

YAESU

FT-50R

Dual-Band Amateur
Hand-Held Transceiver with
Digital Voice Recorder Option

Downloaded by
RadioAmateur.EU



shown with optional
FTT-12 installed

Contents

Description	1	Memory-only Mode, Locking the Controls, Tx TOT	32
Accessories and Options	3	Tone Squelch Modes (CTCSS, DCS)	33
Optional FTT-12 Keypad	4	CTCSS or DCS Bell Paging	34
Control and Connectors	7	Tone/Code Scanning, DTMF Code Squelch/Paging	35
Display Indications	9	Programming/Selecting DTMF Paging Code Memories	37
Specifications	10	DTMF Paging Operation (receiving/sending page calls)	38
Before You Begin	11	Trigger Paging, Auto-Respond Paging	39
Getting Started	73	Paging Tx Delay, Playback Speed, Paging Bell	40
Basic Operation	19	ARTS (Auto Range Transpond System)	41
Frequency Selection Modes (VFO and MR)	19	ARTS Modes, CW (Morse Code) IDer	42
Sub Display Options, Tuning, Transmitting	20	ARTS Polling Speed, Beeper, DTMF Autodial Feature	43
VFO Duplex Mode	21	Autodialer Playback, DTMF Decoder	44
Extended Reception, WFM sql, Auto-Mode select	22	Digital Voice Recorder, Microphone Recording	45
Rx Mode override, Repeater Operation, Tx offset	23	Spkr. Playback, Rx Rec., Tx Playback, Record Protect	46
Repeater Shift, Input Track, Input Monitor	24	VMPS (Voice Mail Paging System)	47
Memory Operation	25	Addendum	49
Storing and Displaying Memories, VFO→ MR, MR	25	Extending Battery Life, APO, Rx Batt. Saver	49
MR→VFO, HOME memory, Custom Tx offset, MT	26	Tx Batt. Saver, Beeper Disable, LED Disable	49
Scanning, Scan Resume Modes, Skip Scan, Lamp	27	Lamp Illumination Modes, Battery Care	51
PTS (Preset Tuning and Scanning)	28	Packet Radio	52
Advanced Operation	29	Cloning	53
Dual Watch (VIM, MM, H/M, V/V)	29	Customizations, MON switch, RV/HM key	54
Naming Memories	30	Appendix	55
Memory Masking	31	Menu FunctionTable, Key Entry Tables	55

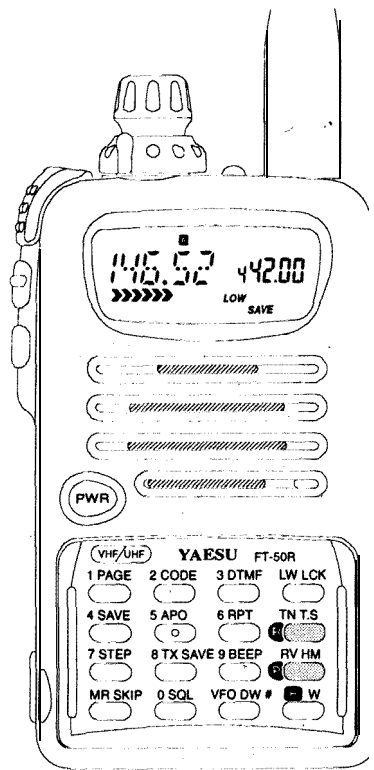

shown with optional
FTT-12 installed

The FT-50R compact FM hand-held transceiver provides up to 5 watts of transmitter output on the 2-m and 70-cm amateur bands. The optional FTT-12 keypad provides tone systems and digital voice functions, while the standard version includes Digital Code Squelch (DCS) encoding and decoding, CTCSS encoding, and a wide range of battery preserving features.

Description

The compact “clamshell” design mounts the battery on the rear, for optimum simplicity and portability. A multi-function knob with concentric volume control allows setting most functions, minimizing the need for complex key sequences. The front half of the case high-impact polycarbonate plastic, while the transceiver chassis/heat sink is die-cast alloy. A choice of 4 rechargeable Ni-Cd packs or a dry cell battery case are available. Rubber gaskets protect against dust and rain or spray. The LCD (display) has selectable lighting modes, and shows all significant frequency digits and most programmable functions, plus relative signal strength and power output.

Two independent VFOs and up to 100 freely tunable memories are programmable from the knob and keypad. The duplex mode allows split VFO operation, and dual-watch monitors a sub-channel VFO or memory while operating from the main channel.

USA versions include extended reception in the VHF, UHF, FM broadcast, and 800 MHz bands (cellular blocked). A separate squelch and bandwidth setting is available to enhance FM broadcast reception.

Memory features include independent tx/rx frequencies or programmable offsets, up to five pairs of subband limits for band scanning, selectable scan skip for busy channels, scan resume on carrier drop or after 5-second pause, and independent instant-re-call HOME channel for VHF and UHF. Memories also

store tuning steps, tone selections, and transmit power level. Standard channel steps from 5 to 50 kHz, plus 1-MHz steps, are available for tuning. You can assign 4-character names to memories.

Also included is a DCS encoder/decoder (104 codes), and a 39-tone CTCSS (Continuous Tone-Coded Squelch System) encoder. The DCS system (and CTCSS decoder provided with the optional FTT-12 keypad) can be set to sound an alert tone when a selective call opens the squelch. Also, the FT-50R can scan a received carrier and determine if a CTCSS tone or DCS code is being used, and display that tone/code.

The ARTS (Auto Range Transpond System) uses DCS signalling to poll another station to indicate when they are within or out of range, and can automatically ID with your callsign in Morse code every five minutes.

In addition to the 4-step power output selection, unique features to extend battery charge life include a battery saver which optimizes save duration according to selectable receiver "sleep" periods TX Save, which automatically reduces transmit power during periods of high incoming signal strength; selectable time delay APO (Automatic Power Off), and continuous or 5-second display illumination.

The keypad generates DTMF tones during transmission, and up to 8 DTMF autodialer memories can store 16 digits each for quick playback of commonly used numbers. A special autodialer memory is re-

served for decoding and displaying DTMF digits off-the-air.

Also, DTMF-based selective calling and private paging capabilities let you select any of 999 three-digit ID codes for your transceiver, and then have it stay quiet until your code is received (from any standard DTMF-equipped transceiver). Upon receiving the DTMF ID code, you can have a paging beeper sound (1, 3, 5, 8 times, or repeating). In the paging mode, your display shows the DTMF ID code of the calling party. Nine 3-digit code memories store your ID plus those of eight other stations or groups you wish to monitor, and an extra code memory always stores the last 3-digit DTMF code heard.

With the optional FTT-12 keypad installed, the transceiver also provides 20 seconds of voice recording from the microphone or receiver, for playback through the speaker or the transmitter. Voice recording can be activated manually or by an incoming signal.

VMPS (Voice Mail Paging System) combines the capabilities of both digital recording and DTMF paging to provide automated response to stations calling you while you are away. The FT-50R allows calling stations to leave a voice message, then answers with your stations CW ID, followed by a pre-stored voice message (that you record).

Please read this manual carefully to familiarize yourself with the transceiver's features,

Accessories & Options

Keypads

FTT-11 (supplied as standard)

FTT-12 DTMF Keypad with Digital Recording, CTCSS decode, and DTMF paging and DTMF code squelch

Rechargeable Ni-Cd Battery Packs

FNB-40 6.0 V, 650 mAh

FNB-41 9.6 V, 600 mAh

FNB-42 9.6 V, 1100 mAh

FNB-49 6.0 V, 600 mAh

Ni-Cd Battery Chargers

NC-50 Dual-Slot Rapid Charger

CA-I 4 Charger Sleeve (required w/NC-50)

NC-GOB/C Compact 15-Hour Charger

('B' suffix for 117-V AC, 'C' suffix for 234-V AC)

Other Accessories

FBA-15 Battery Case for 4 AA-size Dry-Cells

CSC-68 Soft Case for FBA-15, FNB-41

CSC-69 Soft Case for FNB-40

CT-27 Cloning Cable

CT-30 Microphone Adapter

E-DC-5B Cigarette Lighter DC Power Cable

E-DC-6 External DC Power cable

MH-34B4B Speaker/Microphone

MH-37A4B Earpiece Microphone

PA-I 7 Battery Cable Extender

RH-1 Rubber Case Protector

VC-23 VOX Headset

CN-3 BNC -to- SMA Adapter

Availability of accessories may vary: some accessories are supplied as standard per local requirements, others may be unavailable in some regions. Check with your Yaesu dealer for changes to the above list.

FTT-12 Keypad

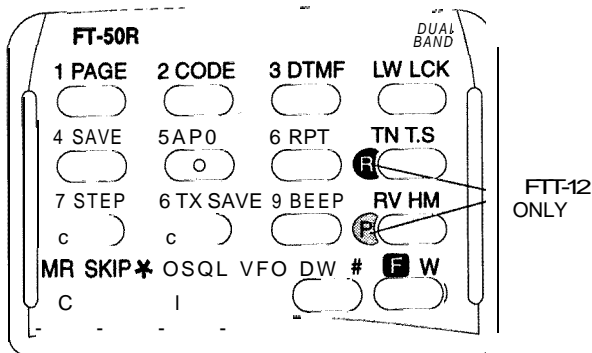

FTT-12

The optional FTT-12 keypad offers additional transceiver functions, as shown in the chart below. See your Yaesu dealer for pricing and availability.

Functions	FTT-11 (standard)	FTT-12 (optional)
DCS & ARTS	0	○
Tone Encoder	0	○
bTMF Encoder	0	○
-S, DTMF Memory	0	○
Direct Frequency Entry (keypad)	0	○
CTCSS Decode		○
DTMF Code Squelch		0
Digital Recorder		○

Installation

The FTT-12 keypad kit includes a keypad, rubber gasket, Ni-Cd recycling label, and small Phillips screwdriver:

- Turn the radio off, and remove the battery. Peel off the black Ni-Cd information seal, and loosen (but do not completely remove) the two screws on either side of the slot behind the original keypad.
- From the rear, carefully press on both screws with both thumbs to eject the keypad slightly, then remove the screws to free the keypad.
- Gently but firmly press the new keypad into place on the front of the radio, ensuring an even gasket seal around the keypad periphery (no "pinching").
- Replace the two screws removed from the slot behind the keypad, making sure the keypad and gasket fit evenly, without pinching.
- Affix the new NiCd label and replace the battery.

Batteries & Chargers

The FT-50R requires the FNB-41 or FNB-42 9.6-volt rechargeable NiCd battery packs for full 5-watt transmitter power output. However, where slightly lower maximum power output is acceptable, the 6-volt FNB-40 and -49 Ni-Cd packs offer smaller size and lighter weight. Any NiCd pack should be fully charged before it is used with the transceiver for the first time.

Two types of battery chargers are available: the NC-60 K-hour compact charger and the NC-50 Rapid Charger (used with CA-14 Charge Adapter). The NC-60 is available with a "B" suffix for operation from 117-V AC, or with a "C" suffix for operation from 220-234-V AC.

NC-50 Dual-Slot Rapid Charger

This AC mains battery charger features rapid and trickle charging modes for all FNB Ni-Cd packs. It requires the CA-14 Charger Sleeve for the FNB-40, -41, -42, and FNB-49, and comes wired for the mains voltage in the area sold.

The rapid mode automatically brings the battery pack up to full charge as fast as safely possible using a peak voltage sensor. A red LED lights during rapid charging, and when the pack approaches full charge, the charger reverts to trickle mode (green LED), to prevent self-discharge. The rapid mode recharges a fully-discharged battery in about one hour.

FBA-15 Dry-Cell Battery Case

The FBA-15 dry-cell battery case uses four "AA"-size (UM-3) batteries. Maximum power output is about 2 watts VHF, 1.5 watts on UHF. Use alkaline cells for best performance. For ease of battery installation, insert the + end in first, then press the - end so that the battery "snaps" into place. Note: the lower single battery can be ejected by pulling upward on the thin strip.

Caution! The FBA-15 must not be used with rechargeable cells. It lacks the necessary thermal and over-current protection circuits provided in the FNB series Ni-Cd Packs.

One or more of the above battery packs/cases may be supplied with the transceiver. If you need a battery, contact your Yaesu dealer. We do not recommend using any other type of battery, and doing so may affect your warranty.

Battery Removal & Replacement

- Make sure the power is switched off, and remove the protective soft case, if used.
- Hold the radio face down in your left hand, and with your right hand, press the Battery Release button behind the antenna jack while sliding the battery down $\frac{1}{4}$ inch. Then lift the battery away.

To open the FBA-15 battery case, hold it in your right hand, inside up, and slide the release catch upward while slipping your left index finger under the notch to the left of the release catch to lift the panel. Always

replace all four batteries, paying attention to the polarity indicated inside the case.

To replace the battery case panel, align the two notches at the bottom edge first, then press the top edge into the case.

Do not attempt to open any of the rechargeable Ni-Cd packs, and do not install rechargeable cells in the FBA-15, as they could explode if accidentally short-circuited.

Other Accessories

MH-34 Speaker/Microphone

The Speaker/Mic can increase operating convenience and extend communications range. It includes a 4-contact plug which mates with the Mic/Ear jack on the right side of the transceiver, disabling the internal speaker whenever the plug is inserted. The cable lets you clip the transceiver to your belt, or hold it above obstructions for better coverage.

VC-23 VOX Headset

The VC-23 connects to the MIC/EAR jack on the right side of the radio. It consists of a headband-supported earphone and attached boom microphone, allowing hands-free VOX (voice-actuated transmit) operation with the transceiver. For further details, refer to the VC-23 Operation Manual.

Controls & Connectors

TOP & Front Panel

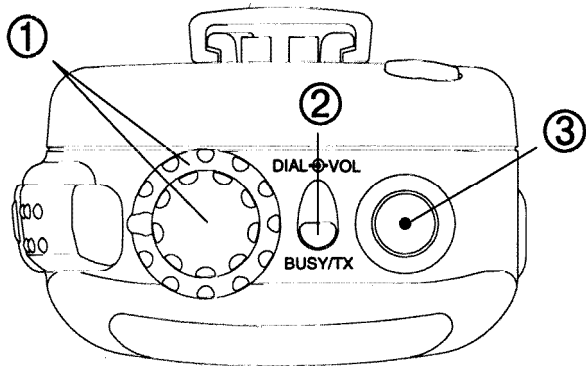

① The outer ring adjusts receiver volume, and the inner knob tunes, selects memories and other menu functions and settings.

② This LED glows red when transmitting, and green when the noise squelch is open (channel busy) during reception.

③ This SMA jack accepts the supplied flexible antenna, or another antenna designed to provide 50-Ω impedance on the 2-m and 70-cm band.

@The upper PTT (Push-to-Talk) button activates the transmitter. Hold this button while speaking across the front of the radio to transmit.

⑤ Press this button to override the squelch, either to set the volume, or to defeat tone squelch temporarily so you can hear weak or all signals.

Sides

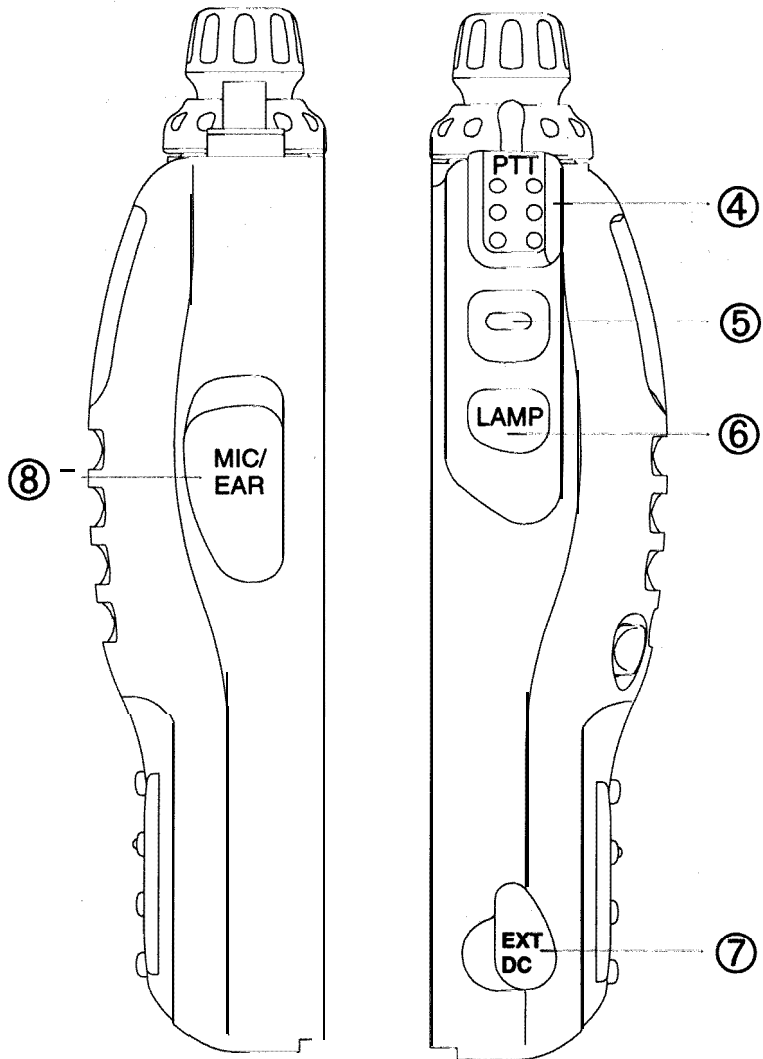

- ⑥ The (lower) LAMP button illuminates the display when operating in the dark.
- ⑦ This 4-mm coaxial jack accepts 5-13 VDC at 2A, via the E-DC-5B cable, to power the transceiver from an external supply. We recommend using this jack only with the optional cable.
- ⑧ This Q-conductor, 3.5-mm mini phone jack provides 8-R audio output and accepts microphone input (2-k Ω) for using an optional earphone, speaker/mic or packet tnc. The internal loudspeaker and microphone are disabled when this jack is used.

Rear (battery pack installed)

- ⑨ Press this button to release the battery for removal.
- ⑩ Install the latch-on belt clip here.

Note: the protective rubber covers over the EXT DC and Mic/Ear jacks must be pressed over them when not in use, to protect the inside of the transceiver from dust and water.

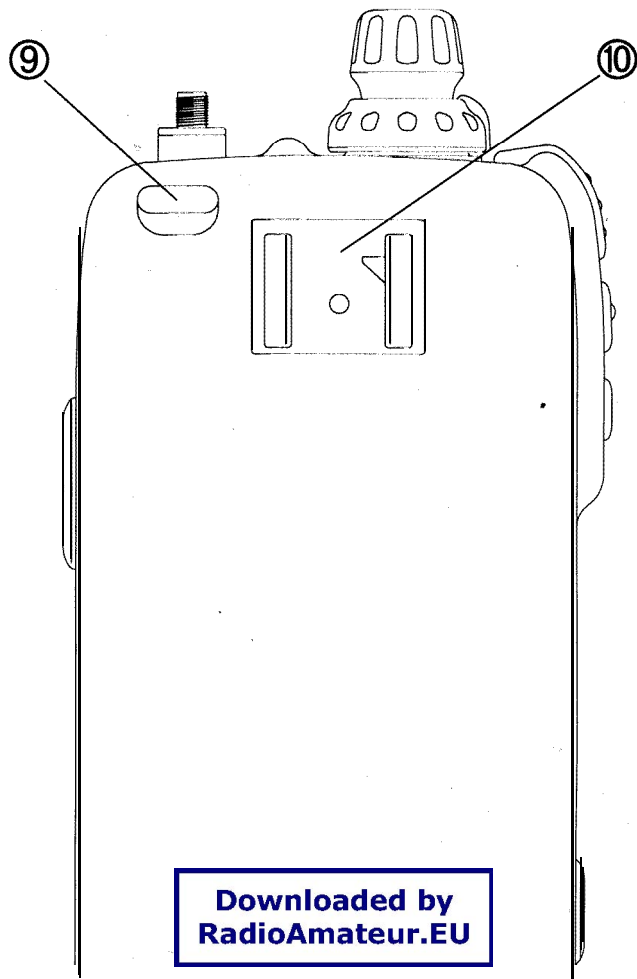

Downloaded by
RadioAmateur.EU

Display Indications

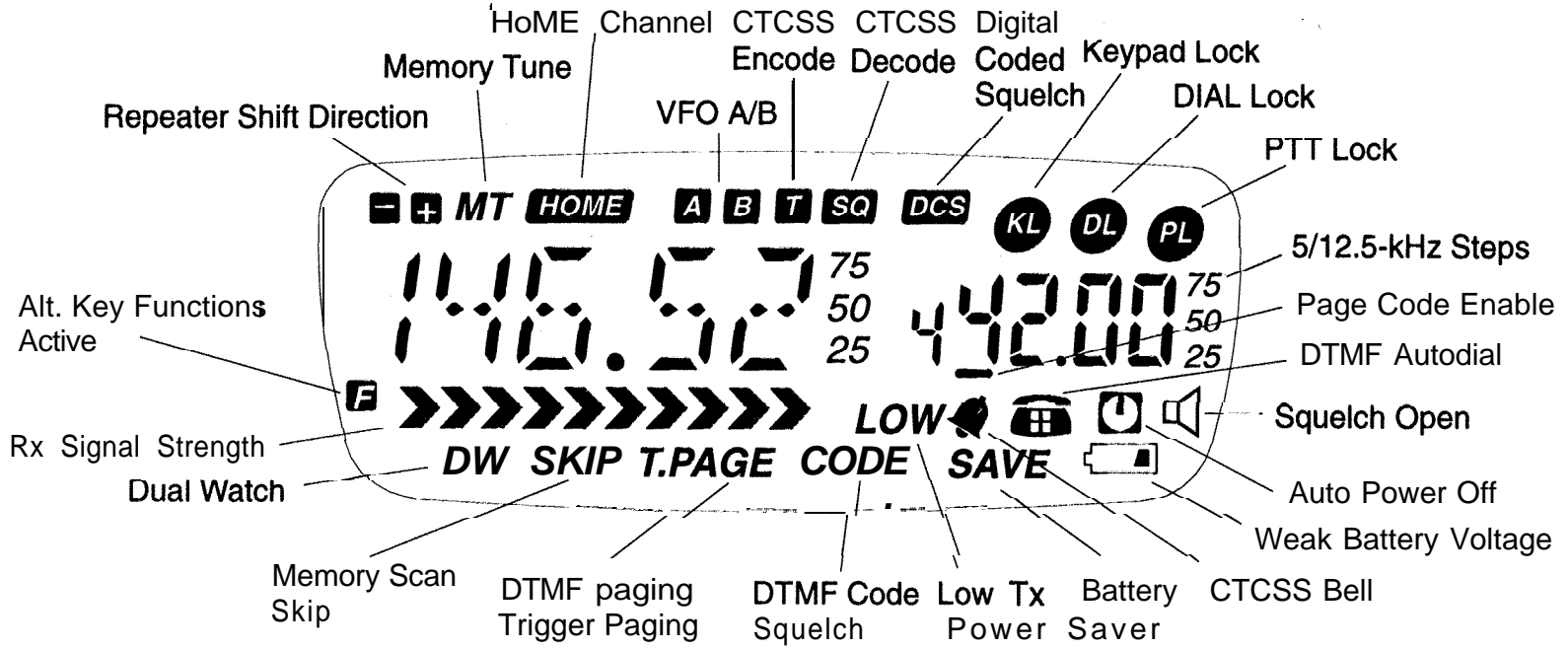

Specifications

General

Frequency range (MHz):	
(transmit)	144 ~ 148, 430 ~ 450
(receive)*	76 ~ 200, 300 - 400
	400 - 540, 590 ~ 999
	(cellular blocked on 800 MHz)
Channel steps:	5, 10, 12.5, 15, 20, 25, & 50 kHz
Emission type:	F2, F3
Supply voltage:	4~16VDC
Current consumption:	250 uA Auto Power Off 24 mA Stby (saver on) 200 mA Rx (approx.) 55 mA Rx (squelched) 1.5ATx(5 W)VHF 1.6ATx(5 W) UHF
Antenna (SMA jack):	YHA-58 rubber helical
Case size (WH D):	57x99x30 mm w/FNB-40
Weight (approx.):	355 grams with FNB-40, antenna, belt clip

Receiver

Circuit type:	Double-conversion superheterodyne
IFS:	45.1 MHz & 455 kHz
Sensitivity:	0.16uV for 12 dB SINAD (VHF) 0.18uV for 12 dB SINAD (UHF)
Adj. ch. selectivity:	65 dB
Intermodulation:	65 dB
AF output:	0.5 W @ 8Ω (10% THD)

Transmitter

Power output (@ 9.6 V):	approx. 5.0, 2.8, 1, & 0.1 W
Frequency stability:	better than ±5 ppm
Modulation system:	variable reactance
Maximum deviation:	*:5 kHz
FM Noise (8 1 kHz):	better than -40 dB
Spurious emissions:	>60 dB below carrier
AF distortion (@ 1 kHz):	< 5%, w/3.0 kHz deviation
Microphone type:	2-kΩ condenser

**Specifications are subject to change without notice, and are guaranteed within amateur bands only.*

Frequency ranges and repeater shift vary according to transceiver version, check with your dealer.

A Few Notes on Safety

When properly cared for, the FT-S50R should provide many years of operating pleasure. However, please read the following items concerning its use:

Battery Charging

Rechargeable batteries contain encapsulated NiCd (Nickel Cadmium) or NiMH (Nickel Metal Hydride) cells. When used properly, they present no operator hazard; however, please note the following points:

- Do not dispose of NiCd cells in the public waste system, as this may present a possible soil contamination hazard. Check with your local waste management bureau for recycling programs available in your area.

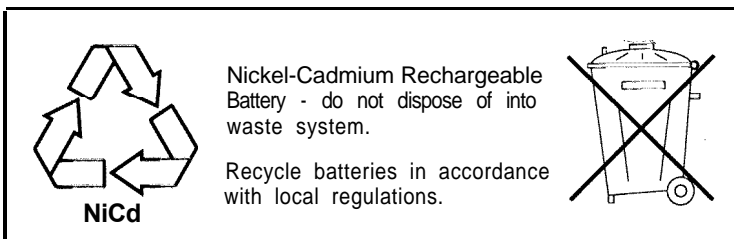

- Never discard any batteries into a fire!

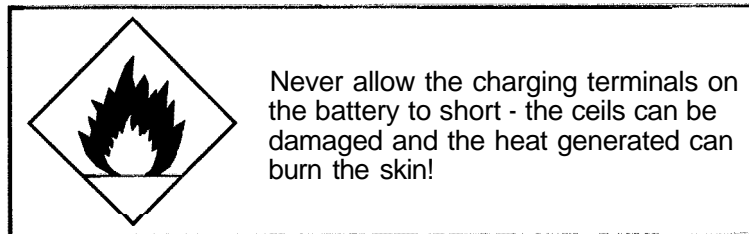

- Do not recharge the battery pack with unapproved chargers.

Modern battery chargers use special circuitry to provide the optimum charge rate and place the battery in a trickle charge state when complete. The use of other chargers could possibly damage your battery pack, and your radio.

- Never allow the battery charging terminals to short!

While the recessed charging terminal on the battery pack offers a degree of safety from inadvertent shorting, never insert any metallic objects into or across the terminals. When separating the battery from the transceiver, never lay it down onto a metallic surface. *The heat generated from a shorted pack can destroy the cells and possibly burn the hand holding it.*

Exposure to Water

While the FT-50R utilizes a water-resistant “clam-shell” design with rubber o-rings to seal out moisture, common sense must prevail...should the radio become exposed to water, use a soft cloth to wipe off any excess drops.

If for any reason the radio is submersed, do not turn it on...remove the battery pack, wipe off the excess water from both the radio and battery, and allow them to dry at *room temperature* (no forced heat) for several days before powering it on again. If the radio fails to function, turn it off immediately and contact your dealer for service information.

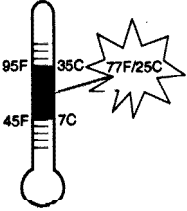



Whenever possible, charge batteries at close to room temperature. Charging at temperatures below 77F/23C can cause electrolyte leakage and result in battery damage. Charging at high temperatures (above 95F/35C) may reduce charge capacity.

RF Radiation Hazard Statement

In 1985, the US. Federal Communications Commission (FCC) adopted a safety standard for human exposure to Radio Frequency (RF) electromagnetic radiation generated by FCC-regulated equipment. The proper use and operation of this transceiver will result in exposure to the operator *substantially below* those *limits* recommended by the FCC. However, the following tips are recommended for maximum operator safety:

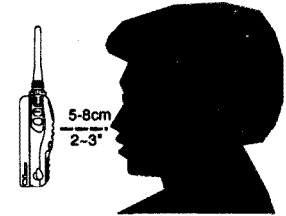
- Do not press the PTT (Push To Talk) switch unless you actually desire to transmit.
- Hold the transceiver a few inches from your mouth when transmitting, so that the antenna is not in direct contact with your face or eyes.
- When not using the transceiver, store it in a safe place, out of the reach of children.
- Do not operate any transmitting equipment near unshielded blasting caps!





Do not hold the transceiver with the antenna touching exposed parts of the body while transmitting, especially the face and eyes.

Getting Started

First Steps

Before operating the transceiver the first time:

- ❑ Charge the battery pack completely (if using a rechargeable pack). If using an FBA-15 dry-cell battery case, install alkaline batteries as described on page 5.
- ❑ Mount the battery pack on the back of the radio: hold it with the rounded top edge 1/3 -inch (8 mm) lower than top, edge of the radio, press the four tabs on the battery into the slots on the radio, and slide the battery up until it clicks.
- ❑ Screw the supplied antenna onto the antenna jack. Never operate the transceiver without an antenna connected.
- ❑ To install the belt clip, slide it up onto the battery pack rails until it “clicks” (locks into place). To remove it, slide the release lever to the left, then press the clip down and off of the mounting rails.
- ❑ If you have a speaker/mic, we suggest you not connect it until you are familiar with basic operation.

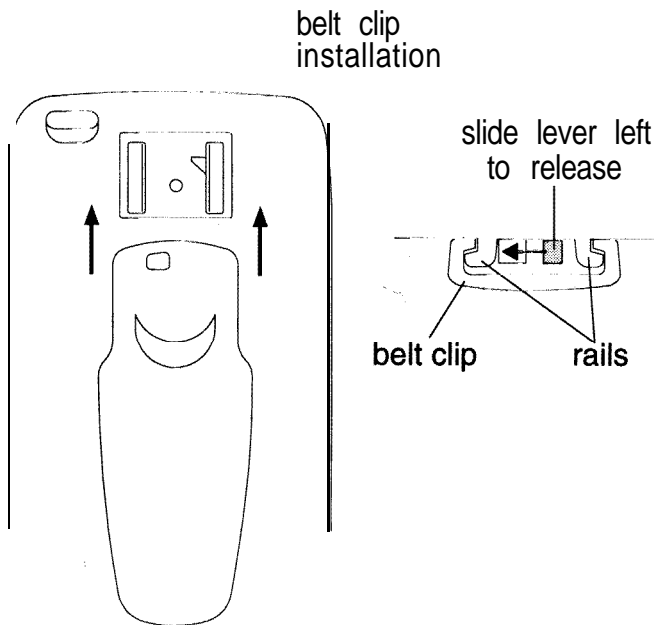
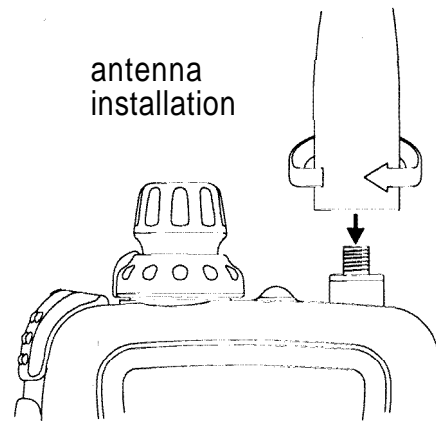
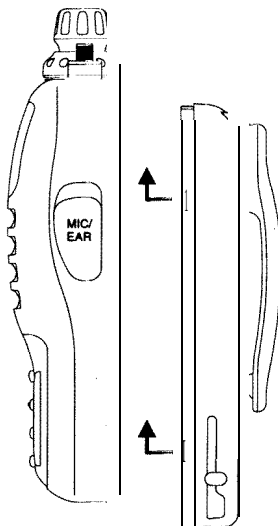

Powering On

To turn the transceiver on, push in the orange **PWR** button for ½ second. If the radio has not been used before, the display should appear like that below.

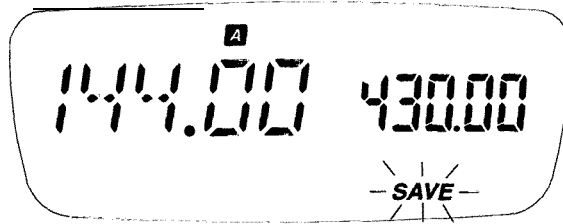

The larger frequency readout is the *main* channel, while the smaller one to the right is called the *sub* channel. The **A** symbol indicates which VFO (A or B) is selected for operation, and the *blinking* SAVE indicator lets you know that the *battery* saver is enabled from the factory (we will cover more on this later).

☞ When you turn on the radio the first time, you will hear channel noise, and will *need to set the squelch level* as explained on the following page.

Knob Functions

Let's spend a few moments on how the knob functions, as understanding its proper use will make it easier to operate the rig and configure various features as we continue through the manual.

As shown in the illustration, the lower ring adjusts the volume. Set it for a comfortable level while receiving a station, or else press the middle monitor switch (below the PTT) to disable the squelch, and adjust the volume level on background noise.

Rotating the knob tunes in the default step size on the VFO, or else selects programmed memories during MR (Memory Recall) operation.

Pressing the knob *momentarily* (< 0.5s) selects the band of operation. *Holding* it longer recalls the menu list, from which various transceiver functions are enabled and their settings are configured.

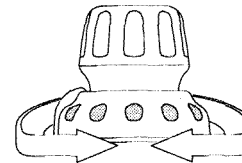

Lower Ring- rotate for volume level adjustment

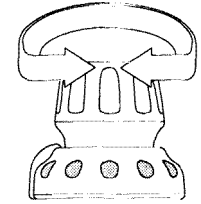

knob - rotate to tune channels, select memories or menu settings

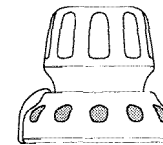
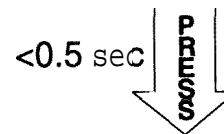

knob - press to switch bands or view default menu settings.

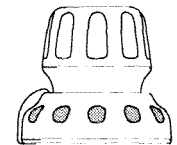
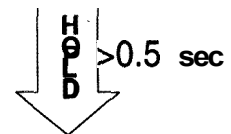

knob, - hold to recall the menu function list,

Let's start by setting the receiver squelch:

- Hold (> 0.5 sec.) the knob down until the beep sounds, then turn the knob (if necessary) to select **SQ** -or-.

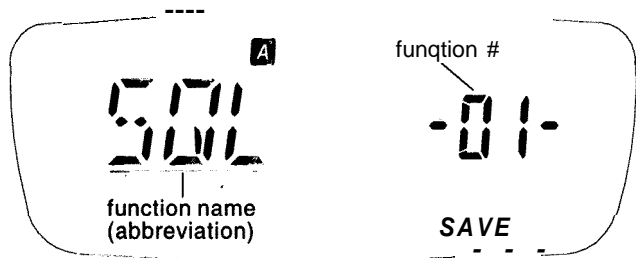

- The name or abbreviation at the left is the function title, with its number displayed to the right. You can turn the knob to scroll through all 32 functions.
- Momentarily pressing the knob shows the default setting for the displayed function (in this case it is the squelch level, which ranges from 0 to 15):

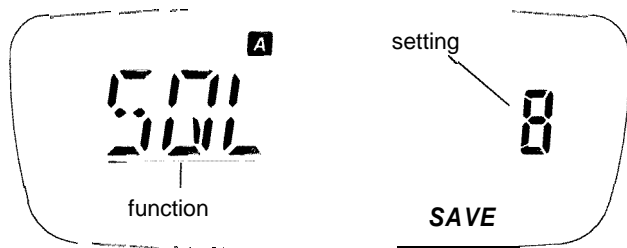

- Rotate the knob a click or two past the point where channel noise is muted, then exit the menu list by simply pressing the PTT (the radio does not transmit). The display reverts to show channel data.

Note - Pressing the knob with a menu active replaces the function number (at the right in the sub display) with either a number (**8**), letter or abbreviation (**OFF**), or a symbol (**KL**). In some cases the function name (at the left) may also change, to describe the setting more clearly.

Follow the instructions carefully when starting out, until you become familiar with the abbreviations and symbols used with each menu function and its associated settings.

Things to remember...

The procedure just covered is used throughout the manual to access functions and change settings as desired. Once again, the three basic steps are:

- Hold the knob down to recall the *menu* list, then *turn* the knob to select the desired *menu function* (number).
- *Press* the knob to display the various *function settings* or state, then *turn* the knob to change or select it as desired.
- *Press the* PTT to save the change and *exit*.

The Keypad

The standard FTT-11 keypad permits quick access to the most commonly-used transceiver functions. The *optional* FTT-12 keypad adds digital voice recording/playback, DTMF code squelch and CTCSS decode capability.

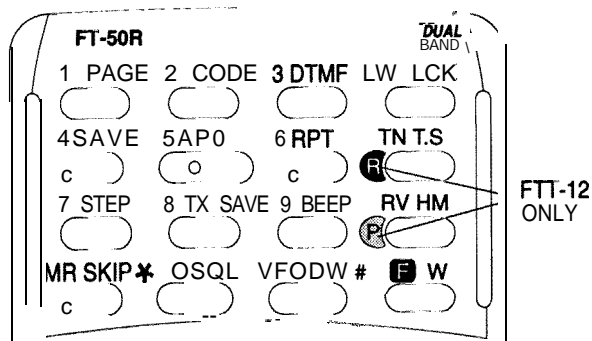

FTT-12

Both keypads are similar in appearance, with the FTT-12 having two additional labels on the pad surface for the digital recording system (the **TN.T.S** and **RV.HM**, specifically). Throughout the manual, features requiring the FTT-12 are highlighted as such.

Important - Normal key presses should be very quick -just a tap. Keys, like the knob, are sensitive to the duration they are depressed. In some cases tapping a key and holding it 'longer will activate a different function, and produce different results and display indications. The instructions specify when a key is to be held down.

To indicate when several keys have to be pressed in sequence, we show an arrow (→) between them. Do not press more than one key at time unless the instructions say so.

One or more beeps indicate key contact has been made (if the key has a function). You can disable the beeper as described later, but we recommend keeping it enabled while getting to know the key functions, since the pitch and number of beeps can be useful feedback.

A several-second timer starts when you press **R.W.**, and automatically restarts when you turn the knob. Pressing other keys may *shut* off the timer as the resulting change in operation occurs, or *restart* the timer so you can select various functions.

Also, after changing a setting, you can usually return to the operating frequency display by pressing the PTT button at the top left corner of the radio. It does not transmit unless the operating frequency is displayed. The front keypad generates standard DTMF tones when pressed while transmitting.

While reading about operation, if you are unsure about the location or function of a button or display item, refer to *Controls and Connectors* and *Display* sections on pages 7 and 8.

Your first QSO

Adjusting the Volume

- Turn the outer ring of the knob on the top panel control to adjust the volume. If there is no signal, you can override the squelch by holding the center button (on the left side below the PTT switch), to set the volume on background noise.

Squelch Setting

- To adjust the squelch, hold the knob down for ½ second, then turn it, if necessary, so that **S QL - 0 1** is displayed.
- Press the knob again momentarily, then turn it to set the squelch threshold (0 to 15) so the receiver is silenced (the **BUSY/TX** LED turns off). Press the PTT momentarily when done.
-  Keypad shortcut for setting the squelch
- Press **[W] → [SQL]**, turn the knob to set the squelch level, then press the PTT to save and exit.

Squelch Sensitivity

First set the volume to mid range, then adjust the squelch (with no signal): slightly past the point where background noise is silenced and the green **BUSY/TX** LED is extinguished. If set higher, sensitivity to weak signals is reduced, if set too low, “falsing” on background noise and weak stations will result.

Tuning & Direct Frequency Entry

- Tune to the desired frequency using the inner knob: press **[W]** at the lower right momentarily, and turn the knob to select the MHz range, then wait 5 seconds or press **[W]** again and turn the knob to select the frequency.
- You can enter frequencies directly from the keypad as well; just key in all the digits. For example, for 146.520 MHz enter:

[PAGE] → [SAVE] → [RPT] → [APO] → [CODE] → [SQL]

If you want to enter an even whole frequency, like 140.00 MHz or 146.000 MHz, there’s a shortcut, Pressing **[VFO/DW#]** after any entry truncates the remaining digit places to zero:

enter 146.500 **[PAGE] → [SAVE] → [RPT] → [APO] → [VFO/DW#]**
 enter 146.000 **[PAGE] → [SAVE] → [RPT] → [VFO/DW]**
 enter 140.000 **[PAGE] → [SAVE] → [VFO/DW#]**

Transmitting

- To transmit, wait until the channel is clear; press the PTT (Push To Talk) and speak in a normal voice. Keeping the transceiver a few centimeters from your mouth will result in best audio clarity. Release the PTT to receive again.

Important - The PTT switch should be pressed inward and in a slightly downward direction for proper operation. Do not press the PTT switch in an *upward* direction, as this cause unreliable closure of the PTT switch, and it may damage the rubber boot.

This angle of PTT switch actuation is designed to be ergonomically optimum when the radio is being held in the palm of your hand.

When you transmit, the **BUSY/TX** LED turns red, and all or a few of the meter bar-segments appear, depending on your transmit power. One of four power output levels can be selected using either the keypad or menu method:

From the menu:

- Hold the knob down to recall the menu list, then turn the knob one click so that **T:PO-02** appears.
- Press the knob once to view the default power level, then rotate the knob to select **L 1**, **L 2**, **L 3**, or **HI**. Press the PTT to save the change and exit.

- Refer to the following table for power output vs. battery type:

Display Code	PO Meter Segments	Power (watts) VHF/UHF		
		FNB-41 FNB-42	FNB-40 FNB-49	FBA-15
HI	▶▶▶▶▶▶▶▶▶▶	5.0/5.0	2.5/2.0	2.0/1.5
L3	▶▶▶▶▶▶	2.8/2.8	2.5/2.0	2.0/1.5
L2	▶▶▶▶	1.0/1.0	1.0/1.0	1.0/1.0
L1	▶▶	0.1/0.1	0.1/0.1	0.1/0.1

- Keypad shortcut for selecting high/low tx power:
- Pressing **LW/LCK** only lets you toggle between high and low power (LOW displayed when active). The low power level will correspond to that set previously in **T:PO-02**.



Remember! - good operating practice and professional courtesy mean using the least transmit power needed to maintain communications.

**Downloaded by
RadioAmateur.EU**

Frequency Selection Modes

There are two frequency selection modes. These affect the behavior of the knob and keys when tuning or keying in frequencies, scanning coverage, and the right half of the display.

VFO **A** **B**

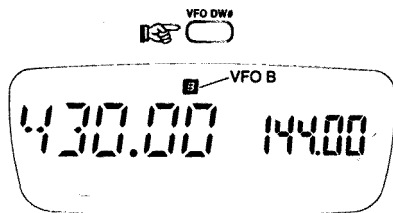
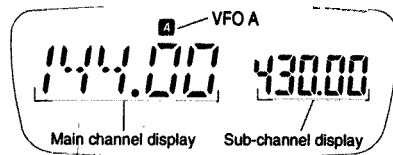

Use this to tune around for clear or active channels. As mentioned before, the knob tunes in the selected step size (or in 1-MHz steps if you press  first), and scanning tunes in the selected step size. The transceiver has two VFOs, A and B, which you select by pressing  (see below) when receiving on either VFO. The display shows **A** or **B** near the top center to indicate which VFO is selected for tuning; the frequency is displayed in large numbers at the left. The frequency of the other VFO is displayed in small numbers at the right.



MR (Memory Recall) CH - 1

Use this to select and operate on stored memories. There are 100 memories, each of which stores repeater shift, transmit power level, tone settings, and tuning steps (for the Memory Tune mode), and can also hold a name tag and a separate transmit frequency.

Either the operating frequency or the memory name, if assigned, is displayed in large letters at the left, and the memory number is displayed at the right.

Each memory can be used in the *Memory Tune* mode, which works like the VFO mode. Special memory mode functions like this are described later, but you should keep these terms in mind. Pressing  switches from the VFO mode to the last-used memory, and  switches from the memory mode to the last-used VFO. While in the memory mode, your previous VFO mode selections are preserved.

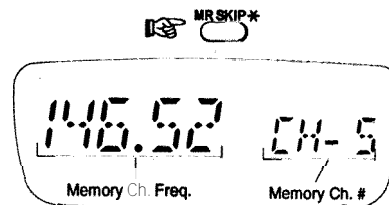
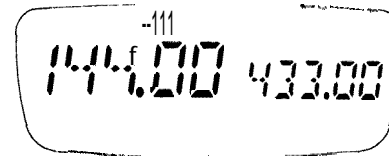

Sub Display Options

The right side of the display (with the smaller digits) is referred to as the sub-display. It normally displays the channel selection for VFO B; however, you can display the battery voltage instead, or else disable the sub display completely:

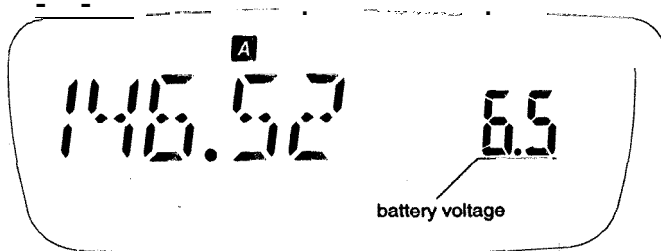

- Press the knob ½ second, then turn it to **SUB** **04**. Press it again momentarily to display the default sub-display choice (**00**).
- Turn it a click to choose battery voltage (**ΔE**), or again disable the sub-display (**OFF**). Press the PTT to save the entry and exit.

Tuning

As mentioned before, you turn the knob to tune in the selected step size, or press **@!!!** first to tune in 1 -MHz steps. You can select a new frequency from a VFO, or by tuning a memory. For now, use the VFO mode: press **VFO/DW#**. You can enter a frequency by turning the knob, or by numeric key entry. See *Locking the Controls* on page 32 if the keys or knob don't work.

Tuning Steps

Channel (tuning) steps can be set to match the standard channel spacing in your region: typically 25 kHz on UHF (and on VHF in Europe), and 15 or 20 kHz on VHF in America. Note that coarser steps tune and scan faster, and that 5- and 15-kHz steps require an extra digit when entered from the keypad. Each VFO and memory has its own tuning step setting.

To change step size:

- Press the knob ½ second, then turn it to **STEP** **10**. Press it again momentarily to display the current step size.
- Turn it to choose the new step size (in kHz), then press it again momentarily to accept the new size. Press the PTT to save the entry and exit.
- Keypad Shortcut** - press **W** → **STEP**, turn the knob for the desired steps, and press the PTT to exit.

Transmitting

Press **LW/LCK** so that **LOW** appears below the center of the display. To transmit, wait until the channel is clear (**BUSY/TX** LED off), then press and hold the PTT while speaking into the microphone (at the right side of the front panel). The **BUSY/TX** indicator glows red when transmitting, and the bargraph shows relative transmitter power output. Release the PTT to receive.

If you need more power to maintain communications, you can select another power setting as described on page 18. However, remember that your batteries

last longer and you cause minimum interference by using the lowest level possible.

Note that if you decide to change the power settings on a memorized channel, you must first re-load that memory (otherwise it reverts to the original memorized power level the next time it is recalled).

VFO Duplex Mode **AB** **|| DUP-08-**

If you need to transmit on a different frequency than your receive channel, but don't want to go to the trouble of **changing** the default tx offset (**SHIFT-Of-**, on page 23), or programming an independent tx offset in a' memory, try out the VFO "duplex" mode.

This feature simply uses one VFO to store the transmit frequency, and the other for the receive frequency. You receive on the main channel, and *always transmit on the sub channel*, regardless of which VFO (A or B) is in which display (main or sub).

- First make sure the sub-channel display is enabled (set **SUB-04** to "on").
- Press **VFO DW** to toggle between VFO A and B, setting up-each VFO with the desired frequency.
- Press **VFO DW** again, as necessary, so that the desired receive frequency is displayed to the left (main channel), with the transmit frequency at the right (sub channel).
- Press and hold the knob ½ second, then turn it to **|| DUP-08-**. Press it again momentarily, then turn it to select "on".

- Press it momentarily again, then press the PTT to save the entry and exit (**AB** now appears at the top of the display).

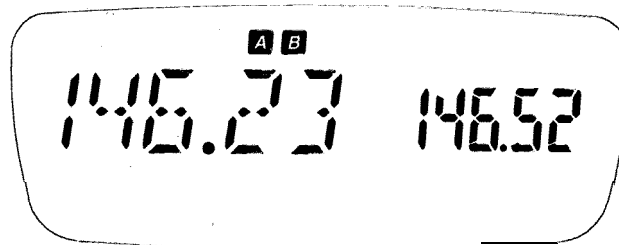

Now, when you transmit, the main and sub display frequencies will switch, indicating transmission is occurring on the sub channel VFO frequency.

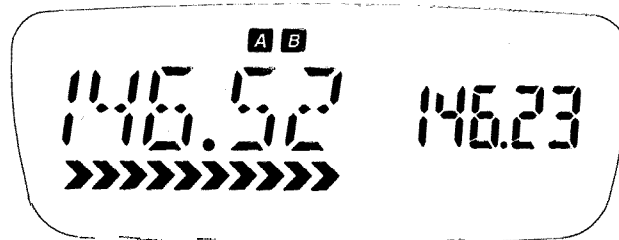

Note that setting a new tx/rx pair is as easy as dialing in new frequencies for VFO A and B, then pressing **VFO DW** so the VFOs are in the correct display. You *are not limited to V/V or U/U operation*; you can mix VHF and UHF VFO channels for cross-band semi-duplex operation!

- To disable VFO duplex operation, set **|| DUP-08-** to **off** again.

Extended Reception

Introduction

In addition to amateur band operation, the FT-50R offers extended receiver tuning and scanning. This feature may not be available in all countries and all transceiver versions - please check with your dealer.

While operating from VFO A or B, each momentary press of the knob recalls four preset band-ranges for tuning and scanning:

Frequency Range	Default Frequency
76-200 MHz*	145 MHz
300-400 MHz	380 MHz
400-540 MHz	430 MHz
590-999 MHz**	800 MHz
*reduced sensitivity from 76-95 MHz	
**800 MHz cellular blocked, non-restorable	

Note - If your radio only switches between 2-m and 70-cm bands, you can expand receiver coverage by hold the knob and LAMP button depressed while turning the transceiver on.

WFM Squelch Setting **WSQL-30-**

The default squelch threshold for WFM (wide bandwidth FM) is preset to 0 (recommended for broadcast reception). To change this setting:

- While tuned to a FM or TV broadcast band, hold the knob down for ½ second, then turn it to select **WSQL -30-**.
- Press it again to display the current squelch setting, then rotate the knob to select the desired level. Press the PTT to save the setting and exit.

Auto-Mode Select **AMOD-31-**

By default, the correct demodulation mode (FM, WFM or AM) is automatically selected according to frequency ranges, as shown below:

Band (MHz)	Service	Mode
76-107.995	TV (Ch 5-6), FM Broadcast-	WFM
108-136.995	Aviation Nav/Com	AM
137-173.995	LMR amateur marine, Wx	FM
174-199.995	TV CH 7-10	WFM
300-334.995	Gov. (Military Aviation)	AM
335-399.995	Gov. (Military)	FM
400-469.995	Gov. amateur LMR	N F M
470-540.000	UHF/TV (Ch 14-24)	WFM
590-799.995	UHF TV (Ch 34-68)	WFM
800-999.000	trunked, SMR	FM

If you would like to disable the auto-mode selection:

- Hold the knob down for ½ second, then turn it to select **RMOD** - 31 - .
- Press it again to display the default setting, then rotate the knob to select **00** or **0FF** (reception defaults to narrow **FM** for all frequencies). Press the PTT to save the setting and exit

Reception Mode Override **RMOD** - 32 -

If you would like to override the mode selection temporarily while receiving on a channel, you can enable this feature. Auto-mode selection takes effect again as soon as you turn the knob and change the channel (unless you have it disabled - NFM only).

- Hold the knob down for ½ second, then turn it to select **RMOD** - 32 - .
- Press it again to display the default setting, then rotate the knob to select **N-FM**, **AM** or **W-FM**. Press the PTT to save the setting and exit.

Repeater Operation **RR5** - 05 -

Fortunately, repeater operation usually requires just tuning to the correct channel, pressing the PTT, and speaking. The ARS (automatic repeater shift) feature sets the correct shift and offset as you tune through the 2-m and 70-cm repeater sub-bands. You can observe the **+** and **-** indicators activate and change as you tune across the amateur band. The chart shows the ARS ranges for common transceiver versions.

ARS-Repeater Subbands

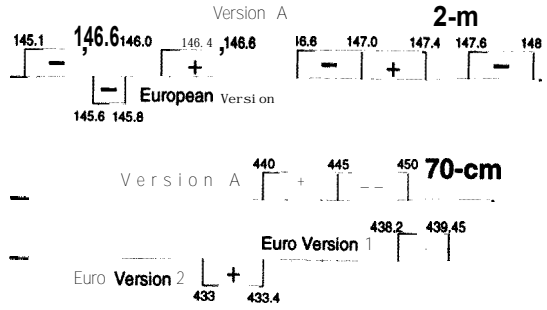

ARS is enabled at the factory. To disable it:

- Hold the knob down ½ second, then turn it to display **RR5** - 05 - . Now press it again momentarily, and turn it to select **0FF** .
- Press the PTT to accept your setting and return the display to the operating frequency.

You can still manually select a new shift, if ARS is activated or not. However, if you change frequency with ARS activated, manual repeater shift selections are terminated and the ARS shifts are restored.

Setting Repeater Tx Offset **SHIFT** - 07 -

Although you should keep the repeater offset programmed to that used in your area, you can change the default repeater offset for special applications:

- Hold the knob down for ½ second, select **SHIFT** - 07 - , then press it again to display the offset.
- Turn the knob to select the new shift offset frequency (selectable in **50-kHz** increments only).
- Press the PTT to save the setting and exit.

Repeater Shift [-] [+] RPTR-06-

When a repeater shift is active, either [-] or [+] appears in the display. If neither appears when tuned to a repeater output frequency, you can activate the shift manually:

- Hold the knob down for ½ second, turn it to select RPTR -06-, then, press it to display the current shift.

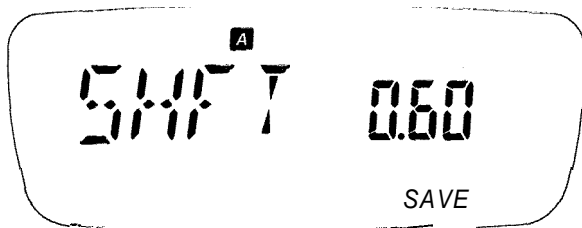

- Press the knob momentarily, and turn it to set repeater shift direction (+RPT, ΣIMP or -RPT). Press the PTT to accept your change and exit
- Keypad** Shortcut: Press [QW] → [RPT], turn the knob to select the desired shift, then press the PTT to exit.

Tone Burst

For repeaters using 1750-Hz burst tone access, you can configure the switch below the PTT to send the tone when pressed. See page 54 for details.

Repeater Input Track RPTL-09-

If you would like to view the repeater input frequency along with the output, and have it track as you tune channels, this can be done using the sub-display:

- Hold the knob down for ½ second, turn it to select RPTL -09-, then press it to display the default setting (oFF).
- Turn the knob one click to enable this feature (on), then press the PTT to accept your change, and exit.

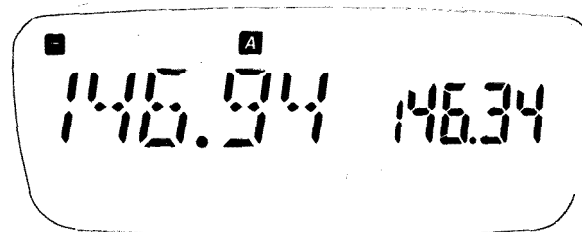

The display will show the input frequency tracking the output as you tune. During transmit, the repeater output appears in the sub-@splay.

Repeater Input Monitor

With a repeater split activated, you can temporarily reverse tx and rx frequencies by pressing [RVHM]. Use this to check a signal's strength on a repeater input frequency (to see if you can work them direct). Either

- [-] or [+] blinks while reverse split is selected. Press [RVHM] again to return to the normal shift direction.



Memory Operation

Storing and Displaying Memories

When you store a memory, the current tuning step, displayed receive frequency, repeater shift, transmitter power level, DCS, and CTCSS tone settings are copied into a memory slot. The slots are labeled numerically from 1 to 100 and **L1 & U1** through **L5 & U5**, for the lower and upper limits of programmable scanning (PMS, described later).



VFO → MR (copying a VFO into memory)

To store a frequency in memory:



- Preset the desired frequency, shift, power level (etc.) in the VFO mode as already described.
- Hold  for ½ sec. (until a second beep sounds) to display the memory slot (blinking) at the right.
- Within five seconds of releasing , turn the knob and select a memory channel for storage. If you select one that was already used, it will be overwritten with new data in the next step.
- Press  to store the displayed data into the selected memory slot. The memory number stops blinking for a second, and then disappears as operation continues in the VFO mode.

If you timed out, operation switched to the memory mode. Simply press  to return to the VFO, and start again.





MR (Memory Recall)

Pressing  changes from VFO to MR (memory recall) operation. The memory number appears at the right, and the receive frequency to the left (unless you assign a name to a memory, or activate Dual Watch as described later). Notice that pressing  from the VFO mode always recalls the last stored *or last-used* memory.



After storing several memories, you can select them by turning the knob, or by *direct keypad access*:

- Enter the number of the desired memory, followed by . If you hear two beeps and return to the previous display, the requested memory is empty.
- To exit and return to the last-used VFO, press .



Filled and Empty Memories



When selecting memories for data entry, you can determine if they are already in use by the display format;   means unfilled, while "C H · " means it contains previous data. You can overwrite filled memories at any time, but of course old data will be lost. Note:   · I is always preset with 144.00 MHz.

MR → VFO (copying a memory into a VFO)

After storing memories, you may want to copy one back to a VFO. You can copy the current memory into the last-used VFO by holding  for ½ second, and pressing .

HOME Memory *HOME*



Although invisible to the procedures just described, the HOME memory can be instantly recalled by pressing  → : *HOME* appears above the frequency at the left. There is a default simplex frequency stored in the HOME memory, but you can reprogram it with any frequency, repeater, power, and tone settings, or even a separate transmit frequency.



To copy the displayed VFO settings into the HOME memory, hold  for ½ second until the right half of the display blinks, then press .

Custom Tx Offset 

All memories can store an non-standard tx offset, for operation on repeaters with non-standard shift. To do this:

- Store the receive frequency using the method already described under *Simple Memory Storage* (any repeater offset will be ignored).
- Tune to the desired transmit frequency, then press and hold  for ½ second to display a slot at the right.





- Press and *hold* the PTT switch while pressing  momentarily (this does not key the transmitter). Of course, if you're storing this in the HOME channel, you press  when holding the PTT).

When a separate transmit frequency memory is displayed,  appear at the top left corner. You can press  to display the transmit frequency,  *blinks* while the pair are reversed.

After storing a memory with a separate transmit frequency, if you rewrite the receive frequency in that memory, the separate transmit frequency is deleted.

Memory Tuning *MT*

While receiving on a memory, you can re-tune it and change any other settings:

- First press  so that *MT* appears; can tune it like a VFO.
- To store the new frequency and settings in the current or other memory, hold  for M-second, select the new slot (if desired), and press . Operation remains on the new memory, as the old memory is restored.
- After re-tuning a memory, to discard your changes, press  to restore the original memory data.

Scanning ΣCRn

Before scanning, ensure the squelch is closed. You can scan either stored memories, or each VFO at the selected tuning step. To scan memories, first recall MR operation (press MR SKIP^* momentarily), then hold MR SKIP^* for $\frac{1}{2}$ second. To scan a VFO (press VFO DW^* momentarily to select VFO **A** or **B**), then press and hold VFO DW^* for $\frac{1}{2}$ second (ΣCRn appears at the right).

Scanning pauses when a signal opens the squelch, and the decimal point in the frequency display at the left blinks. For VFO scanning, a double beep sounds each time the scanner reaches a band edge, unless you have disabled the beeper ($\text{B W} \rightarrow \text{B BEEP}$). Scanning resumes according to how you set the *scan resume* mode, described next.

Stop the scanner manually by pressing MR SKIP^* (on memories), VFO DW^* (on a VFO) or the PTT to stay on the current frequency, Note - You can change scan *direction* (up/down) by rotating the knob (left/right) while memory or VFO scanning is active.

Scan Resume Modes $RESM-11-$

Scanning resumes after pausing on a signal: either after 5 seconds, or after the signal stops transmitting (carrier drops):

- Press the knob $\frac{1}{2}$ second, then turn it to $RESM-11-$. Press it again momentarily to display the current setting (Σ or CRrr).
- Turn it to choose the desired setting, and press the PTT to return to the operating display. Your scan resume setting applies universally: that is, the one setting applies to all scanning modes.

Memory Skip Scanning **SKIP**

When you have some very busy channels stored in memories, you may wish to skip them when scanning, but still have them available for manual selection. You can mark a memory to be skipped by pressing $\text{B W} \rightarrow \text{MR SKIP}^*$ while receiving on the memory. **SKIP** appears at the lower left.

To cancel scan-skip and allow the memory to be scanned, just repeat the step used to disable it: select the memory manually, and press $\text{B W} \rightarrow \text{MR SKIP}^*$.

Scan Lamp $\Sigma \text{CNL-12-}$

If you would like the LCD to illuminate when scanning pauses on activity, the *scan lamp* can be enabled:

- Press the knob $\frac{1}{2}$ second, then turn it to $\Sigma \text{CNL-12-}$. Press it again momentarily to display the default setting (OFF).
- Turn it to enable the scan lamp (ON), and press the PTT to return to the operating display.

PTS (Preset Tuning and Scanning)

You can set the transceiver to tune or scan on/y *within a preset band*. Ten special memories (which form five preset *pairs* when programmed) are available for PTS operation. Each pair (L1&U1 , L2&U2, L3&U3, L4&U4, and L5&U5) define a preset. tuning and scanning range, with an upper and lower limit stored in a “L” and “U” memory.

Although PTS memories are recalled, viewed and programmed the same as regular memories, *they are ignored during regular memory scanning*.

Let's try an example:

Program L 1 and U 1 to limit operation (tuning and scanning) to 444.00 ~ 446.00 MHz:

- From either VFO, copy 444.00 into L 1, and 446.00 into U 1 as you would for regular memories.
- Press **MR SKIP*** to switch to MR mode (if needed), and recall *either* memory of the preset pair (it makes no difference if you select L 1 or U 1).
- Press **MR SKIP*** again to activate memory tuning (MT blinks). Turning the knob now tunes the memory up/down the same as before, however, operation is now restricted to 444.00-446.00 MHz.
- To scan, hold **VEO DW**** for ½ second. Just as with regular VFO scanning, a double beep sounds each time the scanner reaches a preset band edge, unless the beeper is disabled (page 50).

Channel Resolution for PTS Limits

Although you can tune and scan in the default channel step size during PTS operation, you can only store *even or 100-kHz resolution* frequency limits into PTS memories.

For example, while 146.00 or 146.100 are acceptable preset limits, 146.035 or 146.150 are invalid (they would be rounded down to the nearest 1 00-kHz channel).

If ARS or manual repeater shift is activated, the offset is applied automatically when you transmit (even if the resulting transmit frequency is outside the programmed limits).

- To exit PTS, press **MR SKIP*** to return to MR operation, then **VEO DW**** to return to a VFO.
- Note** - you cannot activate PTS tuning or scanning if either PTS memory is marked for skip-scanning, or hidden.

Downloaded by
RadioAmateur.EU

Advanced Operation

Dual Watch DW

Dual watch receives on the main channel while checking for stations on the sub channel. If activity is detected, operation shifts there while the signal is present. There are four dual watch choices, as outlined below in the table:

Dual Watch Operation		
Mode	Main Channel for operation.	Sub Channel to be "watched".
V/M	VFO A or B	any stored memory
M/M	any stored memory	[H- I] (only)
H/M	HOME channel	any stored memory
V/V	VFO A → VFO B →	VFO B VFO A

ⓘ Before using dual watch, ensure that the sub channel display is enabled (set **SUB-04** to **ON**), and the squelch is closed (use **SQ-L-01**).

V/M Dual Watch

To set up V/M dual watch:

- Press **MR SKIP*** and select any stored memory for dual watch to check.
- Press **VFO DW**** as necessary to select either VFO A or B for the main channel.
- From the VFO, press **Q.W** → **VFO DW**** to activate dual watch.

M/M Dual Watch

To set up M/M dual watch:

- Store a frequency that you want dual watch to check in memory [H- I-].
- Press **MR SKIP*** and select another stored memory (other than [H- I-]) for main channel operation.
- With the memory displayed, press **Q.W** → **VFO DW**** to activate Dual Watch.

H/M Dual Watch

To set up H/M dual watch:

- Select any stored memory for main channel operation.
- Press **Q.W** → **RV.HM** to recall the HOME memory (**HOME** appears at the display top).
- With the HOME memory displayed, press **Q.W** → **VFO DW**** to activate dual watch.

V/V Dual Watch

- Press **VFO DW**** as needed to select VFO A and B for the main and sub channel, as desired.
- Press **Q.W** and **ho/d VFO DW**** for ½ second.

For all dual watch modes, **DW** appears at the bottom left of the display. During V/M M/M, and H/M dual watch, the sub channel memory is checked every five seconds for activity (you will see the main and

sub channels briefly switch as this occurs). For *V/V* dual watch, the sub channel is sampled much faster (every 200 ms), and this checking is “transparent” to the operator.

If a signal appears on the subchannel, two beeps sound, the receiver jumps to the subchannel, then *DW* and the decimal on the display blinks. Dual watch resumes according to how you set the scan-resume mode (5 **secs.** or carrier drop).

Otherwise, you can operate on the main channel VFO, or select other memories. If you wish to talk on the subchannel, press **VFO DW*** or **MR SKIP*** to cancel dual watch operation, then the **PTT**.

Note that you can use any memory as a subchannel for *V/M* Dual Watch, but only memory [*H-1* for *M/M*. You can use Memory Tune during Dual Watch, if you activate Memory Tune first, although it may be easier to copy the memory into a VFO instead. You cannot, however, switch **VFOs**, or between memory and VFO operation (pressing the necessary buttons cancels Dual Watch).

If you want to talk on the subchannel, you have to recall it, or press **MR SKIP*** to quit Dual Watch operation.

Naming Memories *NAME-03-*

You can assign a name of up to 4 characters to memories, and have it displayed with name or frequency. There are 48 different characters for naming, including a space and 11 special symbols.

Before naming a memory, first store its frequency and other settings as described previously, then:

- Press **MR SKIP*** and select the memory you wish to name. Hold the knob for ½ second, then turn it to display *NAME-03-*.
- Press the knob momentarily, then turn it so that **00** appears at the right. If this memory has been named previously, that name now appears at the left. Otherwise, the left side is blank.
- Press the knob again momentarily; **SE** appears to the right, with an blinking underline cursor appearing at the left-most digit location. Turn the knob to select a character.

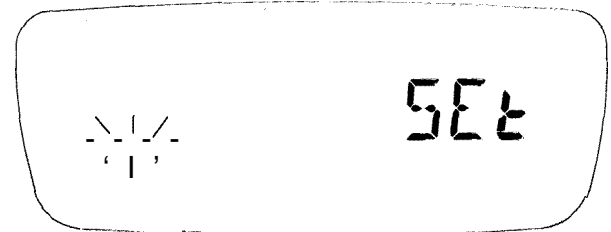

- With the desired character displayed, press the knob momentarily. The cursor moves one digit to the right. Turn the knob to select the next character.

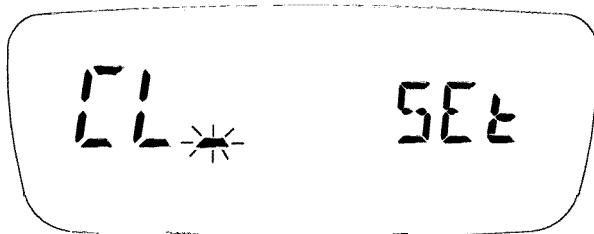

- Repeat the above step until all characters (up to four) are entered. To change any characters, press the knob momentarily to step the cursor through the characters to get to the one to change. Entered characters disappear when the cursor is on them, but reappear when the cursor moves.

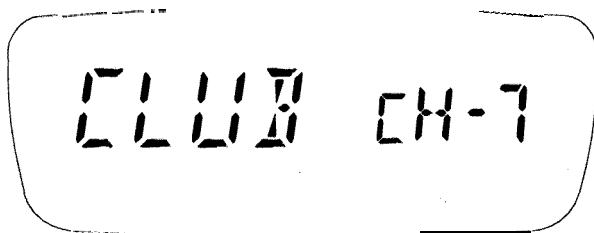



- Hold the knob down ½ second to store the name in memory, then press the PTT to return to the operating display; the name appears to the left, with the memory channel number at the right.

Note that blank spaces can also be entered instead of characters, and names do not have to begin at the first (left-most) character location. To cancel the display of memory names, set **NAME-03-** to **oFF**. You can always turn the names back on as they are preserved with the memories.



Memory Masking

You can mask stored memories from selection and display. Stored data remains and can be restored, until you overwrite it or reset the CPU. You can also restore unused memories, in which case you will find they are set to the bottom edge of the band. You can use this feature to easily check which memories you have not yet stored. You cannot hide [H-I] (this memory must always be accessible).

To hide a memory:

- Recall the memory you wish to hide, then press and hold  ½-second (until  blinks).
- Press ; the display changes to [H-I], and the previously memory can no longer be recalled manually, or included for scanning.

To restore a memory:







- Recall any memory, then press and hold  for M-second (until  blinks). Use the knob to select the memory to be restored, then press  to finish.

Be careful not to overwrite hidden memories accidentally; you cannot recover their previous contents.

Memory-Only Mode



This allows operation only on stored memories, which are displayed by name (if any) at the left, and the memory channel number to the right. No frequency is displayed, and only hyphens appear if you haven't assigned a name to a memory.





Repeater shift and tone setting indicators are displayed, although they cannot be changed. In fact, the *alternate functions of most keys are disabled, as well as the functions accessed by holding the knob down.* Only these functions are available, as indicated:

- Hi/Low TX Power:  ^{LW}LCK
- Lock:  ^W →  ^{LW}LCK
- Channel Selection: knob or keypad
- Memory Scanning:  ^{MR}SKIP*
- Reverse Repeater Split:  ^{RV}HM
- Dual Watch:  ^W →  ^{VFO}DW#
- Digital Voice (with optional FTT-12)

After programming memories, you can toggle memory-only operation on and off by turning the radio off, then holding the PTT and LAMP buttons (top and bottom buttons on the left side) while holding the PWR button for ½ second to turn it on again.

Locking the Controls LOCK-17-

The keypad buttons, knob and PTT can each be “locked” (disabled), to prevent inadvertent transmissions or adjustments. By default, only the keypad locks. To activate or deactivate the lock, press  ^W →  ^{LW}LCK. To change the locking scheme to lock the knob or PTT:

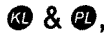
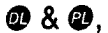
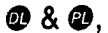
- Hold the knob for ½ second, then turn it to display **LOCK-17-**. Press the knob momentarily, and turn it to select the items to lock :
 -  = keypad,  = DIAL (knob),  = PTT button, or their combinations:
 - , , , or 
- Press the PTT to return to the operating display..

Transmit Time-Out Timer TOT-22-

To limit accidental transmissions, such as if the radio slips between the car seat with the PTT squeezed, the time-out timer shuts off the transmitter after continuous transmission of 2.5 minutes. To change the time-out duration:

- Press the knob down for ½ second, then turn it to display **TOT-22-**.
- Press the knob momentarily, then turn it to select 1, 2.5, 5, 10 minutes (or **OFF**, to disable the timer).
- Press the PTT to save and exit.

Tone Squelch Modes

These systems allow silently monitoring until a call directed to you is received, and offer privacy on an otherwise busy channel.

CTCSS Tone Squelch

Note • CTCSS *decode* (tone squelch) operation requires the optional FTT-12 keypad, and **T SQ** cannot be selected until the unit is installed.

CTCSS am (Continuous Tone Coded Squelch System)

This imposes a continuous, subaudible tone on your transmitted audio. When decoded at the other station, this allows their squelch to open and receive your transmission. Some “closed” repeaters use this to limit access, or to prevent signals intended for other repeaters (with the same input frequency) in fringe areas from locking up the repeater. There are 39 selectable CTCSS tones.

DCS **DCS** (Digital Coded Squelch)

DCS operation modulates a subaudible tone according to a digital protocol (continuous **32-bit** synchronous code). DCS is widely used in the commercial land-mobile industry for its high performance and 104 codes (offers greater privacy than CTCSS).

To use either CTCSS or DCS, both stations must be on the same frequency, and have selected the same CTCSS tone or DCS code.

To activate CTCSS or DCS operation, press **TN TS**:

T (encode) appears when the CTCSS tone generator is activated for transmission only.

T SQ (encode & decode) appears when the CTCSS tone squelch is activated for both tx & rx (only signals “encoded” with the matching tone open the squelch).

DCS appears when the digital code squelch system (tx & rx) is active.

To select a CTCSS tone:

- Press **TN TS**, as needed, to select **T** or **T SQ** operation. Press **Q W** → **TN TS**, to display the default tone at the *right* side of the display.

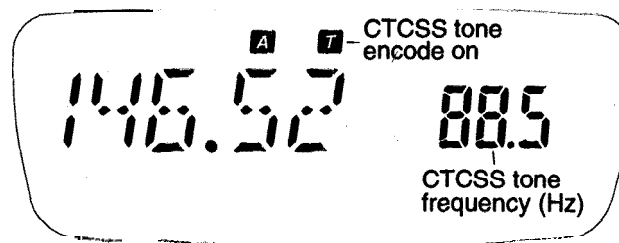

- Next, turn the knob to select the desired tone (see the table on the next page), then press **TN TS** to exit.

To select a DCS code:

- Press **TN TS**, as needed, to select **DCS** operation. Press **Q W** → **TN TS**, to display the default code at the *right* side of the display.
- Next, turn the knob to select the desired code (see the table on the next page), then press **TN TS** to exit.

CTCSS/DCS settings are stored in each memory along with other data. To change a programmed tone/code or state, recall the memory, change the value, and save the memory again.

CTCSS Tone Table (Hz)							
67.0	69.3	71.9	74.4	77.0	79.7	82.5	85.4
88.5	91.5	94.8	97.4	100.0	103.5	107.2	110.9
114.8	118.8	123.0	127.3	131.8	136.5	141.3	146.2
151.4	156.7	162.2	167.9	173.8	179.9	186.2	192.8
203.5	210.7	218.1	225.7	233.6	241.8	250.3	

DCS codes							
023	025	026	031	032	036	043	047
051	053	054	065	071	072	073	074
114	115	116	12	125	131	132	134
143	145	152	155	156	162	165	172
174	205	212	223	225	226	243	244
245	246	251	252	255	261	263	265
266	271	274	306	311	315	325	331
332	343	346	351	356	364	365	371
411	412	413	423	431	432	445	446
452	454	455	462	464	465	466	503
506	516	523	526	532-1	546	565	606
612	624	627	631	632	654	662	664
703	712	723	731	732	734	743	754

CTCSS or DCS Bell Paging BELL-18-

Bell Paging adds an alert ringer to CTCSS and DCS tone squelch operation, for added convenience. The CTCSS/DCS Bell mode displays  at the bottom of the frequency display when enabled. When you receive a call with a matching CTCSS tone or DCS code, the ringer sounds to alert you to the call.

To activate CTCSS or DCS Bell operation (with either CTCSS tone squelch (**TSC**), or DCS (**DCS**) operation already enabled):

- Hold the knob for ½ second, then turn it to display **BELL-18-**. Press the knob, then turn it to activate the bell and select 1, 3, 5, or 8 rings, **r P t** (rings until the PTT is pressed), or **a F F**.
- Press the PTT to save and exit.

Note that other stations do not need to have the CTCSS or DCS Bell function to call you: they can just use standard CTCSS/DCS encoding. You can store the Bell ringer activated in a memory, along with different CTCSS tones, DCS codes, and encode/decode states.

Operating Tip

When you reply to a CTCSS or DCS Bell call, you may want to turn off the Bell function (but leave **TSC** or **DCS** on), or else the transceiver will ring every time your squelch opens.

Tone/Code Scanning (CTCSS/DCS)

When using CTCSS tone squelch (FTT-12 required) or DCS, you can have the radio scan through the tones or codes to determine which one is present on a received signal. Before tone scanning, either tone squelch or DCS must be activated (press  as necessary until either **TS** or **DCS** is displayed).

Press  →  to display the CTCSS tone frequency or DCS tone **code** at the right.

Press and hold  for ½ second to start scanning for a matching tone or code.

Scanning slows when a signal is present, and pauses and blinks when the matching tone/code is found. To accept the displayed tone frequency or code for operation and return to the operating display, press  twice, momentarily.

Busy Channel Lock-Out **BCLO-73**

To prevent transmitting on top of other stations, you can prevent the transmitter from operating whenever a signal is present. To turn on BCLO:

- Hold the knob down for ½ second, then turn it to display **BCLO-23**.
- Press the knob momentarily, then turn it to select **on**. Press the **PTT** to exit.

Note - BCLO may cause problems with repeaters that require response before the carrier drops.



DTMF Code Squelch/Paging Modes

DTMF (Dual-Tone, Multi-Frequency) encoding and decoding allow paging and selective calling using **3-digit** codes transmitted as DTMF sequences. Your receiver remains silent until it receives three DTMF digits that match/ those stored in a dedicated code memory. The squelch then opens so the caller is heard, and, in the paging modes, an alert ringer sounds. *Note* - requires optional **FTT-12** keypad.

Introduction to DTMF Code Squelch

With code squelch, both stations use the same 3-digit DTMF code, sent automatically each time you transmit. The 999 code combinations give an added degree of privacy over CTCSS, and works **hand-in-hand** with the DTMF paging schemes, covered later.

After you and the other station have agreed upon a **3-digit** DTMF code, you need to store this in a private code memory:

- Press  →  so the display appears as below, turn the knob (if needed) to select code memory **P**.

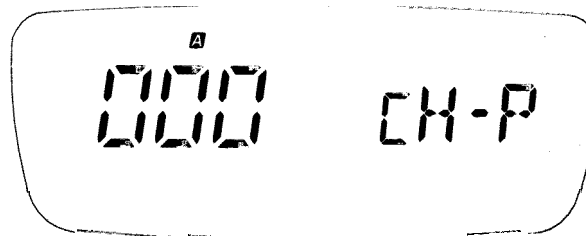

- Use the keypad to enter a three-digit code, and press the **PTT** to save the code and exit.

Now, with your **3-digit** squelch code stored, you can activate DTMF Code Squelch operation:

☐ Press **REW** → **1PAGE**, then **1PAGE** again until **CODE** appears at the display bottom.

When a call opens your squelch (CODE blinks), you can begin your QSO as normal. DTMF code squelch “hangs” open for about three seconds after the received carrier drops, to give you time to respond, then “resets” (**CODE** stops blinking).

Each time you transmit, you will hear three DTMF tones - remember to pause a moment before speaking (as the code is sent). You won't hear their DTMF tones the first time you receive a call, as your squelch does not open until after they are decoded. Afterwards, however, you will hear them while your squelch remains open.

Introduction to DTMF Paging

DTMF paging allows selectively calling other friends or groups by transmitting **3-digit** ID codes that are known beforehand. It extends the previously covered DTMF code squelch mode a step further by providing a means of identifying stations that called you while you were absent - their (paging) ID codes can be displayed and recalled.

There are two types of DTMF paging calls:

Private Call - Here you only receive paging calls that are prefixed with your private **3-digit** code; your squelch opens, the alert ringer sounds, and the **3-digit** code of the station calling is stored in code

memory C, which automatically displays the identity of the calling station.

Group Call - You can receive paging calls for up to six other groups (paging codes match one of those in code memories 1 - 6). The calling station's ID is still entered in code memory C; however, you must *manually recall it to see who called*.

DTMF Paging uses a specially-formatted string of 7 DTMF digits, as shown below.

Format of DTMF Paging Sequence (sent from left to right)						
1st	2nd	...	3rd *	4th	5th	6th
ID of <i>called</i> station			flag		ID of <i>calling</i> station	

There are eight DTMF code memories (labeled 1 ~ 6, P, and C), which each store a **3-digit** code:

P stores *your* private **3-digit** paging code.

1 ~ 6 store the codes of other friends or groups you expect to communicate with.



C is read-only, and stores the ID decoded from a received DTMF paging string. This can be recalled to see the code of the station who called you.

When you want to page someone, you must first select the code memory (1 - 6) holding their **3-digit** code. Then, when you transmit, their code is automatically formatted along with yours, and is sent as the DTMF paging string. Actually, this sequence can be sent manually if needed using any transceiver equipped with a DTMF keypad.

Programming DTMF Paging Code Memories

Before using DTMF Paging, you will need to store your ID code in Code Memory P to receive private calls (you may have already done this, as this slot is also used for DTMF code squelch operation - see page 35). Afterwards, you can store up to six other codes of your friends' for group calls.

Follow this procedure to store code memories:

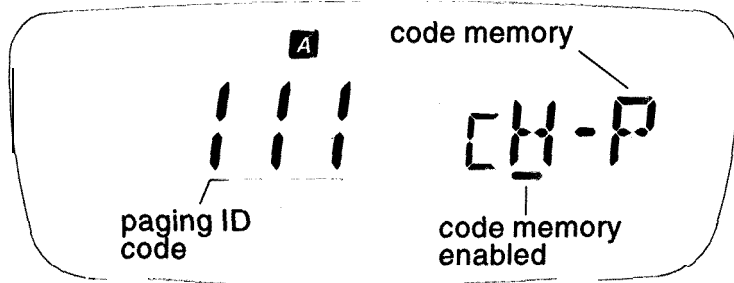

- Press  →  to recall the code memory list. Turn the knob to select code memory P, then use the keypad to enter a three-digit code.



- If you know other paging codes of other friends or groups, you can enter them now - turn the knob to select code memories 1 - 6 and repeat the code digit entry process.
- Press the **PTT** to save the code entries and exit.

Select Code Memories for Operation

In the previous step, you entered your private paging ID in code memory P, along with other group codes in memories I-6. By default, code memories I-6 and P are automatically enabled for operation as soon as they are stored with a code, and Code memory P cannot be turned off. Likewise, code memory C is read-only. Code memories 1-6, however, can be enabled/disabled individually, should you not want to be bothered receiving calls for particular groups:

- Press  → , and rotate the knob to select a code memory that you want to temporarily disable.
- Now, press  as necessary to enable/disable the selected code memory (the under bar disappears for disabled code memories).
- Turn the knob to select other code memories, and repeat the process as needed to enable/disable others (except C and P) as needed.

DTMF Paging Operation

Receiving DTMF Paging Calls PAGE

The only difference between receiving private and group paging calls is how the transceiver responds when the call is decoded. To **set** up to receive DTMF paging calls, you must first turn on this feature:

- Press $\text{[W]} \rightarrow \text{[PAGE]}$ so that **PAGE** appears. If the ringer is enabled (see note below), \bullet **V** also appears.
- Next, press $\text{[W]} \rightarrow \text{[CODE]}$ and turn the knob to select the code memory holding the paging code you want to monitor. To receive *private* calls, this must be code memory **P**, for *group* calls, select **1 - 5**.
- Press the PTT to save and exit.

You are now ready to receive DTMF paging calls. If a private page call is decoded, the alert ringer sounds, the squelch opens, and code memory **C** appears at the right.

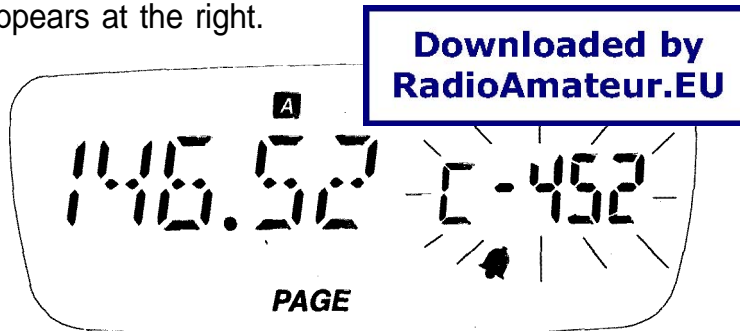

For *group* calls (code memories **1 ~ 5**), the ringer sounds and squelch opens as before, but the group code appears instead of the calling station's code.

You can still find out who called your group or friend, remember that code memory **C** (read-only) always holds the ID of the station sending the page call. This time, you must recall it manually (it only appears automatically for private calls).

Sending DTMF Paging Calls

To respond to a private page call, pressing the **PTT** sends the other station's ID code, a DTMF "star" (*) then your private ID code (code memory **P**) automatically, and resets to receive another call. In this case, Code memory **C** is displayed and formatted so you can respond directly.

For group calls, however, pressing the **PTT** sends a group call using the group ID of the selected (and displayed) code memory (i.e., you wouldn't answer the calling station, but page the called group). Response is designed this way since the original call was directed to another group, rather than to you.

Note about Ringer Settings

There are two separate ringers that sound in the FT-50R; one for the CTCSS/DCS bell feature, and another used for DTMF paging modes.

The CTCSS/DCS bell is configured using **BELL** - **18** (covered on page 34), while the DTMF paging ringer is a function within **PRG E** - **27** (pages 39-40).

Remember that these are configured separately to eliminate any confusion during feature descriptions.

To send a page call:

- Press **Q.W** → **2CODE** and turn the knob to select (display) the code memory of the station you want to page. Press the PTT to exit.
- If you haven't done so already, press **Q.W** → **1PAGE** to enable the DTMF paging mode (*PAGE*).
- Make sure the channel is clear, and press the PTT (follow with your callsign, of course).

To talk after receiving and responding to their call, just switch from paging to code squelch mode:

- Press **Q.W** → **1PAGE**, then **1PAGE** as necessary so that **CODE** appears, then press the PTT to exit. When you finish your QSO, reactivate DTMF Code Paging in the same way (**PAGE** displayed).

Trigger Paging **T.PAGE**

With regular DTMF paging just described, to have a QSO after responding to a page call, either you or the other station (but not both) must select code memory **[**, to use a common DTMF code when switching to DTMF code squelch operation.

Trigger paging overcomes this inconvenience of manually switching to/from code squelch operation, however, it can only be used between transceivers so equipped with this feature.

To activate trigger paging:

- Press **Q.W** → **1PAGE**, then **1PAGE** as necessary so that **T.PAGE** is displayed, then press the PTT to exit.

When a call is received, **T.PAGE** blinks, and the alert ringer sounds. If the other station **is also** using trigger paging, you can respond by just pressing the PTT and talking within 3 seconds after the DTMF code sequence is sent. The pager resets to receive a new call if either station fails to respond to the other within 3 seconds.

Auto-Respond Paging **PAGE-27-**

This feature responds automatically (without operator intervention) to received calls by “paging back” the calling station. This has the same effect as if you manually pressed the PTT after receiving a call in either regular or trigger paging modes.

There are two auto-respond modes:

Answer-Back - this acknowledges a page call by “paging back” the calling station (just as if you manually selected their **3-digit** code and pressed the PTT).

Page Forwarding - this “repeats” a page call in its original sequence (rather than reversing the ID code pair as in answer-back format), relaying the call to extend your paging range.

You can leave your radio with this mode enabled in your vehicle, office or other vantage point when you are temporarily away, but will be using another transceiver and don't want to miss any paging calls.

To enable auto-respond paging:

- Recall **PAGE · 27·**, press the knob momentarily, then turn it to select **ANS**.
- Press the knob momentarily again to display the current *answer-back* mode: **ANS**, **FOR**, or **OFF**.
- Turn the knob to select the desired mode, then press the **PTT** to save the change and exit.

Now, with either auto-respond mode enabled, the transceiver reacts to a valid page call by answering or forwarding the DTMF page sequence, according to selected mode.

Paging Transmit Delay **DELAY**

When calling other stations using DTMF paging or DTMF code squelch (particularly through repeaters), you may find that some stations are unable to receive your calls. This can be caused by their squelch not opening fast enough (after receiving your transmitted carrier) to allow all of the DTMF digits to be received and decoded.

To correct this problem, you can set a longer delay between the time your transmitter is keyed and the first DTMF digit is sent:

- Recall **PAGE · 27·**, press the knob momentarily, then turn it to select **DELAY**.
- Press the knob momentarily again to display the current time delay (*ms*): **250**, **450**, **750**, or **1000**. This is the delay between the moment your press

the **PTT** and transmission of the first DTMF code digit. Set it to **750 ms** or **1000 ms** if operating through a repeater that cuts off the first digit.

- Turn the knob to select the desired delay, then press the **PTT** to save the change and exit.

Playback Speed **SPEED**

This selects the tone duration (50 or 100 ms) for each DTMF paging digit, to select fast or slow playback speed during paging operation. The 50 ms tone duration are preferable, but the slower tones may work better under weak signal conditions.

- Recall **PAGE · 27·**, press the knob momentarily to display **SPEED** (DTMF code sending speed).
- Press the knob momentarily again to display the current speed setting, and turn it to change the setting: **50** or **100 ms** per tone. Press the knob again (or press the **PTT** to exit).

Paging Bell **BELL**

- Rotate the knob one click to display **BELL** (or press **PTT** to quit), then press the knob momentarily again to display the current bell setting: **1**, **3**, **S** or **B** rings, **rPt** (rings until the **PTT** is pressed), or **OFF**.
- Set it to **OFF** only if you do not want the ringer to sound (these settings do not affect the CTCSS or DCS ringer). Press the **PTT** to exit.

ARTS Auto Range Transpond System

This system uses DCS signaling to inform you when you and another ARTS-equipped station are within communications range. Both stations must first select DCS operation using the same DCS code. The ringer can be activated or not, as desired

Whenever you push the PTT, or every 15 seconds after ARTS is activated, your radio transmits a (subaudible) DCS signal for about 1 second. If the other radio is in range, a beeps sound and their display shows **RANG** (in range), or yours does if their radio polls yours first.

Whether you talk or not, both radios continue polling each other. If your CW IDer (covered on the next page) is turned on, your radio IDS in Morse code every nine minutes. As long as your stations remain within range, two beeps sound each time a poll is received (or each time they presses their PTT).

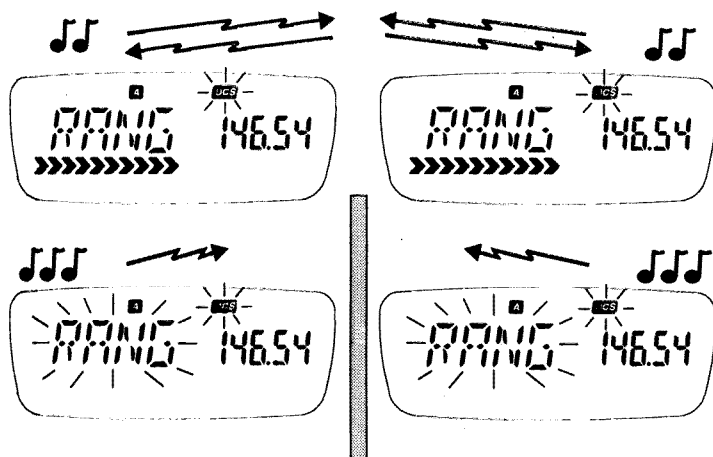

If you move out of range for more than one minute (four pollings), your radio senses that no signal has been received, three beeps sound, and **RANG** *blinks*. If you then move back into range, as soon as they transmit (or their radio polls) your radio sounds, and **RANG** stops blinking

During ARTS operation, your operating frequency is displayed, *but you cannot change it or other settings*. Also, the squelch does not open until a signal is received for about one second, so remember to pause before speaking after pressing the PTT.

To use ARTS:

- First ensure the battery saver feature is disabled.
- Activate DCS (press **TN TS** repeatedly until **DCS** appears). Display the DCS tone code (press **W** → **TN TS**), and set it to match the other station.
- Press **W**; **R X** (receive-only), **T X** (transmit-only), **TR X** (transceive) or just your operating frequency appears at the left, indicating the current ARTS mode (described on the next page). Press **W** again if you want to change it (the operating descriptions assume both radios are set to **TR X**).
- Press **TN TS** alone when done. The display returns to normal, except that now **DCS** is blinking (indicating ARTS is enabled, as opposed to regular DCS operation).
- Finally, to activate ARTS, press **W**, and then hold the knob down for ½ second. Two beeps sound, and your ARTS mode selection appears at the left,

with your operating frequency at the right, and with **DCS** blinking.

- ☐ To cancel ARTS operation, press **QW**, and then press down on the knob and hold it for ½ second. Next, press **QW** → **TN.TS**, then **QW** again, as necessary, to display the frequency at the left again, then press **TN.TS** to finish.

ARTS Modes **R X T X T R X**

In the previous ARTS description, both transceivers were set to the **T R X** (transceive) mode. There are two other ARTS modes available, as outlined below:

R X - Use this mode if you only want your radio to listen, and not poll the other station (in which case their radio should be set to the **T X** mode). Here, your radio will beep and display **R R A N G** (steady or blinking) to indicate the state of connection.

T X - This puts your radio into a transmit-only “beacon” mode where you won’t hear the polling beeps (but you can still hear when the other station talks). When activated, you have *no display of whether the other station is in range*, or not (**R R A N G** does not appear). You should have your CW IDer enabled when this mode is activated (explained at the right).

Your ARTS mode selection is retained by the VFOs and can be stored in memories. If you want to use normal DCS operation, you have to cancel ARTS by selecting the operating frequency when the DCS tone number is displayed (by pressing **QW** → **TN.TS**).

CW ID (Morse Identifier) **[W I] - 26 -**

The CW IDer sends your CW ID about once every 16 pollings during ARTS polling and DTMF answer-back paging (covered later).

To store your **callsign** and activate the IDer:

- ☐ Hold the knob down for ½ second, then turn it to display **[W I] - 76 -**. Now press the knob momentarily, then turn it if necessary, to display **00** at the right.
- ☐ Press the knob again momentarily. The digit location counter appears at the right, with a segment for the ID entry position at the far left (all flashing).

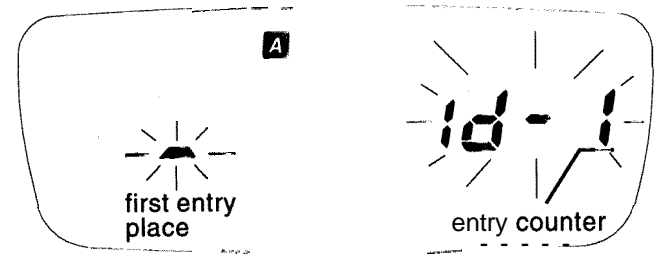

- ☐ Turn the knob to change the character at the left to be the first letter of your callsign. Press the knob *momentarily*. The digit location number **2** now appears at the left. Again turn the knob to select the second character of your callsign.
- ☐ Repeat the above step to finish entering your **callsign** (up to 16 characters), then hold the knob down for ½ second to accept your entry, and finally press the PTT to quit.

ARTS Polling Speed **ARTS-25 SPEED**

You can increase the ARTS polling rate, to have the radio check propagation state more frequently, such as when one or both stations are mobile.

- Hold the knob for ½ second, then turn it to display **PRGE - 25 -**. Press the knob momentarily, and turn it to select **SPEED** (polling speed).
- Press the knob again momentarily, and turn it to change the setting: 15 or 25 second polling intervals. Press the **PTT** to save and exit.

ARTS Polling Beeper **ARTS-25 BEEP**

You can disable the two beeps that sound each time the radio validates a polling (in-range), and three beeps that sound when the units are out-of-range:

- Hold the knob for ½ second, then turn it to display **PRGE - 25 -**. Press the knob momentarily, and turn it to display **BEEP**.
- Press the knob again, and turn it to select **ALL** (all beeps enabled), **RNS** (disable in-range, double-beeps only), or **OFF** (all beeps disabled). Press the **PTT** to save and exit.

DTMF Autodial Feature

Eight **autodial** memories each store DTMF tone sequences of up to 16 digits for remote DTMF control, or telephone numbers for autopatch calls. A ninth memory is read-only and stores DTMF sequences (up to 32 digits) decoded off-the-air.

To store a DTMF autodialer memory:

- First activate the autodial mode* by pressing **MEM** → **DTMF** so that **DTMF** appears in the display.
- Hold **MEM** for ½ second (two beeps), and within 5 seconds, press a numbered key (1-8) corresponding to the **autodial** memory number you want to store (see below).

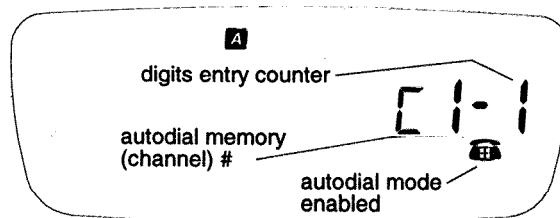

- Hold **MEM** again for ½ second, then (within 5 seconds) key in the phone number you want to store. As you do so, the digit counter increments as the entered digit is displayed to the right of it.

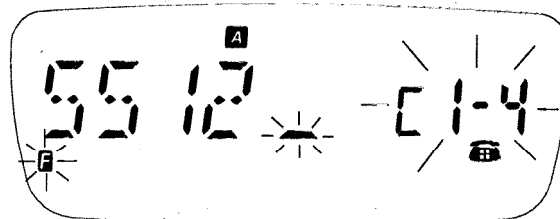

If you make a mistake, hold the knob for %-second to clear all entries for that memory and re-enter all the digits ,



- After entering the final digit, press the PTT momentarily to revert to the edit display. You can turn the knob to review your stored number, or press the key corresponding to that memory to replay it.
- If you want to select another DTMF memory to store, press a numbered key, as before, corresponding to the desired memory number. Otherwise, pressing the PTT again exits to the frequency display.
- Repeat the last two steps, and enter the autodial digits, as desired.
- Press the PTT twice to return to the frequency display.

Note • The non-numeric DTMF tones map to the FTT-12 keypad as follows:

DTMF Tone	A	B	C	D	*	#
Display	R	J	L	J	E	F
Key	LW LCK	TN T.S	RV HM	Q W	MR SKIP*	VF ODW#





Autodialer Playback

You can manually check the contents of DTMF autodial memories while  is displayed. Also use this to play back stored memories into a telephone.

- Hold  for %-second, then press any numbered key to display and play that DTMF memory. Turn the knob to review each stored digit.
- To play back DTMF autodial memories on the air, first ensure the DTMF memory mode is on ( displayed).
- Close the PTT and press the number of the autodial memory to transmit. Once the DTMF sequence has begun, you can release the PTT.

DTMF Decoder

You can use a reserved, read-only, autodialer memory (C - 9) to display and store DTMF sequences decoded off-the-air as they are received:

- With  displayed on the operating channel you expect to receive DTMF transmissions, hold  for %-second, then press  to select autodial memory 9 (C - 9).
- Now, and DTMF tones received are decoded, then stored into C-9. The digits scroll from right to left as they are decoded, and up to 32 digits can be stored. Any additional digits overwrite previous ones, on a first-in, first-out basis.
- To clear the stored digits in C - 9, push and hold in  for 1/2 second, then push and hold in the knob for ?&second.

Digital Voice Recorder (requires FTT-12)

The FTT-12 includes a digital voice recorder that stores one or two messages up to 20 seconds long. You can record messages by the microphone for, playback manually or automatically over the air, and you can manually or automatically record received signals.

By default, one message can be recorded, and is displayed as **REC** and **PLY** during recording and playback, respectively. Before recording, you may wish to partition the **20-second** voice memory into two segments, displayed as **REC1/PLY1** and **REC2/PLY2**. The second segment can be up to 10 seconds long, with the first segment using the remainder (see illustration).

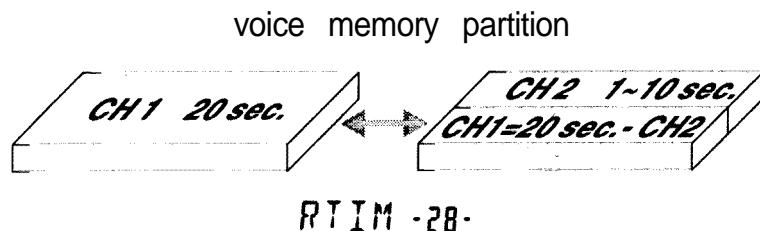

Both segments can be used for manual recording and playback, but only the first segment can be used for automatic receive recording, and only the second segment can be used for automatic voice transmission.

To partition the voice memory recording time:

- Hold the knob down for ½ second, then release and turn it to display **RTIM -28-**.
- Press the knob momentarily and turn it to set the number of seconds to record for **REC 7** (up to ten seconds). The remaining time (20 minus the selected time) is allocated to **REC 1**.
- Press the PTT to return to the operating display.

Note: If you record without first partitioning the voice memory, and later partition it, the *second part* of your previous message will be in the first partition (played back as **PLY 1**), and **PLY 2** will play back the *entire original message, but with the partitions reversed!* To clear this condition, record the second partition (**REC 2**) again.



Microphone Recording

To record your voice through the microphone:

- Hold  for ½ second until **REC** or **REC 1** appears, if you have partitioned the voice memory, turn the knob if you want to record **REC 7**.
- Press the PTT and speak your message into the microphone (no transmission occurs).

During recording, **MIC** appears at the left, and the number of seconds remaining in the segment counts down at the right. You can release the PTT to stop.

Speaker Playback

- To play back a message recorded as *REC* or *REC 1*, hold  for ½ second. The left side of the display shows *PLY* or *PLY1*.
- To play back a message recorded as *REC 2*, press  and then hold  for ½ second. The left side of the display shows *PLY2*.

Receiver Recording

To record a signal from the receiver:

- Hold  for ½ second until *REC* or *REC 1* appears.
- If you have partitioned the voice memory, turn the knob if you want to record in *REC 2*.
- Hold the **Monitor/TCall** button (on the left side, just below the PTT) to record: *REC 1* appears at the left, and the remaining seconds of memory counts down at the right. You can release the button to stop, or wait until the counter runs down. Recording level is not affected by the volume control.

Speaker playback is as described above.

Transmitter Playback

You can manually play back any recorded messages over the air. You can hear them through the speaker during transmission.

- To transmit recordings made with *REC* or *REC 1*, hold the PTT while pressing the knob down *momentarily*. You can then release the PTT: the message transmits until it is done.

To transmit a recording made with *REC 2*, hold the PTT while *pressing and holding the knob down for ½ second*. Then release the knob and PTT: the message transmits until done.

Recording Protection

RPRT-29

This protects any or all recordings from being accidentally over-written:

- Hold the knob for ½ second, and then release and turn it to display *RPRT-29*.
- Press the knob momentarily, then turn it to select *on* (or *off* to deactivate).
- Press the knob again momentarily to accept your setting, and press the PTT to exit.

Now, attempting to overwrite any voice memory with a new recording is blocked.

VMPS (Voice Mail Paging System)

The DTMF Paging and Automatic Recording capability of the FTT-12 keypad may be utilized to allow the storage of “Voice Mail” in an FT-50R which is so equipped. A message of up to 20 seconds in length may be stored in your radio for later recall.

To use this system, two conditions must be met:

- I. The calling station must know your private or group DTMF paging ID code (see page 37).
- II. Your transceiver must have DTMF paging or Trigger paging activated (see page 38 ~ 40).

To set up for VMPS operation:

- First, ensure that your private paging ID code is stored in DTMF Code memory F^1 ($\text{CW} \rightarrow \text{2CODE}$).
- If you haven't already done so, partition the voice memory so as to set up the desired Voice Mail time limit. Without this partitioning, the full 20 seconds of recording time will be available.

IMPORTANT !

ARTS, VMPS, and the auto-response modes for DTMF paging transmit without operator presence. Ensure this type of operation is legal in your country before using it, and adhere to any or all regulations regarding timed station identification (CW ID).

- Activate DTMF paging or Trigger paging ($\text{CW} \rightarrow \text{1PAGE}$).
- Hold the Knob for 1/2 second, then release it and turn it to display $PRGE \cdot 77 \cdot$.
- Press the knob momentarily, then turn it to select $RMSS$. Press the Knob again, turn it to select 00 , then press the PTT switch to exit.
- Press CW and then *hold* TN.TS for 1/2 second; $PR EC$ will appear on the left side of the display, and the receiving frequency at the right.

When a station bearing the correct DTMF paging code calls your FT-50R, the alert ringer of your radio will sound, and the receiver squelch will open. Automatic off-the-air recording will then commence ($PR EC$), storing until the recording partition time limit has been reached, or until the other station stops transmitting (whichever comes first). You may now play back the stored message (from register $PLY 1$) when you return to your transceiver. The blinking DTMF code indicator on the right-hand side of the display provides a visual indication that a message has come in during your absence.

Only one Voice Mail message may be stored at any time, and newer messages will overwrite previous ones.

Downloaded by
RadioAmateur.EU





Extending Battery Life



Operating time depends largely on tx/rx duty cycle, and how you care for the battery pack. The FT-50R offers several ways to conserve battery power, and extend the life of each charge.

APO (Automatic Power-Off) *RP 0-16-*

Obviously the best way to save battery life is to turn the set off when not in use. You can activate APO to turn the transceiver off after a half hour, one, three, five, or eight hours of key inactivity. APO is disabled by default, but you can activate it as follows:

- Hold the knob for ½ second, and then release and turn it to display *RP 0-16-*. Press the knob momentarily, then turn it to select *0.5H, 1H, 3H, 5H, 8H* or *oFF* (APO deactivated).
- Press the PTT to exit.

 shortcut to setting the APO delay:  → .

When the APO timer is active,  appears in the display, and the timer resets every time you press a key or move the knob. If you don't press any keys for the selected time-out period, and you are not scanning or using Dual Watch,  begins blinking, and if you have the key beeper activated (see the following page), an alert melody plays about a minute before the radio turns itself off. Press a key in that minute if you want the radio to stay on.



Once it turns off, you must switch the radio back on for use. If you need to monitor for a long period, or if using an external DC supply, you can deactivate APO by the same steps above.

Receive Battery Saver *SAVE RSRW-14-*

The receive battery **saver** reduces current drain during squelched monitoring by putting the receiver to “sleep” after the squelch closes, and then “waking it up” periodically to check for activity. When enabled, *SAVE* blinks near the bottom right of the display.

You can select from five monitor/sleep durations, from 200 ms to 2 sec. The battery saver is enabled by default. To check or change the ratio or disable the Battery Saver:

- Hold the knob down for ½ second, then release it and turn it to display *RSRW-14-*. Press the knob momentarily, then turn it to select *0.2, 0.3, 0.5, 1.11, 2.0*, or *oFF*.
- Press the PTT to exit.

 shortcut to setting the Rx battery saver “sleep” time:  → .

Transmit Battery Saver **T S R I I - 15 -**

Always use the lowest transmitter power necessary to maintain reliable communications (this may be the law in your country). As described on page 18, there are four Tx power levels: high, low 1, low 2 and low 3. Activating TX Save can reduce transmitter current drain even further, by reducing power output when a full-scale signal is sensed on the receive frequency.

TX Save can be turned on as follows:

Hold the knob down for ½ second, then release it and turn it to display **T S R I I - 15 -**. Press the knob momentarily, then turn it to select **00** (or **0 F F** to deactivate).

Press the PTT to exit.

 shortcut to set the Tx battery saver :  **W** →  **0TX SAVE**

Notice that the **SAVE** indicator is displayed *during transmission* when the TX Save function is activated.

Regardless of whether you use the TX Save feature, remember that the current drain of the **L I** setting is much less than the **H I** setting, so it is good to develop the habit of always using the lowest setting possible, switching to high power only when low power fails to get through.

If you need better range, consider using a higher gain antenna instead of high power (the effect on transmissions is the same, but receive performance improves as well). Make sure any external antenna is designed for 50 ohms impedance at the operating frequency.



Beeper Disable **BEEP- 13 -**

The keypad beeper draws several milliamperes, so you may want to disable it if you need to conserve power while using the controls a lot. Note, however, that you will lose the audible feedback that indicates key functions and errors.

To disable the beeper:

Hold the knob down for ½ second, then release it and turn it to display **BEEP - 13 -**. Press the knob momentarily, then turn it to select **00** (or **0 F F** to disable).

Press the PTP to exit.

 shortcut to disable the beeper :  **W** →  **0 BEEP**

LED Disable **L G T - 19 -**

The LED draws about 15 milliamperes when the squelch is open, and when transmitting. However, you may not need it: the **BUSY** function of the LED is duplicated by the  icon at the right side of the display when the squelch is open, and the bargraph always shows the TX power level when transmitting.

You can disable the LED to conserve power:

Hold the knob down for ½ second, then release it and turn it to display **L G T - 19 -**. Press the knob momentarily, then turn it to select **0 F F** (or **00** to enable).

Press the PTT to exit.

Lamp Illumination Modes *LAMP-20-*

The (lower) LAMP button illuminates the display when operating in the dark. By default, it lights for 5 seconds, but you can change it so that it lights (for 5 seconds) every time a key is pressed or the knob turned, or so that the LAMP button turns the light on until you press it again. To change the setting:

- Hold the knob down for $\frac{1}{2}$ second, then release it and turn it to select *LAMP-20-*.
- Press the knob momentarily, and turn it to select between *5 SEC* (the default), *KEY* (the keypad and knob activate the lamp for 5 seconds) or *TGL* (the LAMP button toggles the lamp on and off).
- Press the knob again momentarily to accept your setting, then release it and press the **PTT**.

Battery Care

As the battery discharges, the voltage drop (especially when transmitting) increases. When battery voltage drops to around 4.0 volts,  blinks at the bottom right of the display, indicating the batteries should be replaced or recharged. As battery voltage drops further, the transceiver shuts off.

If using rechargeable batteries, switch the transceiver off and recharge or replace the battery as soon as  appears. Try to avoid recharging Ni-Cd batteries often with little use between charges, as that can degrade the charge capacity and useful life of the cells. Since it is hard to know exactly when the charge will run out, you may want to carry an extra, fully-charged pack with you to avoid having operation interrupted.

Packet Radio

To use the radio for packet, the receiver battery saver should be disabled (see page 49), since the "sleep" periods used in power saving can cause packets to be missed.

Construct a TNC interface cable as shown in the drawing, and connect the **MIC/EAR** jack to your TNC. **MIC** impedance is 2 k Ω , and maximum input is 300 mVrms. **EAR** impedance is 8 ohms, and maximum output is 2 Vrms (w/9.6-V supply).

Note - the FT-50R is not recommend for use with 9600 bps data interconention/packet operation.

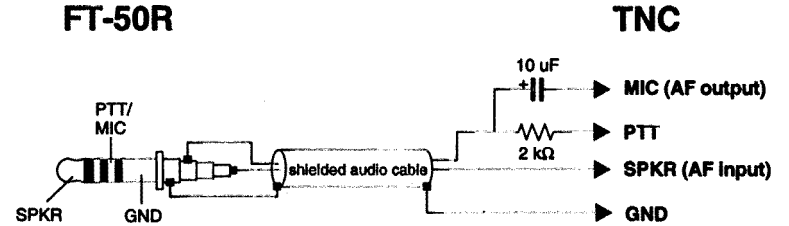

Detail of packet cable construction.

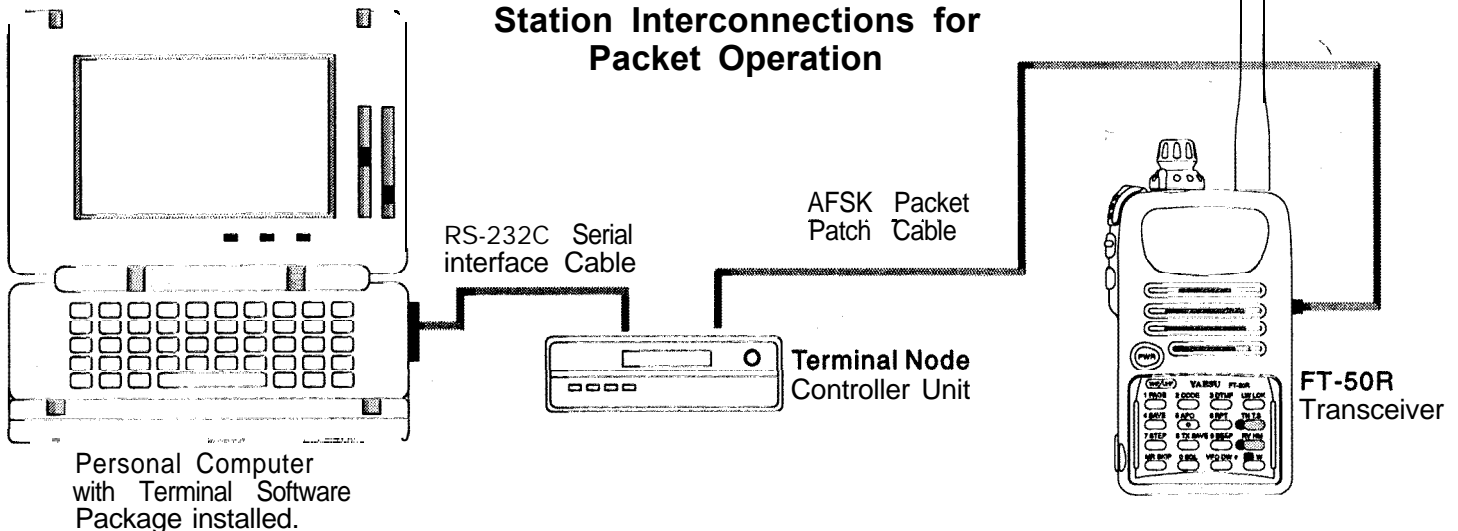

Cloning

You can copy all memories and settings from one radio to another of the same type, as follows:

- Set the squelch threshold level (SQ L - 01 -) to below "9", if necessary.
- Connect the MIC/EAR jacks of the two radios together using a cable with a 4-contact plug at each end. With both radios turned off, turn each one on while holding both the knob down and the PTT pressed (CLON appears on both radios).
- Press the middle (Monitor/TCall) button on the left side of the destination radio (WRIT appears). Press the PTT on the source radio, SEND blinks and WRIT blinks on the other radio as data is transferred.

If successful, CLON reappears on both displays. Otherwise, CERR appears, indicating an error occurred (see box).

- Restore the original squelch threshold level, as desired.

Note - if your cloning attempt fails, recheck the clone cable connections, and ensure that the receiver squelch threshold level on the destination radio is set to below level "9".

After correcting the problem, if you want to try cloning again, press the PTT to reset the source radio, or turn the destination radio off and back on (while holding the knob and button).

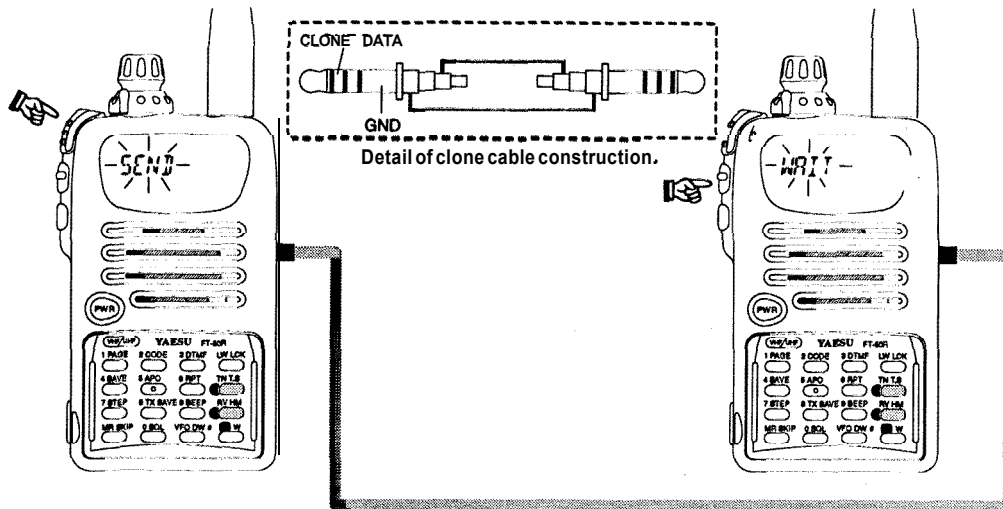

Customizations

MON Switch Function *KEY-21MONTCAL*



By default, pressing the middle switch on the left side of USA version transceivers disables the receiver squelch to monitor weak stations. In European transceiver versions, this transmits a 1750 Hz tone for repeater access instead.

These functions assignments can be reversed, if desired:

- Hold the knob down for ½ second, release it and turn to display *KEY · 21 ·*. Press the knob momentarily (*M/T* appears).
- Press the knob momentarily, then turn the knob to select either *MON* (for monitor) or *TCAL* (for tone call).
- Press it again momentarily, then press PTT to exit.



Now you can press the switch to access the assigned function.

Key Function *KEY-21· HOME REV*

By default, pressing  reverses 'repeater shift (tx/rx frequencies), while pressing  →  switches operation to and from the Home memory.









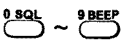

The default key function assignments can be reversed, if desired:

















- Hold the knob down for ½ second, release it and turn to display *KEY · 21 ·*. Press the knob momentarily.
- Turn the knob if necessary, to select *H/R* (for HOME/reverse), then press it again momentarily.
- Turn the knob to select *HOME* or *REV*, then press PTT to exit.

Now you can press  or  →  to access the assigned function(s).

Appendix

FT-50R Menu Function Table		
Menu #	Function	page
SQL 01	Receiver squelch threshold	17
TXPO 02	TX power level	18
NRME 03	Alpha-numeric memory name	30
SUB 04	Sub display option	20
ARS 05	Auto Repeater Shift	23
RPTR 06	Simplex or duplex (+/-) operation	24
SHFT 07	Tx shift (offset)	23
HDUP 08	Duplex (split) VFO operation	21
RPTL 09	Repeater input tracking	24
STEP 10	Tuning step size	20
RESM 11	Scan resume mode	27
SCNL 12	Scan lamp on/off	27
BEEP 13	Keypad beeper on/off	50
RSBK 14	Rx battery saver	49
TSBK 15	Tx power saver	50
RPO 16	Auto Power Off	49
LOCK 17	Keypad/Dial/PTT lock	32
BELL 18	Ringer (off, 1x, 3x, 5x, 8x, repeat)	34
LED 19	BUSY/TX LED disable	50
LAMP 20	LCD illumination mode	51
KEY 21	MON switch/e key assignment	54
TOT 22	TX Time-Out Timer	32
BCLO 23	Busy Channel Lock-Out	35
SFT 24	CPU clock shift - do not change!!!	----
ARTS 25	Auto Range Transpond System	41
CWID 26	CW identification	42

PRGE 27	Pager settings	39
RTIM 28	Digital record time	45
RPRT 29	Record protect	46
WSQL 30	Wide-FM squelch threshold	22
AMOD 31	Auto Rx mode select	22
RMOD 32	Rx mode override	23
Key Entry Table #1		
Press	Function	page
	Enter digits 0 ~ 9 for frequency entry during rx, DTMF digits during tx.	17
	Selects MR and MT operation during rx, enters DTMF * during tx.	19
	Selects VFO A/B during receive, enters DTMF # during tx.	19
	Toggle low/high tx power.	18
	Selects T , TSQ or DCS operation.	33
	Reverse tx/rx frequency channels for a duplex pair (used to monitor repeater input frequency).	24
	Activate alternate key function setting entry (5 seconds).	16
knob	Toggle main operating band.	14,21
HOLD	Function	page
	Start digital voice recording.	45,46
	Playback digital voice recording.	46
	Start VFO scanning.	27
	Recall memory for programming.	25
knob	Recall menu list.	14,15

Key Entry Table #2		
Press  →	Function	Page
	Select squelch setting.	17
	Select PAGE , T.PAGE , or CODE DTMF paging/squelch modes.	36,38
	Recall/select DTMF code memories 1-6., Pand . C.	35,37
	Activate DTMF autodialer.	43
	Select Rx battery saver feature.	49
	Enable/disable APO (auto power off) feature.	AA 49
	Select simplex or duplex (+/- Tx offset) operation.	24
	Select default channel steps size used for tuning and scanning.	20
	Enable/disable Tx battery saver.	50
	Enable/disable keypad beeper.	27,50
	Tag memory for scan skip.	27
	Activate DW (Dual Watch) operation.	29
	Activate selected locking scheme.	32
	no effect	
	Recall HOME memory channel.	26
knob	Activate ARTS.	41

Power-on Settings and Functions		
Hold the following while turning the power on.	Function	page
	KNOB & LAMP	Expanded Rx range 22
	LAMP & PTT	Memory-only mode 32
	KNOB & MON → 	CPU master reset -
	LAMP	LCD segment test -
	KNOB & PTT	Clone mode 53

Downloaded by
RadioAmateur.EU

CAUTION !

Changes or modifications to this device not expressly approved by Yaesu Musen could void the user's authorization to operate this device.

1. Changes or modifications to this device not expressly approved by Yaesu Musen could void the user's authorization to operate this device.
2. This device complies with part 15 of the FCC Rules. Operation is subject to the following two conditions; (1) this device may not cause harmful interference, and (2) this device must accept any interference including interference that may cause undesired operation.
3. The scanning receiver in this equipment is incapable of tuning, or readily being altered, by the User to operate within the frequency bands allocated to the Domestic public Cellular Telecommunications Service in Part 22.

This device complies with RSS-210 of Industry Canada. Operation is subject to the following two conditions; (1) this device may not cause interference, and (2) this device must accept any interference, including interference that may cause undesirable operation of the device.

Y A E S U

Performance without compromise.SM

YAESU MUSEN CO., LTD.

I-20-2 Shimomaruko, Ota-Ku, Tokyo 146. Japan

YAESU U.S.A.

17210 Edwards Rd., Cerritos, CA 90703, U S A.

YAESU INTERNATIONAL DIVISION, (Caribbean, Mexico, Central & So America)

7270 NW 12th St, Suite 320, Miami, FL 33126, U S A

YAESU EUROPE B.V.

Snipweg 3. 1118DN Schiphol. The Netherlands

YAESU UK LTD.

Unit 2, Maple Grove Business Centre,

Lawrence Rd Hounslow, Middlesex, TW4 6DR, U K

YAESU GERMANY GmbH

Am Kronberger Hang 2. D-65624 Schwalbach, Germany

YAESU HK LTD.-

1 1th Floor Tsim Sha Tsui Centre, 66 Mody Rd

Tsim Sha Tsui East, Kowloon, Hong Kong

Copyright 1996

Yaesu Musen Co., Ltd.

All rights reserved.

No portion of this manual
may be reproduced without
the permission of
Yaesu Musen Co., Ltd.

E07521002 (9609F-FA)