



DUAL BAND FM TRANSCEIVER

FTM-350R/E

Technical Supplement

©2010 VERTEX STANDARD CO., LTD.

EH033M90B

VERTEX STANDARD CO., LTD.
4-8-8 Nakameguro, Meguro-Ku, Tokyo 153-8644, Japan

VERTEX STANDARD
US Headquarters
10900 Walker Street, Cypress, CA 90630, U.S.A.

YAESU UK LTD.
Unit 12, Sun Valley Business Park, Winnall Close
Winchester, Hampshire, SO23 0LB, U.K.

VERTEX STANDARD HK LTD.
Unit 5, 20/F., Seaview Centre, 139-141 Hoi Bun Road,
Kwun Tong, Kowloon, Hong Kong

VERTEX STANDARD (AUSTRALIA) PTY., LTD.
Normanby Business Park, Unit 14/45 Normanby Road
Notting Hill 3168, Victoria, Australia

Introduction

This manual provides technical information necessary for servicing the FTM-350R/E Dual Band FM Transceiver.

Servicing this equipment requires expertise in handling surface-mount chip components. Attempts by non-qualified persons to service this equipment may result in permanent damage not covered by the warranty, and may be illegal in some countries.

Two PCB layout diagrams are provided for each double-sided circuit board in the Transceiver. Each side of is referred to by the type of the majority of components installed on that side ("leaded" or "chip-only"). In most cases one side has only chip components, and the other has either a mixture of both chip and leaded components (trimmers, coils, electrolytic capacitors, ICs, etc.), or leaded components only.

While we believe the technical information in this manual to be correct, VERTEX STANDARD assumes no liability for damage that may occur as a result of typographical or other errors that may be present. Your cooperation in pointing out any inconsistencies in the technical information would be appreciated.

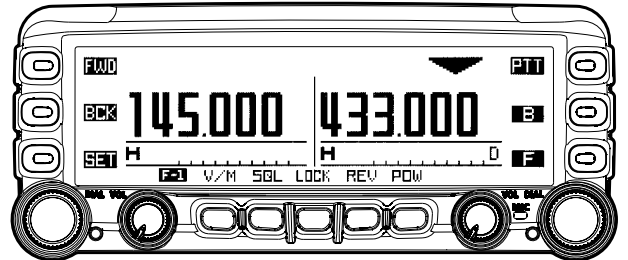

Important Note

The transceiver was assembled using Pb (lead) free solder, based on the RoHS specification. Only lead-free solder (Alloy Composition: Sn-3.0Ag-0.5Cu) should be used for repairs performed on this apparatus. The solder stated above utilizes the alloy composition required for compliance with the lead-free specification, and any solder with the above alloy composition may be used.

Contents

Specifications	2	PANEL Unit Circuit Diagram (Lot.1~)	57
Exploded View & Miscellaneous Parts	5	PANEL Unit Parts Layout (Lot.1~)	58
Block Diagram	7	PANEL Unit Circuit Diagram (Lot.12~)	59
Alignment	9	PANEL Unit Parts Layout (Lot.12~)	60
Board Unit (Schematics, Layouts & Parts)		PANEL Unit Parts List	61
MAIN Unit Circuit Diagram (Lot.1~)	17	PANEL-R Unit Circuit Diagram (Lot.1~)	67
MAIN Unit Parts Layout (Lot.1~)	19	PANEL-R Unit Parts Layout (Lot.1~)	68
MAIN Unit Circuit Diagram (Lot.5~)	21	PANEL-R Unit Circuit Diagram (Lot.6~)	69
MAIN Unit Parts Layout (Lot.5~)	23	PANEL-R Unit Parts Layout (Lot.6~)	70
MAIN Unit Parts List	25	PANEL-R Unit Circuit Diagram (Lot.12~)	71
		PANEL-R Unit Parts Layout (Lot.12~)	72
		PANEL-R Unit Parts List	73

Specifications

General

Frequency Ranges:	RX: 0.5-1.8 MHz (AM Radio) 76-108 MHz (FM Radio) 108-137 MHz (Air Band) 137-174 MHz (144 MHz HAM Band) 174-250 MHz (VHF TV Band) 300-420 MHz (General 1) 420-470 MHz (430 MHz HAM Band) 470-800 MHz (UHF TV Band) 800-1000 MHz (General 2: USA Cellular Blocked) TX: 144-146(148) MHz (Ham Band) 222-225 MHz (USA only) 430-440(450) MHz (Ham Band)
Channel Steps:	5, 6.25, 8.33, (9), 10, 12.5, 15, 20, 25, 50, 100, 200 kHz (9): AM Radio Only
Frequency Stability:	±5ppm (14 °F to +140 °F [-10 °C to +60 °C])
Repeater Shift:	±600 kHz (144 MHz) ±1.6 / 5.0 / 7.6 MHz (430 MHz)
Emission Type:	F1, F2, F3,
Antenna Impedance:	50 Ω
Supply Voltage:	Nominal: 13.8 V DC, Negative Ground Operating: 11.7 ~ 15.8 V, Negative Ground
Current Consumption:	0.5 A (Receive) 10 A (TX, 144 MHz 50W) 10 A (TX, 430 MHz 50W)
Operating Temperature:	-4 °F to +140 °F (-20 °C to +60 °C)
Case Size (WxHxD):	Panel: 6.2" x 2.6" x 1.3" (157 x 66 x 33.5 mm) w/o knob & connectors Rear Chassis: 5.5" x 1.8" x 5.9" (140 x 46 x 150 mm) w/o connectors
Weight (Approx.)	4.6 lbs (2.1 kg) Panel + Rear Chassis + Connection Cable

Transmitter

RF Power Output:	50 / 20 / 5 W
Modulation Type:	Variable Reactance F1, F2, F3
Maximum Deviation:	±5 kHz
Spurious Emission:	At least 60 dB below
Microphone Impedance:	2 kΩ

Receiver

Circuit Type:	Double-Conversion Super heterodyne (FM/AM) Triple-Conversion Super heterodyne (WFM) Single-Conversion Super heterodyne (Radio)
Intermediate Frequencies:	1st: 47.25 MHz, 2nd: 450 kHz ("Main Side" Band, FM/AM) 1st: 44.85 MHz, 2nd: 450 kHz ("Sub Side" Band, FM/AM) 1st: 45.8 MHz, 2nd: 10.7MHz, 3rd: 1MHz ("Main Side" Band, WFM) 1st: 44.0 MHz, 2nd: 10.7MHz, 3rd: 400 kHz ("Sub Side" Band, WFM) 1st: 130 kHz (FM Radio) 1st: 50 kHz (AM Radio)
Sensitivity:	5 μ V TYP for 10 dB SN (0.5-1.7 MHz, AM) 2 μ V TYP for 12 dB SINAD (76-108 MHz, WFM) 0.8 μ V TYP for 10 dB SN (108-137 MHz, AM) 0.2 μ V for 12 dB SINAD (137-140 MHz, FM) 0.2 μ V for 12 dB SINAD (140-150 MHz, FM) EXP 0.25 μ V for 12 dB SINAD (150-174 MHz, FM) 1 μ V TYP for 12 dB SINAD (174-222 MHz, WFM) 0.8 μ V TYP for 10 dB SN (300-336 MHz, AM) 0.25 μ V TYP for 12 dB SINAD (336-420 MHz, FM) 0.2 μ V for 12 dB SINAD (420-470 MHz, FM) EXP 5 μ V TYP for 12 dB SINAD (470-540 MHz, WFM) 5 μ V TYP for 12 dB SINAD (540-800 MHz, WFM) 0.4 μ V TYP for 12 dB SINAD (800 -899.99 MHz, FM) 0.8 μ V TYP for 12 dB SINAD (800 -999.99 MHz, FM)
Squelch Sensitivity:	0.16 μ V (144 / 430 MHz Band)
Selectivity (NFM, AM):	12 kHz / 30 kHz (-6 dB / -60 dB)
AF Output:	8 W @ 8 Ω for 10 % THD (@ 13.8 V) BTL EXP SP 4 W @ 4 Ω for 10 % THD (@ 13.8 V) Normal EXP SP
AF Output Impedance:	4-16 Ω

USA Version Cellular Blocked

Specifications are subject to change without notice, and are guaranteed within the 144/222/430 MHz amateur bands only.

Cellular Blocked per FCC rule Part 15.121, may not receive 900 MHz Amateur band.

Note

Exploded View & Miscellaneous Parts

No.	VXSTD P/N	Description	Qty.
①	U9900236	BIND HEAD TAPTITE-B 2.6X20SUS	4
②	U24208020	BIND HEAD TAPTITE-B 2.6X8SUS	2
③	U24206002	BIND HEAD TAPTITE-B M2.6X6NI	7
④	U51416007	HEX SOCKET HEAD BOLT M4X16B	4
⑤	U71004007	SPRING LOCK WASHER SW4B	4
⑥	U24206002	BIND HEAD TAPTITE-B M2.6X6NI	2
⑦	U24308002	BIND HEAD TAPTITE-B M3X8NI	14
⑧	U03310002	SEMS SCREW ASM3X10NI	4

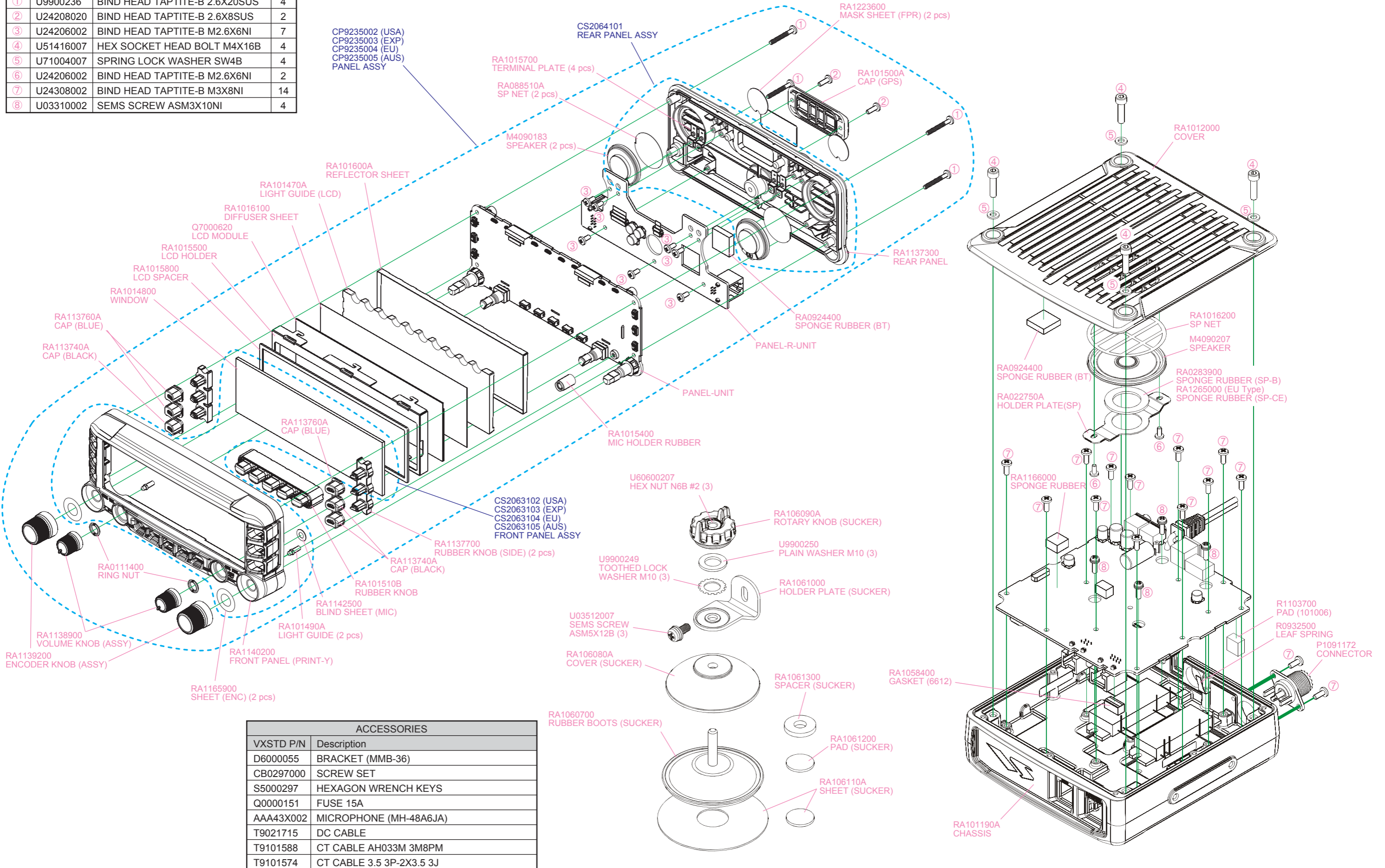

ACCESSORIES	
VXSTD P/N	Description
D6000055	BRACKET (MMB-36)
CB0297000	SCREW SET
S5000297	HEXAGON WRENCH KEYS
Q0000151	FUSE 15A
AAA43X002	MICROPHONE (MH-48A6JA)
T9021715	DC CABLE
T9101588	CT CABLE AH033M 3M8PM
T9101574	CT CABLE 3.5 3P-2X3.5 3J

Note

Block Diagram

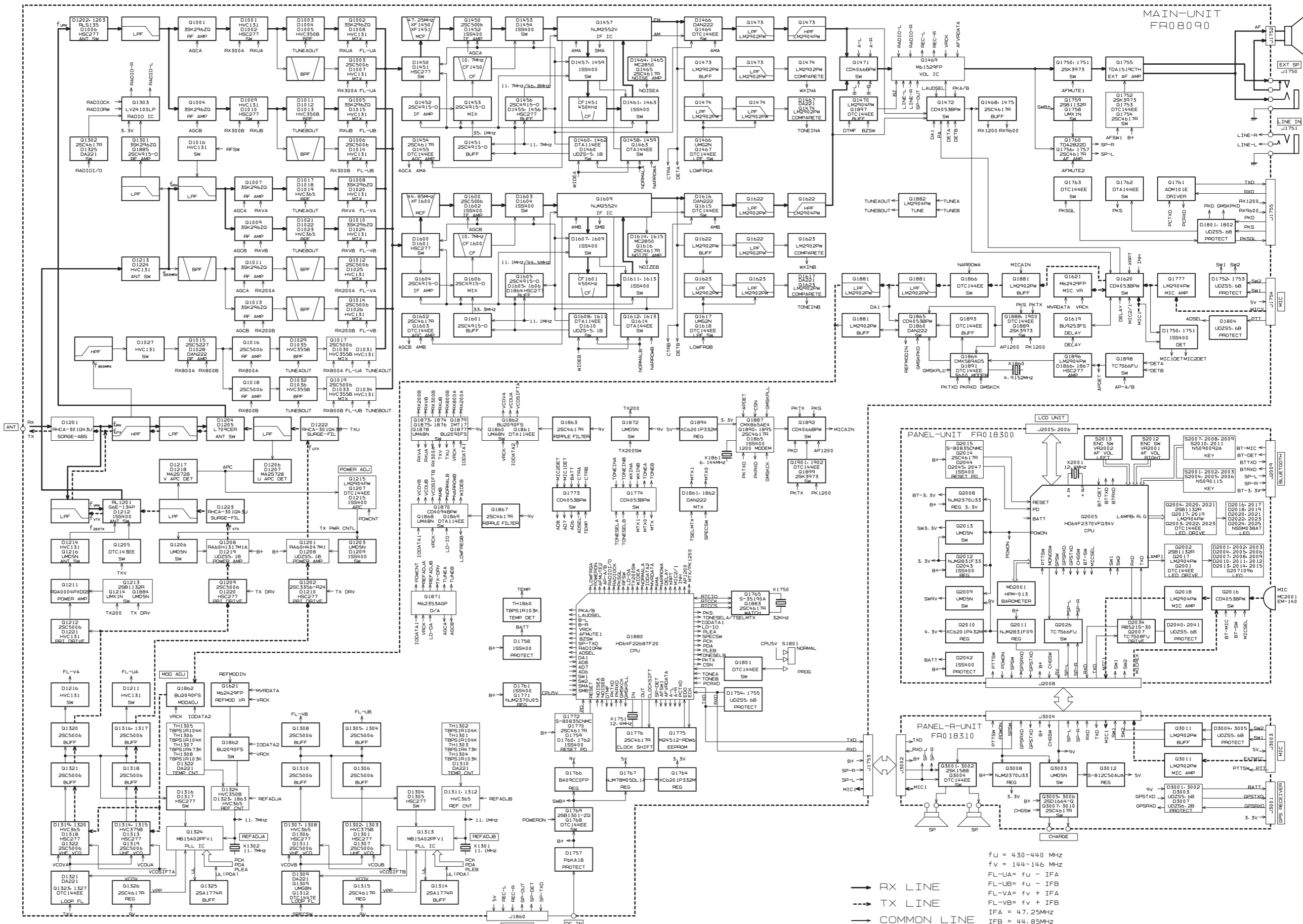

Note

Introduction

The FTM-350R/E is carefully aligned at the factory for the specified performance across the amateur band. Realignment should therefore not be necessary except in the event of a component failure. Only an authorized Vertex Standard representative should perform all component replacement and service, or the warranty policy may be void.

The following procedures cover the adjustments that are not normally required once the transceiver has left the factory. However, if damage occurs and some parts subsequently are replaced, realignment may be required. If a sudden problem occurs during normal operation, it is likely due to component failure; realignment should not be done until after the faulty component has been replaced.

We recommend that servicing be performed only by authorized Vertex Standard service technicians who are experienced with the circuitry and fully equipped for repair and alignment. If a fault is suspected, contact the dealer from whom the transceiver was purchased for instructions regarding repair. Authorized Vertex Standard service technicians realign all circuits and make complete performance checks to ensure compliance with factory specifications after replacing any faulty components.

Those who do undertake any of the following alignments are cautioned to proceed at their own risk. Problems caused by unauthorized attempts at realignment are not covered by the warranty policy. Also, Vertex Standard reserves the right to change circuits and alignment procedures in the interest of improved performance, without notifying owners.

Under no circumstances should any alignment be attempted unless the normal function and operation of the transceiver are clearly understood, the cause of the malfunction has been clearly pinpointed and any faulty components replaced, and realignment determined to be absolutely necessary.

Required Test Equipment

The following test equipment (and familiarity with its use) is necessary for complete realignment. Correction of problems caused by misalignment resulting from use of improper test equipment is not covered under the warranty policy. While most steps do not require all of the equipment listed, the interactions of some adjustments may require that more complex adjustments be performed afterwards.

Do not attempt to perform only a single step unless it is clearly isolated electrically from all other steps. Have all test equipment ready before beginning and, follow all of the steps in a section in the order presented.

- RF Signal Generator with calibrated output level at 1 GHz
- Deviation Meter (linear detector)
- In-line Wattmeter with 5% accuracy at 1 GHz
- 50-Ohm 100-W RF Dummy Load
- 4-Ohm AF Dummy Load
- Regulated DC Power Supply adjustable from 11.5 to 16 VDC, 15A
- Frequency Counter: 0.2-ppm accuracy at 1 GHz
- AF Signal Generator
- AC Voltmeter
- DC Voltmeter: high impedance
- SINAD Meter

Alignment

Alignment Preparation & Precautions

A 50-Ohm RF load and in-line wattmeter must be connected to the antenna jack in all procedures that call for transmission; alignment is not possible with an antenna. After completing one step, read the next step to see if the same test equipment is required. If not, remove the test equipment (except dummy load and wattmeter, if connected) before proceeding.

Correct alignment requires that the ambient temperature be the same as that of the transceiver and test equipment, and that this temperature be held constant between 68 °F ~ 86 °F (20 °C ~ 30 °C). When the transceiver is brought into the shop from hot or cold air, it should be allowed some time to come to room temperature before alignment. Whenever possible, alignments should be made with oscillator shields and circuit boards firmly affixed in place. Also, the test equipment must be thoroughly warmed up before beginning.

Note: Signal levels in dB referred to in the alignment procedure are based on $0\text{dB}\mu = 0.5\mu\text{V}$.

Test Setup

Set up the test equipment as shown below for transceiver alignment. Maintain the supply voltage at 13.8V DC for all steps.

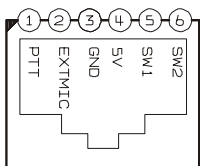
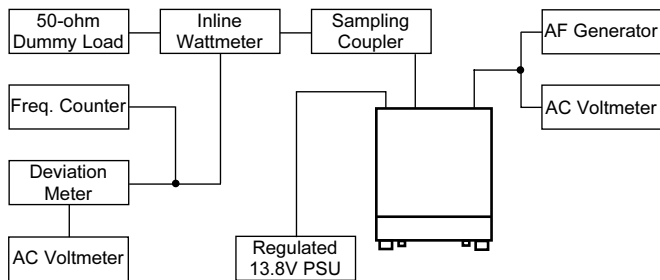

MIC Jack

Entering the Alignment Mode

Alignment of the FTM-350R/E is performed using a front panel software-based procedure. To perform alignment of the transceiver, it must first be placed in the "Alignment Mode," in which the adjustments will be made and then stored into memory.

To enter the Alignment mode:

1. Turn the radio on while pressing and holding the two keys which are located on both sides of the [POWER] switch.

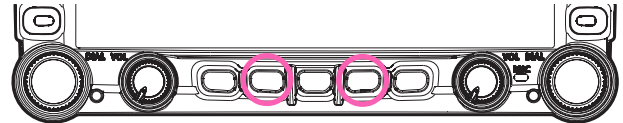

2. Press the keys on the front panel in the following sequence.

[←] ⇒ [→] ⇒ [←] ⇒ [→] ⇒ [←] ⇒ [→]

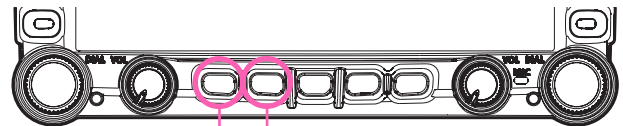

[←] [→]

3. The transceiver is now in the "Alignment Mode."

VCO VCV Adjustment

Connect the DC voltmeter to TP1302 (MAIN) and TP1301 (SUB). Referring to the table below, tune the transceiver to each frequency listed. Confirm that the correct voltage is present, or adjust the listed setting for the required voltage.

MAIN

Tune to:	TX/RX	for
440.05 MHz	RX	2.6 ± 0.25 V
440.00 MHz	TX	1.9 ± 0.25 V
146.05 MHz	RX	1.7 ± 0.25 V
146.00 MHz	TX	1.5 ± 0.25 V

SUB

Tune to:	TX/RX	for
440.05 MHz	RX	2.6 ± 0.30 V
395.05 MHz	RX	1.9 ± 0.25 V
146.05 MHz	RX	1.4 ± 0.25 V
190.05 MHz	RX	1.4 ± 0.25 V

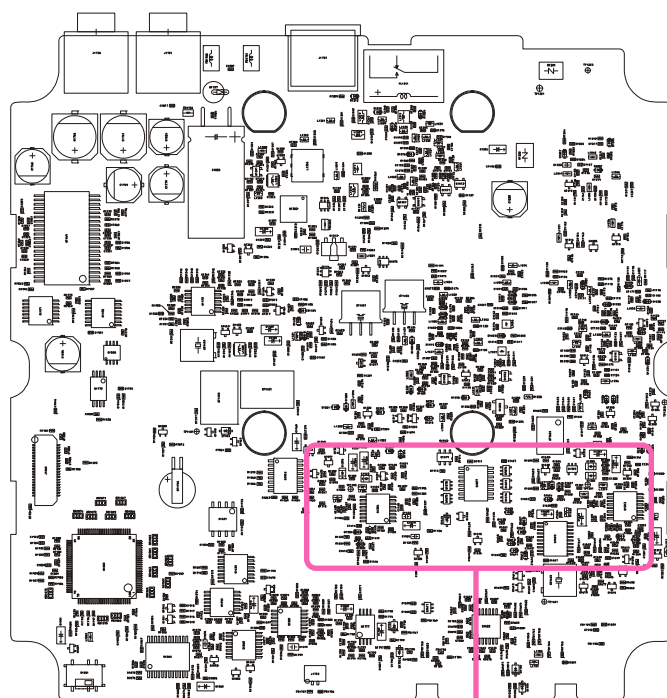

TP1302

TP1301

DC Voltmeter

1. Set the power supply voltage to 13.8 V.
2. Press the **[ADJ]** key to set the alignment Menu Item to "BAT UP".
3. Press and hold in the **[FWD]** key for one second, to save the new setting.

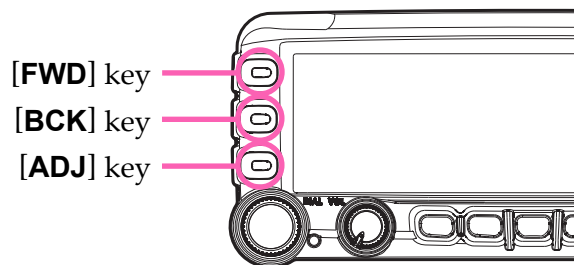

TX Power Adjustment

1. Press the **[ADJ]** key to set the alignment Menu Item to "PWR xxx".
2. Set the transceiver frequency to 440.000 MHz.
3. Press the **[POW]** key to select "LOW".
4. Press the **PTT** switch to activate the transmitter, adjust the left **DIAL** knob so that the RF Power Meter reading is 5 W (± 0.5 W).
5. Press the **[POW]** key to select "MID".
6. Press the **PTT** switch to activate the transmitter, adjust the left **DIAL** knob so that the RF Power Meter reading is 20 W (± 0.5 W).
7. Press the **[POW]** key to select "HIGH".
8. Press the **PTT** switch to activate the transmitter, adjust the left **DIAL** knob so that the RF Power Meter reading is 50 W (± 0.5 W).
9. Set the transceiver frequency to 146.000 MHz.
10. Press the **[POW]** key to select "LOW".
11. Press the **PTT** switch to activate the transmitter, adjust the left **DIAL** knob so that the RF Power Meter reading is 5 W (± 0.5 W).
12. Press the **[POW]** key to select "MID".
13. Press the **PTT** switch to activate the transmitter, adjust the left **DIAL** knob so that the RF Power Meter reading is 20 W (± 0.5 W).
14. Press the **[POW]** key to select "HIGH".
15. Press the **PTT** switch to activate the transmitter, adjust the left **DIAL** knob so that the RF Power Meter reading is 50 W (± 0.5 W).

The following steps is USA Version only.

16. Set the transceiver frequency to 223.550 MHz.
17. Press the **PTT** switch to activate the transmitter, adjust the left **DIAL** knob so that the RF Power Meter reading is 1 W (± 0.1 W).

Alignment

PLL Reference Frequency

1. Set the transceiver frequency to 440.000 MHz.
2. Press the **[POW]** key to select "LOW".
3. Press the **[ADJ]** key to set the alignment Menu Item "REFA xxx".
4. Press the **PTT** switch to activate the transmitter, adjust the left **DIAL** knob, if necessary, so the counter frequency is within 100 Hz of 440.000 MHz.
5. Press and hold in the **[ADJ]** key for one second, to set the alignment Menu Item "REFB xxx".
6. Set the transceiver frequency to 440.050 MHz.
7. Press the **[SET]** key to enter the SET mode.
8. Rotate the left **DIAL** knob to select Menu Item "TX/RX".
9. Press the left **DIAL** knob, then rotate the left **DIAL** knob to select "B08 WIDE/NARROW AUTO".
10. Press the left **DIAL** knob, then rotate the left **DIAL** knob to select "AUTO (FM)".
11. Press the **[ESC]** key repeatedly, to save the new setting.
12. Connect the frequency counter fed through the 0.001 μ F capacitor to the TP1303.
13. Adjust the left **DIAL** knob, as needed, so that the counter frequency reading is 395.200 MHz (\pm 100 Hz).

RF Front-end Tuning

1. Connect the DC voltmeter to TP1401 (MAIN) and TP1601 (SUB) on the MAIN unit, then inject a 439.050 MHz signal at a level of +10 dB μ V (with 1 kHz modulation \pm 3.5 kHz deviation) from the RF signal generator.
2. Set the transceiver frequency to 439.050 MHz.
3. Press the **[ADJ]** key to set the alignment Menu Item "TUNA xxx".
4. Adjust the left **DIAL** knob for maximum deflection on the DC Voltmeter and then turn the dial in the opposite direction until the meter deflection drops slightly lower than maximum.
5. Set the transceiver and RF signal generator frequency to 145.050 MHz.
6. Adjust the left **DIAL** knob for maximum deflection on the DC Voltmeter and then turn the dial in the opposite direction until the meter deflection drops slightly lower than maximum.
7. Set the RF signal generator frequency to 439.050 MHz.

8. Set the transceiver frequency to 439.050 MHz of the **SUB** Band.
9. Press and hold in the **[ADJ]** key to set the alignment Menu Item "TUNB xxx".
10. Adjust the left **DIAL** knob for maximum deflection on the DC Voltmeter and then turn the dial in the opposite direction until the meter deflection drops slightly lower than maximum.
11. Set the transceiver and RF signal generator frequency to 145.050 MHz.
12. Adjust the left **DIAL** knob for maximum deflection on the DC Voltmeter and then turn the dial in the opposite direction until the meter deflection drops slightly lower than maximum.

Squelch Threshold Level

1. Set the RF signal generator to 440.050 MHz. Set the generator for \pm 3.5 kHz deviation of a 1 kHz modulation tone, and set the RF output level from the signal generator to -12 dB μ V.
2. Set the transceiver frequency to 440.050 MHz.
3. Press the **[SET]** key to enter the SET mode.
4. Rotate the left **DIAL** knob to select Menu Item "TX/RX".
5. Press the left **DIAL** knob, then rotate the left **DIAL** knob to select "B08 WIDE/NARROW AUTO".
6. Press the left **DIAL** knob, then rotate the left **DIAL** knob to select "AUTO (FM)".
7. Press the **[ESC]** key repeatedly, to save the new setting and exit the Menu mode.
8. Press the **[ADJ]** key to set the alignment Menu Item "SQLA U D".
9. Press the **[BCK]** key to save the new setting.
10. Increase the output level of the signal generator up to -4 dB μ V.
11. Press the **[FWD]** key to save the new setting.
12. Set the transceiver and RF signal generator frequency to 146.050 MHz.
13. Increase the output level of the signal generator up to -12 dB μ V.
14. Press the **[ADJ]** key to set the alignment Menu Item "SQLA U D".
15. Press the **[BCK]** key to save the new setting.
16. Increase the output level of the signal generator up to -4 dB μ V.
17. Press the **[FWD]** key to save the new setting.

18. To change the mode to "WIDE FM", just repeat steps 3 through 7 above, rotating the left **DIAL** knob to select "WIDE FM" in step 6 above.
19. Set the RF signal generator to 440.050 MHz. Set the generator for ± 22.5 kHz deviation of a 1 kHz modulation tone, and set the RF output level from the signal generator to -1 dB μ V.
20. Set the transceiver frequency to 440.050 MHz.
21. Press the **[ADJ]** key to set the alignment Menu Item "SQLA U D".
22. Press the **[BCK]** key to save the new setting.
23. Increase the output level of the signal generator up to $+7$ dB μ V.
24. Press the **[FWD]** key to save the new setting.
25. Set the transceiver and RF signal generator frequency to 146.050 MHz.
26. Increase the output level of the signal generator up to -1 dB μ V.
27. Press the **[ADJ]** key to set the alignment Menu Item "SQLA U D".
28. Press the **[BCK]** key to save the new setting.
29. Increase the output level of the signal generator up to $+7$ dB μ V.
30. Press the **[FWD]** key to save the new setting.
31. Press and hold in the **[ADJ]** key for one second, to set the alignment Menu Item "SQLB U D".
32. Just repeat all steps above, in "SUB BAND".

S-Meter Calibration

1. Set the RF signal generator to 440.050 MHz. Set the generator for ± 3.5 kHz (± 22.5 kHz for Wide FM) deviation of a 1 kHz modulation tone, and set the RF output level from the signal generator to -5 dB μ V.
2. Set the transceiver frequency to 440.050 MHz.
3. Press the **[SET]** key to enter the SET mode.
4. Rotate the left **DIAL** knob to select Menu Item "TX/RX".
5. Press the left **DIAL** knob, then rotate the left **DIAL** knob to select "B08 WIDE/NARROW AUTO".
6. Press the left **DIAL** knob, then rotate the left **DIAL** knob to select "AUTO (FM)".
7. Press the **[ESC]** key repeatedly, to save the new setting and exit the Menu mode.
8. Press the **[ADJ]** key to set the alignment Menu Item "SMA U D".
9. Press the **[BCK]** key to save the new setting.
10. Increase the output level of the signal generator up to $+23$ dB μ V.
11. Press the **[FWD]** key to save the new setting.
12. To change the mode to "WIDE FM", just repeat steps 3 through 7 above, rotating the left **DIAL** knob to select "WIDE FM" in step 6 above.
13. Increase the output level of the signal generator up to 0 dB μ V.
14. Press the **[BCK]** key to save the new setting.
15. Increase the output level of the signal generator up to $+23$ dB μ V.
16. Press the **[FWD]** key to save the new setting.
17. To change the mode to "FM", just repeat steps 3 through 7 above, rotating the left **DIAL** knob to select "FM" in step 6 above.
18. Set the transceiver and RF signal generator frequency to 146.050 MHz.
19. Increase the output level of the signal generator up to -5 dB μ V.
20. Press the **[BCK]** key to save the new setting.
21. Increase the output level of the signal generator up to $+23$ dB μ V.
22. Press the **[FWD]** key to save the new setting.
23. To change the mode to "WIDE FM", just repeat steps 3 through 7 above, rotating the left **DIAL** knob to select "WIDE FM" in step 6 above.
24. Increase the output level of the signal generator up to 0 dB μ V.
25. Press the **[BCK]** key to save the new setting.

Alignment

26. Increase the output level of the signal generator up to +23 dB μ V.
27. Press the **[FWD]** key to save the new setting.
28. Press and hold in the **[ADJ]** key for one second, to set the alignment Menu Item "**SMB U D**".
29. Just repeat all steps above, in "SUB BAND".

TX Deviation

1. Inject a 1 kHz, 80 mV signal from the Audio Generator.
2. Set the transceiver frequency to 440.050 MHz.
3. Press the **[POW]** key to select "LOW".
4. Press the **[ADJ]** key to set the alignment Menu Item "**DEV xxx**".
5. Press the **PTT** switch to activate the transmitter, adjust the left **DIAL** knob so that the Deviation Meter reading is 4.5 kHz (± 0.2 kHz) (USA Version: 4.2 kHz (± 0.2 kHz)).
6. Set the transceiver frequency to 146.050 MHz.
7. Press the **PTT** switch to activate the transmitter, adjust the left **DIAL** knob so that the Deviation Meter reading is 4.5 kHz (± 0.2 kHz) (USA Version: 4.2 kHz (± 0.2 kHz)).

The following steps is USA Version only.

8. Set the transceiver frequency to 223.550 MHz.
9. Press the **PTT** switch to activate the transmitter, adjust the left **DIAL** knob so that the Deviation Meter reading is 4.2 kHz (± 0.2 kHz).

CTCSS TX Deviation

1. Set the transceiver frequency to 440.050 MHz.
2. Press the **[POW]** key to select "LOW".
3. Press and hold in the **[F]** key for two seconds to change the **[SMART FUNCTION]** key category to the "**SQL**" functions.
4. Press the **[TYPE]** key repeatedly, until the "**TONE ENC**" notation appears.
5. Press the **[TFRQ]** key, then rotate the right **DIAL** knob to select "100.0 Hz".
6. Press the **[ESC]** key to save the new setting.
7. Press the **[ADJ]** key to set the alignment Menu Item "**MOD xxx**".
8. Rotate the left **DIAL** knob to select "**MOD 10EH**".
9. Press the **[ADJ]** key to set the alignment Menu Item "**CTC xxx**".
10. Press the **PTT** switch to activate the transmitter, adjust the left **DIAL** knob so that the Deviation Meter reading is 0.65 kHz ~ 0.75 kHz.
11. Set the transceiver frequency to 146.050 MHz.
12. Press the **[POW]** key to select "LOW".
13. Press and hold in the **[F]** key for two seconds to change the **[SMART FUNCTION]** key category to the "**SQL**" functions.
14. Press the **[TYPE]** key repeatedly, until the "**TONE ENC**" notation appears.

15. Press the [**TFRQ**] key, then rotate the right **DIAL** knob to select "100.0 Hz".
16. Press the [**ESC**] key to save the new setting.
17. Press the [**ADJ**] key to set the alignment Menu Item "**MOD xxx**".
18. Rotate the left **DIAL** knob to select "**MOD 136H**".
19. Press the [**ADJ**] key to set the alignment Menu Item "**CTC xxx**".
20. Press the **PTT** switch to activate the transmitter, adjust the left **DIAL** knob so that the Deviation Meter reading is 0.65 kHz ~ 0.75 kHz.

The following steps is USA Version only.

21. Set the transceiver frequency to 223.550 MHz.
22. Press and hold in the [**F**] key for two seconds to change the [**SMART FUNCTION**] key category to the "**SQL**" functions.
23. Press the [**TYPE**] key repeatedly, until the "**STONE ENC**" notation appears.
24. Press the [**TFRQ**] key, then rotate the right **DIAL** knob to select "100.0 Hz".
25. Press the [**ESC**] key to save the new setting.
26. Press the [**ADJ**] key to set the alignment Menu Item "**MOD xxx**".
27. Rotate the left **DIAL** knob to select "**MOD 126H**".
28. Press the [**ADJ**] key to set the alignment Menu Item "**CTC xxx**".
29. Press the **PTT** switch to activate the transmitter, adjust the left **DIAL** knob so that the Deviation Meter reading is 0.65 kHz ~ 0.75 kHz.

DCS TX Deviation

1. Set the transceiver frequency to 440.050 MHz.
2. Press the [**POW**] key to select "LOW".
3. Press and hold in the [**F**] key for two seconds to change the [**SMART FUNCTION**] key category to the "**SQL**" functions.
4. Press the [**TYPE**] key repeatedly, until the "**DCS**" notation appears.
5. Press the [**ESC**] key to save the new setting.
6. Press the [**ADJ**] key to set the alignment Menu Item "**MOD xxx**".
7. Rotate the left **DIAL** knob to select "**MOD 10EH**".
8. Press the [**ADJ**] key to set the alignment Menu Item "**DCS xxx**".
9. Press the **PTT** switch to activate the transmitter, adjust the left **DIAL** knob so that the Deviation Meter reading is 0.60 kHz ~ 0.80 kHz.
10. Set the transceiver frequency to 146.050 MHz.
11. Press the [**POW**] key to select "LOW".
12. Press and hold in the [**F**] key for two seconds to change the [**SMART FUNCTION**] key category to the "**SQL**" functions.
13. Press the [**TYPE**] key repeatedly, until the "**DCS**" notation appears.
14. Press the [**ESC**] key to save the new setting.
15. Press the [**ADJ**] key to set the alignment Menu Item "**MOD xxx**".
16. Rotate the left **DIAL** knob to select "**MOD 136H**".
17. Press the [**ADJ**] key to set the alignment Menu Item "**DCS xxx**".
18. Press the **PTT** switch to activate the transmitter, adjust the left **DIAL** knob so that the Deviation Meter reading is 0.60 kHz ~ 0.80 kHz.

The following steps is USA Version only.

19. Set the transceiver frequency to 223.550 MHz.
20. Press and hold in the [**F**] key for two seconds to change the [**SMART FUNCTION**] key category to the "**SQL**" functions.
21. Press the [**TYPE**] key repeatedly, until the "**DCS**" notation appears.
22. Press the [**ESC**] key to save the new setting.
23. Press the [**ADJ**] key to set the alignment Menu Item "**MOD xxx**".
24. Rotate the left **DIAL** knob to select "**MOD 126H**".
25. Press the [**ADJ**] key to set the alignment Menu Item "**DCS xxx**".

Alignment

26. Press the **PTT** switch to activate the transmitter, adjust the left **DIAL** knob so that the Deviation Meter reading is 0.60 kHz ~ 0.80 kHz.

Center Meter Calibration

1. Set the RF signal generator to 440.050 MHz. Set the generator for ± 3.5 kHz (Narrow FM) or ± 22.5 kHz (Wide FM) deviation of a 1 kHz modulation tone, and set the RF output level from the signal generator to +10 dB μ V.
2. Set the transceiver frequency to 440.050 MHz.
3. Press the [**SET**] key to enter the SET mode.
4. Rotate the left **DIAL** knob to select Menu Item "TX/RX".
5. Press the left **DIAL** knob, then rotate the left **DIAL** knob to select "B08 WIDE/NARROW AUTO".
6. Press the left **DIAL** knob, then rotate the left **DIAL** knob to select "AUTO (FM)".
7. Press the [**ESC**] key repeatedly, to save the new setting and exit the Menu mode.
8. Press the [**ADJ**] key to set the alignment Menu Item "**CTRA UP**".
9. Press the [**FWD**] key to save the new setting.
10. To change the mode to "NAR FM", just repeat steps 3 through 7 above, rotating the left **DIAL** knob to select "NAR FM" in step 6 above.
11. Press the [**FWD**] key to save the new setting.
12. To change the mode to "WIDE FM", just repeat steps 3 through 7 above, rotating the left **DIAL** knob to select "WIDE FM" in step 6 above.
13. Press the [**ADJ**] key to save the new setting.
14. Press and hold in the [**ADJ**] key for one second, to set the alignment Menu Item "**CTRB UP**".
15. Just repeat all steps above, in "SUB BAND".

VOX Alignment

1. Press the [**ADJ**] key to set the alignment Menu Item "**VOX UP**".
2. Press the [**FWD**] key to save the new setting.

To close the alignment mode, just turn the power off by pressing and holding the [**POWER**] switch for two seconds. The next time the transceiver is turned on, normal operation will resume.

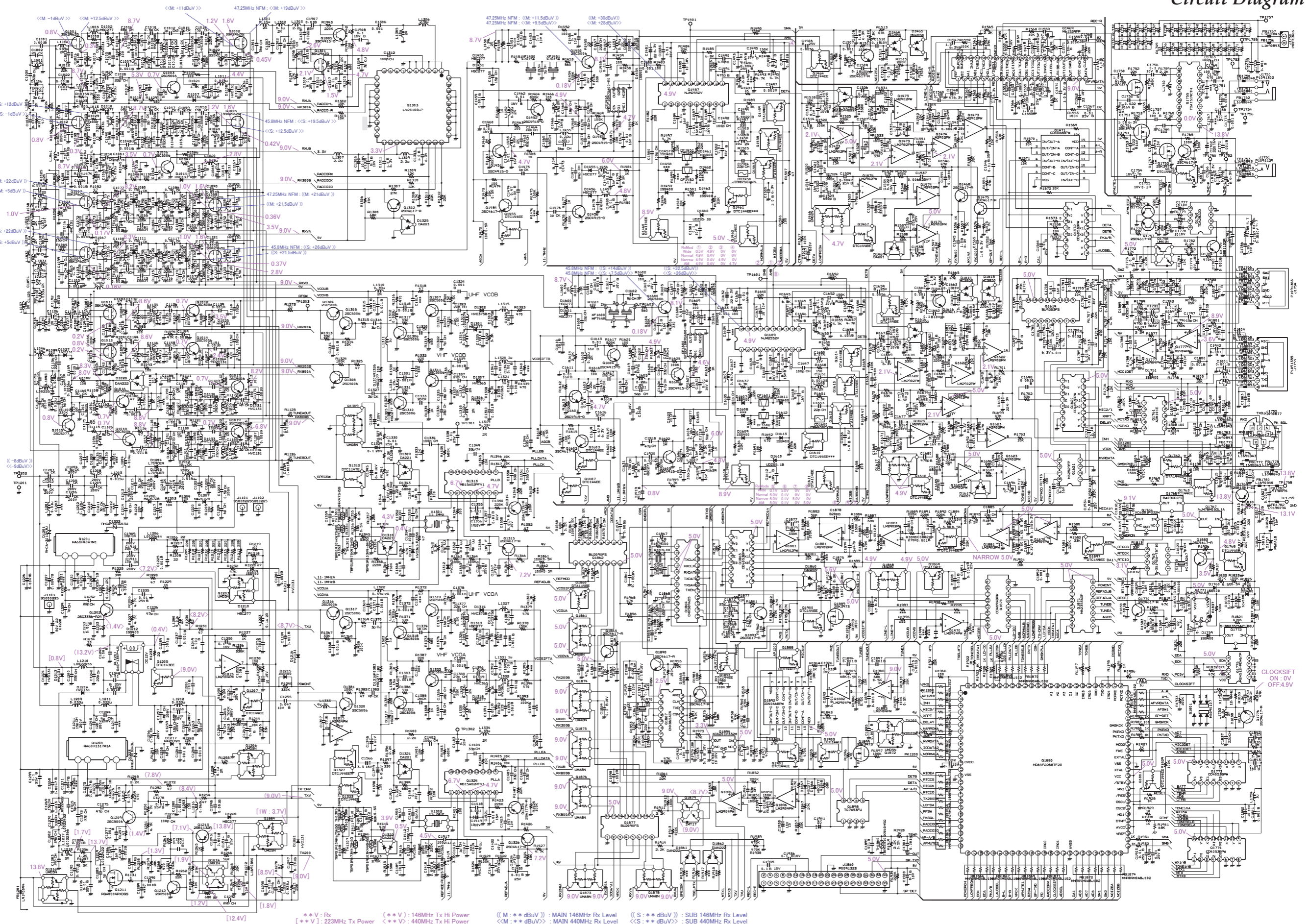

MAIN Unit (Lot. 1~4)

Note

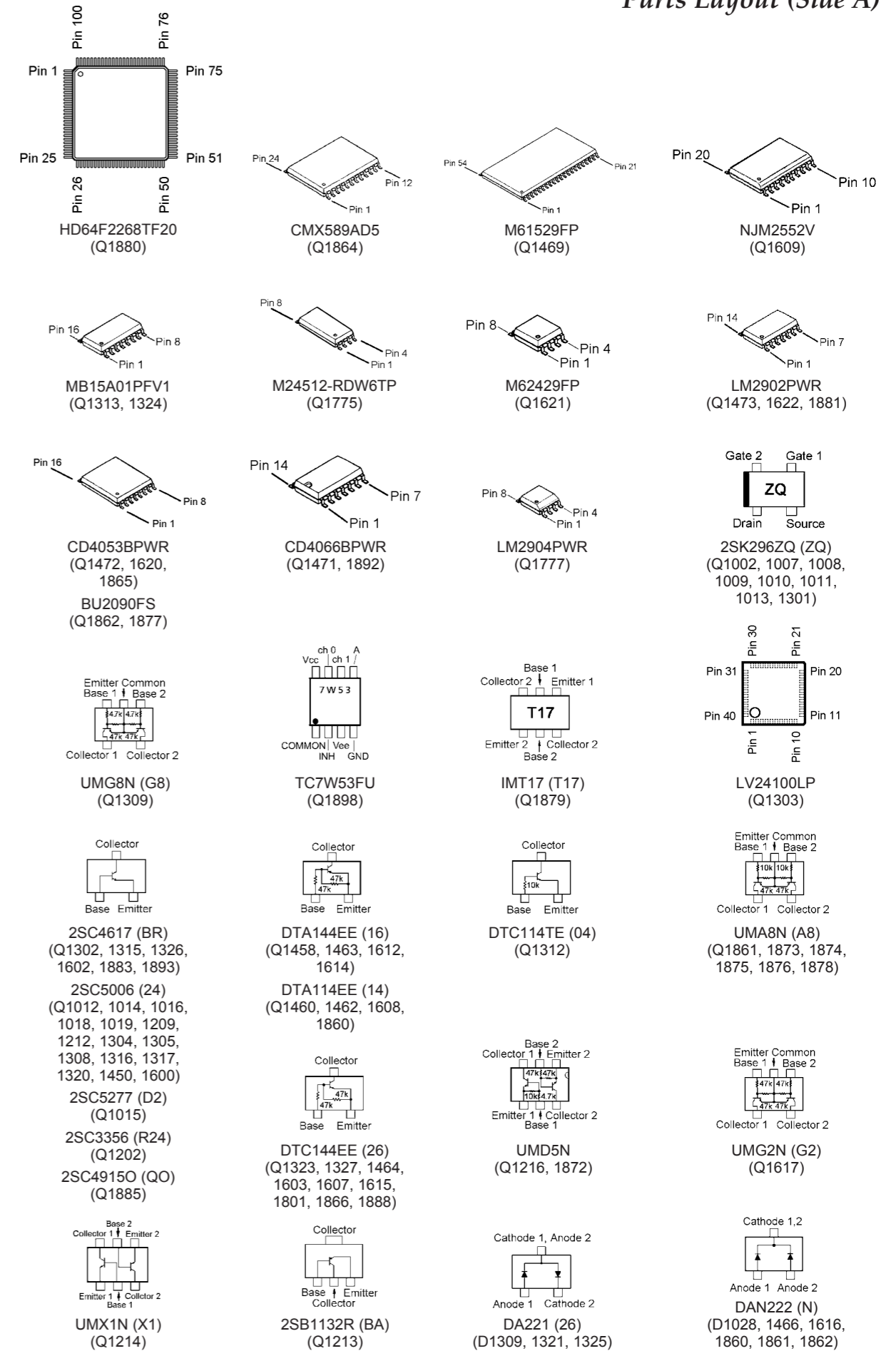
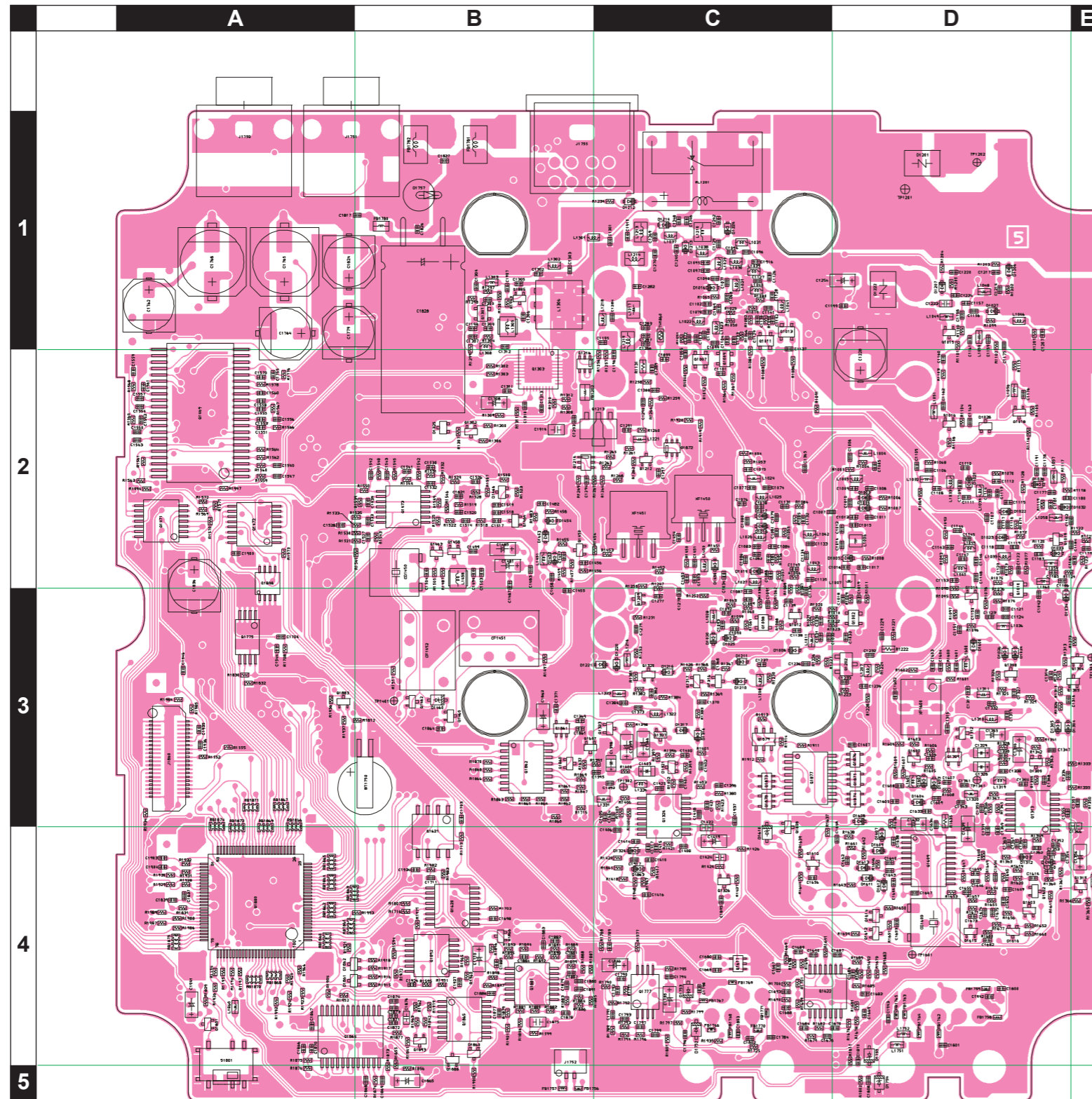

MAIN Unit (Lot. 1~4)

Parts Layout (Side B)

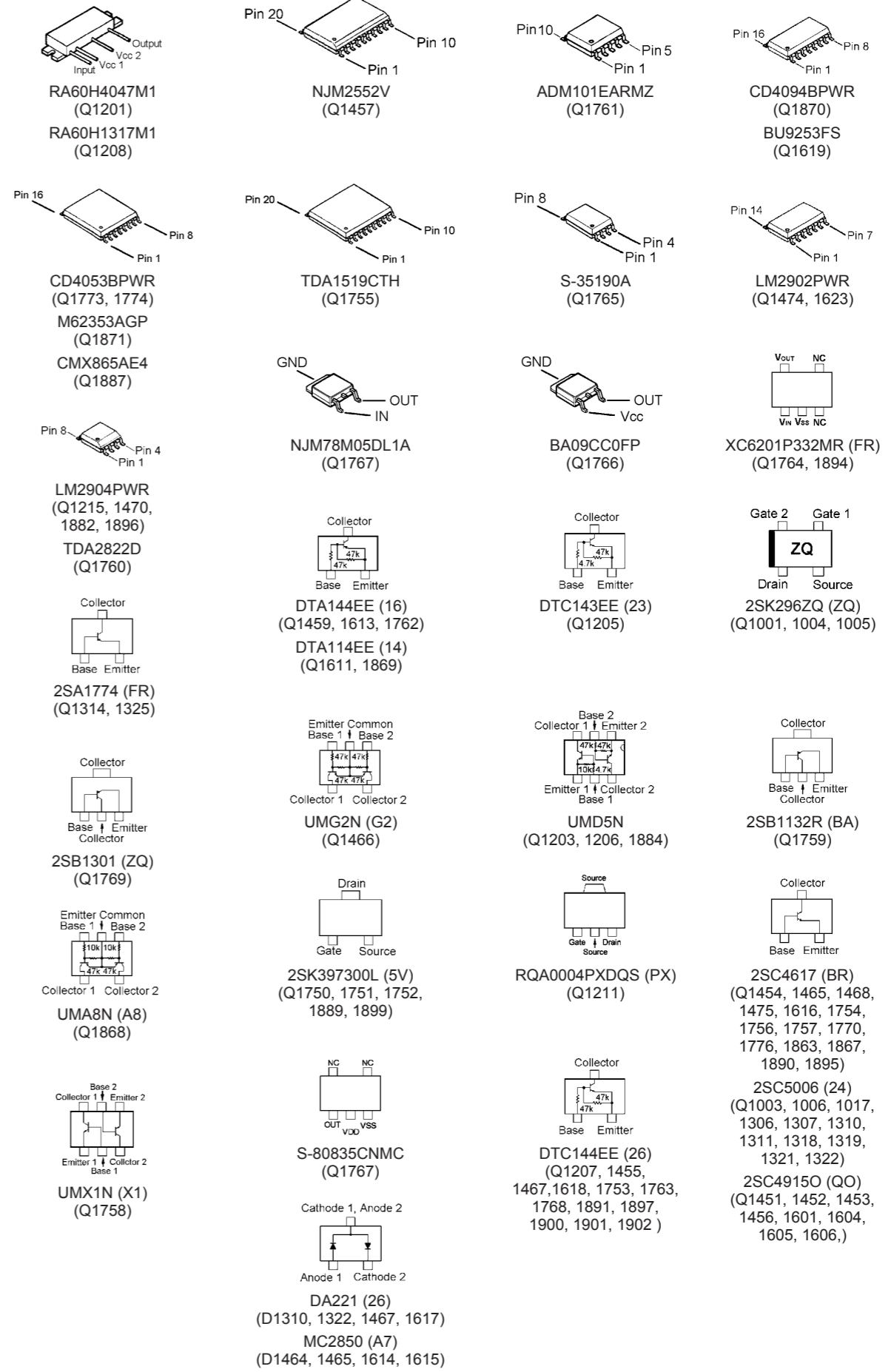
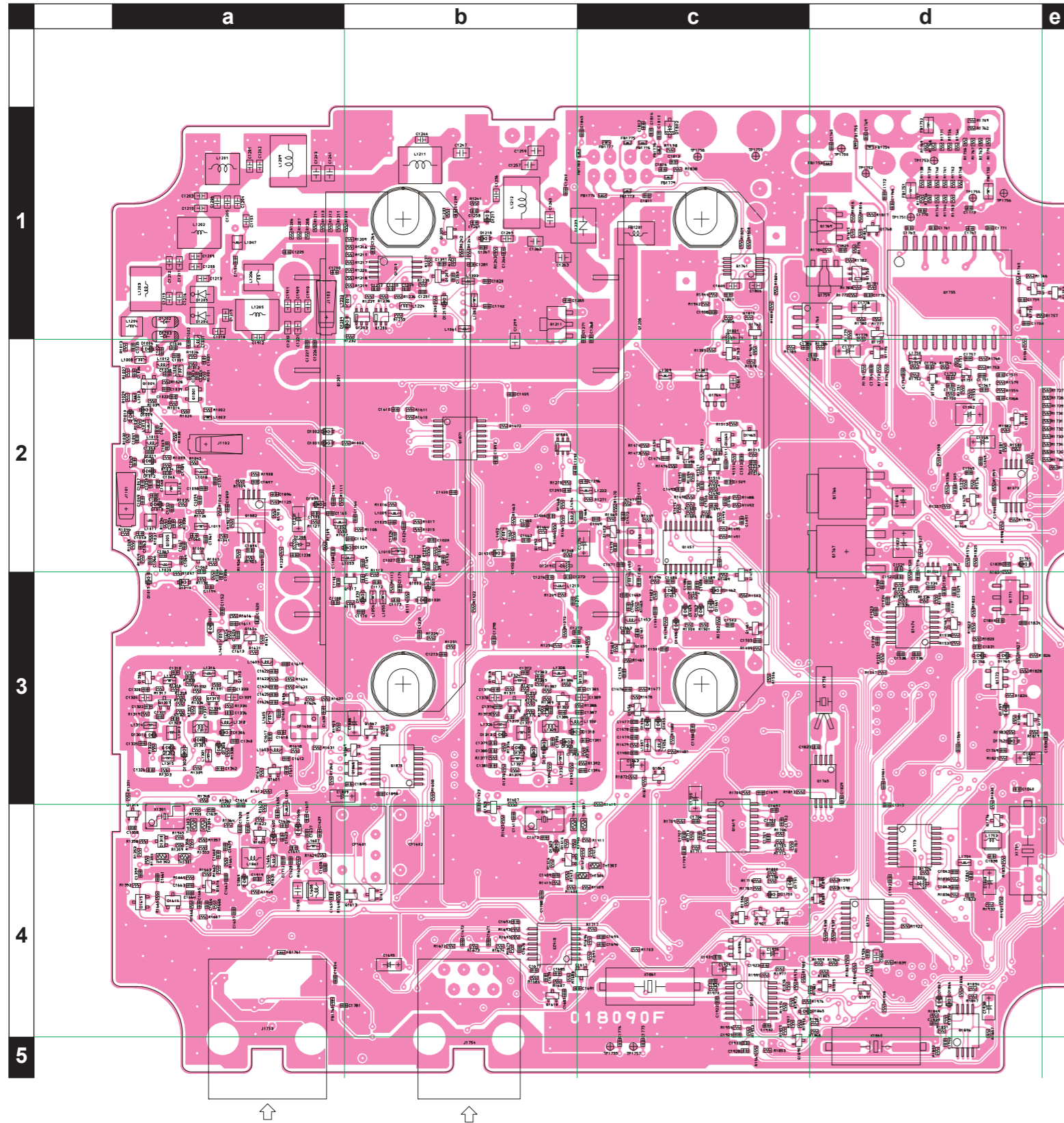

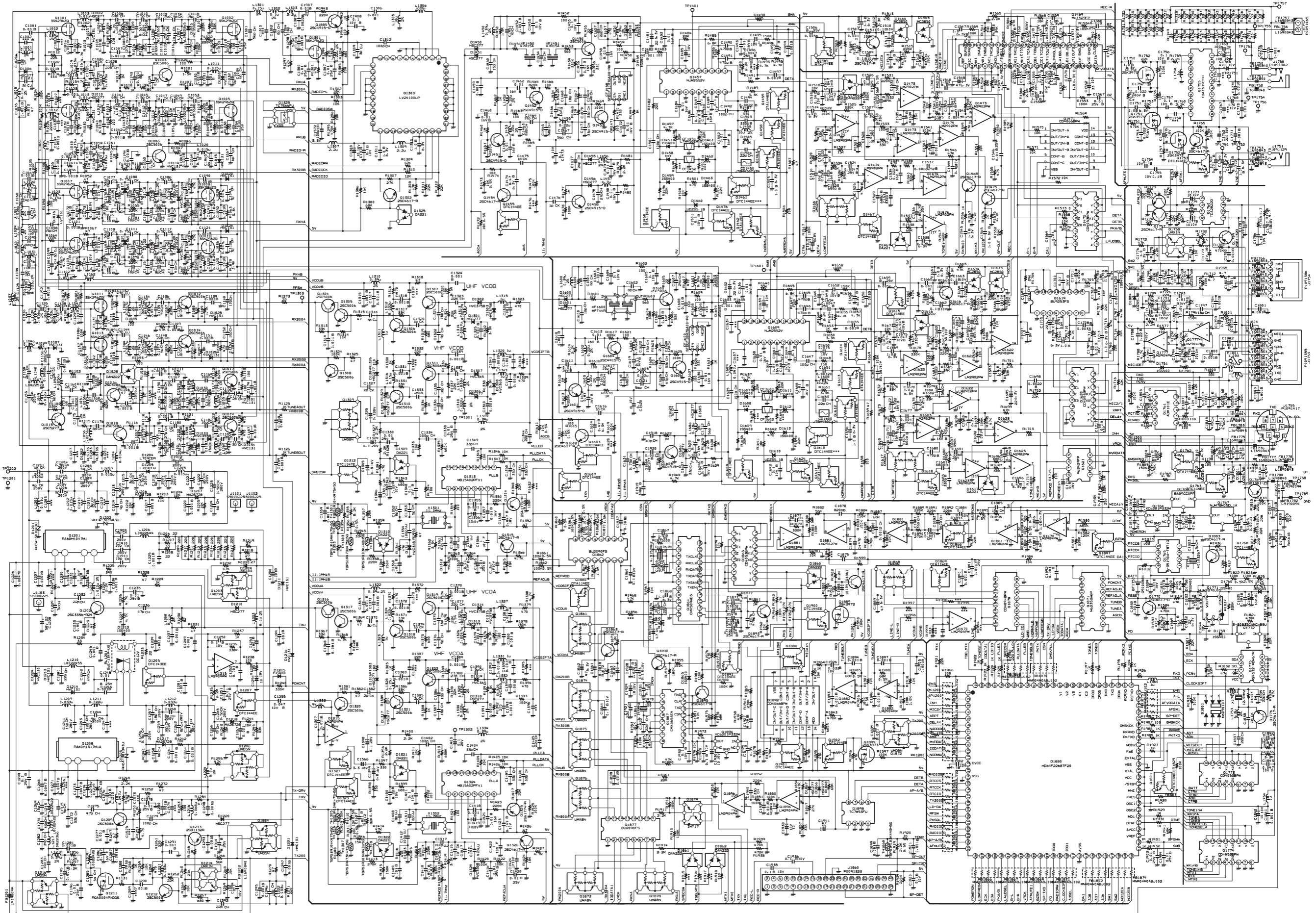

MAIN Unit (Lot. 5~)

Note

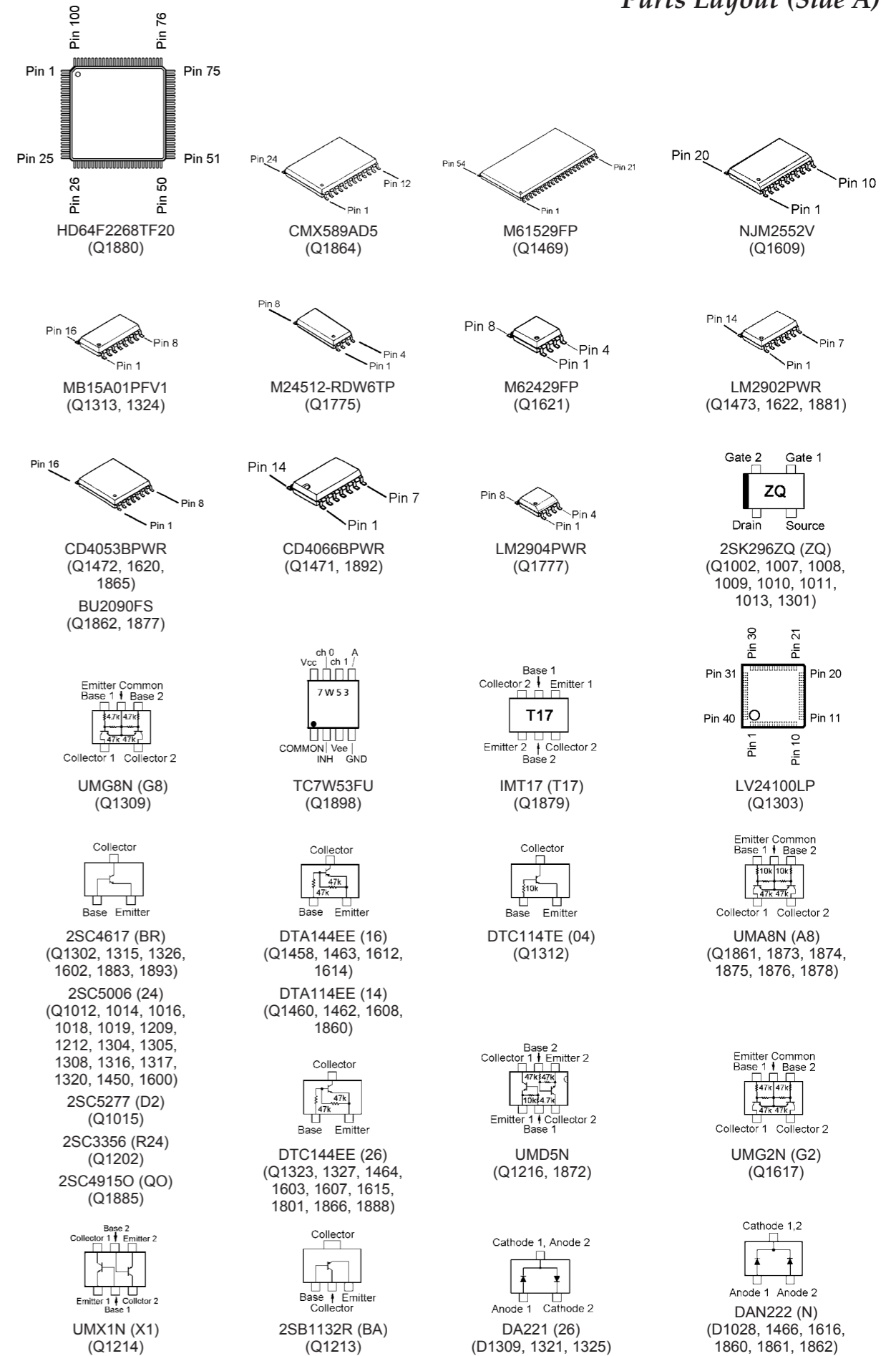
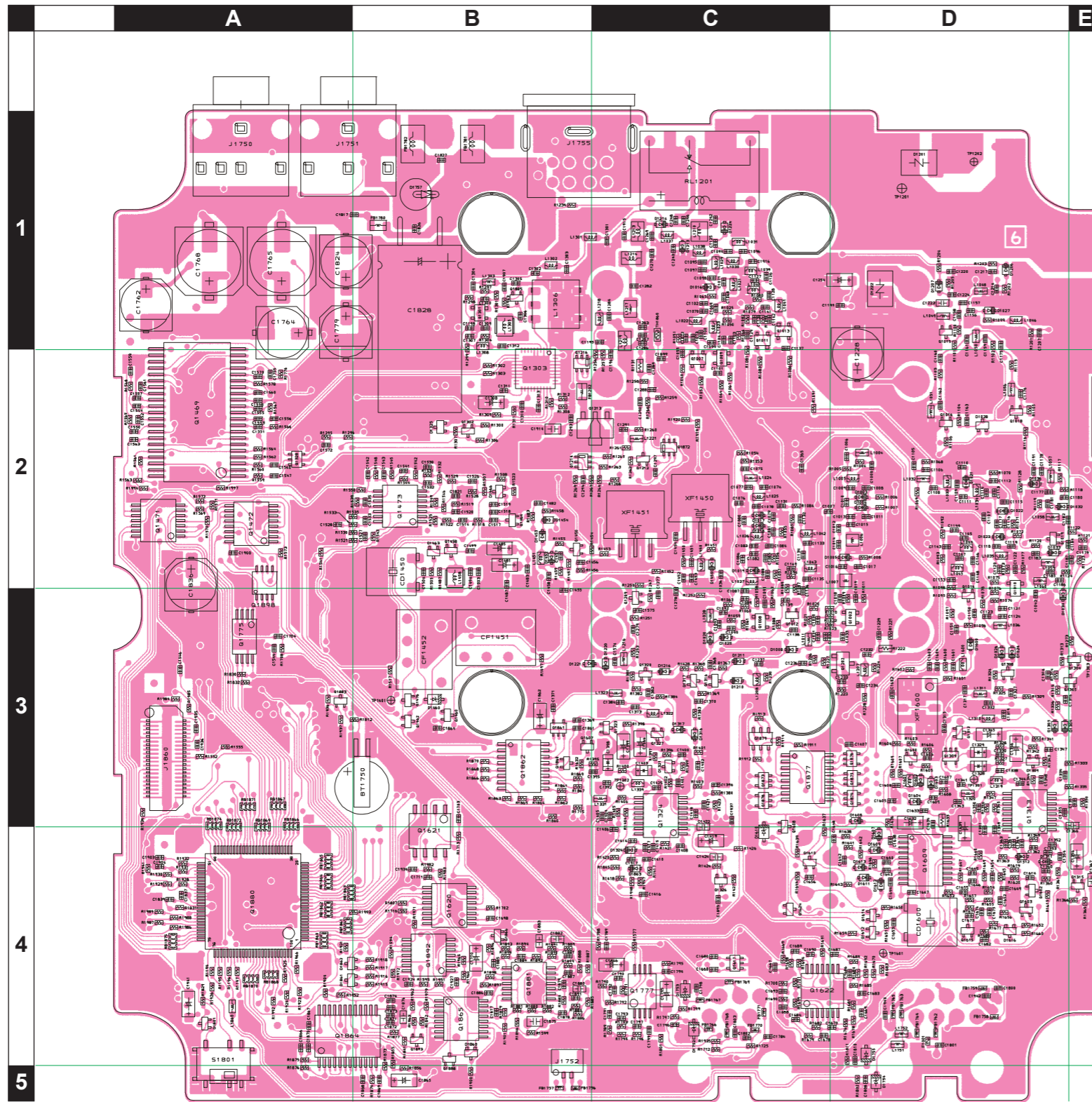

MAIN Unit (Lot. 5~)

Parts Layout (Side B)

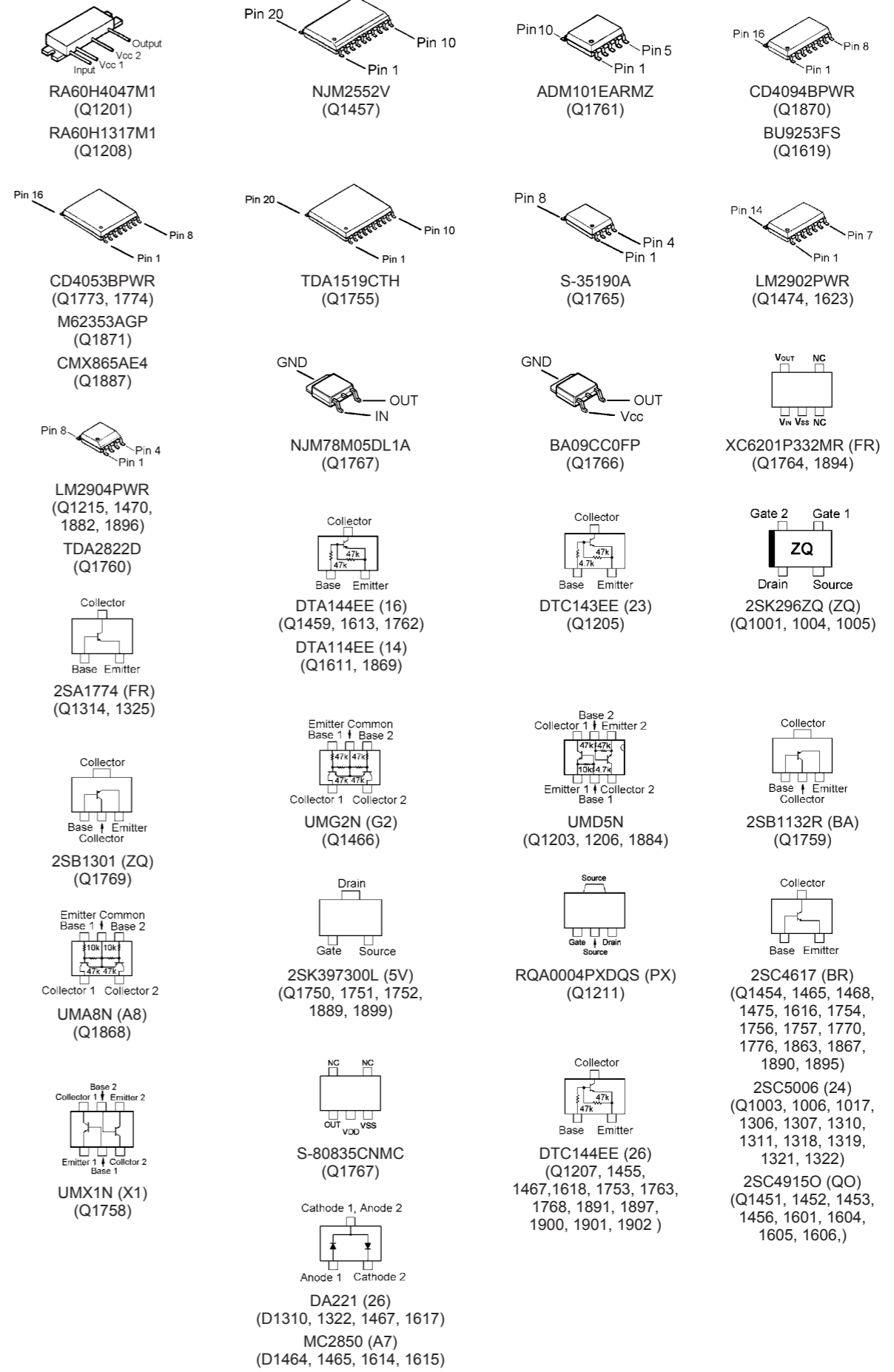
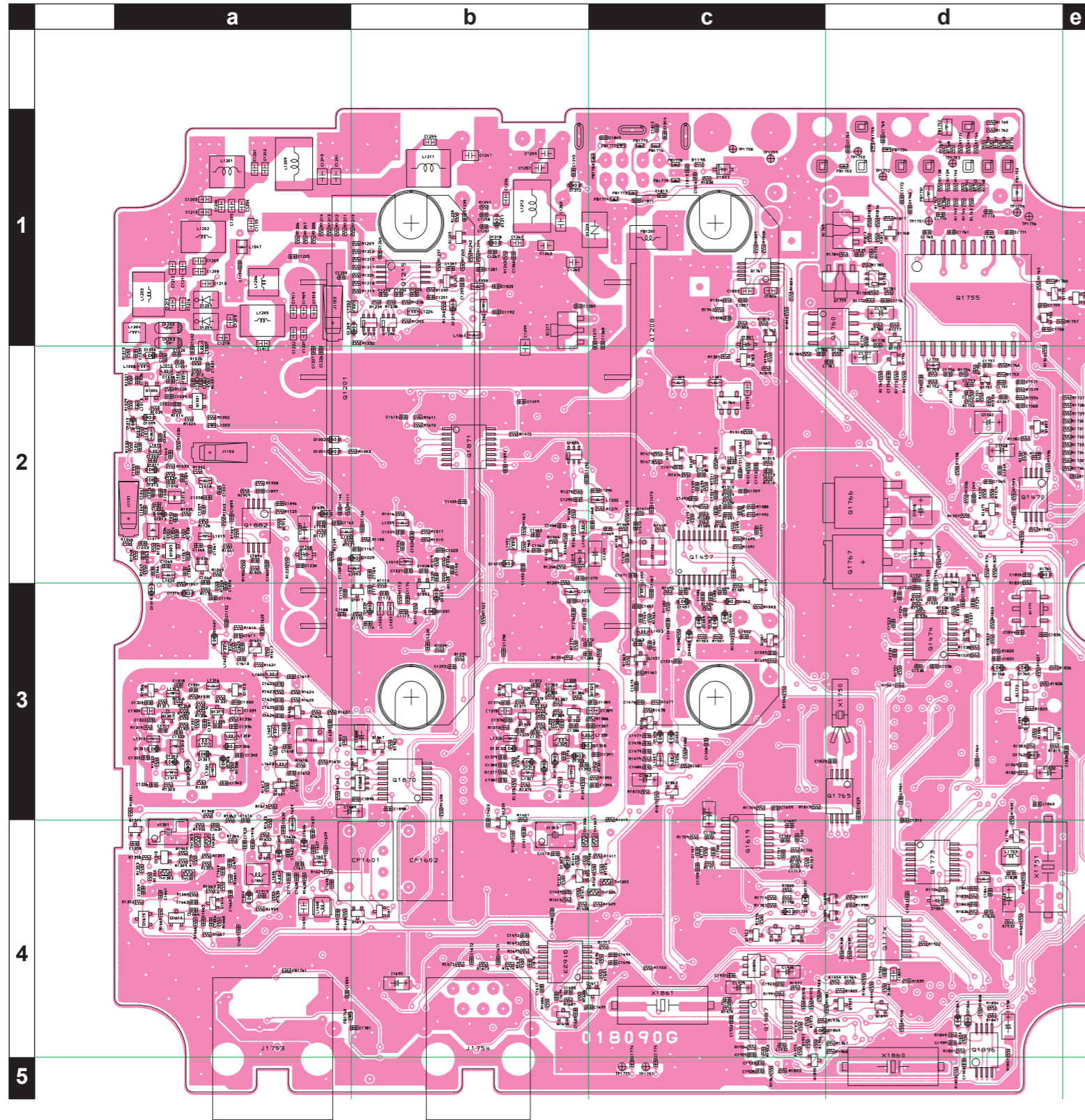

REF	DESCRIPTION	VALUE	V/W	TOL.	MFR'S DESIG	VXSTD P/N	VERS.	LOT	SIDE	LAY ADR
PCB with Components						CS2062701	DST:USA, TYP:A2U			
						CS2062704	DST:EXP, TYP:A1			
						CS2062705	DST:EXP, TYP:A2			
						CS2062706	DST:EXP, TYP:A3			
						CS2062707	DST:EU, TYP:B1			
						CS2062708	DST:EU, TYP:B2			
						CS2062709	DST:EXP, TYP:B3			
						CS2062710	DST:EU, TYP:C1			
						CS2062711	DST:EU, TYP:C2			
						CS2062712	DST:EXP, TYP:C3			
						CS2062713	DST:EU, TYP:D1			
						CS2062714	DST:EU, TYP:D2			
						CS2062715	DST:AUS, TYP:H1			
						CS2062716	DST:AUS, TYP:H2			
Printed Circuit Board						FR018090F		1-4		
						FR018090G	W/ CE LABEL	5-8		
						FR018090F	W/O CE LABEL	5-8		
						FR018090G		9-		
BT1750	LI-ION BATTERY				MS614SE FL28E	Q9000884			A	B3
C 1001	CHIP CAP.	0.001uF	50V	B	GRM155B11H102KA01D	K22178809		1-	B	a2
C 1002	CHIP CAP.	2pF	50V	CK	GRM1554C1H2R0BZ01D	K22178289	USA	1-	B	a2
C 1004	CHIP CAP.	0.001uF	50V	B	GRM155B11H102KA01D	K22178809		1-	B	a2
C 1005	CHIP CAP.	0.001uF	50V	B	GRM155B11H102KA01D	K22178809		1-	A	D2
C 1006	CHIP CAP.	68pF	50V	CH	GRM1552C1H680JZ01D	K22178232		1-	A	D2
C 1007	CHIP CAP.	0.001uF	50V	B	GRM155B11H102KA01D	K22178809		1-	A	C2
C 1008	CHIP CAP.	27pF	50V	CH	GRM1552C1H270JZ01D	K22178222		1-	A	D2
C 1009	CHIP CAP.	0.5pF	50V	CK	GRM1554C1HR50BZ01D	K22178285		1-	A	D2
C 1010	CHIP CAP.	0.5pF	50V	CK	GRM1554C1HR50BZ01D	K22178285		1-	A	D2
C 1011	CHIP CAP.	27pF	50V	CH	GRM1552C1H270JZ01D	K22178222		1-	A	D2
C 1012	CHIP CAP.	1pF	50V	CK	GRM1554C1H1R0BZ01D	K22178287		1-	A	D2
C 1013	CHIP CAP.	0.75pF	50V	CK	GRM1554C1HR75BZ01D	K22178286		1-	A	D2
C 1014	CHIP CAP.	0.5pF	50V	CK	GRM1554C1HR50BZ01D	K22178285		1-	A	D2
C 1015	CHIP CAP.	1pF	50V	CK	GRM1554C1H1R0BZ01D	K22178287		1-	A	D2
C 1016	CHIP CAP.	1pF	50V	CK	GRM1554C1H1R0BZ01D	K22178287		1-	A	D2
C 1017	CHIP CAP.	27pF	50V	CH	GRM1552C1H270JZ01D	K22178222		1-	A	D2
C 1018	CHIP CAP.	15pF	50V	CH	GRM1552C1H150GZ01	K22178300		1-	A	D3
C 1019	CHIP CAP.	0.01uF	25V	B	GRM155B11E103KA01D	K22148834		1-	A	D3
C 1020	CHIP CAP.	12pF	50V	CH	GRM1552C1H120JZ01D	K22178214	AUSTRALIA	1-	B	a2
C 1020	CHIP CAP.	12pF	50V	CH	GRM1552C1H120JZ01D	K22178214	EUROPE	1-	B	a2
C 1020	CHIP CAP.	12pF	50V	CH	GRM1552C1H120JZ01D	K22178214	EXPORT	1-	B	a2
C 1020	CHIP CAP.	33pF	50V	CH	GRM1552C1H330JZ01D	K22178224	USA	1-	B	a2
C 1021	CHIP CAP.	3pF	50V	CJ	GRM1553C1H3R0BZ01D	K22178290		1-	B	a2
C 1022	CHIP CAP.	0.001uF	50V	B	GRM155B11H102KA01D	K22178809		1-	B	a2
C 1023	CHIP CAP.	0.001uF	50V	B	GRM155B11H102KA01D	K22178809		1-	B	b2
C 1024	CHIP CAP.	0.001uF	50V	B	GRM155B11H102KA01D	K22178809		1-	B	b2
C 1025	CHIP CAP.	7pF	50V	CH	GRM1552C1H7R0BZ01D	K22178294		1-	B	b2
C 1026	CHIP CAP.	2pF	50V	CK	GRM1554C1H2R0BZ01D	K22178289		1-	B	b2
C 1027	CHIP CAP.	5pF	50V	CH	GRM1552C1H5R0BZ01D	K22178292		1-	B	b2
C 1028	CHIP CAP.	22pF	50V	CH	GRM1552C1H220GZ01D	K22179707		1-	B	b2
C 1029	CHIP CAP.	0.5pF	50V	CK	GRM1554C1HR50BZ01D	K22178285		1-	B	b2
C 1030	CHIP CAP.	0.001uF	50V	B	GRM155B11H102KA01D	K22178809		1-	A	C3
C 1031	CHIP CAP.	0.001uF	50V	B	GRM155B11H102KA01D	K22178809		1-	A	C3
C 1032	CHIP CAP.	2pF	50V	CK	GRM1554C1H2R0BZ01D	K22178289		1-	A	C3
C 1033	CHIP CAP.	0.001uF	50V	B	GRM155B11H102KA01D	K22178809		1-	A	D3
C 1034	CHIP CAP.	6pF	50V	CH	GRM1552C1H6R0BZ01D	K22178293		1-	A	C2
C 1035	CHIP CAP.	0.001uF	50V	B	GRM155B11H102KA01D	K22178809		1-	B	a2
C 1036	CHIP CAP.	0.001uF	50V	B	GRM155B11H102KA01D	K22178809		1-	B	a2
C 1037	CHIP CAP.	0.001uF	50V	B	GRM155B11H102KA01D	K22178809		1-	B	a2
C 1039	CHIP CAP.	0.001uF	50V	B	GRM155B11H102KA01D	K22178809		1-	B	a2
C 1040	CHIP CAP.	0.001uF	50V	B	GRM155B11H102KA01D	K22178809		1-	B	a2
C 1041	CHIP CAP.	68pF	50V	CH	GRM1552C1H680JZ01D	K22178232		1-	B	a2
C 1042	CHIP CAP.	0.001uF	50V	B	GRM155B11H102KA01D	K22178809		1-	A	D3
C 1043	CHIP CAP.	27pF	50V	CH	GRM1552C1H270JZ01D	K22178222		1-	B	a2
C 1044	CHIP CAP.	2pF	50V	CK	GRM1554C1H2R0BZ01D	K22178289		1-	B	a2
C 1045	CHIP CAP.	0.5pF	50V	CK	GRM1554C1HR50BZ01D	K22178285		1-	B	a2
C 1046	CHIP CAP.	27pF	50V	CH	GRM1552C1H270JZ01D	K22178222		1-	B	a2
C 1047	CHIP CAP.	1pF	50V	CK	GRM1554C1H1R0BZ01D	K22178287		1-	B	a2
C 1048	CHIP CAP.	0.5pF	50V	CK	GRM1554C1HR50BZ01D	K22178285		1-	B	a2
C 1049	CHIP CAP.	0.5pF	50V	CK	GRM1554C1HR50BZ01D	K22178285		1-	B	a2
C 1050	CHIP CAP.	0.5pF	50V	CK	GRM1554C1HR50BZ01D	K22178285		1-	B	a2
C 1051	CHIP CAP.	1pF	50V	CK	GRM1554C1H1R0BZ01D	K22178287		1-	B	a2
C 1052	CHIP CAP.	27pF	50V	CH	GRM1552C1H270JZ01D	K22178222		1-	B	a2
C 1053	CHIP CAP.	15pF	50V	CH	GRM1552C1H150GZ01	K22178300		1-	B	a2
C 1054	CHIP CAP.	0.01uF	25V	B	GRM155B11E103KA01D	K22148834		1-	B	a2
C 1055	CHIP CAP.	0.001uF	50V	B	GRM155B11H102KA01D	K22178809		1-	A	C2

MAIN Unit

Parts List

REF	DESCRIPTION	VALUE	V/W	TOL.	MFR'S DESIG	VXSTD P/N	VERS.	LOT	SIDE	LAY ADR
C 1056	CHIP CAP.	0.001uF	50V	B	GRM155B11H102KA01D	K22178809		1-	B	a3
C 1057	CHIP CAP.	0.001uF	50V	B	GRM155B11H102KA01D	K22178809		1-	B	a2
C 1058	CHIP CAP.	9pF	50V	CH	GRM1552C1H9R0BZ01D	K22178296		1-	B	a2
C 1059	CHIP CAP.	2pF	50V	CK	GRM1554C1H2R0BZ01D	K22178289		1-	B	a2
C 1060	CHIP CAP.	5pF	50V	CH	GRM1552C1H5R0BZ01D	K22178292		1-	B	a2
C 1061	CHIP CAP.	22pF	50V	CH	GRM1552C1H220GZ01D	K22179707		1-	B	a2
C 1062	CHIP CAP.	0.5pF	50V	CK	GRM1554C1HR50BZ01D	K22178285		1-	B	a2
C 1063	CHIP CAP.	0.001uF	50V	B	GRM155B11H102KA01D	K22178809		1-	B	a2
C 1064	CHIP CAP.	0.001uF	50V	B	GRM155B11H102KA01D	K22178809		1-	B	a2
C 1065	CHIP CAP.	3pF	50V	CJ	GRM1553C1H3R0BZ01D	K22178290		1-	B	a2
C 1066	CHIP CAP.	0.001uF	50V	B	GRM155B11H102KA01D	K22178809		1-	B	a2
C 1067	CHIP CAP.	6pF	50V	CH	GRM1552C1H6R0BZ01D	K22178293		1-	B	a2
C 1068	CHIP CAP.	12pF	50V	CH	GRM1552C1H120JZ01D	K22178214		1-	A	C1
C 1069	CHIP CAP.	0.001uF	50V	B	GRM155B11H102KA01D	K22178809		1-	A	C1
C 1070	CHIP CAP.	4pF	50V	CH	GRM1552C1H4R0BZ01D	K22178291	AUSTRALIA	1-	A	C1
C 1070	CHIP CAP.	4pF	50V	CH	GRM1552C1H4R0BZ01D	K22178291	EUROPE	1-	A	C1
C 1070	CHIP CAP.	4pF	50V	CH	GRM1552C1H4R0BZ01D	K22178291	EXPORT	1-	A	C1
C 1070	CHIP CAP.	4pF	50V	CH	GRM1552C1H4R0BZ01D	K22178291	USA	1-	A	C1
C 1071	CHIP CAP.	7pF	50V	CH	GRM1552C1H7R0BZ01D	K22178294		1-	A	C1
C 1072	CHIP CAP.	0.001uF	50V	B	GRM155B11H102KA01D	K22178809		1-	A	C1
C 1073	CHIP CAP.	0.1uF	10V	B	GRM155B11A104KA01D	K22108802		1-	A	C1
C 1074	CHIP CAP.	0.001uF	50V	B	GRM155B11H102KA01D	K22178809		1-	A	C2
C 1075	CHIP CAP.	0.5pF	50V	CK	GRM1554C1HR50BZ01D	K22178285		1-	A	C2
C 1076	CHIP CAP.	0.001uF	50V	B	GRM155B11H102KA01D	K22178809		1-	A	C2
C 1077	CHIP CAP.	8pF	50V	CH	GRM1552C1H8R0BZ01D	K22178295		1-	A	C2
C 1078	CHIP CAP.	1.5pF	50V	CK	GRM1554C1H1R5BZ01D	K22178288		1-	A	C2
C 1079	CHIP CAP.	47pF	50V	CH	GRM1552C1H470JZ01D	K22178228		1-	A	C2
C 1080	CHIP CAP.	0.75pF	50V	CK	GRM1554C1HR75BZ01D	K22178286		1-	A	C2
C 1081	CHIP CAP.	18pF	50V	CH	GRM1552C1H180JZ01D	K22178218		1-	A	C2
C 1082	CHIP CAP.	2pF	50V	CK	GRM1554C1H2R0BZ01D	K22178289		1-	A	C2
C 1083	CHIP CAP.	0.5pF	50V	CK	GRM1554C1HR50BZ01D	K22178285		1-	A	C2
C 1084	CHIP CAP.	47pF	50V	CH	GRM1552C1H470JZ01D	K22178228		1-	A	C2
C 1085	CHIP CAP.	8pF	50V	CH	GRM1552C1H8R0BZ01D	K22178295		1-	A	C2
C 1086	CHIP CAP.	0.5pF	50V	CK	GRM1554C1HR50BZ01D	K22178285		1-	A	C2
C 1087	CHIP CAP.	1pF	50V	CK	GRM1554C1H1R0BZ01D	K22178287		1-	A	C3
C 1088	CHIP CAP.	47pF	50V	CH	GRM1552C1H470JZ01D	K22178228		1-	A	C2
C 1089	CHIP CAP.	15pF	50V	CH	GRM1552C1H150GZ01	K22178300	AUSTRALIA	1-	A	C3
C 1089	CHIP CAP.	15pF	50V	CH	GRM1552C1H150GZ01	K22178300	EUROPE	1-	A	C3
C 1089	CHIP CAP.	15pF	50V	CH	GRM1552C1H150GZ01	K22178300	EXPORT	1-	A	C3
C 1089	CHIP CAP.	15pF	50V	CH	GRM1552C1H150GZ01	K22178300	USA	1-	A	C3
C 1090	CHIP CAP.	0.001uF	50V	B	GRM155B11H102KA01D	K22178809		1-	A	C3
C 1091	CHIP CAP.	0.01uF	25V	B	GRM155B11E103KA01D	K22148834		1-	A	C3
C 1092	CHIP CAP.	0.001uF	50V	B	GRM155B11H102KA01D	K22178809		1-	A	C3
C 1093	CHIP CAP.	7pF	50V	CH	GRM1552C1H7R0BZ01D	K22178294		1-	A	C3
C 1094	CHIP CAP.	12pF	50V	CH	GRM1552C1H120JZ01D	K22178214		1-	A	C1
C 1095	CHIP CAP.	4pF	50V	CH	GRM1552C1H4R0BZ01D	K22178291		1-	A	C1
C 1096	CHIP CAP.	10pF	50V	CH	GRM1552C1H100BZ01D	K22178297		1-	A	C1
C 1097	CHIP CAP.	8pF	50V	CH	GRM1552C1H8R0DZ01D	K22178210		1-	A	C1
C 1098	CHIP CAP.	15pF	50V	CH	GRM1552C1H150GZ01	K22178300		1-	A	C1
C 1099	CHIP CAP.	3pF	50V	CJ	GRM1553C1H3R0BZ01D	K22178290	AUSTRALIA	1-	A	C1
C 1099	CHIP CAP.	3pF	50V	CJ	GRM1553C1H3R0BZ01D	K22178290	EUROPE	1-	A	C1
C 1099	CHIP CAP.	3pF	50V	CJ	GRM1553C1H3R0BZ01D	K22178290	EXPORT	1-	A	C1
C 1099	CHIP CAP.	3pF	50V	CJ	GRM1553C1H3R0BZ01D	K22178290	USA	1-	A	C1
C 1100	CHIP CAP.	9pF	50V	CH	GRM1552C1H9R0BZ01D	K22178296	AUSTRALIA	1-	A	C1
C 1100	CHIP CAP.	9pF	50V	CH	GRM1552C1H9R0BZ01D	K22178296	EUROPE	1-	A	C1
C 1100	CHIP CAP.	9pF	50V	CH	GRM1552C1H9R0BZ01D	K22178296	EXPORT	1-	A	C1
C 1100	CHIP CAP.	9pF	50V	CH	GRM1552C1H9R0BZ01D	K22178296	USA	1-	A	C1
C 1101	CHIP CAP.	0.001uF	50V	B	GRM155B11H102KA01D	K22178809		1-	A	C2
C 1102	CHIP CAP.	0.001uF	50V	B	GRM155B11H102KA01D	K22178809		1-	A	C1
C 1103	CHIP CAP.	0.001uF	50V	B	GRM155B11H102KA01D	K22178809		1-	A	C1
C 1104	CHIP CAP.	0.1uF	10V	B	GRM155B11A104KA01D	K22108802		1-	A	C1
C 1105	CHIP CAP.	0.001uF	50V	B	GRM155B11H102KA01D	K22178809		1-	A	D2
C 1106	CHIP CAP.	0.5pF	50V	CK	GRM1554C1HR50BZ01D	K22178285		1-	A	D2
C 1107	CHIP CAP.	0.001uF	50V	B	GRM155B11H102KA01D	K22178809		1-	A	D2
C 1108	CHIP CAP.	8pF	50V	CH	GRM1552C1H8R0BZ01D	K22178295		1-	A	D2
C 1109	CHIP CAP.	0.75pF	50V	CK	GRM1554C1HR75BZ01D	K22178286		1-	A	D2
C 1110	CHIP CAP.	47pF	50V	CH	GRM1552C1H470JZ01D	K22178228		1-	A	D2
C 1111	CHIP CAP.	0.75pF	50V	CK	GRM1554C1HR75BZ01D	K22178286		1-	A	D2
C 1112	CHIP CAP.	18pF	50V	CH	GRM1552C1H180JZ01D	K22178218		1-	A	D2
C 1113	CHIP CAP.	1.5pF	50V	CK	GRM1554C1H1R5BZ01D	K22178288		1-	A	D2
C 1114	CHIP CAP.	0.75pF	50V	CK	GRM1554C1HR75BZ01D	K22178286		1-	A	D2
C 1115	CHIP CAP.	47pF	50V	CH	GRM1552C1H470JZ01D	K22178228		1-	A	D2
C 1116	CHIP CAP.	8pF	50V	CH	GRM1552C1H8R0BZ01D	K22178295		1-	A	D2
C 1117	CHIP CAP.	0.5pF	50V	CK	GRM1554C1HR50BZ01D	K22178285		1-	A	D2
C 1118	CHIP CAP.	1pF	50V	CK	GRM1554C1H1R0BZ01D	K22178287		1-	A	D2

REF	DESCRIPTION	VALUE	V/W	TOL.	MFR'S DESIG	VXSTD P/N	VERS.	LOT	SIDE	LAY ADR
C 1119	CHIP CAP.	47pF	50V	CH	GRM1552C1H470JZ01D	K22178228		1-	A	D2
C 1120	CHIP CAP.	15pF	50V	CH	GRM1552C1H150GZ01	K22178300	AUSTRALIA	1-	A	D2
C 1120	CHIP CAP.	15pF	50V	CH	GRM1552C1H150GZ01	K22178300	EUROPE	1-	A	D2
C 1120	CHIP CAP.	15pF	50V	CH	GRM1552C1H150GZ01	K22178300	EXPORT	1-	A	D2
C 1120	CHIP CAP.	15pF	50V	CH	GRM1552C1H150GZ01	K22178300	USA	1-	A	D2
C 1121	CHIP CAP.	0.001uF	50V	B	GRM155B11H102KA01D	K22178809		1-	A	D3
C 1122	CHIP CAP.	0.01uF	25V	B	GRM155B11E103KA01D	K22148834		1-	A	D2
C 1123	CHIP CAP.	0.001uF	50V	B	GRM155B11H102KA01D	K22178809		1-	A	D3
C 1124	CHIP CAP.	7pF	50V	CH	GRM1552C1H7R0BZ01D	K22178294		1-	A	D3
C 1125	CHIP CAP.	30pF	50V	CH	GRM1552C1H300JZ01D	K22178223	AUSTRALIA	1-	A	C1
C 1125	CHIP CAP.	30pF	50V	CH	GRM1552C1H300JZ01D	K22178223	EUROPE	1-	A	C1
C 1125	CHIP CAP.	30pF	50V	CH	GRM1552C1H300JZ01D	K22178223	EXPORT	1-	A	C1
C 1125	CHIP CAP.	30pF	50V	CH	GRM1552C1H300JZ01D	K22178223	USA	1-	A	C1
C 1126	CHIP CAP.	4pF	50V	CH	GRM1552C1H4R0BZ01D	K22178291		1-	A	C1
C 1127	CHIP CAP.	2pF	50V	CK	GRM1554C1H2R0BZ01D	K22178289		1-	A	C1
C 1128	CHIP CAP.	22pF	50V	CH	GRM1552C1H220JZ01D	K22178220		1-	A	C1
C 1129	CHIP CAP.	0.001uF	50V	B	GRM155B11H102KA01D	K22178809		1-	A	C1
C 1130	CHIP CAP.	0.001uF	50V	B	GRM155B11H102KA01D	K22178809		1-	A	C1
C 1131	CHIP CAP.	0.001uF	50V	B	GRM155B11H102KA01D	K22178809		1-	A	C2
C 1132	CHIP CAP.	47pF	50V	UJ	GRM1553U1H470JZ01D	K22178319		1-	A	C2
C 1133	CHIP CAP.	5pF	50V	CH	GRM1552C1H5R0BZ01D	K22178292		1-	A	C2
C 1134	CHIP CAP.	2pF	50V	CK	GRM1554C1H2R0BZ01D	K22178289		1-	A	C2
C 1135	CHIP CAP.	4pF	50V	CH	GRM1552C1H4R0BZ01D	K22178291		1-	A	C2
C 1136	CHIP CAP.	27pF	50V	CH	GRM1552C1H270JZ01D	K22178222		1-	A	C3
C 1137	CHIP CAP.	0.001uF	50V	B	GRM155B11H102KA01D	K22178809		1-	A	C1
C 1138	CHIP CAP.	1pF	50V	CK	GRM1554C1H1R0BZ01D	K22178287		1-	A	C3
C 1139	CHIP CAP.	0.001uF	50V	B	GRM155B11H102KA01D	K22178809		1-	A	C3
C 1140	CHIP CAP.	10pF	50V	CH	GRM1552C1H100BZ01D	K22178297		1-	B	a3
C 1141	CHIP CAP.	0.5pF	50V	CK	GRM1554C1HR50BZ01D	K22178285		1-	A	C1
C 1142	CHIP CAP.	0.001uF	50V	B	GRM155B11H102KA01D	K22178809		1-	A	C1
C 1143	CHIP CAP.	0.001uF	50V	B	GRM155B11H102KA01D	K22178809		1-	A	D2
C 1144	CHIP CAP.	47pF	50V	UJ	GRM1553U1H470JZ01D	K22178319		1-	A	D2
C 1145	CHIP CAP.	5pF	50V	CH	GRM1552C1H5R0BZ01D	K22178292		1-	A	D2
C 1146	CHIP CAP.	2pF	50V	CK	GRM1554C1H2R0BZ01D	K22178289		1-	A	D2
C 1147	CHIP CAP.	4pF	50V	CH	GRM1552C1H4R0BZ01D	K22178291		1-	A	D2
C 1148	CHIP CAP.	22pF	50V	CH	GRM1552C1H220JZ01D	K22178220		1-	A	D2
C 1149	CHIP CAP.	0.001uF	50V	B	GRM155B11H102KA01D	K22178809		1-	A	C2
C 1150	CHIP CAP.	1pF	50V	CK	GRM1554C1H1R0BZ01D	K22178287		1-	A	D3
C 1151	CHIP CAP.	0.001uF	50V	B	GRM155B11H102KA01D	K22178809		1-	A	D3
C 1152	CHIP CAP.	10pF	50V	CH	GRM1552C1H100BZ01D	K22178297		1-	B	a3
C 1153	CHIP CAP.	0.001uF	50V	B	GRM155B11H102KA01D	K22178809		1-	A	D2
C 1154	CHIP CAP.	2pF	50V	CK	GRM1554C1H2R0BZ01D	K22178289		1-	B	a1
C 1155	CHIP CAP.	2pF	200V	CK	GRM1884C2D2R0CV01D	K22234204		1-	B	a1
C 1156	CHIP CAP.	220pF	50V	CH	GRM1552C1H221JA01D	K22179713		1-	A	D1
C 1157	CHIP CAP.	2pF	50V	CK	GRM1554C1H2R0BZ01D	K22178289		1-	A	D1
C 1158	CHIP CAP.	6pF	50V	CH	GRM1552C1H6R0BZ01D	K22178293		1-	A	D1
C 1159	CHIP CAP.	0.001uF	50V	B	GRM155B11H102KA01D	K22178809		1-	A	D1
C 1160	CHIP CAP.	2pF	50V	CK	GRM1554C1H2R0BZ01D	K22178289		1-	A	D2
C 1161	CHIP CAP.	1.5pF	50V	CK	GRM1554C1H1R5BZ01D	K22178288		1-	A	D1
C 1162	CHIP CAP.	8pF	50V	CH	GRM1552C1H8R0BZ01D	K22178295		1-	A	D2
C 1163	CHIP CAP.	0.001uF	50V	B	GRM155B11H102KA01D	K22178809		1-	A	D2
C 1164	CHIP CAP.	0.001uF	50V	B	GRM155B11H102KA01D	K22178809		1-	B	b2
C 1166	CHIP CAP.	0.001uF	50V	B	GRM155B11H102KA01D	K22178809		1-	B	a2
C 1167	CHIP CAP.	1pF	50V	CK	GRM1554C1H1R0BZ01D	K22178287		1-	B	b2
C 1168	CHIP CAP.	22pF	50V	CH	GRM1552C1H220GZ01D	K22179707		1-	B	a2
C 1169	CHIP CAP.	10pF	50V	CH	GRM1552C1H100BZ01D	K22178297		1-	B	b2
C 1170	CHIP CAP.	10pF	50V	CH	GRM1552C1H100BZ01D	K22178297		1-	B	b3
C 1171	CHIP CAP.	0.75pF	50V	CK	GRM1554C1HR75BZ01D	K22178286		1-	B	b3
C 1172	CHIP CAP.	2pF	50V	CK	GRM1554C1H2R0BZ01D	K22178289		1-	B	b3
C 1173	CHIP CAP.	2pF	50V	CK	GRM1554C1H2R0BZ01D	K22178289		1-	B	b3
C 1174	CHIP CAP.	0.001uF	50V	B	GRM155B11H102KA01D	K22178809		1-	B	b3
C 1175	CHIP CAP.	2pF	50V	CK	GRM1554C1H2R0BZ01D	K22178289		1-	A	D1
C 1176	CHIP CAP.	8pF	50V	CH	GRM1552C1H8R0BZ01D	K22178295		1-	A	D2
C 1177	CHIP CAP.	0.001uF	50V	B	GRM155B11H102KA01D	K22178809		1-	A	D2
C 1179	CHIP CAP.	0.001uF	50V	B	GRM155B11H102KA01D	K22178809		1-	A	E2
C 1180	CHIP CAP.	1pF	50V	CK	GRM1554C1H1R0BZ01D	K22178287		1-	A	D2
C 1181	CHIP CAP.	22pF	50V	CH	GRM1552C1H220GZ01D	K22179707		1-	A	D2
C 1182	CHIP CAP.	10pF	50V	CH	GRM1552C1H100BZ01D	K22178297		1-	A	E2
C 1183	CHIP CAP.	15pF	50V	CH	GRM1552C1H150JZ01D	K22178216		1-	A	D2
C 1184	CHIP CAP.	0.75pF	50V	CK	GRM1554C1HR75BZ01D	K22178286		1-	A	E2
C 1185	CHIP CAP.	2pF	50V	CK	GRM1554C1H2R0BZ01D	K22178289		1-	A	D2
C 1186	CHIP CAP.	2pF	50V	CK	GRM1554C1H2R0BZ01D	K22178289		1-	A	D2
C 1187	CHIP CAP.	0.001uF	50V	B	GRM155B11H102KA01D	K22178809		1-	A	E2
C 1188	CHIP CAP.	0.001uF	50V	B	GRM155B11H102KA01D	K22178809		1-	B	a3
C 1189	CHIP CAP.	0.001uF	50V	B	GRM155B11H102KA01D	K22178809		1-	B	a2

MAIN Unit

Parts List

REF	DESCRIPTION	VALUE	V/W	TOL.	MFR'S DESIG	VXSTD P/N	VERS.	LOT	SIDE	LAY ADR
C 1190	CHIP CAP.	27pF	50V	CH	GRM1552C1H270JZ01D	K22178222		1-	B	a2
C 1191	CHIP CAP.	27pF	50V	CH	GRM1552C1H270JZ01D	K22178222		1-	A	D2
C 1192	CHIP CAP.	0.001uF	50V	B	GRM155B11H102KA01D	K22178809		1-	B	b1
C 1193	CHIP CAP.	0.001uF	50V	B	GRM155B11H102KA01D	K22178809		1-	B	b2
C 1194	CHIP CAP.	0.001uF	50V	B	GRM155B11H102KA01D	K22178809		1-	B	a3
C 1195	CHIP CAP.	0.001uF	50V	B	GRM155B11H102KA01D	K22178809		1-	A	C1
C 1196	CHIP CAP.	0.01uF	25V	B	GRM155B11E103KA01D	K22148834		1-	A	C2
C 1198	CHIP CAP.	0.001uF	50V	B	GRM155B11H102KA01D	K22178809		1-	A	B1
C 1199	CHIP CAP.	0.001uF	50V	B	GRM155B11H102KA01D	K22178809		1-	A	D1
C 1200	CHIP CAP.	0.001uF	50V	B	GRM155B11H102KA01D	K22178809		1-	B	a1
C 1201	CHIP CAP.	4pF	200V	CH	GRM1882C2D4R0CV01D	K22234206		1-	B	a1
C 1202	CHIP CAP.	4pF	200V	CH	GRM1882C2D4R0CV01D	K22234206		1-	B	a1
C 1204	CHIP CAP.	0.5pF	200V	CK	GRM1884C2DR50CY21D	K22234201		1-	B	a1
C 1205	CHIP CAP.	2pF	200V	CK	GRM1884C2D2R0CV01D	K22234204		1-	B	a1
C 1206	CHIP CAP.	2pF	200V	CK	GRM1884C2D2R0CV01D	K22234204		1-	B	a1
C 1208	CHIP CAP.	4pF	200V	CH	GRM1882C2D4R0CV01D	K22234206		1-	B	a1
C 1209	CHIP CAP.	4pF	200V	CH	GRM1882C2D4R0CV01D	K22234206		1-	B	a1
C 1211	CHIP CAP.	3pF	200V	CJ	GRM1883C2D3R0CV01D	K22234205		1-	B	a1
C 1213	CHIP CAP.	0.5pF	200V	CK	GRM1884C2DR50CY21D	K22234201		1-	B	a1
C 1214	CHIP CAP.	9pF	50V	CH	GRM1552C1H9R0BZ01D	K22178296		1-	A	D1
C 1215	CHIP CAP.	3pF	200V	CJ	GRM1883C2D3R0CV01D	K22234205		1-	B	a1
C 1216	CHIP CAP.	1.5pF	200V	CK	GRM1884C2D1R5CV01D	K22234213		1-	B	a1
C 1217	CHIP CAP.	0.001uF	50V	B	GRM155B11H102KA01D	K22178809		1-	A	D1
C 1218	CHIP CAP.	4pF	200V	CH	GRM1882C2D4R0CV01D	K22234206		1-	B	a1
C 1219	CHIP CAP.	4pF	200V	CH	GRM1882C2D4R0CV01D	K22234206		1-	B	a1
C 1220	CHIP CAP.	0.001uF	50V	B	GRM155B11H102KA01D	K22178809		1-	A	D1
C 1222	CHIP CAP.	2pF	200V	CK	GRM1884C2D2R0CV01D	K22234204		1-	B	a1
C 1223	CHIP CAP.	0.5pF	200V	CK	GRM1884C2DR50CY21D	K22234201		1-	A	D1
C 1224	CHIP CAP.	6pF	50V	CH	GRM1552C1H6R0BZ01D	K22178293		1-	A	D1
C 1225	CHIP CAP.	0.001uF	50V	B	GRM155B11H102KA01D	K22178809		1-	B	a1
C 1226	CHIP CAP.	0.0047uF	50V	B	GRM155B11H472KA01D	K22178838		1-	B	a2
C 1227	CHIP CAP.	0.0047uF	50V	B	GRM155B11H472KA01D	K22178838		1-	B	a2
C 1228	AL.ELECTRO.CAP.	22uF	50V		EEE1HA220WP	K48170026		1-	A	D2
C 1229	CHIP CAP.	7pF	50V	CH	GRM1552C1H7R0BZ01D	K22178294		1-	A	D3
C 1230	CHIP CAP.	0.0047uF	50V	B	GRM155B11H472KA01D	K22178838		1-	B	a2
C 1231	CHIP TA.CAP.	1uF	16V		TEESVA1C105M8R	K78120009		1-	B	a2
C 1232	CHIP CAP.	22pF	50V	CH	GRM1552C1H220JZ01D	K22178220		1-	A	D3
C 1233	CHIP CAP.	0.001uF	50V	B	GRM155B11H102KA01D	K22178809		1-	A	D3
C 1234	CHIP CAP.	0.001uF	50V	B	GRM155B11H102KA01D	K22178809		1-	A	D3
C 1235	CHIP CAP.	0.01uF	25V	B	GRM155B11E103KA01D	K22148834		1-	B	b3
C 1236	CHIP CAP.	47pF	50V	CH	GRM1552C1H470JZ01D	K22178228		1-	A	C3
C 1237	CHIP CAP.	0.001uF	50V	B	GRM155B11H102KA01D	K22178809		1-	A	C3
C 1239	CHIP CAP.	0.001uF	50V	B	GRM155B11H102KA01D	K22178809		1-	B	b1
C 1240	CHIP CAP.	22pF	50V	CH	GRM1552C1H220JZ01D	K22178220		1-	A	C1
C 1241	CHIP CAP.	15pF	200V	CH	GRM2192C2D150JV01D	K22230218		1-	B	a1
C 1242	CHIP CAP.	22pF	50V	CH	GRM1552C1H220JZ01D	K22178220		1-	A	C1
C 1243	CHIP CAP.	12pF	200V	CH	GRM2192C2D120JV01D	K22230217		1-	B	a1
C 1244	CHIP CAP.	4pF	200V	CH	GRM1882C2D4R0CV01D	K22234206		1-	B	b1
C 1245	CHIP CAP.	0.001uF	50V	B	GRM155B11H102KA01D	K22178809		1-	B	b1
C 1246	CHIP CAP.	0.001uF	50V	B	GRM155B11H102KA01D	K22178809		1-	A	C1
C 1248	CHIP CAP.	0.01uF	25V	B	GRM155B11E103KA01D	K22148834		1-	A	C1
C 1249	CHIP CAP.	0.001uF	50V	B	GRM155B11H102KA01D	K22178809		1-	B	b1
C 1250	CHIP CAP.	0.1uF	10V	B	GRM155B11A104KA01D	K22108802		1-	B	b1
C 1251	CHIP CAP.	0.01uF	25V	B	GRM155B11E103KA01D	K22148834		1-	B	b1
C 1252	CHIP CAP.	0.001uF	50V	B	GRM155B11H102KA01D	K22178809		1-	B	b1
C 1253	CHIP CAP.	0.001uF	50V	B	GRM155B11H102KA01D	K22178809		1-	B	b3
C 1254	CHIP TA.CAP.	10uF	10V		TEESVA1A106M8R	K78100028		1-	A	D1
C 1255	CHIP CAP.	0.047uF	10V	B	GRM155B11A473KA01D	K22108801		1-	B	b1
C 1256	CHIP CAP.	0.5pF	200V	CK	GRM1884C2DR50CY21D	K22234201		1-	B	b1
C 1257	CHIP CAP.	18pF	200V	CH	GRM2192C2D180JV01D	K22230219		1-	B	b1
C 1258	CHIP CAP.	6pF	50V	CH	GRM1552C1H6R0BZ01D	K22178293		1-	B	b1
C 1259	CHIP CAP.	18pF	200V	CH	GRM2192C2D180JV01D	K22230219		1-	B	b1
C 1260	CHIP CAP.	8pF	200V	CH	GRM2192C2D8R0DY21D	K22230214		1-	B	b1
C 1260	CHIP CAP.	6pF	200V	CH	GRM2192C2D6R0DY21D	K22230212		7-	B	b1
C 1261	CHIP CAP.	0.001uF	50V	B	GRM155B11H102KA01D	K22178809		1-	B	b1
C 1262	CHIP CAP.	8pF	200V	CH	GRM2192C2D8R0DY21D	K22230214		1-	B	b1
C 1263	CHIP CAP.	8pF	200V	CH	GRM2192C2D8R0DY21D	K22230214		1-	B	b1
C 1264	CHIP CAP.	0.001uF	50V	B	GRM155B11H102KA01D	K22178809		1-	B	b1
C 1265	CHIP CAP.	0.5pF	200V	CK	GRM1884C2DR50CY21D	K22234201		1-	B	b1
C 1266	CHIP CAP.	7pF	50V	CH	GRM1552C1H7R0BZ01D	K22178294		1-	B	b1
C 1267	CHIP CAP.	0.001uF	50V	B	GRM155B11H102KA01D	K22178809		1-	B	b1
C 1268	CHIP CAP.	0.0047uF	50V	B	GRM155B11H472KA01D	K22178838		1-	B	c1
C 1269	CHIP CAP.	15pF	50V	CH	GRM1552C1H150JZ01D	K22178216		1-	A	C1
C 1270	CHIP CAP.	33pF	50V	CH	GRM1552C1H330JZ01D	K22178224		1-	A	C1
C 1271	CHIP CAP.	0.0047uF	50V	B	GRM155B11H472KA01D	K22178838		1-	B	c1

REF	DESCRIPTION	VALUE	V/W	TOL.	MFR'S DESIG	VXSTD P/N	VERS.	LOT	SIDE	LAY ADR
C 1272	CHIP CAP.	33pF	50V	CH	GRM1552C1H330JZ01D	K22178224		1-6	B	b3
C 1273	CHIP CAP.	0.0047uF	50V	B	GRM155B11H472KA01D	K22178838		1-	B	b2
C 1274	CHIP TA.CAP.	0.22uF	35V		TEESVA1V224M8R	K78160027		1-	B	c2
C 1275	CHIP CAP.	47pF	50V	CH	GRM1552C1H470JZ01D	K22178228		1-	B	b3
C 1275	CHIP CAP.	18pF	50V	CH	GRM1552C1H180JZ01D	K22178218		7-	B	b3
C 1276	CHIP CAP.	0.001uF	50V	B	GRM155B11H102KA01D	K22178809		1-	B	b3
C 1277	CHIP CAP.	0.001uF	50V	B	GRM155B11H102KA01D	K22178809		1-6	A	C3
C 1278	CHIP CAP.	0.01uF	25V	B	GRM155B11E103KA01D	K22148834		1-	A	C3
C 1279	CHIP CAP.	100pF	50V	CH	GRM1552C1H101JD01D	K22178236		1-	A	C3
C 1279	CHIP CAP.	10pF	50V	CH	GRM1552C1H100BZ01D	K22178297		7-	A	C3
C 1280	CHIP CAP.	0.001uF	50V	B	GRM155B11H102KA01D	K22178809		1-	B	b3
C 1281	CHIP CAP.	0.001uF	50V	B	GRM155B11H102KA01D	K22178809		1-	B	b1
C 1282	CHIP CAP.	39pF	50V	CH	GRM1552C1H390JZ01D	K22178226		1-	A	C1
C 1283	CHIP CAP.	10pF	50V	CH	GRM1552C1H100BZ01D	K22178297		1-	A	C1
C 1284	CHIP CAP.	0.001uF	50V	B	GRM155B11H102KA01D	K22178809		1-	A	C1
C 1285	CHIP CAP.	5pF	50V	CH	GRM1552C1H5R0BZ01D	K22178292		1-	B	b1
C 1286	CHIP CAP.	0.047uF	16V	F	GRM155F11C473ZA01D	K22129004		1-	A	C1
C 1287	CHIP CAP.	0.001uF	50V	B	GRM155B11H102KA01D	K22178809		1-	A	C1
C 1288	CHIP CAP.	0.001uF	50V	B	GRM155B11H102KA01D	K22178809		1-	A	C2
C 1290	CHIP CAP.	0.001uF	50V	B	GRM155B11H102KA01D	K22178809		1-	A	C2
C 1291	CHIP CAP.	0.001uF	50V	B	GRM155B11H102KA01D	K22178809		1-	A	C2
C 1292	CHIP CAP.	22pF	50V	CH	GRM1552C1H220JZ01D	K22178220		1-	B	b2
C 1293	CHIP CAP.	0.001uF	50V	B	GRM155B11H102KA01D	K22178809		1-	A	B2
C 1294	CHIP CAP.	0.1uF	10V	B	GRM155B11A104KA01D	K22108802		1-	A	B2
C 1295	CHIP CAP.	0.001uF	50V	B	GRM155B11H102KA01D	K22178809		1-	B	b2
C 1296	CHIP CAP.	10pF	50V	CH	GRM1552C1H100BZ01D	K22178297		1-	B	c2
C 1297	CHIP CAP.	0.001uF	50V	B	GRM155B11H102KA01D	K22178809		1-	A	C2
C 1298	CHIP CAP.	0.001uF	50V	B	GRM155B11H102KA01D	K22178809		1-	B	b3
C 1299	CHIP CAP.	0.1uF	25V	B	GRM21BB11E104KA01L	K22140811		1-	B	b2
C 1300	CHIP CAP.	0.01uF	25V	B	GRM155B11E103KA01D	K22148834		1-	A	B1
C 1301	CHIP CAP.	56pF	50V	CH	GRM1552C1H560JD01D	K22178230		1-	A	C1
C 1302	CHIP CAP.	8pF	50V	CH	GRM1552C1H8R0BZ01D	K22178295		1-	A	B1
C 1304	CHIP CAP.	100pF	50V	CH	GRM1552C1H101JD01D	K22178236		1-	A	B1
C 1305	CHIP CAP.	0.0022uF	50V	B	GRM155B11H222KA01D	K22178813		1-	A	B1
C 1306	CHIP CAP.	0.001uF	50V	B	GRM155B11H102KA01D	K22178809		1-	A	B1
C 1307	CHIP CAP.	0.01uF	25V	B	GRM155B11E103KA01D	K22148834		1-	A	B1
C 1308	CHIP TA.CAP.	10uF	10V		TEESVA1A106M8R	K78100028		1-	A	B2
C 1309	CHIP CAP.	3pF	50V	CJ	GRM1553C1H3R0BZ01D	K22178290		1-	A	B1
C 1310	CHIP CAP.	0.1uF	10V	B	GRM155B11A104KA01D	K22108802		1-	A	B2
C 1311	CHIP CAP.	1uF	6.3V	B	GRM155B30J105KE18D	K22088803		1-	A	B2
C 1312	CHIP CAP.	100pF	50V	CH	GRM1552C1H101JD01D	K22178236		1-	A	B1
C 1313	CHIP CAP.	1uF	6.3V	B	GRM155B30J105KE18D	K22088803		1-	A	B2
C 1314	CHIP CAP.	0.001uF	50V	B	GRM155B11H102KA01D	K22178809		1-	A	D3
C 1315	CHIP CAP.	0.001uF	50V	B	GRM155B11H102KA01D	K22178809		1-	A	D3
C 1316	CHIP CAP.	3pF	50V	CJ	GRM1553C1H3R0BZ01D	K22178290		1-	A	D3
C 1317	CHIP CAP.	0.001uF	50V	B	GRM155B11H102KA01D	K22178809		1-	A	D3
C 1318	CHIP CAP.	0.001uF	50V	B	GRM155B11H102KA01D	K22178809		1-	B	a3
C 1320	CHIP CAP.	1pF	50V	CK	GRM1554C1H1R0BZ01D	K22178287		1-	B	a3
C 1321	CHIP CAP.	16pF	50V	CH	GRM1552C1H160JZ01D	K22178217		1-	B	a3
C 1322	CHIP CAP.	9pF	50V	CH	GRM1552C1H9R0BZ01D	K22178296		1-	B	a3
C 1323	CHIP CAP.	22pF	50V	CH	GRM1552C1H220JZ01D	K22178220		1-	B	a3
C 1324	CHIP CAP.	0.001uF	50V	B	GRM188B11H102KA01D	K22174821		1-	B	a3
C 1325	CHIP CAP.	0.001uF	50V	B	GRM155B11H102KA01D	K22178809		1-	B	a3
C 1326	CHIP CAP.	0.001uF	50V	B	GRM155B11H102KA01D	K22178809		1-	B	a3
C 1327	CHIP CAP.	2pF	50V	CK	GRM1554C1H2R0BZ01D	K22178289		1-	A	D3
C 1328	CHIP TA.CAP.	0.1uF	20V		SKF-1D104M-RP	K78130049		1-	A	D3
C 1329	CHIP TA.CAP.	0.1uF	20V		SKF-1D104M-RP	K78130049		1-	A	D3
C 1330	CHIP CAP.	0.01uF	25V	B	GRM155B11E103KA01D	K22148834		1-	A	D3
C 1331	CHIP CAP.	0.001uF	50V	B	GRM155B11H102KA01D	K22178809		1-	B	a3
C 1333	CHIP CAP.	2pF	50V	CK	GRM1554C1H2R0BZ01D	K22178289		1-	B	a3
C 1334	CHIP CAP.	100pF	50V	CH	GRM1552C1H101JD01D	K22178236		1-	A	D3
C 1335	CHIP CAP.	18pF	50V	CH	GRM1552C1H180JZ01D	K22178218		1-	B	a3
C 1336	CHIP CAP.	18pF	50V	CH	GRM1552C1H180JZ01D	K22178218		1-	B	a3
C 1337	CHIP CAP.	27pF	50V	CH	GRM1552C1H270JZ01D	K22178222		1-	B	a3
C 1338	CHIP CAP.	0.01uF	25V	B	GRM155B11E103KA01D	K22148834		1-	A	D3
C 1339	CHIP CAP.	0.001uF	50V	B	GRM188B11H102KA01D	K22174821		1-	B	a3
C 1340	CHIP CAP.	0.001uF	50V	B	GRM155B11H102KA01D	K22178809		1-	B	a3
C 1341	CHIP CAP.	0.001uF	50V	B	GRM155B11H102KA01D	K22178809		1-	A	D3
C 1342	CHIP CAP.	0.001uF	50V	B	GRM155B11H102KA01D	K22178809		1-	B	a3
C 1343	CHIP CAP.	0.001uF	50V	B	GRM155B11H102KA01D	K22178809		1-	A	D3
C 1344	CHIP CAP.	22pF	50V	CH	GRM1552C1H220JZ01D	K22178220		1-	A	D3
C 1345	CHIP TA.CAP.	6.8uF	16V		TEESVA1C685M8R	K78120056		1-	A	D3
C 1346	CHIP TA.CAP.	1uF	16V		TEESVA1C105M8R	K78120009		1-	A	D3
C 1347	CHIP CAP.	0.22uF	10V	B	GRM155B31A224KE18D	K22108808		1-	A	D3
C 1348	CHIP CAP.	0.1uF	10V	B	GRM155B11A104KA01D	K22108802		1-	A	D3

MAIN Unit

Parts List

REF	DESCRIPTION	VALUE	V/W	TOL.	MFR'S DESIG	VXSTD P/N	VERS.	LOT	SIDE	LAY ADR
C 1349	CHIP CAP.	33pF	50V	CH	GRM1552C1H330JZ01D	K22178224		1-	A	D4
C 1350	CHIP CAP.	33pF	50V	CH	GRM1552C1H330JZ01D	K22178224		1-	A	D3
C 1351	CHIP CAP.	33pF	50V	CH	GRM1552C1H330JZ01D	K22178224		1-	A	D4
C 1352	CHIP CAP.	8pF	50V	CH	GRM1552C1H8R0BZ01D	K22178295		1-	A	D4
C 1353	CHIP CAP.	5pF	50V	CH	GRM1552C1H5R0BZ01D	K22178292		1-	A	D4
C 1354	CHIP CAP.	100pF	50V	UJ	GRM1553U1H101JZ01D	K22178323		1-	A	D4
C 1355	CHIP CAP.	0.001uF	50V	B	GRM155B11H102KA01D	K22178809		1-	A	D3
C 1356	CHIP TA.CAP.	10uF	10V		TEESVA1A106M8R	K78100028		1-	A	E4
C 1357	CHIP CAP.	0.01uF	16V	B	GRM36B103K16PT	K22128804		1-	A	E3
C 1358	CHIP CAP.	0.047uF	10V	B	GRM155B11A473KA01D	K22108801		1-	B	a4
C 1359	CHIP CAP.	0.001uF	50V	B	GRM155B11H102KA01D	K22178809		1-	B	a4
C 1360	CHIP CAP.	0.001uF	50V	B	GRM155B11H102KA01D	K22178809		1-	A	D4
C 1361	CHIP CAP.	47pF	50V	UJ	GRM1553U1H470JZ01D	K22178319		1-	A	D4
C 1362	CHIP CAP.	8pF	50V	UJ	GRM1553U1H8R0DZ01D	K22178309		1-	A	D4
C 1363	CHIP CAP.	0.01uF	25V	B	GRM155B11E103KA01D	K22148834		1-	A	D4
C 1364	CHIP CAP.	8pF	50V	UJ	GRM1553U1H8R0DZ01D	K22178309		1-	A	D4
C 1365	CHIP CAP.	0.01uF	25V	B	GRM155B11E103KA01D	K22148834		1-	A	C2
C 1366	CHIP CAP.	1uF	10V	F	GRM188F11A105ZA01D	K22105001		1-	A	E3
C 1367	CHIP CAP.	1uF	10V	F	GRM188F11A105ZA01D	K22105001		1-	A	E4
C 1368	CHIP CAP.	0.001uF	50V	B	GRM155B11H102KA01D	K22178809		1-	A	C3
C 1369	CHIP CAP.	0.001uF	50V	B	GRM155B11H102KA01D	K22178809		1-	A	B3
C 1370	CHIP CAP.	3pF	50V	CJ	GRM1553C1H3R0BZ01D	K22178290		1-	A	C3
C 1371	CHIP CAP.	0.001uF	50V	B	GRM155B11H102KA01D	K22178809		1-	A	B3
C 1372	CHIP CAP.	0.001uF	50V	B	GRM155B11H102KA01D	K22178809		1-	B	b3
C 1374	CHIP CAP.	1pF	50V	CK	GRM1554C1H1R0BZ01D	K22178287		1-	B	b3
C 1375	CHIP CAP.	16pF	50V	CH	GRM1552C1H160JZ01D	K22178217		1-	B	b3
C 1376	CHIP CAP.	9pF	50V	CH	GRM1552C1H9R0BZ01D	K22178296		1-	B	b3
C 1377	CHIP CAP.	22pF	50V	CH	GRM1552C1H220JZ01D	K22178220		1-	B	b3
C 1378	CHIP CAP.	0.001uF	50V	B	GRM188B11H102KA01D	K22174821		1-	B	b3
C 1379	CHIP CAP.	0.001uF	50V	B	GRM155B11H102KA01D	K22178809		1-	B	b3
C 1380	CHIP CAP.	0.001uF	50V	B	GRM155B11H102KA01D	K22178809		1-	B	b3
C 1381	CHIP CAP.	0.001uF	50V	B	GRM155B11H102KA01D	K22178809		1-	B	b3
C 1382	CHIP CAP.	2pF	50V	CK	GRM1554C1H2R0BZ01D	K22178289		1-	A	C3
C 1383	CHIP CAP.	0.001uF	50V	B	GRM155B11H102KA01D	K22178809		1-	B	b3
C 1385	CHIP CAP.	2pF	50V	CK	GRM1554C1H2R0BZ01D	K22178289		1-	B	c3
C 1386	CHIP CAP.	18pF	50V	CH	GRM1552C1H180JZ01D	K22178218		1-	B	b3
C 1387	CHIP CAP.	18pF	50V	CH	GRM1552C1H180JZ01D	K22178218		1-	B	c3
C 1388	CHIP CAP.	27pF	50V	CH	GRM1552C1H270JZ01D	K22178222		1-	B	b3
C 1389	CHIP CAP.	0.001uF	50V	B	GRM188B11H102KA01D	K22174821		1-	B	c3
C 1390	CHIP CAP.	1.5pF	50V	CK	GRM1554C1H1R5BZ01D	K22178288		1-	B	b3
C 1391	CHIP CAP.	0.001uF	50V	B	GRM155B11H102KA01D	K22178809		1-	B	c3
C 1392	CHIP CAP.	0.001uF	50V	B	GRM155B11H102KA01D	K22178809		1-	A	C3
C 1393	CHIP CAP.	0.001uF	50V	B	GRM155B11H102KA01D	K22178809		1-	B	b3
C 1394	CHIP CAP.	0.001uF	50V	B	GRM155B11H102KA01D	K22178809		1-	B	c3
C 1395	CHIP CAP.	0.001uF	50V	B	GRM155B11H102KA01D	K22178809		1-	A	C3
C 1397	CHIP CAP.	0.001uF	50V	B	GRM155B11H102KA01D	K22178809		1-	B	b1
C 1398	CHIP TA.CAP.	0.1uF	20V		SKF-1D104M-RP	K78130049		1-	A	C3
C 1399	CHIP TA.CAP.	6.8uF	16V		TEESVA1C685M8R	K78120056		1-	A	C3
C 1400	CHIP CAP.	0.22uF	10V	B	GRM155B31A224KE18D	K22108808		1-	A	C3
C 1401	CHIP CAP.	0.1uF	10V	B	GRM155B11A104KA01D	K22108802		1-	A	C3
C 1402	CHIP CAP.	100pF	50V	CH	GRM1552C1H101JD01D	K22178236		1-	A	C3
C 1403	CHIP TA.CAP.	0.1uF	20V		SKF-1D104M-RP	K78130049		1-	A	C3
C 1404	CHIP CAP.	33pF	50V	CH	GRM1552C1H330JZ01D	K22178224		1-	A	C3
C 1405	CHIP CAP.	33pF	50V	CH	GRM1552C1H330JZ01D	K22178224		1-	A	C3
C 1406	CHIP CAP.	33pF	50V	CH	GRM1552C1H330JZ01D	K22178224		1-	A	C4
C 1407	CHIP CAP.	0.001uF	50V	B	GRM155B11H102KA01D	K22178809		1-	A	D3
C 1408	CHIP CAP.	8pF	50V	UJ	GRM1553U1H8R0DZ01D	K22178309		1-	A	C4
C 1409	CHIP CAP.	0.001uF	50V	B	GRM155B11H102KA01D	K22178809		1-	B	b4
C 1410	CHIP CAP.	0.001uF	50V	B	GRM155B11H102KA01D	K22178809		1-	A	C4
C 1411	CHIP CAP.	8pF	50V	UJ	GRM1553U1H8R0DZ01D	K22178309		1-	B	b4
C 1412	CHIP CAP.	100pF	50V	UJ	GRM1553U1H101JZ01D	K22178323		1-	B	b4
C 1414	CHIP CAP.	47pF	50V	UJ	GRM1553U1H470JZ01D	K22178319		1-	A	C4
C 1415	CHIP CAP.	1pF	50V	CK	GRM1554C1H1R0BZ01D	K22178287		1-	A	C4
C 1416	CHIP CAP.	0.01uF	25V	B	GRM155B11E103KA01D	K22148834		1-	A	C4
C 1418	CHIP CAP.	0.001uF	50V	B	GRM155B11H102KA01D	K22178809		1-	A	C3
C 1419	CHIP TA.CAP.	10uF	10V		TEESVA1A106M8R	K78100028		1-	A	C4
C 1420	CHIP CAP.	0.01uF	25V	B	GRM155B11E103KA01D	K22148834		1-	B	b2
C 1421	CHIP CAP.	0.01uF	16V	B	GRM36B103K16PT	K22128804		1-	A	C3
C 1422	CHIP CAP.	1uF	10V	F	GRM188F11A105ZA01D	K22105001		1-	A	C4
C 1423	CHIP CAP.	0.047uF	10V	B	GRM155B11A473KA01D	K22108801		1-	B	b4
C 1424	CHIP CAP.	1uF	10V	F	GRM188F11A105ZA01D	K22105001		1-	A	C4
C 1425	CHIP CAP.	22pF	50V	CH	GRM1552C1H220JZ01D	K22178220		1-	A	C3
C 1450	CHIP CAP.	15pF	50V	CH	GRM1552C1H150JZ01D	K22178216		1-	B	b2
C 1451	CHIP CAP.	7pF	50V	CH	GRM1552C1H7R0BZ01D	K22178294		1-	A	C2
C 1452	CHIP CAP.	0.001uF	50V	B	GRM155B11H102KA01D	K22178809		1-	A	C2

REF	DESCRIPTION	VALUE	V/W	TOL.	MFR'S DESIG	VXSTD P/N	VERS.	LOT	SIDE	LAY ADR
C 1453	CHIP CAP.	0.1uF	10V	B	GRM155B11A104KA01D	K22108802		1-	A	C2
C 1454	CHIP CAP.	7pF	50V	CH	GRM1552C1H7R0BZ01D	K22178294		1-	A	C2
C 1455	CHIP CAP.	0.1uF	10V	B	GRM155B11A104KA01D	K22108802		1-	A	B3
C 1456	CHIP CAP.	0.01uF	16V	B	GRM36B103K16PT	K22128804		1-	A	B2
C 1457	CHIP CAP.	22pF	50V	CH	GRM1552C1H220JZ01D	K22178220		1-	A	B2
C 1458	CHIP CAP.	0.01uF	16V	B	GRM36B103K16PT	K22128804		1-	A	B2
C 1459	CHIP CAP.	0.001uF	50V	B	GRM1552C1H820JD01D	K22178234		1-	B	b2
C 1460	CHIP CAP.	0.01uF	16V	B	GRM36B103K16PT	K22128804		1-	B	b2
C 1461	CHIP CAP.	0.01uF	16V	B	GRM36B103K16PT	K22128804		1-	B	c3
C 1462	CHIP CAP.	0.01uF	16V	B	GRM36B103K16PT	K22128804		1-	B	b2
C 1463	CHIP CAP.	82pF	50V	CH	GRM1552C1H820JD01D	K22178234		1-	B	c3
C 1464	CHIP CAP.	10pF	50V	CH	GRM1552C1H100BZ01D	K22178297		1-	B	c3
C 1465	CHIP CAP.	68pF	50V	CH	GRM1552C1H680JZ01D	K22178232		1-	B	c3
C 1466	CHIP CAP.	0.01uF	16V	B	GRM36B103K16PT	K22128804		1-	B	b2
C 1467	CHIP CAP.	56pF	50V	CH	GRM1552C1H560JD01D	K22178230		1-	B	c3
C 1468	CHIP CAP.	18pF	50V	CH	GRM1552C1H180JZ01D	K22178218		1-	B	c2
C 1469	CHIP CAP.	12pF	50V	CH	GRM1552C1H120JZ01D	K22178214		1-	B	c2
C 1470	CHIP CAP.	33pF	50V	CH	GRM1552C1H330JZ01D	K22178224		1-	B	c2
C 1471	CHIP CAP.	33pF	50V	CH	GRM1552C1H330JZ01D	K22178224		1-	B	c2
C 1472	CHIP CAP.	0.01uF	16V	B	GRM36B103K16PT	K22128804		1-	B	c2
C 1473	CHIP CAP.	0.1uF	10V	B	GRM155B11A104KA01D	K22108802		1-	B	c2
C 1474	CHIP CAP.	0.47uF	6.3V	B	GRM155B30J474KE18D	K22088802		1-	B	c2
C 1475	CHIP CAP.	1pF	50V	CK	GRM1554C1H1R0BZ01D	K22178287		1-	B	c3
C 1476	CHIP CAP.	1pF	50V	CK	GRM1554C1H1R0BZ01D	K22178287		1-	B	c3
C 1477	CHIP CAP.	24pF	50V	CH	GRM1552C1H240JZ01D	K22178221		1-	B	c3
C 1478	CHIP CAP.	27pF	50V	CH	GRM1552C1H270JZ01D	K22178222		1-	B	c3
C 1479	CHIP CAP.	0.01uF	16V	B	GRM36B103K16PT	K22128804		1-	B	c3
C 1480	CHIP CAP.	0.01uF	16V	B	GRM36B103K16PT	K22128804		1-	B	c3
C 1481	CHIP TA.CAP.	22uF	6.3V	B	TEESVA0J226M8R	K78080047		1-	A	B2
C 1482	CHIP CAP.	0.001uF	50V	B	GRM155B11H102KA01D	K22178809		1-	A	B2
C 1483	CHIP CAP.	0.01uF	16V	B	GRM36B103K16PT	K22128804		1-	A	B2
C 1484	CHIP CAP.	0.01uF	16V	B	GRM36B103K16PT	K22128804		1-	B	c3
C 1485	CHIP TA.CAP.	10uF	10V	B	TAJA106M010Y	K78100072		1-	A	B2
C 1486	CHIP CAP.	0.01uF	16V	B	GRM36B103K16PT	K22128804		1-	B	c3
C 1487	CHIP CAP.	0.1uF	10V	B	GRM155B11A104KA01D	K22108802		1-	A	B2
C 1488	CHIP CAP.	0.01uF	16V	B	GRM36B103K16PT	K22128804		1-	B	c3
C 1489	CHIP CAP.	0.1uF	10V	B	GRM155B11A104KA01D	K22108802		1-	B	c3
C 1490	CHIP CAP.	470pF	50V	B	GRM155B11H471KA01D	K22178805		1-	B	c2
C 1491	CHIP CAP.	470pF	50V	B	GRM155B11H471KA01D	K22178805		1-	B	c2
C 1492	CHIP CAP.	100pF	50V	CH	GRM1552C1H101JD01D	K22178236		1-	B	c2
C 1493	CHIP CAP.	0.01uF	16V	B	GRM36B103K16PT	K22128804		1-	B	c2
C 1494	CHIP CAP.	0.0022uF	50V	B	GRP155B11H222JA01E	K22178837		1-	A	B2
C 1495	CHIP CAP.	0.1uF	10V	B	GRM155B11A104KA01D	K22108802		1-	B	c2
C 1496	CHIP CAP.	0.0047uF	25V	B	GRM36B472K25PT	K22148830		1-	B	c2
C 1497	CHIP CAP.	0.001uF	50V	B	GRM155B11H102KA01D	K22178809		1-	B	c2
C 1498	CHIP CAP.	1uF	6.3V	B	GRM155B30J105KE18D	K22088803		1-	B	c2
C 1499	CHIP CAP.	0.001uF	50V	B	GRM155B11H102KA01D	K22178809		1-	A	B2
C 1500	CHIP CAP.	100pF	50V	CH	GRM1552C1H101JD01D	K22178236		1-	B	c3
C 1501	CHIP CAP.	0.1uF	10V	B	GRM155B11A104KA01D	K22108802		1-	B	c3
C 1502	CHIP CAP.	0.01uF	16V	B	GRM36B103K16PT	K22128804		1-	B	c3
C 1503	CHIP CAP.	330pF	50V	B	GRM155B11H331KA01D	K22178803		1-	A	B2
C 1504	CHIP CAP.	22pF	50V	CH	GRM1552C1H220JZ01D	K22178220		1-	A	B2
C 1505	CHIP CAP.	1uF	6.3V	B	GRM155B30J105KE18D	K22088803		1-	B	c3
C 1506	CHIP CAP.	0.0056uF	25V	B	GRM155B11E562KA01D	K22148802		1-	B	c2
C 1507	CHIP CAP.	0.001uF	50V	B	GRM155B11H102KA01D	K22178809		1-	B	c2
C 1508	CHIP CAP.	1uF	6.3V	B	GRM155B30J105KE18D	K22088803		1-	B	c3
C 1509	CHIP CAP.	0.1uF	10V	B	GRM155B11A104KA01D	K22108802		1-	B	c2
C 1510	CHIP CAP.	0.1uF	10V	B	GRM155B11A104KA01D	K22108802		1-	B	c2
C 1511	CHIP CAP.	0.0022uF	50V	B	GRM155B11H222KA01D	K22178813		1-	B	c2
C 1512	CHIP CAP.	0.01uF	16V	B	GRM36B103K16PT	K22128804		1-	B	c2
C 1513	CHIP CAP.	0.1uF	10V	B	GRM155B11A104KA01D	K22108802		1-	B	c2
C 1514	CHIP CAP.	1uF	6.3V	B	GRM155B30J105KE18D	K22088803		1-	A	B2
C 1515	CHIP CAP.	0.047uF	10V	B	GRM155B11A473KA01D	K22108801		1-	B	d4
C 1516	CHIP CAP.	0.01uF	16V	B	GRM36B103K16PT	K22128804		1-	B	d3
C 1517	CHIP CAP.	0.047uF	10V	B	GRM155B11A473KA01D	K22108801		1-	A	B2
C 1518	CHIP CAP.	0.047uF	10V	B	GRM155B11A473KA01D	K22108801		1-	A	B2
C 1519	CHIP CAP.	0.047uF	10V	B	GRM155B11A473KA01D	K22108801		1-	A	B2
C 1520	CHIP CAP.	1uF	6.3V	B	GRM155B30J105KE18D	K22088803		1-	A	B2
C 1521	CHIP CAP.	0.022uF	16V	B	GRM155B11C223KA01D	K22128806		1-	B	d2
C 1522	CHIP CAP.	0.022uF	16V	B	GRM155B11C223KA01D	K22128806		1-	B	d3
C 1523	CHIP CAP.	680pF	50V	B	GRM155B11H681KA01D	K22178807		1-	B	d3
C 1524	CHIP CAP.	0.0047uF	25V	B	GRM36B472K25PT	K22148830		1-	B	d3
C 1525	CHIP CAP.	470pF	50V	B	GRM155B11H471KA01D	K22178805		1-	B	d3
C 1526	CHIP CAP.	0.1uF	10V	B	GRM155B11A104KA01D	K22108802		1-	A	B2
C 1527	CHIP CAP.	1uF	6.3V	B	GRM155B30J105KE18D	K22088803		1-	A	B2

MAIN Unit

Parts List

REF	DESCRIPTION	VALUE	V/W	TOL.	MFR'S DESIG	VXSTD P/N	VERS.	LOT	SIDE	LAY ADR
C 1528	CHIP CAP.	0.0047uF	25V	B	GRM36B472K25PT	K22148830		1-	A	A2
C 1529	CHIP CAP.	680pF	50V	B	GRM155B11H681KA01D	K22178807		1-	B	d3
C 1530	CHIP CAP.	0.0022uF	50V	B	GRM155B11H222KA01D	K22178813		1-	A	B2
C 1531	CHIP CAP.	330pF	50V	B	GRM155B11H331KA01D	K22178803		1-	B	d3
C 1532	CHIP CAP.	150pF	50V	CH	GRM1552C1H151JA01D	K22178240		1-	A	B2
C 1533	CHIP CAP.	150pF	50V	CH	GRM1552C1H151JA01D	K22178240		1-	A	B2
C 1534	CHIP CAP.	0.022uF	16V	B	GRM155B11C223KA01D	K22128806		1-	B	d3
C 1535	CHIP CAP.	1uF	6.3V	B	GRM155B30J105KE18D	K22088803		1-	A	B2
C 1536	CHIP CAP.	0.0047uF	25V	B	GRM36B472K25PT	K22148830		1-	B	d3
C 1537	CHIP CAP.	0.0068uF	25V	B	GRM155B11E682KA01D	K22148803		1-	B	d3
C 1538	CHIP CAP.	0.47uF	6.3V	B	GRM155B30J474KE18D	K22088802		1-	B	d3
C 1539	CHIP CAP.	0.001uF	50V	B	GRM155B11H102KA01D	K22178809		1-	B	d3
C 1540	CHIP CAP.	1uF	6.3V	B	GRM155B30J105KE18D	K22088803		1-	A	A2
C 1541	CHIP CAP.	0.0047uF	25V	B	GRM36B472K25PT	K22148830		1-	A	B2
C 1542	CHIP CAP.	0.0047uF	25V	B	GRM36B472K25PT	K22148830		1-	A	B2
C 1543	CHIP CAP.	0.0047uF	25V	B	GRM36B472K25PT	K22148830		1-	A	B2
C 1544	CHIP CAP.	0.1uF	10V	B	GRM155B11A104KA01D	K22108802		1-	A	A3
C 1545	CHIP CAP.	1uF	6.3V	B	GRM155B30J105KE18D	K22088803		1-	B	d2
C 1546	CHIP CAP.	0.01uF	25V	B	GRM155B11E103KA01D	K22148834		1-	A	A3
C 1547	CHIP CAP.	1uF	6.3V	B	GRM155B30J105KE18D	K22088803		1-	A	A2
C 1548	CHIP TA.CAP.	47uF	6.3V		TEESVAOJ476M8R	K78080085		1-	B	d2
C 1549	CHIP CAP.	1uF	6.3V	B	GRM155B30J105KE18D	K22088803		1-	B	d2
C 1550	CHIP CAP.	0.022uF	16V	B	GRM155B11C223KA01D	K22128806		1-	A	A2
C 1551	CHIP CAP.	0.022uF	16V	B	GRM155B11C223KA01D	K22128806		1-	A	A2
C 1552	CHIP CAP.	0.022uF	16V	B	GRM155B11C223KA01D	K22128806		1-	A	A2
C 1553	CHIP CAP.	0.022uF	16V	B	GRM155B11C223KA01D	K22128806		1-	A	A2
C 1554	CHIP CAP.	0.047uF	10V	B	GRM155B11A473KA01D	K22108801		1-	A	A2
C 1555	CHIP CAP.	0.047uF	10V	B	GRM155B11A473KA01D	K22108801		1-	A	A2
C 1556	CHIP CAP.	1uF	6.3V	B	GRM155B30J105KE18D	K22088803		1-	A	A2
C 1557	CHIP CAP.	0.0047uF	25V	B	GRM36B472K25PT	K22148830		1-	A	A2
C 1558	CHIP CAP.	0.0047uF	25V	B	GRM36B472K25PT	K22148830		1-	A	A2
C 1559	CHIP CAP.	1uF	6.3V	B	GRM155B30J105KE18D	K22088803		1-	A	A2
C 1560	CHIP CAP.	1uF	6.3V	B	GRM155B30J105KE18D	K22088803		1-	A	A2
C 1561	CHIP CAP.	1uF	6.3V	B	GRM155B30J105KE18D	K22088803		1-	A	A2
C 1562	CHIP TA.CAP.	33uF	10V		TEESVB21A336M8R	K78100047		1-	B	d2
C 1563	CHIP CAP.	1uF	6.3V	B	GRM155B30J105KE18D	K22088803		1-	A	A2
C 1564	CHIP CAP.	0.01uF	25V	B	GRM155B11E103KA01D	K22148834		1-	B	d3
C 1565	CHIP CAP.	1uF	6.3V	B	GRM155B30J105KE18D	K22088803		1-	B	d2
C 1566	CHIP TA.CAP.	3.3uF	16V		TEESVA1C335M8R	K78120021		1-	A	C3
C 1567	CHIP CAP.	0.01uF	25V	B	GRM155B11E103KA01D	K22148834		1-	B	d2
C 1568	CHIP CAP.	0.01uF	25V	B	GRM155B11E103KA01D	K22148834		1-	B	d2
C 1569	CHIP CAP.	0.1uF	10V	B	GRM155B11A104KA01D	K22108802		1-	B	d3
C 1570	CHIP CAP.	1uF	6.3V	B	GRM155B30J105KE18D	K22088803		1-	A	A2
C 1571	CHIP CAP.	1uF	6.3V	B	GRM155B30J105KE18D	K22088803		1-	B	d2
C 1572	CHIP CAP.	100pF	50V	CH	GRM1552C1H101JD01D	K22178236	W/ CE LABEL	5-8	A	A2
C 1572	CHIP CAP.	100pF	50V	CH	GRM1552C1H101JD01D	K22178236		9-	A	A2
C 1573	CHIP CAP.	15pF	50V	CH	GRM1552C1H150JZ01D	K22178216	W/ CE LABEL	7-	B	b3
C 1573	CHIP CAP.	15pF	50V	CH	GRM1552C1H150JZ01D	K22178216	W/O CE LABEL	7-	B	b3
C 1574	CHIP CAP.	22pF	50V	CH	GRM1552C1H220JZ01D	K22178220	W/ CE LABEL	7-	A	C3
C 1574	CHIP CAP.	22pF	50V	CH	GRM1552C1H220JZ01D	K22178220	W/O CE LABEL	7-	A	C3
C 1600	CHIP CAP.	12pF	50V	CH	GRM1552C1H120JZ01D	K22178214		1-	B	a3
C 1601	CHIP CAP.	6pF	50V	CH	GRM1552C1H6R0BZ01D	K22178293		1-	A	D3
C 1602	CHIP CAP.	8pF	50V	CH	GRM1552C1H8R0BZ01D	K22178295		1-	A	D3
C 1603	CHIP CAP.	0.001uF	50V	B	GRM155B11H102KA01D	K22178809		1-	A	D3
C 1604	CHIP CAP.	0.1uF	10V	B	GRM155B11A104KA01D	K22108802		1-	A	D3
C 1605	CHIP CAP.	0.1uF	10V	B	GRM155B11A104KA01D	K22108802		1-	A	D3
C 1606	CHIP CAP.	0.01uF	16V	B	GRM36B103K16PT	K22128804		1-	A	D3
C 1607	CHIP CAP.	24pF	50V	CH	GRM1552C1H240JZ01D	K22178221		1-	A	D3
C 1608	CHIP CAP.	0.01uF	16V	B	GRM36B103K16PT	K22128804		1-	A	D3
C 1610	CHIP CAP.	0.001uF	50V	B	GRM155B11H102KA01D	K22178809		1-	B	b2
C 1611	CHIP CAP.	0.01uF	16V	B	GRM36B103K16PT	K22128804		1-	B	a3
C 1612	CHIP CAP.	0.01uF	16V	B	GRM36B103K16PT	K22128804		1-	B	a3
C 1613	CHIP CAP.	0.01uF	16V	B	GRM36B103K16PT	K22128804		1-	B	a3
C 1614	CHIP CAP.	0.47uF	6.3V	B	GRM155B30J474KE18D	K22088802		1-	A	D4
C 1615	CHIP CAP.	82pF	50V	CH	GRM1552C1H820JD01D	K22178234		1-	B	a3
C 1616	CHIP CAP.	1pF	50V	CK	GRM1554C1H1R0BZ01D	K22178287		1-	B	a4
C 1617	CHIP CAP.	10pF	50V	CH	GRM1552C1H100BZ01D	K22178297		1-	B	a3
C 1618	CHIP CAP.	68pF	50V	CH	GRM1552C1H680JZ01D	K22178232		1-	B	a3
C 1619	CHIP CAP.	0.01uF	16V	B	GRM36B103K16PT	K22128804		1-	B	a3
C 1620	CHIP CAP.	0.1uF	10V	B	GRM155B11A104KA01D	K22108802		1-	B	a3
C 1621	CHIP CAP.	56pF	50V	CH	GRM1552C1H560JD01D	K22178230		1-	B	a3
C 1622	CHIP CAP.	15pF	50V	CH	GRM1552C1H150JZ01D	K22178216		1-	B	a3
C 1623	CHIP CAP.	7pF	50V	CH	GRM1552C1H7R0BZ01D	K22178294		1-	B	a4
C 1624	CHIP CAP.	12pF	50V	CH	GRM1552C1H120JZ01D	K22178214		1-	B	a3
C 1625	CHIP CAP.	33pF	50V	CH	GRM1552C1H330JZ01D	K22178224		1-	B	a3

REF	DESCRIPTION	VALUE	V/W	TOL.	MFR'S DESIG	VXSTD P/N	VERS.	LOT	SIDE	LAY ADR
C 1626	CHIP CAP.	47pF	50V	CH	GRM1552C1H470JZ01D	K22178228		1-	B	a3
C 1627	CHIP CAP.	33pF	50V	CH	GRM1552C1H330JZ01D	K22178224		1-	B	a4
C 1628	CHIP CAP.	0.01uF	16V	B	GRM36B103K16PT	K22128804		1-	B	a4
C 1629	CHIP CAP.	0.01uF	16V	B	GRM36B103K16PT	K22128804		1-	B	a4
C 1630	CHIP CAP.	0.01uF	16V	B	GRM36B103K16PT	K22128804		1-	B	a3
C 1631	CHIP CAP.	0.75pF	50V	CK	GRM1554C1HR75BZ01D	K22178286		1-	B	a4
C 1632	CHIP TA.CAP.	22uF	6.3V		TEESVA0J226M8R	K78080047		1-	A	D3
C 1633	CHIP CAP.	0.001uF	50V	B	GRM155B11H102KA01D	K22178809		1-	A	D3
C 1635	CHIP CAP.	100pF	50V	CH	GRM1552C1H101JD01D	K22178236		1-	B	a4
C 1636	CHIP CAP.	0.01uF	16V	B	GRM36B103K16PT	K22128804		1-	B	a4
C 1638	CHIP CAP.	0.01uF	16V	B	GRM36B103K16PT	K22128804		1-	A	D4
C 1639	CHIP TA.CAP.	10uF	10V		TAJA106M010Y	K78100072		1-	A	D4
C 1640	CHIP CAP.	0.01uF	16V	B	GRM36B103K16PT	K22128804		1-	A	D4
C 1641	CHIP CAP.	0.1uF	10V	B	GRM155B11A104KA01D	K22108802		1-	B	a4
C 1642	CHIP CAP.	0.1uF	10V	B	GRM155B11A104KA01D	K22108802		1-	A	D4
C 1643	CHIP CAP.	0.01uF	16V	B	GRM36B103K16PT	K22128804		1-	A	D4
C 1644	CHIP CAP.	0.1uF	10V	B	GRM155B11A104KA01D	K22108802		1-	A	D4
C 1645	CHIP CAP.	470pF	50V	B	GRM155B11H471KA01D	K22178805		1-	A	D4
C 1646	CHIP CAP.	470pF	50V	B	GRM155B11H471KA01D	K22178805		1-	A	D4
C 1647	CHIP CAP.	100pF	50V	CH	GRM1552C1H101JD01D	K22178236		1-	A	D4
C 1648	CHIP CAP.	0.01uF	16V	B	GRM36B103K16PT	K22128804		1-	A	D4
C 1649	CHIP CAP.	0.01uF	16V	B	GRM36B103K16PT	K22128804		1-	A	D4
C 1650	FILM CAP.	0.015uF	10V		ECHU01153JX5	K57100001		1-	B	a4
C 1651	CHIP CAP.	0.0012uF	50V	B	GRM155B11H122KA01	K22178810		1-	B	a4
C 1652	CHIP CAP.	0.1uF	10V	B	GRM155B11A104KA01D	K22108802		1-	A	D4
C 1653	CHIP CAP.	22pF	50V	CH	GRM1552C1H220JZ01D	K22178220		1-	A	D4
C 1654	CHIP CAP.	0.0047uF	25V	B	GRM36B472K25PT	K22148830		1-	A	D4
C 1655	CHIP CAP.	0.001uF	50V	B	GRM155B11H102KA01D	K22178809		1-	A	D4
C 1656	CHIP CAP.	1uF	6.3V	B	GRM155B30J105KE18D	K22088803		1-	A	C4
C 1657	CHIP CAP.	1uF	6.3V	B	GRM155B30J105KE18D	K22088803		1-	B	a4
C 1658	CHIP CAP.	0.001uF	50V	B	GRM155B11H102KA01D	K22178809		1-	B	a4
C 1659	CHIP CAP.	0.0056uF	25V	B	GRM155B11E562KA01D	K22148802		1-	B	a4
C 1660	CHIP CAP.	0.001uF	50V	B	GRM155B11H102KA01D	K22178809		1-	B	a4
C 1661	CHIP CAP.	1uF	6.3V	B	GRM155B30J105KE18D	K22088803		1-	B	a4
C 1662	CHIP CAP.	0.1uF	10V	B	GRM155B11A104KA01D	K22108802		1-	B	a4
C 1663	CHIP CAP.	0.1uF	10V	B	GRM155B11A104KA01D	K22108802		1-	B	a4
C 1664	CHIP CAP.	0.0022uF	50V	B	GRM155B11H222KA01D	K22178813		1-	B	a4
C 1665	CHIP CAP.	0.01uF	16V	B	GRM36B103K16PT	K22128804		1-	B	a4
C 1666	CHIP CAP.	0.1uF	10V	B	GRM155B11A104KA01D	K22108802		1-	B	a4
C 1667	CHIP CAP.	0.047uF	10V	B	GRM155B11A473KA01D	K22108801		1-	A	C4
C 1668	CHIP CAP.	0.01uF	16V	B	GRM36B103K16PT	K22128804		1-	A	C4
C 1669	CHIP CAP.	1uF	6.3V	B	GRM155B30J105KE18D	K22088803		1-	A	D4
C 1670	CHIP CAP.	1uF	6.3V	B	GRM155B30J105KE18D	K22088803		1-	A	D4
C 1671	CHIP CAP.	0.022uF	16V	B	GRM155B11C223KA01D	K22128806		1-	B	b4
C 1672	CHIP CAP.	0.022uF	16V	B	GRM155B11C223KA01D	K22128806		1-	B	b4
C 1673	CHIP CAP.	0.047uF	10V	B	GRM155B11A473KA01D	K22108801		1-	A	D4
C 1674	CHIP CAP.	0.047uF	10V	B	GRM155B11A473KA01D	K22108801		1-	A	D4
C 1675	CHIP CAP.	0.047uF	10V	B	GRM155B11A473KA01D	K22108801		1-	A	D4
C 1676	CHIP CAP.	680pF	50V	B	GRM155B11H681KA01D	K22178807		1-	B	b4
C 1677	CHIP CAP.	0.0047uF	25V	B	GRM36B472K25PT	K22148830		1-	B	b4
C 1678	CHIP CAP.	0.0047uF	25V	B	GRM36B472K25PT	K22148830		1-	A	C4
C 1679	CHIP CAP.	0.022uF	16V	B	GRM155B11C223KA01D	K22128806		1-	B	b4
C 1680	CHIP CAP.	470pF	50V	B	GRM155B11H471KA01D	K22178805		1-	A	C4
C 1681	CHIP CAP.	680pF	50V	B	GRM155B11H681KA01D	K22178807		1-	B	b4
C 1682	CHIP CAP.	0.1uF	10V	B	GRM155B11A104KA01D	K22108802		1-	A	D4
C 1683	CHIP CAP.	0.0022uF	50V	B	GRM155B11H222KA01D	K22178813		1-	A	D4
C 1684	CHIP CAP.	150pF	50V	CH	GRM1552C1H151JA01D	K22178240		1-	A	C4
C 1685	CHIP CAP.	330pF	50V	B	GRM155B11H331KA01D	K22178803		1-	B	b4
C 1686	CHIP CAP.	150pF	50V	CH	GRM1552C1H151JA01D	K22178240		1-	A	D4
C 1687	CHIP CAP.	0.0047uF	25V	B	GRM36B472K25PT	K22148830		1-	A	D4
C 1688	CHIP CAP.	1uF	6.3V	B	GRM155B30J105KE18D	K22088803		1-	A	C4
C 1689	CHIP CAP.	0.0047uF	25V	B	GRM36B472K25PT	K22148830		1-	A	C4
C 1690	CHIP CAP.	0.0047uF	25V	B	GRM36B472K25PT	K22148830		1-	A	C4
C 1691	CHIP CAP.	0.0068uF	25V	B	GRM155B11E682KA01D	K22148803		1-	B	c4
C 1692	CHIP CAP.	0.001uF	50V	B	GRM155B11H102KA01D	K22178809		1-	B	b4
C 1693	CHIP CAP.	1uF	6.3V	B	GRM155B30J105KE18D	K22088803		1-	A	C4
C 1694	CHIP CAP.	0.0047uF	25V	B	GRM36B472K25PT	K22148830		1-	B	c4
C 1695	CHIP TA.CAP.	22uF	6.3V		TEESVA0J226M8R	K78080047		1-	B	b4
C 1696	CHIP CAP.	0.47uF	6.3V	B	GRM155B30J474KE18D	K22088802		1-	B	c4
C 1697	CHIP CAP.	1uF	6.3V	B	GRM155B30J105KE18D	K22088803		1-	B	c4
C 1698	CHIP CAP.	0.0022uF	50V	B	GRM155B11H222KA01D	K22178813		1-	A	B4
C 1699	CHIP CAP.	100pF	50V	CH	GRM1552C1H101JD01D	K22178236		1-	B	c3
C 1700	CHIP CAP.	0.01uF	16V	B	GRM36B103K16PT	K22128804		1-	B	c4
C 1701	CHIP CAP.	0.0022uF	50V	B	GRM155B11H222KA01D	K22178813		1-	B	c4
C 1702	CHIP CAP.	0.01uF	16V	B	GRM36B103K16PT	K22128804		1-	B	c4

MAIN Unit

Parts List

REF	DESCRIPTION	VALUE	V/W	TOL.	MFR'S DESIG	VXSTD P/N	VERS.	LOT	SIDE	LAY ADR
C 1703	CHIP CAP.	1uF	6.3V	B	GRM155B30J105KE18D	K22088803		1-	A	B3
C 1704	CHIP CAP.	0.0047uF	50V	B	GRM155B11H472KA01D	K22178838		1-	A	A3
C 1705	CHIP TA.CAP.	22uF	6.3V	B	TEESVA0J226M8R	K78080047		1-	B	c3
C 1706	CHIP CAP.	0.01uF	16V	B	GRM36B103K16PT	K22128804		1-	B	c4
C 1707	CHIP CAP.	1uF	6.3V	B	GRM155B30J105KE18D	K22088803		1-	B	c4
C 1708	CHIP CAP.	0.0033uF	50V	B	GRM155B11H332KA01D	K22178815		1-	B	c4
C 1709	CHIP CAP.	0.01uF	16V	B	GRM36B103K16PT	K22128804		1-	B	c4
C 1710	CHIP TA.CAP.	6.8uF	16V	B	TEESVA1C685M8R	K78120056		1-	A	B4
C 1711	CHIP CAP.	0.1uF	10V	B	GRM155B11A104KA01D	K22108802		1-	A	B4
C 1712	CHIP CAP.	56pF	50V	CH	GRM1552C1H560JD01D	K22178230		1-	B	a4
C 1713	CHIP CAP.	1uF	6.3V	B	GRM155B30J105KE18D	K22088803		1-	B	c4
C 1750	CHIP CAP.	1uF	6.3V	B	GRM155B30J105KE18D	K22088803		1-	B	d2
C 1751	CHIP CAP.	1uF	6.3V	B	GRM155B30J105KE18D	K22088803		1-	B	d2
C 1752	CHIP CAP.	0.022uF	16V	B	GRM155B11C223KA01D	K22128806		1-	B	d2
C 1753	CHIP CAP.	0.022uF	16V	B	GRM155B11C223KA01D	K22128806		1-	B	d2
C 1754	CHIP CAP.	0.1uF	10V	B	GRM155B11A104KA01D	K22108802		1-	B	d2
C 1755	CHIP CAP.	0.1uF	10V	B	GRM155B11A104KA01D	K22108802		1-	A	A2
C 1756	CHIP CAP.	0.1uF	10V	B	GRM155B11A104KA01D	K22108802		1-	B	d2
C 1757	CHIP CAP.	0.1uF	10V	B	GRM155B11A104KA01D	K22108802		1-	B	d2
C 1758	CHIP CAP.	0.047uF	10V	B	GRM155B11A473KA01D	K22108801		1-	B	d1
C 1760	CHIP CAP.	0.001uF	50V	B	GRM155B11H102KA01D	K22178809		1-	B	d1
C 1762	AL.ELECTRO.CAP.	220uF	16V		EMVA160ADA221MF80G	K48120021		1-	A	A1
C 1763	CHIP CAP.	100pF	50V	CH	GRM1552C1H101JD01D	K22178236		1-	B	d1
C 1764	AL.ELECTRO.CAP.	100uF	10V		RVZ-10V101MF55U-R2	K48100008		1-	A	A1
C 1765	AL.ELECTRO.CAP.	470uF	10V		RVZ-10V471M	K48100010		1-	A	A1
C 1766	CHIP CAP.	1uF	6.3V	B	GRM155B30J105KE18D	K22088803		1-	B	d1
C 1768	AL.ELECTRO.CAP.	470uF	10V		RVZ-10V471M	K48100010		1-	A	A1
C 1769	CHIP CAP.	0.001uF	50V	B	GRM155B11H102KA01D	K22178809		1-	B	d1
C 1770	CHIP CAP.	0.001uF	50V	B	GRM155B11H102KA01D	K22178809		1-	B	d1
C 1771	CHIP CAP.	0.001uF	50V	B	GRM155B11H102KA01D	K22178809		1-	B	d1
C 1772	CHIP CAP.	1uF	6.3V	B	GRM155B30J105KE18D	K22088803		1-	B	d1
C 1773	CHIP CAP.	0.001uF	50V	B	GRM155B11H102KA01D	K22178809		1-	B	d1
C 1774	CHIP CAP.	0.001uF	50V	B	GRM155B11H102KA01D	K22178809		1-	B	c5
C 1775	CHIP CAP.	0.001uF	50V	B	GRM155B11H102KA01D	K22178809		1-	B	c5
C 1776	CHIP CAP.	1uF	6.3V	B	GRM155B30J105KE18D	K22088803		1-	B	d1
C 1777	CHIP TA.CAP.	10uF	10V		TAJA106M010Y	K78100072		1-	B	d2
C 1778	CHIP TA.CAP.	10uF	10V		TAJA106M010Y	K78100072		1-	B	d1
C 1779	AL.ELECTRO.CAP.	100uF	10V		RVZ-10V101MF55U-R2	K48100008		1-	A	A1
C 1780	CHIP CAP.	0.001uF	50V	B	GRM155B11H102KA01D	K22178809		1-	B	d3
C 1781	CHIP CAP.	0.001uF	50V	B	GRM155B11H102KA01D	K22178809		1-	B	b4
C 1784	CHIP CAP.	0.001uF	50V	B	GRM155B11H102KA01D	K22178809		1-	A	C4
C 1786	CHIP CAP.	0.1uF	10V	B	GRM155B11A104KA01D	K22108802		1-	B	c2
C 1787	CHIP CAP.	0.1uF	10V	B	GRM155B11A104KA01D	K22108802		1-	B	d2
C 1788	CHIP CAP.	0.22uF	10V	B	GRM155B31A224KE18D	K22108808		1-	B	b4
C 1789	CHIP CAP.	0.001uF	50V	B	GRM155B11H102KA01D	K22178809		1-	A	C4
C 1790	CHIP CAP.	470pF	50V	B	GRM155B11H471KA01D	K22178805		1-	A	C4
C 1791	CHIP CAP.	0.022uF	16V	B	GRM155B11C223KA01D	K22128806		1-	A	C4
C 1792	CHIP CAP.	0.022uF	16V	B	GRM155B11C223KA01D	K22128806		1-	A	C4
C 1793	CHIP CAP.	0.01uF	16V	B	GRM36B103K16PT	K22128804		1-	A	C4
C 1794	CHIP CAP.	0.001uF	50V	B	GRM155B11H102KA01D	K22178809		1-	A	C4
C 1795	CHIP TA.CAP.	10uF	10V		TEESVA1A106M8R	K78100028		1-	A	C4
C 1796	CHIP CAP.	0.001uF	50V	B	GRM155B11H102KA01D	K22178809		1-	A	C4
C 1797	CHIP CAP.	15pF	50V	CH	GRM1552C1H150GZ01	K22178300		1-	A	C4
C 1798	CHIP CAP.	0.001uF	50V	B	GRM155B11H102KA01D	K22178809		1-	A	C4
C 1799	CHIP CAP.	0.1uF	10V	B	GRM155B11A104KA01D	K22108802		1-	A	C4
C 1800	CHIP CAP.	0.001uF	50V	B	GRM155B11H102KA01D	K22178809		1-	A	D4
C 1801	CHIP CAP.	0.001uF	50V	B	GRM155B11H102KA01D	K22178809		1-	A	D4
C 1802	CHIP CAP.	0.001uF	50V	B	GRM155B11H102KA01D	K22178809		1-	A	C4
C 1803	CHIP CAP.	0.001uF	50V	B	GRM155B11H102KA01D	K22178809		1-	A	C4
C 1804	CHIP CAP.	0.001uF	50V	B	GRM155B11H102KA01D	K22178809		1-	B	a4
C 1805	CHIP CAP.	0.1uF	16V	B	GRM188B11C104KA01D	K22124805		1-	B	c1
C 1806	CHIP CAP.	0.1uF	16V	B	GRM188B11C104KA01D	K22124805		1-	B	c1
C 1807	CHIP CAP.	0.1uF	10V	B	GRM155B11A104KA01D	K22108802		1-	B	c1
C 1808	CHIP CAP.	0.001uF	50V	B	GRM155B11H102KA01D	K22178809		1-	A	D5
C 1809	CHIP CAP.	1uF	16V	B	C1608JB1C105KT	K22124813		1-	B	d4
C 1810	CHIP CAP.	0.001uF	50V	B	GRM155B11H102KA01D	K22178809		1-	A	D4
C 1811	CHIP CAP.	47pF	50V	CH	GRM1552C1H470JZ01D	K22178228		1-	B	c1
C 1812	CHIP CAP.	47pF	50V	CH	GRM1552C1H470JZ01D	K22178228		1-	B	c1
C 1813	CHIP CAP.	47pF	50V	CH	GRM1552C1H470JZ01D	K22178228		1-	B	c1
C 1814	CHIP CAP.	47pF	50V	CH	GRM1552C1H470JZ01D	K22178228		1-	B	c1
C 1815	CHIP CAP.	47pF	50V	CH	GRM1552C1H470JZ01D	K22178228		1-	B	c1
C 1816	CHIP CAP.	47pF	50V	CH	GRM1552C1H470JZ01D	K22178228		1-	B	c1
C 1817	CHIP CAP.	0.001uF	50V	B	GRM155B11H102KA01D	K22178809		1-	A	B1
C 1818	CHIP TA.CAP.	22uF	16V		TEESVB21C226M8R	K78120028		1-	B	d2
C 1819	CHIP CAP.	1uF	10V	F	GRM188F11A105ZA01D	K22105001		1-	B	c2

REF	DESCRIPTION	VALUE	V/W	TOL.	MFR'S DESIG	VXSTD P/N	VERS.	LOT	SIDE	LAY ADR
C 1820	CHIP CAP.	0.001uF	50V	B	GRM155B11H102KA01D	K22178809		1-	B	b1
C 1821	CHIP CAP.	0.001uF	50V	B	GRM155B11H102KA01D	K22178809		1-	A	B2
C 1822	CHIP TA.CAP.	47uF	6.3V		TEESVB20J476M8R	K78080048		1-	B	d2
C 1823	CHIP CAP.	7pF	50V	CH	GRM1552C1H7R0BZ01D	K22178294		1-	B	d3
C 1824	AL.ELECTRO.CAP.	100uF	16V		EEE1CA101WP	K48120012		1-	A	A1
C 1825	CHIP CAP.	0.001uF	50V	B	GRM155B11H102KA01D	K22178809		1-	B	d1
C 1826	CHIP CAP.	0.001uF	50V	B	GRM155B11H102KA01D	K22178809		1-	A	B1
C 1827	CHIP CAP.	0.001uF	50V	B	GRM155B11H102KA01D	K22178809		1-	A	B1
C 1828	AL.ELECTRO.CAP.	2200uF	16V		RJ5-16V222M	K40129101		1-	A	B1
C 1829	CHIP CAP.	0.01uF	16V	B	GRM36B103K16PT	K22128804		1-	B	d3
C 1830	CHIP CAP.	0.001uF	50V	B	GRM155B11H102KA01D	K22178809		1-	B	e3
C 1831	CHIP CAP.	0.001uF	50V	B	GRM155B11H102KA01D	K22178809		1-	B	d3
C 1832	CHIP TA.CAP.	22uF	6.3V		TEESVA0J226M8R	K78080047		1-	B	d3
C 1833	CHIP CAP.	0.001uF	50V	B	GRM155B11H102KA01D	K22178809		1-	B	d4
C 1834	CHIP CAP.	1uF	6.3V	B	GRM155B30J105KE18D	K22088803		1-	B	d3
C 1835	CHIP CAP.	0.001uF	50V	B	GRM155B11H102KA01D	K22178809		1-	B	d2
C 1836	AL.ELECTRO.CAP.	100uF	16V		EEE1CA101WP	K48120012		1-	A	A2
C 1837	CHIP CAP.	22pF	50V	CH	GRM1552C1H220JZ01D	K22178220		1-	A	A4
C 1838	CHIP CAP.	2pF	50V	CK	GRM1554C1H2R0BZ01D	K22178289		1-	B	d4
C 1839	CHIP CAP.	22pF	50V	CH	GRM1552C1H220JZ01D	K22178220		1-	A	A4
C 1840	CHIP TA.CAP.	10uF	10V		TEESVA1A106M8R	K78100028		1-	B	d4
C 1841	CHIP CAP.	0.001uF	50V	B	GRM155B11H102KA01D	K22178809		1-	B	d4
C 1842	CHIP CAP.	0.047uF	10V	B	GRM155B11A473KA01D	K22108801		1-	B	d4
C 1843	CHIP CAP.	0.047uF	10V	B	GRM155B11A473KA01D	K22108801		1-	B	d4
C 1844	CHIP CAP.	0.1uF	10V	B	GRM155B11A104KA01D	K22108802		1-	B	d3
C 1845	CHIP CAP.	47pF	50V	CH	GRM1552C1H470JZ01D	K22178228		1-	B	c1
C 1846	CHIP TA.CAP.	10uF	10V		TEESVA1A106M8R	K78100028		1-	A	C4
C 1860	CHIP CAP.	0.1uF	10V	B	GRM155B11A104KA01D	K22108802		1-	B	d3
C 1861	CHIP CAP.	0.001uF	50V	B	GRM155B11H102KA01D	K22178809		1-	A	B3
C 1862	CHIP TA.CAP.	47uF	6.3V		TEESVA0J476M8R	K78080085		1-	A	B3
C 1863	CHIP TA.CAP.	10uF	10V		TEESVA1A106M8R	K78100028		1-	B	c3
C 1864	CHIP CAP.	0.1uF	10V	B	GRM155B11A104KA01D	K22108802		1-	A	B3
C 1865	CHIP TA.CAP.	47uF	4V		SK7-0G476M-RA	K78060048		1-	A	B5
C 1866	CHIP CAP.	22pF	50V	CH	GRM1552C1H220JZ01D	K22178220		1-	A	A4
C 1867	CHIP CAP.	1uF	6.3V	B	GRM155B30J105KE18D	K22088803		1-	A	A4
C 1868	CHIP CAP.	1uF	6.3V	B	GRM155B30J105KE18D	K22088803		1-	A	B5
C 1869	CHIP CAP.	22pF	50V	CH	GRM1552C1H220JZ01D	K22178220		1-	A	B5
C 1870	CHIP CAP.	22pF	50V	CH	GRM1552C1H220JZ01D	K22178220		1-	A	A4
C 1871	CHIP CAP.	0.0068uF	25V	B	GRM155B11E682KA01D	K22148803		1-	A	B4
C 1872	CHIP CAP.	0.0056uF	25V	B	GRM155B11E562KA01D	K22148802		1-	A	B4
C 1873	CHIP CAP.	0.0068uF	25V	B	GRM155B11E682KA01D	K22148803		1-	A	B4
C 1874	CHIP CAP.	0.0056uF	25V	B	GRM155B11E562KA01D	K22148802		1-	A	B4
C 1876	CHIP CAP.	470pF	50V	CH	GRM1882C1H471JA01D	K22174249		1-	A	B4
C 1877	CHIP CAP.	10pF	50V	CH	GRM1552C1H100BZ01D	K22178297		1-	A	B4
C 1878	CHIP CAP.	820pF	50V	B	GRM155B11H821KA01D	K22178808		1-	A	B4
C 1879	CHIP CAP.	47pF	50V	CH	GRM1552C1H470JZ01D	K22178228		1-	A	B4
C 1880	CHIP CAP.	0.0012uF	50V	B	GRM155B11H122KA01	K22178810		1-4	A	B4
C 1880	CHIP CAP.	0.0012uF	50V	CH	GRM1882C1H122JA01D	K22174276	W/ CE LABEL	5-8	A	B4
C 1880	CHIP CAP.	0.0012uF	50V	B	GRM155B11H122KA01	K22178810	W/O CE LABEL	5-8	A	B4
C 1880	CHIP CAP.	0.0012uF	50V	CH	GRM1882C1H122JA01D	K22174276		9-	A	B4
C 1881	CHIP CAP.	36pF	50V	CH	GRM1552C1H360JZ01D	K22178225		1-	A	B4
C 1882	CHIP CAP.	0.001uF	50V	B	GRM155B11H102KA01D	K22178809		1-4	A	B4
C 1882	CHIP CAP.	0.001uF	50V	CH	GRM1882C1H102JA01D	K22174275	W/ CE LABEL	5-8	A	B4
C 1882	CHIP CAP.	0.001uF	50V	B	GRM155B11H102KA01D	K22178809	W/O CE LABEL	5-8	A	B4
C 1882	CHIP CAP.	0.001uF	50V	CH	GRM1882C1H102JA01D	K22174275		9-	A	B4
C 1883	CHIP CAP.	560pF	50V	B	GRM155B11H561KD01	K22178806		1-4	A	B4
C 1883	CHIP CAP.	560pF	50V	CH	GRM1882C1H561JA01D	K22174273	W/ CE LABEL	5-8	A	B4
C 1883	CHIP CAP.	560pF	50V	B	GRM155B11H561KD01	K22178806	W/O CE LABEL	5-8	A	B4
C 1883	CHIP CAP.	560pF	50V	CH	GRM1882C1H561JA01D	K22174273		9-	A	B4
C 1884	CHIP CAP.	0.1uF	10V	B	GRM155B11A104KA01D	K22108802		1-	A	B4
C 1885	CHIP CAP.	15pF	50V	CH	GRM1552C1H150GZ01	K22178300		1-	A	B4
C 1886	CHIP CAP.	1uF	6.3V	B	GRM155B30J105KE18D	K22088803		1-	A	B4
C 1887	CHIP CAP.	1uF	6.3V	B	GRM155B30J105KE18D	K22088803		1-	A	B4
C 1888	CHIP TA.CAP.	10uF	10V		TEESVA1A106M8R	K78100028		1-	B	b3
C 1889	CHIP TA.CAP.	47uF	6.3V		TEESVA0J476M8R	K78080085		1-	B	a3
C 1890	CHIP CAP.	0.001uF	50V	B	GRM155B11H102KA01D	K22178809		1-	B	b3
C 1891	CHIP CAP.	0.0047uF	25V	B	GRM36B472K25PT	K22148830		1-	A	B4
C 1892	CHIP CAP.	0.001uF	50V	B	GRM155B11H102KA01D	K22178809		1-	B	b2
C 1893	CHIP CAP.	0.001uF	50V	B	GRM155B11H102KA01D	K22178809		1-	B	a2
C 1894	CHIP CAP.	0.001uF	50V	B	GRM155B11H102KA01D	K22178809		1-	B	a2
C 1895	CHIP CAP.	0.001uF	50V	B	GRM155B11H102KA01D	K22178809		1-	A	C4
C 1896	CHIP CAP.	0.001uF	50V	B	GRM155B11H102KA01D	K22178809		1-	B	a2
C 1897	CHIP CAP.	0.001uF	50V	B	GRM155B11H102KA01D	K22178809		1-	B	a2
C 1898	CHIP CAP.	0.001uF	50V	B	GRM155B11H102KA01D	K22178809		1-	B	b3
C 1899	CHIP CAP.	0.001uF	50V	B	GRM155B11H102KA01D	K22178809		1-	A	C2

MAIN Unit

Parts List

REF	DESCRIPTION	VALUE	V/W	TOL.	MFR'S DESIG	VXSTD P/N	VERS.	LOT	SIDE	LAY ADR
C 1900	CHIP CAP.	0.1uF	10V	B	GRM155B11A104KA01D	K22108802		1-	A	A2
C 1901	CHIP CAP.	0.001uF	50V	B	GRM155B11H102KA01D	K22178809		1-	B	d3
C 1902	CHIP CAP.	0.1uF	10V	B	GRM155B11A104KA01D	K22108802		1-	B	d4
C 1903	CHIP CAP.	0.01uF	25V	B	GRM155B11E103KA01D	K22148834		1-	A	A4
C 1904	CHIP CAP.	0.01uF	25V	B	GRM155B11E103KA01D	K22148834		1-	A	A4
C 1905	CHIP CAP.	0.001uF	50V	B	GRM155B11H102KA01D	K22178809		1-	B	a2
C 1907	CHIP CAP.	0.01uF	25V	B	GRM155B11E103KA01D	K22148834		1-	A	B1
C 1908	CHIP CAP.	0.1uF	10V	B	GRM155B11A104KA01D	K22108802		1-	B	c1
C 1909	CHIP CAP.	10pF	200V	CH	GRM1882C2D100JV01D	K22234212		1-	B	a1
C 1910	CHIP CAP.	10pF	200V	CH	GRM1882C2D100JV01D	K22234212		1-	B	a1
C 1911	CHIP CAP.	10pF	200V	CH	GRM1882C2D100JV01D	K22234212		1-	B	a1
C 1912	CHIP CAP.	1pF	200V	CK	GRM1884C2D1R0CV01D	K22234203		1-	B	a1
C 1914	CHIP CAP.	0.1uF	25V	B	GRM21BB11E104KA01L	K22140811		1-	A	B2
C 1915	CHIP CAP.	5pF	50V	CH	GRM1552C1H5R0BZ01D	K22178292		1-	A	C1
C 1917	CHIP CAP.	100pF	50V	UJ	GRM1552C1H101JZ01D	K22178323		1-	A	C4
C 1918	CHIP CAP.	47pF	50V	CH	GRM1552C1H470JZ01D	K22178228		1-	B	a4
C 1919	CHIP CAP.	390pF	50V	B	GRM155B11H391KD01D	K22178804		1-	B	a4
C 1920	CHIP CAP.	0.001uF	50V	B	GRM155B11H102KA01D	K22178809		1-	B	a4
C 1921	CHIP CAP.	22pF	50V	CH	GRM1552C1H220JZ01D	K22178220		1-	B	c4
C 1922	CHIP CAP.	22pF	50V	CH	GRM1552C1H220JZ01D	K22178220		1-	B	c4
C 1923	CHIP CAP.	0.1uF	10V	B	GRM155B11A104KA01D	K22108802		1-	B	c4
C 1924	CHIP CAP.	1uF	6.3V	B	GRM155B30J105KE18D	K22088803		1-	A	B4
C 1925	CHIP CAP.	100pF	50V	CH	GRM1552C1H101JZ01D	K22178236		1-	B	c4
C 1926	CHIP CAP.	0.033uF	10V	B	GRM155B11A333KA01D	K22108803		1-	B	d4
C 1927	CHIP CAP.	0.001uF	50V	B	GRM155B11H102KA01D	K22178809		1-	A	B4
C 1928	CHIP CAP.	0.022uF	16V	B	GRM155B11C223KA01D	K22128806		1-	B	c5
C 1929	CHIP TA.CAP.	10uF	10V		TEESVA1A106M8R	K78100028		1-	B	c4
C 1930	CHIP TA.CAP.	10uF	10V		TEESVA1A106M8R	K78100028		1-	B	c4
C 1931	CHIP CAP.	0.1uF	10V	B	GRM155B11A104KA01D	K22108802		1-	B	c4
C 1932	CHIP CAP.	0.1uF	10V	B	GRM155B11A104KA01D	K22108802		1-	B	c4
C 1933	CHIP CAP.	0.1uF	10V	B	GRM155B11A104KA01D	K22108802		1-	B	c5
C 1934	CHIP CAP.	0.01uF	25V	B	GRM155B11E103KA01D	K22148834		1-	A	B4
C 1935	CHIP CAP.	0.1uF	10V	B	GRM155B11A104KA01D	K22108802		1-	A	A3
C 1936	CHIP CAP.	0.1uF	10V	B	GRM155B11A104KA01D	K22108802		1-	A	A3
C 1937	CHIP CAP.	0.001uF	50V	B	GRM155B11H102KA01D	K22178809		1-	A	C3
C 1938	CHIP TA.CAP.	10uF	10V		TEESVA1A106M8R	K78100028		1-	B	d4
C 1939	CHIP CAP.	0.001uF	50V	B	GRM155B11H102KA01D	K22178809		1-	B	d4
C 1940	CHIP CAP.	33pF	50V	CH	GRM1552C1H330JZ01D	K22178224		1-	B	d5
C 1941	CHIP TA.CAP.	47uF	4V		SK7-0G476M-RA	K78060048		1-	A	A4
C 1942	CHIP CAP.	0.001uF	50V	B	GRM155B11H102KA01D	K22178809		1-	A	D4
C 1943	CHIP CAP.	0.001uF	50V	B	GRM155B11H102KA01D	K22178809		1-	A	D4
CD1450	CERAMIC DISC				JTBM450CX24	H7901530		1-	A	B2
CD1600	CERAMIC DISC				JTBM450CX24	H7901530		1-	A	D4
CF1450	CERAMIC FILTER				SFECF10M7GA00-R0	H3900577		1-	B	c2
CF1451	CERAMIC FILTER				LTM450EW	H3900574		1-	A	B3
CF1600	CERAMIC FILTER				SFECF10M7GA00-R0	H3900577		1-	B	a3
CF1601	CERAMIC FILTER				LTM450EW	H3900574		1-	B	a4
D 1001	DIODE				HVC131TRF-E	G2070676		1-	B	a2
D 1002	DIODE				HSC277TRF-E	G2070584		1-	B	a2
D 1003	DIODE				HVC350B-TRF-E	G2070596		1-	A	D2
D 1004	DIODE				HVC350B-TRF-E	G2070596		1-	A	D2
D 1005	DIODE				HVC350B-TRF-E	G2070596		1-	A	D2
D 1006	DIODE				HSC277TRF-E	G2070584		1-	B	a2
D 1007	DIODE				HVC131TRF-E	G2070676		1-	B	b3
D 1008	DIODE				HVC131TRF-E	G2070676		1-	A	C3
D 1009	DIODE				HVC131TRF-E	G2070676		1-	B	a2
D 1010	DIODE				HSC277TRF-E	G2070584		1-	B	a2
D 1011	DIODE				HVC350B-TRF-E	G2070596		1-	B	a2
D 1012	DIODE				HVC350B-TRF-E	G2070596		1-	B	a2
D 1013	DIODE				HVC350B-TRF-E	G2070596		1-	B	a2
D 1014	DIODE				HVC131TRF-E	G2070676		1-	B	a3
D 1015	DIODE				HVC131TRF-E	G2070676		1-	B	a3
D 1016	DIODE				HVC131TRF-E	G2070676		1-	A	C1
D 1017	DIODE				HVC365 TRF-E	G2070902		1-	A	C2
D 1018	DIODE				HVC365 TRF-E	G2070902		1-	A	C2
D 1019	DIODE				HVC365 TRF-E	G2070902		1-	A	C2
D 1020	DIODE				HVC131TRF-E	G2070676		1-	A	C3
D 1021	DIODE				HVC365 TRF-E	G2070902		1-	A	D2
D 1022	DIODE				HVC365 TRF-E	G2070902		1-	A	D2
D 1023	DIODE				HVC365 TRF-E	G2070902		1-	A	D2
D 1024	DIODE				HVC131TRF-E	G2070676		1-	A	D3
D 1025	DIODE				HVC131TRF-E	G2070676		1-	A	C3
D 1026	DIODE				HVC131TRF-E	G2070676		1-	A	D3
D 1027	DIODE				HVC131TRF-E	G2070676		1-	A	D1
D 1028	DIODE				DAN222 TL	G2070174		1-	A	D2

MAIN Unit

Parts List

REF	DESCRIPTION	VALUE	V/W	TOL.	MFR'S DESIG	VXSTD P/N	VERS.	LOT	SIDE	LAY ADR
D 1029	DIODE				HVC355B TRF-E	G2070588		1-	B	b2
D 1030	DIODE				HVC355B TRF-E	G2070588		1-	B	b3
D 1031	DIODE				HVC131TRF-E	G2070676		1-	B	b3
D 1032	DIODE				HVC355B TRF-E	G2070588		1-	A	D2
D 1033	DIODE				HVC355B TRF-E	G2070588		1-	A	D2
D 1034	DIODE				HVC131TRF-E	G2070676		1-	A	D3
D 1035	DIODE				HVC355B TRF-E	G2070588		1-	B	a2
D 1036	DIODE				HVC355B TRF-E	G2070588		1-	A	D2
D 1201	SURGE ABSORBER				RHCA-301Q43U	Q9000827		1-	A	D1
D 1202	DIODE				RLS135 TE-11	G2070128		1-	B	a1
D 1203	DIODE				RLS135 TE-11	G2070128		1-	B	a1
D 1204	DIODE				L709CER	G2071124		1-	B	a1
D 1205	DIODE				L709CER	G2071124		1-	B	a1
D 1206	DIODE				MA2S72800L	G2070858		1-	A	D1
D 1207	DIODE				MA2S72800L	G2070858		1-	A	D1
D 1208	DIODE				UDZS TE-17 5.1B	G2070908		1-	B	a2
D 1209	DIODE				1SS400 TE61	G2070634		1-	B	b1
D 1210	DIODE				HSC277TRF-E	G2070584		1-	A	C3
D 1211	DIODE				HVC131TRF-E	G2070676		1-	A	C3
D 1212	DIODE				1SS400 TE61	G2070634		1-	B	b1
D 1213	DIODE				HVC131TRF-E	G2070676		1-	A	C1
D 1214	DIODE				HVC131TRF-E	G2070676		1-	A	C1
D 1215	DIODE				1SS400 TE61	G2070634		1-	B	b1
D 1216	DIODE				HVC131TRF-E	G2070676		1-	A	C3
D 1217	DIODE				MA2S72800L	G2070858		1-	B	b1
D 1218	DIODE				MA2S72800L	G2070858		1-	B	b1
D 1219	DIODE				UDZS TE-17 5.1B	G2070908		1-	B	b2
D 1220	DIODE				HSC277TRF-E	G2070584		1-	A	C3
D 1221	DIODE				HVC131TRF-E	G2070676		1-	A	B3
D 1222	SURGE ABSORBER				RHCA-301Q43U	Q9000827		1-	A	D1
D 1223	SURGE ABSORBER				RHCA-301Q43U	Q9000827		1-	B	c1
D 1224	DIODE				HVC131TRF-E	G2070676		1-	A	C1
D 1301	DIODE				HSC277TRF-E	G2070584		1-	B	a3
D 1302	DIODE				HVC375B-TRF-E	G2070856		1-	B	a3
D 1303	DIODE				HVC375B-TRF-E	G2070856		1-	B	a3
D 1304	DIODE				HSC277TRF-E	G2070584		1-	A	D3
D 1305	DIODE				HSC277TRF-E	G2070584		1-	A	D3
D 1306	DIODE				HSC277TRF-E	G2070584		1-	B	a3
D 1307	DIODE				HVC365 TRF-E	G2070902		1-	B	a3
D 1308	DIODE				HVC365 TRF-E	G2070902		1-	B	a3
D 1309	DIODE				DA221 TL	G2070178		1-	A	D3
D 1310	DIODE				DA221 TL	G2070178		1-	B	a4
D 1311	DIODE				HVC365 TRF-E	G2070902		1-	A	D4
D 1312	DIODE				HVC365 TRF-E	G2070902		1-	A	D4
D 1313	DIODE				HSC277TRF-E	G2070584		1-	B	b3
D 1314	DIODE				HVC375B-TRF-E	G2070856		1-	B	b3
D 1315	DIODE				HVC375B-TRF-E	G2070856		1-	B	b3
D 1316	DIODE				HSC277TRF-E	G2070584		1-	A	C3
D 1317	DIODE				HSC277TRF-E	G2070584		1-	A	C3
D 1318	DIODE				HSC277TRF-E	G2070584		1-	B	b3
D 1319	DIODE				HVC365 TRF-E	G2070902		1-	B	b3
D 1320	DIODE				HVC365 TRF-E	G2070902		1-	B	b3
D 1321	DIODE				DA221 TL	G2070178		1-	A	C3
D 1322	DIODE				DA221 TL	G2070178		1-	B	b4
D 1323	DIODE				HVC365 TRF-E	G2070902		1-	B	b4
D 1324	DIODE				HVC350B-TRF-E	G2070596		1-	A	C4
D 1325	DIODE				DA221 TL	G2070178		1-	A	B2
D 1450	DIODE				HSC277TRF-E	G2070584		1-	A	C2
D 1451	DIODE				HSC277TRF-E	G2070584		1-	B	b2
D 1452	DIODE				1SS400 TE61	G2070634		1-	A	B2
D 1453	DIODE				1SS400 TE61	G2070634		1-	A	B2
D 1454	DIODE				1SS400 TE61	G2070634		1-	A	B2
D 1455	DIODE				HSC277TRF-E	G2070584		1-	B	c3
D 1456	DIODE				HSC277TRF-E	G2070584		1-	B	c3
D 1457	DIODE				1SS400 TE61	G2070634		1-	B	c3
D 1459	DIODE				1SS400 TE61	G2070634		1-	B	c3
D 1460	DIODE				UDZS TE-17 5.1B	G2070908		1-	A	B3
D 1461	DIODE				1SS400 TE61	G2070634		1-	B	c3
D 1463	DIODE				1SS400 TE61	G2070634		1-	B	c3
D 1464	DIODE				MC2850-T111-1	G2070704		1-	B	c2
D 1465	DIODE				MC2850-T111-1	G2070704		1-	B	c2
D 1466	DIODE				DAN222 TL	G2070174		1-	A	B2
D 1467	DIODE				DA221 TL	G2070178		1-	B	d3
D 1600	DIODE				HSC277TRF-E	G2070584		1-	A	D3
D 1601	DIODE				HSC277TRF-E	G2070584		1-	B	a3

MAIN Unit

Parts List

REF	DESCRIPTION	VALUE	V/W	TOL.	MFR'S DESIG	VXSTD P/N	VERS.	LOT	SIDE	LAY ADR
D 1602	DIODE				1SS400 TE61	G2070634		1-	A	D3
D 1603	DIODE				1SS400 TE61	G2070634		1-	A	D3
D 1604	DIODE				1SS400 TE61	G2070634		1-	A	D3
D 1605	DIODE				HSC277TRF-E	G2070584		1-	B	a4
D 1606	DIODE				HSC277TRF-E	G2070584		1-	B	a4
D 1607	DIODE				1SS400 TE61	G2070634		1-	A	D4
D 1609	DIODE				1SS400 TE61	G2070634		1-	A	D4
D 1610	DIODE				UDZS TE-17 5.1B	G2070908		1-	A	C4
D 1611	DIODE				1SS400 TE61	G2070634		1-	A	D4
D 1613	DIODE				1SS400 TE61	G2070634		1-	A	D4
D 1614	DIODE				MC2850-T111-1	G2070704		1-	B	a4
D 1615	DIODE				MC2850-T111-1	G2070704		1-	B	a4
D 1616	DIODE				DAN222 TL	G2070174		1-	A	D4
D 1617	DIODE				DA221 TL	G2070178		1-	B	c4
D 1750	DIODE				1SS400 TE61	G2070634		1-	B	c4
D 1751	DIODE				1SS400 TE61	G2070634		1-	B	c4
D 1752	DIODE				UDZS TE-17 5.6B	G2070910		1-	A	C4
D 1753	DIODE				UDZS TE-17 5.6B	G2070910		1-	A	C4
D 1754	DIODE				UDZS TE-17 5.6B	G2070910		1-	A	D5
D 1755	DIODE				UDZS TE-17 5.6B	G2070910		1-	A	D4
D 1757	SURGE ABSORBER				P6KA18A-E3	Q9000721		1-	A	B1
D 1758	DIODE				1SS400 TE61	G2070634		1-	B	d3
D 1759	DIODE				1SS400 TE61	G2070634		1-	B	d3
D 1760	DIODE				1SS400 TE61	G2070634		1-	B	d3
D 1761	DIODE				1SS400 TE61	G2070634		1-	B	d2
D 1762	DIODE				1SS400 TE61	G2070634		1-	B	d3
D 1801	DIODE				UDZS TE-17 5.6B	G2070910		1-	B	c1
D 1802	DIODE				UDZS TE-17 5.6B	G2070910		1-	B	c1
D 1804	DIODE				UDZS TE-17 5.6B	G2070910		1-	B	d4
D 1860	DIODE				DAN222 TL	G2070174		1-	A	B4
D 1861	DIODE				DAN222 TL	G2070174		1-	A	A4
D 1862	DIODE				DAN222 TL	G2070174		1-	A	A4
D 1863	DIODE				HVC365 TRF-E	G2070902		1-	A	C4
D 1864	DIODE				HSC277TRF-E	G2070584		1-	B	a4
D 1865	DIODE				1SS400 TE61	G2070634		1-	B	c4
D 1866	DIODE				HSC277TRF-E	G2070584		1-	B	d4
D 1867	DIODE				HSC277TRF-E	G2070584		1-	B	d4
F 1001	CHIP FUSE	1A			FCC10 102ABTP	Q0000120	W/ CE LABEL	5-	A	D4
FB1201	FERRITE BEADS				SMB304729	L9190094		1-	B	c1
FB1202	CHIP COIL				BLM21PG300SN1D	L1690840		1-	A	B2
FB1750	CHIP COIL				BLM21PG300SN1D	L1690840		1-	B	d1
FB1751	CHIP COIL				BLM21PG300SN1D	L1690840		1-	B	d1
FB1752	CHIP COIL				BLM21PG300SN1D	L1690840		1-	B	d1
FB1753	FERRITE BEADS				BLM15AG121SN1D	L1690843		1-	B	d1
FB1754	FERRITE BEADS				BLM15AG121SN1D	L1690843		1-	B	d1
FB1755	FERRITE BEADS				BLM15AG121SN1D	L1690843		1-	B	d1
FB1756	FERRITE BEADS				BLM15AG121SN1D	L1690843		1-	A	B5
FB1757	FERRITE BEADS				BLM15AG121SN1D	L1690843		1-	A	B5
FB1758	FERRITE BEADS				BLM15AG121SN1D	L1690843		1-	A	D4
FB1759	FERRITE BEADS				BLM15AG121SN1D	L1690843		1-	A	D4
FB1760	FERRITE BEADS				BLM15AG121SN1D	L1690843		1-	B	a4
FB1761	FERRITE BEADS				BLM15AG121SN1D	L1690843		1-	B	a4
FB1762	FERRITE BEADS				BLM15AG121SN1D	L1690843		1-	A	D4
FB1763	FERRITE BEADS				BLM15AG121SN1D	L1690843		1-	A	D4
FB1764	FERRITE BEADS				BLM15AG121SN1D	L1690843		1-	A	D4
FB1765	FERRITE BEADS				BLM15AG121SN1D	L1690843		1-	A	D4
FB1766	FERRITE BEADS				BLM15AG121SN1D	L1690843		1-	A	C4
FB1767	FERRITE BEADS				BLM15AG121SN1D	L1690843		1-	A	C4
FB1768	FERRITE BEADS				BLM15AG121SN1D	L1690843		1-	A	C4
FB1769	FERRITE BEADS				BLM15AG121SN1D	L1690843		1-	A	C4
FB1770	FERRITE BEADS				BLM15AG121SN1D	L1690843		1-	A	C4
FB1771	FERRITE BEADS				BLM15AG121SN1D	L1690843		1-	A	C4
FB1773	FERRITE BEADS				BLM15AG121SN1D	L1690843		1-	B	c1
FB1774	FERRITE BEADS				BLM15AG121SN1D	L1690843		1-	B	c1
FB1775	FERRITE BEADS				BLM15AG121SN1D	L1690843		1-	B	c1
FB1776	FERRITE BEADS				BLM15AG121SN1D	L1690843		1-	B	c1
FB1777	FERRITE BEADS				BLM15AG121SN1D	L1690843		1-	B	c1
FB1778	FERRITE BEADS				BLM15AG121SN1D	L1690843		1-	B	c1
FB1779	FERRITE BEADS				BLM15AG121SN1D	L1690843		1-	B	c1
FB1780	CHIP COIL				BLM21PG300SN1D	L1690840		1-	A	B1
FB1781	FERRITE BEADS				SMB304729	L9190094		1-	A	B1
FB1782	FERRITE BEADS				SMB304729	L9190094		1-	A	B1
FB1783	FERRITE BEADS				BLM15AG121SN1D	L1690843		1-	B	c1
J 1101	SHIELD FINGER				4025 3100089	S5000225		1-	B	a2
J 1102	SHIELD FINGER				4025 3100089	S5000225		1-	B	a2

REF	DESCRIPTION	VALUE	V/W	TOL.	MFR'S DESIG	VXSTD P/N	VERS.	LOT	SIDE	LAY ADR
J 1103	SHIELD FINGER				4025 3100089	S5000225		1-	B	a1
J 1750	CONNECTOR				HSJ0912-01-020	P1091302		1-	A	A1
J 1751	CONNECTOR				HSJ0912-01-040	P1091129		1-	A	A1
J 1752	CONNECTOR				BM02B-SRSS-TBT(LF)(SN)	P0091465		1-	A	B4
J 1753	CONNECTOR				MJV0808KX06	P1091355		1-	B	a5
J 1754	CONNECTOR				MJV0606KX06-H	P1091386		1-	B	b5
J 1755	CONNECTOR				MD-S8000-70(LF)(SN)	P1090877		1-4	A	B1
J 1755	CONNECTOR				MD-S8100-90	P1091417	W/ CE LABEL	5-	A	B1
J 1755	CONNECTOR				MD-S8000-70(LF)(SN)	P1090877	W/O CE LABEL	5-	A	B1
J 1860	CONNECTOR				AXK6S40635P	P0091323		1-	A	A3
L 1001	M.RFC	0.01uH		2%	C1608CB-10NG-RF	L1691032		1-	B	a2
L 1002	M.RFC	0.039uH		2%	C1608CB-39NG-RF	L1691039		1-	B	a2
L 1003	M.RFC	0.01uH			TFL0510-10N	L1690811		1-	B	a2
L 1004	M.RFC	0.1uH			TFL0816-100N	L1690981		1-	A	D2
L 1005	M.RFC	0.01uH		2%	C1608CB-10NG-RF	L1691032		1-	A	D2
L 1006	COIL				E2 0.28-1.0-4T-R	L0022365		1-	A	D2
L 1007	COIL				E2 0.28-1.0-4T-R	L0022365		1-	A	D2
L 1008	M.RFC	0.01uH		2%	C1608CB-10NG-RF	L1691032		1-	B	a2
L 1009	M.RFC	0.015uH			TFL0816-15	L1690493		1-	B	b2
L 1010	M.RFC	0.015uH			TFL0816-15	L1690493		1-	B	b2
L 1011	M.RFC	0.015uH			TFL0816-15	L1690493		1-	A	C3
L 1012	M.RFC	0.039uH		2%	C1608CB-39NG-RF	L1691039		1-	B	a2
L 1013	M.RFC	0.01uH			TFL0510-10N	L1690811		1-	B	a2
L 1014	M.RFC	0.1uH			TFL0816-100N	L1690981		1-	B	a2
L 1015	M.RFC	0.01uH		2%	C1608CB-10NG-RF	L1691032		1-	B	a2
L 1016	COIL				E2 0.28-1.0-4T-R	L0022365		1-	B	a2
L 1017	COIL				E2 0.28-1.0-4T-R	L0022365		1-	B	a2
L 1018	M.RFC	0.015uH			TFL0816-15	L1690493		1-	B	a2
L 1019	M.RFC	0.015uH			TFL0816-15	L1690493		1-	B	a2
L 1020	M.RFC	0.015uH			TFL0816-15	L1690493		1-	B	a2
L 1021	M.RFC	0.056uH		2%	C1608CB-56NG-RF	L1691041		1-	A	C1
L 1022	M.RFC	0.039uH		2%	C1608CB-39NG-RF	L1691039	AUSTRALIA	1-	A	C1
L 1022	M.RFC	0.039uH		2%	C1608CB-39NG-RF	L1691039	EUROPE	1-	A	C1
L 1022	M.RFC	0.039uH		2%	C1608CB-39NG-RF	L1691039	EXPORT	1-	A	C1
L 1022	M.RFC	0.039uH		2%	C1608CB-39NG-RF	L1691039	USA	1-	A	C1
L 1023	M.RFC	0.15uH		2%	C1608CB-R15G-RF	L1691101	AUSTRALIA	1-	A	C1
L 1023	M.RFC	0.15uH		2%	C1608CB-R15G-RF	L1691101	EUROPE	1-	A	C1
L 1023	M.RFC	0.15uH		2%	C1608CB-R15G-RF	L1691101	EXPORT	1-	A	C1
L 1023	M.RFC	0.15uH		2%	C1608CB-R15G-RF	L1691101	USA	1-	A	C1
L 1024	M.RFC	1uH			LK1608 1R0K-T	L1690687		1-	A	C2
L 1025	M.RFC	0.082uH		2%	C1608CB-82NG-RF	L1691044		1-	A	C2
L 1026	M.RFC	0.082uH		2%	C1608CB-82NG-RF	L1691044		1-	A	C2
L 1027	M.RFC	0.082uH		2%	C1608CB-82NG-RF	L1691044		1-	A	C2
L 1028	M.RFC	0.047uH			TFL0816-47	L1690499		1-	A	C3
L 1029	M.RFC	0.1uH		2%	C1608CB-R10G-RF	L1691045		1-	A	C1
L 1030	M.RFC	0.039uH		2%	C1608CB-39NG-RF	L1691039		1-	A	C1
L 1031	M.RFC	0.082uH		2%	C1608CB-82NG-RF	L1691044		1-	A	C1
L 1032	M.RFC	1uH			LK1608 1R0K-T	L1690687		1-	A	D2
L 1033	M.RFC	0.082uH		2%	C1608CB-82NG-RF	L1691044		1-	A	D2
L 1034	M.RFC	0.082uH		2%	C1608CB-82NG-RF	L1691044		1-	A	D2
L 1035	M.RFC	0.082uH		2%	C1608CB-82NG-RF	L1691044		1-	A	D2
L 1036	M.RFC	0.047uH			TFL0816-47	L1690499		1-	A	D3
L 1037	M.RFC	0.068uH		2%	C1608CB-68NG-RF	L1691042		1-	A	C1
L 1038	M.RFC	0.033uH		2%	C1608CB-33NG-RF	L1691038	AUSTRALIA	1-	A	C1
L 1038	M.RFC	0.033uH		2%	C1608CB-33NG-RF	L1691038	EUROPE	1-	A	C1
L 1038	M.RFC	0.033uH		2%	C1608CB-33NG-RF	L1691038	EXPORT	1-	A	C1
L 1038	M.RFC	0.033uH		2%	C1608CB-33NG-RF	L1691038	USA	1-	A	C1
L 1039	M.RFC	0.056uH		2%	C1608CB-56NG-RF	L1691041		1-	A	C1
L 1040	M.RFC	0.033uH		2%	C1608CB-33NG-RF	L1691038		1-	A	C1
L 1041	M.RFC	0.082uH		2%	C1608CB-82NG-RF	L1691044		1-	A	C1
L 1042	M.RFC	0.047uH		2%	C1608CB-47NG-RF	L1691040		1-	A	C2
L 1043	M.RFC	0.047uH		2%	C1608CB-47NG-RF	L1691040		1-	A	C2
L 1044	M.RFC	0.047uH		2%	C1608CB-47NG-RF	L1691040		1-	A	D2
L 1045	M.RFC	0.047uH		2%	C1608CB-47NG-RF	L1691040		1-	A	D2
L 1046	M.RFC	0.39uH		2%	C1608CB-R39G-RF	L1691107		1-	A	D1
L 1047	COIL				E2 0.3-1.1-3T-R	L0022579		1-	B	a1
L 1048	M.RFC	0.0082uH			TFL0816-8N2	L1690490		1-	A	D1
L 1049	M.RFC	0.012uH			TFL0816-12	L1690492		1-	A	D1
L 1050	M.RFC	0.0056uH			TFL0816-5N6	L1690488		1-	A	D1
L 1051	M.RFC	0.0056uH			TFL0816-5N6	L1690488		1-	A	D2
L 1052	M.RFC	0.0056uH			TFL0816-5N6	L1690488		1-	B	a2
L 1053	M.RFC	0.0039uH			TFL0816-3N9	L1690486		1-	B	b2
L 1054	M.RFC	0.0056uH			TFL0816-5N6	L1690488		1-	B	b3
L 1055	M.RFC	0.01uH			TFL0816-10	L1690491		1-	B	b3
L 1056	M.RFC	0.0056uH			TFL0816-5N6	L1690488		1-	A	D2

MAIN Unit

Parts List

REF	DESCRIPTION	VALUE	V/W	TOL.	MFR'S DESIG	VXSTD P/N	VERS.	LOT	SIDE	LAY ADR
L 1057	M.RFC	0.0056uH			TFL0816-5N6	L1690488		1-	A	D2
L 1058	M.RFC	0.0039uH			TFL0816-3N9	L1690486		1-	A	D2
L 1059	M.RFC	0.0056uH			TFL0816-5N6	L1690488		1-	A	D2
L 1060	M.RFC	0.01uH			TFL0816-10	L1690491		1-	A	D2
L 1061	M.RFC	0.1uH			TFL0816-100N	L1690981		1-	B	b1
L 1062	M.RFC	0.1uH			TFL0816-100N	L1690981		1-	B	b1
L 1201	COIL	0.01uH			AS1003-10NK	L0022544		1-	B	a1
L 1202	COIL	0.015uH			AS100440-15N	L0022811		1-	B	a1
L 1203	COIL	0.015uH			AS100440-15N	L0022811		1-	B	a1
L 1204	COIL	0.014uH			AS050425-14NK	L0022583		1-	B	a1
L 1205	COIL	0.015uH			AS100440-15N	L0022811		1-	B	a1
L 1206	COIL				E2 0.4-3.0-6.5T-L	L0022644		1-	B	a1
L 1207	M.RFC	0.012uH		2%	C1608CB-12NG-RF	L1691033		1-	A	D3
L 1208	M.RFC	0.01uH		2%	C1608CB-10NG-RF	L1691032		1-	A	C3
L 1209	COIL	0.033uH			AS1005-33NK	L0022546		1-	B	a1
L 1210	COIL				E2 0.3-1.4-6T-L	L0022455		1-	A	C1
L 1211	COIL	0.022uH			AS1004-22NK	L0022545		1-	B	b1
L 1212	COIL	0.033uH			AS1005-33NK	L0022546		1-	B	b1
L 1213	COIL				E2 0.28-1.0-7TR	L0022422		1-	A	C1
L 1214	COIL				E2 0.28-1.0-7TR	L0022422		1-	A	C1
L 1215	M.RFC	0.047uH			TFL0816-47	L1690499		1-	B	b3
L 1216	M.RFC	0.068uH			TFL0816-68	L1690501		1-	A	C3
L 1217	COIL				E2 0.28-1.0-6T-R	L0022366		1-	A	C1
L 1218	M.RFC	0.39uH		2%	C1608CB-R39G-RF	L1691107		1-	A	C1
L 1219	COIL				E2 0.28-1.0-7TR	L0022422		1-	A	C1
L 1221	M.RFC	0.033uH			TFL0816-33	L1690497		1-	A	C2
L 1222	M.RFC	0.033uH			TFL0816-33	L1690497		1-	B	c2
L 1223	M.RFC	0.1uH		2%	C1608CB-R10G-RF	L1691045		1-	B	b1
L 1224	M.RFC	0.1uH		2%	C1608CB-R10G-RF	L1691045		1-	B	b1
L 1301	M.RFC	0.15uH		2%	C1608CB-R15G-RF	L1691101		1-	A	B1
L 1302	M.RFC	0.1uH		2%	C1608CB-R10G-RF	L1691045		1-	A	B1
L 1303	M.RFC	2.2uH			LK1608 2R2K-T	L1690634		1-	A	B1
L 1305	M.RFC	10uH		2%	KQ1008TE100G	L1691216		1-	A	B1
L 1306	COIL RF	278uH			#P613AN-0557Z=P3	L0022998		1-	A	B1
L 1307	M.RFC	2.2uH			LK1608 2R2K-T	L1690634		1-	B	c2
L 1308	M.RFC	0.22uH		2%	C1608CB-R22G-RF	L1691103		1-	A	B1
L 1309	M.RFC	2.2uH			LK1608 2R2K-T	L1690634		1-	B	c2
L 1310	M.RFC	0.39uH		2%	C1608CB-R39G-RF	L1691107		1-	A	D3
L 1311	M.RFC	1uH			LK1608 1R0K-T	L1690687		1-	A	D3
L 1312	M.RFC	0.022uH			TFL0816-22	L1690495		1-	B	a3
L 1313	COIL				E2 0.3-1.1-3T-R	L0022579		1-	B	a3
L 1314	M.RFC	0.0047uH			TFL0816-4N7	L1690487		1-	B	a3
L 1315	M.RFC	1uH			LK1608 1R0K-T	L1690687		1-	B	a3
L 1316	M.RFC	0.15uH			LK1608 R15K-T	L1690409		1-	B	a3
L 1317	CHIP COIL	0.033uH		2%	LQW2BHN33NG03L	L1691222		1-	B	a3
L 1318	M.RFC	0.022uH		2%	C1608CB-22NG-RF	L1691036		1-	B	a3
L 1319	M.RFC	0.39uH		2%	C1608CB-R39G-RF	L1691107		1-	A	D3
L 1320	M.RFC	1uH			LK1608 1R0K-T	L1690687		1-	A	D3
L 1321	M.RFC	1uH			LK1608 1R0K-T	L1690687		1-	B	a3
L 1322	M.RFC	0.39uH		2%	C1608CB-R39G-RF	L1691107		1-	A	C3
L 1323	M.RFC	1uH			LK1608 1R0K-T	L1690687		1-	A	C3
L 1324	M.RFC	0.022uH			TFL0816-22	L1690495		1-	B	b3
L 1325	COIL				E2 0.3-1.1-3T-R	L0022579		1-	B	b3
L 1326	M.RFC	0.0047uH			TFL0816-4N7	L1690487		1-	B	b3
L 1327	M.RFC	1uH			LK1608 1R0K-T	L1690687		1-	B	b3
L 1328	M.RFC	0.15uH			LK1608 R15K-T	L1690409		1-	B	b3
L 1329	CHIP COIL	0.033uH		2%	LQW2BHN33NG03L	L1691222		1-	B	b3
L 1330	M.RFC	0.022uH		2%	C1608CB-22NG-RF	L1691036		1-	B	b3
L 1331	M.RFC	1uH			LK1608 1R0K-T	L1690687		1-	A	C3
L 1332	M.RFC	1uH			LK1608 1R0K-T	L1690687		1-	B	b3
L 1333	M.RFC	1uH			LK1608 1R0K-T	L1690687		1-	B	b1
L 1334	M.RFC	0.39uH		2%	C1608CB-R39G-RF	L1691107		1-	A	C3
L 1450	M.RFC	0.39uH		2%	C1608CB-R39G-RF	L1691107		1-	A	C2
L 1451	M.RFC	0.39uH		2%	C1608CB-R39G-RF	L1691107		1-	A	B2
L 1452	M.RFC	0.22uH		2%	C1608CB-R22G-RF	L1691103		1-	B	b2
L 1453	M.RFC	0.22uH		2%	C1608CB-R22G-RF	L1691103		1-	B	c3
L 1454	M.RFC	0.39uH		2%	C1608CB-R39G-RF	L1691107		1-	B	b2
L 1455	M.RFC	0.22uH		2%	C1608CB-R22G-RF	L1691103		1-	B	c3
L 1456	M.RFC	0.39uH		2%	C1608CB-R39G-RF	L1691107		1-	B	c3
L 1457	M.RFC	4.7uH			LK1608 4R7K-T	L1690688		1-	B	c3
L 1458	M.RFC	10uH		2%	KQ1008TE100G	L1691216		1-	A	B2
L 1600	M.RFC	0.39uH		2%	C1608CB-R39G-RF	L1691107		1-	A	D3
L 1601	M.RFC	0.39uH		2%	C1608CB-R39G-RF	L1691107		1-	A	D3
L 1602	M.RFC	0.22uH		2%	C1608CB-R22G-RF	L1691103		1-	B	a3
L 1603	M.RFC	0.22uH		2%	C1608CB-R22G-RF	L1691103		1-	B	a3

REF	DESCRIPTION	VALUE	V/W	TOL.	MFR'S DESIG	VXSTD P/N	VERS.	LOT	SIDE	LAY ADR
L 1604	M.RFC	0.39uH		2%	C1608CB-R39G-RF	L1691107		1-	B	a3
L 1605	M.RFC	0.22uH		2%	C1608CB-R22G-RF	L1691103		1-	B	a3
L 1606	M.RFC	0.18uH		2%	C1608CB-R18G-RF	L1691102		1-	B	a4
L 1607	M.RFC	4.7uH			LK1608 4R7K-T	L1690688		1-	B	a4
L 1608	M.RFC	10uH		2%	KQ1008TE100G	L1691216		1-	B	a4
L 1609	M.RFC	0.047uH			TFL0816-47	L1690499		1-	B	a4
L 1750	M.RFC	1uH			LK1608 1R0K-T	L1690687		1-	B	d2
L 1751	M.RFC	1uH			LK1608 1R0K-T	L1690687		1-	A	D4
L 1752	M.RFC	1uH			LK1608 1R0K-T	L1690687		1-	A	D4
L 1753	M.RFC	6.8uH		2%	KQ1008TE6R8G	L1691214		1-	B	d4
L 1754	M.RFC	1uH			LK1608 1R0K-T	L1690687		1-	B	d4
L 1860	M.RFC	1uH			LK1608 1R0K-T	L1690687		1-	A	A4
L 1861	CHIP COIL	1uH		2%	C2520C-1R0G-RA	L1691309		1-	B	a4
Q 1001	FET				3SK296ZQ-TL-E	G4802968		1-	B	a2
Q 1002	FET				3SK296ZQ-TL-E	G4802968		1-	A	D3
Q 1003	TRANSISTOR				2SC5006-T1	G3350068		1-	B	b3
Q 1004	FET				3SK296ZQ-TL-E	G4802968		1-	B	a2
Q 1005	FET				3SK296ZQ-TL-E	G4802968		1-	B	a2
Q 1006	TRANSISTOR				2SC5006-T1	G3350068		1-	B	a2
Q 1007	FET				3SK296ZQ-TL-E	G4802968		1-	A	C2
Q 1008	FET				3SK296ZQ-TL-E	G4802968		1-	A	C3
Q 1009	FET				3SK296ZQ-TL-E	G4802968		1-	A	C2
Q 1010	FET				3SK296ZQ-TL-E	G4802968		1-	A	D3
Q 1011	FET				3SK296ZQ-TL-E	G4802968		1-	A	C1
Q 1012	TRANSISTOR				2SC5006-T1	G3350068		1-	A	C3
Q 1013	FET				3SK296ZQ-TL-E	G4802968		1-	A	C1
Q 1014	TRANSISTOR				2SC5006-T1	G3350068		1-	A	D3
Q 1015	TRANSISTOR				2SC5277-D2-TL	G3352778B		1-	A	D1
Q 1016	TRANSISTOR				2SC5006-T1	G3350068		1-	A	D2
Q 1017	TRANSISTOR				2SC5006-T1	G3350068		1-	B	b3
Q 1018	TRANSISTOR				2SC5006-T1	G3350068		1-	A	D2
Q 1019	TRANSISTOR				2SC5006-T1	G3350068		1-	A	D2
Q 1201	IC				RA60H4047M1-101	G1094556		1-	B	b1
Q 1202	TRANSISTOR				2SC3356-T2B R24	G3333567D		1-	A	D3
Q 1203	TRANSISTOR				UMD5N TR	G3070343		1-	B	b1
Q 1205	TRANSISTOR				DTC143EE TL	G3070114		1-	B	b1
Q 1206	TRANSISTOR				UMD5N TR	G3070343		1-	B	b1
Q 1207	TRANSISTOR				DTC144EE TL	G3070075		1-	B	b1
Q 1208	IC				RA60H1317M1A-101	G1094554		1-	B	c1
Q 1209	TRANSISTOR				2SC5006-T1	G3350068		1-	A	C3
Q 1211	FET				RQA0004PXDQS	G3070391		1-	B	b1
Q 1212	TRANSISTOR				2SC5006-T1	G3350068		1-	A	C2
Q 1213	TRANSISTOR				2SB1132 T100 R	G3211327R		1-	A	C2
Q 1214	TRANSISTOR				UMX1N TN	G3070324		1-	A	B2
Q 1215	IC				LM2904PWR	G1094010		1-	B	b1
Q 1216	TRANSISTOR				UMD5N TR	G3070343		1-	A	B2
Q 1301	FET				3SK296ZQ-TL-E	G4802968		1-	A	B1
Q 1302	TRANSISTOR				2SC4617 TL R	G3346178R		1-	A	B2
Q 1303	IC				LV24100LP-TLM-E	G1094371		1-	A	B2
Q 1304	TRANSISTOR				2SC5006-T1	G3350068		1-	A	E3
Q 1305	TRANSISTOR				2SC5006-T1	G3350068		1-	A	E3
Q 1306	TRANSISTOR				2SC5006-T1	G3350068		1-	B	a3
Q 1307	TRANSISTOR				2SC5006-T1	G3350068		1-	B	a3
Q 1308	TRANSISTOR				2SC5006-T1	G3350068		1-	A	D3
Q 1309	TRANSISTOR				UMG8N TR	G3070145		1-	A	D3
Q 1310	TRANSISTOR				2SC5006-T1	G3350068		1-	B	a3
Q 1311	TRANSISTOR				2SC5006-T1	G3350068		1-	B	a3
Q 1312	TRANSISTOR				DTC114TE TL	G3070225		1-	A	D3
Q 1313	IC				MB15A02PFV1-G-BND-EFE1	G1092541		1-	A	D3
Q 1314	TRANSISTOR				2SA1774 TL R	G3117748R		1-	B	a4
Q 1315	TRANSISTOR				2SC4617 TL R	G3346178R		1-	A	E4
Q 1316	TRANSISTOR				2SC5006-T1	G3350068		1-	A	C3
Q 1317	TRANSISTOR				2SC5006-T1	G3350068		1-	A	C3
Q 1318	TRANSISTOR				2SC5006-T1	G3350068		1-	B	b3
Q 1319	TRANSISTOR				2SC5006-T1	G3350068		1-	B	b3
Q 1320	TRANSISTOR				2SC5006-T1	G3350068		1-	A	C3
Q 1321	TRANSISTOR				2SC5006-T1	G3350068		1-	B	c3
Q 1322	TRANSISTOR				2SC5006-T1	G3350068		1-	B	b3
Q 1323	TRANSISTOR				DTC144EE TL	G3070075		1-	A	C3
Q 1324	IC				MB15A02PFV1-G-BND-EFE1	G1092541		1-	A	C3
Q 1325	TRANSISTOR				2SA1774 TL R	G3117748R		1-	B	b4
Q 1326	TRANSISTOR				2SC4617 TL R	G3346178R		1-	A	C4
Q 1327	TRANSISTOR				DTC144EE TL	G3070075		1-	A	C3
Q 1328	IC				TC7S66FU(TE85R.F)	G1092116	W/ CE LABEL	5-8	A	A2
Q 1328	IC				TC7S66FU(TE85R.F)	G1092116		9-	A	A2

MAIN Unit

Parts List

REF	DESCRIPTION	VALUE	V/W	TOL.	MFR'S DESIG	VXSTD P/N	VERS.	LOT	SIDE	LAY ADR
Q 1450	TRANSISTOR				2SC5006-T1	G3350068		1-	A	B2
Q 1451	TRANSISTOR				2SC4915-O(TE85L.F)	G3349158O		1-	B	c3
Q 1452	TRANSISTOR				2SC4915-O(TE85L.F)	G3349158O		1-	B	b2
Q 1453	TRANSISTOR				2SC4915-O(TE85L.F)	G3349158O		1-	B	c2
Q 1454	TRANSISTOR				2SC4617 TL R	G3346178R		1-	B	c2
Q 1455	TRANSISTOR				DTC144EE TL	G3070075		1-	B	c2
Q 1456	TRANSISTOR				2SC4915-O(TE85L.F)	G3349158O		1-	B	c3
Q 1457	IC				NJM2552V-TE1	G1094382		1-	B	c2
Q 1458	TRANSISTOR				DTA144EE TL	G3070074		1-	A	B2
Q 1459	TRANSISTOR				DTA144EE TL	G3070074		1-	B	c3
Q 1460	TRANSISTOR				DTA114EE TL	G3070263		1-	A	B3
Q 1462	TRANSISTOR				DTA114EE TL	G3070263		1-	A	B3
Q 1463	TRANSISTOR				DTA144EE TL	G3070074		1-	A	B2
Q 1464	TRANSISTOR				DTC144EE TL	G3070075		1-	A	B2
Q 1465	TRANSISTOR				2SC4617 TL R	G3346178R		1-	B	c2
Q 1466	TRANSISTOR				UMG2N TR	G3070088		1-	B	d2
Q 1467	TRANSISTOR				DTC144EE TL	G3070075		1-	B	d3
Q 1468	TRANSISTOR				2SC4617 TL R	G3346178R		1-	B	d2
Q 1469	IC				M61529FP	G1094557		1-	A	A2
Q 1470	IC				LM2904PWR	G1094010		1-	B	d2
Q 1471	IC				CD4066BPWR	G1093865		1-	A	A2
Q 1472	IC				CD4053BPWR	G1093864		1-	A	A2
Q 1473	IC				LM2902PWR	G1094009		1-	A	B2
Q 1474	IC				LM2902PWR	G1094009		1-	B	d3
Q 1475	TRANSISTOR				2SC4617 TL R	G3346178R		1-	B	d2
Q 1476	TRANSISTOR				DTC144EE TL	G3070075	W/ CE LABEL	5-8	A	B3
Q 1476	TRANSISTOR				DTC144EE TL	G3070075		9-	A	B3
Q 1600	TRANSISTOR				2SC5006-T1	G3350068		1-	A	D3
Q 1601	TRANSISTOR				2SC4915-O(TE85L.F)	G3349158O		1-	B	a3
Q 1602	TRANSISTOR				2SC4617 TL R	G3346178R		1-	A	D4
Q 1603	TRANSISTOR				DTC144EE TL	G3070075		1-	A	D4
Q 1604	TRANSISTOR				2SC4915-O(TE85L.F)	G3349158O		1-	B	a3
Q 1605	TRANSISTOR				2SC4915-O(TE85L.F)	G3349158O		1-	B	a4
Q 1606	TRANSISTOR				2SC4915-O(TE85L.F)	G3349158O		1-	B	a3
Q 1607	TRANSISTOR				DTC144EE TL	G3070075		1-	A	B3
Q 1608	TRANSISTOR				DTA114EE TL	G3070263		1-	A	C4
Q 1609	IC				NJM2552V-TE1	G1094382		1-	A	D4
Q 1611	TRANSISTOR				DTA114EE TL	G3070263		1-	B	b4
Q 1612	TRANSISTOR				DTA144EE TL	G3070074		1-	A	D4
Q 1613	TRANSISTOR				DTA144EE TL	G3070074		1-	B	b4
Q 1614	TRANSISTOR				DTA144EE TL	G3070074		1-	A	D4
Q 1615	TRANSISTOR				DTC144EE TL	G3070075		1-	A	D4
Q 1616	TRANSISTOR				2SC4617 TL R	G3346178R		1-	B	a4
Q 1617	TRANSISTOR				UMG2N TR	G3070088		1-	A	C4
Q 1618	TRANSISTOR				DTC144EE TL	G3070075		1-	B	b4
Q 1619	IC				BU9253FS-E2	G1094359		1-	B	c4
Q 1620	IC				CD4053BPWR	G1093864		1-	A	B4
Q 1621	IC				M62429FP-CF0R	G1093655		1-	A	B4
Q 1622	IC				LM2902PWR	G1094009		1-	A	C4
Q 1623	IC				LM2902PWR	G1094009		1-	B	b4
Q 1624	TRANSISTOR				DTC144EE TL	G3070075	W/ CE LABEL	5-8	A	C4
Q 1624	TRANSISTOR				DTC144EE TL	G3070075		9-	A	C4
Q 1750	FET				2SK397300L	G3839738		1-	B	d2
Q 1751	FET				2SK397300L	G3839738		1-	B	d2
Q 1752	FET				2SK397300L	G3839738		1-	B	d1
Q 1753	TRANSISTOR				DTC144EE TL	G3070075		1-	B	e1
Q 1754	TRANSISTOR				2SC4617 TL R	G3346178R		1-	B	d1
Q 1755	IC				TDA1519CTH	G1093778		1-	B	d1
Q 1756	TRANSISTOR				2SC4617 TL R	G3346178R		1-	B	d2
Q 1757	TRANSISTOR				2SC4617 TL R	G3346178R		1-	B	d1
Q 1758	TRANSISTOR				UMX1N TN	G3070324		1-	B	d1
Q 1759	TRANSISTOR				2SB1132 T100 R	G3211327R		1-	B	d1
Q 1760	IC				TDA2822D013TR	G1091542		1-	B	d1
Q 1761	IC				ADM101EARMZ-REEL7	G1092913		1-	B	c1
Q 1762	TRANSISTOR				DTA144EE TL	G3070074		1-	B	c1
Q 1763	TRANSISTOR				DTC144EE TL	G3070075		1-	B	c2
Q 1764	IC				XC6201P332MR	G1093946		1-	B	c2
Q 1765	IC				S-35190A-T8T1G	G1094356		1-	B	d3
Q 1766	IC				BA09CC0FP(TAPE)	G1094432		1-	B	d2
Q 1767	IC				NJM78M05DL1A-TE1	G1093660		1-	B	d2
Q 1768	TRANSISTOR				DTC144EE TL	G3070075		1-	B	d1
Q 1769	TRANSISTOR				2SB1301-T2 ZQ/ZP	G3213017Q		1-	B	d1
Q 1770	TRANSISTOR				2SC4617 TL R	G3346178R		1-	B	d3
Q 1771	IC				NJM2370U05-TE1	G1094563		1-	B	d3
Q 1772	IC				S-80835CNMC-B8U-T2-G	G1093606		1-	B	d3

MAIN Unit

Parts List

REF	DESCRIPTION	VALUE	V/W	TOL.	MFR'S DESIG	VXSTD P/N	VERS.	LOT	SIDE	LAY ADR
Q 1773	IC				CD4053BPWR	G1093864		1-	B	d4
Q 1774	IC				CD4053BPWR	G1093864		1-	B	d4
Q 1775	IC				M24512-RDW6TP	G1094562		1-	A	A3
Q 1776	TRANSISTOR				2SC4617 TL R	G3346178R		1-	B	d4
Q 1777	IC				LM2904PWR	G1094010		1-	A	C4
Q 1801	TRANSISTOR				DTC144EE TL	G3070075		1-	A	A4
Q 1860	TRANSISTOR				DTA114EE TL	G3070263		1-	A	B3
Q 1861	TRANSISTOR				UMA8N TR	G3070270		1-	A	B3
Q 1862	IC				BU2090FS-E2	G1092187		1-	A	B3
Q 1863	TRANSISTOR				2SC4617 TL R	G3346178R		1-	B	c3
Q 1864	IC				CMX589AD5	G1094597		1-	A	A4
Q 1865	IC				CD4053BPWR	G1093864		1-	A	B4
Q 1866	TRANSISTOR				DTC144EE TL	G3070075		1-	A	B4
Q 1867	TRANSISTOR				2SC4617 TL R	G3346178R		1-	B	b3
Q 1868	TRANSISTOR				UMA8N TR	G3070270		1-	B	b3
Q 1869	TRANSISTOR				DTA114EE TL	G3070263		1-	B	b3
Q 1870	IC				CD4094BPWR	G1093866		1-	B	b3
Q 1871	IC				M62353AGP	G1094272		1-	B	b2
Q 1872	TRANSISTOR				UMD5N TR	G3070343		1-	A	C2
Q 1873	TRANSISTOR				UMA8N TR	G3070270		1-	A	C3
Q 1874	TRANSISTOR				UMA8N TR	G3070270		1-	A	D3
Q 1875	TRANSISTOR				UMA8N TR	G3070270		1-	A	D3
Q 1876	TRANSISTOR				UMA8N TR	G3070270		1-	A	D3
Q 1877	IC				BU2090FS-E2	G1092187		1-	A	C3
Q 1878	TRANSISTOR				UMA8N TR	G3070270		1-	A	C3
Q 1879	TRANSISTOR				IMT17 T110	G3070295		1-	A	C3
Q 1880	IC				HD64F2268TF20(FLASH)			1-	A	A4
Q 1881	IC				LM2902PWR	G1094009		1-	A	B4
Q 1882	IC				LM2904PWR	G1094010		1-	B	a2
Q 1883	TRANSISTOR				2SC4617 TL R	G3346178R		1-	A	A3
Q 1884	TRANSISTOR				UMD5N TR	G3070343		1-	B	b2
Q 1885	TRANSISTOR				2SC4915-O(TE85L.F)	G3349158O		1-	A	B1
Q 1887	IC				CMX865AE4	G1094617		1-	B	c4
Q 1888	TRANSISTOR				DTC144EE TL	G3070075		1-	A	B4
Q 1889	FET				2SK397300L	G3839738		1-	B	d4
Q 1890	TRANSISTOR				2SC4617 TL R	G3346178R		1-	B	c5
Q 1891	TRANSISTOR				DTC144EE TL	G3070075		1-	B	d4
Q 1892	IC				CD4066BPWR	G1093865		1-	A	B4
Q 1893	TRANSISTOR				2SC4617 TL R	G3346178R		1-	A	B4
Q 1894	IC				XC6201P332MR	G1093946		1-	B	c4
Q 1895	TRANSISTOR				2SC4617 TL R	G3346178R		1-	B	d4
Q 1896	IC				LM2904PWR	G1094010		1-	B	d4
Q 1897	TRANSISTOR				DTC144EE TL	G3070075		1-	B	d2
Q 1898	IC				TC7W53FU(TE12L_F)	G1094158		1-	A	A2
Q 1899	FET				2SK397300L	G3839738		1-	B	d4
Q 1900	TRANSISTOR				DTC144EE TL	G3070075		1-	B	c4
Q 1901	TRANSISTOR				DTC144EE TL	G3070075		1-	B	c4
Q 1902	TRANSISTOR				DTC144EE TL	G3070075		1-	B	c4
R 1001	CHIP RES.	47	1/16W	5%	RMC1/16S 470JTH	J24189009		1-	B	a2
R 1003	CHIP RES.	10	1/16W	5%	RMC1/16S 100JTH	J24189001		1-	B	b2
R 1004	CHIP RES.	4.7k	1/16W	5%	RMC1/16S 472JTH	J24189033		1-	A	D2
R 1005	CHIP RES.	100	1/16W	5%	RMC1/16S 101JTH	J24189013		1-	A	D2
R 1006	CHIP RES.	100k	1/16W	5%	RMC1/16S 104JTH	J24189049		1-	A	D2
R 1007	CHIP RES.	100k	1/16W	5%	RMC1/16S 104JTH	J24189049		1-	A	D2
R 1008	CHIP RES.	100k	1/16W	5%	RMC1/16S 104JTH	J24189049		1-	A	D2
R 1009	CHIP RES.	33k	1/16W	5%	RMC1/16S 333JTH	J24189043		1-	A	D3
R 1010	CHIP RES.	220k	1/16W	5%	RMC1/16S 224JTH	J24189053		1-	A	D3
R 1011	CHIP RES.	150	1/16W	5%	RMC1/16S 151JTH	J24189015		1-	A	D3
R 1012	CHIP RES.	22k	1/16W	5%	RMC1/16S 223JTH	J24189041		1-	B	a2
R 1013	CHIP RES.	47	1/16W	5%	RMC1/16S 470JTH	J24189009		1-	B	a2
R 1015	CHIP RES.	47k	1/16W	5%	RMC1/16S 473JTH	J24189045		1-	B	b2
R 1016	CHIP RES.	4.7k	1/16W	5%	RMC1/16S 472JTH	J24189033		1-	B	b2
R 1017	CHIP RES.	100	1/16W	5%	RMC1/16S 101JTH	J24189013		1-	B	b2
R 1018	CHIP RES.	1k	1/16W	5%	RMC1/16S 102JTH	J24189025		1-	B	b2
R 1019	CHIP RES.	1M	1/16W	5%	RMC1/16S 105JTH	J24189061		1-	B	b2
R 1020	CHIP RES.	100	1/16W	5%	RMC1/16S 101JTH	J24189013		1-	A	C3
R 1021	CHIP RES.	1.5k	1/16W	5%	RMC1/16S 152JTH	J24189027		1-	A	C3
R 1022	CHIP RES.	220k	1/16W	5%	RMC1/16S 224JTH	J24189053		1-	A	D3
R 1023	CHIP RES.	47k	1/16W	5%	RMC1/16S 473JTH	J24189045		1-	A	D3
R 1024	CHIP RES.	100k	1/16W	5%	RMC1/16S 104JTH	J24189049		1-	B	a2
R 1025	CHIP RES.	82k	1/16W	5%	RMC1/16S 823JTH	J24189048		1-	A	C1
R 1026	CHIP RES.	220k	1/16W	5%	RMC1/16S 224JTH	J24189053		1-	B	a2
R 1028	CHIP RES.	47	1/16W	5%	RMC1/16S 470JTH	J24189009		1-	B	a2
R 1030	CHIP RES.	10	1/16W	5%	RMC1/16S 100JTH	J24189001		1-	B	a2
R 1031	CHIP RES.	4.7k	1/16W	5%	RMC1/16S 472JTH	J24189033		1-	B	a2

MAIN Unit

Parts List

REF	DESCRIPTION	VALUE	V/W	TOL.	MFR'S DESIG	VXSTD P/N	VERS.	LOT	SIDE	LAY ADR
R 1032	CHIP RES.	100	1/16W	5%	RMC1/16S 101JTH	J24189013		1-	B	a2
R 1033	CHIP RES.	100k	1/16W	5%	RMC1/16S 104JTH	J24189049		1-	B	a2
R 1034	CHIP RES.	100k	1/16W	5%	RMC1/16S 104JTH	J24189049		1-	B	a2
R 1035	CHIP RES.	100k	1/16W	5%	RMC1/16S 104JTH	J24189049		1-	B	a2
R 1036	CHIP RES.	33k	1/16W	5%	RMC1/16S 333JTH	J24189043		1-	B	a2
R 1037	CHIP RES.	220k	1/16W	5%	RMC1/16S 224JTH	J24189053		1-	B	a2
R 1038	CHIP RES.	150	1/16W	5%	RMC1/16S 151JTH	J24189015		1-	B	a2
R 1039	CHIP RES.	100k	1/16W	5%	RMC1/16S 104JTH	J24189049		1-	B	a2
R 1040	CHIP RES.	100k	1/16W	5%	RMC1/16S 104JTH	J24189049		1-	A	C2
R 1041	CHIP RES.	47k	1/16W	5%	RMC1/16S 473JTH	J24189045		1-	B	a2
R 1042	CHIP RES.	4.7k	1/16W	5%	RMC1/16S 472JTH	J24189033		1-	B	a2
R 1043	CHIP RES.	100	1/16W	5%	RMC1/16S 101JTH	J24189013		1-	B	a2
R 1044	CHIP RES.	2.2k	1/16W	5%	RMC1/16S 222JTH	J24189029		1-	B	a3
R 1045	CHIP RES.	1M	1/16W	5%	RMC1/16S 105JTH	J24189061		1-	B	a2
R 1046	CHIP RES.	100	1/16W	5%	RMC1/16S 101JTH	J24189013		1-	B	a2
R 1047	CHIP RES.	3.3k	1/16W	5%	RMC1/16S 332JTH	J24189031		1-	B	a3
R 1048	CHIP RES.	220k	1/16W	5%	RMC1/16S 224JTH	J24189053		1-	B	a2
R 1049	CHIP RES.	47k	1/16W	5%	RMC1/16S 473JTH	J24189045		1-	B	a2
R 1050	CHIP RES.	10k	1/16W	5%	RMC1/16S 103JTH	J24189037		1-	A	C1
R 1051	CHIP RES.	22	1/16W	5%	RMC1/16S 220JTH	J24189005		1-	A	C1
R 1052	CHIP RES.	47	1/16W	5%	RMC1/16S 470JTH	J24189009		1-	A	C2
R 1053	CHIP RES.	1k	1/16W	5%	RMC1/16S 102JTH	J24189025		1-	A	C2
R 1054	CHIP RES.	100	1/16W	5%	RMC1/16S 101JTH	J24189013		1-	A	C2
R 1055	CHIP RES.	220k	1/16W	5%	RMC1/16S 224JTH	J24189053		1-	A	C2
R 1056	CHIP RES.	220k	1/16W	5%	RMC1/16S 224JTH	J24189053		1-	A	C2
R 1057	CHIP RES.	220k	1/16W	5%	RMC1/16S 224JTH	J24189053		1-	A	C2
R 1058	CHIP RES.	15k	1/16W	5%	RMC1/16S 153JTH	J24189039		1-	A	C3
R 1059	CHIP RES.	47k	1/16W	5%	RMC1/16S 473JTH	J24189045		1-	A	C3
R 1060	CHIP RES.	120k	1/16W	5%	RMC1/16S 124JTH	J24189050		1-	A	C3
R 1061	CHIP RES.	220k	1/16W	5%	RMC1/16S 224JTH	J24189053		1-	A	C3
R 1062	CHIP RES.	150	1/16W	5%	RMC1/16S 151JTH	J24189015		1-	A	C3
R 1063	CHIP RES.	3.3k	1/16W	5%	RMC1/16S 332JTH	J24189031		1-	A	C3
R 1064	CHIP RES.	100k	1/16W	5%	RMC1/16S 104JTH	J24189049		1-	A	C2
R 1065	CHIP RES.	4.7k	1/16W	5%	RMC1/16S 472JTH	J24189033		1-	A	C1
R 1066	CHIP RES.	22	1/16W	5%	RMC1/16S 220JTH	J24189005		1-	A	C1
R 1067	CHIP RES.	47	1/16W	5%	RMC1/16S 470JTH	J24189009		1-	A	C2
R 1068	CHIP RES.	1k	1/16W	5%	RMC1/16S 102JTH	J24189025		1-	A	D2
R 1069	CHIP RES.	100	1/16W	5%	RMC1/16S 101JTH	J24189013		1-	A	D2
R 1070	CHIP RES.	220k	1/16W	5%	RMC1/16S 224JTH	J24189053		1-	A	D2
R 1071	CHIP RES.	220k	1/16W	5%	RMC1/16S 224JTH	J24189053		1-	A	D2
R 1072	CHIP RES.	220k	1/16W	5%	RMC1/16S 224JTH	J24189053		1-	A	D2
R 1073	CHIP RES.	15k	1/16W	5%	RMC1/16S 153JTH	J24189039		1-	A	D2
R 1074	CHIP RES.	47k	1/16W	5%	RMC1/16S 473JTH	J24189045		1-	A	D3
R 1075	CHIP RES.	120k	1/16W	5%	RMC1/16S 124JTH	J24189050		1-	A	D2
R 1076	CHIP RES.	220k	1/16W	5%	RMC1/16S 224JTH	J24189053		1-	A	D3
R 1077	CHIP RES.	150	1/16W	5%	RMC1/16S 151JTH	J24189015		1-	A	D2
R 1078	CHIP RES.	3.9k	1/16W	5%	RMC1/16S 392JTH	J24189032		1-	A	D3
R 1079	CHIP RES.	470k	1/16W	5%	RMC1/16S 474JTH	J24189057		1-	A	C1
R 1080	CHIP RES.	47k	1/16W	5%	RMC1/16S 473JTH	J24189045		1-	A	C1
R 1081	CHIP RES.	100k	1/16W	5%	RMC1/16S 104JTH	J24189049		1-	A	C2
R 1082	CHIP RES.	47	1/16W	5%	RMC1/16S 470JTH	J24189009		1-	A	C1
R 1083	CHIP RES.	47	1/16W	5%	RMC1/16S 470JTH	J24189009		1-	A	C2
R 1084	CHIP RES.	470	1/16W	5%	RMC1/16S 471JTH	J24189021		1-	A	C2
R 1085	CHIP RES.	100	1/16W	5%	RMC1/16S 101JTH	J24189013		1-	A	C2
R 1086	CHIP RES.	100k	1/16W	5%	RMC1/16S 104JTH	J24189049		1-	A	C2
R 1087	CHIP RES.	820k	1/16W	5%	RMC1/16S 824JTH	J24189060		1-	A	C3
R 1088	CHIP RES.	470	1/16W	5%	RMC1/16S 471JTH	J24189021		1-	A	C3
R 1089	CHIP RES.	4.7k	1/16W	5%	RMC1/16S 472JTH	J24189033		1-	A	C3
R 1090	CHIP RES.	47	1/16W	5%	RMC1/16S 470JTH	J24189009		1-	A	C1
R 1091	CHIP RES.	47	1/16W	5%	RMC1/16S 470JTH	J24189009		1-	A	C2
R 1092	CHIP RES.	470	1/16W	5%	RMC1/16S 471JTH	J24189021		1-	A	D2
R 1093	CHIP RES.	100	1/16W	5%	RMC1/16S 101JTH	J24189013		1-	A	D2
R 1094	CHIP RES.	47k	1/16W	5%	RMC1/16S 473JTH	J24189045		1-	A	C2
R 1095	CHIP RES.	820k	1/16W	5%	RMC1/16S 824JTH	J24189060		1-	A	D3
R 1096	CHIP RES.	180	1/16W	5%	RMC1/16S 181JTH	J24189016		1-	A	D3
R 1097	CHIP RES.	6.8k	1/16W	5%	RMC1/16S 682JTH	J24189035		1-	A	D3
R 1098	CHIP RES.	47k	1/16W	5%	RMC1/16S 473JTH	J24189045		1-	A	D3
R 1099	CHIP RES.	100	1/16W	5%	RMC1/16S 101JTH	J24189013		1-	A	D1
R 1100	CHIP RES.	330k	1/16W	5%	RMC1/16S 334JTH	J24189055		1-	A	D1
R 1101	CHIP RES.	68	1/16W	5%	RMC1/16S 680JTH	J24189011		1-	A	D1
R 1102	CHIP RES.	100	1/16W	5%	RMC1/16S 101JTH	J24189013		1-	A	D1
R 1103	CHIP RES.	0	1/16W	5%	RMC1/16S JPPTH	J24189070		1-	A	D2
R 1104	CHIP RES.	820k	1/16W	5%	RMC1/16S 824JTH	J24189060		1-	A	D2
R 1105	CHIP RES.	820k	1/16W	5%	RMC1/16S 824JTH	J24189060		1-	A	D2
R 1106	CHIP RES.	47	1/16W	5%	RMC1/16S 470JTH	J24189009		1-	A	D2

MAIN Unit

Parts List

REF	DESCRIPTION	VALUE	V/W	TOL.	MFR'S DESIG	VXSTD P/N	VERS.	LOT	SIDE	LAY ADR
R 1107	CHIP RES.	1k	1/16W	5%	RMC1/16S 102JTH	J24189025		1-	B	a2
R 1108	CHIP RES.	100	1/16W	5%	RMC1/16S 101JTH	J24189013		1-	B	b2
R 1109	CHIP RES.	100k	1/16W	5%	RMC1/16S 104JTH	J24189049		1-	B	a2
R 1110	CHIP RES.	100k	1/16W	5%	RMC1/16S 104JTH	J24189049		1-	B	b3
R 1111	CHIP RES.	47k	1/16W	5%	RMC1/16S 473JTH	J24189045		1-	B	a2
R 1112	CHIP RES.	820k	1/16W	5%	RMC1/16S 824JTH	J24189060		1-	B	b3
R 1113	CHIP RES.	100	1/16W	5%	RMC1/16S 101JTH	J24189013		1-	B	b3
R 1114	CHIP RES.	180	1/16W	5%	RMC1/16S 181JTH	J24189016		1-	B	b3
R 1115	CHIP RES.	0	1/16W	5%	RMC1/16S JPTH	J24189070		1-	A	D2
R 1116	CHIP RES.	47	1/16W	5%	RMC1/16S 470JTH	J24189009		1-	A	D2
R 1117	CHIP RES.	1k	1/16W	5%	RMC1/16S 102JTH	J24189025		1-	A	D2
R 1118	CHIP RES.	100	1/16W	5%	RMC1/16S 101JTH	J24189013		1-	A	D2
R 1119	CHIP RES.	100k	1/16W	5%	RMC1/16S 104JTH	J24189049		1-	A	D2
R 1120	CHIP RES.	100k	1/16W	5%	RMC1/16S 104JTH	J24189049		1-	A	D2
R 1121	CHIP RES.	47k	1/16W	5%	RMC1/16S 473JTH	J24189045		1-	A	E2
R 1122	CHIP RES.	820k	1/16W	5%	RMC1/16S 824JTH	J24189060		1-	A	E2
R 1123	CHIP RES.	470	1/16W	5%	RMC1/16S 471JTH	J24189021		1-	A	E2
R 1124	CHIP RES.	470	1/16W	5%	RMC1/16S 471JTH	J24189021		1-	A	D2
R 1125	CHIP RES.	1k	1/16W	5%	RMC1/16S 102JTH	J24189025		1-	B	a2
R 1126	CHIP RES.	1k	1/16W	5%	RMC1/16S 102JTH	J24189025		1-	B	a2
R 1127	CHIP RES.	100k	1/16W	5%	RMC1/16S 104JTH	J24189049		1-	B	a2
R 1128	CHIP RES.	100k	1/16W	5%	RMC1/16S 104JTH	J24189049		1-	A	D2
R 1129	CHIP RES.	180	1/16W	5%	RMC1/16S 181JTH	J24189016		1-	B	b2
R 1130	CHIP RES.	180	1/16W	5%	RMC1/16S 181JTH	J24189016		1-	B	a3
R 1131	CHIP RES.	0	1/16W	5%	RMC1/16 000JATP	J24185000		1-	A	C2
R 1194	CHIP RES.	1k	1/16W	5%	RMC1/16S 102JTH	J24189025		1-	A	A4
R 1195	CHIP RES.	1k	1/16W	5%	RMC1/16S 102JTH	J24189025		1-	A	A4
R 1196	CHIP RES.	1k	1/16W	5%	RMC1/16S 102JTH	J24189025		1-	A	A4
R 1197	CHIP RES.	1k	1/16W	5%	RMC1/16S 102JTH	J24189025		1-	A	A4
R 1198	CHIP RES.	100	1/16W	5%	RMC1/16S 101JTH	J24189013		1-	B	c1
R 1202	CHIP RES.	10k	1/16W	5%	RMC1/16S 103JTH	J24189037		1-	A	D1
R 1203	CHIP RES.	10k	1/16W	5%	RMC1/16S 103JTH	J24189037		1-	A	D1
R 1204	CHIP RES.	10k	1/16W	5%	RMC1/16S 103JTH	J24189037		1-	A	D1
R 1205	CHIP RES.	10k	1/16W	5%	RMC1/16S 103JTH	J24189037		1-	A	D1
R 1206	CHIP RES.	22	1/16W	5%	RMC1/16S 220JTH	J24189005		1-	B	a1
R 1207	CHIP RES.	22	1/16W	5%	RMC1/16S 220JTH	J24189005		1-	B	a1
R 1208	CHIP RES.	22	1/16W	5%	RMC1/16S 220JTH	J24189005		1-	B	a1
R 1209	CHIP RES.	220	1/16W	5%	RMC1/16S 221JTH	J24189017		1-	B	b1
R 1210	CHIP RES.	220	1/16W	5%	RMC1/16S 221JTH	J24189017		1-	B	b1
R 1211	CHIP RES.	220	1/16W	5%	RMC1/16S 221JTH	J24189017		1-	B	a1
R 1212	CHIP RES.	220	1/16W	5%	RMC1/16S 221JTH	J24189017		1-	B	a1
R 1213	CHIP RES.	220	1/16W	5%	RMC1/16S 221JTH	J24189017		1-	B	a1
R 1214	CHIP RES.	220	1/16W	5%	RMC1/16S 221JTH	J24189017		1-	B	a1
R 1215	CHIP RES.	220	1/16W	5%	RMC1/16S 221JTH	J24189017		1-	B	b1
R 1216	CHIP RES.	220	1/16W	5%	RMC1/16S 221JTH	J24189017		1-	B	b1
R 1217	CHIP RES.	220	1/16W	5%	RMC1/16S 221JTH	J24189017		1-	B	b1
R 1218	CHIP RES.	27	1/16W	5%	RMC1/16S 270JTH	J24189006		1-	B	b1
R 1219	CHIP RES.	27	1/16W	5%	RMC1/16S 270JTH	J24189006		1-	B	b1
R 1220	CHIP RES.	27	1/16W	5%	RMC1/16S 270JTH	J24189006		1-	B	b1
R 1221	CHIP RES.	680	1/16W	5%	RMC1/16S 681JTH	J24189023		7-	A	D3
R 1222	CHIP RES.	0	1/16W	5%	RMC1/16 000JATP	J24185000		1-	A	D3
R 1223	CHIP RES.	47	1/16W	5%	RMC1/16S 470JTH	J24189009		1-	A	D3
R 1224	CHIP RES.	2.2k	1/16W	5%	RMC1/16S 222JTH	J24189029		1-	A	D3
R 1225	CHIP RES.	390	1/16W	5%	RMC1/16S 391JTH	J24189020		1-	B	a2
R 1226	CHIP RES.	4.7k	1/16W	5%	RMC1/16S 472JTH	J24189033		1-	A	C3
R 1227	CHIP RES.	4.7k	1/16W	5%	RMC1/16S 472JTH	J24189033		1-	A	C3
R 1228	CHIP RES.	47	1/16W	5%	RMC1/16S 470JTH	J24189009		1-	A	D3
R 1229	CHIP RES.	1k	1/16W	5%	RMC1/16S 102JTH	J24189025		1-	B	b3
R 1230	CHIP RES.	82	1/16W	5%	RMC1/16S 820JTH	J24189012		1-	A	C3
R 1231	CHIP RES.	47	1/16W	5%	RMC1/16S 470JTH	J24189009		1-	B	b3
R 1232	CHIP RES.	47k	1/16W	5%	RMC1/16S 473JTH	J24189045		1-	B	b1
R 1233	CHIP RES.	22	1/16W	5%	RMC1/16S 220JTH	J24189005		1-	B	b1
R 1234	CHIP RES.	33	1/16W	5%	RMC1/16S 330JTH	J24189007		1-	A	B1
R 1235	CHIP RES.	2.2M	1/16W	5%	RMC1/16S 225JTH	J24189065		1-	B	b1
R 1236	CHIP RES.	330k	1/16W	5%	RMC1/16S 334JTH	J24189055		1-	B	b1
R 1237	CHIP RES.	1k	1/16W	5%	RMC1/16S 102JTH	J24189025		1-	B	b1
R 1238	CHIP RES.	100	1/16W	5%	RMC1/16S 101JTH	J24189013		1-	B	b1
R 1239	CHIP RES.	100	1/16W	5%	RMC1/16S 101JTH	J24189013		1-	B	b1
R 1240	CHIP RES.	330k	1/16W	5%	RMC1/16S 334JTH	J24189055		1-	B	b1
R 1241	CHIP RES.	10k	1/16W	5%	RMC1/16S 103JTH	J24189037		1-	B	b1
R 1242	CHIP RES.	10k	1/16W	5%	RMC1/16S 103JTH	J24189037		1-	B	b1
R 1243	CHIP RES.	10k	1/16W	5%	RMC1/16S 103JTH	J24189037		1-	B	b1
R 1244	CHIP RES.	10k	1/16W	5%	RMC1/16S 103JTH	J24189037		1-	B	b1
R 1245	CHIP RES.	33k	1/16W	5%	RMC1/16S 333JTH	J24189043		1-	B	b1
R 1247	CHIP RES.	47	1/16W	5%	RMC1/16S 470JTH	J24189009		1-	A	C3

MAIN Unit

Parts List

REF	DESCRIPTION	VALUE	V/W	TOL.	MFR'S DESIG	VXSTD P/N	VERS.	LOT	SIDE	LAY ADR
R 1247	CHIP RES.	22	1/16W	5%	RMC1/16S 220JTH	J24189005		7-	A	C3
R 1248	CHIP RES.	2.2k	1/16W	5%	RMC1/16S 222JTH	J24189029		1-	B	b2
R 1249	CHIP RES.	470	1/16W	5%	RMC1/16S 471JTH	J24189021		1-	B	b3
R 1249	CHIP RES.	150	1/16W	5%	RMC1/16S 151JTH	J24189015		7-	B	b3
R 1250	CHIP RES.	4.7k	1/16W	5%	RMC1/16S 472JTH	J24189033		1-	A	C2
R 1251	CHIP RES.	4.7k	1/16W	5%	RMC1/16S 472JTH	J24189033		1-	A	C3
R 1251	CHIP RES.	2.7k	1/16W	5%	RMC1/16S 272JTH	J24189030		7-	A	C3
R 1252	CHIP RES.	1k	1/16W	5%	RMC1/16S 102JTH	J24189025		1-	A	C3
R 1253	CHIP RES.	150	1/16W	5%	RMC1/16S 151JTH	J24189015		1-	A	C3
R 1253	CHIP RES.	120	1/16W	5%	RMC1/16S 121JTH	J24189014		7-	A	C3
R 1254	CHIP RES.	47	1/16W	5%	RMC1/16S 470JTH	J24189009		1-	B	b3
R 1255	CHIP RES.	47k	1/16W	5%	RMC1/16S 473JTH	J24189045		1-	B	b1
R 1256	CHIP RES.	1.2k	1/16W	5%	RMC1/16S 122JTH	J24189026		1-	A	C2
R 1257	CHIP RES.	1.2k	1/16W	5%	RMC1/16S 122JTH	J24189026		1-	A	C2
R 1258	CHIP RES.	1k	1/16W	5%	RMC1/16S 102JTH	J24189025		1-	A	C2
R 1259	CHIP RES.	10k	1/16W	5%	RMC1/16S 103JTH	J24189037		1-	A	C2
R 1260	CHIP RES.	470	1/16W	5%	RMC1/16S 471JTH	J24189021		1-	A	C2
R 1261	CHIP RES.	220	1/16W	5%	RMC1/16S 221JTH	J24189017		1-	A	C2
R 1262	CHIP RES.	22k	1/16W	5%	RMC1/16S 223JTH	J24189041		1-	A	C2
R 1263	CHIP RES.	27k	1/16W	5%	RMC1/16S 273JTH	J24189042		1-	A	C2
R 1264	CHIP RES.	10k	1/16W	5%	RMC1/16S 103JTH	J24189037		1-	A	C2
R 1265	CHIP RES.	1k	1/16W	5%	RMC1/16S 102JTH	J24189025		1-	A	C2
R 1266	CHIP RES.	56k	1/16W	5%	RMC1/16S 563JTH	J24189046		1-	A	C2
R 1267	CHIP RES.	680	1/16W	5%	RMC1/16S 681JTH	J24189023		1-	A	C2
R 1268	CHIP RES.	10k	1/16W	5%	RMC1/16S 103JTH	J24189037		1-	A	C2
R 1269	CHIP RES.	10k	1/16W	5%	RMC1/16S 103JTH	J24189037		1-	A	B2
R 1270	CHIP RES.	47	1/16W	5%	RMC1/16S 470JTH	J24189009		1-	B	b2
R 1271	CHIP RES.	220	1/16W	5%	RMC1/16S 221JTH	J24189017		1-	B	c2
R 1272	CHIP RES.	47	1/16W	5%	RMC1/16S 470JTH	J24189009		1-	B	b3
R 1273	CHIP RES.	22	1/16W	5%	RMC1/16S 220JTH	J24189005		1-	A	E3
R 1295	CHIP RES.	470k	1/16W	5%	RMC1/16S 474JTH	J24189057	W/ CE LABEL	5-8	A	A2
R 1295	CHIP RES.	470k	1/16W	5%	RMC1/16S 474JTH	J24189057		9-	A	A2
R 1296	CHIP RES.	10k	1/16W	5%	RMC1/16S 103JTH	J24189037	W/ CE LABEL	5-8	A	A2
R 1296	CHIP RES.	10k	1/16W	5%	RMC1/16S 103JTH	J24189037		9-	A	A2
R 1297	CHIP RES.	27k	1/16W	5%	RMC1/16S 273JTH	J24189042		1-	A	B1
R 1298	CHIP RES.	5.6k	1/16W	5%	RMC1/16S 562JTH	J24189034		1-	A	B1
R 1299	CHIP RES.	27k	1/16W	5%	RMC1/16S 273JTH	J24189042		1-	A	B1
R 1300	CHIP RES.	68k	1/16W	5%	RMC1/16S 683JTH	J24189047		1-	A	B2
R 1301	CHIP RES.	470	1/16W	5%	RMC1/16S 471JTH	J24189021		1-	A	B1
R 1302	CHIP RES.	10k	1/16W	5%	RMC1/16S 103JTH	J24189037		1-	A	B2
R 1303	CHIP RES.	10k	1/16W	5%	RMC1/16S 103JTH	J24189037		1-	A	B2
R 1304	CHIP RES.	680	1/16W	5%	RMC1/16S 681JTH	J24189023		1-	A	B1
R 1305	CHIP RES.	100	1/16W	5%	RMC1/16S 101JTH	J24189013		1-	B	c2
R 1306	CHIP RES.	15k	1/16W	5%	RMC1/16S 153JTH	J24189039		1-	A	B2
R 1307	CHIP RES.	27k	1/16W	5%	RMC1/16S 273JTH	J24189042		1-	A	B2
R 1308	CHIP RES.	47k	1/16W	5%	RMC1/16S 473JTH	J24189045		1-	A	B2
R 1309	CHIP RES.	12k	1/16W	5%	RMC1/16S 123JTH	J24189038		1-	A	B2
R 1310	CHIP RES.	12k	1/16W	5%	RMC1/16S 123JTH	J24189038		1-	A	B2
R 1311	CHIP RES.	22k	1/16W	5%	RMC1/16S 223JTH	J24189041		1-	A	B2
R 1312	CHIP RES.	22k	1/16W	5%	RMC1/16S 223JTH	J24189041		1-	A	B2
R 1313	CHIP RES.	33k	1/16W	5%	RMC1/16S 333JTH	J24189043		1-	A	D3
R 1314	CHIP RES.	10k	1/16W	5%	RMC1/16S 103JTH	J24189037		1-	A	D3
R 1315	CHIP RES.	47	1/16W	5%	RMC1/16S 470JTH	J24189009		1-	A	D3
R 1316	CHIP RES.	470	1/16W	5%	RMC1/16S 471JTH	J24189021		1-	B	a3
R 1317	CHIP RES.	33k	1/16W	5%	RMC1/16S 333JTH	J24189043		1-	B	a3
R 1318	CHIP RES.	47	1/16W	5%	RMC1/16S 470JTH	J24189009		1-	B	a3
R 1319	CHIP RES.	680	1/16W	5%	RMC1/16S 681JTH	J24189023		1-	B	a3
R 1320	CHIP RES.	15k	1/16W	0.5%	RR0510R-153-D	J24189147		1-	B	a3
R 1321	CHIP RES.	22k	1/16W	0.5%	RR0510R-223-D	J24189151		1-	B	a3
R 1322	CHIP RES.	3.3k	1/16W	5%	RMC1/16S 332JTH	J24189031		1-	B	a3
R 1323	CHIP RES.	470	1/16W	5%	RMC1/16S 471JTH	J24189021		1-	B	a3
R 1324	CHIP RES.	100k	1/16W	5%	RMC1/16S 104JTH	J24189049		1-	A	D3
R 1325	CHIP RES.	47	1/16W	5%	RMC1/16S 470JTH	J24189009		1-	A	D3
R 1326	CHIP RES.	100	1/16W	5%	RMC1/16S 101JTH	J24189013		1-	A	D3
R 1327	CHIP RES.	2.2k	1/16W	5%	RMC1/16S 222JTH	J24189029		1-	A	D3
R 1328	CHIP RES.	2.2k	1/16W	5%	RMC1/16S 222JTH	J24189029		1-	A	D3
R 1329	CHIP RES.	220	1/16W	5%	RMC1/16S 221JTH	J24189017		1-	A	D3
R 1330	CHIP RES.	1k	1/16W	5%	RMC1/16S 102JTH	J24189025		1-	B	a3
R 1331	CHIP RES.	33k	1/16W	5%	RMC1/16S 333JTH	J24189043		1-	B	a3
R 1332	CHIP RES.	220	1/16W	5%	RMC1/16S 221JTH	J24189017		1-	B	a3
R 1333	CHIP RES.	10k	1/16W	5%	RMC1/16S 103JTH	J24189037		1-	A	E3
R 1334	CHIP RES.	1k	1/16W	5%	RMC1/16S 102JTH	J24189025		1-	B	a3
R 1335	CHIP RES.	680k	1/16W	5%	RMC1/16S 684JTH	J24189059		1-	A	E3
R 1336	CHIP RES.	15k	1/16W	5%	RMC1/16S 153JTH	J24189039		1-	B	a3
R 1337	CHIP RES.	22k	1/16W	5%	RMC1/16S 223JTH	J24189041		1-	B	a3

MAIN Unit

Parts List

REF	DESCRIPTION	VALUE	V/W	TOL.	MFR'S DESIG	VXSTD P/N	VERS.	LOT	SIDE	LAY ADR
R 1338	CHIP RES.	3.3k	1/16W	5%	RMC1/16S 332JTH	J24189031		1-	B	a3
R 1339	CHIP RES.	470	1/16W	5%	RMC1/16S 471JTH	J24189021		1-	B	a3
R 1341	CHIP RES.	470	1/16W	5%	RMC1/16S 471JTH	J24189021		1-	A	D3
R 1342	CHIP RES.	1.2k	1/16W	5%	RMC1/16S 122JTH	J24189026		1-	A	D3
R 1343	CHIP RES.	680	1/16W	5%	RMC1/16S 681JTH	J24189023		1-	A	D3
R 1344	CHIP RES.	100	1/16W	5%	RMC1/16S 101JTH	J24189013		1-	A	D3
R 1345	CHIP RES.	10k	1/16W	5%	RMC1/16S 103JTH	J24189037		1-	A	D3
R 1346	CHIP RES.	10k	1/16W	5%	RMC1/16S 103JTH	J24189037		1-	A	D3
R 1347	CHIP RES.	10k	1/16W	5%	RMC1/16S 103JTH	J24189037		1-	A	D3
R 1348	CHIP RES.	22k	1/16W	5%	RMC1/16S 223JTH	J24189041		1-	B	a3
R 1349	CHIP RES.	100	1/16W	5%	RMC1/16S 101JTH	J24189013		1-	A	D4
R 1350	CHIP RES.	220k	1/16W	5%	RMC1/16S 224JTH	J24189053		1-	A	E3
R 1351	CHIP RES.	100k	1/16W	5%	RMC1/16S 104JTH	J24189049		1-	B	a3
R 1352	CHIP RES.	47	1/16W	5%	RMC1/16S 470JTH	J24189009		1-	B	a4
R 1353	CHIP RES.	47k	1/16W	5%	RMC1/16S 473JTH	J24189045		1-	B	a4
R 1354	CHIP RES.	330k	1/16W	5%	RMC1/16S 334JTH	J24189055		1-	B	a4
R 1355	CHIP RES.	8.2k	1/16W	5%	RMC1/16S 822JTH	J24189036		1-	B	a4
R 1356	CHIP RES.	18k	1/16W	0.5%	RR0510R-183-D	J24189149		1-	B	a4
R 1357	CHIP RES.	120k	1/16W	5%	RMC1/16S 124JTH	J24189050		1-	B	a4
R 1358	CHIP RES.	220k	1/16W	5%	RMC1/16S 224JTH	J24189053		1-	B	a4
R 1359	CHIP RES.	0	1/16W	5%	RMC1/16S JPTH	J24189070		1-	B	a4
R 1360	CHIP RES.	150k	1/16W	5%	RMC1/16S 154JTH	J24189051		1-	A	D4
R 1361	CHIP RES.	47k	1/16W	5%	RMC1/16S 473JTH	J24189045		1-	A	D4
R 1362	CHIP RES.	3.3k	1/16W	5%	RMC1/16S 332JTH	J24189031		1-	B	a4
R 1363	CHIP RES.	100k	1/16W	5%	RMC1/16S 104JTH	J24189049		1-	A	D4
R 1364	CHIP RES.	100k	1/16W	5%	RMC1/16S 104JTH	J24189049		1-	B	a4
R 1365	CHIP RES.	18k	1/16W	5%	RMC1/16S 183JTH	J24189040		1-	A	E4
R 1366	CHIP RES.	4.7k	1/16W	5%	RMC1/16S 472JTH	J24189033		1-	A	E4
R 1367	CHIP RES.	33k	1/16W	5%	RMC1/16S 333JTH	J24189043		1-	A	C3
R 1368	CHIP RES.	4.7k	1/16W	5%	RMC1/16S 472JTH	J24189033		1-	A	C3
R 1369	CHIP RES.	47	1/16W	5%	RMC1/16S 470JTH	J24189009		1-	A	C3
R 1370	CHIP RES.	470	1/16W	5%	RMC1/16S 471JTH	J24189021		1-	B	b3
R 1371	CHIP RES.	33k	1/16W	5%	RMC1/16S 333JTH	J24189043		1-	B	b3
R 1372	CHIP RES.	47	1/16W	5%	RMC1/16S 470JTH	J24189009		1-	B	b3
R 1373	CHIP RES.	680	1/16W	5%	RMC1/16S 681JTH	J24189023		1-	B	b3
R 1374	CHIP RES.	15k	1/16W	0.5%	RR0510R-153-D	J24189147		1-	B	b3
R 1375	CHIP RES.	22k	1/16W	0.5%	RR0510R-223-D	J24189151		1-	B	b3
R 1376	CHIP RES.	3.3k	1/16W	5%	RMC1/16S 332JTH	J24189031		1-	B	b3
R 1377	CHIP RES.	180	1/16W	5%	RMC1/16S 181JTH	J24189016		1-	B	b3
R 1378	CHIP RES.	150k	1/16W	5%	RMC1/16S 154JTH	J24189051		1-	B	b3
R 1379	CHIP RES.	470	1/16W	5%	RMC1/16S 471JTH	J24189021		1-	B	b3
R 1380	CHIP RES.	4.7k	1/16W	5%	RMC1/16S 472JTH	J24189033		1-	A	C3
R 1381	CHIP RES.	100k	1/16W	5%	RMC1/16S 104JTH	J24189049		1-	A	C3
R 1382	CHIP RES.	47	1/16W	5%	RMC1/16S 470JTH	J24189009		1-	A	C3
R 1383	CHIP RES.	100	1/16W	5%	RMC1/16S 101JTH	J24189013		1-	A	C3
R 1384	CHIP RES.	220	1/16W	5%	RMC1/16S 221JTH	J24189017		1-	A	C3
R 1385	CHIP RES.	1k	1/16W	5%	RMC1/16S 102JTH	J24189025		1-	B	b3
R 1386	CHIP RES.	33k	1/16W	5%	RMC1/16S 333JTH	J24189043		1-	B	b3
R 1387	CHIP RES.	220	1/16W	5%	RMC1/16S 221JTH	J24189017		1-	B	b3
R 1388	CHIP RES.	1k	1/16W	5%	RMC1/16S 102JTH	J24189025		1-	B	c3
R 1389	CHIP RES.	15k	1/16W	5%	RMC1/16S 153JTH	J24189039		1-	B	b3
R 1390	CHIP RES.	22k	1/16W	5%	RMC1/16S 223JTH	J24189041		1-	B	b3
R 1391	CHIP RES.	3.3k	1/16W	5%	RMC1/16S 332JTH	J24189031		1-	B	c3
R 1392	CHIP RES.	270	1/16W	5%	RMC1/16S 271JTH	J24189018		1-	B	c3
R 1393	CHIP RES.	100k	1/16W	5%	RMC1/16S 104JTH	J24189049		1-	B	b3
R 1394	CHIP RES.	470	1/16W	5%	RMC1/16S 471JTH	J24189021		1-	B	b3
R 1396	CHIP RES.	2.2k	1/16W	5%	RMC1/16S 222JTH	J24189029		1-	A	C3
R 1397	CHIP RES.	330	1/16W	5%	RMC1/16S 331JTH	J24189019		1-	A	C3
R 1398	CHIP RES.	150	1/16W	5%	RMC1/16S 151JTH	J24189015		1-	A	C3
R 1399	CHIP RES.	680	1/16W	5%	RMC1/16S 681JTH	J24189023		1-	A	C3
R 1400	CHIP RES.	2.2k	1/16W	5%	RMC1/16S 222JTH	J24189029		1-	A	C3
R 1401	CHIP RES.	10k	1/16W	5%	RMC1/16S 103JTH	J24189037		1-	A	C3
R 1402	CHIP RES.	100	1/16W	5%	RMC1/16S 101JTH	J24189013		1-	A	C3
R 1403	CHIP RES.	680k	1/16W	5%	RMC1/16S 684JTH	J24189059		1-	A	C3
R 1403	CHIP RES.	470k	1/16W	5%	RMC1/16S 474JTH	J24189057		11-	A	C3
R 1404	CHIP RES.	10k	1/16W	5%	RMC1/16S 103JTH	J24189037		1-	A	C3
R 1405	CHIP RES.	10k	1/16W	5%	RMC1/16S 103JTH	J24189037		1-	A	C3
R 1406	CHIP RES.	10k	1/16W	5%	RMC1/16S 103JTH	J24189037		1-	A	C3
R 1407	CHIP RES.	22k	1/16W	5%	RMC1/16S 223JTH	J24189041		1-	B	b4
R 1408	CHIP RES.	33k	1/16W	5%	RMC1/16S 333JTH	J24189043		1-	B	b4
R 1409	CHIP RES.	150k	1/16W	5%	RMC1/16S 154JTH	J24189051		1-	B	c4
R 1410	CHIP RES.	12k	1/16W	0.5%	RR0510R-123-D	J24189145		1-	B	c4
R 1411	CHIP RES.	18k	1/16W	0.5%	RR0510R-183-D	J24189149		1-	B	c4
R 1412	CHIP RES.	82k	1/16W	0.5%	RR0510R-823-D	J24189165		1-	B	c4
R 1413	CHIP RES.	270k	1/16W	5%	RMC1/16S 274JTH	J24189054		1-	B	b4

MAIN Unit

Parts List

REF	DESCRIPTION	VALUE	V/W	TOL.	MFR'S DESIG	VXSTD P/N	VERS.	LOT	SIDE	LAY ADR
R 1414	CHIP RES.	47k	1/16W	5%	RMC1/16S 473JTH	J24189045		1-	B	b4
R 1415	CHIP RES.	150k	1/16W	5%	RMC1/16S 154JTH	J24189051		1-	B	b4
R 1416	CHIP RES.	47k	1/16W	5%	RMC1/16S 473JTH	J24189045		1-	B	b4
R 1417	CHIP RES.	330k	1/16W	5%	RMC1/16S 334JTH	J24189055		1-	A	C4
R 1418	CHIP RES.	0	1/16W	5%	RMC1/16S JPTH	J24189070		1-	A	C4
R 1419	CHIP RES.	3.3k	1/16W	5%	RMC1/16S 332JTH	J24189031		1-	B	c4
R 1420	CHIP RES.	100k	1/16W	5%	RMC1/16S 104JTH	J24189049		1-	A	C4
R 1421	CHIP RES.	100	1/16W	5%	RMC1/16S 101JTH	J24189013		1-	A	C4
R 1422	CHIP RES.	100k	1/16W	5%	RMC1/16S 104JTH	J24189049		1-	B	b3
R 1423	CHIP RES.	220k	1/16W	5%	RMC1/16S 224JTH	J24189053		1-	A	C3
R 1424	CHIP RES.	18k	1/16W	5%	RMC1/16S 183JTH	J24189040		1-	A	C4
R 1425	CHIP RES.	100k	1/16W	5%	RMC1/16S 104JTH	J24189049		1-	B	b4
R 1426	CHIP RES.	47	1/16W	5%	RMC1/16S 470JTH	J24189009		1-	A	C4
R 1427	CHIP RES.	4.7k	1/16W	5%	RMC1/16S 472JTH	J24189033		1-	A	C4
R 1428	CHIP RES.	100k	1/16W	5%	RMC1/16S 104JTH	J24189049		1-	A	C3
R 1449	CHIP RES.	1k	1/16W	5%	RMC1/16S 102JTH	J24189025		1-	B	c2
R 1450	CHIP RES.	1.8k	1/16W	5%	RMC1/16S 182JTH	J24189028		1-	A	C2
R 1451	CHIP RES.	0	1/16W	5%	RMC1/16S JPTH	J24189070		1-	A	C2
R 1452	CHIP RES.	100	1/16W	5%	RMC1/16S 101JTH	J24189013		1-	A	C2
R 1453	CHIP RES.	560	1/16W	5%	RMC1/16S 561JTH	J24189022		1-	A	C2
R 1454	CHIP RES.	330k	1/16W	5%	RMC1/16S 334JTH	J24189055		1-	A	C2
R 1455	CHIP RES.	22	1/16W	5%	RMC1/16S 220JTH	J24189005		1-	A	B2
R 1456	CHIP RES.	330	1/16W	5%	RMC1/16S 331JTH	J24189019		1-	A	B2
R 1457	CHIP RES.	470	1/16W	5%	RMC1/16S 471JTH	J24189021		1-	A	B2
R 1458	CHIP RES.	1k	1/16W	5%	RMC1/16S 102JTH	J24189025		1-	A	B2
R 1459	CHIP RES.	100	1/16W	5%	RMC1/16S 101JTH	J24189013		1-	A	B2
R 1460	CHIP RES.	1M	1/16W	5%	RMC1/16S 105JTH	J24189061		1-	B	c3
R 1461	CHIP RES.	220k	1/16W	5%	RMC1/16S 224JTH	J24189053		1-	B	c3
R 1462	CHIP RES.	1k	1/16W	5%	RMC1/16S 102JTH	J24189025		1-	B	b2
R 1463	CHIP RES.	100	1/16W	5%	RMC1/16S 101JTH	J24189013		1-	B	b2
R 1464	CHIP RES.	820k	1/16W	5%	RMC1/16S 824JTH	J24189060		1-	B	b2
R 1465	CHIP RES.	1k	1/16W	5%	RMC1/16S 102JTH	J24189025		1-	B	c3
R 1466	CHIP RES.	100	1/16W	5%	RMC1/16S 101JTH	J24189013		1-	B	b2
R 1467	CHIP RES.	1k	1/16W	5%	RMC1/16S 102JTH	J24189025		1-	B	b2
R 1468	CHIP RES.	100	1/16W	5%	RMC1/16S 101JTH	J24189013		1-	B	b2
R 1469	CHIP RES.	100k	1/16W	5%	RMC1/16S 104JTH	J24189049		1-	B	c2
R 1470	CHIP RES.	330	1/16W	5%	RMC1/16S 331JTH	J24189019		1-	B	c2
R 1471	CHIP RES.	100	1/16W	5%	RMC1/16S 101JTH	J24189013		1-	B	c2
R 1472	CHIP RES.	10k	1/16W	0.5%	RR0510P-103-D	J24189143		1-	B	b2
R 1473	CHIP RES.	10k	1/16W	0.5%	RR0510P-103-D	J24189143		1-	B	c2
R 1474	CHIP RES.	100	1/16W	5%	RMC1/16S 101JTH	J24189013		1-	B	c2
R 1475	CHIP RES.	100k	1/16W	5%	RMC1/16S 104JTH	J24189049		1-	B	c2
R 1477	CHIP RES.	1M	1/16W	5%	RMC1/16S 105JTH	J24189061		1-	B	c3
R 1478	CHIP RES.	100k	1/16W	5%	RMC1/16S 104JTH	J24189049		1-	B	c3
R 1479	CHIP RES.	2.2k	1/16W	5%	RMC1/16S 222JTH	J24189029		1-	B	c3
R 1480	CHIP RES.	1k	1/16W	5%	RMC1/16S 102JTH	J24189025		1-	B	c3
R 1481	CHIP RES.	1k	1/16W	5%	RMC1/16S 102JTH	J24189025		1-	B	c3
R 1482	CHIP RES.	220	1/16W	5%	RMC1/16S 221JTH	J24189017		1-	B	c3
R 1483	CHIP RES.	100	1/16W	5%	RMC1/16S 101JTH	J24189013		1-	A	B2
R 1484	CHIP RES.	22k	1/16W	5%	RMC1/16S 223JTH	J24189041		1-	B	c2
R 1485	CHIP RES.	6.8k	1/16W	5%	RMC1/16S 682JTH	J24189035		1-	B	c2
R 1486	CHIP RES.	150k	1/16W	5%	RMC1/16S 154JTH	J24189051		1-	B	c2
R 1487	CHIP RES.	330	1/16W	5%	RMC1/16S 331JTH	J24189019		1-	A	B2
R 1488	CHIP RES.	2.2k	1/16W	5%	RMC1/16S 222JTH	J24189029		1-	B	c2
R 1489	CHIP RES.	3.3k	1/16W	5%	RMC1/16S 332JTH	J24189031		1-	B	c3
R 1490	CHIP RES.	100k	1/16W	5%	RMC1/16S 104JTH	J24189049		1-	B	c2
R 1491	CHIP RES.	1k	1/16W	5%	RMC1/16S 102JTH	J24189025		1-	B	c2
R 1493	CHIP RES.	4.7k	1/16W	5%	RMC1/16S 472JTH	J24189033		1-	B	c2
R 1494	CHIP RES.	150k	1/16W	5%	RMC1/16S 154JTH	J24189051		1-	B	c2
R 1495	CHIP RES.	4.7k	1/16W	5%	RMC1/16S 472JTH	J24189033		1-	B	c2
R 1496	CHIP RES.	22k	1/16W	5%	RMC1/16S 223JTH	J24189041		1-	B	c3
R 1497	CHIP RES.	4.7k	1/16W	5%	RMC1/16S 472JTH	J24189033		1-	A	B3
R 1498	CHIP RES.	22k	1/16W	5%	RMC1/16S 223JTH	J24189041		1-	B	c3
R 1500	CHIP RES.	10k	1/16W	5%	RMC1/16S 103JTH	J24189037		1-	B	c3
R 1501	CHIP RES.	470	1/16W	5%	RMC1/16S 471JTH	J24189021		1-	B	c3
R 1502	CHIP RES.	22k	1/16W	5%	RMC1/16S 223JTH	J24189041		1-	B	c3
R 1504	CHIP RES.	22k	1/16W	5%	RMC1/16S 223JTH	J24189041		1-	B	c3
R 1505	CHIP RES.	3.3k	1/16W	5%	RMC1/16S 332JTH	J24189031		1-	A	B2
R 1506	CHIP RES.	100	1/16W	5%	RMC1/16S 101JTH	J24189013		1-	B	c3
R 1507	CHIP RES.	47	1/16W	5%	RMC1/16S 470JTH	J24189009		1-	A	B2
R 1508	CHIP RES.	470k	1/16W	5%	RMC1/16S 474JTH	J24189057		1-	A	B2
R 1509	CHIP RES.	680	1/16W	5%	RMC1/16S 681JTH	J24189023		1-	B	c2
R 1510	CHIP RES.	3.3k	1/16W	5%	RMC1/16S 332JTH	J24189031		1-	B	c2
R 1511	CHIP RES.	100k	1/16W	5%	RMC1/16S 104JTH	J24189049		1-	B	c2
R 1512	CHIP RES.	3.3k	1/16W	5%	RMC1/16S 332JTH	J24189031		1-	B	c2

MAIN Unit

Parts List

REF	DESCRIPTION	VALUE	V/W	TOL.	MFR'S DESIG	VXSTD P/N	VERS.	LOT	SIDE	LAY ADR
R 1513	CHIP RES.	47k	1/16W	5%	RMC1/16S 473JTH	J24189045		1-	B	c2
R 1514	CHIP RES.	150k	1/16W	5%	RMC1/16S 154JTH	J24189051		1-	B	c2
R 1515	CHIP RES.	220k	1/16W	5%	RMC1/16S 224JTH	J24189053		1-	B	c2
R 1516	CHIP RES.	470k	1/16W	5%	RMC1/16S 474JTH	J24189057		1-	B	c2
R 1517	CHIP RES.	100k	1/16W	5%	RMC1/16S 104JTH	J24189049		1-	A	B3
R 1518	CHIP RES.	10k	1/16W	5%	RMC1/16S 103JTH	J24189037		1-	A	B2
R 1519	CHIP RES.	33k	1/16W	5%	RMC1/16S 333JTH	J24189043		1-	A	B2
R 1520	CHIP RES.	68k	1/16W	5%	RMC1/16S 683JTH	J24189047		1-	B	d3
R 1521	CHIP RES.	10k	1/16W	5%	RMC1/16S 103JTH	J24189037		1-	A	B2
R 1522	CHIP RES.	100k	1/16W	5%	RMC1/16S 104JTH	J24189049		1-	A	B2
R 1523	CHIP RES.	330k	1/16W	5%	RMC1/16S 334JTH	J24189055		1-	A	B2
R 1524	CHIP RES.	390k	1/16W	5%	RMC1/16S 394JTH	J24189056		1-	B	d3
R 1525	CHIP RES.	330k	1/16W	5%	RMC1/16S 334JTH	J24189055		1-	A	B2
R 1526	CHIP RES.	390k	1/16W	5%	RMC1/16S 394JTH	J24189056		1-	B	d3
R 1527	CHIP RES.	15k	1/16W	5%	RMC1/16S 153JTH	J24189039		1-	B	d2
R 1528	CHIP RES.	330k	1/16W	5%	RMC1/16S 334JTH	J24189055		1-	A	B2
R 1529	CHIP RES.	56k	1/16W	0.5%	RR0510R-563-D	J24189161		1-	A	B2
R 1530	CHIP RES.	33k	1/16W	5%	RMC1/16S 333JTH	J24189043		1-	A	B2
R 1531	CHIP RES.	220k	1/16W	5%	RMC1/16S 224JTH	J24189053		1-	A	B2
R 1532	CHIP RES.	39k	1/16W	5%	RMC1/16S 393JTH	J24189044		1-	A	B2
R 1533	CHIP RES.	100k	1/16W	5%	RMC1/16S 104JTH	J24189049		1-	A	B2
R 1534	CHIP RES.	47k	1/16W	5%	RMC1/16S 473JTH	J24189045		1-	B	d3
R 1535	CHIP RES.	33k	1/16W	5%	RMC1/16S 333JTH	J24189043		1-	A	B2
R 1536	CHIP RES.	390k	1/16W	5%	RMC1/16S 394JTH	J24189056		1-	B	d3
R 1537	CHIP RES.	68k	1/16W	5%	RMC1/16S 683JTH	J24189047		1-	B	d3
R 1538	CHIP RES.	68k	1/16W	5%	RMC1/16S 683JTH	J24189047		1-	B	d3
R 1539	CHIP RES.	33k	1/16W	5%	RMC1/16S 333JTH	J24189043		1-	A	B2
R 1540	CHIP RES.	390k	1/16W	5%	RMC1/16S 394JTH	J24189056		1-	B	d3
R 1541	CHIP RES.	100k	1/16W	5%	RMC1/16S 104JTH	J24189049		1-	A	A2
R 1542	CHIP RES.	10k	1/16W	5%	RMC1/16S 103JTH	J24189037		1-	A	B2
R 1543	CHIP RES.	47k	1/16W	5%	RMC1/16S 473JTH	J24189045		1-	A	B2
R 1544	CHIP RES.	1k	1/16W	5%	RMC1/16S 102JTH	J24189025		1-	A	B2
R 1545	CHIP RES.	27k	1/16W	5%	RMC1/16S 273JTH	J24189042		1-	A	B2
R 1546	CHIP RES.	47k	1/16W	5%	RMC1/16S 473JTH	J24189045		1-	A	B2
R 1547	CHIP RES.	10k	1/16W	5%	RMC1/16S 103JTH	J24189037		1-	B	d3
R 1548	CHIP RES.	390k	1/16W	5%	RMC1/16S 394JTH	J24189056		1-	A	B2
R 1549	CHIP RES.	47k	1/16W	5%	RMC1/16S 473JTH	J24189045		1-	A	B2
R 1550	CHIP RES.	10k	1/16W	5%	RMC1/16S 103JTH	J24189037		1-	A	B2
R 1551	CHIP RES.	10k	1/16W	5%	RMC1/16S 103JTH	J24189037		1-	B	d3
R 1552	CHIP RES.	56k	1/16W	5%	RMC1/16S 563JTH	J24189046		1-	A	A3
R 1553	CHIP RES.	100k	1/16W	5%	RMC1/16S 104JTH	J24189049		1-	B	d2
R 1554	CHIP RES.	100k	1/16W	5%	RMC1/16S 104JTH	J24189049		1-	B	d2
R 1555	CHIP RES.	47k	1/16W	5%	RMC1/16S 473JTH	J24189045		1-	A	A3
R 1556	CHIP RES.	1k	1/16W	5%	RMC1/16S 102JTH	J24189025		1-	B	d2
R 1557	CHIP RES.	4.7k	1/16W	5%	RMC1/16S 472JTH	J24189033		1-	B	d2
R 1558	CHIP RES.	10k	1/16W	5%	RMC1/16S 103JTH	J24189037		1-	B	d2
R 1559	CHIP RES.	100k	1/16W	5%	RMC1/16S 104JTH	J24189049		1-	A	A2
R 1560	CHIP RES.	100k	1/16W	5%	RMC1/16S 104JTH	J24189049		1-	A	A2
R 1561	CHIP RES.	39k	1/16W	5%	RMC1/16S 393JTH	J24189044		1-	A	A2
R 1562	CHIP RES.	39k	1/16W	5%	RMC1/16S 393JTH	J24189044		1-	A	A2
R 1563	CHIP RES.	39k	1/16W	5%	RMC1/16S 393JTH	J24189044		1-	A	A2
R 1564	CHIP RES.	39k	1/16W	5%	RMC1/16S 393JTH	J24189044		1-	A	A2
R 1565	CHIP RES.	2.2k	1/16W	5%	RMC1/16S 222JTH	J24189029		1-	A	A2
R 1566	CHIP RES.	2.2k	1/16W	5%	RMC1/16S 222JTH	J24189029		1-	A	A2
R 1567	CHIP RES.	10k	1/16W	5%	RMC1/16S 103JTH	J24189037		1-	A	A2
R 1568	CHIP RES.	10k	1/16W	5%	RMC1/16S 103JTH	J24189037		1-	A	A2
R 1569	CHIP RES.	10k	1/16W	5%	RMC1/16S 103JTH	J24189037		1-	A	A2
R 1570	CHIP RES.	10k	1/16W	5%	RMC1/16S 103JTH	J24189037		1-	A	A2
R 1571	CHIP RES.	10k	1/16W	5%	RMC1/16S 103JTH	J24189037		1-	A	A2
R 1572	CHIP RES.	10k	1/16W	5%	RMC1/16S 103JTH	J24189037		1-	A	A2
R 1573	CHIP RES.	0	1/16W	5%	RMC1/16S JPTH	J24189070		1-	A	A2
R 1574	CHIP RES.	390k	1/16W	5%	RMC1/16S 394JTH	J24189056		1-	B	d2
R 1575	CHIP RES.	4.7k	1/16W	5%	RMC1/16S 472JTH	J24189033		1-	B	d2
R 1576	CHIP RES.	1k	1/16W	5%	RMC1/16S 102JTH	J24189025		1-	B	d2
R 1577	CHIP RES.	100	1/16W	5%	RMC1/16S 101JTH	J24189013		1-	A	C4
R 1578	CHIP RES.	1k	1/16W	5%	RMC1/16S 102JTH	J24189025		1-	A	A2
R 1579	CHIP RES.	1k	1/16W	5%	RMC1/16S 102JTH	J24189025		1-	B	d2
R 1580	CHIP RES.	680k	1/16W	5%	RMC1/16S 684JTH	J24189059		1-	B	d2
R 1581	CHIP RES.	220k	1/16W	5%	RMC1/16S 224JTH	J24189053		1-	B	d2
R 1582	CHIP RES.	120k	1/16W	5%	RMC1/16S 124JTH	J24189050		1-	B	d2
R 1583	CHIP RES.	470k	1/16W	5%	RMC1/16S 474JTH	J24189057		1-	B	d3
R 1584	CHIP RES.	470k	1/16W	5%	RMC1/16S 474JTH	J24189057		1-	B	d3
R 1594	CHIP RES.	27k	1/16W	5%	RMC1/16S 273JTH	J24189042		1-	A	B4
R 1595	CHIP RES.	47k	1/16W	5%	RMC1/16S 473JTH	J24189045		1-	A	B4
R 1596	CHIP RES.	47k	1/16W	5%	RMC1/16S 473JTH	J24189045		1-	B	c4

MAIN Unit

Parts List

REF	DESCRIPTION	VALUE	V/W	TOL.	MFR'S DESIG	VXSTD P/N	VERS.	LOT	SIDE	LAY ADR
R 1597	CHIP RES.	100k	1/16W	5%	RMC1/16S 104JTH	J24189049		1-	B	d4
R 1598	CHIP RES.	100k	1/16W	5%	RMC1/16S 104JTH	J24189049		1-	B	d4
R 1599	CHIP RES.	0	1/16W	5%	RMC1/16S JPTH	J24189070		1-	A	B4
R 1600	CHIP RES.	1.8k	1/16W	5%	RMC1/16S 182JTH	J24189028		1-	A	D3
R 1601	CHIP RES.	100	1/16W	5%	RMC1/16S 101JTH	J24189013		1-	A	D3
R 1602	CHIP RES.	100	1/16W	5%	RMC1/16S 101JTH	J24189013		1-	A	D3
R 1603	CHIP RES.	560	1/16W	5%	RMC1/16S 561JTH	J24189022		1-	A	D3
R 1604	CHIP RES.	330k	1/16W	5%	RMC1/16S 334JTH	J24189055		1-	A	D3
R 1605	CHIP RES.	22	1/16W	5%	RMC1/16S 220JTH	J24189005		1-	A	D3
R 1606	CHIP RES.	330	1/16W	5%	RMC1/16S 331JTH	J24189019		1-	A	D3
R 1607	CHIP RES.	470	1/16W	5%	RMC1/16S 471JTH	J24189021		1-	A	D3
R 1608	CHIP RES.	1k	1/16W	5%	RMC1/16S 102JTH	J24189025		1-	A	D3
R 1609	CHIP RES.	100	1/16W	5%	RMC1/16S 101JTH	J24189013		1-	A	D3
R 1610	CHIP RES.	10k	1/16W	0.5%	RR0510P-103-D	J24189143		1-	B	b2
R 1611	CHIP RES.	10k	1/16W	0.5%	RR0510P-103-D	J24189143		1-	B	b2
R 1612	CHIP RES.	1M	1/16W	5%	RMC1/16S 105JTH	J24189061		1-	B	a3
R 1613	CHIP RES.	220k	1/16W	5%	RMC1/16S 224JTH	J24189053		1-	B	a3
R 1614	CHIP RES.	2.2k	1/16W	5%	RMC1/16S 222JTH	J24189029		1-	B	a3
R 1615	CHIP RES.	100	1/16W	5%	RMC1/16S 101JTH	J24189013		1-	A	D4
R 1616	CHIP RES.	100	1/16W	5%	RMC1/16S 101JTH	J24189013		1-	B	a3
R 1617	CHIP RES.	820k	1/16W	5%	RMC1/16S 824JTH	J24189060		1-	B	a3
R 1618	CHIP RES.	1k	1/16W	5%	RMC1/16S 102JTH	J24189025		1-	B	a3
R 1619	CHIP RES.	100k	1/16W	5%	RMC1/16S 104JTH	J24189049		1-	A	D4
R 1621	CHIP RES.	100	1/16W	5%	RMC1/16S 101JTH	J24189013		1-	B	a3
R 1622	CHIP RES.	1M	1/16W	5%	RMC1/16S 105JTH	J24189061		1-	B	a4
R 1623	CHIP RES.	2.2k	1/16W	5%	RMC1/16S 222JTH	J24189029		1-	B	a3
R 1624	CHIP RES.	100	1/16W	5%	RMC1/16S 101JTH	J24189013		1-	B	a3
R 1625	CHIP RES.	100k	1/16W	5%	RMC1/16S 104JTH	J24189049		1-	B	a3
R 1626	CHIP RES.	330	1/16W	5%	RMC1/16S 331JTH	J24189019		1-	B	a3
R 1627	CHIP RES.	100	1/16W	5%	RMC1/16S 101JTH	J24189013		1-	B	a3
R 1628	CHIP RES.	2.2k	1/16W	5%	RMC1/16S 222JTH	J24189029		1-	B	a4
R 1629	CHIP RES.	1k	1/16W	5%	RMC1/16S 102JTH	J24189025		1-	B	a4
R 1630	CHIP RES.	1k	1/16W	5%	RMC1/16S 102JTH	J24189025		1-	B	a4
R 1631	CHIP RES.	1k	1/16W	5%	RMC1/16S 102JTH	J24189025		1-	B	a3
R 1633	CHIP RES.	270k	1/16W	5%	RMC1/16S 274JTH	J24189054		1-	B	a4
R 1635	CHIP RES.	100	1/16W	5%	RMC1/16 101JATP	J24185101		1-	A	D3
R 1636	CHIP RES.	22k	1/16W	5%	RMC1/16S 223JTH	J24189041		1-	A	D3
R 1637	CHIP RES.	4.7k	1/16W	5%	RMC1/16S 472JTH	J24189033		1-	A	C4
R 1638	CHIP RES.	22k	1/16W	5%	RMC1/16S 223JTH	J24189041		1-	A	D4
R 1640	CHIP RES.	22k	1/16W	5%	RMC1/16S 223JTH	J24189041		1-	A	D4
R 1641	CHIP RES.	10k	1/16W	5%	RMC1/16S 103JTH	J24189037		1-	A	D4
R 1642	CHIP RES.	470	1/16W	5%	RMC1/16S 471JTH	J24189021		1-	A	D4
R 1643	CHIP RES.	22k	1/16W	5%	RMC1/16S 223JTH	J24189041		1-	A	D4
R 1645	CHIP RES.	6.8k	1/16W	5%	RMC1/16S 682JTH	J24189035		1-	A	D4
R 1646	CHIP RES.	22k	1/16W	5%	RMC1/16S 223JTH	J24189041		1-	A	D4
R 1647	CHIP RES.	150k	1/16W	5%	RMC1/16S 154JTH	J24189051		1-	A	D4
R 1648	CHIP RES.	150	1/16W	5%	RMC1/16S 151JTH	J24189015		1-	B	a4
R 1649	CHIP RES.	2.2k	1/16W	5%	RMC1/16S 222JTH	J24189029		1-	A	D4
R 1650	CHIP RES.	3.3k	1/16W	5%	RMC1/16S 332JTH	J24189031		1-	A	D4
R 1651	CHIP RES.	3.3k	1/16W	5%	RMC1/16S 332JTH	J24189031		1-	A	D4
R 1652	CHIP RES.	100k	1/16W	5%	RMC1/16S 104JTH	J24189049		1-	A	D4
R 1653	CHIP RES.	1k	1/16W	5%	RMC1/16S 102JTH	J24189025		1-	A	D4
R 1655	CHIP RES.	4.7k	1/16W	5%	RMC1/16S 472JTH	J24189033		1-	A	D4
R 1656	CHIP RES.	150k	1/16W	5%	RMC1/16S 154JTH	J24189051		1-	A	D4
R 1657	CHIP RES.	4.7k	1/16W	5%	RMC1/16S 472JTH	J24189033		1-	A	D4
R 1658	CHIP RES.	100	1/16W	5%	RMC1/16S 101JTH	J24189013		1-	B	b3
R 1659	CHIP RES.	47	1/16W	5%	RMC1/16S 470JTH	J24189009		1-	A	D4
R 1660	CHIP RES.	470k	1/16W	5%	RMC1/16S 474JTH	J24189057		1-	A	D4
R 1661	CHIP RES.	680	1/16W	5%	RMC1/16S 681JTH	J24189023		1-	B	a4
R 1662	CHIP RES.	3.3k	1/16W	5%	RMC1/16S 332JTH	J24189031		1-	B	a4
R 1663	CHIP RES.	100k	1/16W	5%	RMC1/16S 104JTH	J24189049		1-	B	a4
R 1664	CHIP RES.	3.3k	1/16W	5%	RMC1/16S 332JTH	J24189031		1-	B	a4
R 1665	CHIP RES.	47k	1/16W	5%	RMC1/16S 473JTH	J24189045		1-	B	a4
R 1666	CHIP RES.	150k	1/16W	5%	RMC1/16S 154JTH	J24189051		1-	B	a4
R 1667	CHIP RES.	220k	1/16W	5%	RMC1/16S 224JTH	J24189053		1-	B	a4
R 1668	CHIP RES.	470k	1/16W	5%	RMC1/16S 474JTH	J24189057		1-	B	a4
R 1669	CHIP RES.	100k	1/16W	5%	RMC1/16S 104JTH	J24189049		1-	A	C4
R 1670	CHIP RES.	100k	1/16W	5%	RMC1/16S 104JTH	J24189049		1-	A	D4
R 1671	CHIP RES.	10k	1/16W	5%	RMC1/16S 103JTH	J24189037		1-	A	D4
R 1672	CHIP RES.	15k	1/16W	5%	RMC1/16S 153JTH	J24189039		1-	B	b4
R 1673	CHIP RES.	68k	1/16W	5%	RMC1/16S 683JTH	J24189047		1-	B	b4
R 1674	CHIP RES.	390k	1/16W	5%	RMC1/16S 394JTH	J24189056		1-	B	b4
R 1675	CHIP RES.	390k	1/16W	5%	RMC1/16S 394JTH	J24189056		1-	B	b4
R 1676	CHIP RES.	33k	1/16W	5%	RMC1/16S 333JTH	J24189043		1-	A	D4
R 1677	CHIP RES.	330k	1/16W	5%	RMC1/16S 334JTH	J24189055		1-	A	D4

MAIN Unit

Parts List

REF	DESCRIPTION	VALUE	V/W	TOL.	MFR'S DESIG	VXSTD P/N	VERS.	LOT	SIDE	LAY ADR
R 1678	CHIP RES.	330k	1/16W	5%	RMC1/16S 334JTH	J24189055		1-	A	D4
R 1679	CHIP RES.	100k	1/16W	5%	RMC1/16S 104JTH	J24189049		1-	A	C4
R 1680	CHIP RES.	330k	1/16W	5%	RMC1/16S 334JTH	J24189055		1-	A	D4
R 1681	CHIP RES.	10k	1/16W	5%	RMC1/16S 103JTH	J24189037		1-	A	D4
R 1682	CHIP RES.	33k	1/16W	5%	RMC1/16S 333JTH	J24189043		1-	A	C4
R 1683	CHIP RES.	56k	1/16W	0.5%	RR0510R-563-D	J24189161		1-	A	D4
R 1684	CHIP RES.	220k	1/16W	5%	RMC1/16S 224JTH	J24189053		1-	A	D4
R 1685	CHIP RES.	39k	1/16W	5%	RMC1/16S 393JTH	J24189044		1-	A	D4
R 1686	CHIP RES.	47k	1/16W	5%	RMC1/16S 473JTH	J24189045		1-	B	b4
R 1687	CHIP RES.	390k	1/16W	5%	RMC1/16S 394JTH	J24189056		1-	B	b4
R 1688	CHIP RES.	390k	1/16W	5%	RMC1/16S 394JTH	J24189056		1-	B	b4
R 1689	CHIP RES.	1k	1/16W	5%	RMC1/16S 102JTH	J24189025		1-	A	D4
R 1690	CHIP RES.	33k	1/16W	5%	RMC1/16S 333JTH	J24189043		1-	A	C4
R 1691	CHIP RES.	27k	1/16W	5%	RMC1/16S 273JTH	J24189042		1-	A	C4
R 1692	CHIP RES.	10k	1/16W	5%	RMC1/16S 103JTH	J24189037		1-	A	D4
R 1693	CHIP RES.	100k	1/16W	5%	RMC1/16S 104JTH	J24189049		1-	B	b4
R 1694	CHIP RES.	390k	1/16W	5%	RMC1/16S 394JTH	J24189056		1-	A	C4
R 1695	CHIP RES.	47k	1/16W	5%	RMC1/16S 473JTH	J24189045		1-	B	b4
R 1696	CHIP RES.	68k	1/16W	5%	RMC1/16S 683JTH	J24189047		1-	B	c4
R 1697	CHIP RES.	68k	1/16W	5%	RMC1/16S 683JTH	J24189047		1-	B	c4
R 1698	CHIP RES.	10k	1/16W	5%	RMC1/16S 103JTH	J24189037		1-	A	C4
R 1699	CHIP RES.	47k	1/16W	5%	RMC1/16S 473JTH	J24189045		1-	A	C4
R 1700	CHIP RES.	33k	1/16W	5%	RMC1/16S 333JTH	J24189043		1-	A	C4
R 1701	CHIP RES.	47k	1/16W	5%	RMC1/16S 473JTH	J24189045		1-	A	C4
R 1702	CHIP RES.	22k	1/16W	5%	RMC1/16S 223JTH	J24189041		1-	A	B4
R 1703	CHIP RES.	10k	1/16W	5%	RMC1/16S 103JTH	J24189037		1-	B	c4
R 1704	CHIP RES.	39k	1/16W	5%	RMC1/16S 393JTH	J24189044		1-	B	c3
R 1705	CHIP RES.	10k	1/16W	5%	RMC1/16S 103JTH	J24189037		1-	B	c4
R 1706	CHIP RES.	18k	1/16W	5%	RMC1/16S 183JTH	J24189040		1-	B	c4
R 1707	CHIP RES.	22k	1/16W	5%	RMC1/16S 223JTH	J24189041		1-	B	c4
R 1708	CHIP RES.	10k	1/16W	5%	RMC1/16S 103JTH	J24189037		1-	A	A3
R 1709	CHIP RES.	10k	1/16W	5%	RMC1/16S 103JTH	J24189037		1-	B	c4
R 1710	CHIP RES.	4.7k	1/16W	5%	RMC1/16S 472JTH	J24189033		1-	B	c4
R 1711	CHIP RES.	15k	1/16W	5%	RMC1/16S 153JTH	J24189039		1-	B	c4
R 1712	CHIP RES.	4.7	1/16W	5%	RMC1/16S 4R7JTH	J24189066	W/ CE LABEL	5-8	A	C4
R 1712	CHIP RES.	4.7	1/16W	5%	RMC1/16S 4R7JTH	J24189066		9-	A	C4
R 1713	CHIP RES.	47k	1/16W	5%	RMC1/16S 473JTH	J24189045		1-	A	B4
R 1714	CHIP RES.	10k	1/16W	5%	RMC1/16S 103JTH	J24189037		1-	B	c4
R 1715	CHIP RES.	10k	1/16W	5%	RMC1/16S 103JTH	J24189037		1-	A	B3
R 1716	CHIP RES.	12k	1/16W	5%	RMC1/16S 123JTH	J24189038		1-	A	B4
R 1717	CHIP RES.	10k	1/16W	5%	RMC1/16S 103JTH	J24189037		1-	B	c4
R 1718	CHIP RES.	0	1/16W	5%	RMC1/16S JPTH	J24189070	W/O CE LABEL	9-		
R 1725	CHIP RES.	100k	1/16W	5%	RMC1/16S 104JTH	J24189049		1-	A	C4
R 1726	CHIP RES.	22k	1/16W	5%	RMC1/16S 223JTH	J24189041		1-	B	d4
R 1727	CHIP RES.	33	1/16W	5%	RMC1/16S 330JTH	J24189007		1-	B	e2
R 1728	CHIP RES.	33	1/16W	5%	RMC1/16S 330JTH	J24189007		1-	B	e2
R 1729	CHIP RES.	33	1/16W	5%	RMC1/16S 330JTH	J24189007		1-	B	e2
R 1730	CHIP RES.	33	1/16W	5%	RMC1/16S 330JTH	J24189007		1-	B	e2
R 1731	CHIP RES.	33	1/16W	5%	RMC1/16S 330JTH	J24189007		1-	B	e2
R 1732	CHIP RES.	33	1/16W	5%	RMC1/16S 330JTH	J24189007		1-	B	e2
R 1733	CHIP RES.	33	1/16W	5%	RMC1/16S 330JTH	J24189007		1-	B	e2
R 1734	CHIP RES.	33	1/16W	5%	RMC1/16S 330JTH	J24189007		1-	B	e2
R 1735	CHIP RES.	33	1/16W	5%	RMC1/16S 330JTH	J24189007		1-	B	e2
R 1736	CHIP RES.	33	1/16W	5%	RMC1/16S 330JTH	J24189007		1-	B	e2
R 1737	CHIP RES.	33	1/16W	5%	RMC1/16S 330JTH	J24189007		1-	B	e2
R 1738	CHIP RES.	33	1/16W	5%	RMC1/16S 330JTH	J24189007		1-	B	d1
R 1739	CHIP RES.	33	1/16W	5%	RMC1/16S 330JTH	J24189007		1-	B	d1
R 1740	CHIP RES.	33	1/16W	5%	RMC1/16S 330JTH	J24189007		1-	B	d1
R 1741	CHIP RES.	33	1/16W	5%	RMC1/16S 330JTH	J24189007		1-	B	d1
R 1742	CHIP RES.	33	1/16W	5%	RMC1/16S 330JTH	J24189007		1-	B	d1
R 1743	CHIP RES.	33	1/16W	5%	RMC1/16S 330JTH	J24189007		1-	B	d1
R 1744	CHIP RES.	33	1/16W	5%	RMC1/16S 330JTH	J24189007		1-	B	d1
R 1745	CHIP RES.	33	1/16W	5%	RMC1/16S 330JTH	J24189007		1-	B	d1
R 1746	CHIP RES.	33	1/16W	5%	RMC1/16S 330JTH	J24189007		1-	B	d1
R 1747	CHIP RES.	33	1/16W	5%	RMC1/16S 330JTH	J24189007		1-	B	d1
R 1748	CHIP RES.	33	1/16W	5%	RMC1/16S 330JTH	J24189007		1-	B	d1
R 1749	CHIP RES.	33	1/16W	5%	RMC1/16S 330JTH	J24189007		1-	B	d1
R 1750	CHIP RES.	470k	1/16W	5%	RMC1/16S 474JTH	J24189057		1-	B	d2
R 1751	CHIP RES.	470k	1/16W	5%	RMC1/16S 474JTH	J24189057		1-	B	d2
R 1752	CHIP RES.	22k	1/16W	5%	RMC1/16S 223JTH	J24189041		1-	B	d2
R 1753	CHIP RES.	22k	1/16W	5%	RMC1/16S 223JTH	J24189041		1-	B	d2
R 1754	CHIP RES.	100k	1/16W	5%	RMC1/16S 104JTH	J24189049		1-	B	d2
R 1755	CHIP RES.	100k	1/16W	5%	RMC1/16S 104JTH	J24189049		1-	B	d2
R 1756	CHIP RES.	33	1/16W	5%	RMC1/16S 330JTH	J24189007		1-	B	d1
R 1757	CHIP RES.	1M	1/16W	5%	RMC1/16S 105JTH	J24189061		1-	B	d1

MAIN Unit

Parts List

REF	DESCRIPTION	VALUE	V/W	TOL.	MFR'S DESIG	VXSTD P/N	VERS.	LOT	SIDE	LAY ADR
R 1758	CHIP RES.	33	1/16W	5%	RMC1/16S 330JTH	J24189007		1-	B	d1
R 1759	CHIP RES.	2.2k	1/16W	5%	RMC1/16S 222JTH	J24189029		1-	B	d2
R 1760	CHIP RES.	2.2k	1/16W	5%	RMC1/16S 222JTH	J24189029		1-	B	d2
R 1761	CHIP RES.	22k	1/16W	5%	RMC1/16S 223JTH	J24189041		1-	B	d2
R 1762	CHIP RES.	33	1/16W	5%	RMC1/16S 330JTH	J24189007		1-	B	d1
R 1763	CHIP RES.	33	1/16W	5%	RMC1/16S 330JTH	J24189007		1-	B	d1
R 1764	CHIP RES.	33	1/16W	5%	RMC1/16S 330JTH	J24189007		1-	B	d1
R 1765	CHIP RES.	100k	1/16W	5%	RMC1/16S 104JTH	J24189049		1-	B	d1
R 1766	CHIP RES.	100k	1/16W	5%	RMC1/16S 104JTH	J24189049		1-	B	d1
R 1767	CHIP RES.	33	1/16W	5%	RMC1/16S 330JTH	J24189007		1-	B	d1
R 1768	CHIP RES.	33	1/16W	5%	RMC1/16S 330JTH	J24189007		1-	B	d1
R 1769	CHIP RES.	33	1/16W	5%	RMC1/16S 330JTH	J24189007		1-	B	d1
R 1770	CHIP RES.	33	1/16W	5%	RMC1/16S 330JTH	J24189007		1-	B	d1
R 1771	CHIP RES.	33	1/16W	5%	RMC1/16S 330JTH	J24189007		1-	B	d1
R 1772	CHIP RES.	47k	1/16W	5%	RMC1/16S 473JTH	J24189045		1-	B	d1
R 1773	CHIP RES.	22k	1/16W	5%	RMC1/16S 223JTH	J24189041		1-	B	d2
R 1774	CHIP RES.	22k	1/16W	5%	RMC1/16S 223JTH	J24189041		1-	B	d2
R 1775	CHIP RES.	2.2k	1/16W	5%	RMC1/16S 222JTH	J24189029		1-	B	d1
R 1776	CHIP RES.	22k	1/16W	5%	RMC1/16S 223JTH	J24189041		1-	A	A2
R 1777	CHIP RES.	22k	1/16W	5%	RMC1/16S 223JTH	J24189041		1-	B	d1
R 1778	CHIP RES.	22k	1/16W	5%	RMC1/16S 223JTH	J24189041		1-	B	d1
R 1779	CHIP RES.	1k	1/16W	5%	RMC1/16S 102JTH	J24189025		1-	B	d1
R 1780	CHIP RES.	1k	1/16W	5%	RMC1/16S 102JTH	J24189025		1-	B	d1
R 1781	CHIP RES.	10k	1/16W	5%	RMC1/16S 103JTH	J24189037		1-	B	d1
R 1782	CHIP RES.	2.2k	1/16W	5%	RMC1/16S 222JTH	J24189029		1-	B	d1
R 1783	CHIP RES.	2.2k	1/16W	5%	RMC1/16S 222JTH	J24189029		1-	B	d1
R 1784	CHIP RES.	470k	1/16W	5%	RMC1/16S 474JTH	J24189057		1-	B	d1
R 1785	CHIP RES.	4.7	1/16W	5%	RMC1/16S 4R7JTH	J24189066		1-	B	c2
R 1786	CHIP RES.	4.7	1/16W	5%	RMC1/16S 4R7JTH	J24189066		1-	B	d2
R 1787	CHIP RES.	4.7k	1/16W	5%	RMC1/16S 472JTH	J24189033		1-	B	c4
R 1788	CHIP RES.	4.7k	1/16W	5%	RMC1/16S 472JTH	J24189033		1-	A	C4
R 1789	CHIP RES.	10k	1/16W	5%	RMC1/16S 103JTH	J24189037		1-	A	C4
R 1790	CHIP RES.	15k	1/16W	5%	RMC1/16S 153JTH	J24189039		1-	A	C4
R 1791	CHIP RES.	2.2M	1/16W	5%	RMC1/16S 225JTH	J24189065		1-	A	C4
R 1792	CHIP RES.	47k	1/16W	5%	RMC1/16S 473JTH	J24189045		1-	A	C4
R 1793	CHIP RES.	1k	1/16W	5%	RMC1/16S 102JTH	J24189025		1-	A	C4
R 1794	CHIP RES.	4.7k	1/16W	5%	RMC1/16S 472JTH	J24189033		1-	A	C4
R 1795	CHIP RES.	33k	1/16W	5%	RMC1/16S 333JTH	J24189043		1-	A	C4
R 1796	CHIP RES.	150k	1/16W	5%	RMC1/16S 154JTH	J24189051		1-	A	C4
R 1797	CHIP RES.	100k	1/16W	0.5%	RR0510R-104-D	J24189167		1-	A	C4
R 1798	CHIP RES.	4.7k	1/16W	5%	RMC1/16S 472JTH	J24189033		1-	B	c4
R 1799	CHIP RES.	100k	1/16W	0.5%	RR0510R-104-D	J24189167		1-	A	C4
R 1800	CHIP RES.	10k	1/16W	5%	RMC1/16S 103JTH	J24189037		1-	B	c4
R 1801	CHIP RES.	15k	1/16W	5%	RMC1/16S 153JTH	J24189039		1-	A	C4
R 1802	CHIP RES.	100k	1/16W	5%	RMC1/16S 104JTH	J24189049		1-	A	D5
R 1803	CHIP RES.	1k	1/16W	5%	RMC1/16S 102JTH	J24189025		1-	B	c1
R 1804	CHIP RES.	1k	1/16W	5%	RMC1/16S 102JTH	J24189025		1-	B	c1
R 1805	CHIP RES.	150k	1/16W	5%	RMC1/16S 154JTH	J24189051		1-	B	d4
R 1806	CHIP RES.	4.7k	1/16W	5%	RMC1/16S 472JTH	J24189033		1-	B	c1
R 1807	CHIP RES.	12k	1/16W	5%	RMC1/16S 123JTH	J24189038		1-	A	B4
R 1808	CHIP RES.	100	1/16W	5%	RMC1/16S 101JTH	J24189013		1-	B	c1
R 1809	CHIP RES.	100	1/16W	5%	RMC1/16S 101JTH	J24189013		1-	B	c1
R 1810	CHIP RES.	4.7k	1/16W	5%	RMC1/16S 472JTH	J24189033		1-	B	c1
R 1811	CHIP RES.	100k	1/16W	5%	RMC1/16S 104JTH	J24189049		1-	A	D4
R 1812	CHIP RES.	1k	1/16W	5%	RMC1/16S 102JTH	J24189025		1-	A	B3
R 1813	CHIP RES.	22k	1/16W	5%	RMC1/16S 223JTH	J24189041		1-	B	c3
R 1814	CHIP RES.	220	1/16W	5%	RMC1/16S 221JTH	J24189017		1-	B	d1
R 1815	CHIP RES.	220	1/16W	5%	RMC1/16S 221JTH	J24189017		1-	B	d1
R 1816	CHIP RES.	220	1/16W	5%	RMC1/16S 221JTH	J24189017		1-	B	d1
R 1817	CHIP RES.	220	1/16W	5%	RMC1/16S 221JTH	J24189017		1-	B	d1
R 1818	CHIP RES.	100k	1/16W	5%	RMC1/16S 104JTH	J24189049		1-	B	d1
R 1819	CHIP RES.	47k	1/16W	5%	RMC1/16S 473JTH	J24189045		1-	B	d3
R 1820	CHIP RES.	100k	1/16W	0.5%	RR0510R-104-D	J24189167		1-	B	d3
R 1821	CHIP RES.	22k	1/16W	5%	RMC1/16S 223JTH	J24189041		1-	B	d3
R 1822	CHIP RES.	100k	1/16W	0.5%	RR0510R-104-D	J24189167		1-	B	d3
R 1823	CHIP RES.	100k	1/16W	0.5%	RR0510R-104-D	J24189167		1-	B	d3
R 1824	CHIP RES.	470k	1/16W	5%	RMC1/16S 474JTH	J24189057		1-	B	d3
R 1825	CHIP RES.	100k	1/16W	0.5%	RR0510R-104-D	J24189167		1-	B	d2
R 1826	CHIP RES.	10k	1/16W	5%	RMC1/16S 103JTH	J24189037		1-	B	d3
R 1827	CHIP RES.	15k	1/16W	5%	RMC1/16S 153JTH	J24189039		1-	B	d3
R 1828	CHIP RES.	22k	1/16W	5%	RMC1/16S 223JTH	J24189041		1-	B	d3
R 1829	CHIP RES.	100k	1/16W	5%	RMC1/16S 104JTH	J24189049		1-	A	A4
R 1830	CHIP RES.	22k	1/16W	5%	RMC1/16S 223JTH	J24189041		1-	A	A3
R 1831	CHIP RES.	47	1/16W	5%	RMC1/16S 470JTH	J24189009		1-	A	A4
R 1832	CHIP RES.	47k	1/16W	5%	RMC1/16S 473JTH	J24189045		1-	A	A3

MAIN Unit

Parts List

REF	DESCRIPTION	VALUE	V/W	TOL.	MFR'S DESIG	VXSTD P/N	VERS.	LOT	SIDE	LAY ADR
R 1833	CHIP RES.	1M	1/16W	5%	RMC1/16S 105JTH	J24189061		1-	B	d4
R 1834	CHIP RES.	47k	1/16W	5%	RMC1/16S 473JTH	J24189045		1-	B	d4
R 1835	CHIP RES.	3.3M	1/16W	5%	RMC1/16S 335JTH	J24189324		1-	B	d4
R 1836	CHIP RES.	3.3M	1/16W	5%	RMC1/16S 335JTH	J24189324		1-	B	d4
R 1837	CHIP RES.	330k	1/16W	5%	RMC1/16S 334JTH	J24189055		1-	B	d3
R 1838	CHIP RES.	100	1/16W	5%	RMC1/16S 101JTH	J24189013		1-	B	c1
R 1839	CHIP RES.	470k	1/16W	5%	RMC1/16S 474JTH	J24189057		1-	B	d4
R 1840	CHIP RES.	680k	1/16W	5%	RMC1/16S 684JTH	J24189059		1-	B	d4
R 1841	CHIP RES.	1M	1/16W	5%	RMC1/16S 105JTH	J24189061		1-	A	B4
R 1842	CHIP RES.	47k	1/16W	5%	RMC1/16S 473JTH	J24189045		1-	A	B4
R 1843	CHIP RES.	470k	1/16W	5%	RMC1/16S 474JTH	J24189057		1-	B	d4
R 1844	CHIP RES.	680k	1/16W	5%	RMC1/16S 684JTH	J24189059		1-	B	d4
R 1845	CHIP RES.	0	1/16W	5%	RMC1/16S JPTH	J24189070		1-	A	C4
R 1847	CHIP RES.	27k	1/16W	5%	RMC1/16S 273JTH	J24189042		1-	B	d4
R 1848	CHIP RES.	68k	1/16W	5%	RMC1/16S 683JTH	J24189047		1-	B	d4
R 1849	CHIP RES.	10k	1/16W	5%	RMC1/16S 103JTH	J24189037		1-	B	d4
R 1850	CHIP RES.	100k	1/16W	5%	RMC1/16S 104JTH	J24189049		1-	B	d4
R 1851	CHIP RES.	100k	1/16W	5%	RMC1/16S 104JTH	J24189049		1-	B	d4
R 1852	CHIP RES.	220k	1/16W	5%	RMC1/16S 224JTH	J24189053		1-	B	d5
R 1853	CHIP RES.	10k	1/16W	5%	RMC1/16S 103JTH	J24189037		1-	B	c5
R 1854	CHIP RES.	47k	1/16W	5%	RMC1/16S 473JTH	J24189045		1-	B	d4
R 1857	CHIP RES.	33k	1/16W	5%	RMC1/16S 333JTH	J24189043		1-	B	d4
R 1860	CHIP RES.	68k	1/16W	0.5%	RR0510R-683-D	J24189163		1-	A	B3
R 1861	CHIP RES.	100k	1/16W	0.5%	RR0510R-104-D	J24189167		1-	A	B3
R 1862	CHIP RES.	100k	1/16W	0.5%	RR0510R-104-D	J24189167		1-	A	B3
R 1863	CHIP RES.	100k	1/16W	0.5%	RR0510R-104-D	J24189167		1-	A	B3
R 1864	CHIP RES.	100k	1/16W	0.5%	RR0510R-104-D	J24189167		1-	A	B3
R 1865	CHIP RES.	100k	1/16W	0.5%	RR0510R-104-D	J24189167		1-	A	B3
R 1866	CHIP RES.	390k	1/16W	5%	RMC1/16S 394JTH	J24189056		1-	A	B3
R 1867	CHIP RES.	3.3M	1/16W	5%	RMC1/16S 335JTH	J24189324		1-	A	B3
R 1868	CHIP RES.	820k	1/16W	5%	RMC1/16S 824JTH	J24189060		1-	A	B3
R 1869	CHIP RES.	1.5M	1/16W	5%	RMC1/16S 155JTH	J24189063		1-	A	B3
R 1870	CHIP RES.	1.5M	1/16W	5%	RMC1/16S 155JTH	J24189063		1-	A	B3
R 1871	CHIP RES.	8.2k	1/16W	5%	RMC1/16S 822JTH	J24189036		1-	B	c3
R 1872	CHIP RES.	15k	1/16W	5%	RMC1/16S 153JTH	J24189039		1-	B	c3
R 1873	CHIP RES.	100k	1/16W	5%	RMC1/16S 104JTH	J24189049		1-	A	B5
R 1874	CHIP RES.	100k	1/16W	5%	RMC1/16S 104JTH	J24189049		1-	A	B5
R 1875	CHIP RES.	100	1/16W	5%	RMC1/16S 101JTH	J24189013		1-	A	A4
R 1876	CHIP RES.	1M	1/16W	5%	RMC1/16S 105JTH	J24189061		1-	A	A5
R 1877	CHIP RES.	51k	1/16W	5%	RMC1/16S 513JTH	J24189391		1-	A	B4
R 1878	CHIP RES.	470k	1/16W	5%	RMC1/16S 474JTH	J24189057		1-	B	c2
R 1879	CHIP RES.	330k	1/16W	5%	RMC1/16S 334JTH	J24189055		1-	A	B4
R 1880	CHIP RES.	68k	1/16W	5%	RMC1/16S 683JTH	J24189047		1-	A	B4
R 1881	CHIP RES.	100k	1/16W	5%	RMC1/16S 104JTH	J24189049		1-	A	B4
R 1882	CHIP RES.	56k	1/16W	5%	RMC1/16S 563JTH	J24189046		1-	A	B4
R 1883	CHIP RES.	150k	1/16W	5%	RMC1/16S 154JTH	J24189051		1-	A	B4
R 1884	CHIP RES.	150k	1/16W	5%	RMC1/16S 154JTH	J24189051		1-	A	B4
R 1885	CHIP RES.	82k	1/16W	5%	RMC1/16S 823JTH	J24189048		1-	A	B4
R 1886	CHIP RES.	470k	1/16W	5%	RMC1/16S 474JTH	J24189057		1-	A	B4
R 1887	CHIP RES.	68k	1/16W	5%	RMC1/16S 683JTH	J24189047		1-	A	B4
R 1888	CHIP RES.	10k	1/16W	5%	RMC1/16S 103JTH	J24189037		1-	A	B4
R 1889	CHIP RES.	220k	1/16W	5%	RMC1/16S 224JTH	J24189053		1-	A	B4
R 1890	CHIP RES.	270k	1/16W	5%	RMC1/16S 274JTH	J24189054		1-	A	B4
R 1891	CHIP RES.	220k	1/16W	5%	RMC1/16S 224JTH	J24189053		1-	A	B4
R 1892	CHIP RES.	220k	1/16W	5%	RMC1/16S 224JTH	J24189053		1-	A	B4
R 1893	CHIP RES.	3.9k	1/16W	0.5%	RR0510P-392-D	J24189133		1-	A	B4
R 1894	CHIP RES.	22k	1/16W	5%	RMC1/16S 223JTH	J24189041		1-	A	B4
R 1895	CHIP RES.	4.7k	1/16W	0.5%	RR0510P-472-D	J24189135		1-	A	B4
R 1896	CHIP RES.	1M	1/16W	5%	RMC1/16S 105JTH	J24189061		1-	A	B4
R 1897	CHIP RES.	56k	1/16W	0.5%	RR0510R-563-D	J24189161		1-	A	B4
R 1898	CHIP RES.	100k	1/16W	0.5%	RR0510R-104-D	J24189167		1-	A	B4
R 1899	CHIP RES.	100k	1/16W	0.5%	RR0510R-104-D	J24189167		1-	A	B4
R 1900	CHIP RES.	470k	1/16W	5%	RMC1/16S 474JTH	J24189057		1-	A	B5
R 1901	CHIP RES.	10k	1/16W	5%	RMC1/16S 103JTH	J24189037		1-	A	B4
R 1902	CHIP RES.	8.2k	1/16W	5%	RMC1/16S 822JTH	J24189036		1-	B	b3
R 1903	CHIP RES.	15k	1/16W	5%	RMC1/16S 153JTH	J24189039		1-	B	a3
R 1904	CHIP RES.	10k	1/16W	5%	RMC1/16S 103JTH	J24189037		1-	A	A4
R 1905	CHIP RES.	68k	1/16W	0.5%	RR0510R-683-D	J24189163		1-	B	a2
R 1906	CHIP RES.	100k	1/16W	0.5%	RR0510R-104-D	J24189167		1-	B	a2
R 1907	CHIP RES.	10k	1/16W	5%	RMC1/16S 103JTH	J24189037		1-	B	a2
R 1908	CHIP RES.	68k	1/16W	0.5%	RR0510R-683-D	J24189163		1-	B	a2
R 1909	CHIP RES.	100k	1/16W	0.5%	RR0510R-104-D	J24189167		1-	B	a2
R 1910	CHIP RES.	10k	1/16W	5%	RMC1/16S 103JTH	J24189037		1-	B	a2
R 1911	CHIP RES.	2.2k	1/16W	5%	RMC1/16S 222JTH	J24189029		1-	A	C3
R 1912	CHIP RES.	100k	1/16W	5%	RMC1/16S 104JTH	J24189049		1-	A	C3

MAIN Unit

Parts List

REF	DESCRIPTION	VALUE	V/W	TOL.	MFR'S DESIG	VXSTD P/N	VERS.	LOT	SIDE	LAY ADR
R 1913	CHIP RES.	100k	1/16W	5%	RMC1/16S 104JTH	J24189049		1-	A	C3
R 1914	CHIP RES.	2.2k	1/16W	5%	RMC1/16S 222JTH	J24189029		1-	A	C3
R 1915	CHIP RES.	0	1/16W	5%	RMC1/16S JPTH	J24189070	VER.A2 DST:USA	1-	A	B4
R 1915	CHIP RES.	0	1/16W	5%	RMC1/16S JPTH	J24189070	VERSION A1	1-	A	B4
R 1915	CHIP RES.	0	1/16W	5%	RMC1/16S JPTH	J24189070	VERSION A2	1-	A	B4
R 1915	CHIP RES.	0	1/16W	5%	RMC1/16S JPTH	J24189070	VERSION A3	1-	A	B4
R 1915	CHIP RES.	0	1/16W	5%	RMC1/16S JPTH	J24189070	VERSION C1	1-	A	B4
R 1915	CHIP RES.	0	1/16W	5%	RMC1/16S JPTH	J24189070	VERSION C2	1-	A	B4
R 1915	CHIP RES.	0	1/16W	5%	RMC1/16S JPTH	J24189070	VERSION C3	1-	A	B4
R 1915	CHIP RES.	0	1/16W	5%	RMC1/16S JPTH	J24189070	VERSION D1	1-	A	B4
R 1915	CHIP RES.	0	1/16W	5%	RMC1/16S JPTH	J24189070	VERSION H1	1-	A	B4
R 1915	CHIP RES.	0	1/16W	5%	RMC1/16S JPTH	J24189070	VERSION H2	1-	A	B4
R 1916	CHIP RES.	0	1/16W	5%	RMC1/16S JPTH	J24189070	VER.A2 DST:USA	1-	A	B4
R 1916	CHIP RES.	0	1/16W	5%	RMC1/16S JPTH	J24189070	VERSION A1	1-	A	B4
R 1916	CHIP RES.	0	1/16W	5%	RMC1/16S JPTH	J24189070	VERSION A2	1-	A	B4
R 1916	CHIP RES.	0	1/16W	5%	RMC1/16S JPTH	J24189070	VERSION A3	1-	A	B4
R 1916	CHIP RES.	0	1/16W	5%	RMC1/16S JPTH	J24189070	VERSION B1	1-	A	B4
R 1916	CHIP RES.	0	1/16W	5%	RMC1/16S JPTH	J24189070	VERSION B2	1-	A	B4
R 1916	CHIP RES.	0	1/16W	5%	RMC1/16S JPTH	J24189070	VERSION B3	1-	A	B4
R 1916	CHIP RES.	0	1/16W	5%	RMC1/16S JPTH	J24189070	VERSION H1	1-	A	B4
R 1916	CHIP RES.	0	1/16W	5%	RMC1/16S JPTH	J24189070	VERSION H2	1-	A	B4
R 1917	CHIP RES.	0	1/16W	5%	RMC1/16S JPTH	J24189070	VERSION A1	1-	A	B4
R 1917	CHIP RES.	0	1/16W	5%	RMC1/16S JPTH	J24189070	VERSION A2	1-	A	B4
R 1917	CHIP RES.	0	1/16W	5%	RMC1/16S JPTH	J24189070	VERSION B1	1-	A	B4
R 1917	CHIP RES.	0	1/16W	5%	RMC1/16S JPTH	J24189070	VERSION B2	1-	A	B4
R 1917	CHIP RES.	0	1/16W	5%	RMC1/16S JPTH	J24189070	VERSION C1	1-	A	B4
R 1917	CHIP RES.	0	1/16W	5%	RMC1/16S JPTH	J24189070	VERSION C2	1-	A	B4
R 1917	CHIP RES.	0	1/16W	5%	RMC1/16S JPTH	J24189070	VERSION H1	1-	A	B4
R 1917	CHIP RES.	0	1/16W	5%	RMC1/16S JPTH	J24189070	VERSION H2	1-	A	B4
R 1918	CHIP RES.	0	1/16W	5%	RMC1/16S JPTH	J24189070	VER.A2 DST:USA	1-	A	B4
R 1918	CHIP RES.	0	1/16W	5%	RMC1/16S JPTH	J24189070	VERSION A1	1-	A	B4
R 1918	CHIP RES.	0	1/16W	5%	RMC1/16S JPTH	J24189070	VERSION B1	1-	A	B4
R 1918	CHIP RES.	0	1/16W	5%	RMC1/16S JPTH	J24189070	VERSION C1	1-	A	B4
R 1918	CHIP RES.	0	1/16W	5%	RMC1/16S JPTH	J24189070	VERSION D1	1-	A	B4
R 1918	CHIP RES.	0	1/16W	5%	RMC1/16S JPTH	J24189070	VERSION D2	1-	A	B4
R 1918	CHIP RES.	0	1/16W	5%	RMC1/16S JPTH	J24189070	VERSION H1	1-	A	B4
R 1919	CHIP RES.	2.2k	1/16W	0.5%	RR0510P-222-D	J24189127		1-	A	C2
R 1920	CHIP RES.	1k	1/16W	5%	RMC1/16S 102JTH	J24189025		1-	A	C2
R 1921	CHIP RES.	22k	1/16W	5%	RMC1/16S 223JTH	J24189041		1-	A	A4
R 1922	CHIP RES.	1k	1/16W	5%	RMC1/16S 102JTH	J24189025		1-	B	d4
R 1923	CHIP RES.	1k	1/16W	5%	RMC1/16S 102JTH	J24189025		1-	A	A4
R 1924	CHIP RES.	1k	1/16W	5%	RMC1/16S 102JTH	J24189025		1-	A	A4
R 1925	CHIP RES.	1k	1/16W	5%	RMC1/16S 102JTH	J24189025		1-	A	A4
R 1926	CHIP RES.	1k	1/16W	5%	RMC1/16S 102JTH	J24189025		1-	A	A4
R 1927	CHIP RES.	1k	1/16W	5%	RMC1/16S 102JTH	J24189025		1-	B	d4
R 1928	CHIP RES.	1k	1/16W	5%	RMC1/16S 102JTH	J24189025		1-	A	A4
R 1929	CHIP RES.	1k	1/16W	5%	RMC1/16S 102JTH	J24189025		1-	A	A4
R 1930	CHIP RES.	1k	1/16W	5%	RMC1/16S 102JTH	J24189025		1-	A	A4
R 1931	CHIP RES.	1k	1/16W	5%	RMC1/16S 102JTH	J24189025		1-	A	A4
R 1932	CHIP RES.	1k	1/16W	5%	RMC1/16S 102JTH	J24189025		1-	A	A4
R 1933	CHIP RES.	100k	1/16W	5%	RMC1/16S 104JTH	J24189049		1-	B	d4
R 1934	CHIP RES.	220k	1/16W	5%	RMC1/16S 224JTH	J24189053		1-	A	A3
R 1935	CHIP RES.	10	1/16W	5%	RMC1/16S 100JTH	J24189001		1-4	A	C4
R 1935	CHIP RES.	4.7	1/16W	5%	RMC1/16S 4R7JTH	J24189066	W/ CE LABEL	5-8	A	C4
R 1935	CHIP RES.	10	1/16W	5%	RMC1/16S 100JTH	J24189001	W/O CE LABEL	5-8	A	C4
R 1935	CHIP RES.	4.7	1/16W	5%	RMC1/16S 4R7JTH	J24189066		9-	A	C4
R 1936	CHIP RES.	47k	1/16W	5%	RMC1/16S 473JTH	J24189045		1-	A	A3
R 1937	CHIP RES.	120k	1/16W	5%	RMC1/16S 124JTH	J24189050		1-	A	A3
R 1938	CHIP RES.	470k	1/16W	5%	RMC1/16S 474JTH	J24189057		1-	B	d4
R 1939	CHIP RES.	470k	1/16W	5%	RMC1/16S 474JTH	J24189057		1-	B	d4
R 1940	CHIP RES.	22k	1/16W	5%	RMC1/16S 223JTH	J24189041		1-	B	d2
R 1941	CHIP RES.	68k	1/16W	5%	RMC1/16S 683JTH	J24189047		1-4	A	A4
R 1941	CHIP RES.	68k	1/16W	5%	RMC1/16S 683JTH	J24189047	W/ CE LABEL	5-	A	A4
R 1941	CHIP RES.	68k	1/16W	5%	RMC1/16S 683JTH	J24189047	W/O CE LABEL	5-	A	A4
R 1942	CHIP RES.	1k	1/16W	5%	RMC1/16S 102JTH	J24189025		1-	B	c1
R 1943	CHIP RES.	220k	1/16W	5%	RMC1/16S 224JTH	J24189053		1-	A	B1
R 1944	CHIP RES.	100	1/16W	5%	RMC1/16S 101JTH	J24189013		1-	B	c1
R 1945	CHIP RES.	33k	1/16W	5%	RMC1/16S 333JTH	J24189043		1-	B	a4
R 1946	CHIP RES.	15k	1/16W	5%	RMC1/16S 153JTH	J24189039		1-	B	b4
R 1947	CHIP RES.	220k	1/16W	5%	RMC1/16S 224JTH	J24189053		1-	A	C4
R 1948	CHIP RES.	220k	1/16W	5%	RMC1/16S 224JTH	J24189053		1-	A	C4
R 1949	CHIP RES.	4.7k	1/16W	5%	RMC1/16S 472JTH	J24189033		1-	B	a4
R 1950	CHIP RES.	47	1/16W	5%	RMC1/16S 470JTH	J24189009		1-	B	a4
R 1951	CHIP RES.	27k	1/16W	5%	RMC1/16S 273JTH	J24189042		1-	A	B4
R 1952	CHIP RES.	27k	1/16W	5%	RMC1/16S 273JTH	J24189042		1-	A	A4

MAIN Unit

Parts List

REF	DESCRIPTION	VALUE	V/W	TOL.	MFR'S DESIG	VXSTD P/N	VERS.	LOT	SIDE	LAY ADR
R 1953	CHIP RES.	100k	1/16W	5%	RMC1/16S 104JTH	J24189049		1-	B	c4
R 1954	CHIP RES.	100k	1/16W	5%	RMC1/16S 104JTH	J24189049		1-	B	c4
R 1955	CHIP RES.	100k	1/16W	5%	RMC1/16S 104JTH	J24189049		1-	B	c4
R 1957	CHIP RES.	100k	1/16W	5%	RMC1/16S 104JTH	J24189049		1-	B	c4
R 1958	CHIP RES.	47k	1/16W	5%	RMC1/16S 473JTH	J24189045		1-	B	d4
R 1959	CHIP RES.	10k	1/16W	5%	RMC1/16S 103JTH	J24189037		1-	B	d4
R 1960	CHIP RES.	270k	1/16W	5%	RMC1/16S 274JTH	J24189054		1-	A	B4
R 1961	CHIP RES.	22k	1/16W	5%	RMC1/16S 223JTH	J24189041		1-	B	c5
R 1962	CHIP RES.	10k	1/16W	5%	RMC1/16S 103JTH	J24189037		1-	A	B4
R 1963	CHIP RES.	100k	1/16W	5%	RMC1/16S 104JTH	J24189049		1-	A	B4
R 1964	CHIP RES.	1k	1/16W	5%	RMC1/16S 102JTH	J24189025		1-	B	d4
R 1965	CHIP RES.	1k	1/16W	5%	RMC1/16S 102JTH	J24189025		1-	A	B4
R 1966	CHIP RES.	100	1/16W	5%	RMC1/16S 101JTH	J24189013		1-	A	A4
R 1967	CHIP RES.	10k	1/16W	5%	RMC1/16S 103JTH	J24189037		1-	B	d4
R 1968	CHIP RES.	47k	1/16W	5%	RMC1/16S 473JTH	J24189045		1-	B	d4
R 1969	CHIP RES.	4.7k	1/16W	5%	RMC1/16S 472JTH	J24189033		1-	B	c2
R 1970	CHIP RES.	100	1/16W	5%	RMC1/16S 101JTH	J24189013		1-	B	c4
R 1971	CHIP RES.	470k	1/16W	5%	RMC1/16S 474JTH	J24189057		1-	A	B4
R 1972	CHIP RES.	470k	1/16W	5%	RMC1/16S 474JTH	J24189057		1-	A	B4
R 1973	CHIP RES.	47k	1/16W	5%	RMC1/16S 473JTH	J24189045		1-	B	c4
R 1974	CHIP RES.	10k	1/16W	5%	RMC1/16S 103JTH	J24189037		1-	B	c4
R 1975	CHIP RES.	68k	1/16W	5%	RMC1/16S 683JTH	J24189047		1-	B	c4
R 1976	CHIP RES.	47k	1/16W	5%	RMC1/16S 473JTH	J24189045		1-	B	c4
R 1977	CHIP RES.	47k	1/16W	5%	RMC1/16S 473JTH	J24189045		1-	B	c4
R 1978	CHIP RES.	68k	1/16W	5%	RMC1/16S 683JTH	J24189047		1-	B	c4
R 1979	CHIP RES.	10k	1/16W	5%	RMC1/16S 103JTH	J24189037		1-	A	B4
R 1980	CHIP RES.	100k	1/16W	5%	RMC1/16S 104JTH	J24189049		1-	B	c4
R 1981	CHIP RES.	100k	1/16W	5%	RMC1/16S 104JTH	J24189049		1-	B	d4
R 1982	CHIP RES.	330k	1/16W	5%	RMC1/16S 334JTH	J24189055		1-	A	B4
R 1983	CHIP RES.	1M	1/16W	5%	RMC1/16S 105JTH	J24189061		1-	A	B4
R 1984	CHIP RES.	47k	1/16W	5%	RMC1/16S 473JTH	J24189045		1-	A	A3
R 1985	CHIP RES.	47k	1/16W	5%	RMC1/16S 473JTH	J24189045		1-	A	A3
R 1986	CHIP RES.	1k	1/16W	5%	RMC1/16S 102JTH	J24189025		1-	A	A4
R 1987	CHIP RES.	100	1/16W	5%	RMC1/16S 101JTH	J24189013		1-	A	A4
R 1988	CHIP RES.	1k	1/16W	5%	RMC1/16S 102JTH	J24189025		1-	A	A4
R 1989	CHIP RES.	1k	1/16W	5%	RMC1/16S 102JTH	J24189025		1-	A	A4
R 1990	CHIP RES.	47k	1/16W	5%	RMC1/16S 473JTH	J24189045		1-	B	c4
R 1991	CHIP RES.	47k	1/16W	5%	RMC1/16S 473JTH	J24189045		1-	B	c4
R 1992	CHIP RES.	220	1/16W	5%	RMC1/16S 221JTH	J24189017		1-	A	A4
R 1993	CHIP RES.	100	1/16W	5%	RMC1/16S 101JTH	J24189013		1-	A	B4
RB1860	BLOCK RES.				MNR04M0ABJ102	J42900039		1-	A	A4
RB1861	BLOCK RES.				MNR04M0ABJ102	J42900039		1-	A	A4
RB1862	BLOCK RES.				MNR04M0ABJ102	J42900039		1-	A	A4
RB1863	BLOCK RES.				MNR04M0ABJ102	J42900039		1-	A	A4
RB1864	BLOCK RES.				MNR04M0ABJ102	J42900039		1-	A	A4
RB1865	BLOCK RES.				MNR04M0ABJ102	J42900039		1-	A	A4
RB1866	BLOCK RES.				MNR04M0ABJ102	J42900039		1-	A	A4
RB1867	BLOCK RES.				MNR04M0ABJ102	J42900039		1-	A	A3
RB1868	BLOCK RES.				MNR04M0ABJ102	J42900039		1-	A	A4
RB1869	BLOCK RES.				MNR04M0ABJ102	J42900039		1-	A	A4
RB1870	BLOCK RES.				MNR04M0ABJ102	J42900039		1-	A	A4
RB1871	BLOCK RES.				MNR04M0ABJ102	J42900039		1-	A	A3
RB1872	BLOCK RES.				MNR04M0ABJ102	J42900039		1-	A	A4
RB1874	BLOCK RES.				MNR04M0ABJ102	J42900039		1-	A	A4
RB1875	BLOCK RES.				MNR04M0ABJ102	J42900039		1-	A	A4
RL1201	RELAY		DC12V		G6E-134P-US DC12V	M1190068		1-	A	C1
S 1801	SLIDE SWITCH				SSSS820201	N6090107		1-	A	A4
TH1301	THERMISTOR				TBPS1R104K475H5Q	G9090069		1-	B	a4
TH1302	THERMISTOR				TBPS1R104K475H5Q	G9090069		1-	B	a4
TH1303	THERMISTOR				TBPS1R473K475H5Q	G9090068		1-	B	a4
TH1304	THERMISTOR				TBPS1R103K440H5Q	G9090067		1-	B	a4
TH1305	THERMISTOR				TBPS1R104K475H5Q	G9090069		1-	B	c4
TH1306	THERMISTOR				TBPS1R104K475H5Q	G9090069		1-	B	c4
TH1307	THERMISTOR				TBPS1R473K475H5Q	G9090068		1-	B	c4
TH1308	THERMISTOR				TBPS1R103K440H5Q	G9090067		1-	B	b4
TH1860	THERMISTOR				TBPS1R103K440H5Q	G9090067		1-	A	C1
X 1301	XTAL NX5032SA	11.1MHZ			11.1MHZ	H0103375		1-	B	a4
X 1302	XTAL NX5032SA	11.7MHZ			11.7MHZ	H0103320		1-	B	b4
X 1750	XTAL VT-200				32.768KHZ 20PPM/6PF	H0103267		1-	B	d3
X 1751	XTAL U4B	12.4MHZ			12.4MHZ	H0103374		1-	B	d4
X 1860	XTAL XJCGGC	4.9152MHZ			4.9152MHZ	H0103310		1-	B	d5
X 1861	XTAL U4B	6.144MHZ			6.144MHZ	H0103379		1-	B	c4
XF1450	XTAL FILTER				47R15A9 47.250MHZ	H1102400		1-	A	C2
XF1451	XTAL FILTER				47R15A9 47.250MHZ	H1102400		1-	A	C2
XF1600	XTAL FILTER				MFT44R 44.85MHZ	H1102443		1-	A	D3

MAIN Unit

Note:

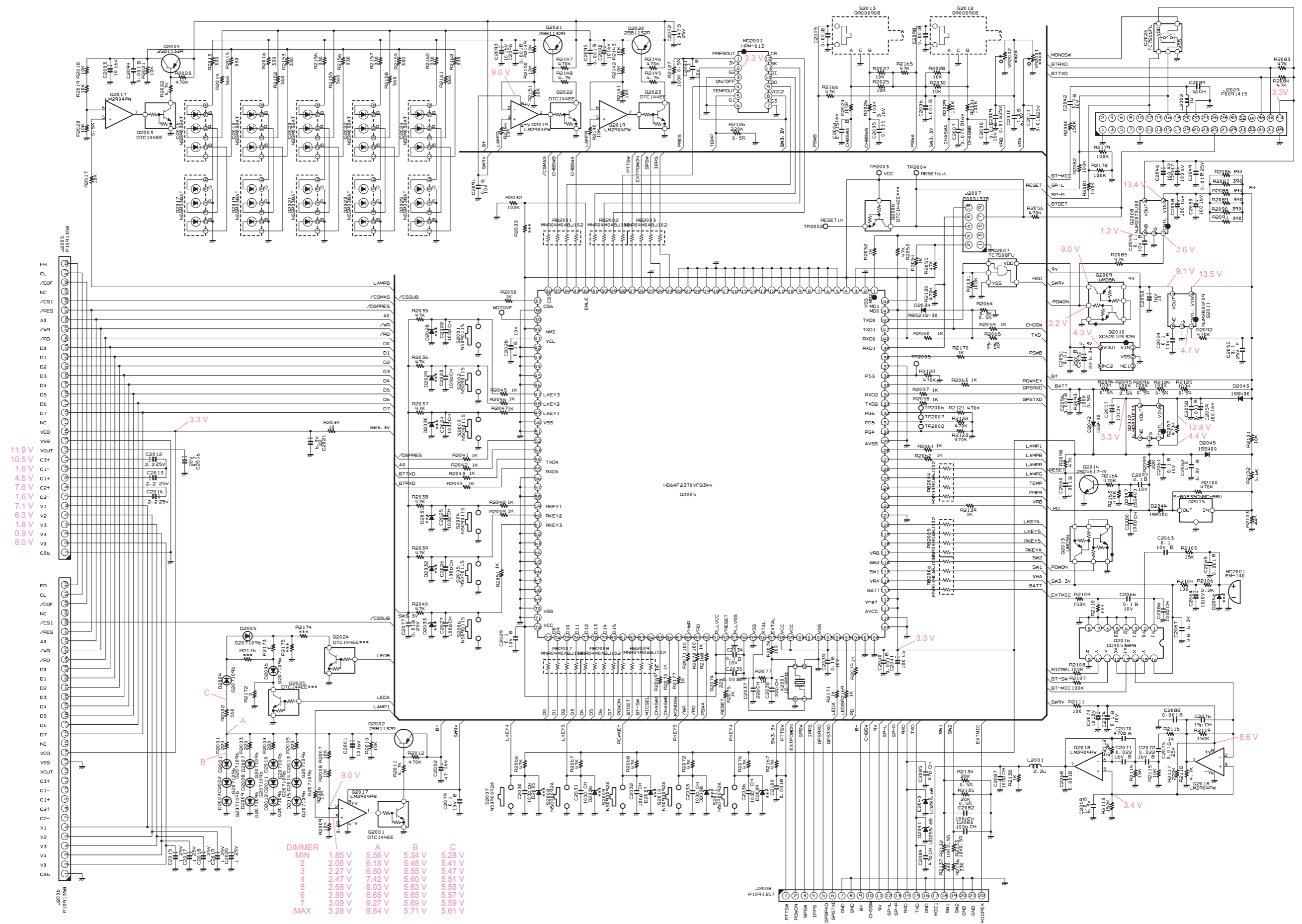

- 11.9V
- 10.5V
- 1.6V
- 4.6V
- 7.6V
- 1.6V
- 7.1V
- 1.8V
- 0.9V
- 8.0V

DIMMER

	A	B	C
MIN	1.85 V	0.56 V	0.26 V
	2.06 V	0.18 V	0.46 V
	2.27 V	7.89 V	0.47 V
	2.88 V	8.03 V	0.51 V
	2.85 V	9.85 V	0.55 V
	3.09 V	9.27 V	0.59 V
	3.28 V	9.84 V	0.61 V

PANEL Unit (Lot. 1~11)

Parts Layout

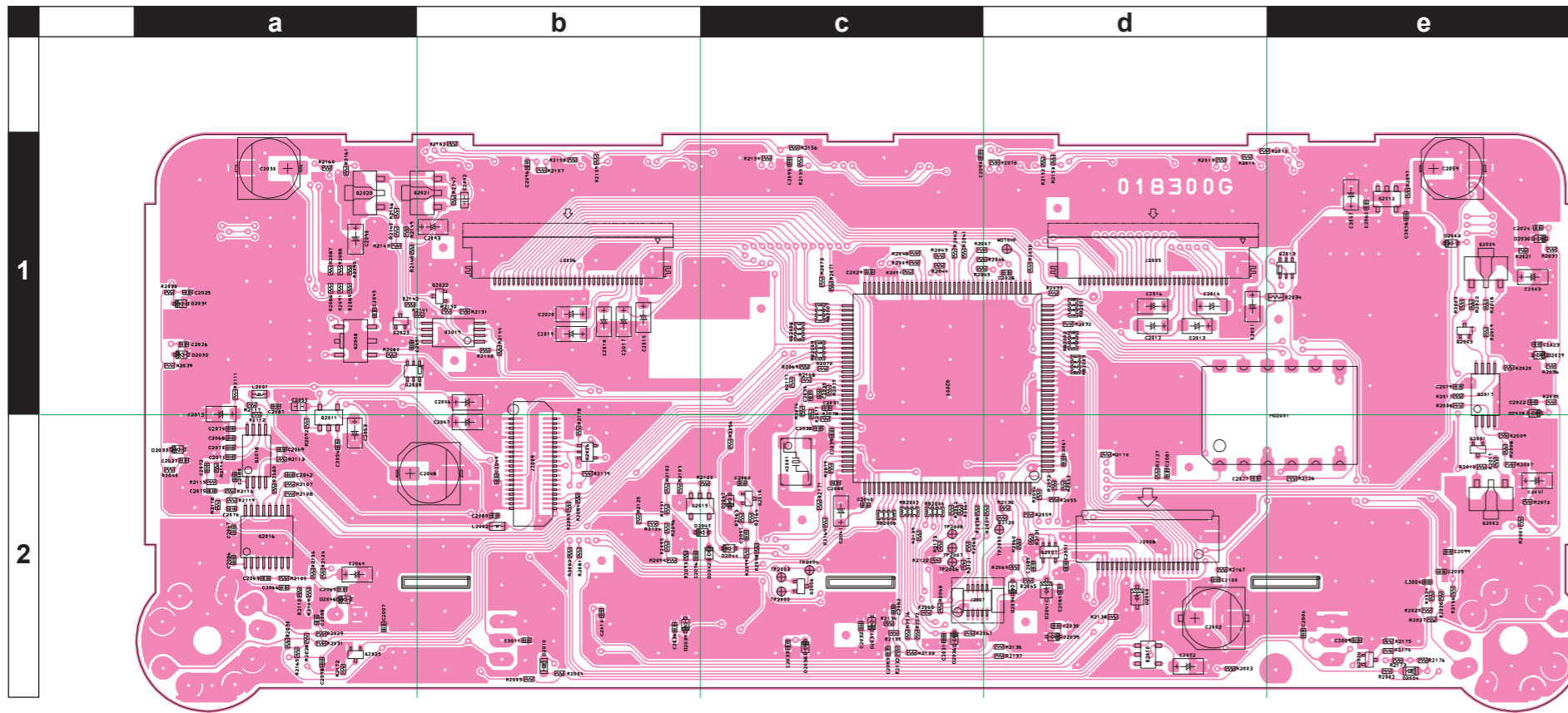
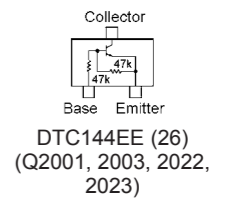
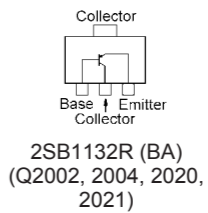
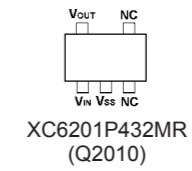
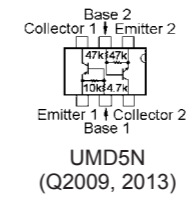
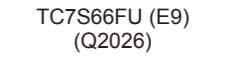
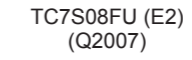
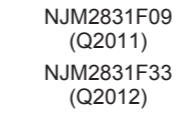
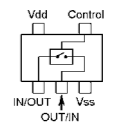
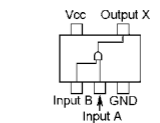
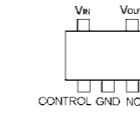
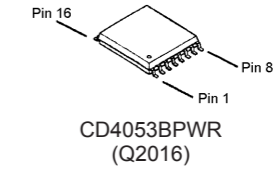
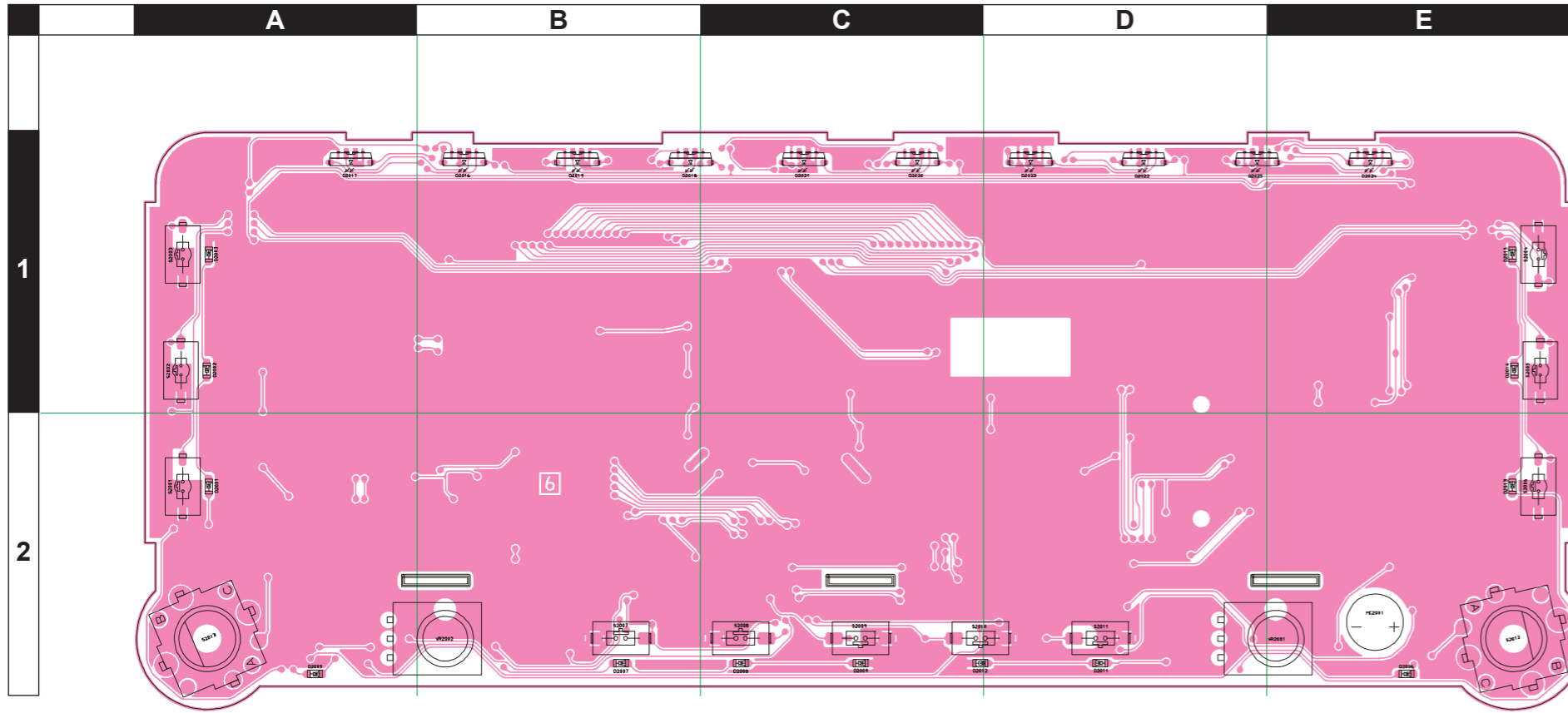

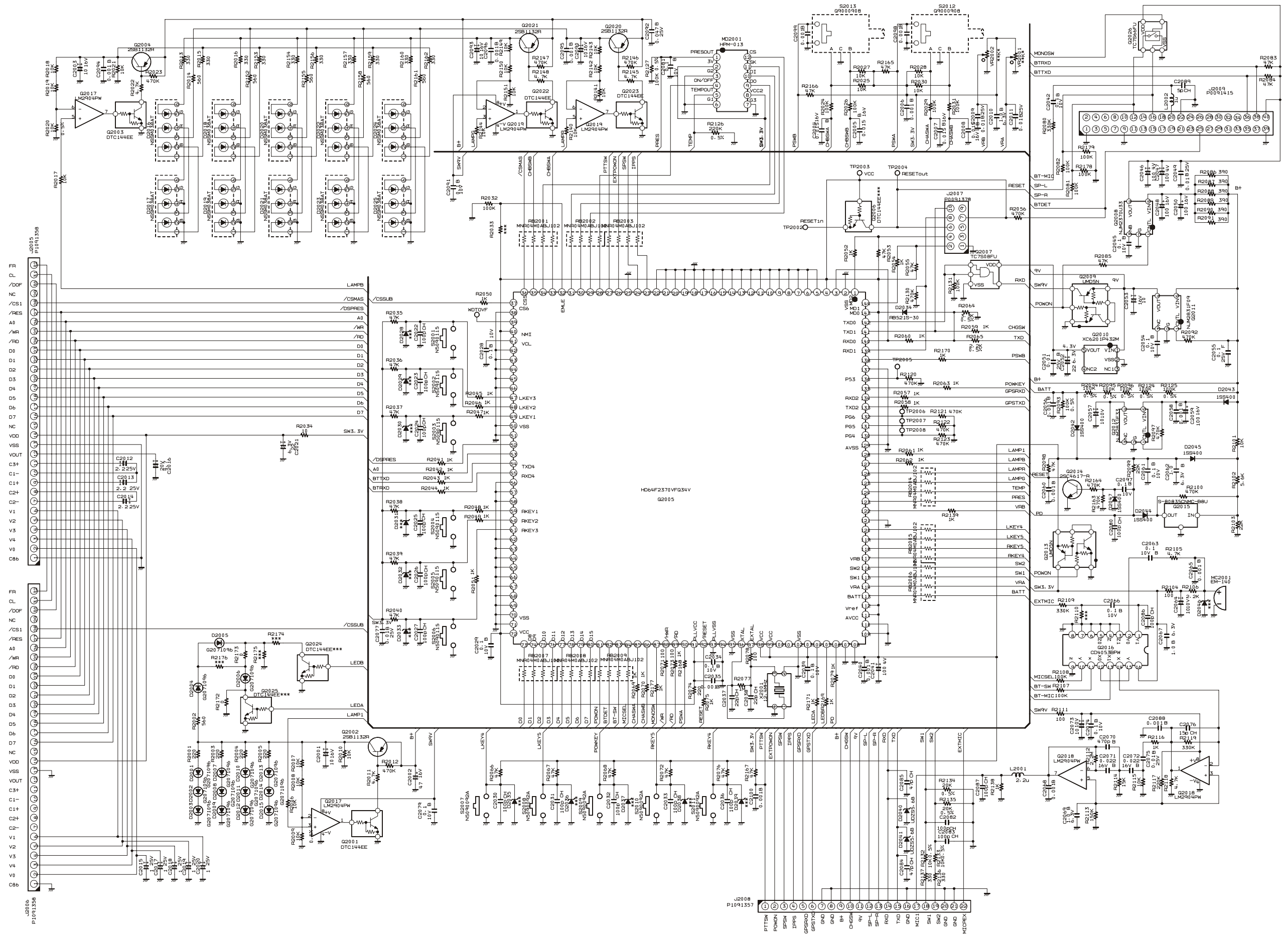

PANEL Unit (Lot. 12~)

Parts Layout

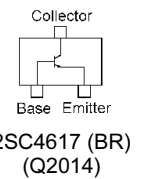
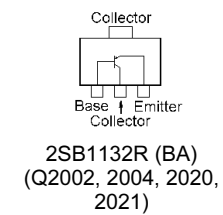
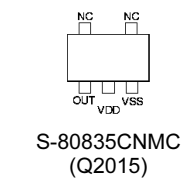
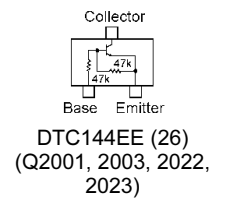
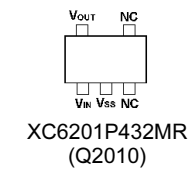
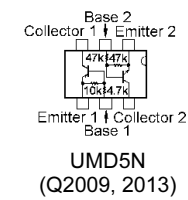
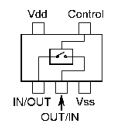
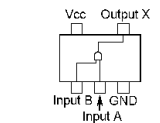
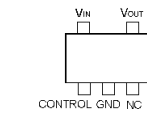
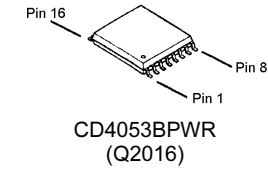
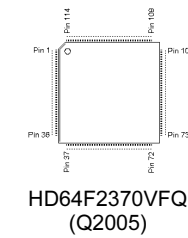
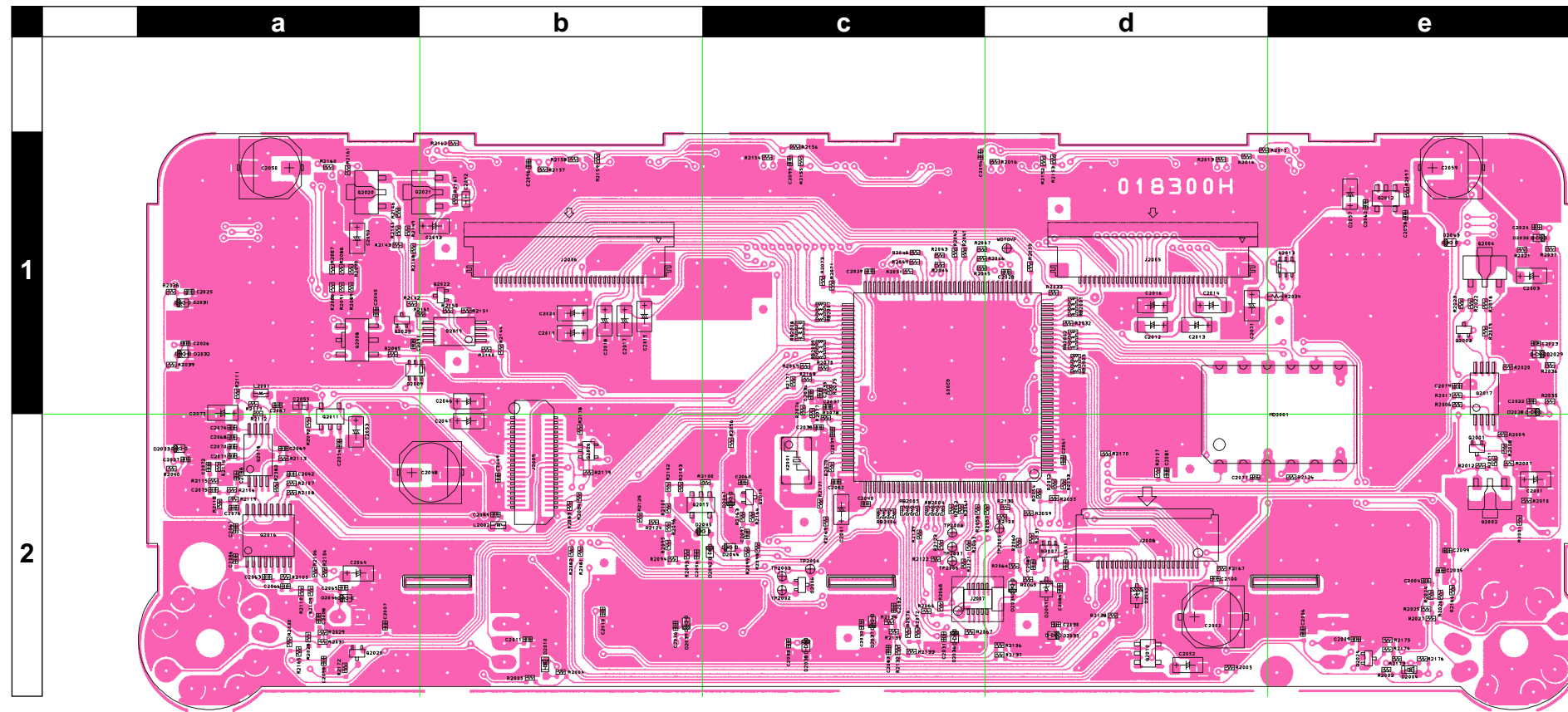
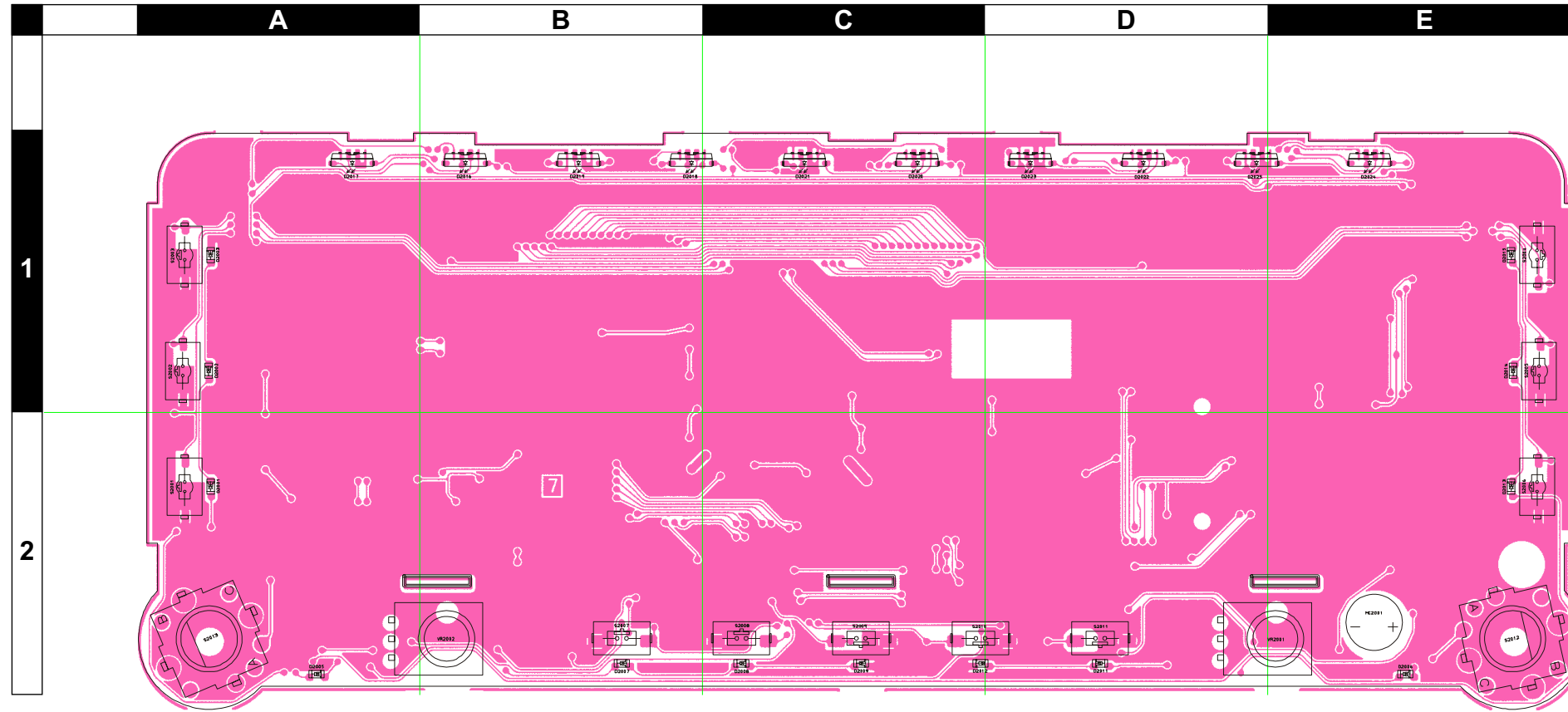

REF	DESCRIPTION	VALUE	V/W	TOL.	MFR'S DESIG	VXSTD P/N	VERS.	LOT	SIDE	LAY ADR
PCB with Components						-----				
Printed Circuit Board						FR018300G		1-		
						FR018300H		12-		
C 2001	CHIP TA.CAP.	10uF	16V		TEESVA1C106M8R	K78120077		1-	B	f2
C 2002	AL.ELECTRO.CAP.	47uF	16V		RV4-16V470MF46-RR2	K48120019		1-	B	f2
C 2003	CHIP TA.CAP.	10uF	16V		TEESVA1C106M8R	K78120077		1-	B	f1
C 2004	CHIP CAP.	0.015uF	16V	B	GRM155B11C153KA01D	K22128807		1-	B	f2
C 2005	CHIP CAP.	0.015uF	16V	B	GRM155B11C153KA01D	K22128807		1-	B	f2
C 2006	CHIP CAP.	0.001uF	50V	B	GRM155B11H102KA01D	K22178809		1-	B	f2
C 2007	CHIP CAP.	0.015uF	16V	B	GRM155B11C153KA01D	K22128807		1-	B	d2
C 2008	CHIP CAP.	0.015uF	16V	B	GRM155B11C153KA01D	K22128807		1-	B	d2
C 2009	CHIP CAP.	0.01uF	25V	B	GRM155B11E103KA01D	K22148834		1-	B	f2
C 2010	CHIP CAP.	1uF	6.3V	B	GRM155B30J105KE18D	K22088803		1-	B	e2
C 2011	CHIP CAP.	0.01uF	25V	B	GRM155B11E103KA01D	K22148834		1-	B	d2
C 2012	CHIP TA.CAP.	2.2uF	25V		TEESVA1E225M8R	K78140020		1-	B	f1
C 2013	CHIP TA.CAP.	2.2uF	25V		TEESVA1E225M8R	K78140020		1-	B	f1
C 2014	CHIP TA.CAP.	2.2uF	25V		TEESVA1E225M8R	K78140020		1-	B	f1
C 2015	CHIP TA.CAP.	1uF	25V		TEESVA1E105M8R	K78140013		1-	B	e1
C 2016	CHIP TA.CAP.	4.7uF	20V		TEESVA1D475M8R	K78130048		1-	B	f1
C 2017	CHIP TA.CAP.	1uF	25V		TEESVA1E105M8R	K78140013		1-	B	e1
C 2018	CHIP TA.CAP.	1uF	25V		TEESVA1E105M8R	K78140013		1-	B	e1
C 2019	CHIP TA.CAP.	1uF	25V		TEESVA1E105M8R	K78140013		1-	B	e1
C 2020	CHIP TA.CAP.	1uF	25V		TEESVA1E105M8R	K78140013		1-	B	e1
C 2021	CHIP TA.CAP.	22uF	6.3V		TAJA226M006Y	K78080086		1-	B	f1
C 2022	CHIP CAP.	100pF	50V	CH	GRM1552C1H101JD01D	K22178236		1-	B	f1
C 2023	CHIP CAP.	100pF	50V	CH	GRM1552C1H101JD01D	K22178236		1-	B	f1
C 2024	CHIP CAP.	100pF	50V	CH	GRM1552C1H101JD01D	K22178236		1-	B	f1
C 2025	CHIP CAP.	100pF	50V	CH	GRM1552C1H101JD01D	K22178236		1-	B	c1
C 2026	CHIP CAP.	100pF	50V	CH	GRM1552C1H101JD01D	K22178236		1-	B	c1
C 2027	CHIP CAP.	100pF	50V	CH	GRM1552C1H101JD01D	K22178236		1-	B	c2
C 2028	CHIP CAP.	0.1uF	10V	B	GRM155B11A104KA01D	K22108802		1-	B	f1
C 2029	CHIP CAP.	0.1uF	10V	B	GRM155B11A104KA01D	K22108802		1-	B	f1
C 2030	CHIP CAP.	100pF	50V	CH	GRM1552C1H101JD01D	K22178236		1-	B	f2
C 2031	CHIP CAP.	100pF	50V	CH	GRM1552C1H101JD01D	K22178236		1-	B	f2
C 2032	CHIP CAP.	100pF	50V	CH	GRM1552C1H101JD01D	K22178236		1-	B	f2
C 2033	CHIP CAP.	100pF	50V	CH	GRM1552C1H101JD01D	K22178236		1-	B	e2
C 2034	CHIP CAP.	0.1uF	10V	B	GRM155B11A104KA01D	K22108802		1-	B	e1
C 2035	CHIP CAP.	0.001uF	50V	B	GRM155B11H102KA01D	K22178809		1-	B	e1
C 2036	CHIP CAP.	100pF	50V	CH	GRM1552C1H101JD01D	K22178236		1-	B	e2
C 2037	CHIP CAP.	22pF	50V	CH	GRM1552C1H220JZ01D	K22178220		1-	B	e1
C 2038	CHIP CAP.	22pF	50V	CH	GRM1552C1H220JZ01D	K22178220		1-	B	e2
C 2039	CHIP CAP.	0.1uF	10V	B	GRM155B11A104KA01D	K22108802		1-	B	e2
C 2040	CHIP CAP.	0.001uF	50V	B	GRM155B11H102KA01D	K22178809		1-	B	f2
C 2041	CHIP TA.CAP.	100uF	4V		TEESVA0G107M8R	K78060051		1-	B	e2
C 2042	CHIP CAP.	0.1uF	10V	B	GRM155B11A104KA01D	K22108802		1-	B	d2
C 2043	CHIP CAP.	1uF	6.3V	B	GRM155B30J105KE18D	K22088803		3-5		
C 2044	CHIP CAP.	1uF	6.3V	B	GRM155B30J105KE18D	K22088803		3-5		
C 2045	CHIP CAP.	0.1uF	10V	B	GRM155B11A104KA01D	K22108802		1-	B	d1
C 2046	CHIP TA.CAP.	100uF	4V		TEESVA0G107M8R	K78060051		1-	B	d1
C 2047	CHIP TA.CAP.	100uF	4V		TEESVA0G107M8R	K78060051		1-	B	d2
C 2048	AL.ELECTRO.CAP.	100uF	16V		EEE1CA101WP	K48120012		1-	B	d2
C 2049	CHIP CAP.	0.01uF	25V	B	GRM155B11E103KA01D	K22148834		1-	B	d2
C 2050	AL.ELECTRO.CAP.	100uF	16V		EEE1CA101WP	K48120012		1-	B	c1
C 2051	CHIP CAP.	0.01uF	25V	B	GRM155B11E103KA01D	K22148834		1-	B	f2
C 2052	CHIP TA.CAP.	22uF	6.3V		TEESVA0J226M8R	K78080047		1-	B	f2
C 2053	CHIP TA.CAP.	10uF	16V		TEESVA1C106M8R	K78120077		1-	B	d2
C 2054	CHIP CAP.	0.1uF	10V	B	GRM155B11A104KA01D	K22108802		1-	B	d2
C 2055	CHIP CAP.	0.1uF	25V	F	GRM188F11E104ZA01D	K22145001		1-	B	d1
C 2056	CHIP CAP.	0.001uF	50V	B	GRM155B11H102KA01D	K22178809		1-	B	e2
C 2057	CHIP TA.CAP.	10uF	10V		TEESVA1A106M8R	K78100028		1-	B	f1
C 2058	CHIP CAP.	0.001uF	50V	B	GRM155B11H102KA01D	K22178809		1-	B	f1
C 2059	AL.ELECTRO.CAP.	100uF	16V		EEE1CA101WP	K48120012		1-	B	f1
C 2060	CHIP CAP.	0.001uF	50V	B	GRM155B11H102KA01D	K22178809		1-	B	e2
C 2061	CHIP CAP.	0.1uF	10V	B	GRM155B11A104KA01D	K22108802		1-	B	f2
C 2062	CHIP CAP.	1uF	6.3V	B	GRM155B30J105KE18D	K22088803		1-	B	f1
C 2063	CHIP CAP.	0.1uF	10V	B	GRM155B11A104KA01D	K22108802		1-	B	c2
C 2064	CHIP TA.CAP.	10uF	10V		TEESVA1A106M8R	K78100028		1-	B	d2
C 2065	CHIP CAP.	0.001uF	50V	B	GRM155B11H102KA01D	K22178809		1-	B	d2
C 2066	CHIP CAP.	0.1uF	10V	B	GRM155B11A104KA01D	K22108802		1-	B	d2
C 2067	CHIP CAP.	1uF	6.3V	B	GRM155B30J105KE18D	K22088803		1-	B	c2
C 2068	CHIP CAP.	0.001uF	50V	B	GRM155B11H102KA01D	K22178809		1-	B	c2
C 2069	CHIP CAP.	1uF	6.3V	B	GRM155B30J105KE18D	K22088803		1-	B	d2
C 2070	CHIP CAP.	470pF	50V	B	GRM155B11H471KA01D	K22178805		1-	B	c2
C 2071	CHIP CAP.	0.022uF	16V	B	GRM155B11C223KA01D	K22128806		1-	B	c2
C 2072	CHIP CAP.	0.022uF	16V	B	GRM155B11C223KA01D	K22128806		1-	B	c2

PANEL Unit

Parts List

REF	DESCRIPTION	VALUE	V/W	TOL.	MFR'S DESIG	VXSTD P/N	VERS.	LOT	SIDE	LAY ADR
C 2073	CHIP TA.CAP.	10uF	10V		TEESVA1A106M8R	K78100028		1-	B	c1
C 2074	CHIP CAP.	0.1uF	10V	B	GRM155B11A104KA01D	K22108802		1-	B	c2
C 2075	CHIP CAP.	0.01uF	25V	B	GRM155B11E103KA01D	K22148834		1-	B	c2
C 2076	CHIP CAP.	15pF	50V	CH	GRM1552C1H150JZ01D	K22178216		1-	B	c2
C 2077	CHIP CAP.	0.01uF	25V	B	GRM155B11E103KA01D	K22148834		1-	B	f2
C 2079	CHIP CAP.	0.1uF	10V	B	GRM155B11A104KA01D	K22108802		1-	B	f1
C 2080	CHIP CAP.	100pF	50V	CH	GRM1552C1H101JD01D	K22178236		1-	B	e2
C 2081	CHIP CAP.	0.1uF	10V	B	GRM155B11A104KA01D	K22108802		1-	B	f2
C 2082	CHIP CAP.	100pF	50V	CH	GRM1552C1H101JD01D	K22178236		1-	B	f2
C 2083	CHIP CAP.	100pF	50V	CH	GRM1552C1H101JD01D	K22178236		1-	B	f2
C 2084	CHIP CAP.	47pF	50V	CH	GRM1552C1H470JZ01D	K22178228		1-	B	f2
C 2085	CHIP CAP.	47pF	50V	CH	GRM1552C1H470JZ01D	K22178228		1-	B	f2
C 2086	CHIP CAP.	100pF	50V	CH	GRM1552C1H101JD01D	K22178236		1-	B	c2
C 2087	CHIP CAP.	100pF	50V	CH	GRM1552C1H101JD01D	K22178236		1-	B	c1
C 2088	CHIP CAP.	0.001uF	50V	B	GRM155B11H102KA01D	K22178809		1-	B	c2
C 2089	CHIP CAP.	5pF	50V	CH	GRM1552C1H5R0BZ01D	K22178292		1-	B	d2
C 2090	CHIP TA.CAP.	10uF	16V		TEESVA1C106M8R	K78120077		1-	B	d1
C 2091	CHIP CAP.	0.1uF	10V	B	GRM155B11A104KA01D	K22108802		1-	B	d1
C 2092	CHIP CAP.	0.047uF	25V	B	GRM155B11E473KA01D	K22144811		1-	B	d1
C 2093	CHIP TA.CAP.	10uF	16V		TEESVA1C106M8R	K78120077		1-	B	d1
C 2094	CHIP CAP.	0.001uF	50V	B	GRM155B11H102KA01D	K22178809		1-	B	f1
C 2095	CHIP CAP.	0.001uF	50V	B	GRM155B11H102KA01D	K22178809		1-	B	e1
C 2096	CHIP CAP.	0.001uF	50V	B	GRM155B11H102KA01D	K22178809		1-	B	d1
C 2097	CHIP CAP.	0.1uF	10V	B	GRM155B11A104KA01D	K22108802		1-	B	e2
C 2098	CHIP CAP.	0.001uF	50V	B	GRM155B11H102KA01D	K22178809		1-	B	d2
C 2099	CHIP CAP.	0.001uF	50V	B	GRM155B11H102KA01D	K22178809		1-	B	f2
C 2100	CHIP CAP.	0.001uF	50V	B	GRM155B11H102KA01D	K22178809		1-	B	f2
D 2001	LED				19-213/S2C-AN1P2B/3T	G2071096		1-	A	A2
D 2002	LED				19-213/S2C-AN1P2B/3T	G2071096		1-	A	A1
D 2003	LED				19-213/S2C-AN1P2B/3T	G2071096		1-	A	A1
D 2004	LED				19-213/S2C-AN1P2B/3T	G2071096		1-	B	f2
D 2005	LED				19-213/S2C-AN1P2B/3T	G2071096		1-	A	A2
D 2006	LED				19-213/S2C-AN1P2B/3T	G2071096		1-	A	B2
D 2007	LED				19-213/S2C-AN1P2B/3T	G2071096		1-	A	A2
D 2008	LED				19-213/S2C-AN1P2B/3T	G2071096		1-	A	A2
D 2009	LED				19-213/S2C-AN1P2B/3T	G2071096		1-	A	A2
D 2010	LED				19-213/S2C-AN1P2B/3T	G2071096		1-	B	d2
D 2011	LED				19-213/S2C-AN1P2B/3T	G2071096		1-	A	A2
D 2012	LED				19-213/S2C-AN1P2B/3T	G2071096		1-	A	A2
D 2013	LED				19-213/S2C-AN1P2B/3T	G2071096		1-	A	C2
D 2014	LED				19-213/S2C-AN1P2B/3T	G2071096		1-	A	C1
D 2015	LED				19-213/S2C-AN1P2B/3T	G2071096		1-	A	C1
D 2016	LED				NSSM038AT	G2071252		1-	A	A1
D 2017	LED				NSSM038AT	G2071252		1-	A	A1
D 2018	LED				NSSM038AT	G2071252		1-	A	A1
D 2019	LED				NSSM038AT	G2071252		1-	A	A1
D 2020	LED				NSSM038AT	G2071252		1-	A	A1
D 2021	LED				NSSM038AT	G2071252		1-	A	A1
D 2022	LED				NSSM038AT	G2071252		1-	A	B1
D 2023	LED				NSSM038AT	G2071252		1-	A	A1
D 2024	LED				NSSM038AT	G2071252		1-	A	B1
D 2025	LED				NSSM038AT	G2071252		1-	A	B1
D 2034	DIODE				RB521S-30 TE61	G2070642		1-	B	f2
D 2040	DIODE				UDZS TE-17 5.6B	G2070910		1-	B	f2
D 2041	DIODE				UDZS TE-17 5.6B	G2070910		1-	B	f2
D 2042	DIODE				1SS400 TE61	G2070634		1-	B	e2
D 2043	DIODE				1SS400 TE61	G2070634		1-	B	f1
D 2044	DIODE				1SS400 TE61	G2070634		1-	B	e2
D 2045	DIODE				1SS400 TE61	G2070634		1-	B	e2
D 2047	DIODE				1SS400 TE61	G2070634		1-	B	e2
J 2005	CONNECTOR				08 6212 032 340 800A+	P1091358		1-	B	f1
J 2006	CONNECTOR				08 6212 032 340 800A+	P1091358		1-	B	e1
J 2007	CONNECTOR				AXK6F10345YP	P0091378		1-	B	f2
J 2008	CONNECTOR				IMSA-9637S-22	P1091357		1-	B	f2
J 2009	CONNECTOR				AXK6S40435J	P0091415		1-	B	d2
L 2001	M.RFC	2.2uH			LK1608 2R2K-T	L1690634		1-	B	c1
L 2002	M.RFC	1uH			LK1608 1R0K-T	L1690687		1-	B	d2
MC2001	MIC. ELEMENT				EM-140	M3290032		1-	A	B2
MD2001	MODULE				HPM-013	Q7000612		1-	B	f1
Q 2001	TRANSISTOR				DTC144EE TL	G3070075		1-	B	f2
Q 2002	TRANSISTOR				2SB1132 T100 R	G3211327R		1-	B	f2
Q 2003	TRANSISTOR				DTC144EE TL	G3070075		1-	B	f1
Q 2004	TRANSISTOR				2SB1132 T100 R	G3211327R		1-	B	f1
Q 2005	IC				HD64F2370Vfq34V			1-	B	f1
Q 2007	IC				TC7S08FU(TE85R.F)	G1091528		1-	B	f2

PANEL Unit

Parts List

REF	DESCRIPTION	VALUE	V/W	TOL.	MFR'S DESIG	VXSTD P/N	VERS.	LOT	SIDE	LAY ADR
Q 2008	IC				NJM2370U33-TE1	G1094564		1-	B	d1
Q 2009	TRANSISTOR				UMD5N TR	G3070343		1-	B	d1
Q 2010	IC				XC6201P432MR	G1094566		1-	B	f2
Q 2011	IC				NJM2831F09-TE1	G1094565		1-	B	d2
Q 2012	IC				NJM2831F33-TE1	G1094632		1-	B	f1
Q 2013	TRANSISTOR				UMD5N TR	G3070343		1-	B	f1
Q 2014	TRANSISTOR				2SC4617 TL R	G3346178R		1-	B	e2
Q 2015	IC				S-80835CNMC-B8U-T2-G	G1093606		1-	B	e2
Q 2016	IC				CD4053BPWR	G1093864		1-	B	c2
Q 2017	IC				LM2904PWR	G1094010		1-	B	f1
Q 2018	IC				LM2904PWR	G1094010		1-	B	c2
Q 2019	IC				LM2904PWR	G1094010		1-	B	d1
Q 2020	TRANSISTOR				2SB1132 T100 R	G3211327R		1-	B	d1
Q 2021	TRANSISTOR				2SB1132 T100 R	G3211327R		1-	B	d1
Q 2022	TRANSISTOR				DTC144EE TL	G3070075		1-	B	d1
Q 2023	TRANSISTOR				DTC144EE TL	G3070075		1-	B	d1
Q 2026	IC				TC7S66FU(TE85R.F)	G1092116		1-	B	e2
R 2001	CHIP RES.	220	1/16W	5%	RMC1/16S 221JTH	J24189017		1-	B	f2
R 2002	CHIP RES.	560	1/16W	5%	RMC1/16S 561JTH	J24189022		1-	B	f2
R 2003	CHIP RES.	220	1/16W	5%	RMC1/16S 221JTH	J24189017		1-	B	f2
R 2004	CHIP RES.	220	1/16W	5%	RMC1/16S 221JTH	J24189017		1-	B	d2
R 2005	CHIP RES.	220	1/16W	5%	RMC1/16S 221JTH	J24189017		1-	B	d2
R 2006	CHIP RES.	10k	1/16W	5%	RMC1/16S 103JTH	J24189037		1-	B	f1
R 2007	CHIP RES.	10k	1/16W	5%	RMC1/16S 103JTH	J24189037		1-	B	f2
R 2008	CHIP RES.	10k	1/16W	5%	RMC1/16S 103JTH	J24189037		1-	B	f2
R 2009	CHIP RES.	10k	1/16W	0.5%	RR0510P-103-D	J24189143		1-	B	f2
R 2010	CHIP RES.	10k	1/16W	5%	RMC1/16S 103JTH	J24189037		1-	B	f2
R 2011	CHIP RES.	4.7k	1/16W	5%	RMC1/16S 472JTH	J24189033		1-	B	f2
R 2012	CHIP RES.	470k	1/16W	5%	RMC1/16S 474JTH	J24189057		1-	B	f2
R 2013	CHIP RES.	330	1/16W	5%	RMC1/16S 331JTH	J24189019		1-	B	f1
R 2014	CHIP RES.	560	1/16W	5%	RMC1/16S 561JTH	J24189022		1-	B	f1
R 2015	CHIP RES.	330	1/16W	5%	RMC1/16S 331JTH	J24189019		1-	B	f1
R 2016	CHIP RES.	330	1/16W	5%	RMC1/16S 331JTH	J24189019		1-	B	f1
R 2017	CHIP RES.	10k	1/16W	5%	RMC1/16S 103JTH	J24189037		1-	B	f1
R 2018	CHIP RES.	10k	1/16W	5%	RMC1/16S 103JTH	J24189037		1-	B	f1
R 2019	CHIP RES.	10k	1/16W	5%	RMC1/16S 103JTH	J24189037		1-	B	f1
R 2020	CHIP RES.	10k	1/16W	0.5%	RR0510P-103-D	J24189143		1-	B	f1
R 2021	CHIP RES.	10k	1/16W	5%	RMC1/16S 103JTH	J24189037		1-	B	f1
R 2022	CHIP RES.	4.7k	1/16W	5%	RMC1/16S 472JTH	J24189033		1-	B	f1
R 2023	CHIP RES.	470k	1/16W	5%	RMC1/16S 474JTH	J24189057		1-	B	f1
R 2024	CHIP RES.	100k	1/16W	5%	RMC1/16S 104JTH	J24189049		1-	B	f2
R 2025	CHIP RES.	10k	1/16W	5%	RMC1/16S 103JTH	J24189037		1-	B	f2
R 2026	CHIP RES.	100k	1/16W	5%	RMC1/16S 104JTH	J24189049		1-	B	f2
R 2027	CHIP RES.	10k	1/16W	5%	RMC1/16S 103JTH	J24189037		1-	B	f2
R 2028	CHIP RES.	10k	1/16W	5%	RMC1/16S 103JTH	J24189037		1-	B	d2
R 2029	CHIP RES.	100k	1/16W	5%	RMC1/16S 104JTH	J24189049		1-	B	d2
R 2030	CHIP RES.	10k	1/16W	5%	RMC1/16S 103JTH	J24189037		1-	B	d2
R 2031	CHIP RES.	100k	1/16W	5%	RMC1/16S 104JTH	J24189049		1-	B	d2
R 2032	CHIP RES.	100k	1/16W	5%	RMC1/16S 104JTH	J24189049		1-	B	f1
R 2034	CHIP RES.	10	1/16W	5%	RMC1/16 100JATP	J24185100		1-	B	f1
R 2035	CHIP RES.	47k	1/16W	5%	RMC1/16S 473JTH	J24189045		1-	B	f1
R 2036	CHIP RES.	47k	1/16W	5%	RMC1/16S 473JTH	J24189045		1-	B	f1
R 2037	CHIP RES.	47k	1/16W	5%	RMC1/16S 473JTH	J24189045		1-	B	f1
R 2038	CHIP RES.	47k	1/16W	5%	RMC1/16S 473JTH	J24189045		1-	B	c1
R 2039	CHIP RES.	47k	1/16W	5%	RMC1/16S 473JTH	J24189045		1-	B	c1
R 2040	CHIP RES.	47k	1/16W	5%	RMC1/16S 473JTH	J24189045		1-	B	c2
R 2041	CHIP RES.	1k	1/16W	5%	RMC1/16S 102JTH	J24189025		1-	B	f1
R 2042	CHIP RES.	1k	1/16W	5%	RMC1/16S 102JTH	J24189025		1-	B	f1
R 2043	CHIP RES.	1k	1/16W	5%	RMC1/16S 102JTH	J24189025		1-	B	f1
R 2044	CHIP RES.	1k	1/16W	5%	RMC1/16S 102JTH	J24189025		1-	B	f1
R 2045	CHIP RES.	1k	1/16W	5%	RMC1/16S 102JTH	J24189025		1-	B	f1
R 2046	CHIP RES.	1k	1/16W	5%	RMC1/16S 102JTH	J24189025		1-	B	f1
R 2047	CHIP RES.	1k	1/16W	5%	RMC1/16S 102JTH	J24189025		1-	B	f1
R 2048	CHIP RES.	1k	1/16W	5%	RMC1/16S 102JTH	J24189025		1-	B	f1
R 2049	CHIP RES.	1k	1/16W	5%	RMC1/16S 102JTH	J24189025		1-	B	f1
R 2050	CHIP RES.	1k	1/16W	5%	RMC1/16S 102JTH	J24189025		1-	B	f1
R 2051	CHIP RES.	1k	1/16W	5%	RMC1/16S 102JTH	J24189025		1-	B	f1
R 2052	CHIP RES.	1k	1/16W	5%	RMC1/16S 102JTH	J24189025		1-	B	f2
R 2053	CHIP RES.	47k	1/16W	5%	RMC1/16S 473JTH	J24189045		1-	B	f2
R 2054	CHIP RES.	1k	1/16W	5%	RMC1/16S 102JTH	J24189025		1-	B	f2
R 2055	CHIP RES.	47k	1/16W	5%	RMC1/16S 473JTH	J24189045		1-	B	f2
R 2056	CHIP RES.	470k	1/16W	5%	RMC1/16S 474JTH	J24189057		1-	B	e2
R 2057	CHIP RES.	1k	1/16W	5%	RMC1/16S 102JTH	J24189025		1-	B	f2
R 2058	CHIP RES.	1k	1/16W	5%	RMC1/16S 102JTH	J24189025		1-	B	f2
R 2059	CHIP RES.	1k	1/16W	5%	RMC1/16S 102JTH	J24189025		1-	B	f2

PANEL Unit

Parts List

REF	DESCRIPTION	VALUE	V/W	TOL.	MFR'S DESIG	VXSTD P/N	VERS.	LOT	SIDE	LAY ADR
R 2060	CHIP RES.	1k	1/16W	5%	RMC1/16S 102JTH	J24189025		1-	B	f2
R 2061	CHIP RES.	1k	1/16W	5%	RMC1/16S 102JTH	J24189025		1-	B	f2
R 2062	CHIP RES.	1k	1/16W	5%	RMC1/16S 102JTH	J24189025		1-	B	f2
R 2063	CHIP RES.	1k	1/16W	5%	RMC1/16S 102JTH	J24189025		1-	B	f2
R 2064	CHIP RES.	3.3k	1/16W	0.5%	RR0510P-332-D	J24189131		1-	B	f2
R 2065	CHIP RES.	2.2k	1/16W	0.5%	RR0510P-222-D	J24189127		1-	B	f2
R 2066	CHIP RES.	47k	1/16W	5%	RMC1/16S 473JTH	J24189045		1-	B	f2
R 2067	CHIP RES.	47k	1/16W	5%	RMC1/16S 473JTH	J24189045		1-	B	f2
R 2068	CHIP RES.	47k	1/16W	5%	RMC1/16S 473JTH	J24189045		1-	B	f2
R 2069	CHIP RES.	1k	1/16W	5%	RMC1/16S 102JTH	J24189025		1-	B	e1
R 2070	CHIP RES.	1k	1/16W	5%	RMC1/16S 102JTH	J24189025		1-	B	e1
R 2071	CHIP RES.	100	1/16W	5%	RMC1/16S 101JTH	J24189013		1-	B	e1
R 2072	CHIP RES.	47k	1/16W	5%	RMC1/16S 473JTH	J24189045		1-	B	f2
R 2073	CHIP RES.	100	1/16W	5%	RMC1/16S 101JTH	J24189013		1-	B	e1
R 2074	CHIP RES.	220	1/16W	5%	RMC1/16S 221JTH	J24189017		1-	B	e1
R 2075	CHIP RES.	1k	1/16W	5%	RMC1/16S 102JTH	J24189025		1-	B	e1
R 2076	CHIP RES.	47k	1/16W	5%	RMC1/16S 473JTH	J24189045		1-	B	f2
R 2077	CHIP RES.	1M	1/16W	5%	RMC1/16S 105JTH	J24189061		1-	B	e1
R 2078	CHIP RES.	100	1/16W	5%	RMC1/16S 101JTH	J24189013		1-	B	e2
R 2079	CHIP RES.	1k	1/16W	5%	RMC1/16S 102JTH	J24189025		1-	B	e2
R 2080	CHIP RES.	330k	1/16W	5%	RMC1/16S 334JTH	J24189055		1-	B	c2
R 2081	CHIP RES.	100k	1/16W	5%	RMC1/16S 104JTH	J24189049		1-	B	e2
R 2082	CHIP RES.	100k	1/16W	5%	RMC1/16S 104JTH	J24189049		1-	B	e2
R 2083	CHIP RES.	47k	1/16W	5%	RMC1/16S 473JTH	J24189045		1-	B	e2
R 2084	CHIP RES.	47k	1/16W	5%	RMC1/16S 473JTH	J24189045		1-	B	e2
R 2085	CHIP RES.	47k	1/16W	5%	RMC1/16S 473JTH	J24189045		1-	B	d1
R 2086	CHIP RES.	390	1/16W	5%	RMC1/16S 391JTH	J24189020		1-	B	d1
R 2087	CHIP RES.	390	1/16W	5%	RMC1/16S 391JTH	J24189020		1-	B	d1
R 2088	CHIP RES.	390	1/16W	5%	RMC1/16S 391JTH	J24189020		1-	B	d1
R 2089	CHIP RES.	390	1/16W	5%	RMC1/16S 391JTH	J24189020		1-	B	d1
R 2090	CHIP RES.	390	1/16W	5%	RMC1/16S 391JTH	J24189020		1-	B	d1
R 2091	CHIP RES.	390	1/16W	5%	RMC1/16S 391JTH	J24189020		1-	B	d1
R 2092	CHIP RES.	470k	1/16W	5%	RMC1/16S 474JTH	J24189057		1-	B	d2
R 2093	CHIP RES.	100k	1/16W	0.5%	RR0510R-104-D	J24189167		1-	B	e2
R 2094	CHIP RES.	100k	1/16W	0.5%	RR0510R-104-D	J24189167		1-	B	e2
R 2095	CHIP RES.	100k	1/16W	0.5%	RR0510R-104-D	J24189167		1-	B	e2
R 2096	CHIP RES.	100k	1/16W	0.5%	RR0510R-104-D	J24189167		1-	B	e2
R 2097	CHIP RES.	470k	1/16W	5%	RMC1/16S 474JTH	J24189057		1-	B	f1
R 2098	CHIP RES.	47k	1/16W	5%	RMC1/16S 473JTH	J24189045		1-	B	e2
R 2099	CHIP RES.	22k	1/16W	5%	RMC1/16S 223JTH	J24189041		1-	B	e2
R 2100	CHIP RES.	470k	1/16W	5%	RMC1/16S 474JTH	J24189057		1-	B	e2
R 2101	CHIP RES.	10k	1/16W	5%	RMC1/16S 103JTH	J24189037		1-	B	e2
R 2102	CHIP RES.	5.6k	1/16W	5%	RMC1/16S 562JTH	J24189034		1-	B	e2
R 2103	CHIP RES.	22k	1/16W	5%	RMC1/16S 223JTH	J24189041		1-	B	e2
R 2104	CHIP RES.	100	1/16W	5%	RMC1/16S 101JTH	J24189013		1-	B	d2
R 2105	CHIP RES.	4.7k	1/16W	5%	RMC1/16S 472JTH	J24189033		1-	B	d2
R 2106	CHIP RES.	2.2k	1/16W	5%	RMC1/16S 222JTH	J24189029		1-	B	d2
R 2107	CHIP RES.	100k	1/16W	5%	RMC1/16S 104JTH	J24189049		1-	B	d2
R 2108	CHIP RES.	100k	1/16W	5%	RMC1/16S 104JTH	J24189049		1-	B	d2
R 2109	CHIP RES.	330k	1/16W	5%	RMC1/16S 334JTH	J24189055		1-	B	d2
R 2111	CHIP RES.	100	1/16W	5%	RMC1/16S 101JTH	J24189013		1-	B	c1
R 2112	CHIP RES.	2.2M	1/16W	5%	RMC1/16S 225JTH	J24189065		1-	B	c1
R 2113	CHIP RES.	150k	1/16W	5%	RMC1/16S 154JTH	J24189051		1-	B	d2
R 2114	CHIP RES.	15k	1/16W	5%	RMC1/16S 153JTH	J24189039		1-	B	c2
R 2115	CHIP RES.	10k	1/16W	5%	RMC1/16S 103JTH	J24189037		1-	B	c2
R 2116	CHIP RES.	1k	1/16W	5%	RMC1/16S 102JTH	J24189025		1-	B	c2
R 2117	CHIP RES.	220k	1/16W	5%	RMC1/16S 224JTH	J24189053		1-	B	c1
R 2118	CHIP RES.	4.7k	1/16W	5%	RMC1/16S 472JTH	J24189033		1-	B	c2
R 2119	CHIP RES.	330k	1/16W	5%	RMC1/16S 334JTH	J24189055		1-	B	c2
R 2120	CHIP RES.	470k	1/16W	5%	RMC1/16S 474JTH	J24189057		1-	B	f2
R 2121	CHIP RES.	470k	1/16W	5%	RMC1/16S 474JTH	J24189057		1-	B	f2
R 2122	CHIP RES.	470k	1/16W	5%	RMC1/16S 474JTH	J24189057		1-	B	f2
R 2123	CHIP RES.	470k	1/16W	5%	RMC1/16S 474JTH	J24189057		1-	B	f2
R 2124	CHIP RES.	100k	1/16W	0.5%	RR0510R-104-D	J24189167		1-	B	e2
R 2125	CHIP RES.	100k	1/16W	0.5%	RR0510R-104-D	J24189167		1-	B	e2
R 2126	CHIP RES.	220k	1/16W	0.5%	MCR01MZPD2203	J24189389		1-	B	f2
R 2127	CHIP RES.	100k	1/16W	0.5%	RR0510R-104-D	J24189167		1-	B	f2
R 2130	CHIP RES.	470k	1/16W	5%	RMC1/16S 474JTH	J24189057		1-	B	f2
R 2131	CHIP RES.	100k	1/16W	5%	RMC1/16S 104JTH	J24189049		1-	B	f2
R 2132	CHIP RES.	10k	1/16W	0.5%	RR0510P-103-D	J24189143		1-	B	f2
R 2133	CHIP RES.	10k	1/16W	0.5%	RR0510P-103-D	J24189143		1-	B	f2
R 2134	CHIP RES.	20k	1/16W	0.5%	RR0510R-203-D	J24189150		1-	B	f2
R 2135	CHIP RES.	20k	1/16W	0.5%	RR0510R-203-D	J24189150		1-	B	f2
R 2136	CHIP RES.	330	1/16W	5%	RMC1/16S 331JTH	J24189019		1-	B	f2
R 2137	CHIP RES.	330	1/16W	5%	RMC1/16S 331JTH	J24189019		1-	B	f2

PANEL Unit

Parts List

REF	DESCRIPTION	VALUE	V/W	TOL.	MFR'S DESIG	VXSTD P/N	VERS.	LOT	SIDE	LAY ADR
R 2138	CHIP RES.	1k	1/16W	5%	RMC1/16S 102JTH	J24189025		1-	B	f2
R 2139	CHIP RES.	1k	1/16W	5%	RMC1/16S 102JTH	J24189025		1-	B	f2
R 2140	CHIP RES.	10k	1/16W	5%	RMC1/16S 103JTH	J24189037		1-	B	d1
R 2141	CHIP RES.	10k	1/16W	5%	RMC1/16S 103JTH	J24189037		1-	B	d1
R 2142	CHIP RES.	10k	1/16W	5%	RMC1/16S 103JTH	J24189037		1-	B	d1
R 2143	CHIP RES.	10k	1/16W	5%	RMC1/16S 103JTH	J24189037		1-	B	d1
R 2144	CHIP RES.	10k	1/16W	5%	RMC1/16S 103JTH	J24189037		1-	B	d1
R 2145	CHIP RES.	4.7k	1/16W	5%	RMC1/16S 472JTH	J24189033		1-	B	d1
R 2146	CHIP RES.	470k	1/16W	5%	RMC1/16S 474JTH	J24189057		1-	B	d1
R 2147	CHIP RES.	470k	1/16W	5%	RMC1/16S 474JTH	J24189057		1-	B	d1
R 2148	CHIP RES.	4.7k	1/16W	5%	RMC1/16S 472JTH	J24189033		1-	B	d1
R 2149	CHIP RES.	10k	1/16W	5%	RMC1/16S 103JTH	J24189037		1-	B	d1
R 2150	CHIP RES.	10k	1/16W	5%	RMC1/16S 103JTH	J24189037		1-	B	d1
R 2151	CHIP RES.	10k	1/16W	5%	RMC1/16S 103JTH	J24189037		1-	B	d1
R 2152	CHIP RES.	560	1/16W	5%	RMC1/16S 561JTH	J24189022		1-	B	f1
R 2153	CHIP RES.	330	1/16W	5%	RMC1/16S 331JTH	J24189019		1-	B	f1
R 2154	CHIP RES.	330	1/16W	5%	RMC1/16S 331JTH	J24189019		1-	B	e1
R 2155	CHIP RES.	560	1/16W	5%	RMC1/16S 561JTH	J24189022		1-	B	e1
R 2156	CHIP RES.	330	1/16W	5%	RMC1/16S 331JTH	J24189019		1-	B	e1
R 2157	CHIP RES.	330	1/16W	5%	RMC1/16S 331JTH	J24189019		1-	B	d1
R 2158	CHIP RES.	560	1/16W	5%	RMC1/16S 561JTH	J24189022		1-	B	e1
R 2159	CHIP RES.	330	1/16W	5%	RMC1/16S 331JTH	J24189019		1-	B	e1
R 2160	CHIP RES.	330	1/16W	5%	RMC1/16S 331JTH	J24189019		1-	B	d1
R 2161	CHIP RES.	560	1/16W	5%	RMC1/16S 561JTH	J24189022		1-	B	d1
R 2162	CHIP RES.	330	1/16W	5%	RMC1/16S 331JTH	J24189019		1-	B	d1
R 2163	CHIP RES.	470k	1/16W	5%	RMC1/16S 474JTH	J24189057		1-	B	e2
R 2164	CHIP RES.	470k	1/16W	5%	RMC1/16S 474JTH	J24189057		1-	B	e2
R 2165	CHIP RES.	47k	1/16W	5%	RMC1/16S 473JTH	J24189045		1-	B	d2
R 2166	CHIP RES.	47k	1/16W	5%	RMC1/16S 473JTH	J24189045		1-	B	f2
R 2167	CHIP RES.	47k	1/16W	5%	RMC1/16S 473JTH	J24189045		1-	B	f2
R 2168	CHIP RES.	1k	1/16W	5%	RMC1/16S 102JTH	J24189025		1-	B	e1
R 2169	CHIP RES.	1k	1/16W	5%	RMC1/16S 102JTH	J24189025		1-	B	e2
R 2170	CHIP RES.	1k	1/16W	5%	RMC1/16S 102JTH	J24189025		1-	B	f2
R 2171	CHIP RES.	1k	1/16W	5%	RMC1/16S 102JTH	J24189025		1-	B	e2
R 2172	CHIP RES.	0	1/16W	5%	RMC1/16S JPTH	J24189070		1-	B	d2
R 2173	CHIP RES.	0	1/16W	5%	RMC1/16S JPTH	J24189070		1-	B	f2
R 2177	CHIP RES.	1k	1/16W	5%	RMC1/16S 102JTH	J24189025		1-	B	e1
R 2178	CHIP RES.	100k	1/16W	5%	RMC1/16S 104JTH	J24189049		1-2	B	e2
R 2178	CHIP RES.	100k	1/16W	5%	RMC1/16S 104JTH	J24189049		6-	B	e2
R 2179	CHIP RES.	100k	1/16W	5%	RMC1/16S 104JTH	J24189049		1-2	B	e2
R 2179	CHIP RES.	100k	1/16W	5%	RMC1/16S 104JTH	J24189049		6-	B	e2
RB2001	BLOCK RES.				MNR04M0ABJ102	J42900039		1-	B	f1
RB2002	BLOCK RES.				MNR04M0ABJ102	J42900039		1-	B	f1
RB2003	BLOCK RES.				MNR04M0ABJ102	J42900039		1-	B	f1
RB2004	BLOCK RES.				MNR04M0ABJ102	J42900039		1-	B	f2
RB2005	BLOCK RES.				MNR04M0ABJ102	J42900039		1-	B	f2
RB2006	BLOCK RES.				MNR04M0ABJ102	J42900039		1-	B	f2
RB2007	BLOCK RES.				MNR04M0ABJ102	J42900039		1-	B	e1
RB2008	BLOCK RES.				MNR04M0ABJ102	J42900039		1-	B	e1
RB2009	BLOCK RES.				MNR04M0ABJ102	J42900039		1-	B	e1
S 2001	TACT SWITCH				SKQYAAE010	N5090115		1-	A	A2
S 2002	TACT SWITCH				SKQYAAE010	N5090115		1-	A	A1
S 2003	TACT SWITCH				SKQYAAE010	N5090115		1-	A	A1
S 2004	TACT SWITCH				SKQYAAE010	N5090115		1-	A	C1
S 2005	TACT SWITCH				SKQYAAE010	N5090115		1-	A	C1
S 2006	TACT SWITCH				SKQYAAE010	N5090115		1-	A	C2
S 2007	TACT SWITCH				SKQMASE010	N5090092A		1-	A	A2
S 2008	TACT SWITCH				SKQMASE010	N5090092A		1-	A	A2
S 2009	TACT SWITCH				SKQMASE010	N5090092A		1-	A	A2
S 2010	TACT SWITCH				SKQMASE010	N5090092A		1-	A	A2
S 2011	TACT SWITCH				SKQMASE010	N5090092A		1-	A	A2
S 2012	ROTARY ENCODER				EC09E1524404	Q9000908		1-	A	C2
S 2013	ROTARY ENCODER				EC09E1524404	Q9000908		1-	A	A2
VR2001	POT.				RH76N1075 15FB203 RY-8598	J60800298		1-	A	B2
VR2002	POT.				RH76N1075 15FB203 RY-8598	J60800298		1-	A	A2
X 2001	XTAL TSS-6	12.4MHz			TSS-5032A 12.4MHZ	H0103376		1-	B	e2

PANEL Unit

Note

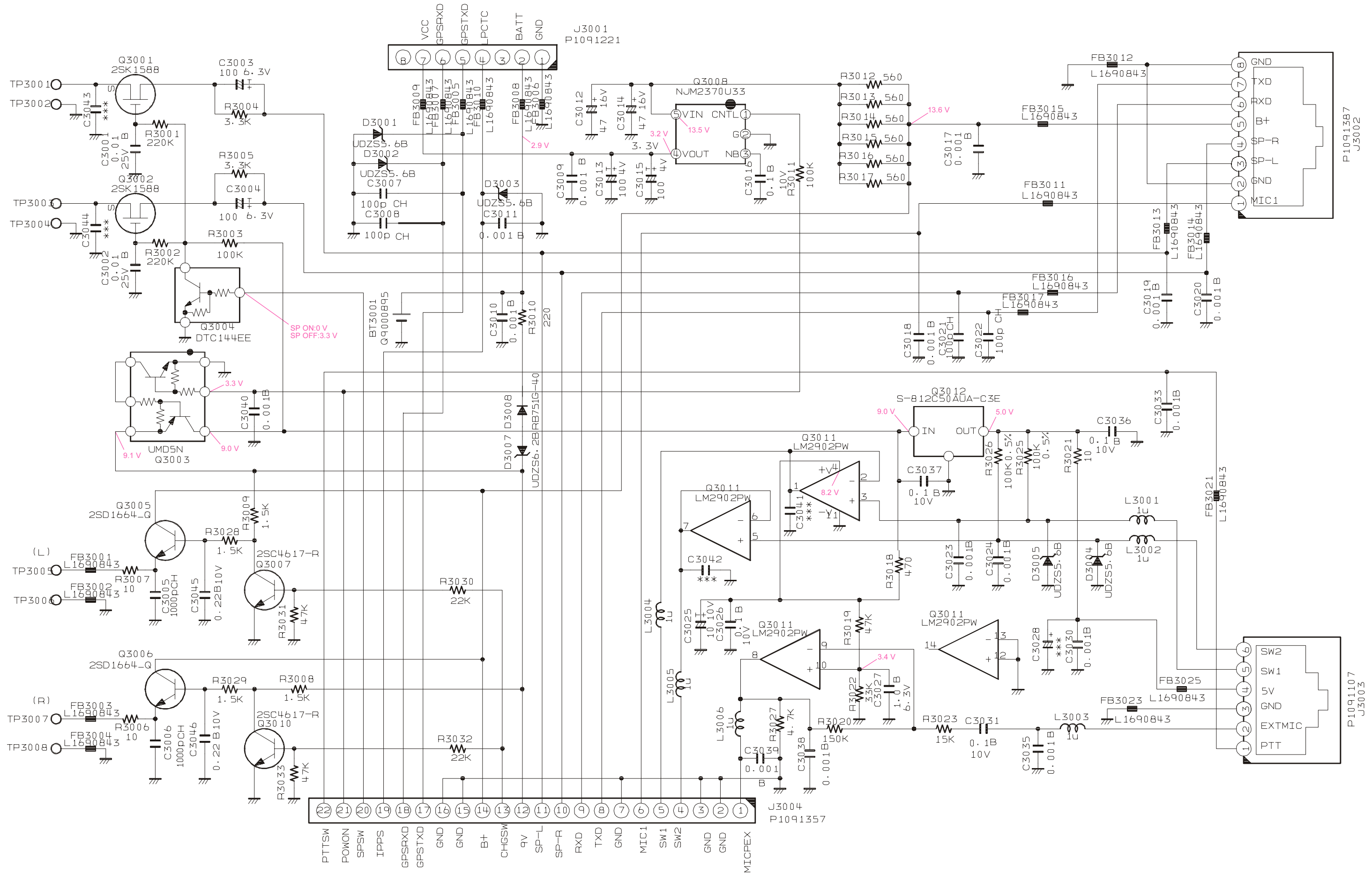

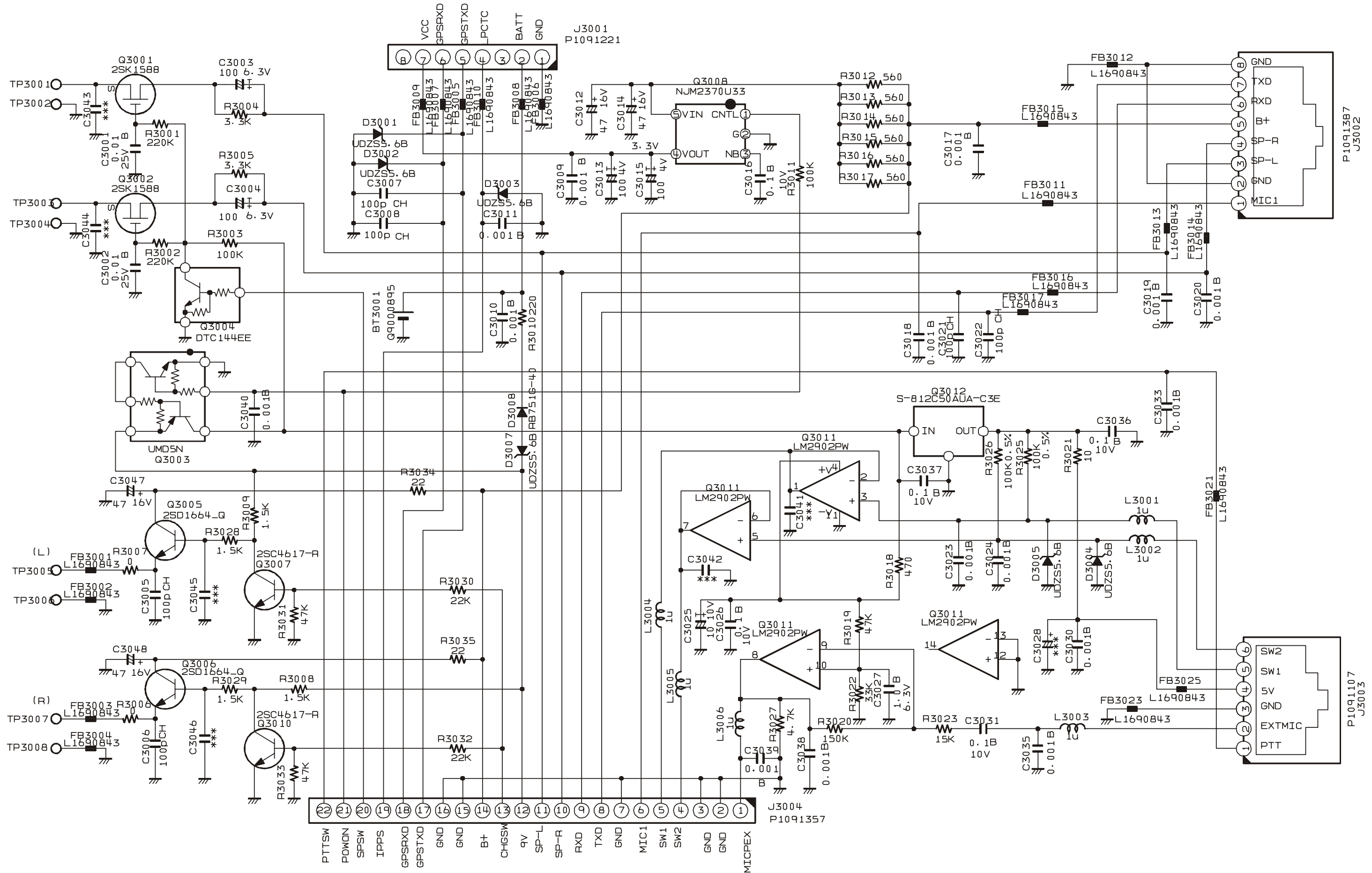

PANEL-R Unit (Lot. 6~11)

Parts Layout

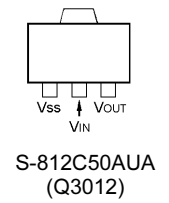
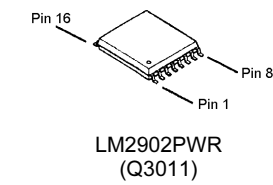
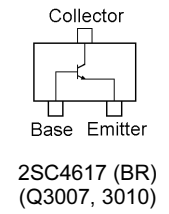
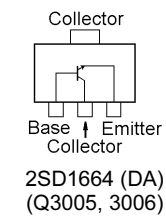
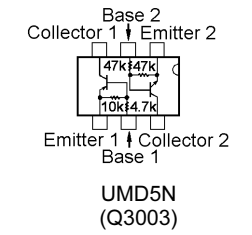
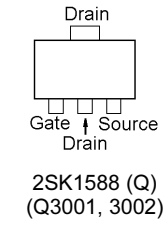
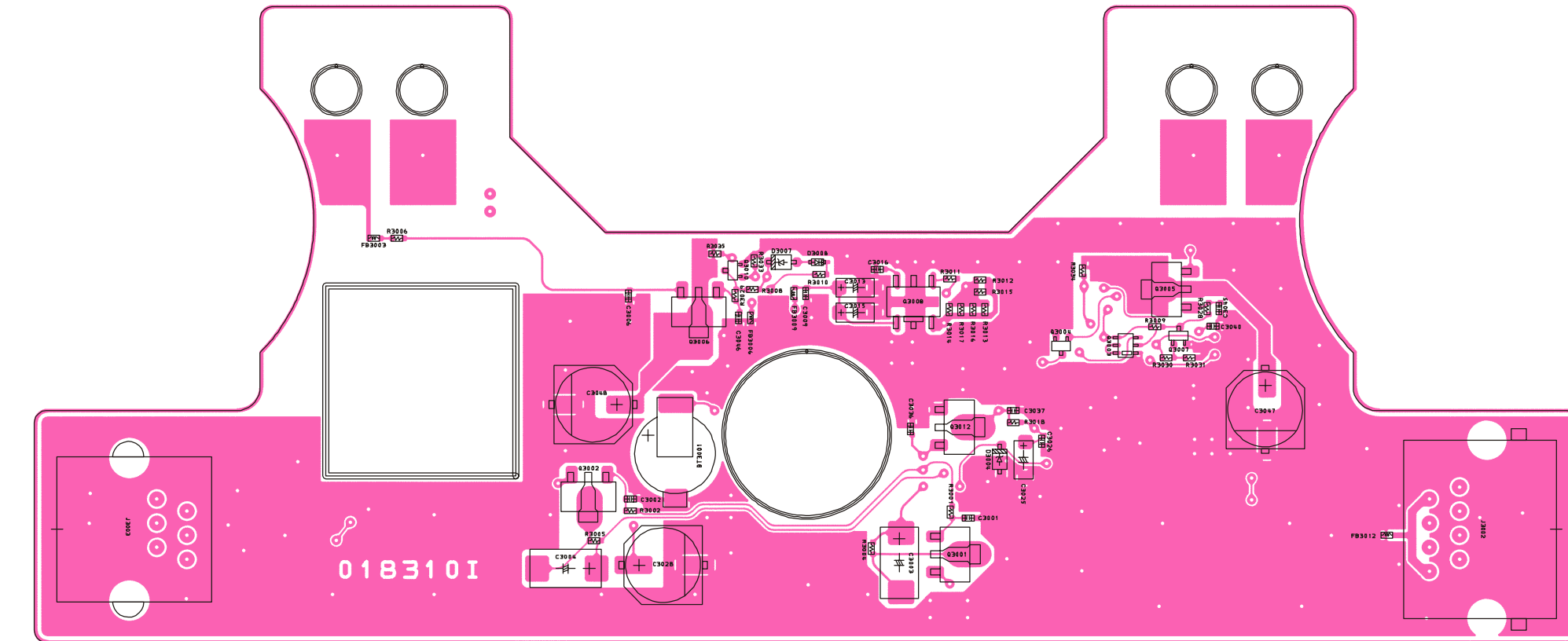
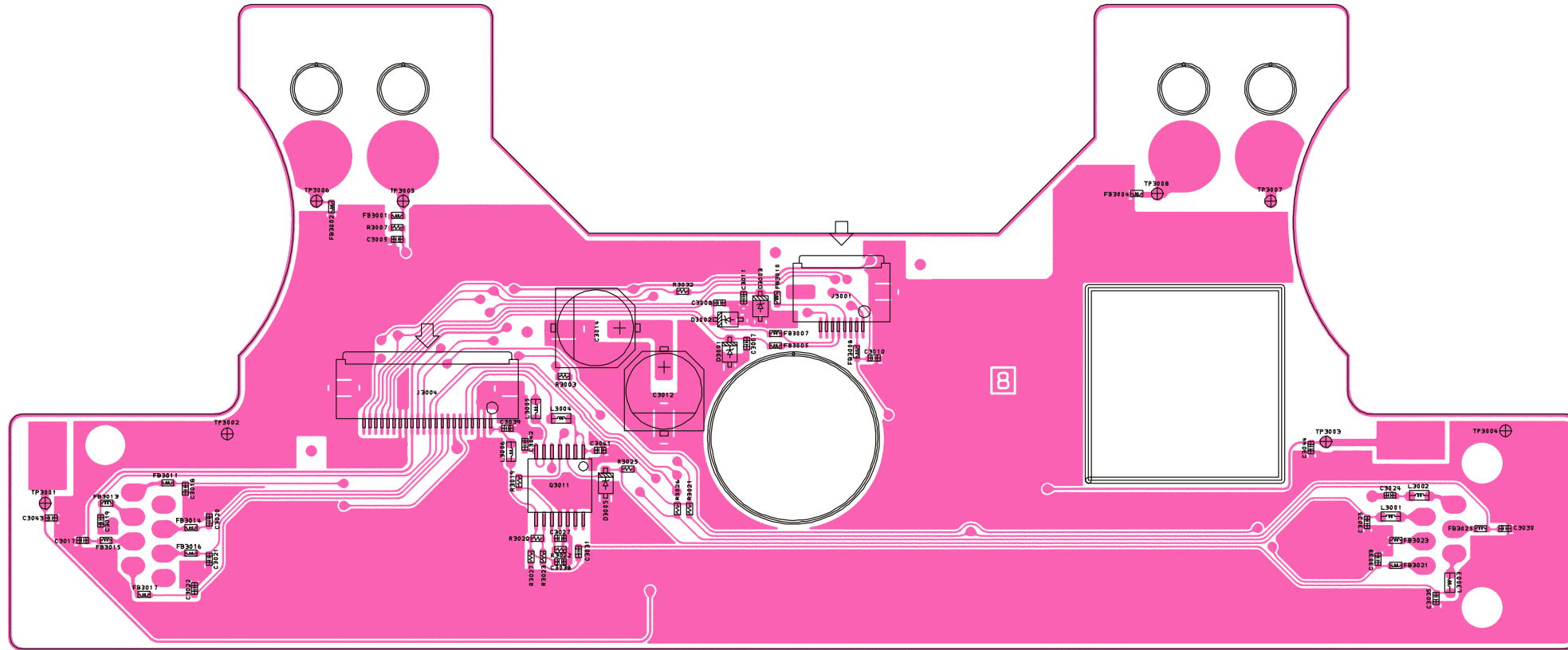

018310I

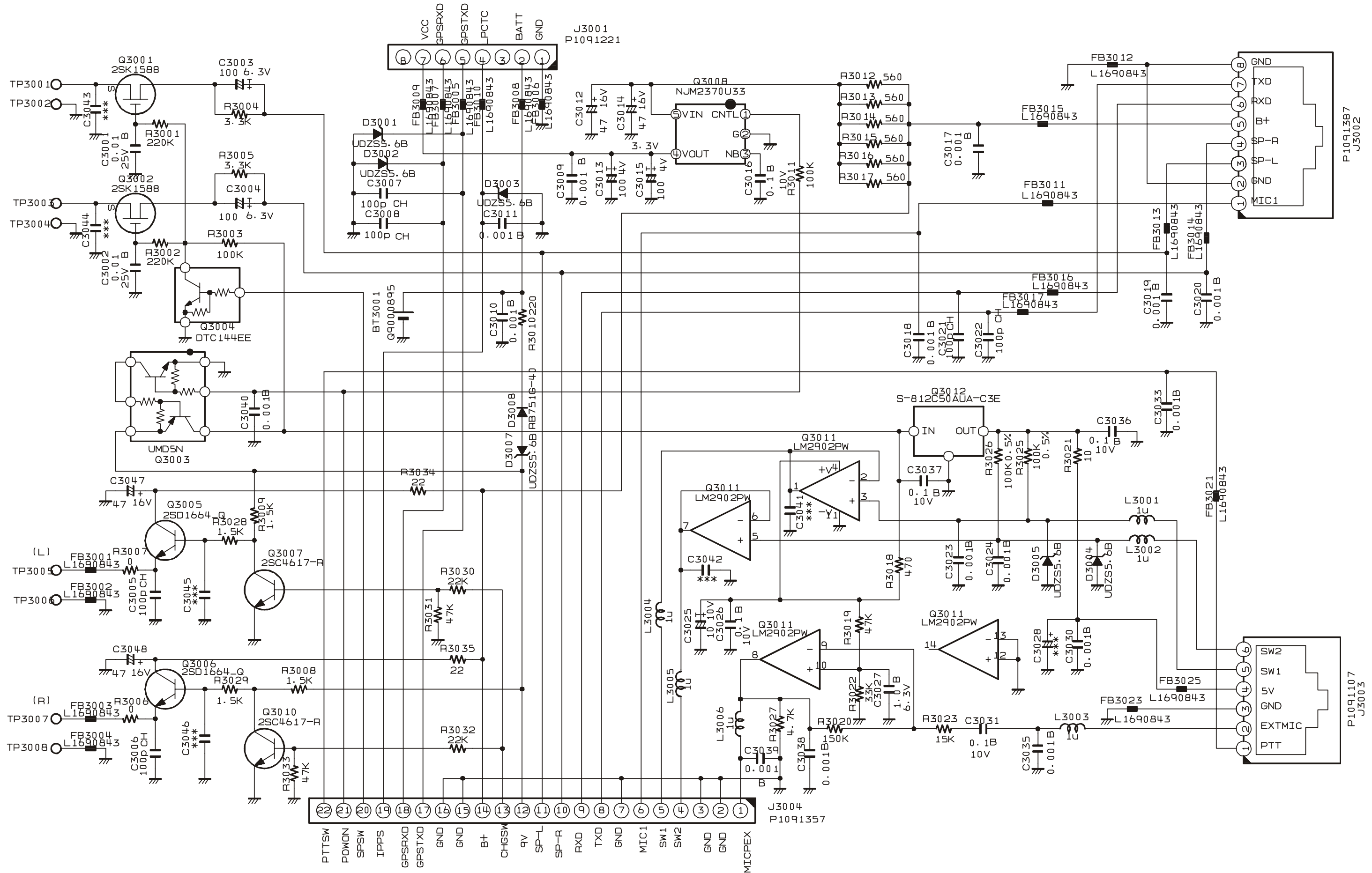

PANEL-R Unit (Lot. 12~)

Parts Layout

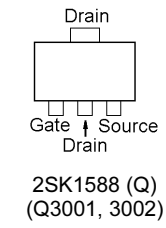
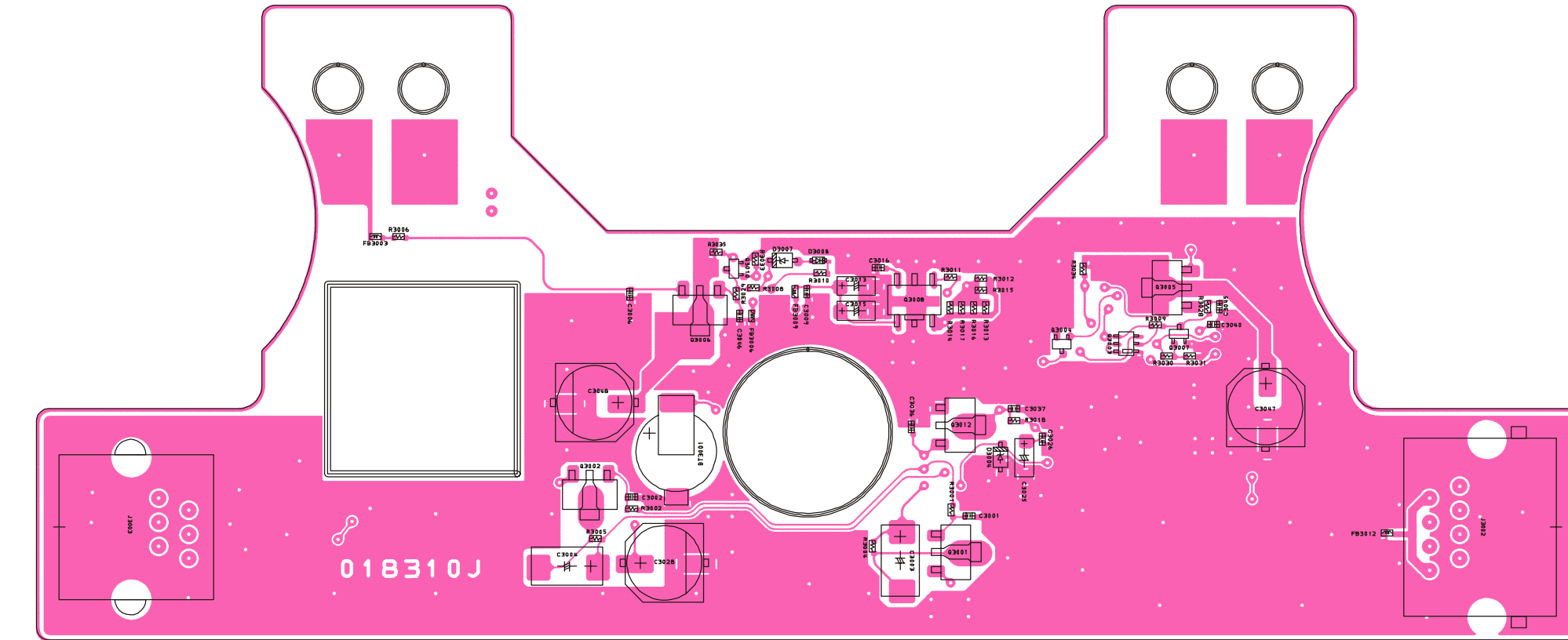
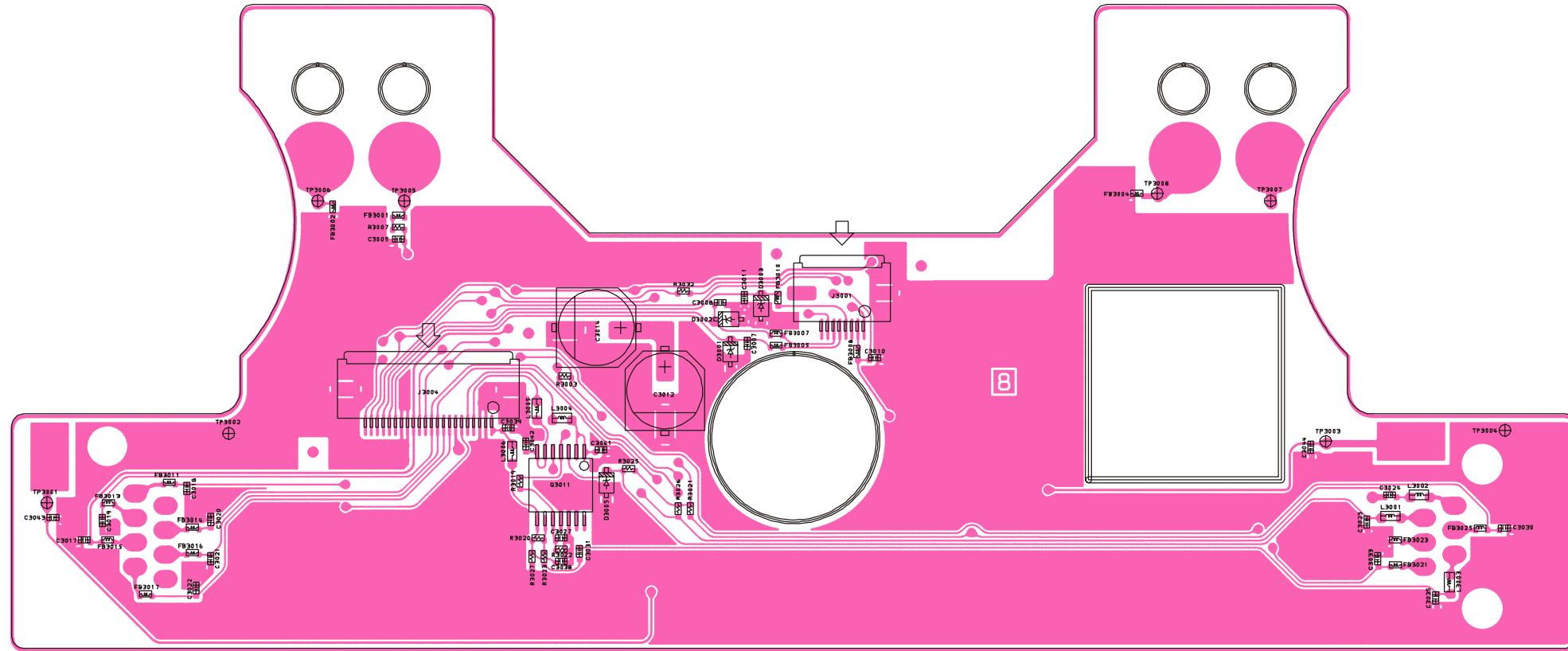

2SK1588 (Q)
(Q3001, 3002)

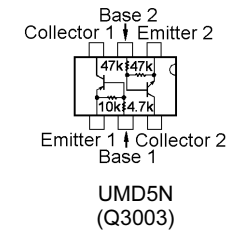

UMD5N
(Q3003)

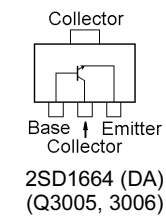

2SD1664 (DA)
(Q3005, 3006)

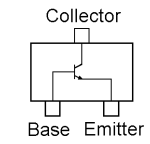

2SC4617 (BR)
(Q3007, 3010)

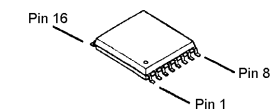

LM2902PWR
(Q3011)

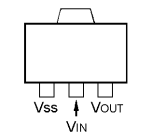

S-812C50AUA
(Q3012)

PANEL-R Unit

Parts List

REF	DESCRIPTION	VALUE	V/W	TOL.	MFR'S DESIG	VXSTD P/N	VERS.	LOT	SIDE	LAY ADR
PCB with Components						-----				
Printed Circuit Board						FR018310H		1-		
						FR018310I		6-		
						FR018310J		12-		
BT3001	LI-ION BATTERY				ML614R-TT31	Q9000895		1-		
C 3001	CHIP CAP.	0.01uF	25V	B	GRM155B11E103KA01D	K22148834		1-	B	e2
C 3002	CHIP CAP.	0.01uF	25V	B	GRM155B11E103KA01D	K22148834		1-	B	d2
C 3003	CHIP TA.CAP.	100uF	6.3V		TEESVC0J107M12R	K78080049		1-	B	e2
C 3004	CHIP TA.CAP.	100uF	6.3V		TEESVC0J107M12R	K78080049		1-	B	d2
C 3005	CHIP CAP.	0.001uF	50V	B	GRM155B11H102KA01D	K22178809		1-	A	A1
C 3005	CHIP CAP.	0.001uF	50V	B	GRM155B11H102KA01D	K22178809		6-	A	A1
C 3005	CHIP CAP.	100pF	50V	CH	GRM1552C1H101JD01D	K22178236		12-	A	A1
C 3006	CHIP CAP.	0.001uF	50V	B	GRM155B11H102KA01D	K22178809		1-	B	d1
C 3006	CHIP CAP.	0.001uF	50V	B	GRM155B11H102KA01D	K22178809		6-	B	d1
C 3006	CHIP CAP.	100pF	50V	CH	GRM1552C1H101JD01D	K22178236		12-	B	d1
C 3007	CHIP CAP.	100pF	50V	CH	GRM1552C1H101JD01D	K22178236		1-	A	A1
C 3008	CHIP CAP.	100pF	50V	CH	GRM1552C1H101JD01D	K22178236		1-	A	A1
C 3009	CHIP CAP.	0.001uF	50V	B	GRM155B11H102KA01D	K22178809		1-	B	e1
C 3010	CHIP CAP.	0.001uF	50V	B	GRM155B11H102KA01D	K22178809		1-	A	A1
C 3011	CHIP CAP.	0.001uF	50V	B	GRM155B11H102KA01D	K22178809		1-	A	A1
C 3012	AL.ELECTRO.CAP.	47uF	16V		RV4-16V470MF46-RR2	K48120019		1-	A	A2
C 3013	CHIP TA.CAP.	100uF	4V		TEESVA0G107M8R	K78060051		1-	B	e1
C 3014	AL.ELECTRO.CAP.	47uF	16V		RV4-16V470MF46-RR2	K48120019		1-	A	A1
C 3015	CHIP TA.CAP.	100uF	4V		TEESVA0G107M8R	K78060051		1-	B	e1
C 3016	CHIP CAP.	0.1uF	10V	B	GRM155B11A104KA01D	K22108802		1-	B	e1
C 3017	CHIP CAP.	0.001uF	50V	B	GRM155B11H102KA01D	K22178809		1-	A	A2
C 3018	CHIP CAP.	0.001uF	50V	B	GRM155B11H102KA01D	K22178809		1-	A	A2
C 3019	CHIP CAP.	0.001uF	50V	B	GRM155B11H102KA01D	K22178809		1-	A	A2
C 3020	CHIP CAP.	0.001uF	50V	B	GRM155B11H102KA01D	K22178809		1-	A	A2
C 3021	CHIP CAP.	100pF	50V	CH	GRM1552C1H101JD01D	K22178236		1-	A	A2
C 3022	CHIP CAP.	100pF	50V	CH	GRM1552C1H101JD01D	K22178236		1-	A	A2
C 3023	CHIP CAP.	0.001uF	50V	B	GRM155B11H102KA01D	K22178809		1-	A	B2
C 3024	CHIP CAP.	0.001uF	50V	B	GRM155B11H102KA01D	K22178809		1-	A	B2
C 3025	CHIP TA.CAP.	10uF	10V		TEESVA1A106M8R	K78100028		1-	B	e2
C 3026	CHIP CAP.	0.1uF	10V	B	GRM155B11A104KA01D	K22108802		1-	B	e2
C 3027	CHIP CAP.	1uF	6.3V	B	GRM155B30J105KE18D	K22088803		1-	A	A2
C 3030	CHIP CAP.	0.001uF	50V	B	GRM155B11H102KA01D	K22178809		1-	A	B2
C 3031	CHIP CAP.	0.1uF	10V	B	GRM155B11A104KA01D	K22108802		1-	A	A2
C 3033	CHIP CAP.	0.001uF	50V	B	GRM155B11H102KA01D	K22178809		1-	A	B2
C 3035	CHIP CAP.	0.001uF	50V	B	GRM155B11H102KA01D	K22178809		1-	A	B2
C 3036	CHIP CAP.	0.1uF	10V	B	GRM155B11A104KA01D	K22108802		1-	B	e2
C 3037	CHIP CAP.	0.1uF	10V	B	GRM155B11A104KA01D	K22108802		1-	B	e2
C 3038	CHIP CAP.	0.001uF	50V	B	GRM155B11H102KA01D	K22178809		1-	A	A2
C 3039	CHIP CAP.	0.001uF	50V	B	GRM155B11H102KA01D	K22178809		1-	A	A2
C 3040	CHIP CAP.	0.001uF	50V	B	GRM155B11H102KA01D	K22178809		1-	B	e1
C 3045	CHIP CAP.	0.22uF	10V	B	GRM155B31A224KE18D	K22108808		1-2	B	e1
C 3045	CHIP CAP.	0.22uF	10V	B	GRM155B31A224KE18D	K22108808		6-11	B	e1
C 3046	CHIP CAP.	0.22uF	10V	B	GRM155B31A224KE18D	K22108808		1-2	B	e1
C 3046	CHIP CAP.	0.22uF	10V	B	GRM155B31A224KE18D	K22108808		6-11	B	e1
C 3047	AL.ELECTRO.CAP.	47uF	16V		RV4-16V470MF46-RR2	K48120019		12-	B	e2
C 3048	AL.ELECTRO.CAP.	47uF	16V		RV4-16V470MF46-RR2	K48120019		12-	B	d2
D 3001	DIODE				UDZS TE-17 5.6B	G2070910		1-	A	A1
D 3002	DIODE				UDZS TE-17 5.6B	G2070910		1-	A	A1
D 3003	DIODE				UDZS TE-17 5.6B	G2070910		1-	A	A1
D 3004	DIODE				UDZS TE-17 5.6B	G2070910		1-	B	e2
D 3005	DIODE				UDZS TE-17 5.6B	G2070910		1-	A	A2
D 3007	DIODE				UDZS TE-17 5.6B	G2070910		1-	B	e1
D 3008	DIODE				RB751G-40T2R	G2071066		1-	B	e1
FB3001	FERRITE BEADS				BLM15AG121SN1D	L1690843		1-	A	A1
FB3002	FERRITE BEADS				BLM15AG121SN1D	L1690843		1-	A	A1
FB3003	FERRITE BEADS				BLM15AG121SN1D	L1690843		1-	B	d1
FB3004	FERRITE BEADS				BLM15AG121SN1D	L1690843		1-	A	A1
FB3005	FERRITE BEADS				BLM15AG121SN1D	L1690843		1-	A	A1
FB3006	FERRITE BEADS				BLM15AG121SN1D	L1690843		1-	B	e1
FB3007	FERRITE BEADS				BLM15AG121SN1D	L1690843		1-	A	A1
FB3008	FERRITE BEADS				BLM15AG121SN1D	L1690843		1-	A	A1
FB3009	FERRITE BEADS				BLM15AG121SN1D	L1690843		1-	B	e1
FB3010	FERRITE BEADS				BLM15AG121SN1D	L1690843		1-	A	A1
FB3011	FERRITE BEADS				BLM15AG121SN1D	L1690843		1-	A	A2
FB3012	FERRITE BEADS				BLM15AG121SN1D	L1690843		1-	B	e2
FB3013	FERRITE BEADS				BLM15AG121SN1D	L1690843		1-	A	A2
FB3014	FERRITE BEADS				BLM15AG121SN1D	L1690843		1-	A	A2
FB3015	FERRITE BEADS				BLM15AG121SN1D	L1690843		1-	A	A2
FB3016	FERRITE BEADS				BLM15AG121SN1D	L1690843		1-	A	A2
FB3017	FERRITE BEADS				BLM15AG121SN1D	L1690843		1-	A	A2

PANEL-R Unit

Parts List

REF	DESCRIPTION	VALUE	V/W	TOL.	MFR'S DESIG	VXSTD P/N	VERS.	LOT	SIDE	LAY ADR
FB3021	FERRITE BEADS				BLM15AG121SN1D	L1690843		1-	A	B2
FB3023	FERRITE BEADS				BLM15AG121SN1D	L1690843		1-	A	B2
FB3025	FERRITE BEADS				BLM15AG121SN1D	L1690843		1-	A	B2
J 3001	CONNECTOR				9637S-08A-Y905	P1091221		1-	A	A1
J 3002	CONNECTOR				MJM0808KE06-H	P1091387		1-	B	e2
J 3003	CONNECTOR				NTC-623PCBL6-B	P1091107		1-	B	c2
J 3004	CONNECTOR				IMSA-9637S-22	P1091357		1-	A	A2
L 3001	M.RFC	1uH			LK1608 1R0K-T	L1690687		1-	A	B2
L 3002	M.RFC	1uH			LK1608 1R0K-T	L1690687		1-	A	B2
L 3003	M.RFC	1uH			LK1608 1R0K-T	L1690687		1-	A	B2
L 3004	M.RFC	1uH			LK1608 1R0K-T	L1690687		1-	A	A2
L 3005	M.RFC	1uH			LK1608 1R0K-T	L1690687		1-	A	A2
L 3006	M.RFC	1uH			LK1608 1R0K-T	L1690687		1-	A	A2
Q 3001	FET				2SK1588-T1-AZ	G3815888		1-	B	e2
Q 3002	FET				2SK1588-T1-AZ	G3815888		1-	B	d2
Q 3003	TRANSISTOR				UMD5N TR	G3070343		1-	B	e1
Q 3004	TRANSISTOR				DTC144EE TL	G3070075		1-	B	e1
Q 3005	TRANSISTOR				2SD1664 T100 Q	G3416647Q		1-	B	e1
Q 3006	TRANSISTOR				2SD1664 T100 Q	G3416647Q		1-	B	e1
Q 3007	TRANSISTOR				2SC4617 TL R	G3346178R		1-	B	e1
Q 3007	TRANSISTOR				DTC144EE TL	G3070075		3-	B	e1
Q 3007	TRANSISTOR				2SC4617 TL R	G3346178R		6-	B	e1
Q 3008	IC				NJM2370U33-TE1	G1094564		1-	B	e1
Q 3010	TRANSISTOR				2SC4617 TL R	G3346178R		1-	B	e1
Q 3010	TRANSISTOR				DTC144EE TL	G3070075		3-	B	e1
Q 3010	TRANSISTOR				2SC4617 TL R	G3346178R		6-	B	e1
Q 3011	IC				LM2902PWR	G1094009		1-	A	A2
Q 3012	IC				S-812C50AUA-C3E-T2G	G1093652		1-	B	e2
R 3001	CHIP RES.	220k	1/16W	5%	RMC1/16S 224JTH	J24189053		1-	B	e2
R 3002	CHIP RES.	220k	1/16W	5%	RMC1/16S 224JTH	J24189053		1-	B	d2
R 3003	CHIP RES.	100k	1/16W	5%	RMC1/16S 104JTH	J24189049		1-	A	A2
R 3004	CHIP RES.	3.3k	1/16W	5%	RMC1/16S 332JTH	J24189031		1-	B	e2
R 3005	CHIP RES.	3.3k	1/16W	5%	RMC1/16S 332JTH	J24189031		1-	B	d2
R 3006	CHIP RES.	10	1/16W	5%	RMC1/16S 100JTH	J24189001		1-	B	d1
R 3006	CHIP RES.	10	1/16W	5%	RMC1/16S 100JTH	J24189001		6-	B	d1
R 3006	CHIP RES.	0	1/16W	5%	RMC1/16S JPTH	J24189070		12-	B	d1
R 3007	CHIP RES.	10	1/16W	5%	RMC1/16S 100JTH	J24189001		1-	A	A1
R 3007	CHIP RES.	10	1/16W	5%	RMC1/16S 100JTH	J24189001		6-	A	A1
R 3007	CHIP RES.	0	1/16W	5%	RMC1/16S JPTH	J24189070		12-	A	A1
R 3008	CHIP RES.	1.5k	1/16W	5%	RMC1/16S 152JTH	J24189027		1-	B	e1
R 3008	CHIP RES.	3.3k	1/16W	5%	RMC1/16S 332JTH	J24189031		3-	B	e1
R 3008	CHIP RES.	1.5k	1/16W	5%	RMC1/16S 152JTH	J24189027		6-	B	e1
R 3009	CHIP RES.	1.5k	1/16W	5%	RMC1/16S 152JTH	J24189027		1-	B	e1
R 3009	CHIP RES.	3.3k	1/16W	5%	RMC1/16S 332JTH	J24189031		3-	B	e1
R 3009	CHIP RES.	1.5k	1/16W	5%	RMC1/16S 152JTH	J24189027		6-	B	e1
R 3010	CHIP RES.	220	1/16W	5%	RMC1/16S 221JTH	J24189017		1-	B	e1
R 3011	CHIP RES.	100k	1/16W	5%	RMC1/16S 104JTH	J24189049		1-	B	e1
R 3012	CHIP RES.	560	1/16W	5%	RMC1/16S 561JTH	J24189022		1-	B	e1
R 3013	CHIP RES.	560	1/16W	5%	RMC1/16S 561JTH	J24189022		1-	B	e1
R 3014	CHIP RES.	560	1/16W	5%	RMC1/16S 561JTH	J24189022		1-	B	e1
R 3015	CHIP RES.	560	1/16W	5%	RMC1/16S 561JTH	J24189022		1-	B	e1
R 3016	CHIP RES.	560	1/16W	5%	RMC1/16S 561JTH	J24189022		1-	B	e1
R 3017	CHIP RES.	560	1/16W	5%	RMC1/16S 561JTH	J24189022		1-	B	e1
R 3018	CHIP RES.	470	1/16W	5%	RMC1/16S 471JTH	J24189021		1-	B	e2
R 3019	CHIP RES.	47k	1/16W	5%	RMC1/16S 473JTH	J24189045		1-	A	A2
R 3020	CHIP RES.	150k	1/16W	5%	RMC1/16S 154JTH	J24189051		1-	A	A2
R 3021	CHIP RES.	10	1/16W	5%	RMC1/16S 100JTH	J24189001		1-	A	A2
R 3022	CHIP RES.	33k	1/16W	5%	RMC1/16S 333JTH	J24189043		1-	A	A2
R 3023	CHIP RES.	15k	1/16W	5%	RMC1/16S 153JTH	J24189039		1-	A	A2
R 3025	CHIP RES.	100k	1/16W	0.5%	RR0510R-104-D	J24189167		1-	A	A2
R 3026	CHIP RES.	100k	1/16W	0.5%	RR0510R-104-D	J24189167		1-	A	A2
R 3027	CHIP RES.	4.7k	1/16W	5%	RMC1/16S 472JTH	J24189033		1-	A	A2
R 3028	CHIP RES.	1.5k	1/16W	5%	RMC1/16S 152JTH	J24189027		1-2	B	e1
R 3028	CHIP RES.	1.5k	1/16W	5%	RMC1/16S 152JTH	J24189027		6-	B	e1
R 3029	CHIP RES.	1.5k	1/16W	5%	RMC1/16S 152JTH	J24189027		1-2	B	e1
R 3029	CHIP RES.	1.5k	1/16W	5%	RMC1/16S 152JTH	J24189027		6-	B	e1
R 3030	CHIP RES.	22k	1/16W	5%	RMC1/16S 223JTH	J24189041		1-2	B	e1
R 3030	CHIP RES.	22k	1/16W	5%	RMC1/16S 223JTH	J24189041		6-	B	e1
R 3031	CHIP RES.	47k	1/16W	5%	RMC1/16S 473JTH	J24189045		1-2	B	e1
R 3031	CHIP RES.	47k	1/16W	5%	RMC1/16S 473JTH	J24189045		6-	B	e1
R 3032	CHIP RES.	22k	1/16W	5%	RMC1/16S 223JTH	J24189041		1-2	A	A1
R 3032	CHIP RES.	22k	1/16W	5%	RMC1/16S 223JTH	J24189041		6-	A	A1
R 3033	CHIP RES.	47k	1/16W	5%	RMC1/16S 473JTH	J24189045		1-2	B	e1
R 3033	CHIP RES.	47k	1/16W	5%	RMC1/16S 473JTH	J24189045		6-	B	e1
R 3034	CHIP RES.	22	1/16W	5%	RMC1/16S 220JTH	J24189005		12-	B	e1

Parts List

REF	DESCRIPTION	VALUE	V/W	TOL.	MFR'S DESIG	VXSTD P/N	VERS.	LOT	SIDE	LAY ADR
R 3035	CHIP RES.	22	1/16W	5%	RMC1/16S 220JTH	J24189005		12-	B	e1

PANEL-R Unit

Note



Copyright 2010
VERTEX STANDARD CO., LTD.
All rights reserved

No portion of this manual
may be reproduced without
the permission of
VERTEX STANDARD CO., LTD.

Printed in Japan.