



**PRO SOLOIST MODEL 2701
PRO/DGX MODEL 2720**

SERVICE MANUAL



TABLE OF CONTENTS

1. Introduction	2
2. Theory of Operation	2
3. General Information	3
4. Trouble Shooting Procedure	3
5. Tuning and Calibrations	4
6. Circuit Descriptions.	5
7. R.O.M. Truth Tables	8
8. Voice Flow Charts.	10
9. Interconnection Diagram	40
10. Block Diagrams, Board A, C & E.	41 - 43
11. Schematics & Layouts, Boards A, B, C, D, E, F, & G.	44 - 61
12. Parts List	62

THE INFORMATION CONTAINED HEREIN IS CONFIDENTIAL AND PROPRIETARY TO ARP INSTRUMENTS, INC. IT IS DISCLOSED TO YOU SOLELY FOR PURPOSES OF INSTRUCTION AS TO OPERATION OF THE EQUIPMENT AND MAINTENANCE AS APPROPRIATE. IT IS NOT TO BE USED BY YOU FOR ANY OTHER PURPOSE, NOR IS IT TO BE DISCLOSED TO OTHERS WITHOUT THE EXPRESS PERMISSION OF ARP INSTRUMENTS, INC.

**ARP INSTRUMENTS, INC.
45 Hartwell Avenue
Lexington, MA 02173
(617) 861-6000**

Document No. 9001801

**© March, 1976, by ARP Instruments, Inc.
3rd Printing (updated) March, 1977**

1. Introduction

Included in this service manual are troubleshooting references which if used properly can greatly reduce the repair time of the Pro Soloist.

Section 2 covers the signal flow through the Pro Soloist. Section 3 describes design techniques unique to the product. Section 4 describes 'where to start' when a problem occurs. The circuit descriptions in section 5 should be consulted once a faulty circuit has been identified by the use of the R.O.M. truth tables and Voice Flow charts in sections 7 and 8.

VOICES AND EFFECTS

Bassoon	Buzz Bassoon
English Horn	Sax
Oboe	Space Reed
Clarinet	Telstar
Flute	Song Whistle
Tuba	Noze
Trombone	Pulsar
French Horn	Comic Wow
Trumpet	Mute Trumpet
Cello	Steel Guitar
Violin	Harpsichord
Bass	Space Bass
Piano	Steel Drum
Banjo	Country Guitar
Fuzz Guitar I	Fuzz Guitar II

2. Theory of Operation

The Pro Soloist is a hybrid of digital and analog circuits. The internal flow of the audio signals is, in most respects, quite similar to any of our other synthesizers. That is, a raw signal (pulse or sawtooth wave) is processed through a voltage controlled filter and a voltage controlled amplifier to the output of the instrument. Two envelope generators (ADSR and AR) are available to control the VCF and VCA to determine the attack and decay characteristics of the instrument. In addition to the voltage controlled filter, there are fixed band pass filters which shape the raw waveforms for particular voices.

In variable synthesizers, such as the ARP Odyssey or the ARP 2600, the signal paths, oscillator waveforms and filter characteristics are adjusted manually. In the Pro Soloist, each of these settings are programmed by a digital memory. (Read Only Memory, or R.O.M.).

Referring to the block diagram, Board A is the

CONTROLS:

Portamento— Enables the pitch to slide from note to note.

Portamento Speed—Regulates the time required to slide from note to note.

Touch Sensitivity—Controls the over-all amount of keyboard touch sensor effects.

Brilliance—Permits the addition or subtraction of brilliance.

Volume—Regulates the over-all volume of the instrument.

Repeat—Creates the rapid pick strokes of string instruments.

Vibrato/Repeat Speed—Controls the vibrato speed and repeat rate.

Octave Transpose Switch—Transposes the instrument up and down one octave.

Waveform Generator board. A sawtooth wave and a pulse wave are supplied (at the correct pitch) to Board C, the Filter board. Board C contains the voltage controlled filter (VCF), the voltage controlled amplifier (VCA), and 14 fixed filters. The signal paths through board C are determined by the R.O.M. outputs which select one of several paths through the different filters.

Board B provides the ADSR or AR output to the VCF and/or the VCA (again determined by the R.O.M.s). Board E (keyboard electronics) sends a 6 bit (6 line) code to board A to control the pitch of the oscillator. Board E also supplies the envelope generators on board B with a gate and trigger. Board F, the Voice Selection board, generates a 5 bit code which addresses all of the R.O.M.s (eight total) which in turn program the signal paths and filter settings. The Special Effects board (D) generates the touch sensor effects: vibrato, growl, wow, volume, brilliance and pitch bend.

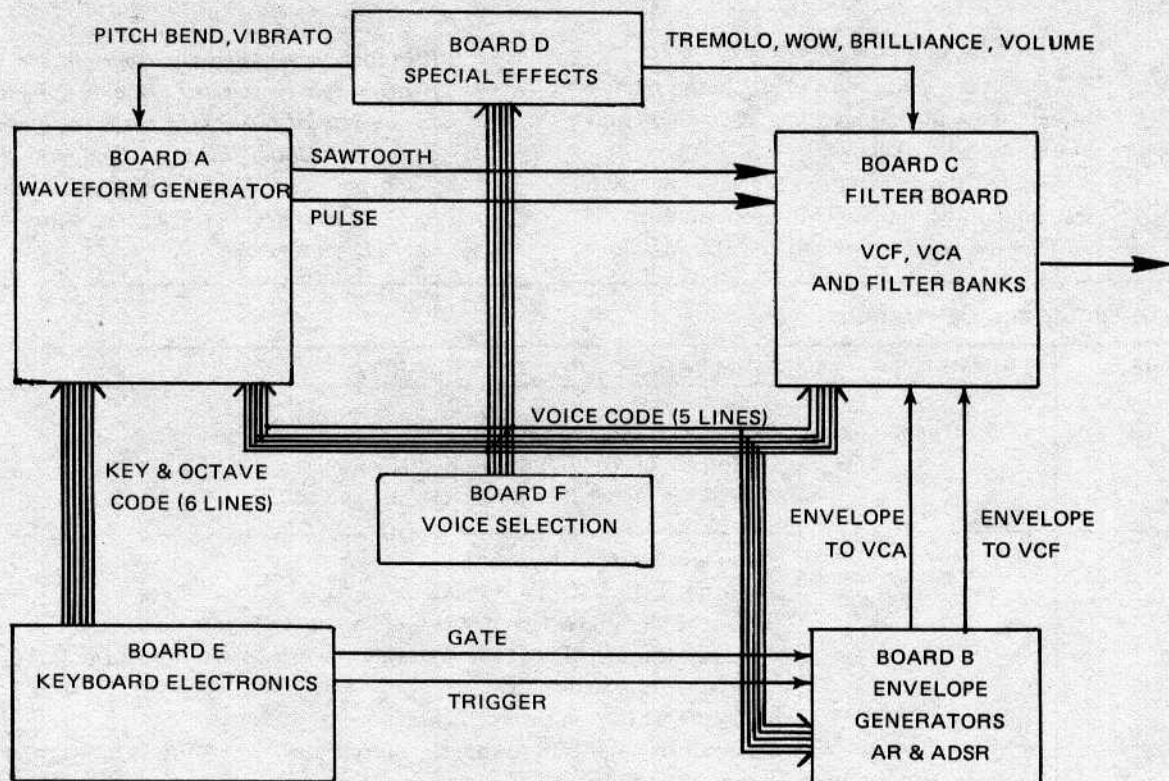

PRO SOLOIST BLOCK DIAGRAM

3. General Information

The digital circuits in the Pro Soloist employ 'open collector' TTL devices. This means that a logic 1 is an open circuit, and a logic 0 is ground. The voltage level on the output of this type of gate does not necessarily relate to the logic level. Illustrated below are two uses for the open collector type gates which will be found in the Pro Soloist.

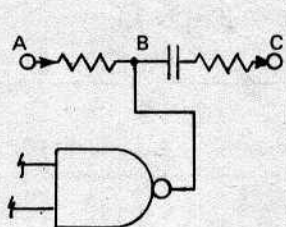

B = LOGIC 1: Signal passes from A to C (B is open)

B = LOGIC 0: Signal is stopped (B grounds out the signal)

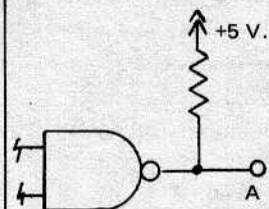

A = LOGIC 1: +5 VOLTS

A = LOGIC 0: 0 VOLTS

It is necessary in some circuits to add (externally) a "pull up" resistor (22K typical) from the +5 volt power supply to the output of an open collector type gate so that the logic level can be identified with a DVM or oscilloscope. Always verify the logic state of these chips in this manner before assuming the device is defective.

4. Trouble Shooting Procedure

INSTRUMENT DEAD: When the Pro Soloist is totally dead, the following should be checked:

1. Power supply: Check the +15 volt, -15 volt and +5 volt outputs. If the power supply (board G) is malfunctioning, remove the power connector from board C and connect the supply to a dummy load while trouble shooting (see the power supply section for dummy load values).
2. VCA: All signals in the Pro Soloist are routed through the VCA; therefore, the output of the VCA should be checked while a key is depressed. If there is no signal, check the output of the VCF. If there is still no signal, check the sawtooth and pulse outputs of board A.

VOICES MISSING, INCORRECT OR DEAD: When some of the voices are correct and some incorrect, the defective circuit common to the incorrect voices must be identified. Proceed as follows:

1. Check the voice code output of board F: This code addresses ALL of the Read Only Memory chips in the Pro Soloist. See the board F circuit description section for the voice code truth table.

CONTINUED ON NEXT PAGE

2. Make a list of *all* the defective voices.
3. Consult the Voice Flow charts in this manual to determine the circuit which is common only to the voices listed above.
4. Consult the schematics, Voice Flow chart test points and the R.O.M. truth tables to determine the code outputs of the R.O.M. which

is in the suspected circuit. *Caution: The R.O.M. is often falsely accused of being defective; the failure rate of the R.O.M.s is actually very low. Example: Oboe, Electric Bass and Electric Piano are dead, Violin and Cello are not correct. Conclusion: defective resonator bank 3, board C; change Z2B.*

5. Tuning and Calibrations

REF.	TRIMMER	TRIM PROCEDURE	BOARD A
R37	VCF TRACK	<ol style="list-style-type: none"> 1. Pin low C on the keyboard. 2. Monitor TP-1 (J2-4) with a digital voltmeter. 3. Adjust trimmer R37 for exactly zero volts. 	
R29	SET 'B'	<ol style="list-style-type: none"> 1. Pin low C on the keyboard. 2. Turn ON the VIOLIN voice switch. 3. Put the vibrato switch DOWN. 4. Adjust trimmer R24 (TUNE) so that the Pro Soloist is tuned to low C on an organ or strobe tuner. 5. Pin the B1 key on the keyboard. 6. Adjust trimmer R29 so that the output of the Pro Solist is tuned to 'B' on the organ or strobe tuner. 	
R49	TOUCH SENSITIVITY	<ol style="list-style-type: none"> 1. Turn ON the TRUMPET and PITCH BEND switches. 2. Put the TOUCH SENSITIVITY slider on the front panel in the MIDPOSITION. 3. Adjust trimmer R49 for the amount of pitch bend desired by the customer on a firm key depression (usually maximum). 	
R24	TUNE	<ol style="list-style-type: none"> 1. This control is used to tune the Pro Soloist to the same frequency as other instruments it is being used with. It is adjustable from the front for the customer. 	
		BOARD C TRIM PROCEDURE	
R20	VCF OFFSET (CALIBRATE)	<ol style="list-style-type: none"> 1. Turn ON the FLUTE voice switch. 2. Put the BRILLIANCE slider on the front panel MIDPOSITION. 3. Adjust R20 for the best flute sound possible. 	
R45	VCF CONTROL REJECT	<ol style="list-style-type: none"> 1. Turn ON the HARPSICHORD voice switch. 2. Adjust trimmer R45 for minimum 'thump' on key depression (turn amplifier up) 	
R54	VCA CONTROL	<ol style="list-style-type: none"> 1. Adjust trimmer R45 (see above) 2. Turn ON the HARPSICHORD voice switch. 3. Adjust trimmer R54 for minimum 'thump' on key depression (turn amplifier up) 	

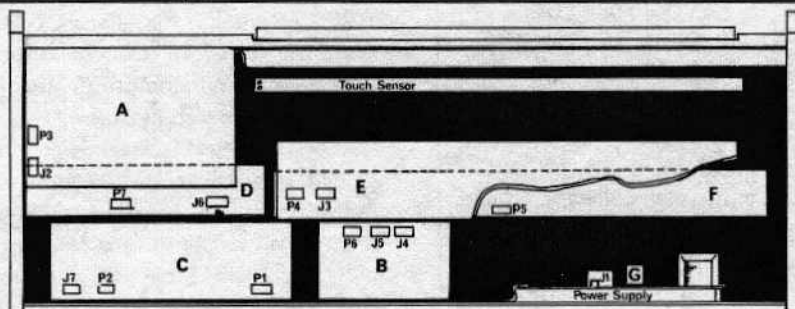

2701 BOARD LOCATIONS

6.1 Board A circuit Description

The 4 bit key code from board E is converted to an analog control voltage in the D to A converter. Although the 2 bit octave code is also fed to the D to A converter, it serves as a correction voltage; the octave control over the voltage controlled oscillator is in the Frequency to Voltage converter circuit. The output of the D to A converter is +5 volts when any C key is depressed. When any C# key is depressed, the D to A output increases to about +5.3 volts. The highest voltage produced by the D to A converter is +9 volts when any B key is depressed. Trimmer R29 (set 'B' trimmer) sets the interval between each key and is equivalent to the volts per octave trimmers in the standard ARP synthesizers except that it only affects the interval between C and B on the keyboard rather than from low C to high C.

The voltage from the D to A converter is fed through a differential amplifier to the voltage controlled oscillator circuitry. Here the control voltage (now -1 V/OCT) is supplied to a linear voltage to exponential current converter (Q3 and Q4). Q4 determines the charging time on capacitor C7. C7 and Q5 are a uni-junction oscillator operating at about seven or eight octaves higher than the pitch that is heard on the output of the Pro Soloist. Q6 makes the sawtooth from Q5 compatible with TTL circuitry and supplies it to the frequency to voltage converter. Z3 and half of Z1 are divide by two chips which are enabled by the two bit octave code from board E. Depending in which octave a key is being depressed, none, one, two or three of these dividers are enabled to supply Z22 (one shot) with a pulse wave which is either at the same frequency as the oscillator, or one, two or three octaves lower. Since the pulse width on the output of the one shot is constant, the repetition rate (frequency) of the pulses is integrated to provide an offset voltage to the differential amplifier thus providing the octave control over the oscillator (4 octaves). The output of the differential amplifier will have a large AC component which is filtered by C4 and C5 to yield a DC control voltage (-1V/OCT) on J2-4.

The output of the voltage controlled oscillator is also supplied to the Programmable Octave Dividers. Depending on the voice selected, R.O.M. Z15 will instruct half of Z1 and Z8 to either send the signal through the circuit, or divide it either once, twice or three times (down 1, 2 or 3 octaves). The manual octave dividers divide the signal even lower, depending on the position of the Transpose switch. The signal then enters the Six Stage Frequency divider circuit whose output is processed in the Sawtooth Sum circuit. Each of the divisions is weighted and summed to produce a +10 volt sawtooth made of 64 small steps.

The Pulse Generator circuit monitors the outputs of the six stage dividers to develop the following pulse widths: 1/14, 1/9, 1/64 and 2/11. Additionally, the Dynamic Pulse Converter circuit develops a variable (dynamic) width pulse wave. All of the pulse waves are supplied to the Pulse Selection circuit where one is selected by R.O.M. Z15 and routed to the pulse output.

6.2 Board B Circuit Description

Board B is the Envelope Generator Board. Z1, Z2 and Z3 (R.O.M.s) program the attack time, decay time, sustain level, and release time of the ADSR envelope generator and the attack and release times of the AR envelope generator.

ADSR: The output of the attack R-S flip flop (Z4 pin 3) changes from logic 1 to logic 0 when a gate and trigger are supplied from the keyboard electronics (board E) on J4-6 and J4-7. Z5 pin 3 provides a logic 1 which allows R64 to charge the integrating capacitor, C3. Q4 and Q5 follow the voltage and supply it to the switching circuitry to be routed to either the VCF and/or the VCA.

Q6 is a "peak detector" comparator. When the ADSR output reaches the maximum voltage (about +5 volts) Q6 resets the R-S flip flop output (Z4 pin 3) to logic 1. The voltage on C3 then discharges through CR16, CR17 or CR18 to the voltage level on the junction of R30, R31 and R32 (sustain level). When the gate on J4-6 is no longer present (all keys up) the remaining voltage on C3 discharges through CR20 and pins 3, 4 or 5 of Z1 to zero.

AR: The gate voltage is supplied to the AR circuit from Z5 pin 8 to charge capacitor C2 through CR2, CR3 or CR4. When all keys are released, the voltage on C4 discharges through CR5 or CR6 back to pin 8 of Z5.

R.O.M. Z3 selects which envelope (ADSR and/or AR) is to be routed to P6-16, the VCA control input. Z3 also selects which envelope is to be supplied to Z6. R1, R2, R3 and R4 attenuate the envelope before it is processed through Z6. Z6 sums and inverts the ADSR or AR envelope, the growl signal from board D and the touch brilliance voltage from board D. The envelope must be inverted because the VCF accepts negative going control voltages. The output of Z6 is connected to the control input of the filter via the brilliance slider on board A.

Q7, Q8 and Z4 pins 9, 10 and 11 are the squelch circuit which provides a momentary pulse to the VCA

control input to turn it off to prevent transients from being heard when a voice switch is turned on.

6.3 Board C Circuit Description

Board C contains a voltage controlled filter (VCF), a voltage controlled amplifier (VCA), four high pass filters (HPF) and ten band pass filters (arranged in one of three banks). R.O.M.s Z6, Z7 and Z8 determine the signal paths through each of these filters and determines the settings for the VCF.

The sawtooth waveform supplied from board A is processed through the Sawtooth/Pulse Mixer and is routed through one or more of the High Pass Filters. The output of the HPF is routed through the VCF and the VCA to the output of the Pro Soloist.

The pulse waveform from the pulse amplifier can take either of two paths: through the Sawtooth/Pulse mixer, or through the resonator banks. Resonator banks 1, 2 and 3 are supplied with the pulse waveform only. R.O.M. Z8 determines which (if any) of the resonators in each bank are enabled. The output of Resonator Bank 1 and 2 may be routed only to the input of the VCA. The output of Resonator Bank 3 may be routed to the input of either the VCF or the VCA (again, determined by R.O.M. Z8).

The VCF Tracking circuit determines whether the VCF will track at one volt per octave, 2 volts per octave, 5 volts per octave, or not at all. The Resonance circuit determines the amount of feedback from the VCF output to the VCF input for 'wow' effects.

6.4 Board D Circuit Description

Board D provides the touch sensor effects: Vibrato, Pitch Bend, Wow, Repeat, Growl, and Brilliance.

Z3 is a low frequency oscillator producing a triangle wave for vibrato and tremolo, and a square wave for repeat triggers.

Z4 and Z5 are a voltage controlled amplifier exclusively for the vibrato signal. Q3, Q4 and Q5 delay the Vibrato VCA from turning on for certain voices (such as violin) producing a delayed vibrato. All 'upper' voices have delayed vibrato (if used at all); lower voices have undelayed vibrato. Z4D and Z4E switch the output of the Vibrato VCA to either P7-11 for vibrato or P7-16 for tremolo. Vibrato and tremolo are never on at the same time. Tremolo affects the VCF on board C; vibrato affects the pitch of the oscillator on board A.

Z2 B and Z2C are an astable flip flop oscillating at

32 Hz. to produce the growl signal. This signal is gated into a band pass circuit (Z2D and Z2E) through CR8. The growl output is applied to the VCF control input through Z6 on board B.

6.5 Board E Circuit Description

The keyboard electronics generate three signals which are routed to other parts of the instrument:

1. Pitch information (4 bit key code and 2 bit octave code).
2. Gate (+5 volts while a key is down).
3. Trigger (short pulse on each new key depression).

The codes for each key are as follows:

C	0000
C#	0001
D	0010
D#	0011
E	0100
F	0101
F#	0110
G	0111
G#	1000
A	1001
A#	1010
B	1011
Not used	1100
" "	1101
" "	1110
" "	1111
Octave 1	00
Octave 2	01
Octave 3	10
Octave 4	11
(High C only)	

In order to generate these coded outputs, the circuitry on board E is designed to scan the keyboard about 100 times per second. When the scanning circuitry comes to a note which is pressed down by the performer, the number corresponding to that note is loaded into the 6 bit memory at the output and a gate and trigger pulse are generated.

An oscillator (Z2C, Z8D Z8B and C3) produces a square wave at about 150 KHz. The output of the oscillator is fed into a six stage frequency divider (Z4 & Z5). The first four stages of the frequency divider (Z4) are wired to a 'data selector' chip (Z11).

The outputs of the six stage frequency dividers produce a six bit binary word which 'counts' from 00 0000 to 11 1111 (0 to 64). The first four divisions

of the frequency divider are connected to the data selector chip which monitors the changing code. The last two divisions (octave information) are decoded so that only one bus rod is enabled at a time (enabled is logic 0).

The inputs of Z11 are wired to the keyboard contacts such that all C's are wired to pin 8, C#s to pin 7 etc. When a key is depressed, one of the outputs of the octave decoder is connected to one of the inputs of the data selector chip. Pin 10 of Z11 will be a logic 1 *only* when the following occurs: 1) A key is depressed (to enable a particular input of Z11), 2) The octave decoder output is enabled (occurs only when the octave code is correct), and 3) The code on pins 11, 13, 14 and 15 matches the enabled input (Example: 'D' input is enabled AND code 0010 is present on the data selector input).

A logic 1 on pin 10 of Z11 indicates that at that instant, the codes on the output of the six stage frequency divider matches the key and octave depressed. The output of Z11 (pin 10) is processed through the strobe gate and the R-S flip flop to update the 6 bit memory by pulsing the clock inputs of the 'D' type flip flops. Thus the outputs of the 6 stage frequency divider are quickly memorized before the number changes.

Since the only time the R-S flip flop changes state is when a key is being depressed, the gate memory circuit monitors the output of the R-S flip flop to provide a gate signal (+5 volts) for as long as a key is depressed. The leading edge of the gate signal (Q bar) is differentiated and processed through the one shot circuit to develop a 15msec. delayed trigger pulse whenever a key is depressed.

When one key is being held, additional triggers are obtained from the 6 bit code change detector. The exclusive OR gates provide pulses to the one shot delay circuit only when the key or octave code change (when a different key is depressed).

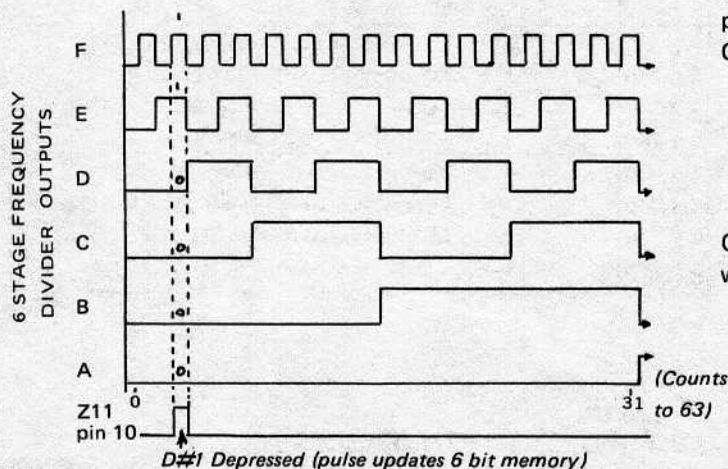

6.6 Board F-II & F-III Circuit Description

In order to minimize the number of interconnecting wires between the Voice Select board and the rest of the Pro Soloist, the 15 Voice Select switches are encoded into five bit binary words. In this manner, it is possible to send over five wires all of the information necessary to say which of the 15 switches has been depressed. Separate wires are also brought out for the portamento switch. In addition a Voice select squelch line is also brought out which indicates when none of the switches are on.

VOICE CODE TRUTH TABLE

	A = 0	A = 1	B	C	D	E
OFF	OFF	0	0	0	0	0
Buzz Bassoon	Bassoon	0	0	0	0	1
Saxophone	English Horn	0	0	1	0	0
Space Reed	Oboe	0	0	1	1	1
Telstar	Clarinet	0	1	0	0	0
Song Whistle	Flute	0	1	0	1	1
Noze	Tuba	0	1	1	0	0
Pulsar	Trombone	0	1	1	1	1
Comic Wow	French Horn	1	0	0	0	0
Mute Trumpet	Trumpet	1	0	0	0	1
Steel Guitar	Cello	1	0	1	0	0
Harpichord	Violin	1	0	1	1	1
Space Bass	Electric Bass	1	1	0	0	0
Steel Drum	Electric Piano	1	1	0	1	1
Country Guitar	Banjo	1	1	1	0	0
Fuzz Guitar II	Fuzz Guitar I	1	1	1	1	1

6.7 Board G (Power Supply)

An apparent malfunction of the power supply may be the result of shorts or other problems on other boards in the Pro Soloist. If there is any doubt about the power supply being defective, remove P1 from board C and clip on a set of dummy loads as follows:

- +15V to ground: 270 ohm, 1 Watt
- 15 V to ground: 330 ohm, 1 Watt
- +5 V to ground: 5 ohm, 10 Watt

Observe the following color coding of power supply wires:

- +15V = Red
- 15V = Violet
- + 5 V = Orange
- Ground = Black

ADDRESS
msb

ADDRESS									
A	B	C	D	E					
1	1	1	1	1	15 FUZZ GUITAR I	20 HARPSICHOARD	24 PULSAR	28 SPACE REED	
1	1	1	1	0	14 BANJO	21 STEEL GUITAR	25 NOZE	29 SAX	
1	1	1	0	1	12 ELEC. PIANO	22 MUTE TRUMPET	26 SONG WHISTLE	30 BUZZ BASSOON	
1	1	1	0	0	13 ELEC. BASS	23 COMIC WDW	27 TELSTAR	0 OFF	
1	1	0	1	1	VIOLIN	16 FUZZ GUITAR II	28 SPACE REED		
1	1	0	1	0	8 CELLO	14 COUNTRY GUITAR	29 SAX		
1	1	0	0	1	9 TRUMPET	18 STEEL DRUM	0 OFF		
1	1	0	0	0	3 FR. HORN	19 SPACE BASS			
1	0	1	1	1	7 TROMBONE	20 HARPSICHOARD			
1	0	1	1	0	6 TUBA	21 STEEL GUITAR			
1	0	1	0	1	5 FLUTE	22 MUTE TRUMPET			
1	0	1	0	0	4 CLARINET	23 COMIC WDW			
1	0	0	1	1	3 OBOE	24 PULSAR			
1	0	0	1	0	2 ENG. HORN	25 NOZE			
1	0	0	0	1	1 BASSOON	26 SONG WHISTLE			
1	0	0	0	0	0 OFF	27 TELSTAR			
0	1	1	1	1	16 FUZZ GUITAR II	28 SPACE REED			
0	1	1	1	0	14 COUNTRY GUITAR	29 SAX			
0	1	1	0	1	18 STEEL DRUM	0 OFF			
0	1	1	0	0	19 SPACE BASS				
0	1	0	1	1	20 HARPSICHOARD				
0	1	0	1	0	21 STEEL GUITAR				
0	1	0	0	1	22 MUTE TRUMPET				
0	1	0	0	0	23 COMIC WDW				
0	0	1	1	1	24 PULSAR				
0	0	1	1	0	25 NOZE				
0	0	1	0	1	26 SONG WHISTLE				
0	0	1	0	0	27 TELSTAR				
0	0	0	1	1	28 SPACE REED				
0	0	0	1	0	29 SAX				
0	0	0	0	1	30 BUZZ BASSOON				
0	0	0	0	0	0 OFF				

BOARD A Z15

PIN	
9	LOGIC 1 SELECT DYNAMIC PULSE
7	LOGIC 1 SELECT 1/14 PULSE
6	LOGIC 1 SELECT 1/9 PULSE
5	LOGIC 1 SELECT 1/64 PULSE
4	LOGIC 1 SELECT 1/2 PULSE
3	LOGIC 1 SELECT 2/11 PULSE
2	LOGIC 1 ENABLE DOWN 1 OCTAVE
1	LOGIC 1 ENABLE DOWN 2 OCTAVES

BOARD B Z1

9	LOGIC 1 ENABLE VCA ATTENUATOR
7	LOGIC 1 SELECT ADSR S/R B
6	LOGIC 1 SELECT ADSR S/R A
5	LOGIC 1 SELECT ADSR RELEASE C
4	LOGIC 1 SELECT ADSR RELEASE B
3	LOGIC 1 SELECT ADSR RELEASE A
2	LOGIC 1 SELECT ADSR SUSTAIN B
1	LOGIC 1 SELECT ADSR SUSTAIN A

BOARD B Z2

9	LOGIC 1 SELECT ADSR DECAY B
7	LOGIC 1 SELECT ADSR DECAY A
6	LOGIC 1 SELECT ADSR ATTACK C
5	LOGIC 1 SELECT ADSR ATTACK B
4	LOGIC 1 SELECT ADSR ATTACK A
3	LOGIC 1 SELECT AR RELEASE A
2	LOGIC 1 SELECT AR ATTACK B
1	LOGIC 1 SELECT AR ATTACK A

BOARD B Z3

9	LOGIC 1 SELECT VCF ENV. ATTEN. D
7	LOGIC 1 SELECT VCF ENV. ATTEN. C
6	LOGIC 1 SELECT VCF ENV. ATTEN. B
5	LOGIC 1 SELECT VCF ENV. ATTEN. A
4	LOGIC 1 ROUTE ADSR TO VCF
3	LOGIC 1 ROUTE ADSR TO VCA
2	LOGIC 1 ROUTE AR TO VCF
1	LOGIC 1 ROUTE AR TO VCA

MSB ADDRESS

								BOARD C Z6			
								PIN			
A	B	C	D	E							
1	0	1	1	1	0	1	1	1	1	9	LOGIC 1 SELECT MAX. FILTER RES.
0	0	1	1	1	0	1	1	0	1	7	LOGIC 1 SELECT MED. FILTER RES.
0	0	1	1	1	1	1	0	0	0	6	LOGIC 1 SELECT NO FILTER RES.
0	1	1	1	1	1	0	1	1	1	5	LOGIC 0 ENABLE NO TRACK
1	1	1	1	1	1	1	1	1	1	4	LOGIC 0 ENABLE TRACK 5V/OCT
1	0	0	0	0	0	1	0	0	0	3	LOGIC 0 ENABLE TRACK 2V/OCT
0	0	0	1	0	0	0	0	1	0	2	LOGIC 0 ENABLE FILTER OFFSET B
0	1	1	1	0	0	0	0	1	0	1	LOGIC 0 ENABLE FILTER OFFSET A
								BOARD C Z7			
								PIN			
1	1	1	1	1	1	1	1	1	1	9	LOGIC 0 ENABLE E. HORN & NO. 2 RES.
0	1	1	1	0	0	0	0	0	0	7	LOGIC 1 ENABLE PULSE +10 dB
1	1	0	0	1	0	0	1	1	1	6	LOGIC 1 ROUTE PULSE TO HPF INPUT
1	0	0	0	1	0	0	0	0	0	5	LOGIC 1 ROUTE SAWTOOTH TO HPF
0	0	0	0	0	0	0	0	0	1	4	LOGIC 1 ENABLE HPF D
1	0	0	0	1	0	1	0	0	0	3	LOGIC 1 ENABLE HPF C
0	1	0	0	1	1	0	1	0	1	2	LOGIC 1 ENABLE HPF B
0	0	0	1	1	0	0	0	1	1	1	LOGIC 1 ENABLE HPF A
								BOARD C Z8			
								PIN			
0	1	1	1	1	0	0	0	0	1	9	LOGIC 1 ROUTE NO. 3 RES. TO VCF
1	0	0	0	1	0	0	0	1	0	7	LOGIC 1 ROUTE NO. 3 RES. TO VCA
1	0	0	0	0	1	0	0	1	0	6	LOGIC 1 ENABLE OBOE RESONATOR
1	0	0	1	1	0	1	1	0	0	5	LOGIC 1 ENABLE E. BASS RESONATOR
1	0	1	0	0	0	0	0	1	0	4	LOGIC 1 ENABLE E. PIANO RESONATOR
0	1	0	0	1	1	0	1	0	0	3	LOGIC 1 ENABLE VIOLIN 1 RESONATOR
0	1	1	1	1	1	1	1	1	1	2	LOGIC 0 ENABLE RES. 1&2, CELLO 1,2 &3
1	1	1	1	1	0	1	1	1	0	1	LOGIC 0 ENABLE RES. 1 & 2, VIOLIN 2,3
								BOARD D Z1			
								PIN			
0	0	0	0	0	0	1	0	0	0	9	LOGIC 1 ENABLE GROWL B MAX
0	0	0	0	1	0	0	1	0	0	7	LOGIC 1 ENABLE GROWL A [+B]
0	0	0	0	0	0	0	1	1	0	6	LOGIC 1 ENABLE VIBRATO C MIN.
1	0	0	0	0	1	0	1	1	0	5	LOGIC 1 ENABLE VIBRATO B MED.
1	0	0	1	0	0	0	0	1	0	4	LOGIC 1 ENABLE VIBRATO A MAX.
1	1	0	0	1	1	0	0	1	1	3	LOGIC 1 ENABLE VIBRATO, 0=TREMOLO
0	0	1	1	1	0	0	0	1	1	2	LOGIC 1 ENABLE FILTER OFFSET C [D]
0	0	1	1	0	0	0	0	1	0	1	LOGIC 1 ENABLE FILTER OFFSET D

A	B	C	D	E
1	0	0	0	1

2701 BOARD TEST POINTS: REFER TO THE SCHEMATICS FOR BOARDS A, B & C FOR THE LOCATIONS OF THE TEST POINTS.

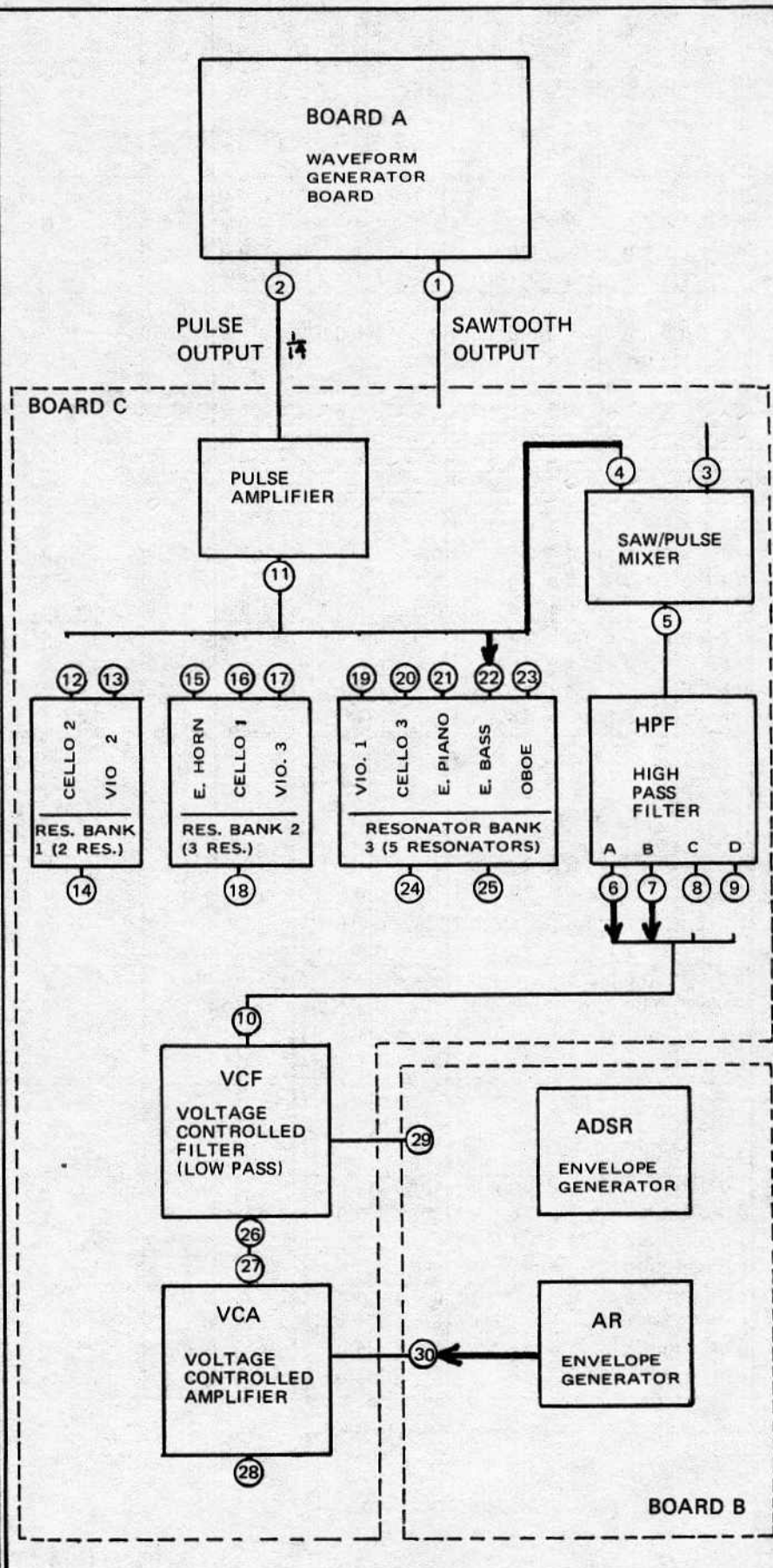
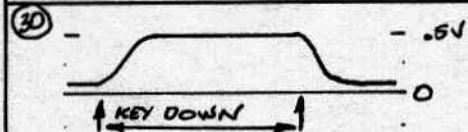
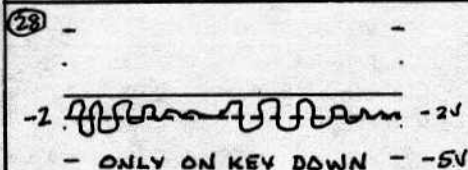
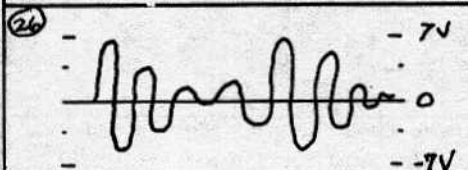
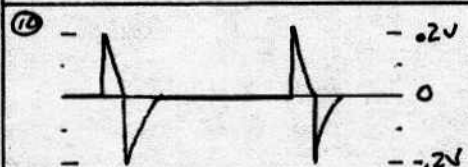
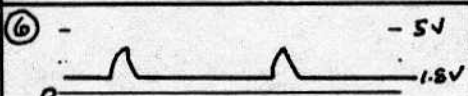
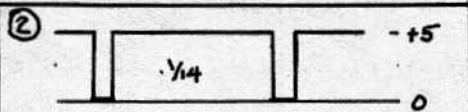

VOICE CODE

A	B	C	D	E
1	0	0	1	0

2701 VOICE FLOW CHART

VOICE: ENG. HORN ②

2701 BOARD TEST POINTS: REFER TO THE SCHEMATICS FOR BOARDS A, B & C FOR THE LOCATIONS OF THE TEST POINTS.

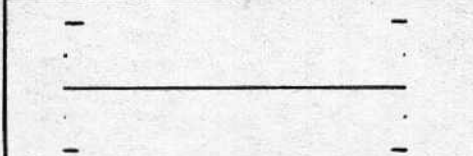
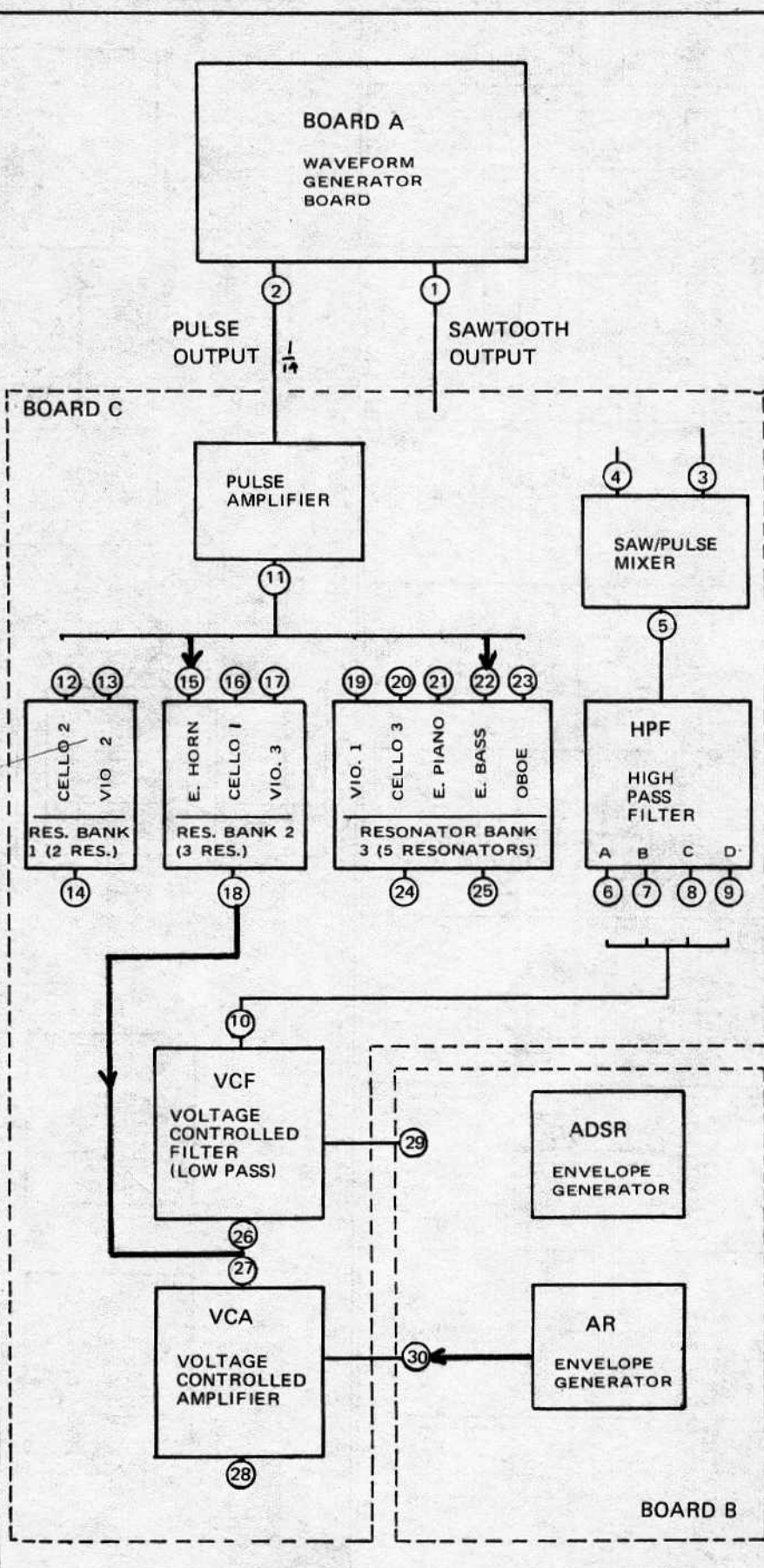
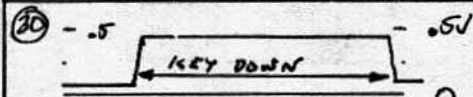
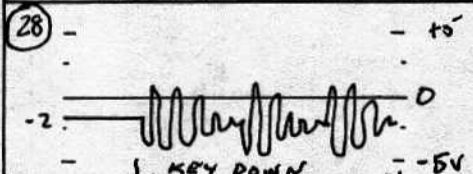
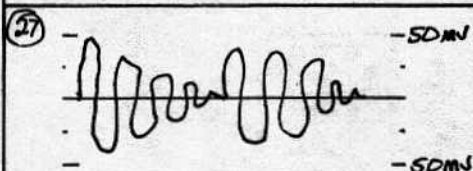
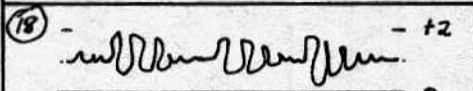
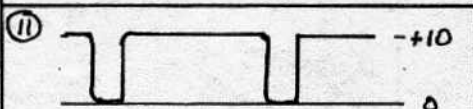
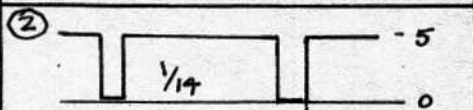

VOICE CODE

A	B	C	D	E
1	0	0	1	1

2701 VOICE FLOW CHART

VOICE:OBOE ③

2701 BOARD TEST POINTS: REFER TO THE SCHEMATICS FOR BOARDS A, B & C FOR THE LOCATIONS OF THE TEST POINTS.

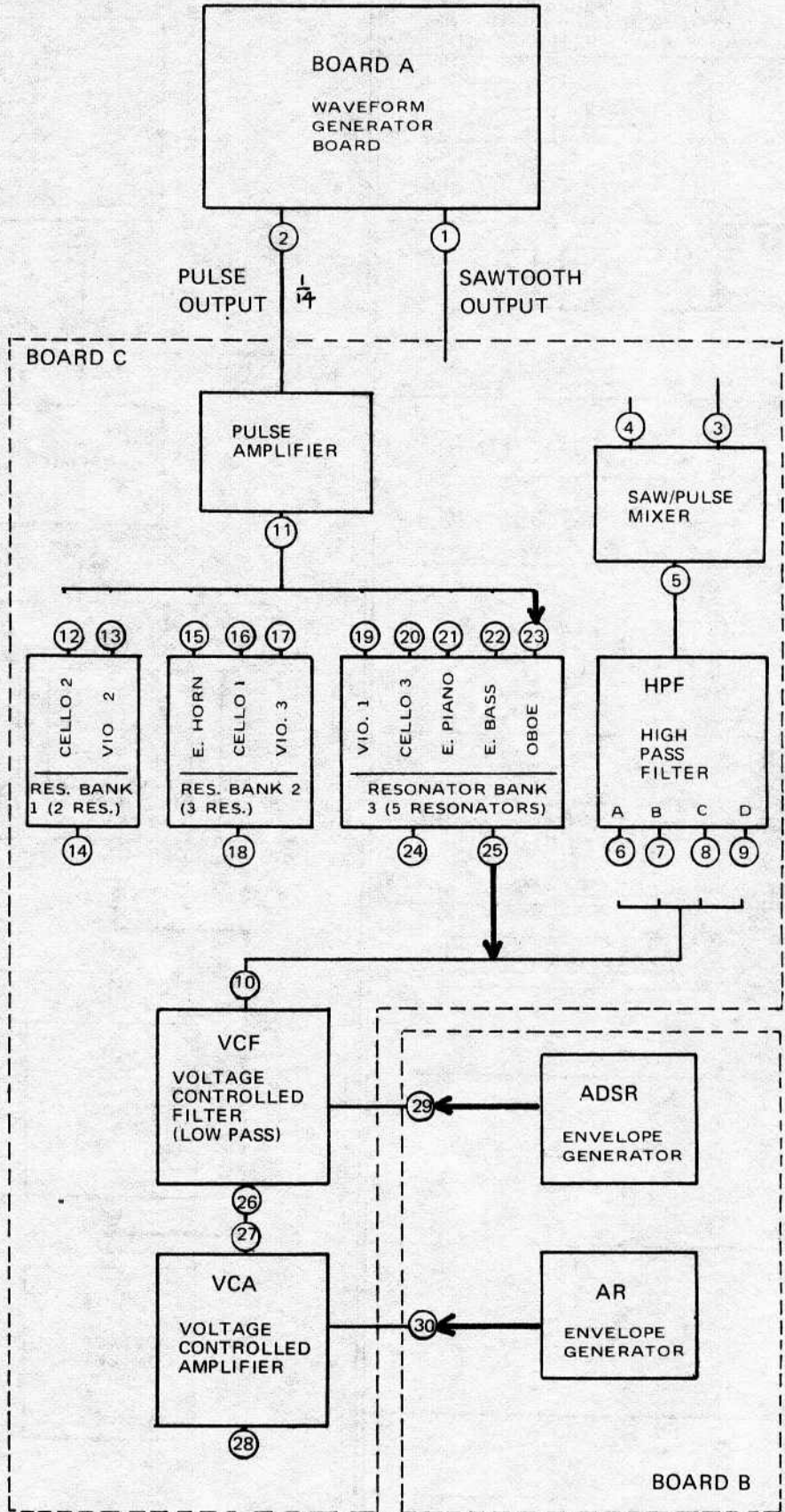
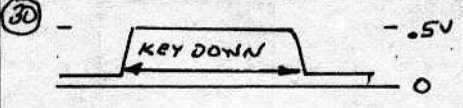
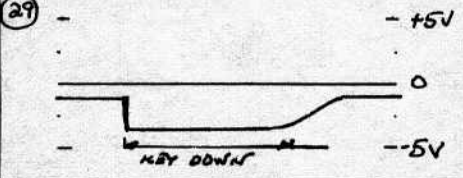
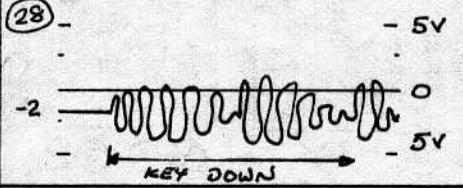
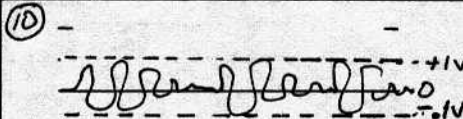
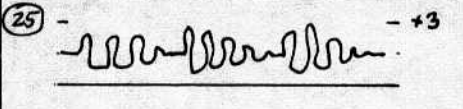
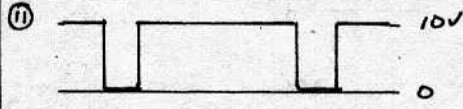
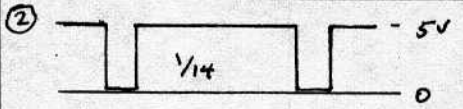

VOICE CODE	A	B	C	D	E
	1	0	1	0	0

2701 VOICE FLOW CHART

VOICE: CLARINET ④

2701 BOARD TEST POINTS: REFER TO THE SCHEMATICS FOR BOARDS A, B & C FOR THE LOCATIONS OF THE TEST POINTS.

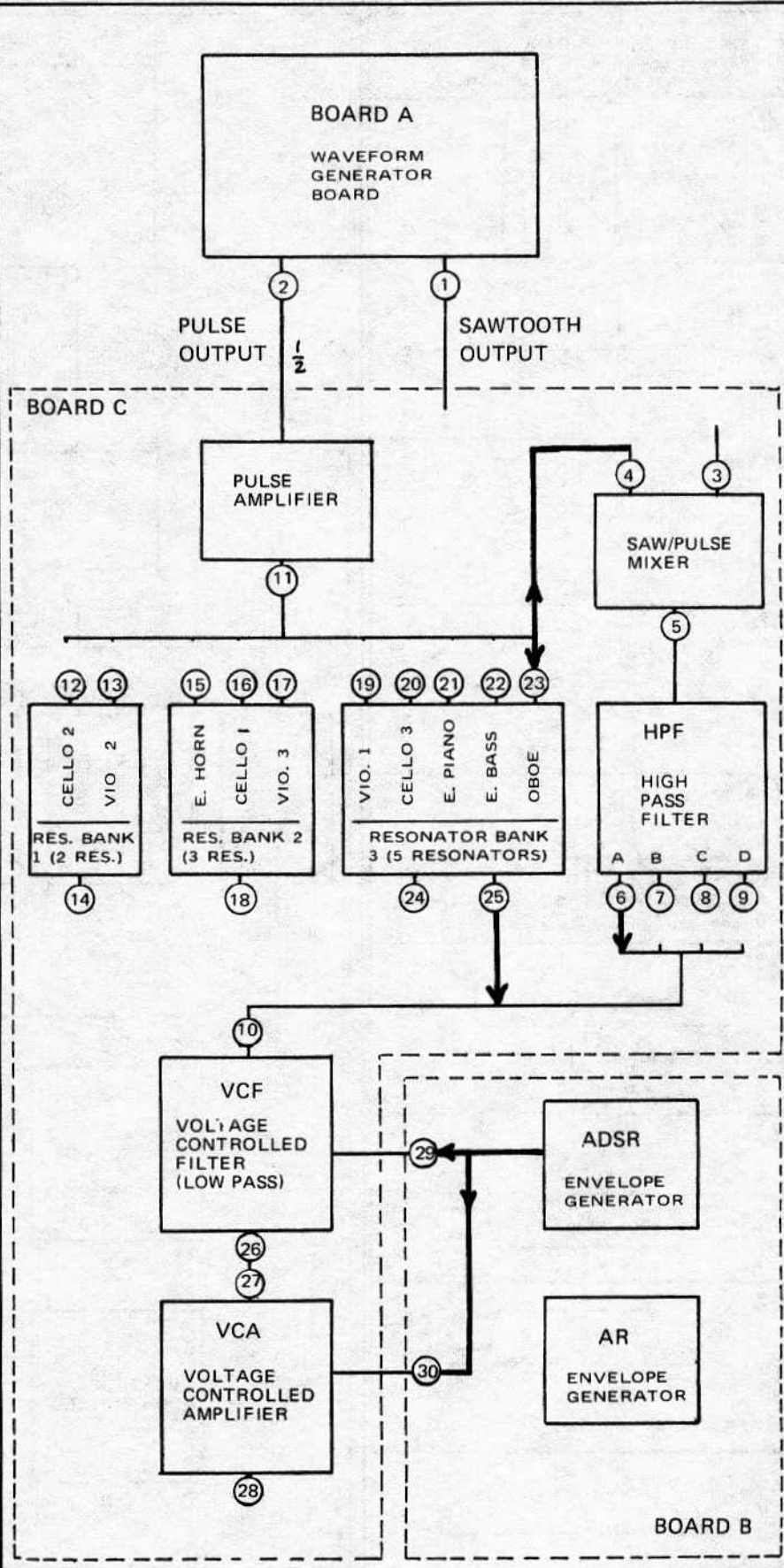
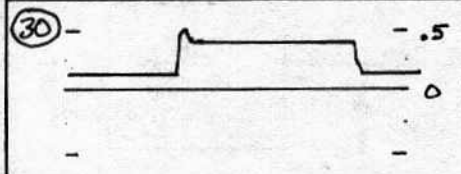
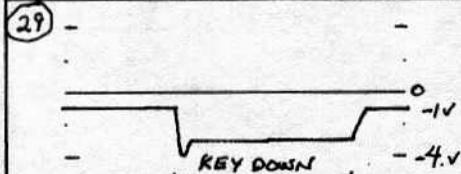
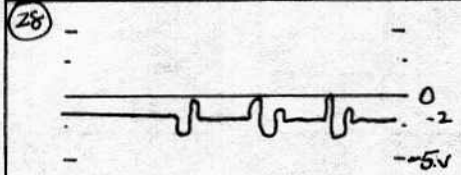
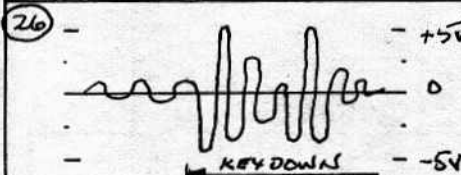
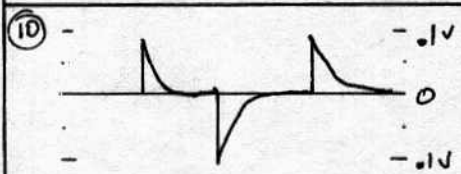
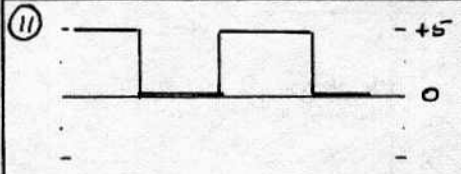
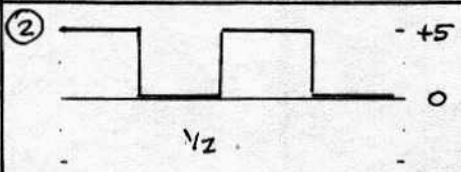

VOICE CODE

A	B	C	D	E
1	0	1	0	1

2701 VOICE FLOW CHART

VOICE: FLUTE

2701 BOARD TEST POINTS: REFER TO THE SCHEMATICS FOR BOARDS A, B & C FOR THE LOCATIONS OF THE TEST POINTS.

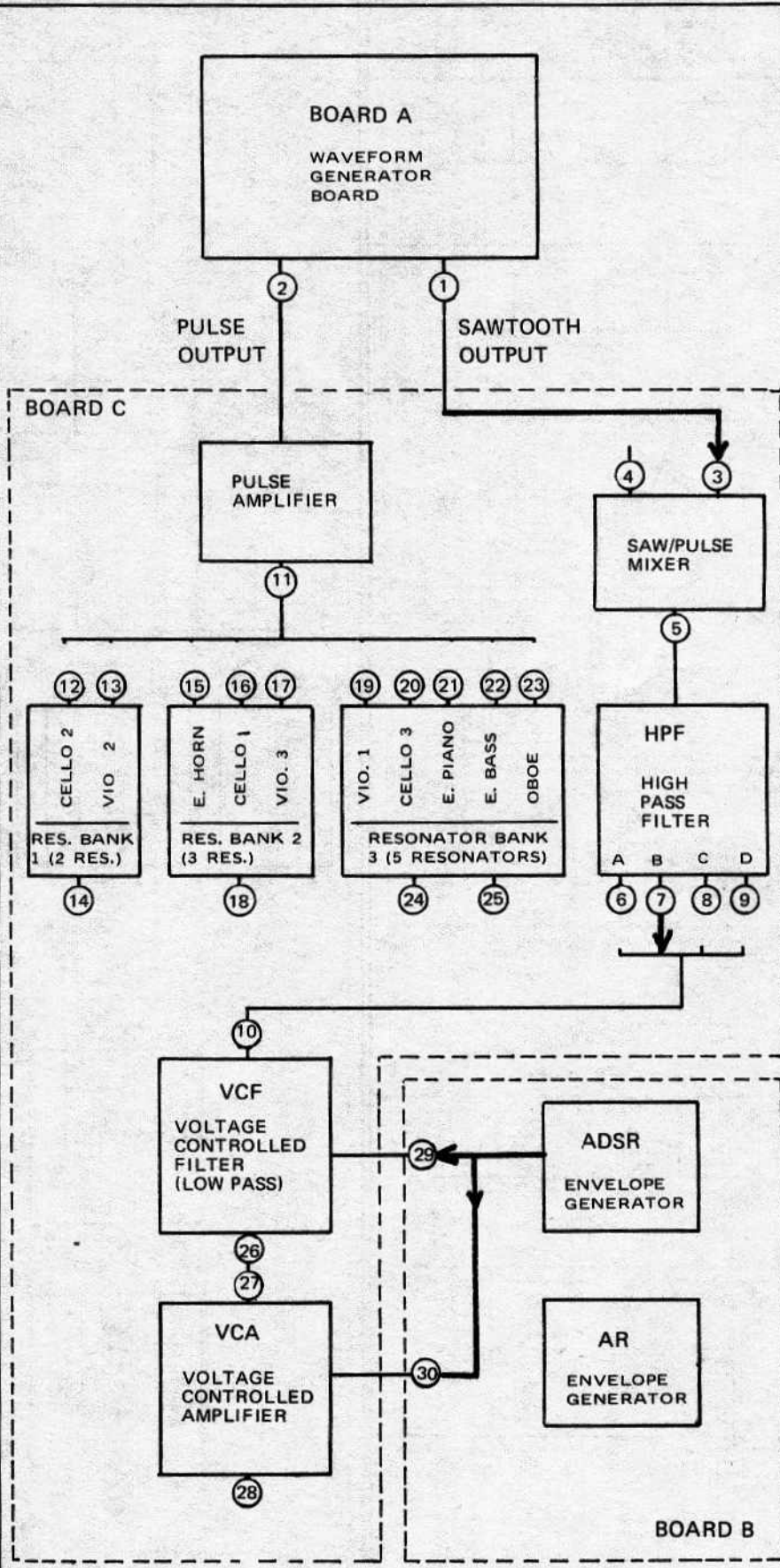
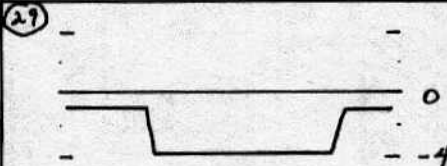
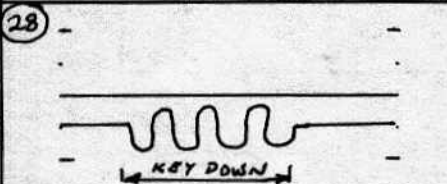
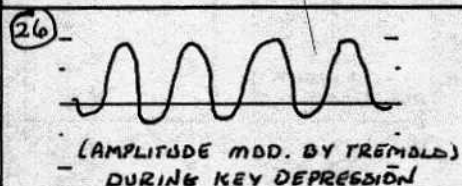
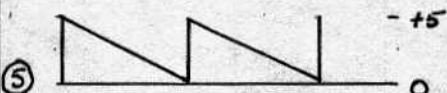
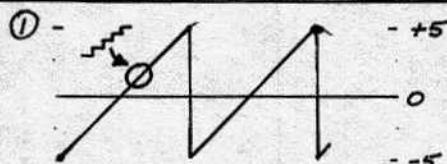

VOICE CODE	A	B	C	D	E
	1	0	1	1	0

2701 VOICE FLOW CHART

VOICE: TUBA [©]

2701 BOARD TEST POINTS: REFER TO THE SCHEMATICS FOR BOARDS A, B & C FOR THE LOCATIONS OF THE TEST POINTS.

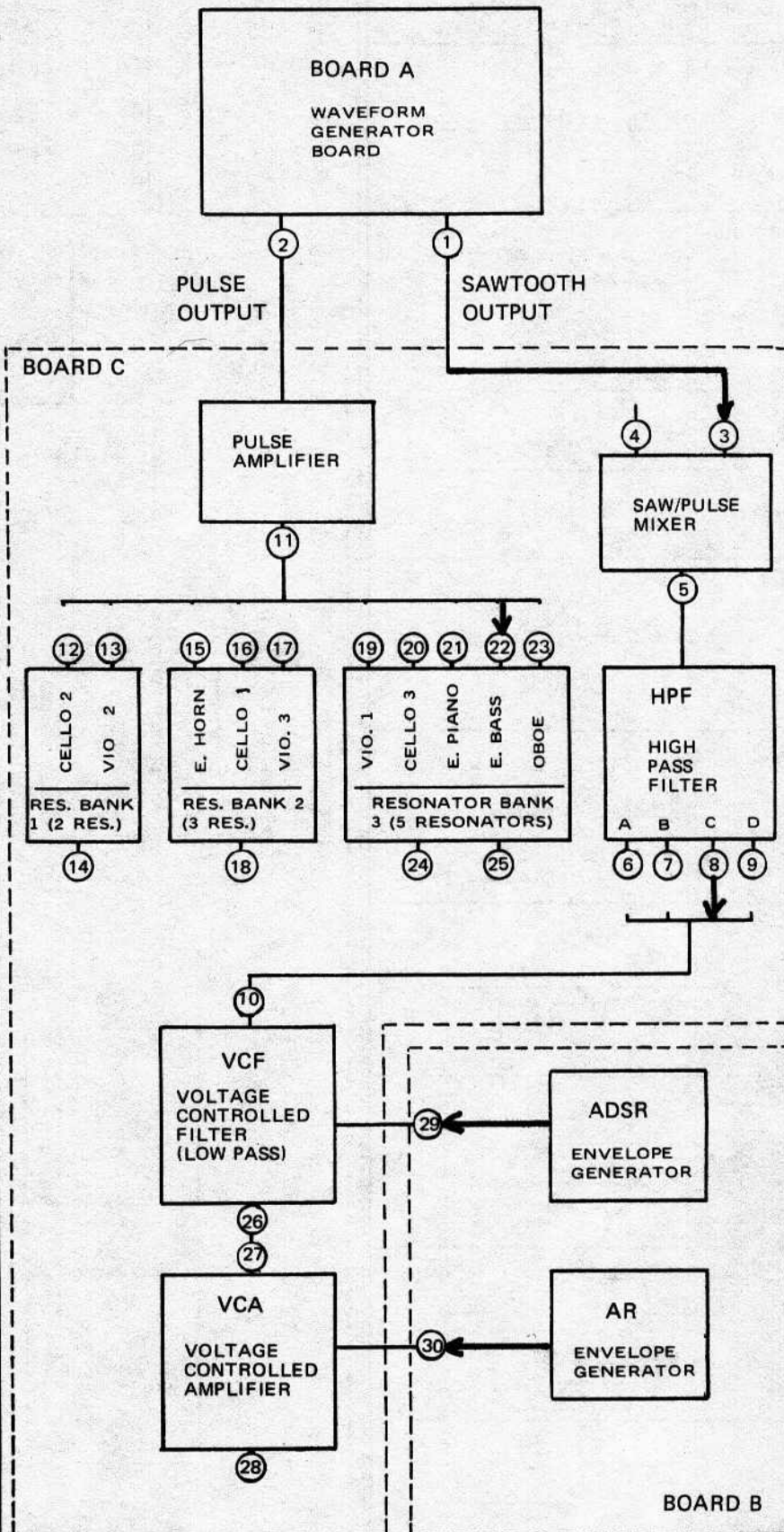
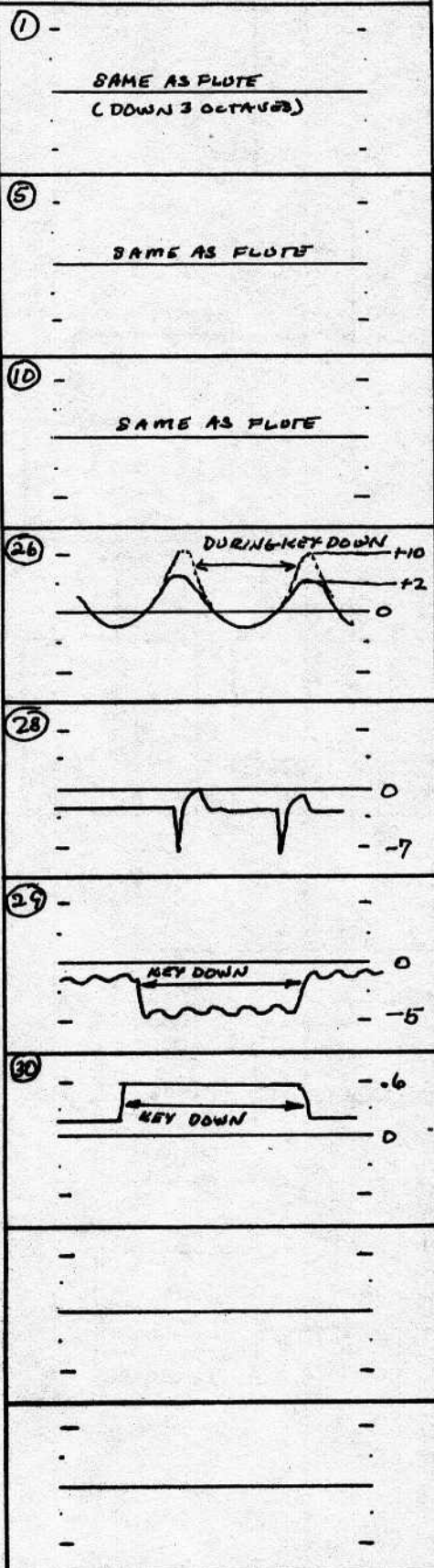

BOARD B

VOICE CODE

A	B	C	D	E
1	0	1	1	1

2701 VOICE FLOW CHART

VOICE: TROMBONE®

2701 BOARD TEST POINTS: REFER TO THE SCHEMATICS FOR BOARDS A, B & C FOR THE LOCATIONS OF THE TEST POINTS.

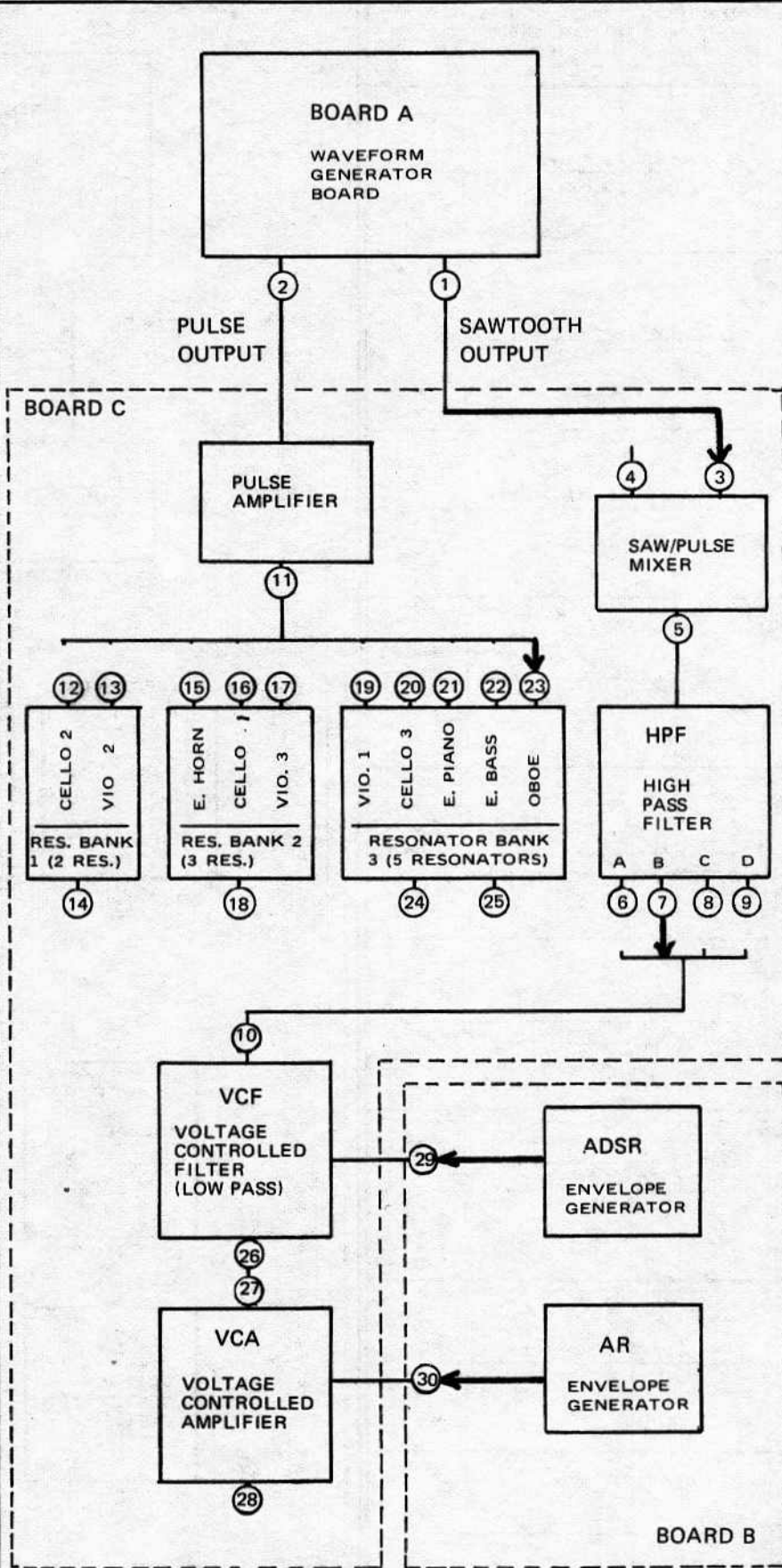
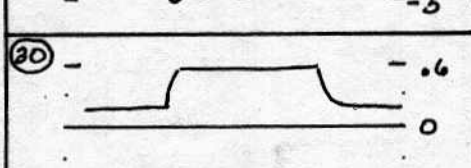
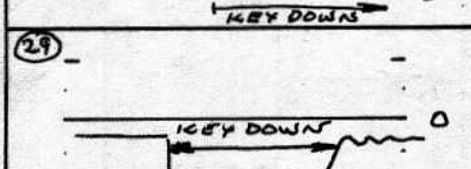
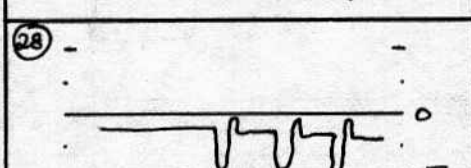
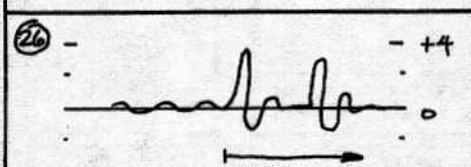
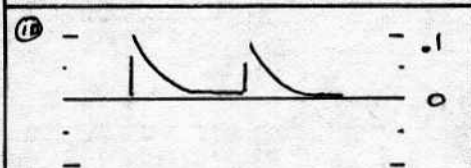
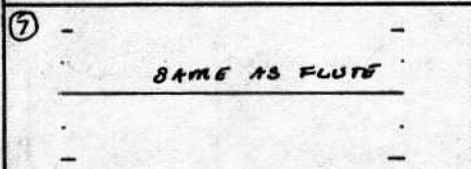
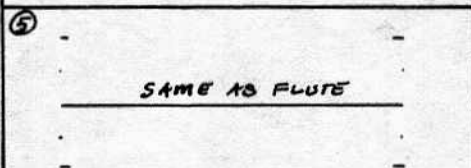
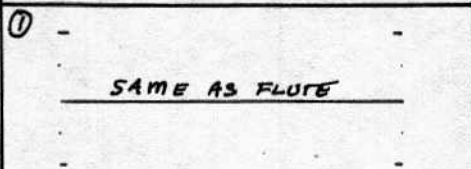

VOICE CODE	A	B	C	D	E
	1	1	0	0	0

2701 VOICE FLOW CHART

VOICE: FR. HORN®

2701 BOARD TEST POINTS: REFER TO THE SCHEMATICS FOR BOARDS A, B & C FOR THE LOCATIONS OF THE TEST POINTS.

① -

SAME AS FLUTE

⑤ -

SAME AS FLUTE

⑦ -

SAME AS FLUTE
(SHARPER)

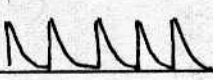
⑩ -

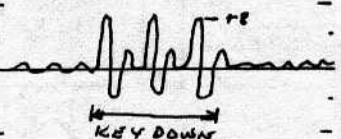
⑫ -

⑭ -

⑯ -

SAME AS FLUTE

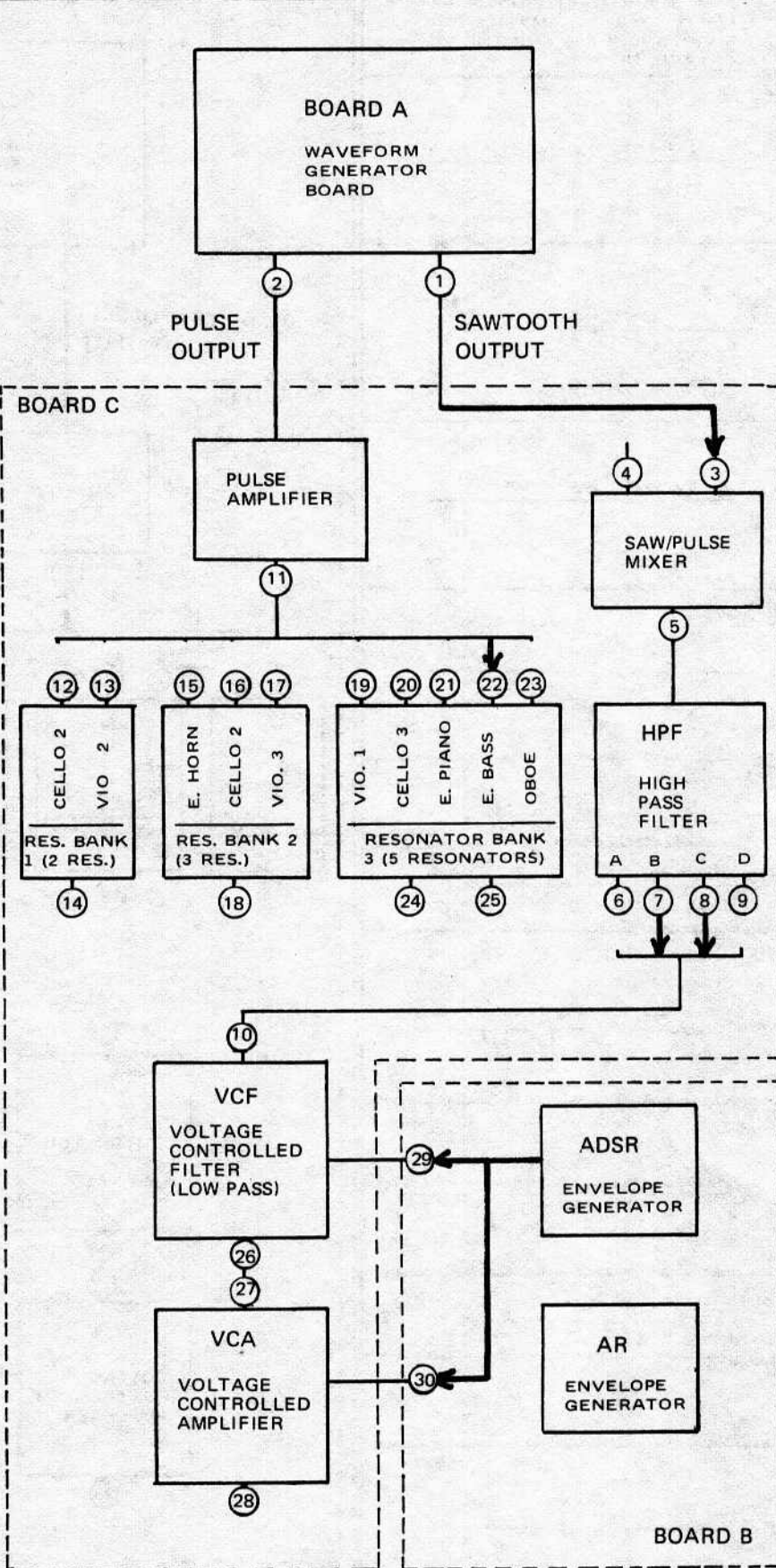

A	B	C	D	E
1	1	0	0	1

2701 BOARD TEST POINTS: REFER TO THE SCHEMATICS FOR BOARDS A, B & C FOR THE LOCATIONS OF THE TEST POINTS.

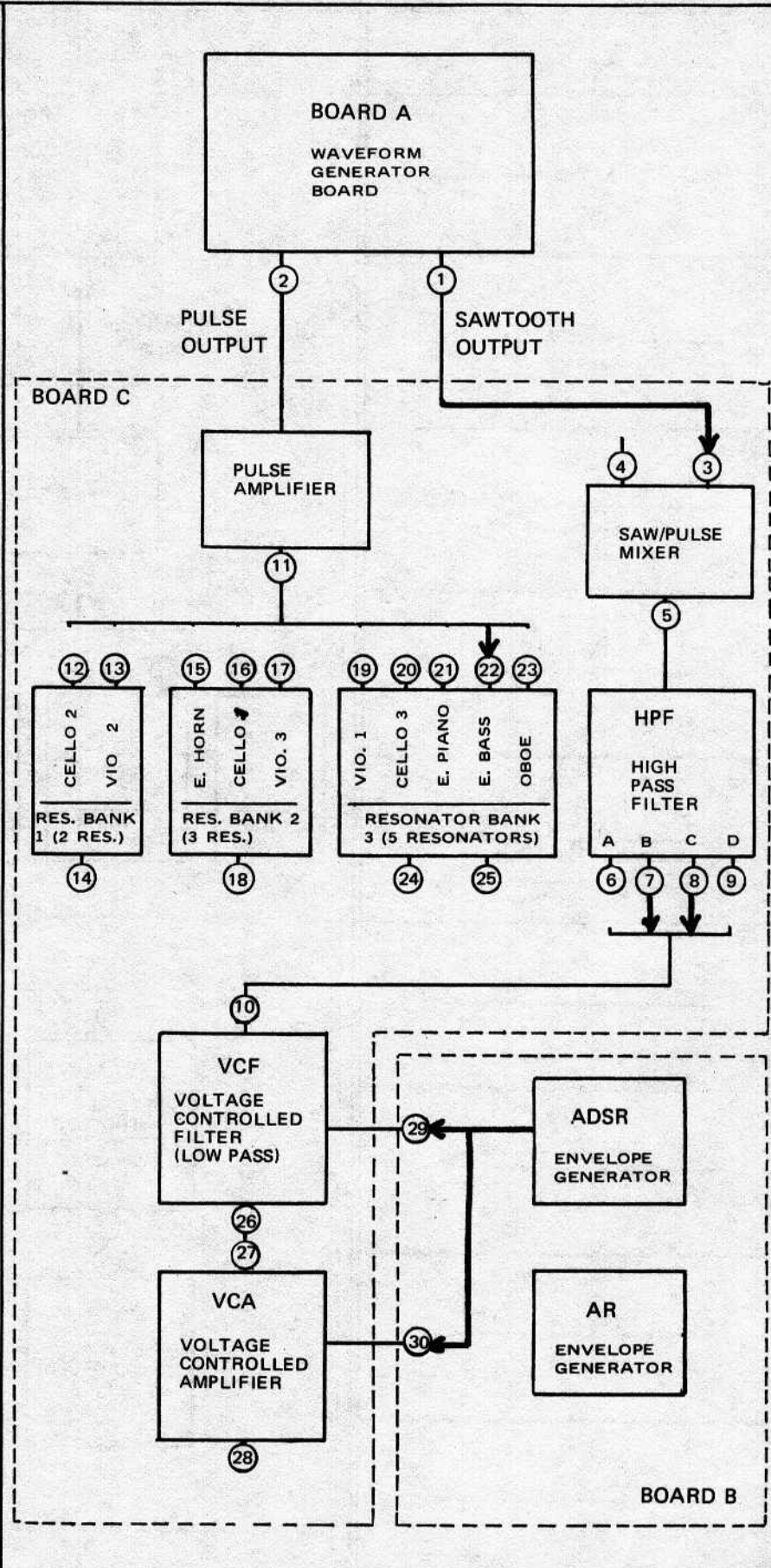
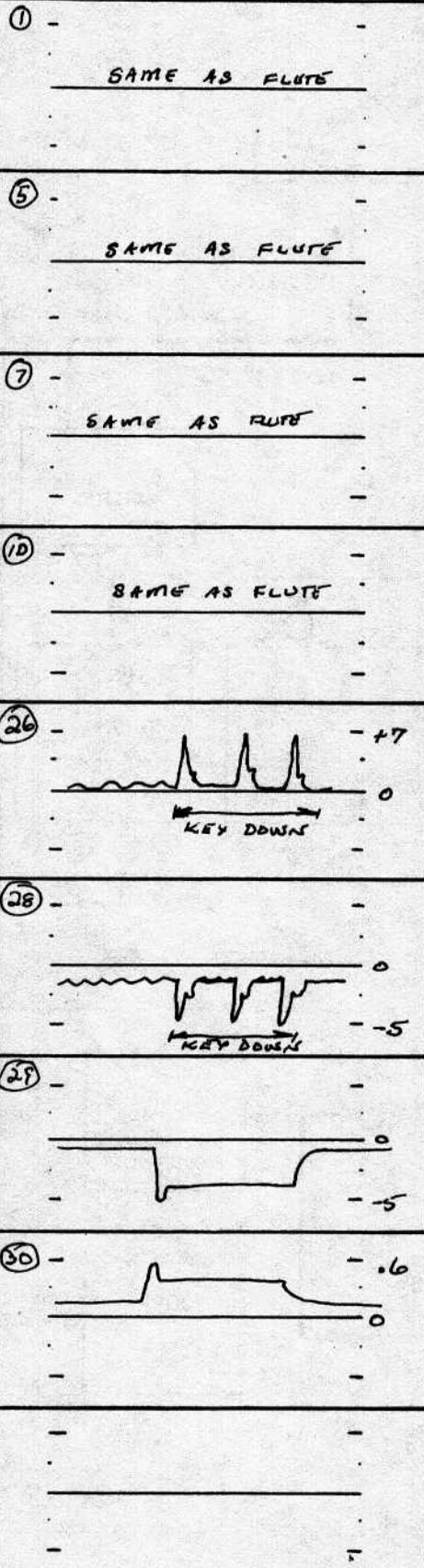

VOICE CODE	A	B	C	D	E
	1	1	0	1	0

2701 VOICE FLOW CHART

VOICE: CELLO

2701 BOARD TEST POINTS: REFER TO THE SCHEMATICS FOR BOARDS A, B & C FOR THE LOCATIONS OF THE TEST POINTS.

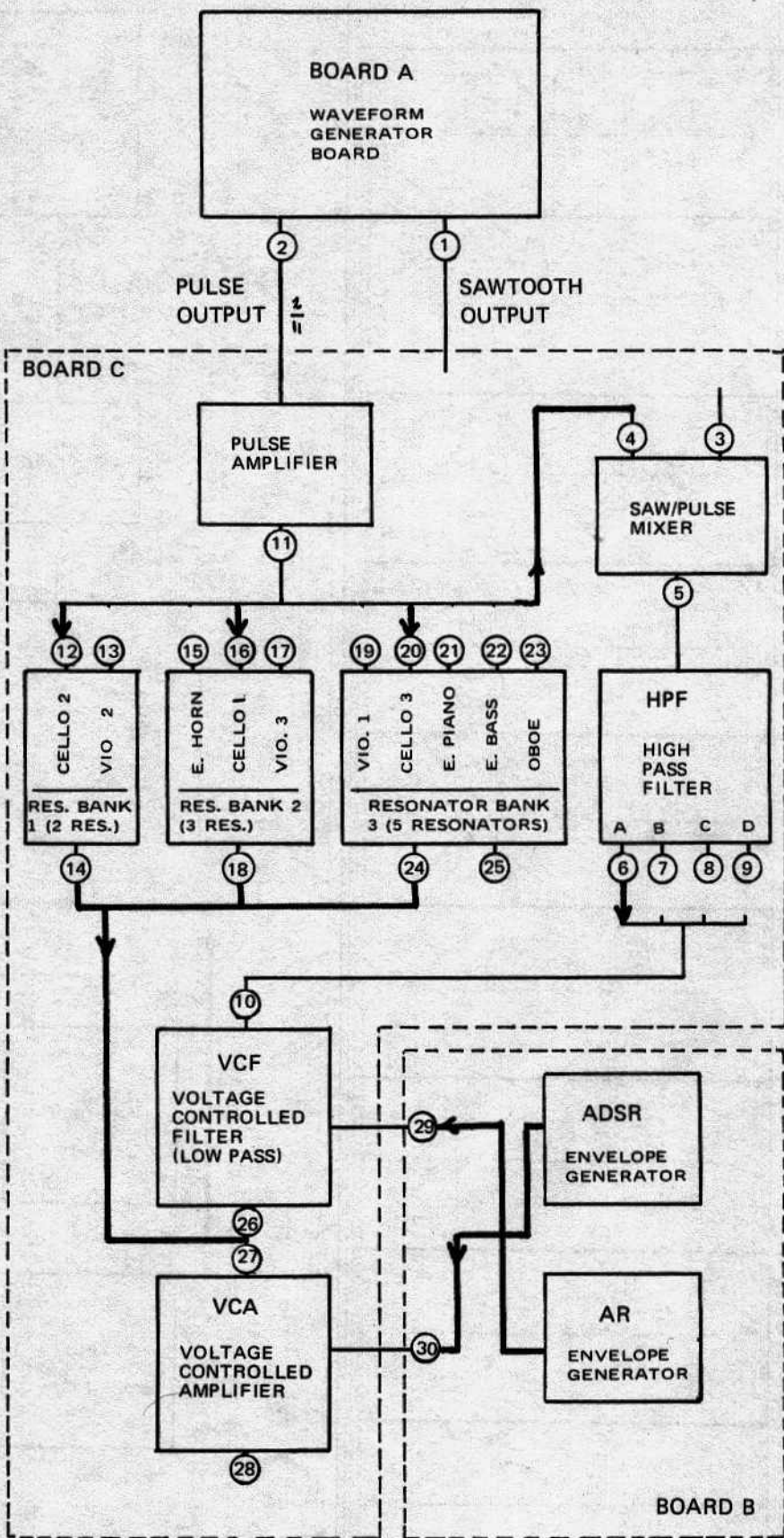
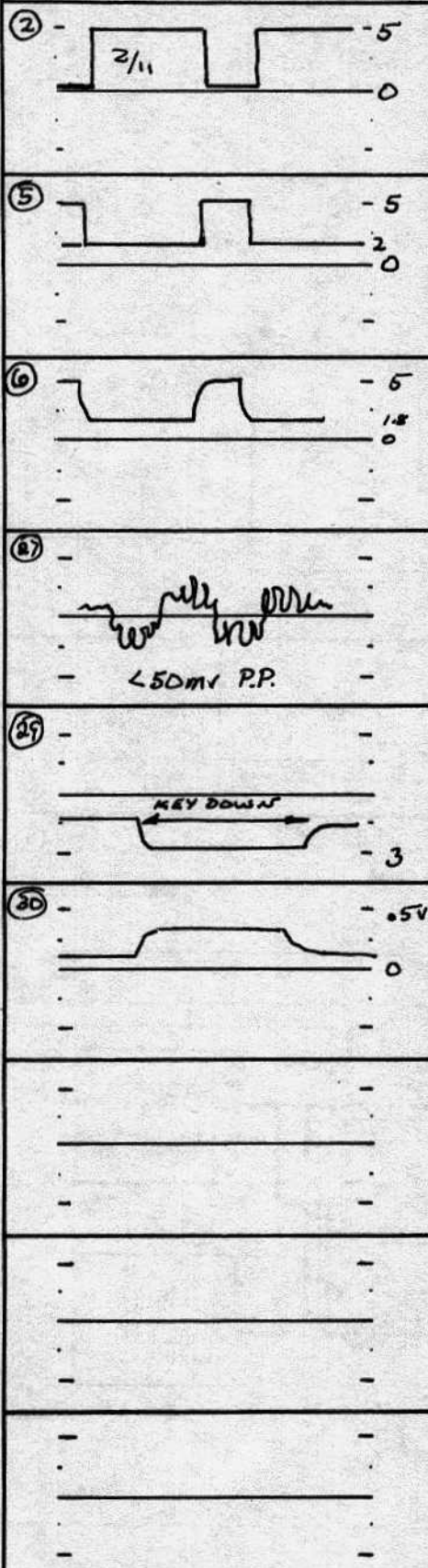

VOICE CODE	A	B	C	D	E
	1	1	0	1	1

2701 VOICE FLOW CHART

VOICE: VIOLIN [®]

2701 BOARD TEST POINTS: REFER TO THE SCHEMATICS FOR BOARDS A, B & C FOR THE LOCATIONS OF THE TEST POINTS.

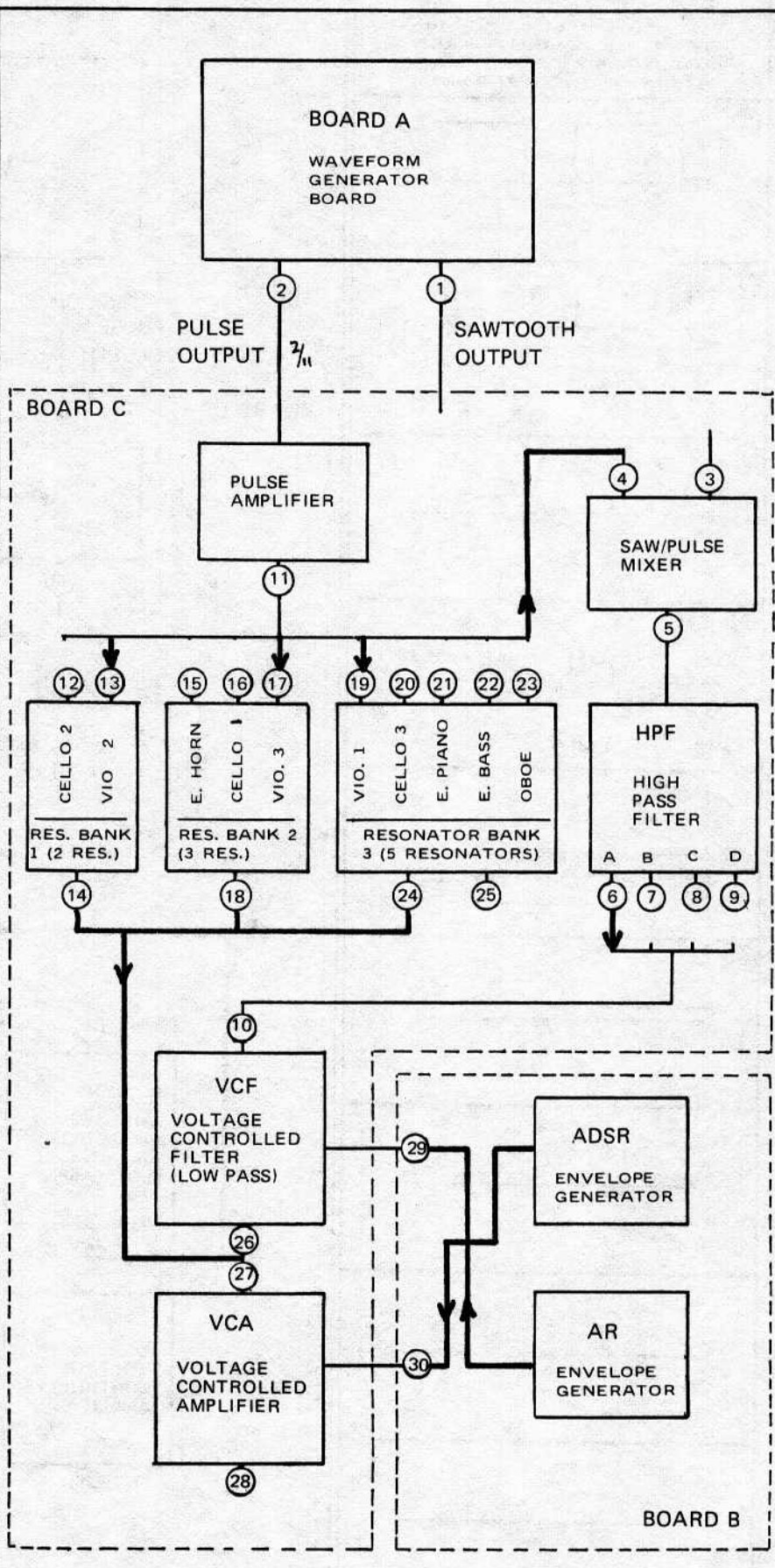
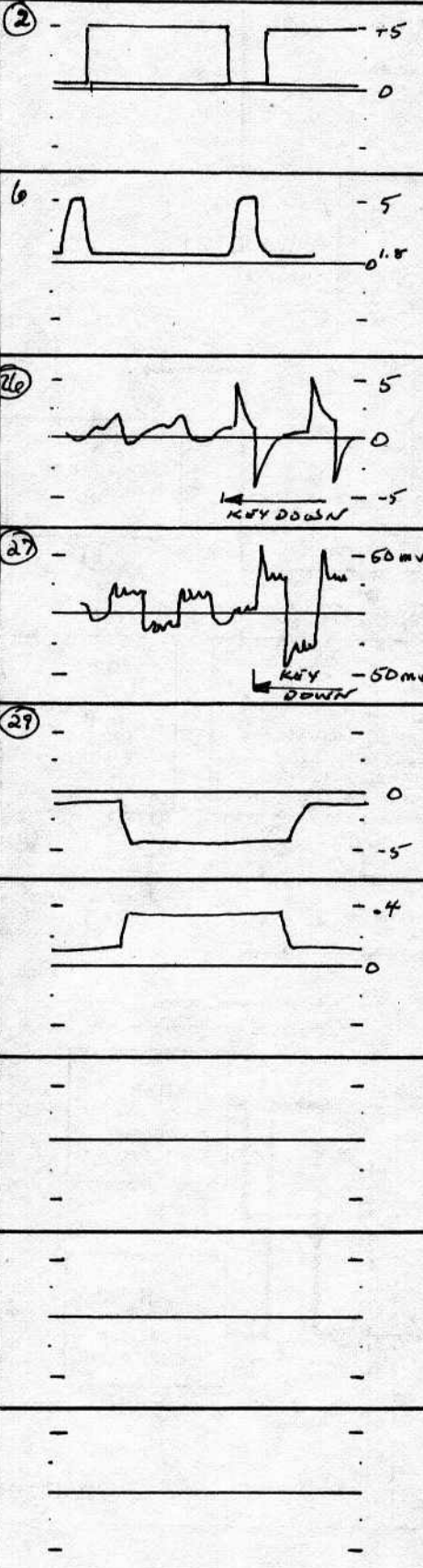

A	B	C	D	E
1	1	1	0	0

2701 BOARD TEST POINTS: REFER TO THE SCHEMATICS FOR BOARDS A, B & C FOR THE LOCATIONS OF THE TEST POINTS.

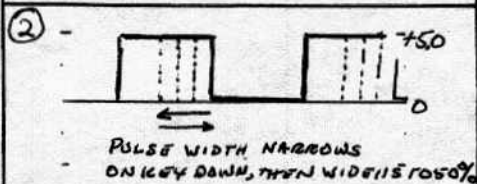

⑪ SAME AS TP-2 EXCEPT 110V

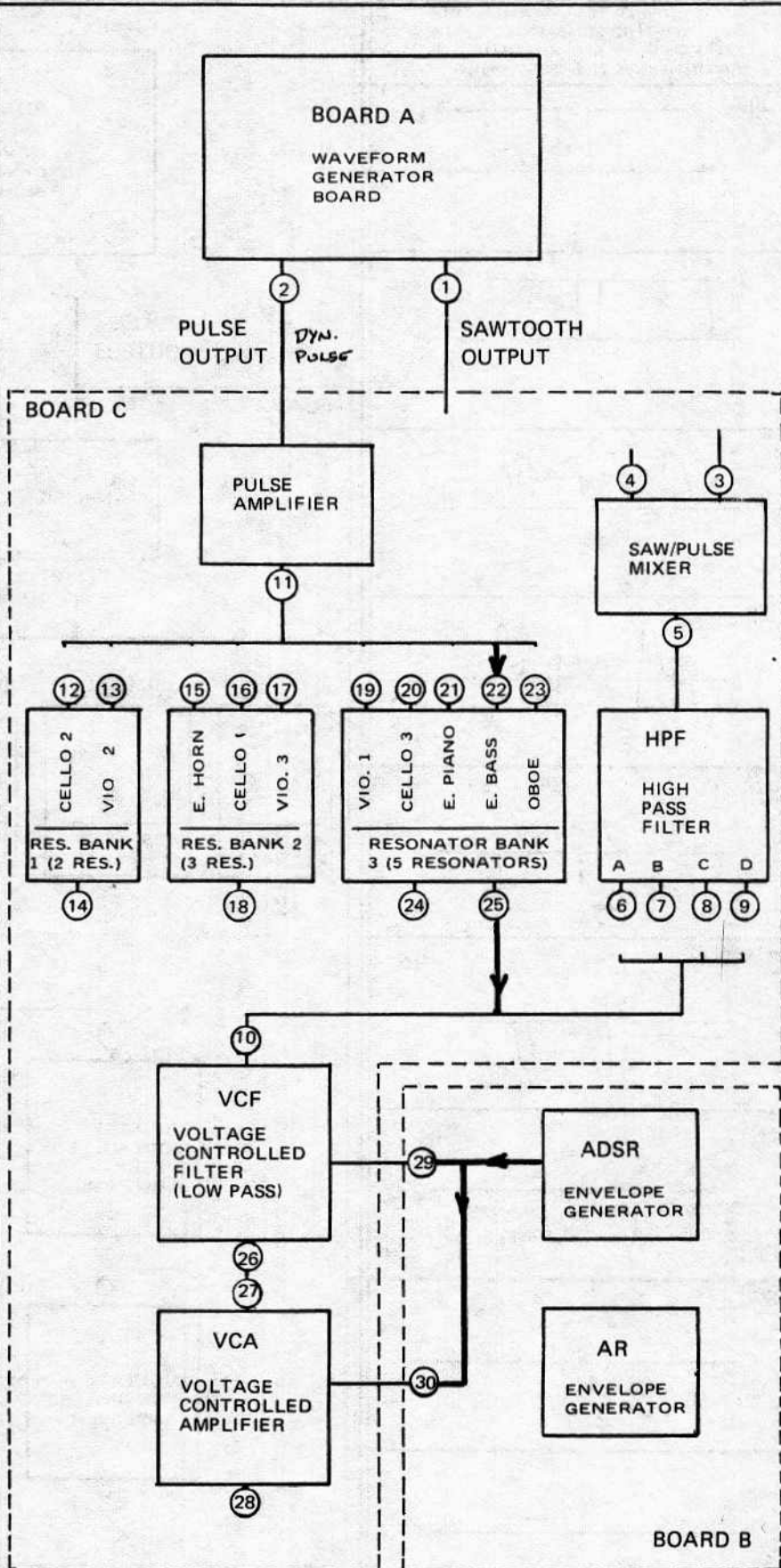
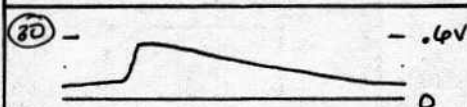
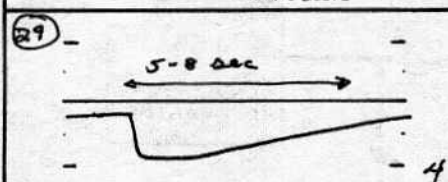
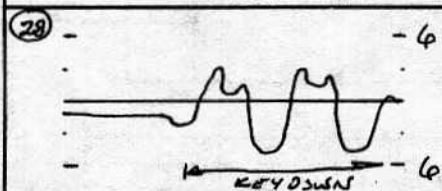
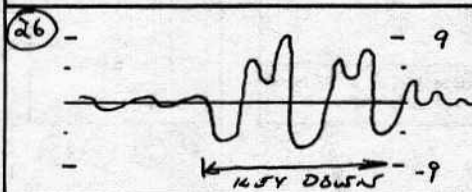
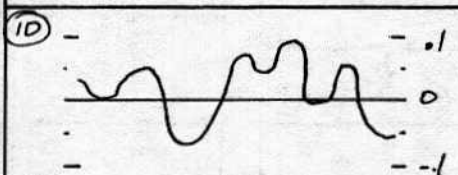
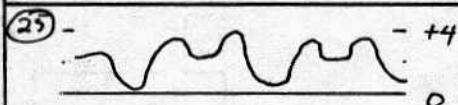

VOICE CODE	A	B	C	D	E
	1	1	1	0	1

2701 VOICE FLOW CHART

VOICE:ELEC. PIANO®

2701 BOARD TEST POINTS: REFER TO THE SCHEMATICS FOR BOARDS A, B & C FOR THE LOCATIONS OF THE TEST POINTS.

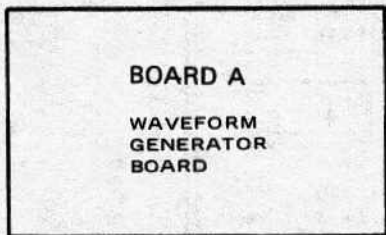
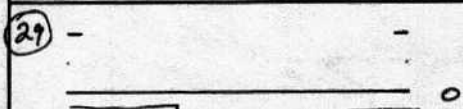
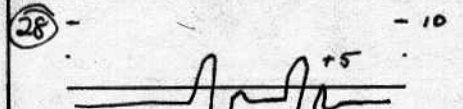
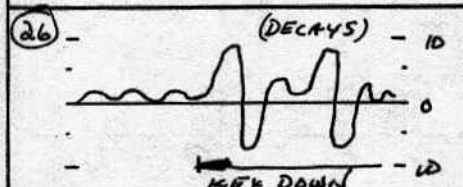
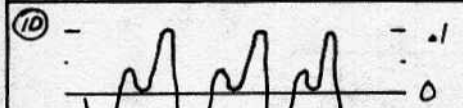
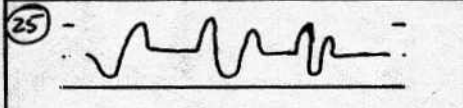
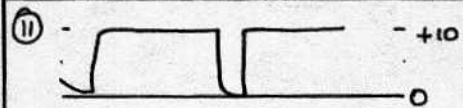
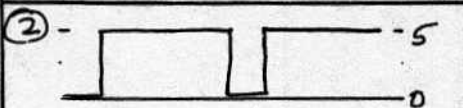

PULSE OUTPUT $\frac{1}{4}$
SAWTOOTH OUTPUT

BOARD C

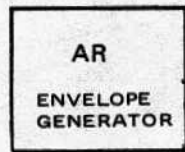
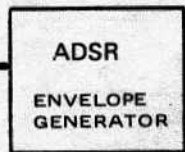
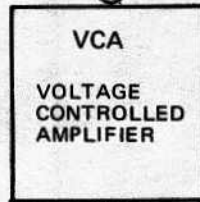
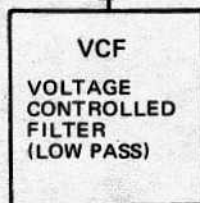
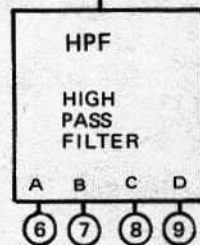
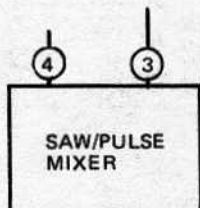
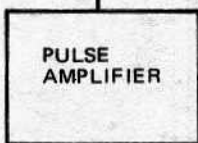

BOARD B

VOICE CODE	A	B	C	D	E
	1	1	1	1	0

2701 VOICE FLOW CHART

VOICE: BANJO [®]

2701 BOARD TEST POINTS: REFER TO THE SCHEMATICS FOR BOARDS A, B & C FOR THE LOCATIONS OF THE TEST POINTS.

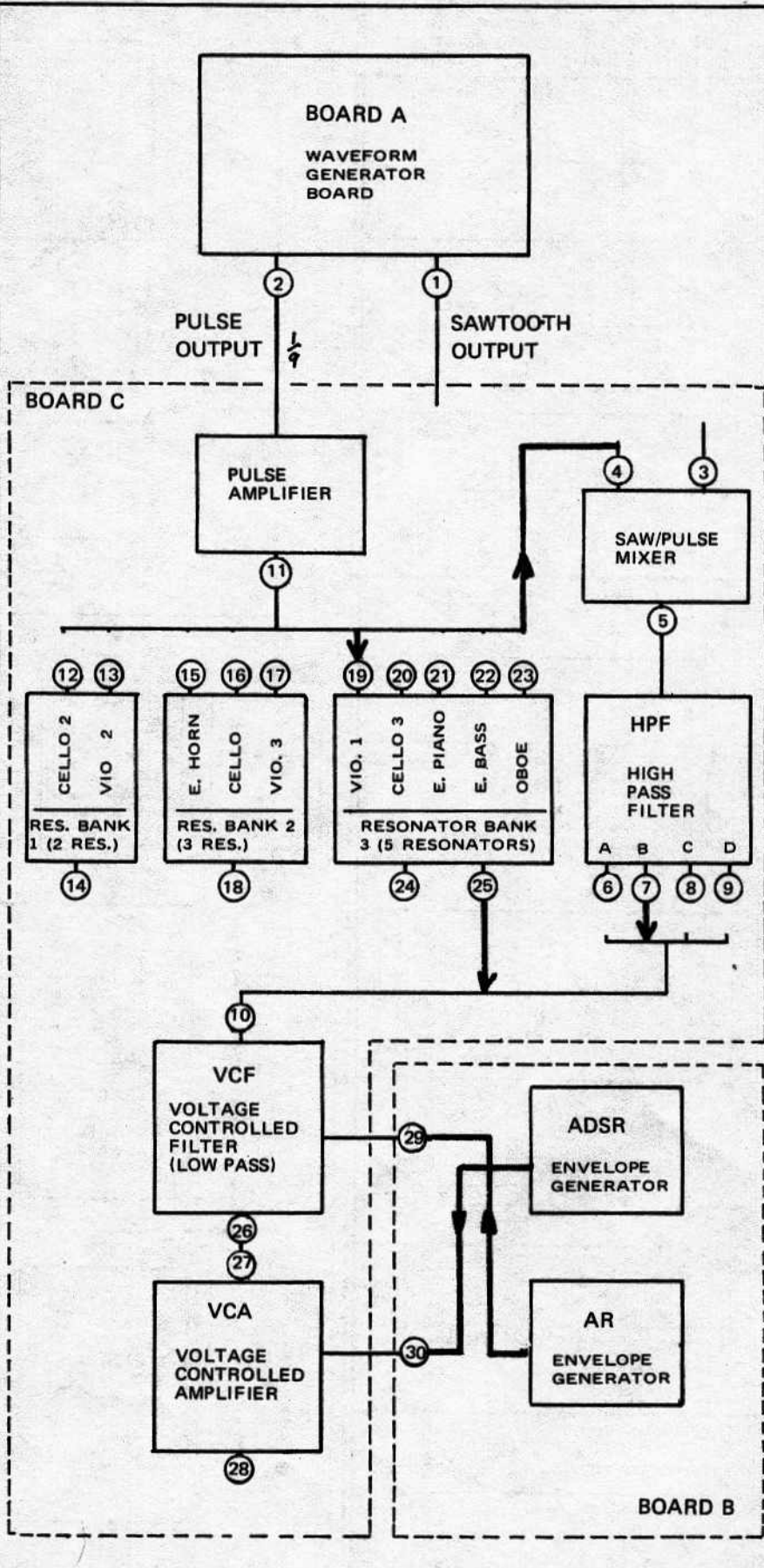
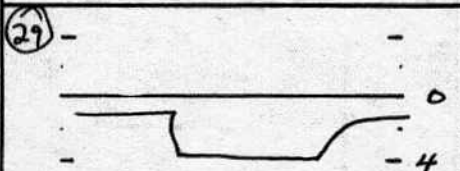
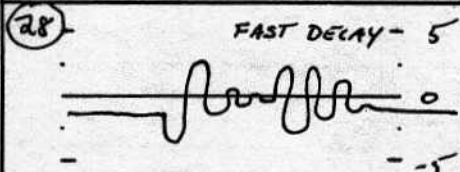
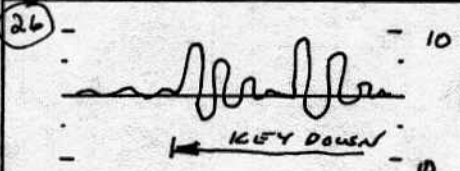
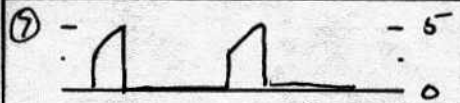
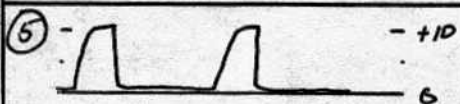
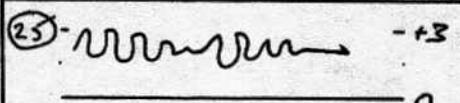
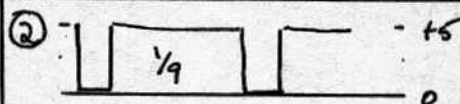

VOICE CODE	A	B	C	D	E
	1	1	1	1	1

2701 VOICE FLOW CHART

VOICE: FUZZ GUIT I

2701 BOARD TEST POINTS: REFER TO THE SCHEMATICS FOR BOARDS A, B & C FOR THE LOCATIONS OF THE TEST POINTS.

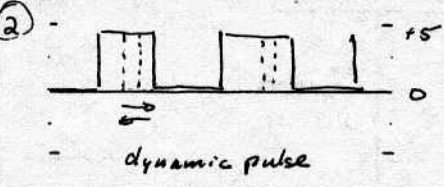
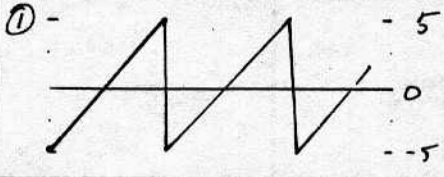

11 SAME AS TP-2

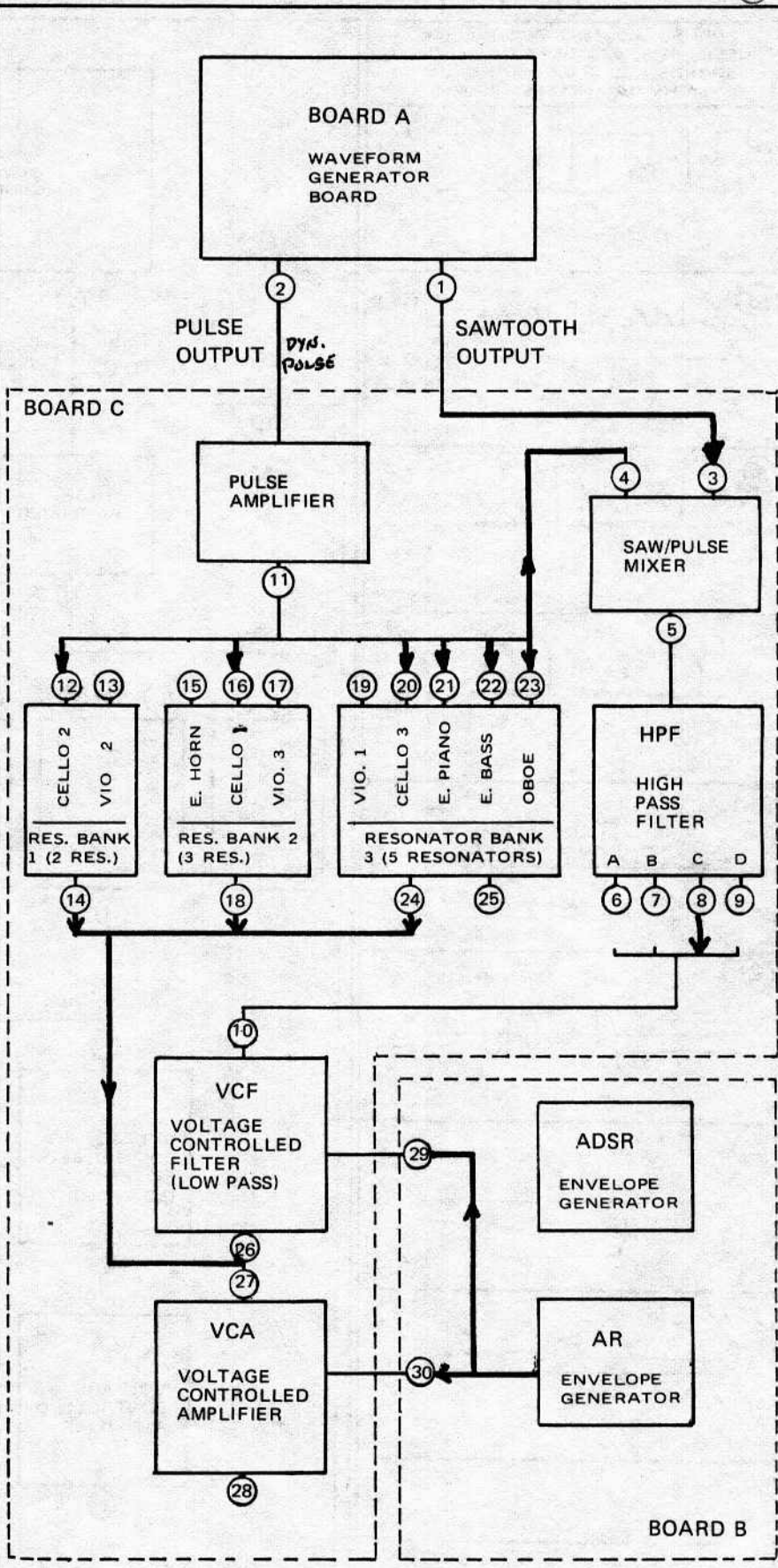
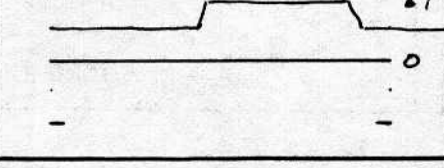
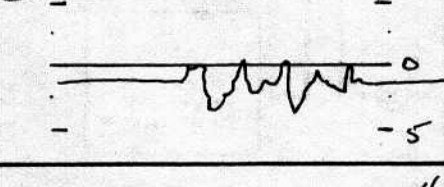
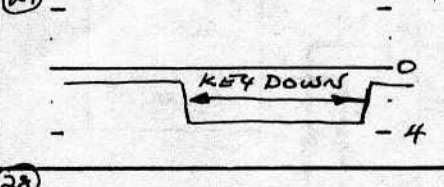
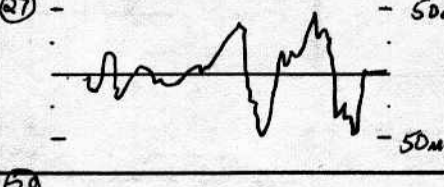
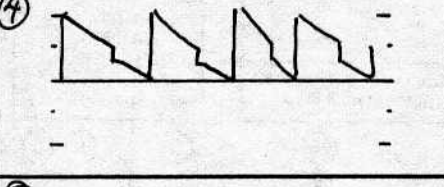
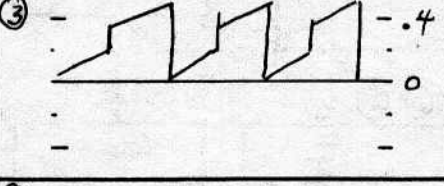

VOICE CODE

A	B	C	D	E
0	1	1	1	1

2701 VOICE FLOW CHART

VOICE: FUZZ GUIT. II

16

2701 BOARD TEST POINTS: REFER TO THE SCHEMATICS FOR BOARDS A, B & C FOR THE LOCATIONS OF THE TEST POINTS.

② -
SAME AS FUZZ 1

⑪ -
SAME AS FUZZ 1

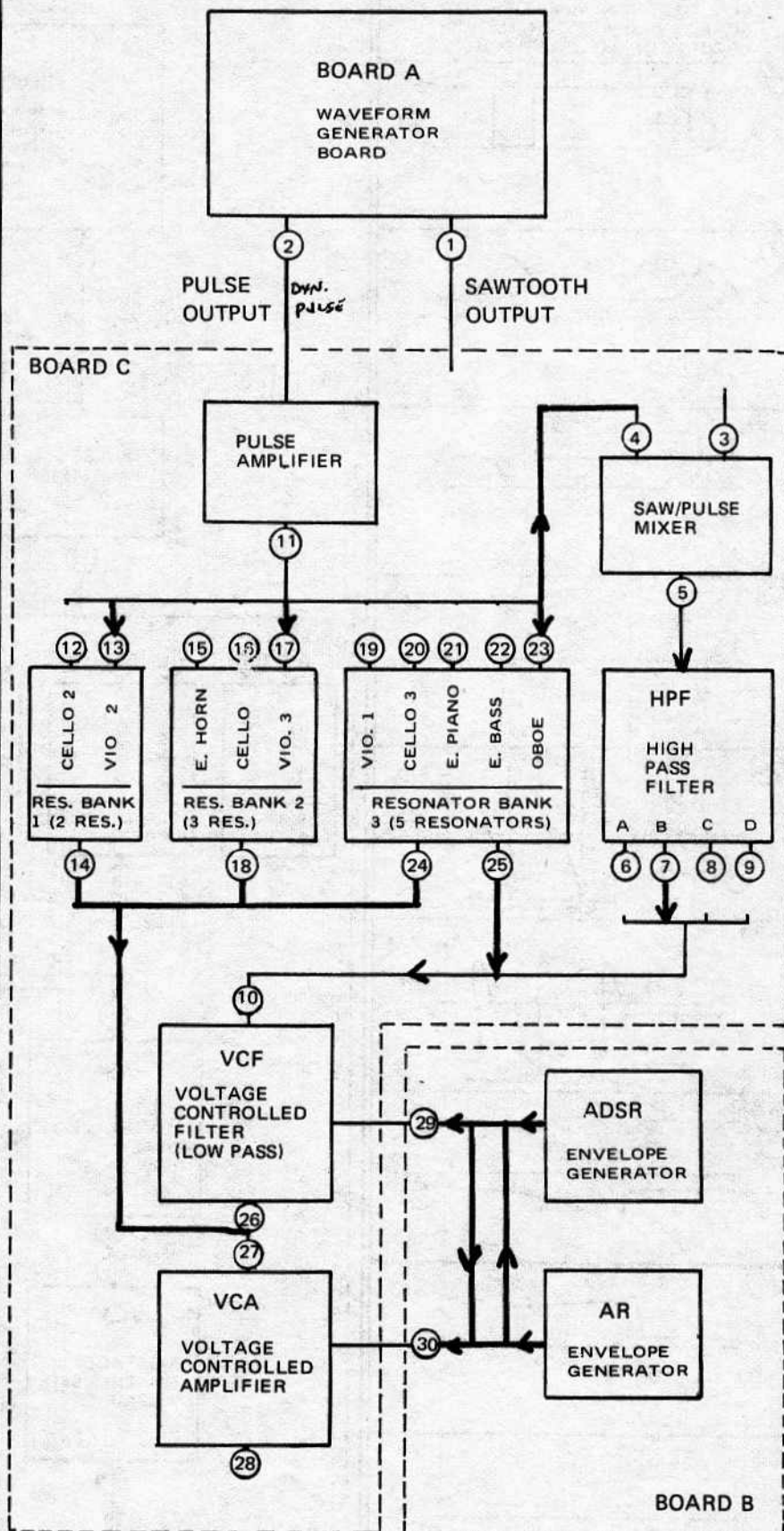
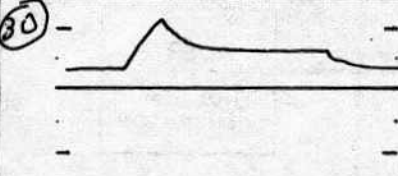
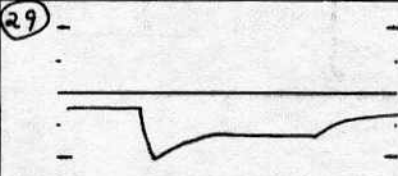
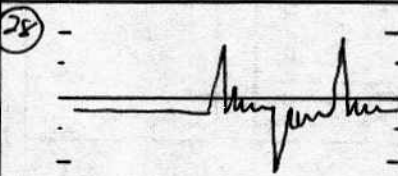
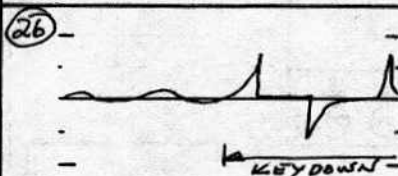
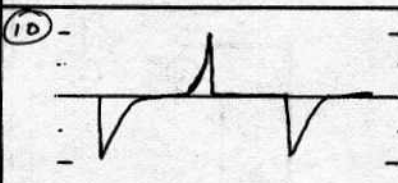

A	B	C	D	E
0	1	1	1	0

2701 BOARD TEST POINTS: REFER TO THE SCHEMATICS FOR BOARDS A, B & C FOR THE LOCATIONS OF THE TEST POINTS.

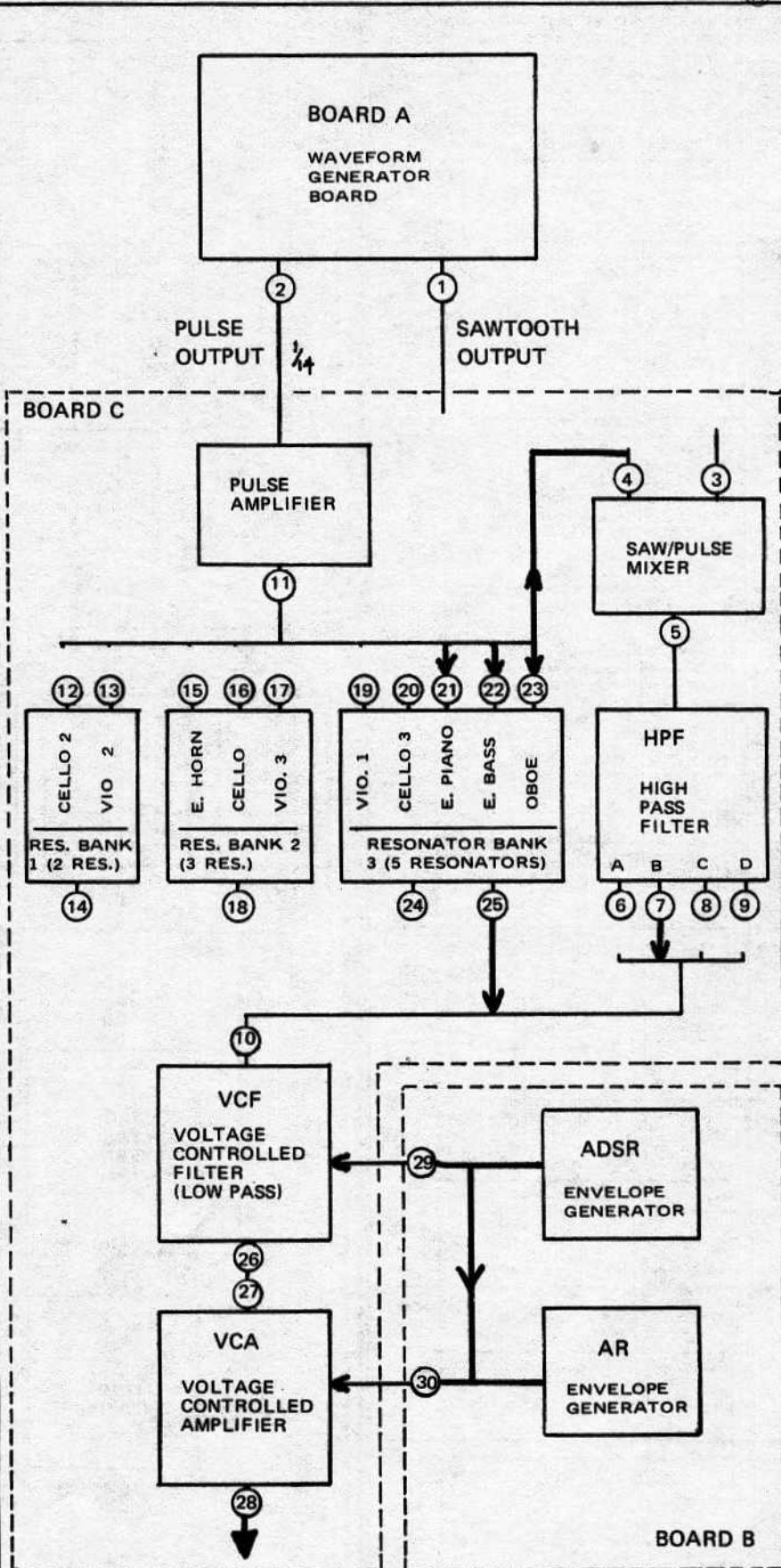
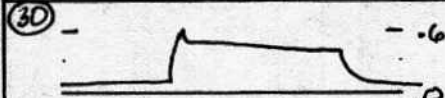
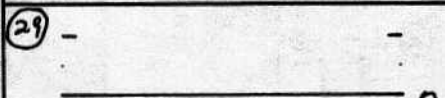
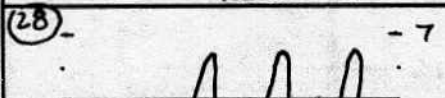
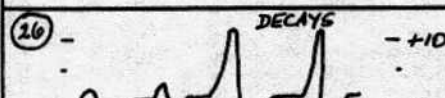
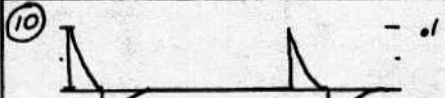
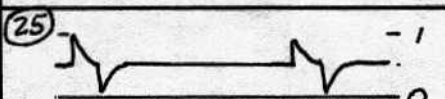
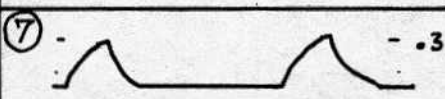
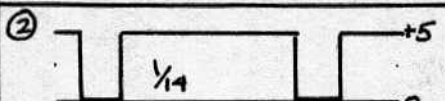

VOICE CODE

A	B	C	D	E
0	1	1	0	1

2701 VOICE FLOW CHART

VOICE: STEEL DRUM

2701 BOARD TEST POINTS: REFER TO THE SCHEMATICS FOR BOARDS A, B & C FOR THE LOCATIONS OF THE TEST POINTS.

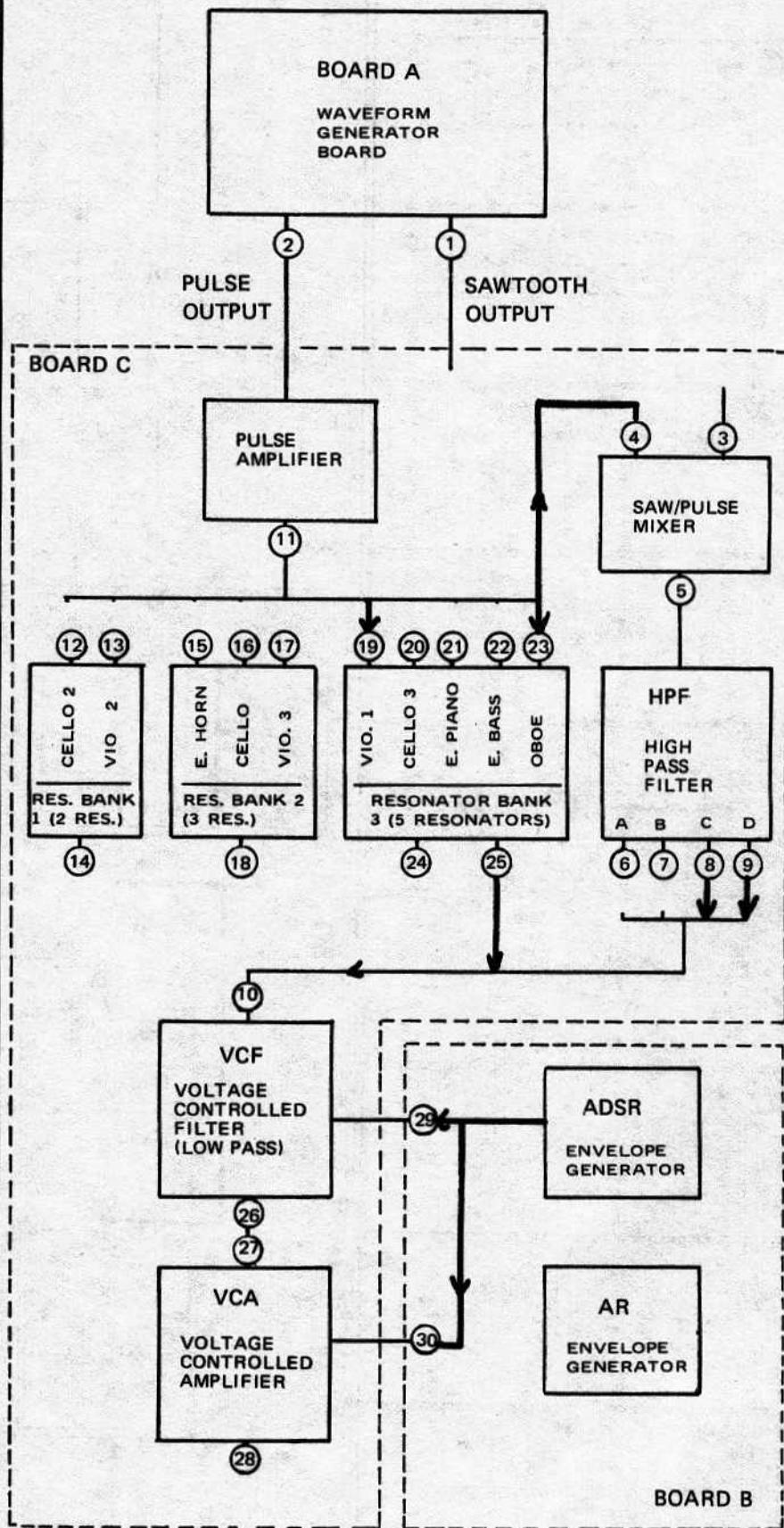
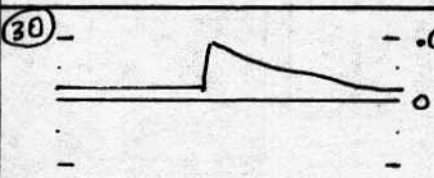
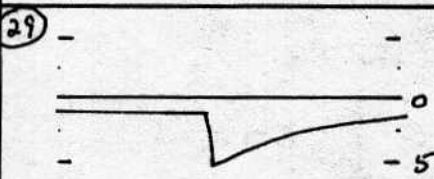
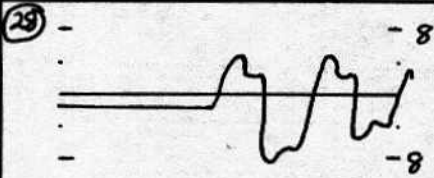
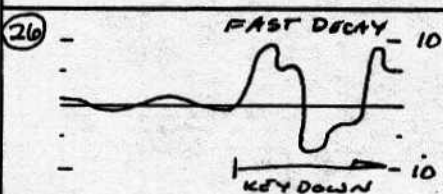
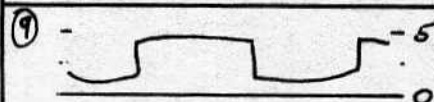
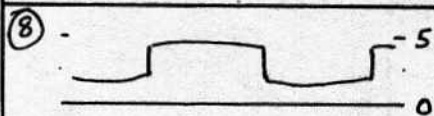
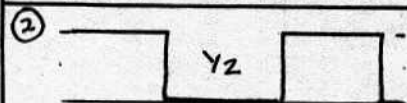

VOICE CODE	A	B	C	D	E
	0	1	1	0	0

2701 VOICE FLOW CHART

VOICE:SPACE BASS

2701 BOARD TEST POINTS: REFER TO THE SCHEMATICS FOR BOARDS A, B & C FOR THE LOCATIONS OF THE TEST POINTS.

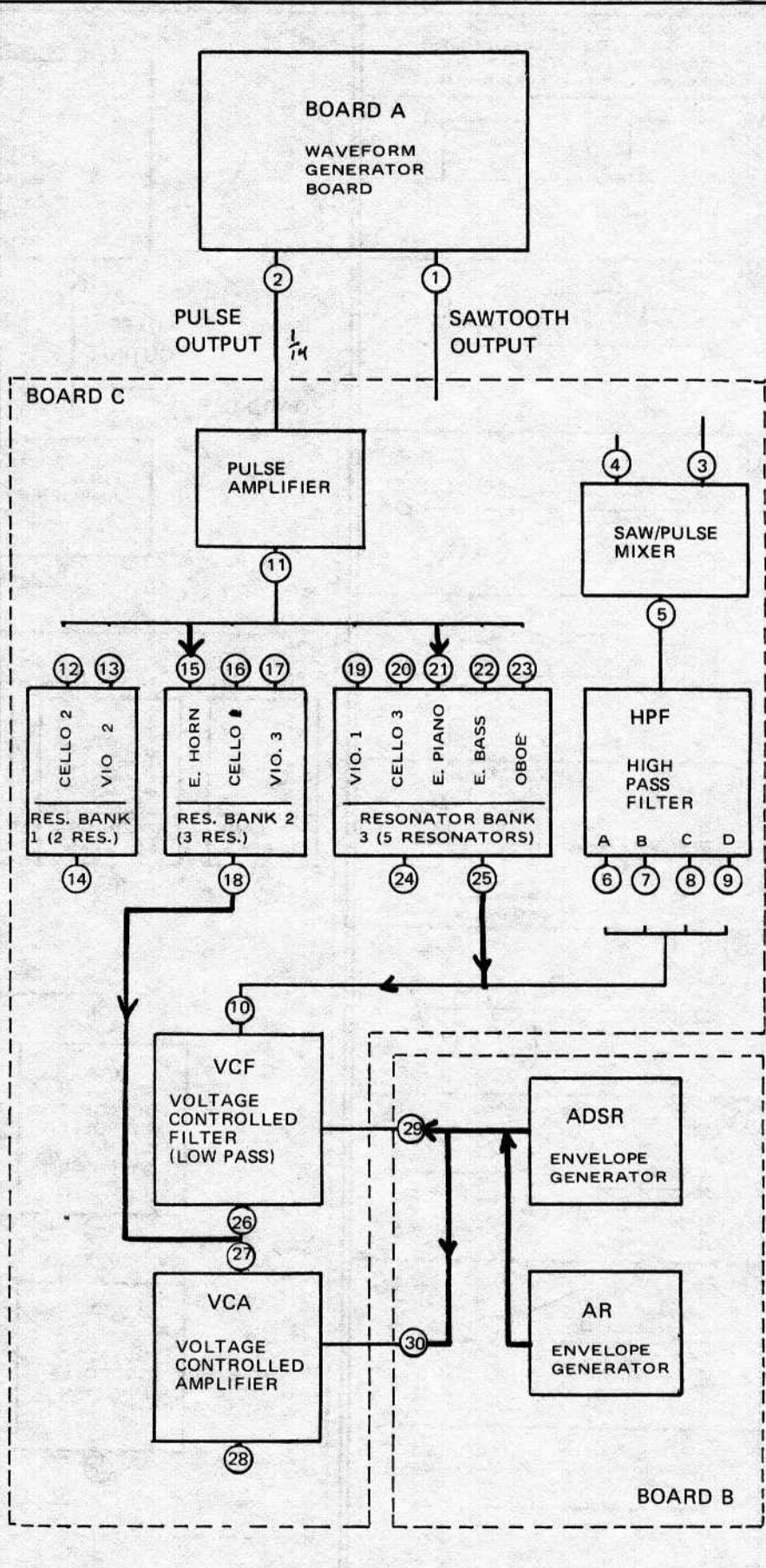
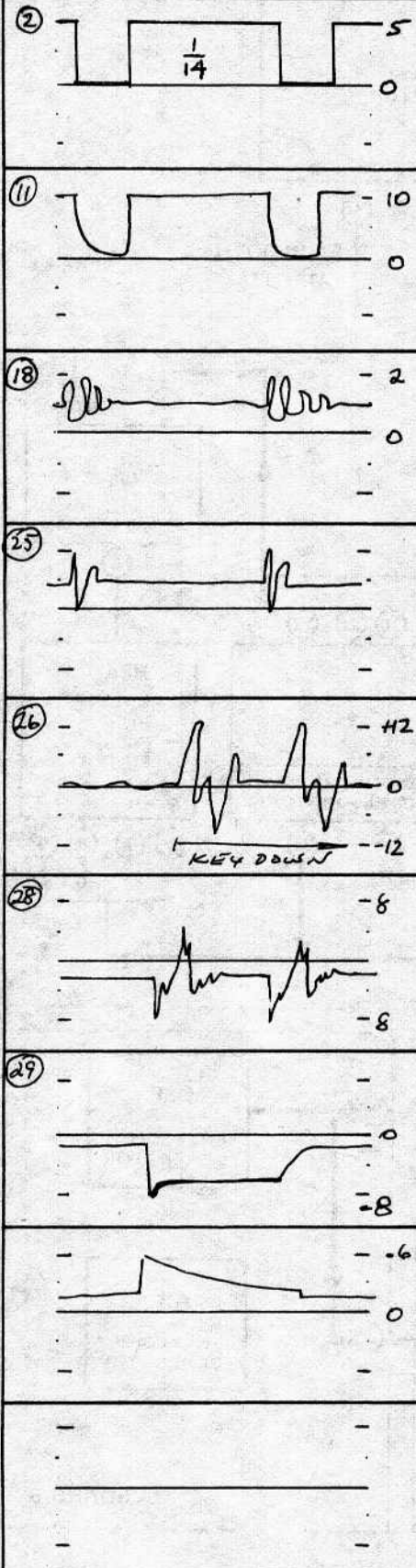

VOICE CODE	A	B	C	D	E
	0	1	0	1	1

2701 VOICE FLOW CHART

VOICE: HARPSICHORD 28

2701 BOARD TEST POINTS: REFER TO THE SCHEMATICS FOR BOARDS A, B & C FOR THE LOCATIONS OF THE TEST POINTS.

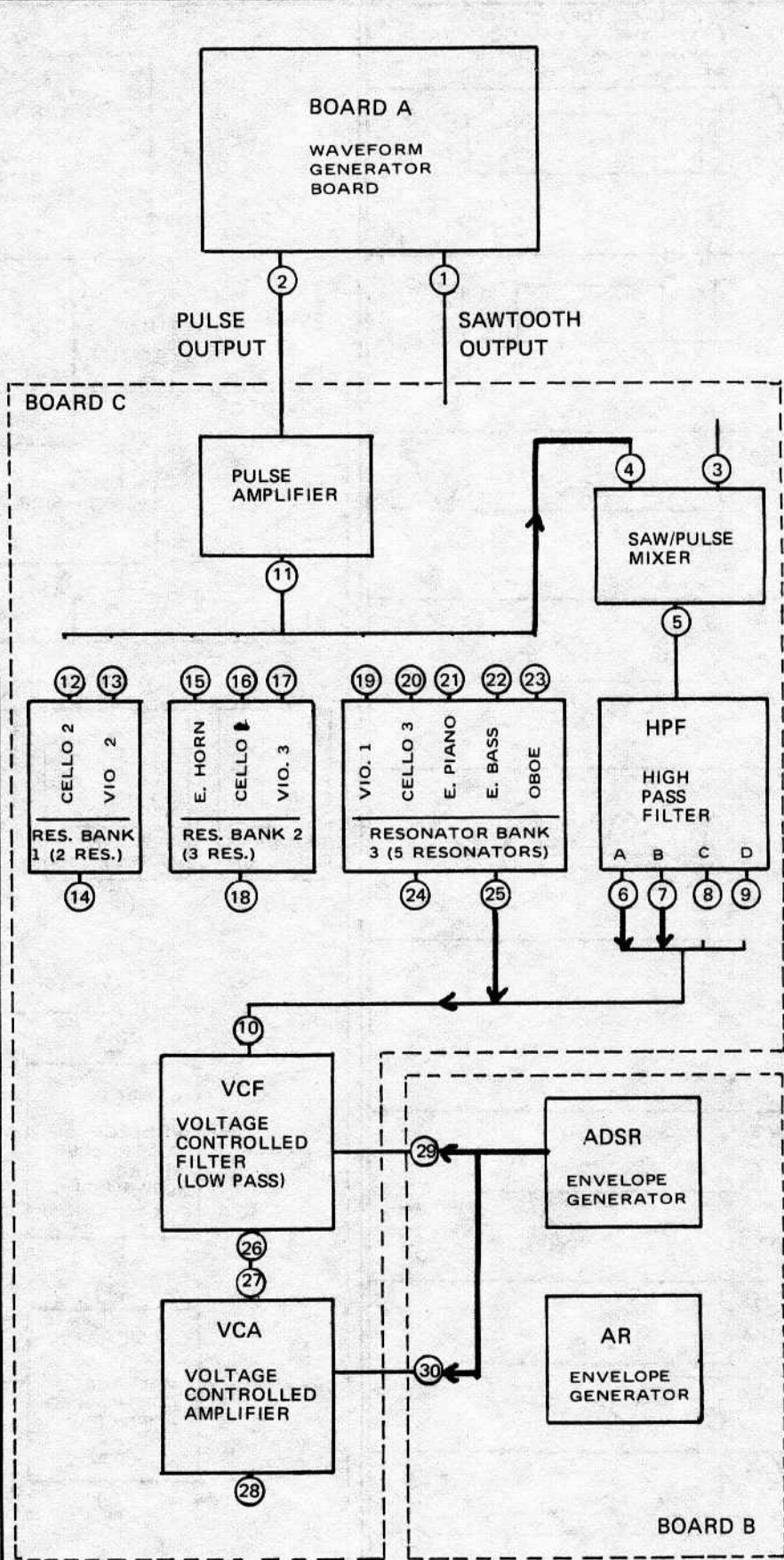
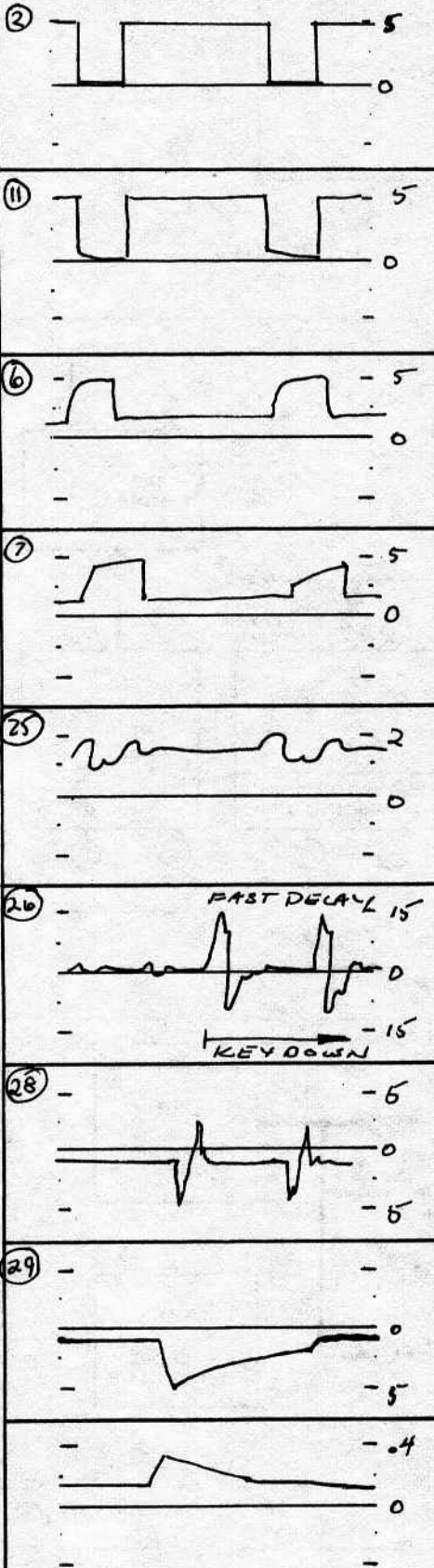

VOICE CODE

A	B	C	D	E
0	1	0	1	0

2701 VOICE FLOW CHART

VOICE: Steel Guitar ²

2701 BOARD TEST POINTS: REFER TO THE SCHEMATICS FOR BOARDS A, B & C FOR THE LOCATIONS OF THE TEST POINTS.

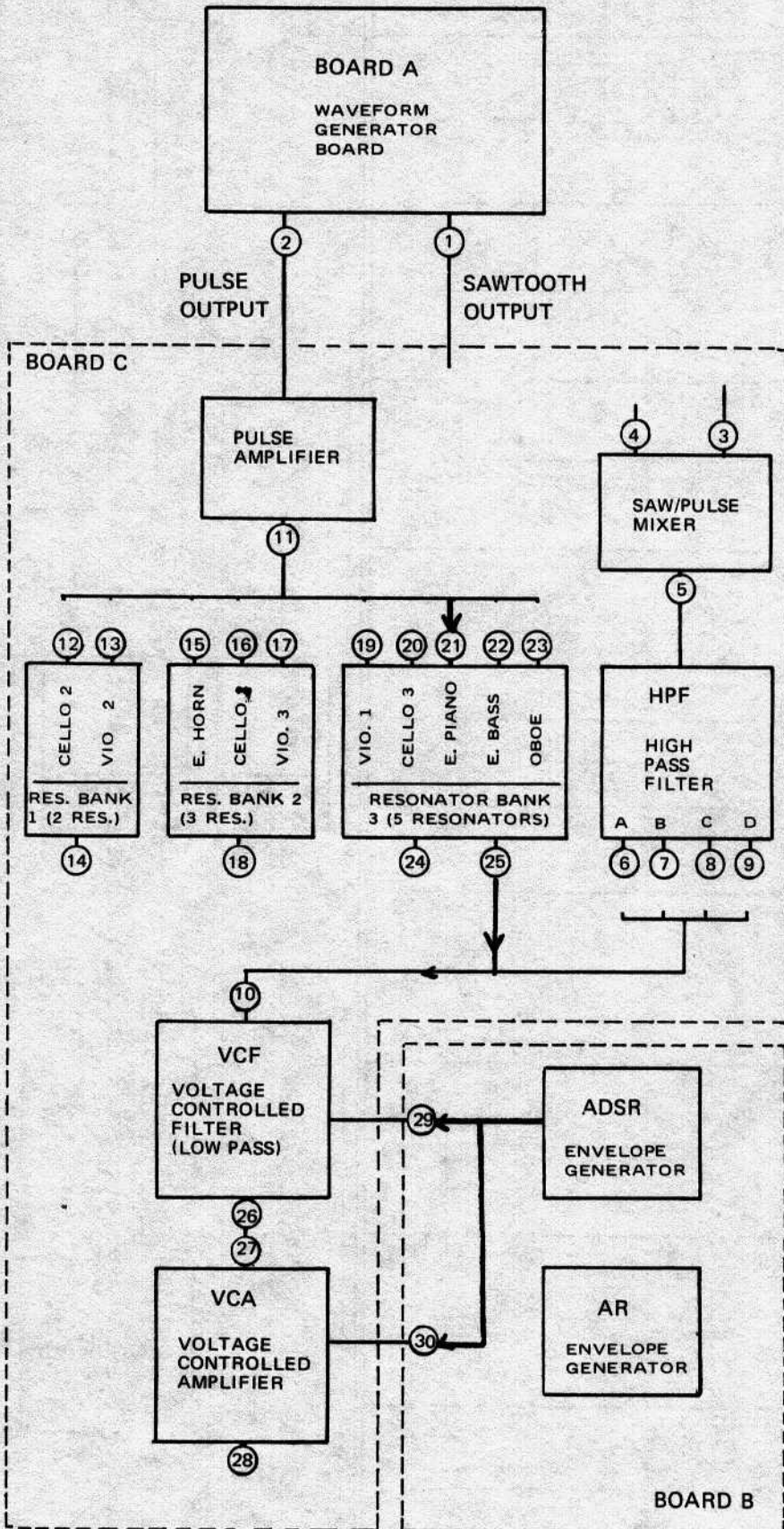
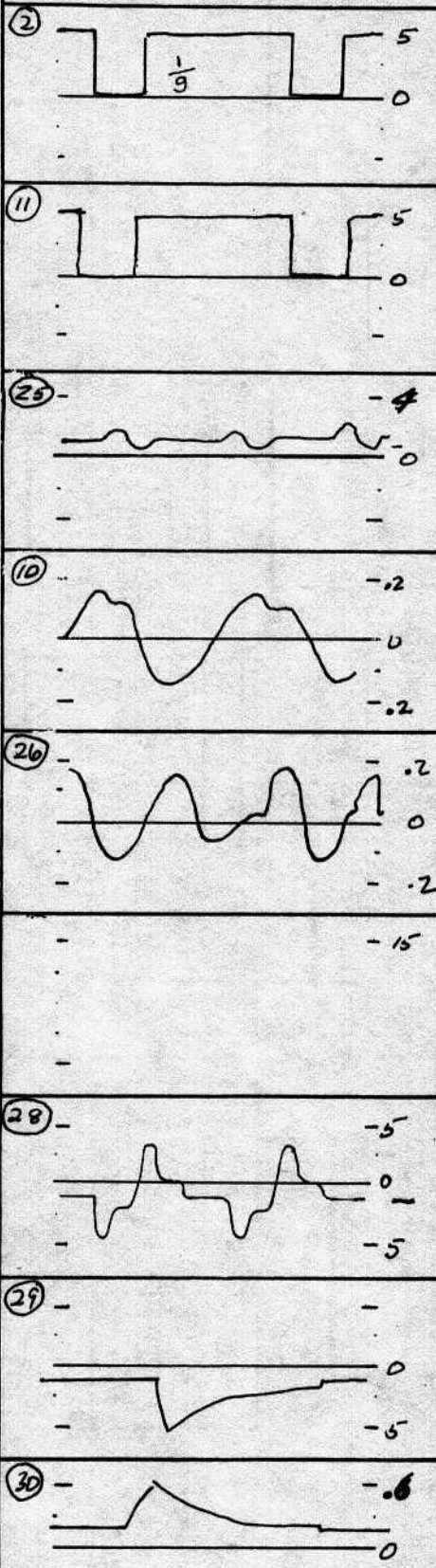

VOICE CODE	A	B	C	D	E
	0	1	0	0	1

2701 VOICE FLOW CHART

VOICE: Mute Trumpet 23

2701 BOARD TEST POINTS: REFER TO THE SCHEMATICS FOR BOARDS A, B & C FOR THE LOCATIONS OF THE TEST POINTS.

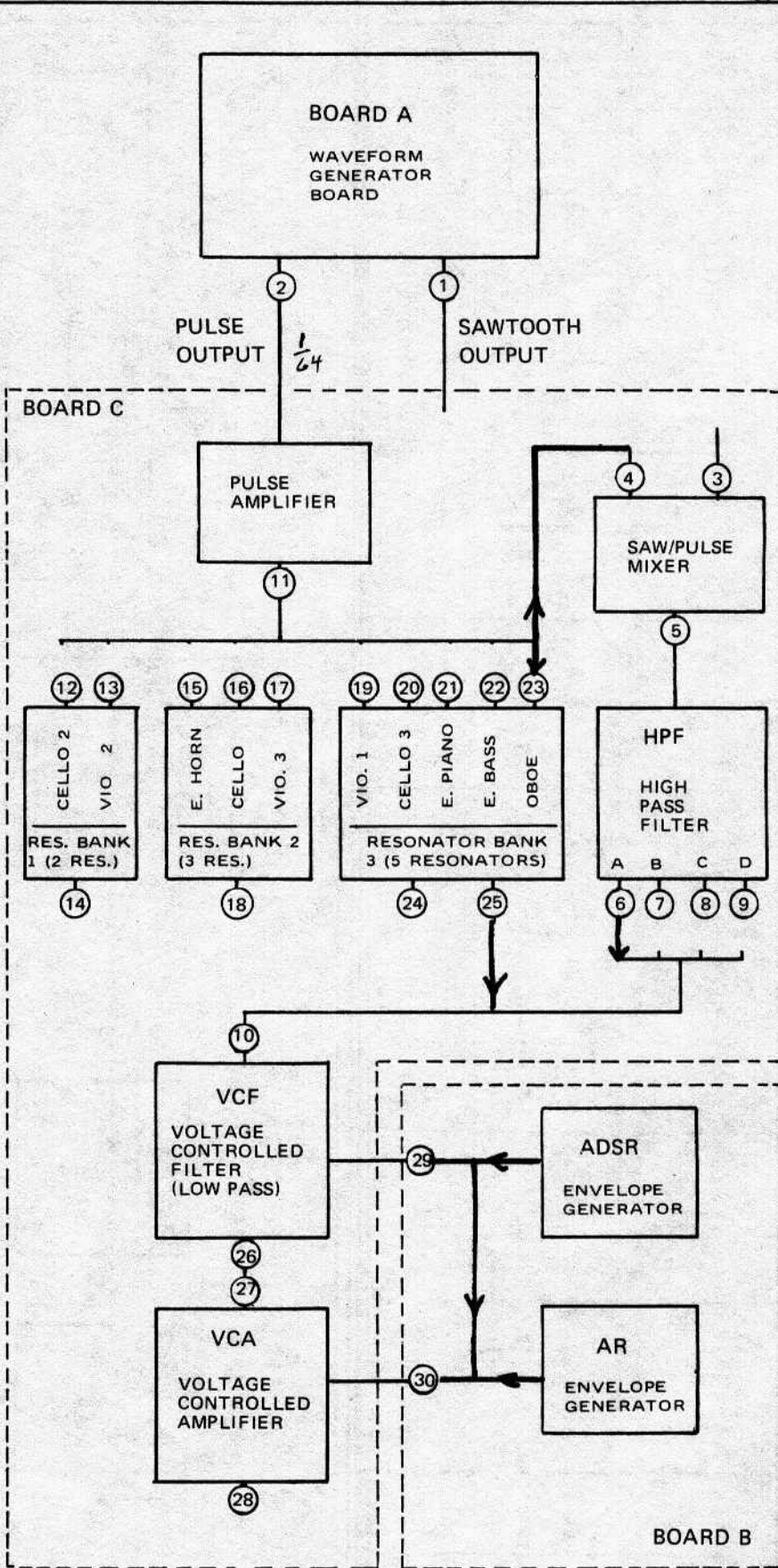
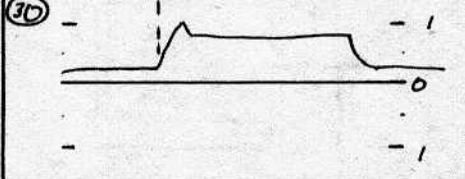
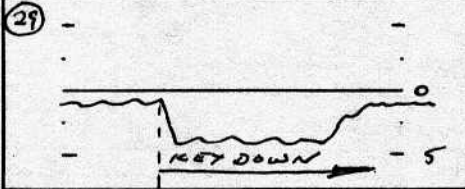
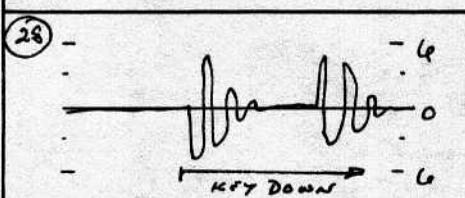
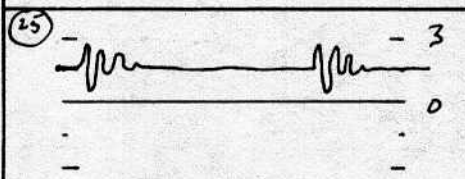
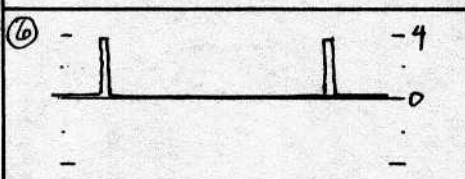
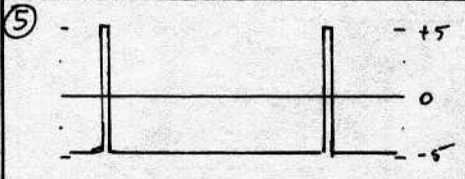
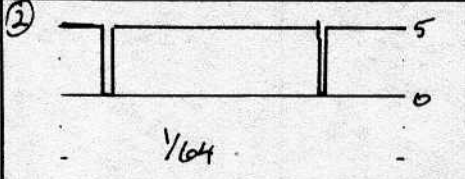

VOICE CODE	A	B	C	D	E
	0	1	0	0	0

2701 VOICE FLOW CHART

VOICE: COMIC WOW

2701 BOARD TEST POINTS: REFER TO THE SCHEMATICS FOR BOARDS A, B & C FOR THE LOCATIONS OF THE TEST POINTS.

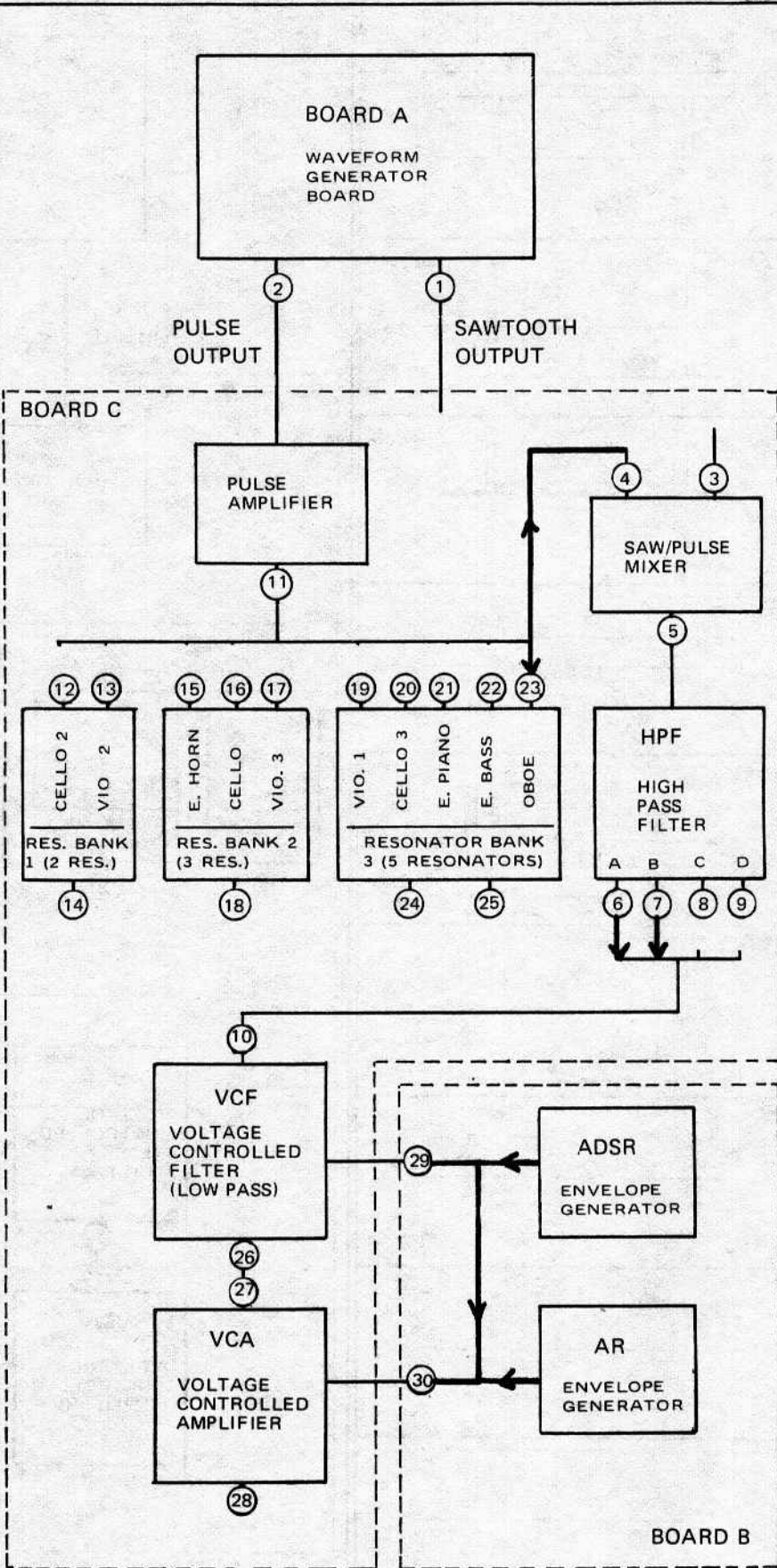
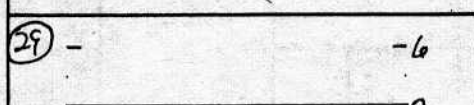
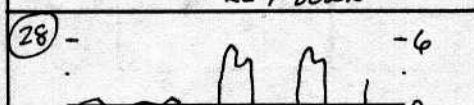
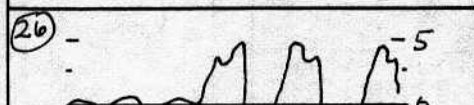
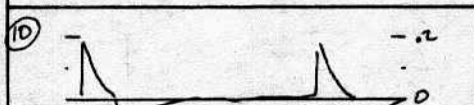
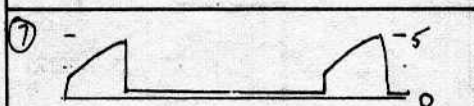
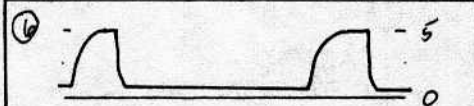
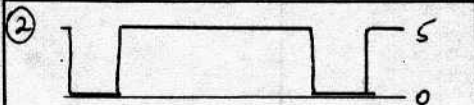

VOICE CODE	A	B	C	D	E
	0	0	1	1	1

2701 VOICE FLOW CHART

VOICE: PULSAR

24

2701 BOARD TEST POINTS: REFER TO THE SCHEMATICS FOR BOARDS A, B & C FOR THE LOCATIONS OF THE TEST POINTS.

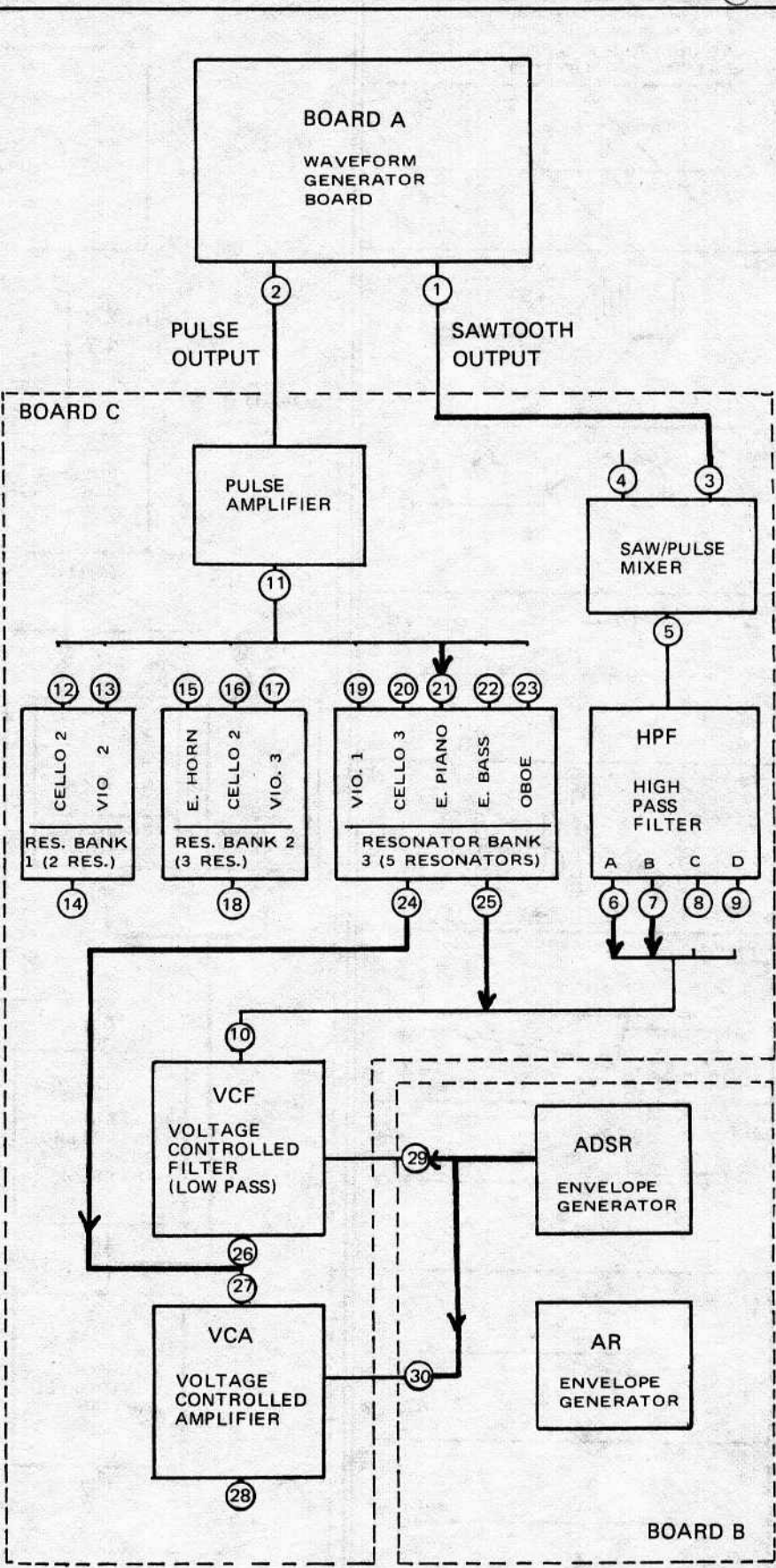
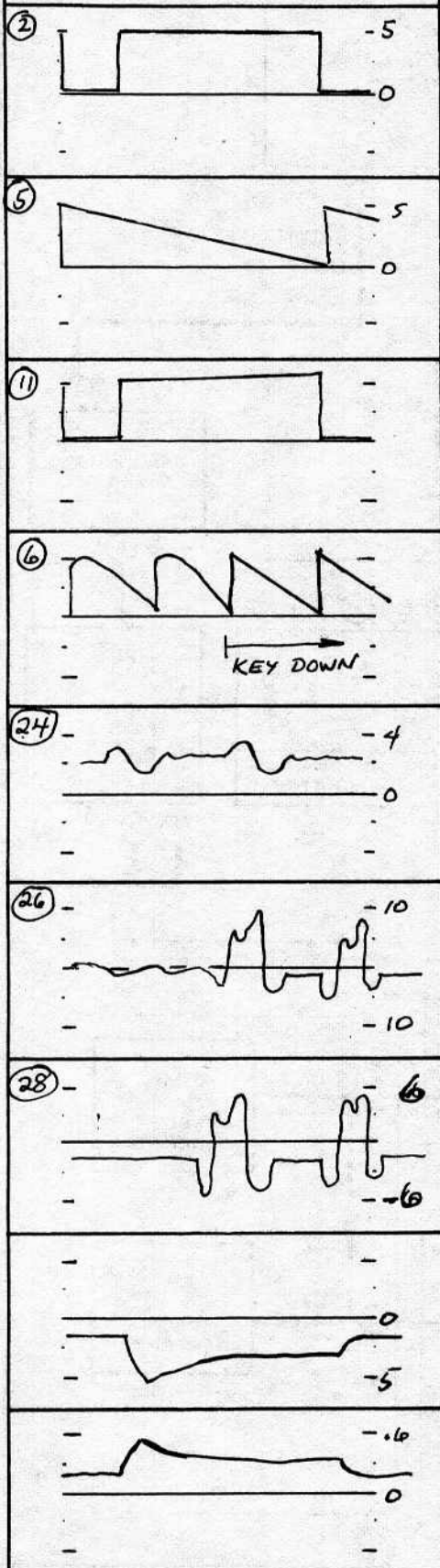

VOICE CODE	A	B	C	D	E
	0	0	1	1	0

2701 VOICE FLOW CHART

VOICE: NOZE

2701 BOARD TEST POINTS: REFER TO THE SCHEMATICS FOR BOARDS A, B & C FOR THE LOCATIONS OF THE TEST POINTS.

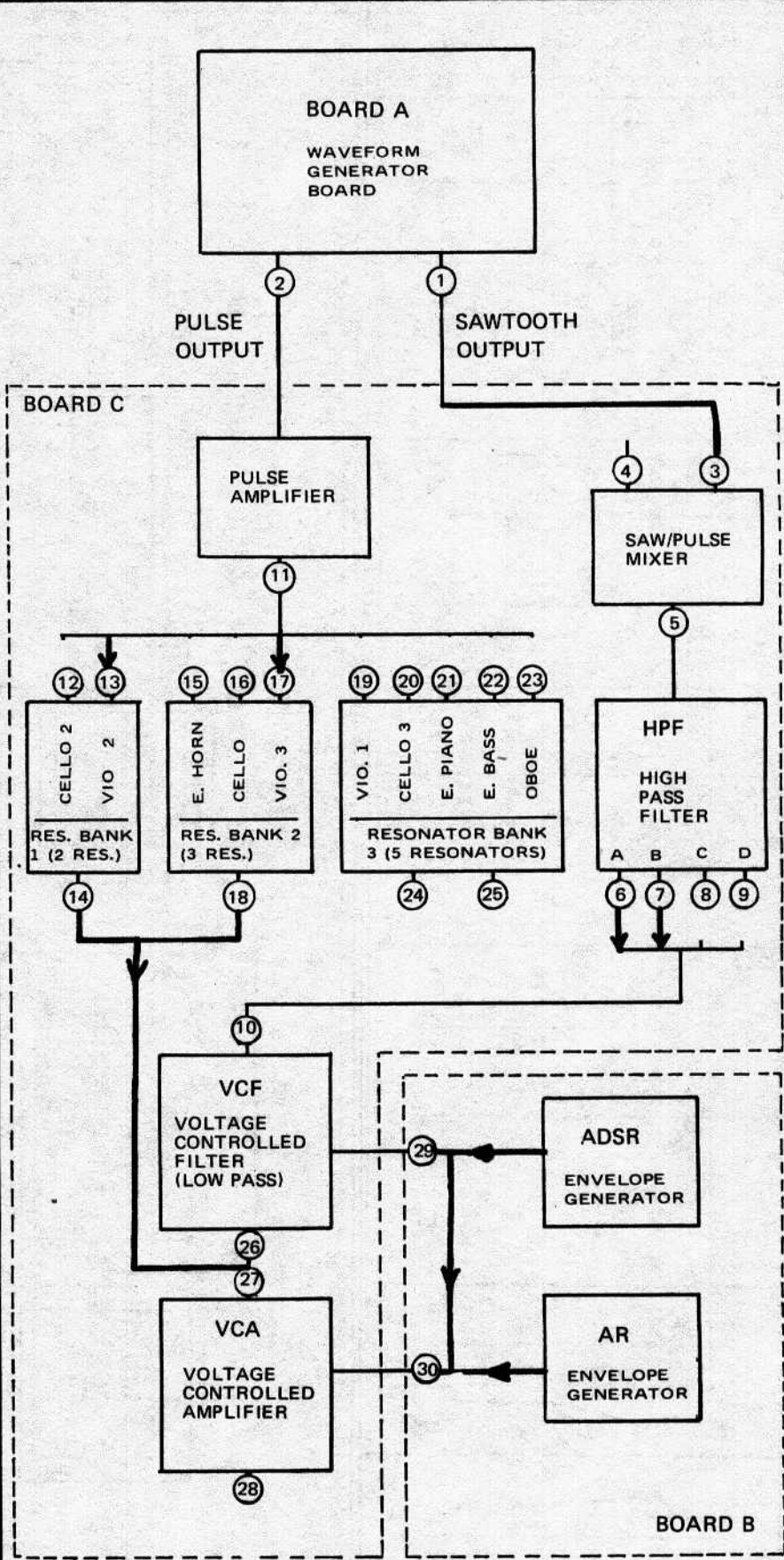
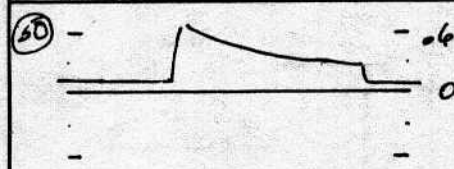
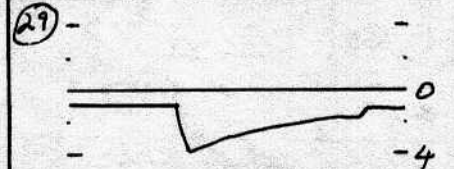
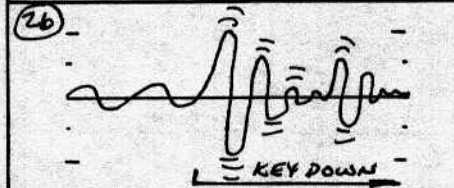
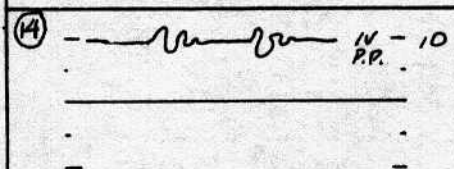
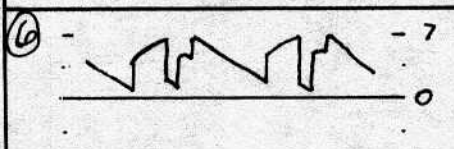
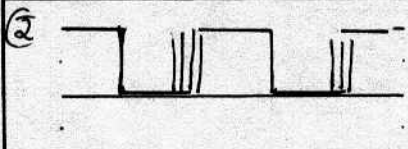
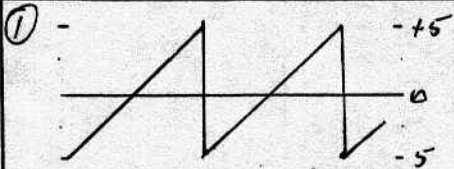

VOICE CODE	A	B	C	D	E
	0	0	1	0	1

2701 VOICE FLOW CHART

VOICE:SONG WHIST. (26)

2701 BOARD TEST POINTS: REFER TO THE SCHEMATICS FOR BOARDS A, B & C FOR THE LOCATIONS OF THE TEST POINTS.

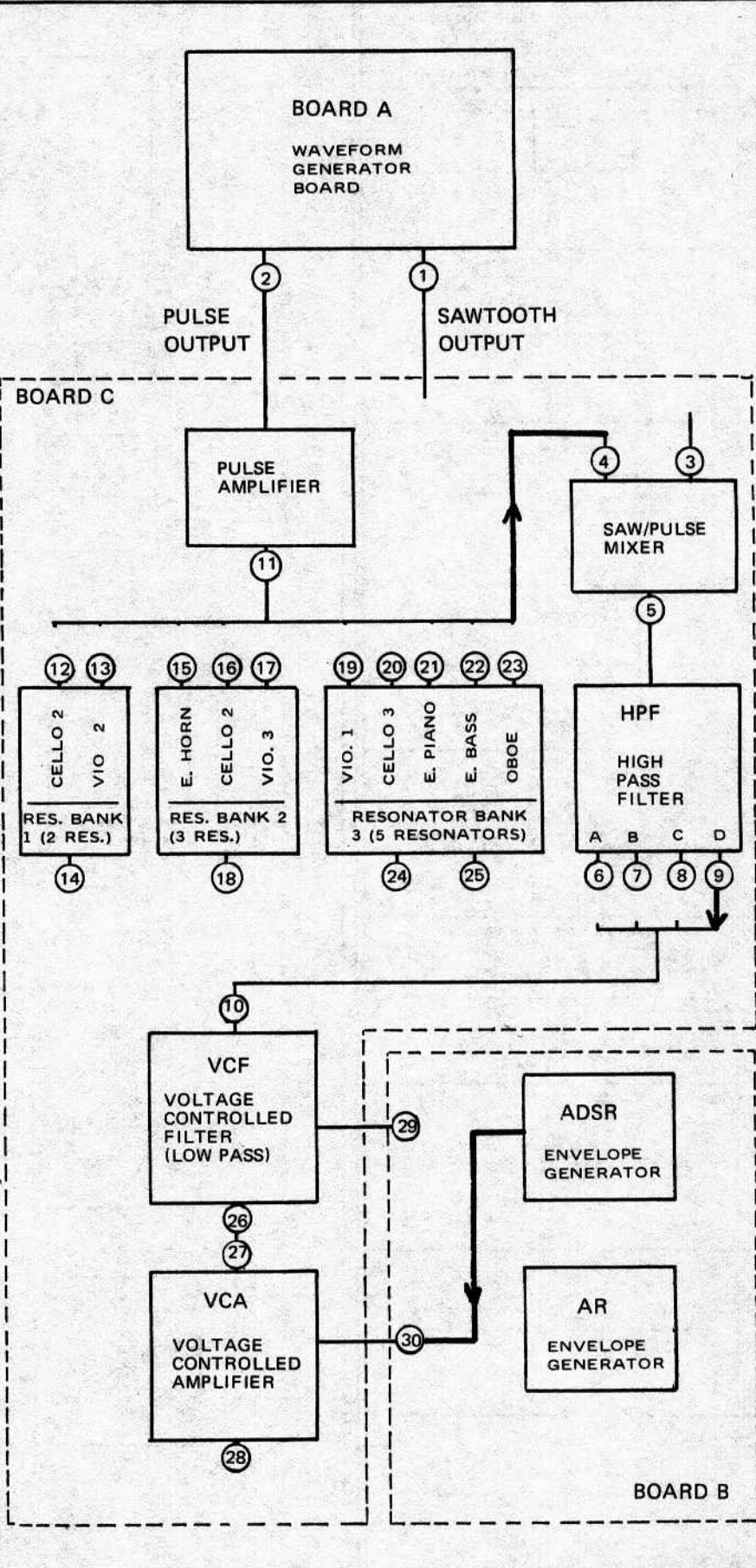
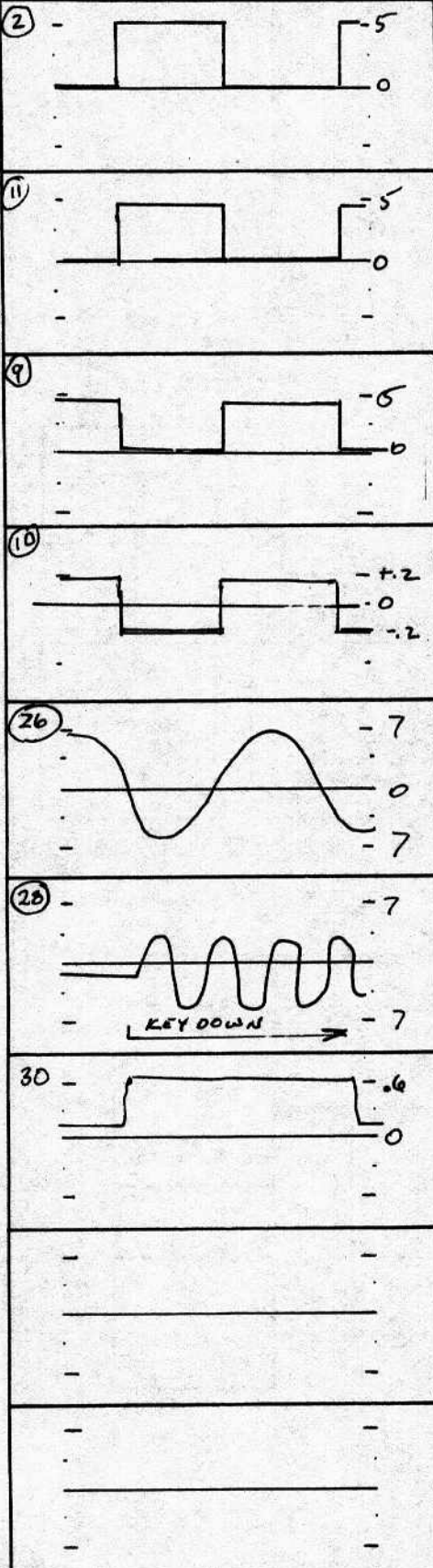

VOICE CODE

A	B	C	D	E
0	0	1	0	0

2701 VOICE FLOW CHART

VOICE: TELSTAR

2701 BOARD TEST POINTS: REFER TO THE SCHEMATICS FOR BOARDS A, B & C FOR THE LOCATIONS OF THE TEST POINTS.

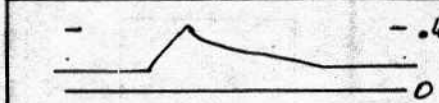
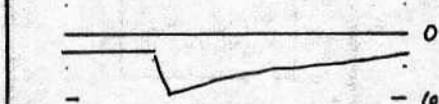
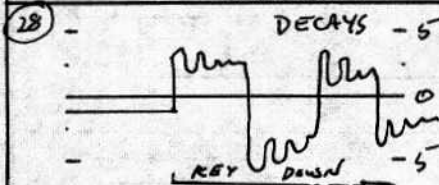
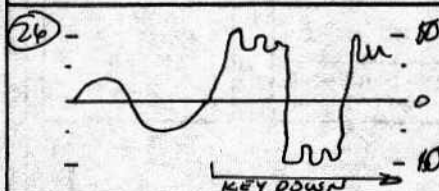
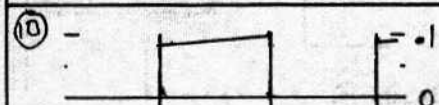
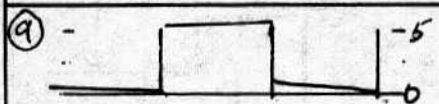
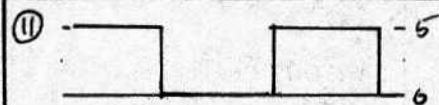

BOARD A

WAVEFORM
GENERATOR
BOARD

PULSE
OUTPUT

SAWTOOTH
OUTPUT

BOARD C

PULSE
AMPLIFIER

SAW/PULSE
MIXER

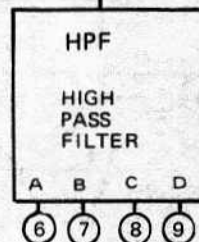
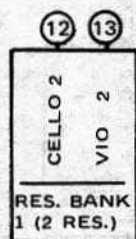

⑩



ADSR

ENVELOPE
GENERATOR

⑳

㉑

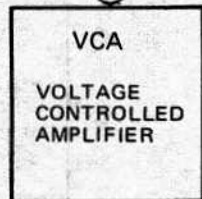

AR

ENVELOPE
GENERATOR

㉒

BOARD B

VOICE CODE	A	B	C	D	E
	0	0	0	1	1

2701 VOICE FLOW CHART

VOICE: SPACE REED

2701 BOARD TEST POINTS: REFER TO THE SCHEMATICS FOR BOARDS A, B & C FOR THE LOCATIONS OF THE TEST POINTS.

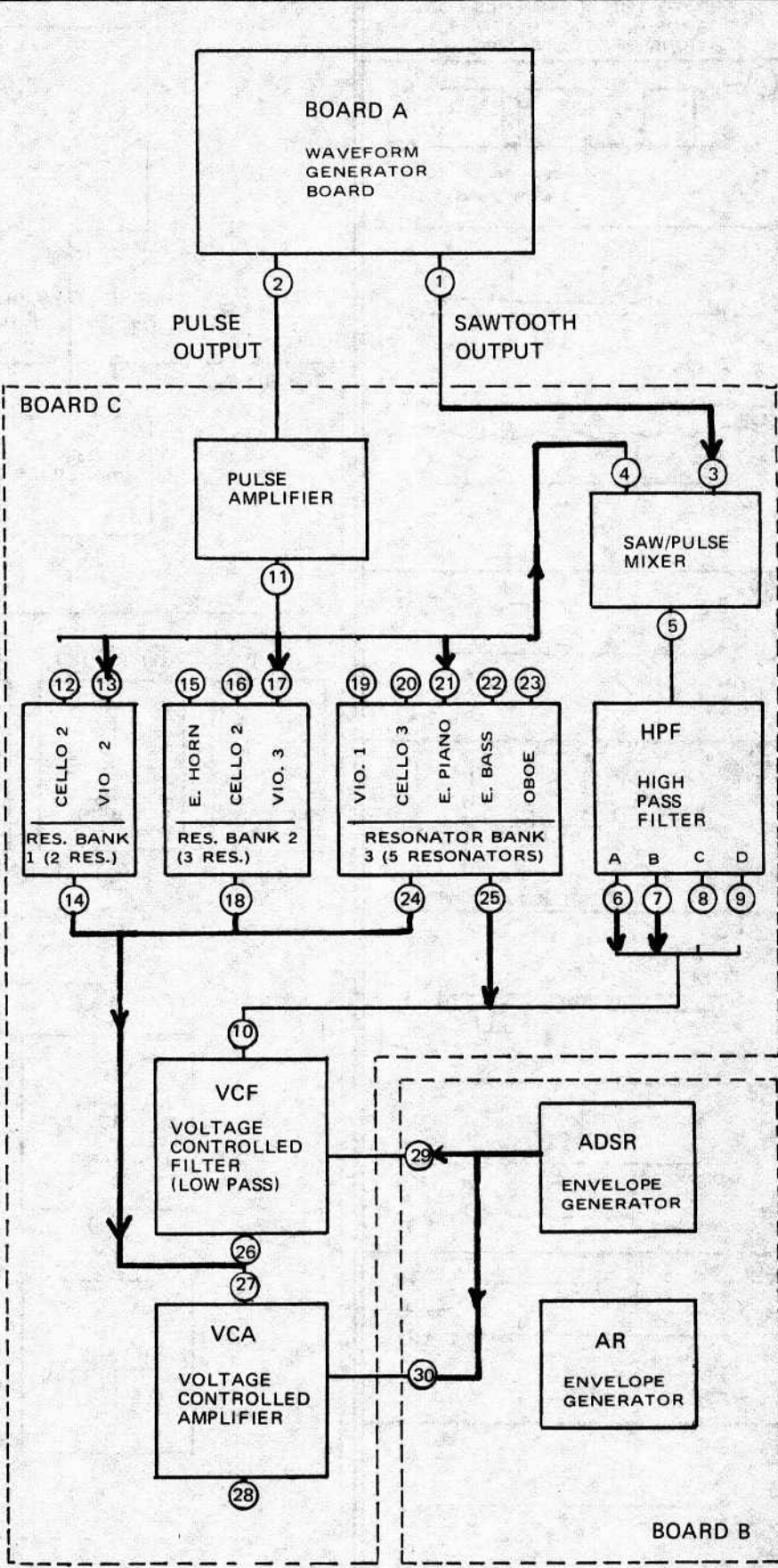
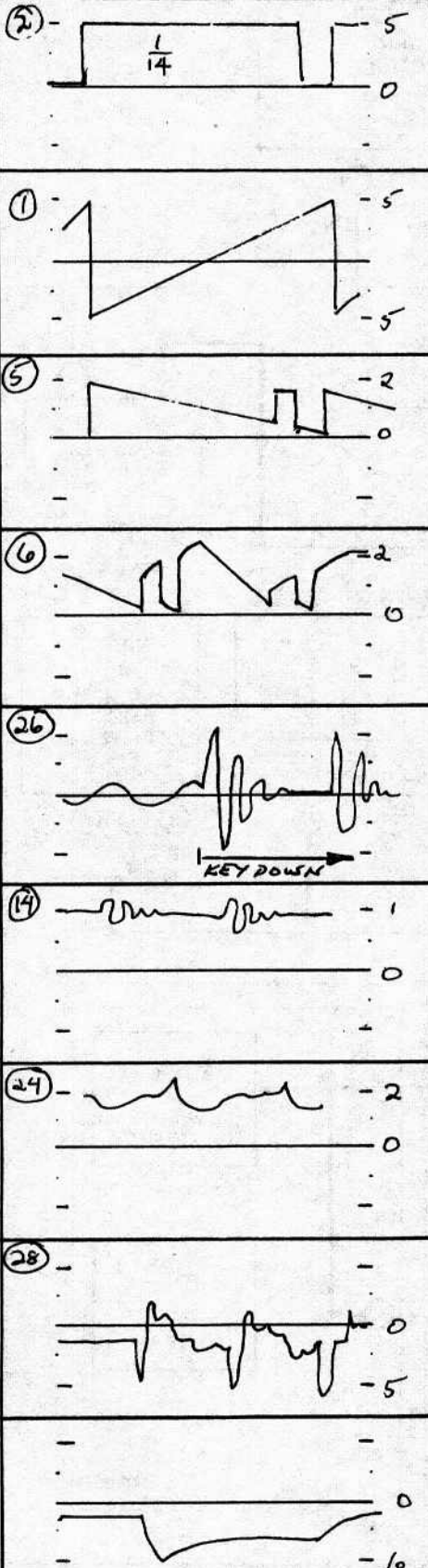

VOICE CODE	A	B	C	D	E
	0	0	0	1	0

2701 VOICE FLOW CHART

VOICE: SAX ²⁸

2701 BOARD TEST POINTS: REFER TO THE SCHEMATICS FOR BOARDS A, B & C FOR THE LOCATIONS OF THE TEST POINTS.

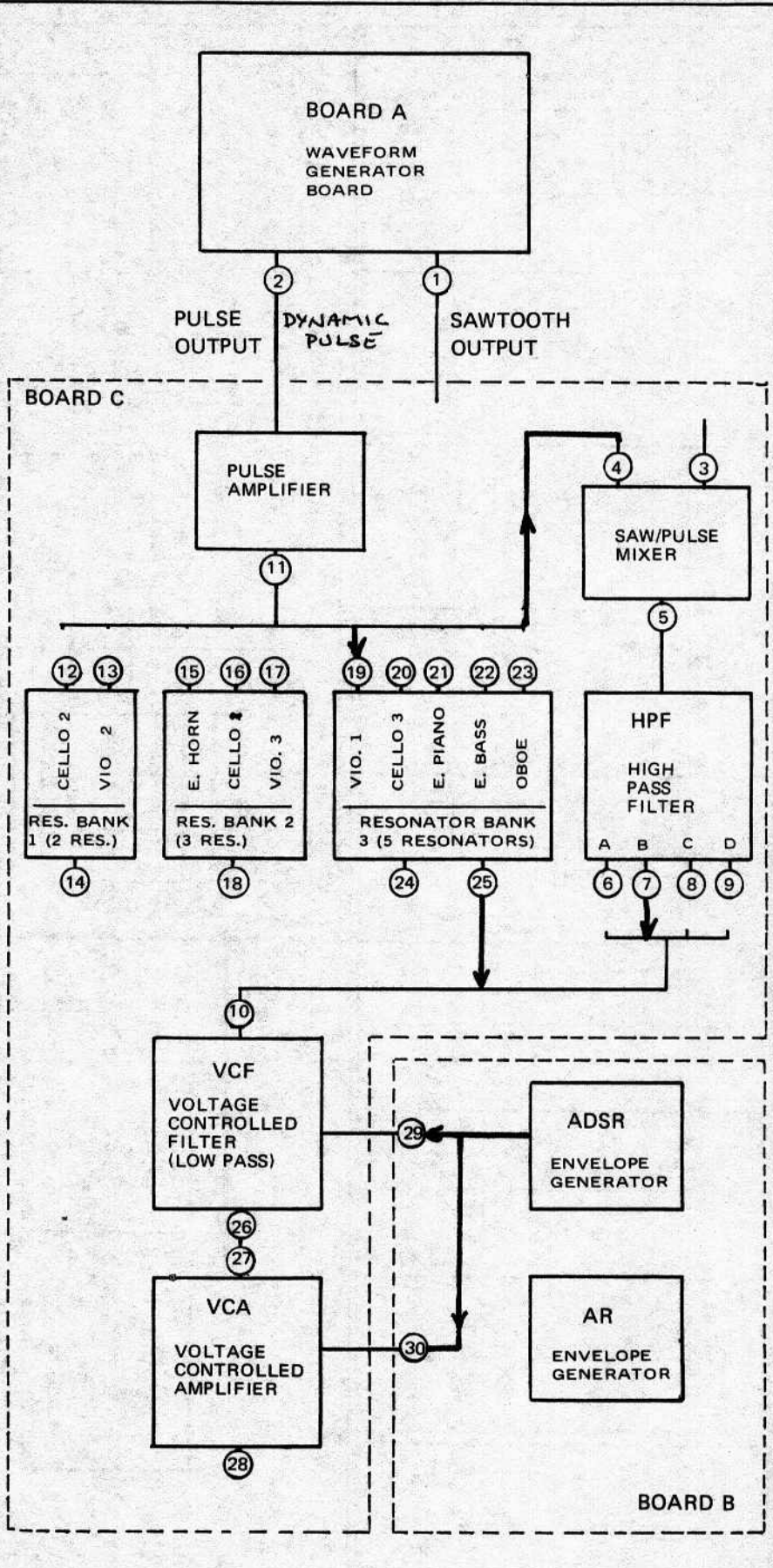
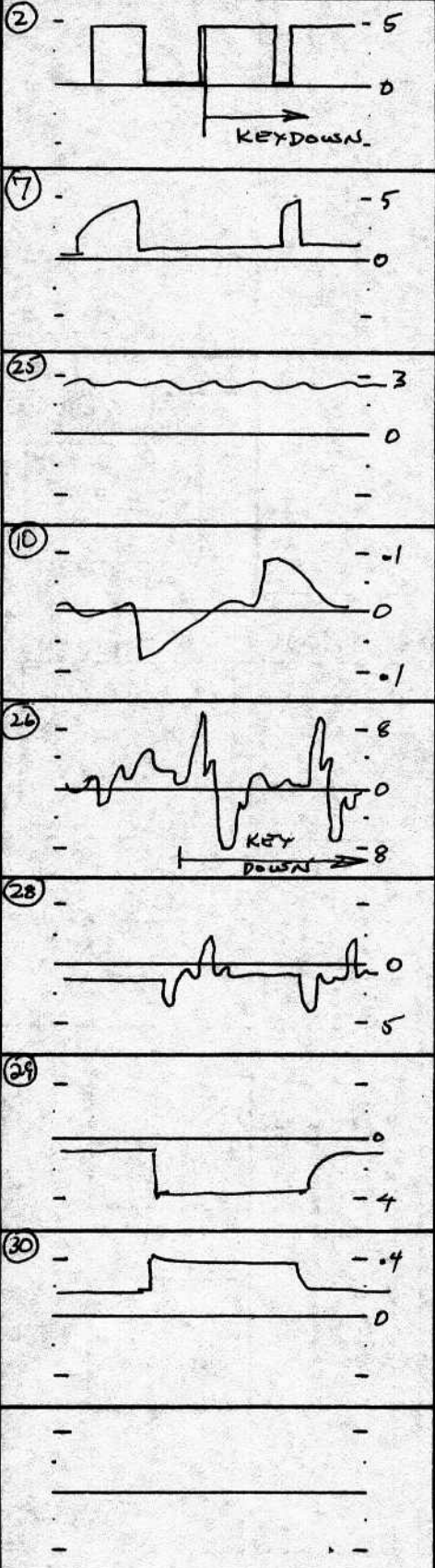

VOICE CODE	A	B	C	D	E
	0	0	0	0	1

2701 VOICE FLOW CHART

VOICE: Buzz Bassoon (30)

2701 BOARD TEST POINTS: REFER TO THE SCHEMATICS FOR BOARDS A, B & C FOR THE LOCATIONS OF THE TEST POINTS.

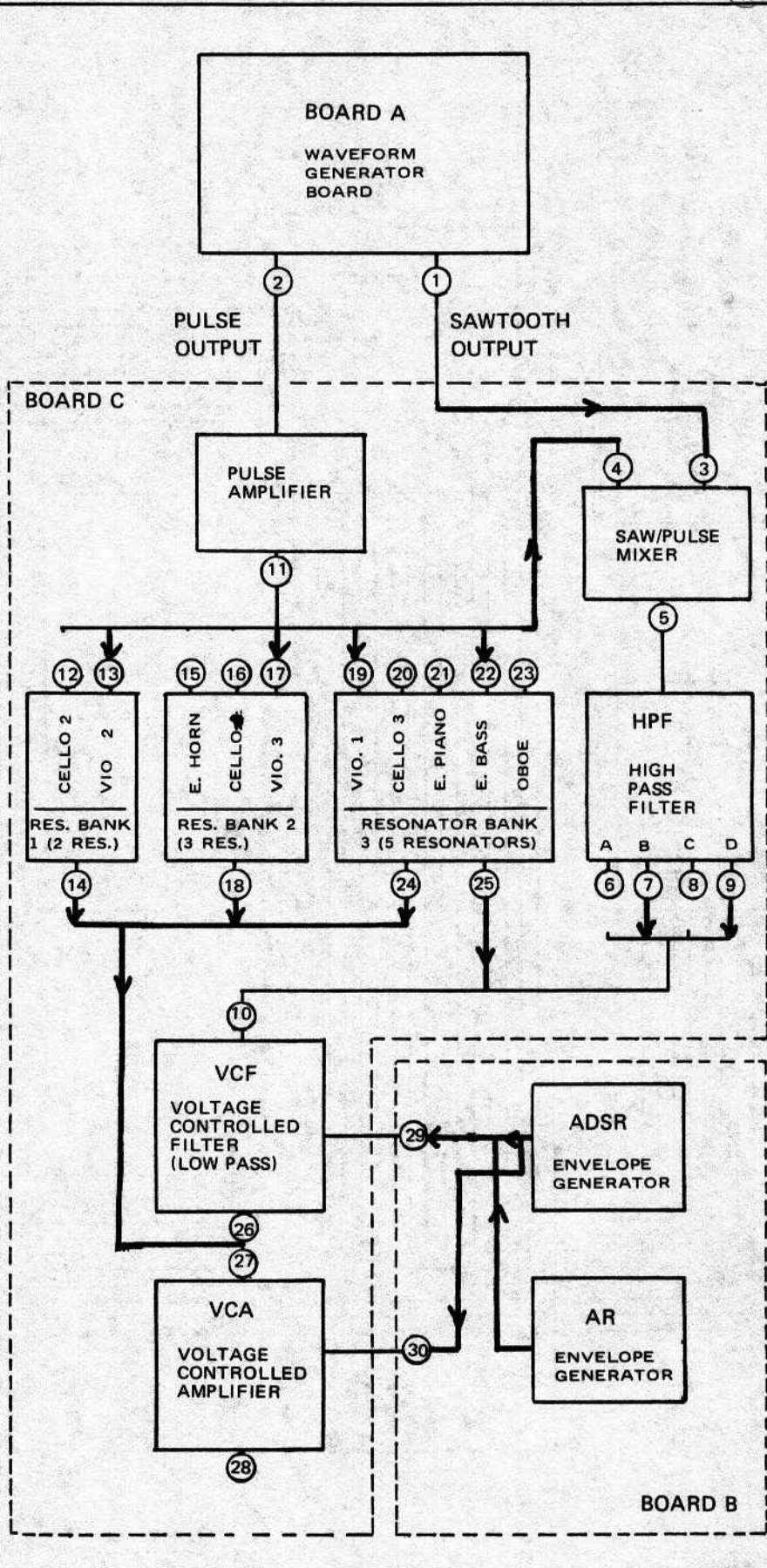
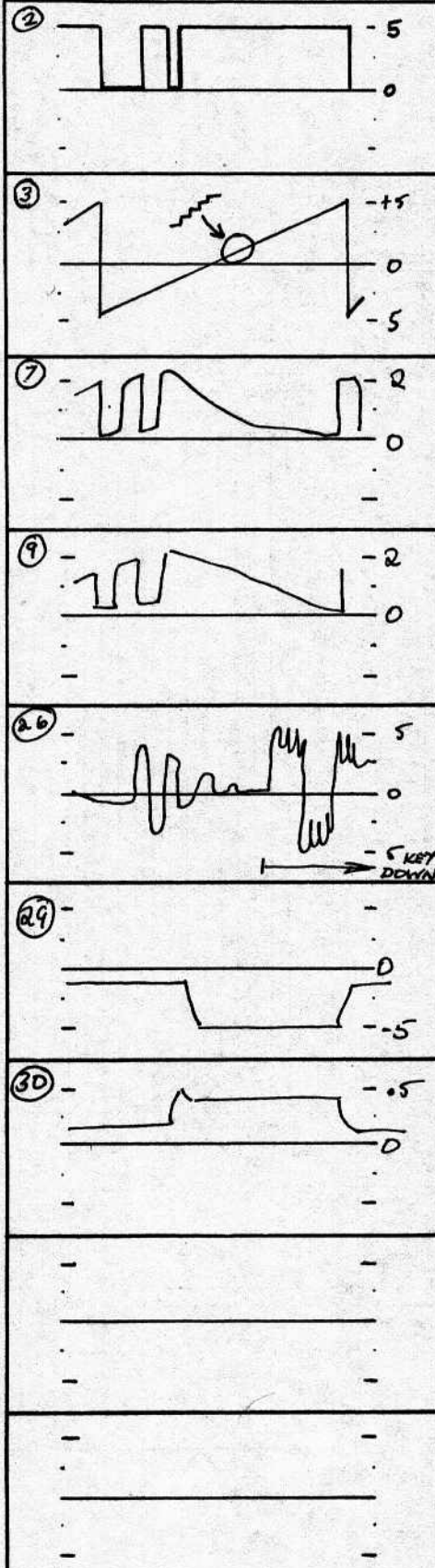

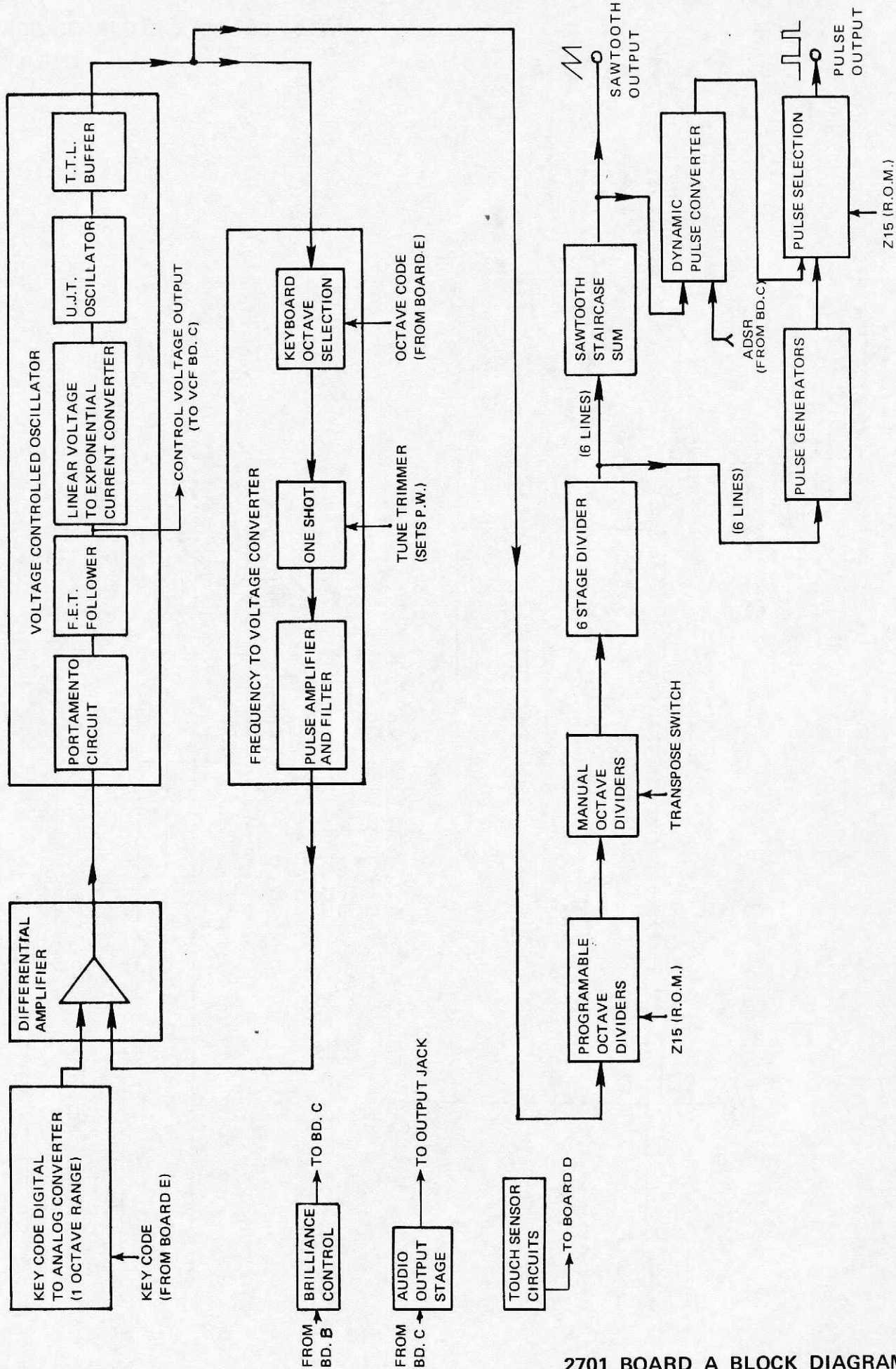

2701 BOARD A BLOCK DIAGRAM

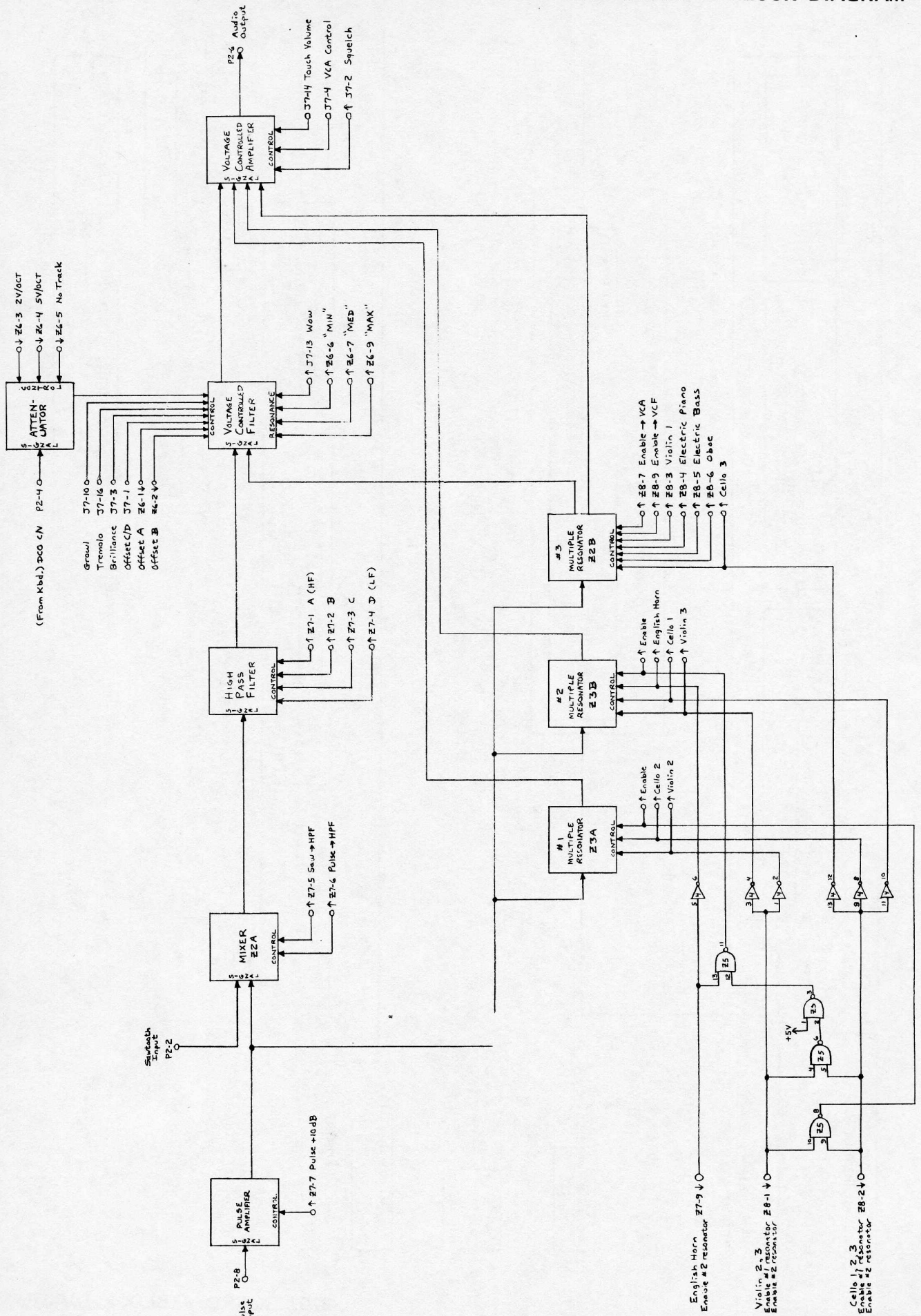

NOTE Arrows @ /logic inputs: ↑ indicates logic 1 activates function ↓ indicates logic 0 activates function

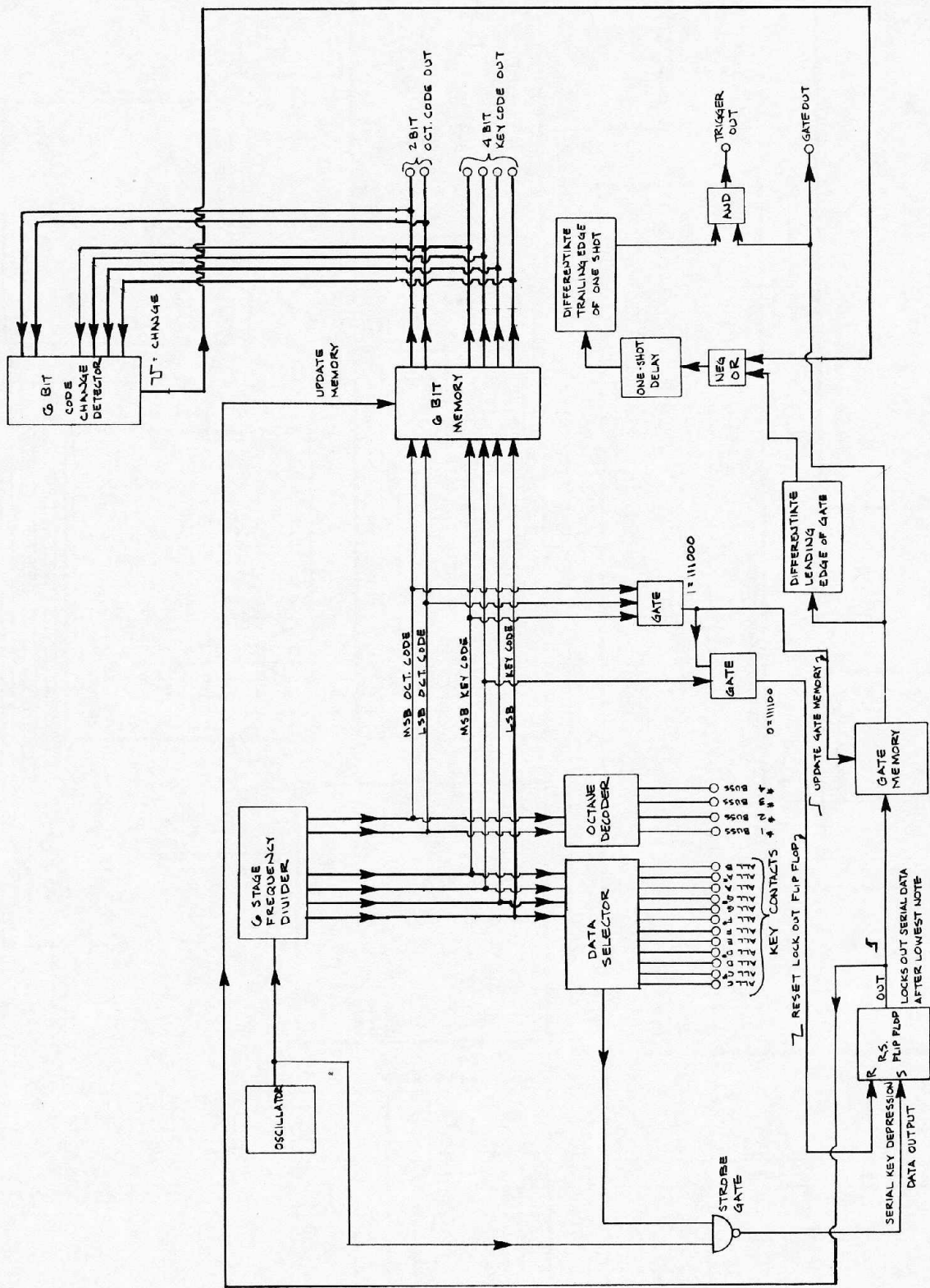

BOARD E BLOCK DIAGRAM

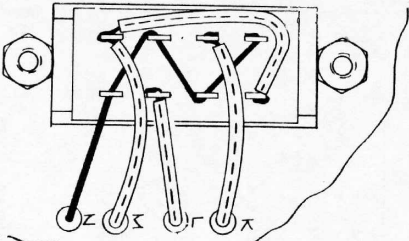

C16
.001

R20
820K

Z21
S19989
A-2701-008

Z20
B-2701-012

Z19
7405

Z18
7410

Z17
7402

Z16
7454

Z15 BROWN
A-2701-057-1

Z14
B-2701-011-

Z13
7454

Z12
7412

Z11
7493

Z10
7402

Z9
7400

Z8
7473

Z7
7405

Z6
7412

Z5
7403

Z4
7400

Z3
7473

Z2
7400

Z1
7473

R21
330K

R22
680K

R23
100K

R24
100K

R25
100K

R26
100K

R27
100K

R28
100K

R29
100K

R30
100K

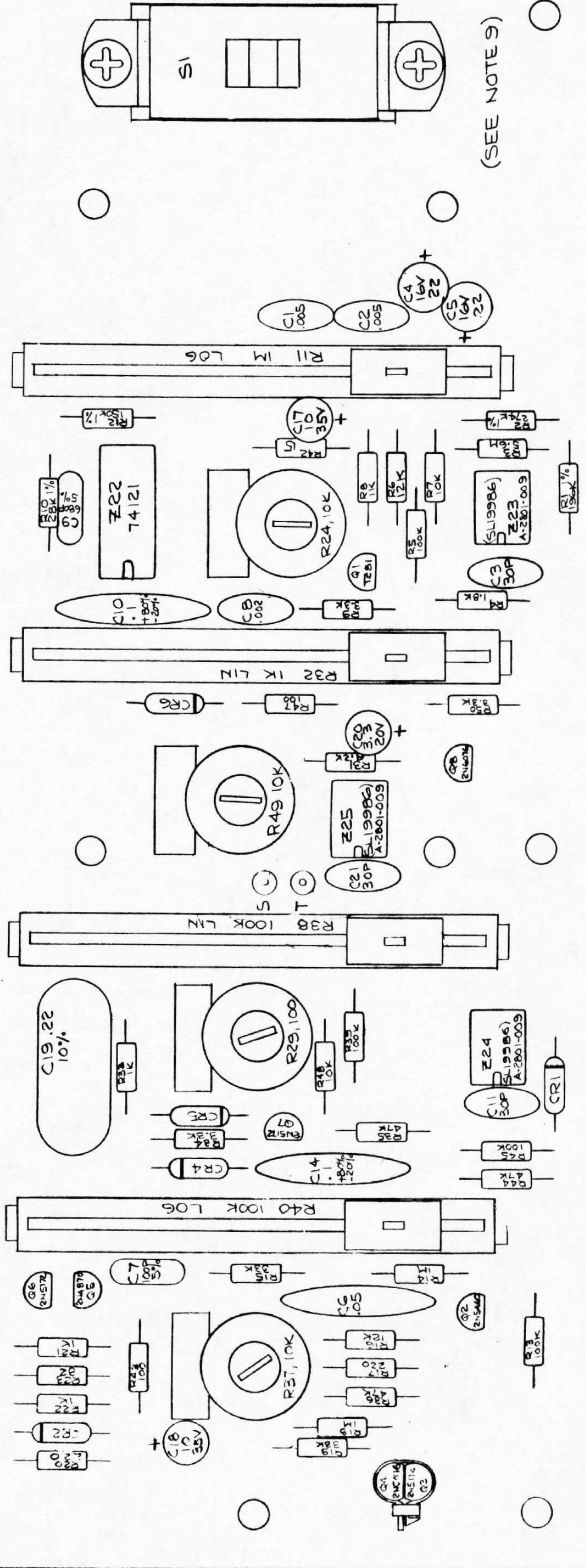

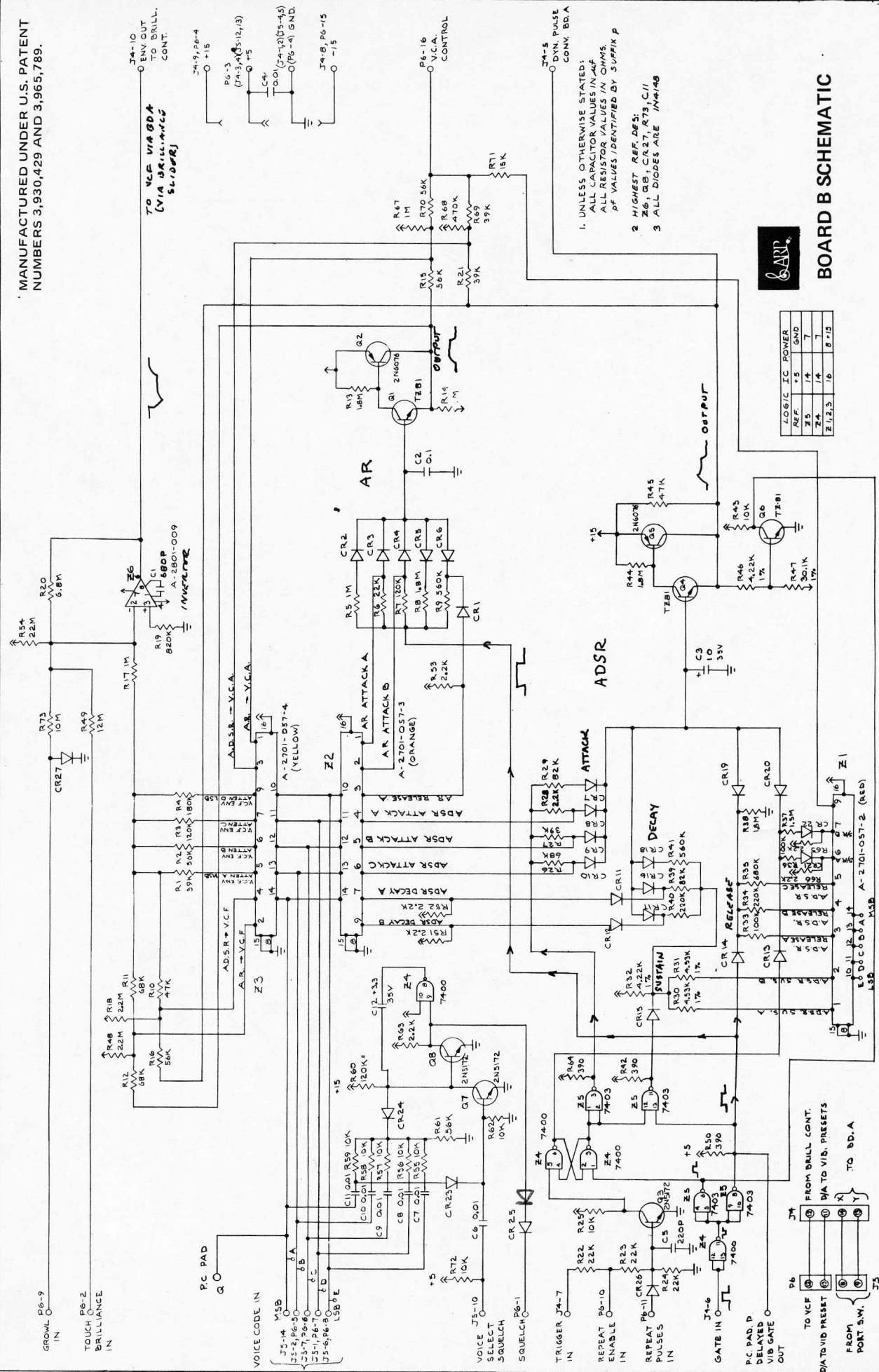

BOARD B SCHEMATIC

1. UNLESS OTHERWISE STATED:
ALL CAPACITOR VALUES IN μF
ALL RESISTOR VALUES IN OHMS.
PF VALUES IDENTIFIED BY SUFFIX P
2. HIGHEST REF. DFGS:
Z6, CR3, CR27, CR73, C/11
3. ALL DIODES ARE 1N4148

LOGIC IC POWER	
REF. #5	GND
Z5	14
Z4	14
Z1,2,3	16
P-15	7

2701 BOARD C SCHEMATIC

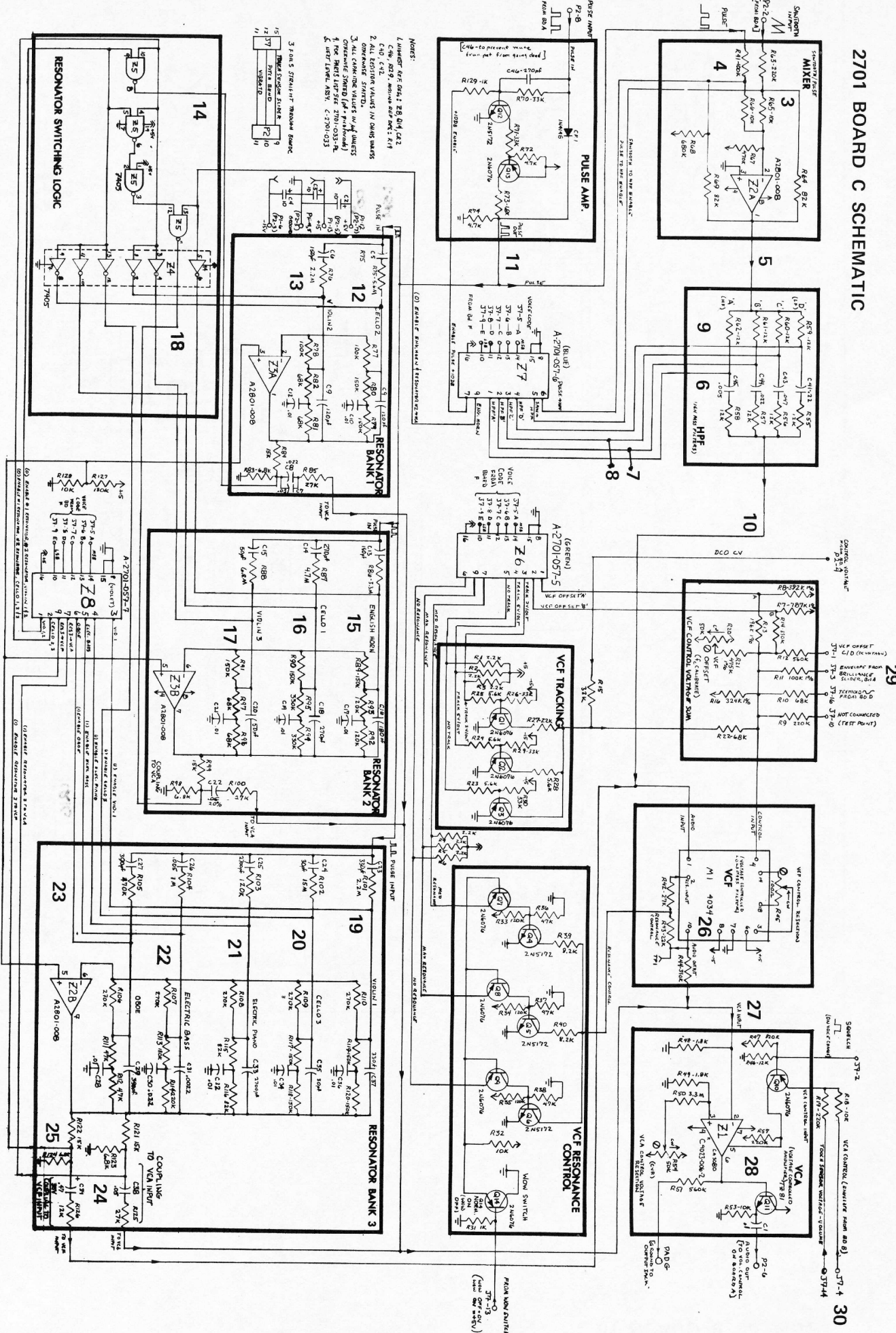

NOTES:
 1. HIGHER REF. DES.: 28.04.02.2
 C46, Q27, assume ref. des.: R14
 C47, C48

- ALL RESISTIVE VALUES IN OHMS UNLESS SPECIFIED OTHERWISE
- ALL COMPONENT VALUES IN FOOTNOTES
- CONCENTRIC STRIP LINES (SEE P. 14)
- FOR PART LIST SEE 2701-003-R
- UNIT LEVEL ASSY. C-2701-003

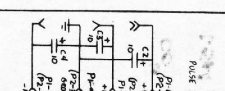

29

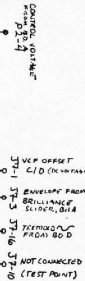

30

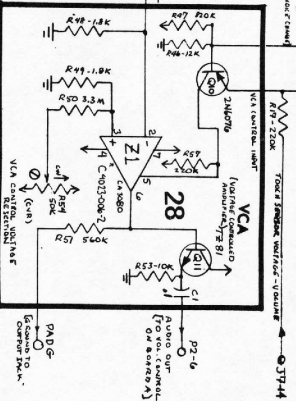

2701 BOARD C LAYOUT

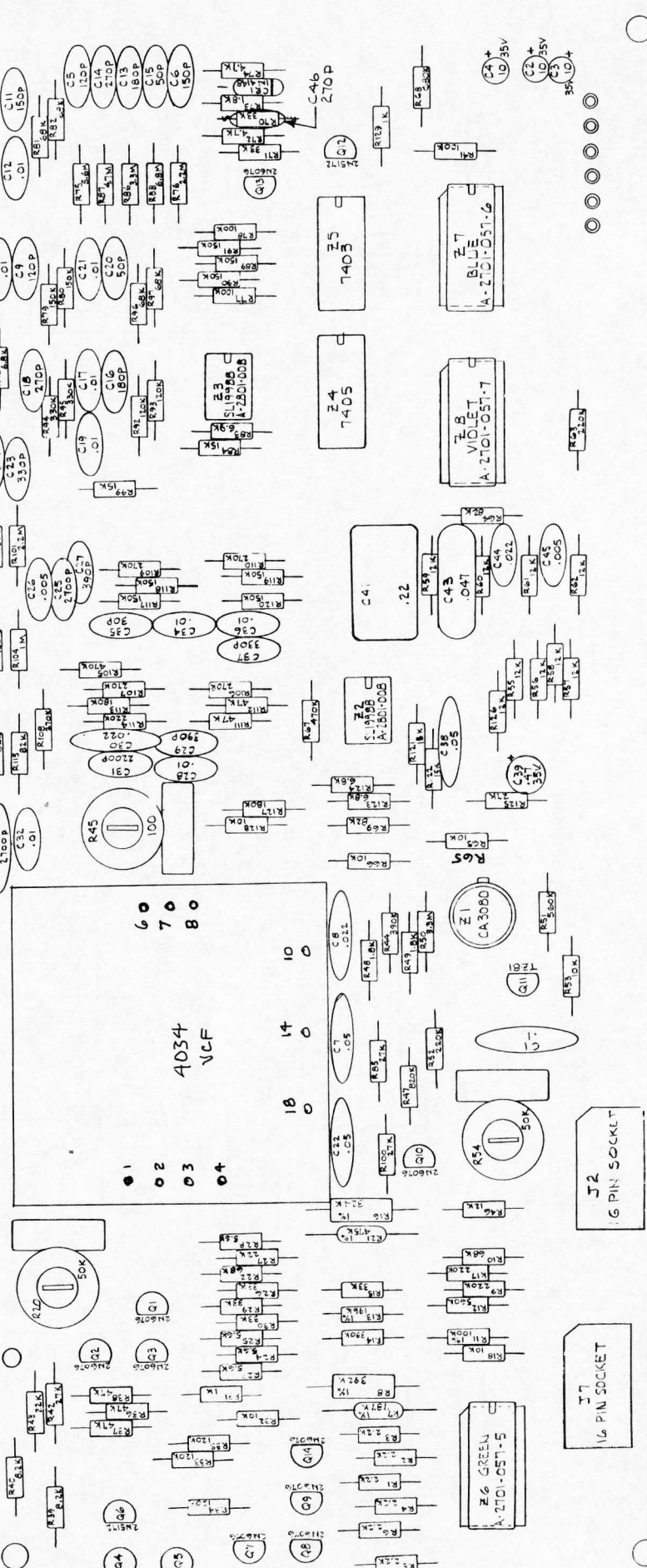

2701 BOARD C LAYOUT

MANUFACTURED UNDER U.S. PATENT
NUMBERS 3,930,429 AND 3,965,789.

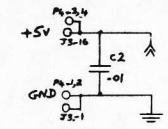

POWER SUPPLY CONNECTIONS			
I.C.	GND	+5V	TYPE
Z4	10	5	7475
Z5	11	16	7475
Z3	8	16	74174
Z6	7	14	7403
Z1,2	7	14	7443
Z11	12	24	174150
Z9	7	14	7429
Z10	7	14	8601
Z8	7	14	7402
Z7	7	14	7400

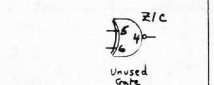
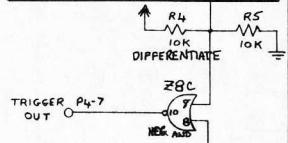
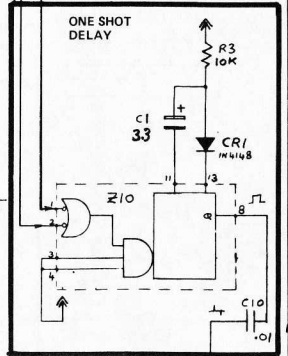
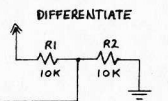
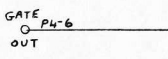

INTERNAL CONNECTIONS TO SPLIT BUSSES:

- OCT 4 BUSS
- OCT 3 BUSS
- OCT 2 BUSS
- OCT 1 BUSS

INTERNAL CONNECTIONS TO KEY CONTACTS:

- ALL KEYS C
- C
- D
- D
- E
- F
- F
- G
- G
- A
- A
- B

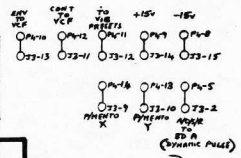
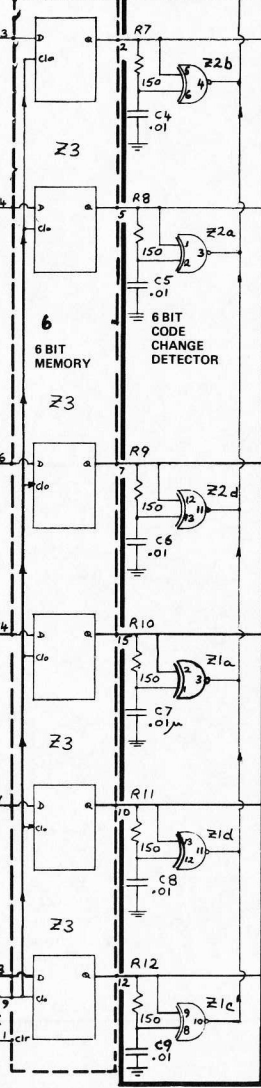
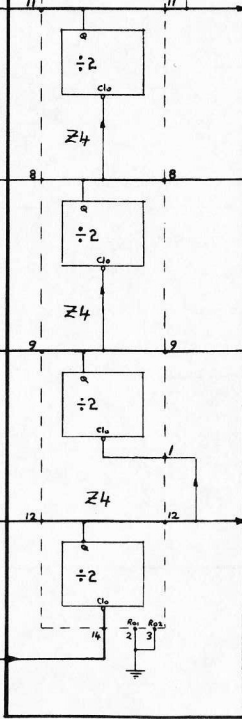
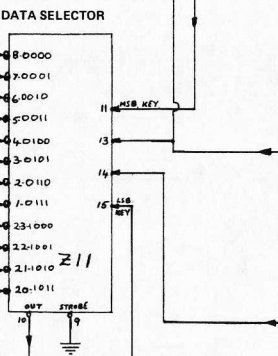
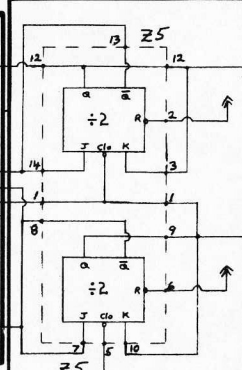
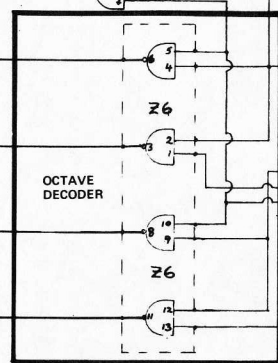
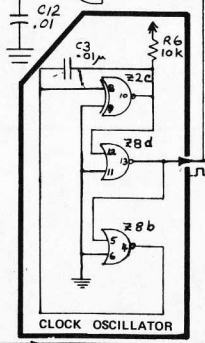
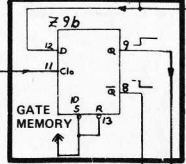
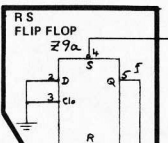

OCTAVE CODE OUT (TO BOARD A)

KEY CODE OUT (TO BOARD A)

2701 Board E
ARP Keyboard Electronics

BOARD E LAYOUT

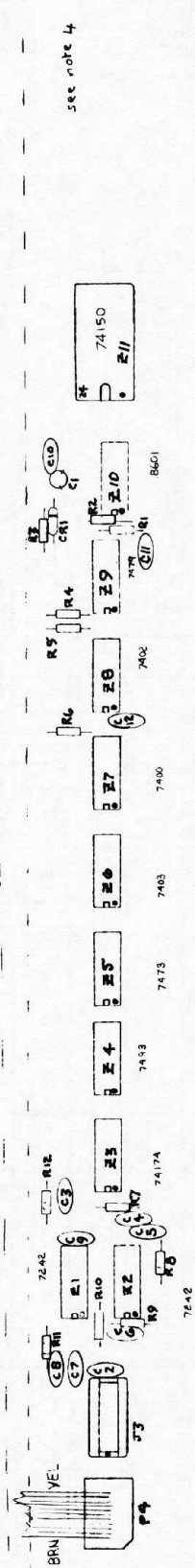

- CR1 ~ IN4148 DIODE
- R1-R6 10K RESISTOR, CARBON FILM, ± 5% 1/4W
- R7-R12 150Ω " " " " " "
- C1 3.3μf CAPACITOR, TANTALUM, EPOXY ± 10% 20V
- C2-C12 .01μf CAPACITOR CERAMIC, DISC ± 20% 50V

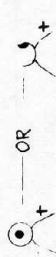

MANUFACTURED UNDER U.S. PATENT
NUMBERS 3,930,429 AND 3,965,789.

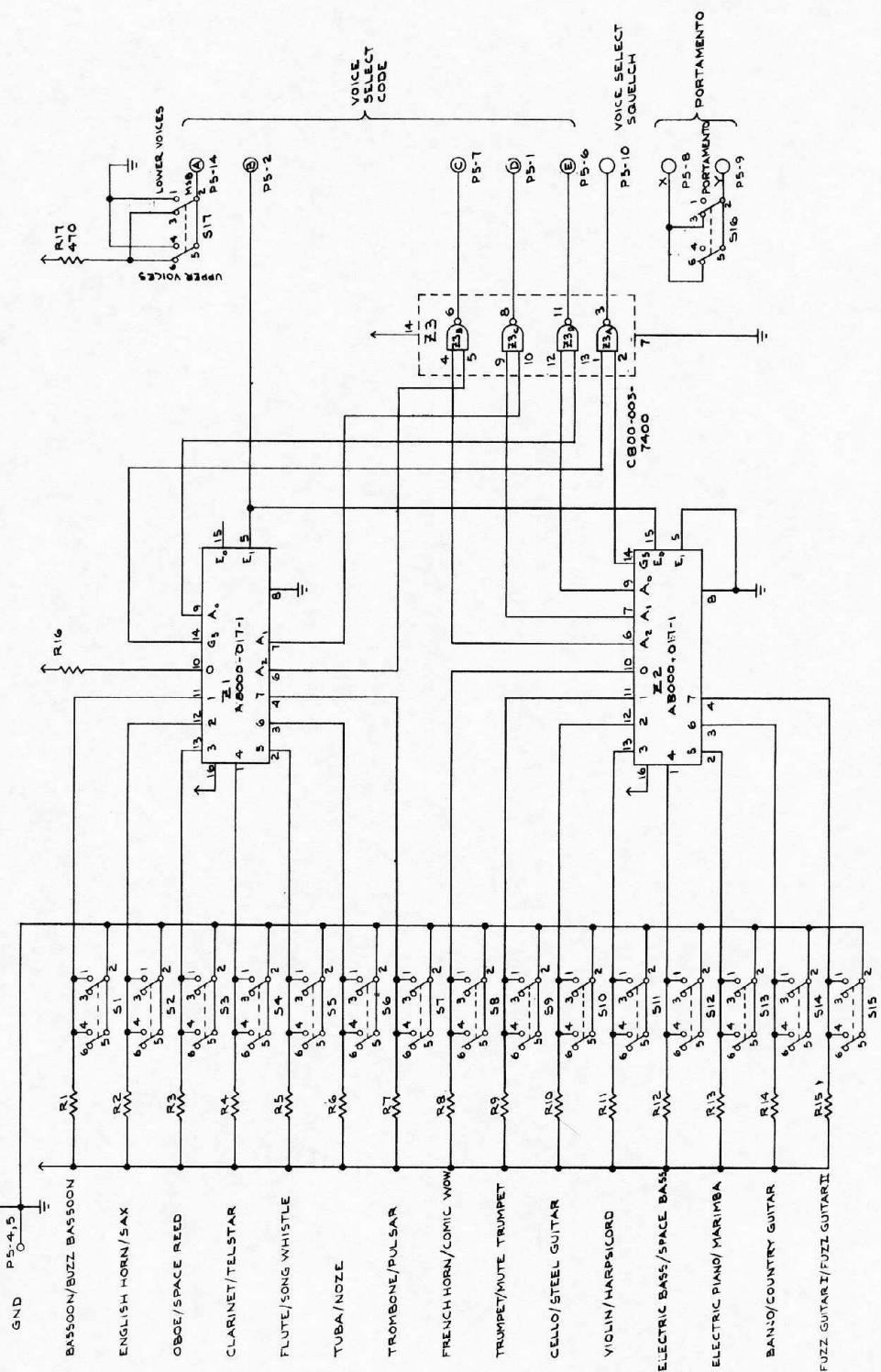
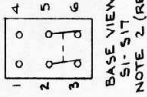

LOWER VOICE	UPPER VOICE	OUTPUT CODE
A 0	A 1	B C D E
BUZZ BASSOON	BASSOON	0 0 1 1
SAX	ENGLISH HORN	0 1 1 0
SPACE REED	OBOE	0 1 0 1
TELSTAR	CLARINET	0 1 0 0
SONG WHISTLE	FLUTE	0 1 0 1
NOZE	TUBA	0 1 1 0
PULSAR	TROMBONE	0 1 1 1
COMIC WOV	FRENCH HORN	1 0 0 0
MUTE TRUMPET	TRUMPET	1 0 0 1
STEEL GUITAR	CELLO	1 0 1 0
HARPSICORD	VIOLIN	1 0 1 1
SPACE BASS	ELECTRIC BASS	1 0 1 0
MARIMBA	ELECTRIC PIANO	1 1 0 1
COUNTRY GUITAR	BANJO	1 1 1 0
FUZZ GUITAR I	FUZZ GUITAR II	1 1 1 1

- NOTES:
1. UNLESS OTHERWISE SPECIFIED:
ALL RESISTOR VALUES ARE IN OHMS
RESISTOR RIG ARE 2.2K
 2. HIGHEST RES. DES.
 3. HIGHEST RES. DES.

BOARD F-II SCHEMATIC

BOARD F-II LAYOUT

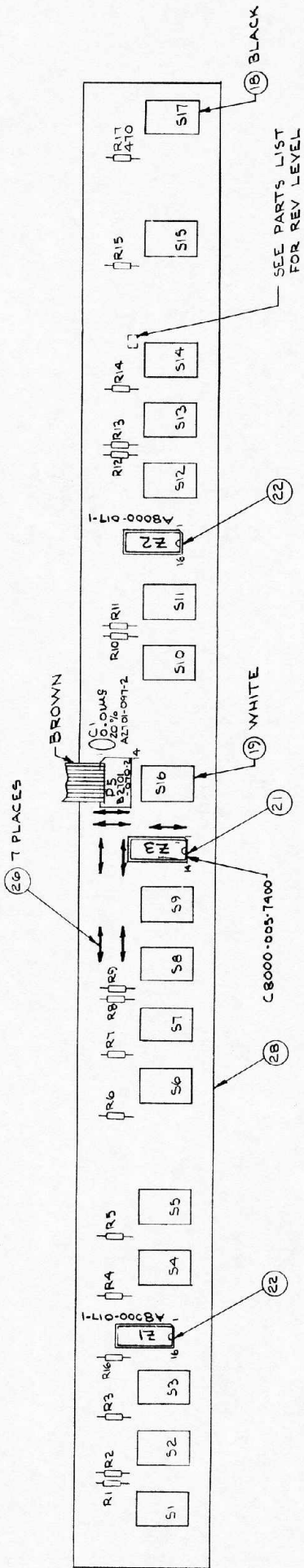

20 7 PLACES

BROWN

C1
0.01uS
20%
AL701-DHT-2

Z2
AB000-017-1

WHITE

C8000-005-T400

SEE PARTS LIST
FOR REV LEVEL

18 BLACK

22

21

28

22

22

22

22

22

22

22

22

22

22

22

22

22

22

22

22

22

22

22

22

22

22

22

22

22

22

22

22

22

22

22

22

22

22

22

22

22

22

22

22

22

22

22

22

22

22

22

22

22

22

22

22

22

22

22

22

22

22

22

22

22

22

22

22

22

22

22

22

22

22

22

22

22

22

22

22

22

22

22

22

22

22

22

22

22

22

22

22

22

22

22

22

22

22

22

22

22

22

22

22

22

22

22

22

22

22

22

22

22

22

22

22

22

22

22

22

22

22

22

22

22

22

22

22

22

22

22

22

22

22

22

22

22

22

22

22

22

22

22

22

22

22

22

22

22

22

22

22

22

22

22

22

22

22

22

22

22

22

22

22

22

22

22

22

22

22

22

22

22

22

22

22

22

22

22

22

22

22

22

22

22

22

22

22

22



PRO/DGX MODEL 2720
BOARD F-III
LAYOUT

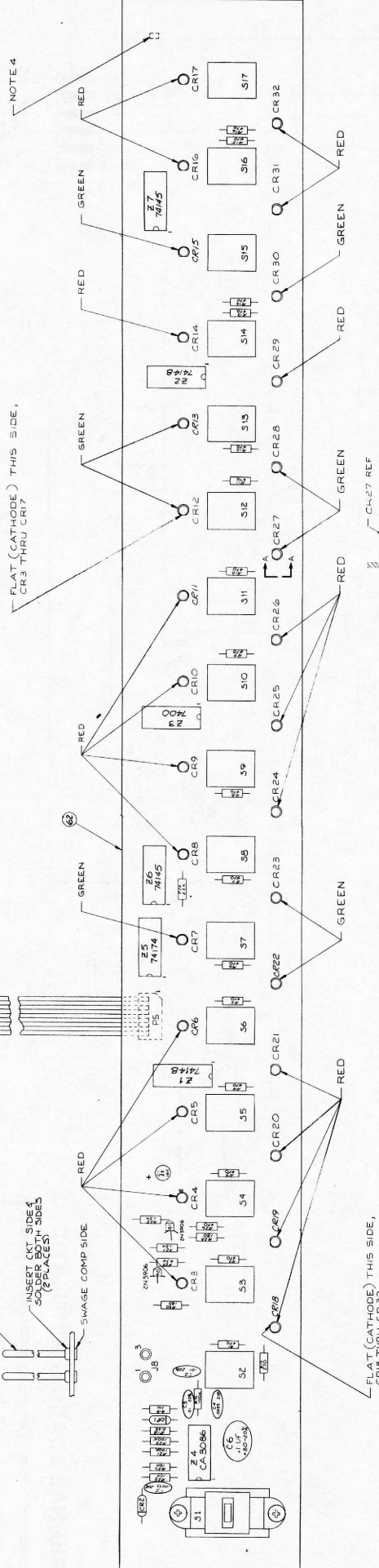

NOTE 4
FLAT (CATHODE) THIS SIDE,
CR3 THRU CR17

FLAT (CATHODE) THIS SIDE,
CR18 THRU CR32

SWAGE COMP SIDE
INSERT CKT. SIDE 4
SOLDER BOTH SIDES
(2 PLACES)

CR27 REF
SHOULDER OF LEAD TO
SOLDER ON BOARD,
(TYP CR3 THRU CR32)
SECTION A-A

- NOTES:
- UNLESS OTHERWISE SPECIFIED, RESISTOR VALUES ARE IN OHMS. CAPACITOR VALUES ARE IN μ F (P-PICOFARADS).
 - RESISTOR TOLERANCE IS $\pm 5\%$.
 - RESISTOR VALUE IN P1 AND ITS DIAGONAL COUNTERPART IS 2K THRU 27.
 - FINISHED ASSY TO BE FREE OF EXCESS FLUX.
 - RUBBER STAMP REV LEVEL OF THIS DRAWING USING BLACK INK, COVER WITH CLEAR VARNISH, (BOTH SIDES).
 - FOR PARTS LIST, SEE PL721401.

1 RES. FILM PRINT 2
2.5%

1 RES. FILM PRINT 2
5% 7%

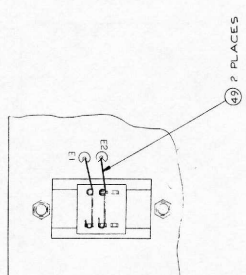
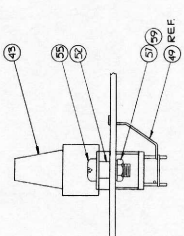

99 ? PLACES

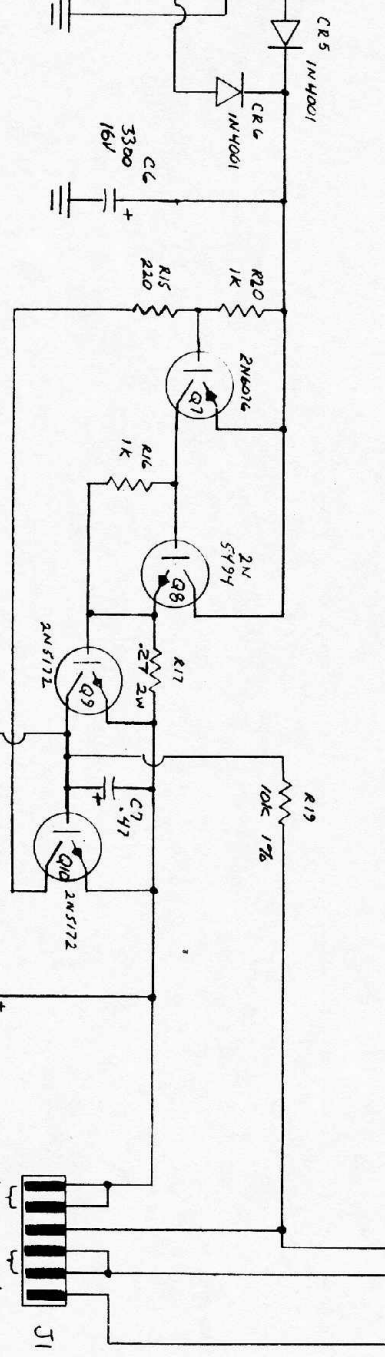
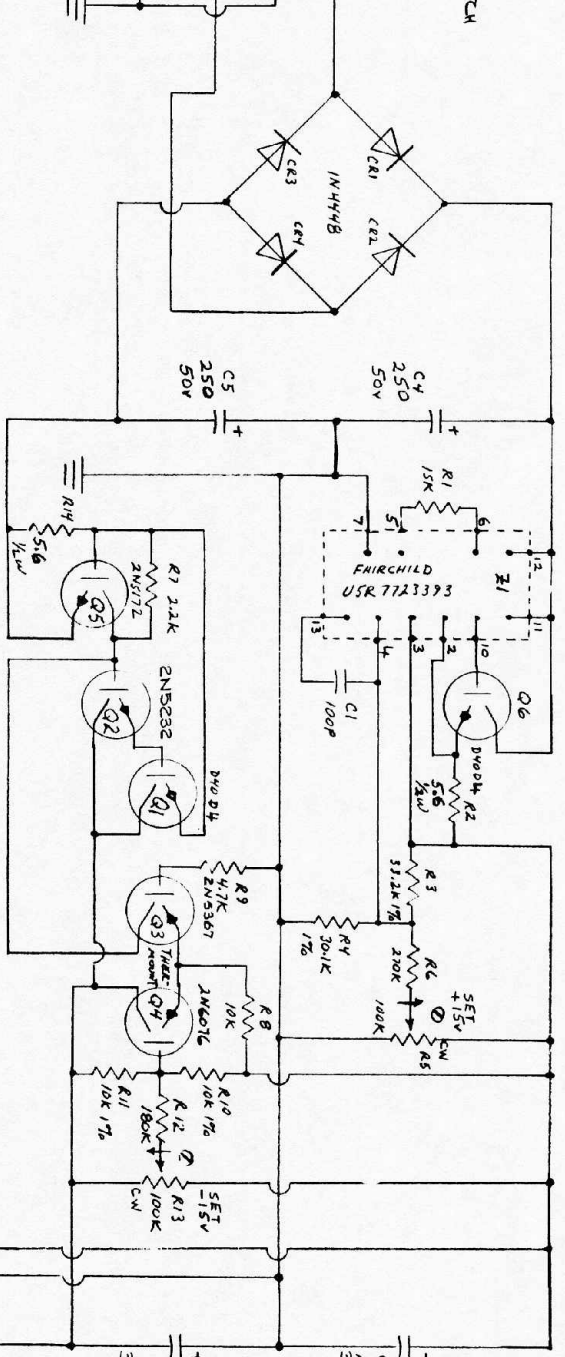
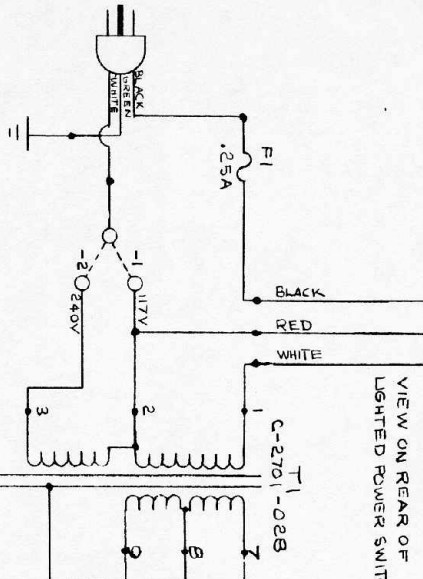
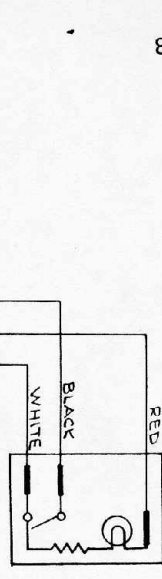

ORIGINAL BOARD G SCHEMATIC

ARRP

2701 Board G
Power Supply

ORIGINAL BOARD G LAYOUT

component side view

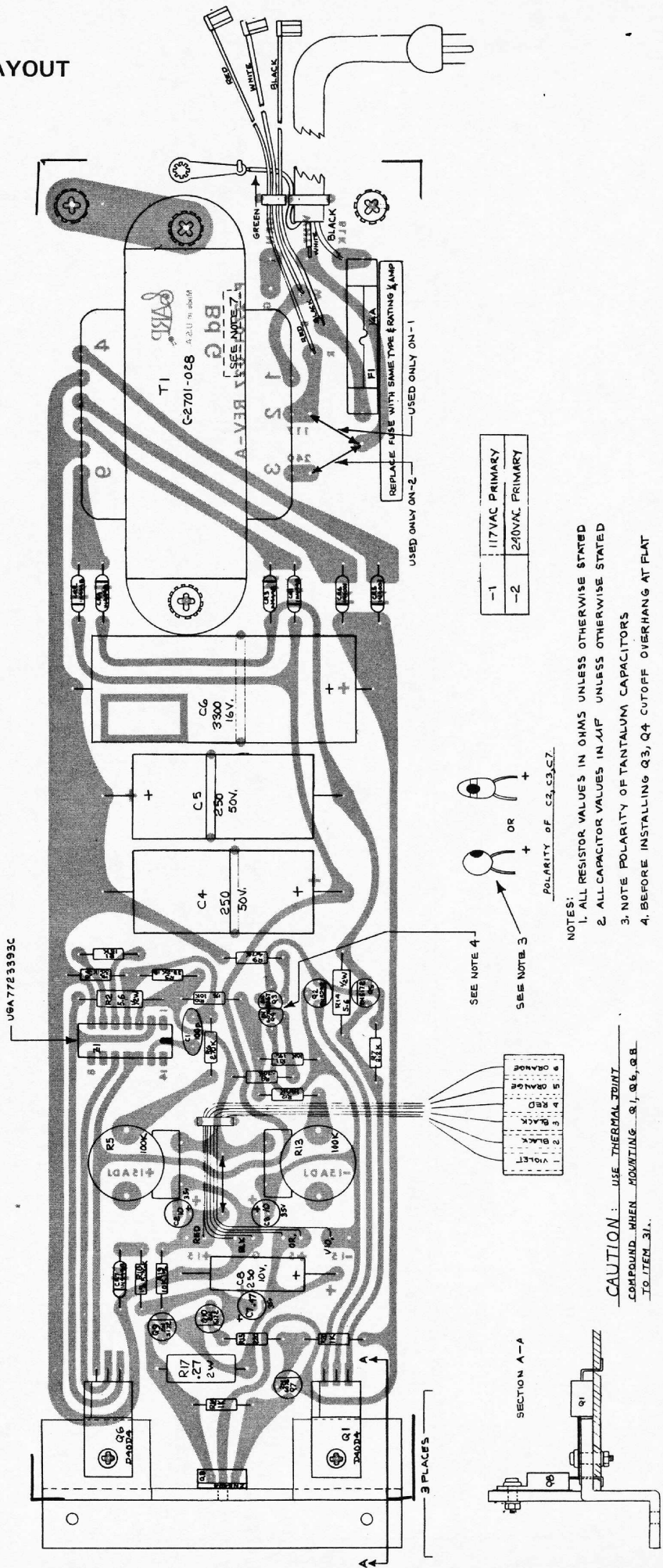

USA7723393C

3 PLACES

SECTION A-A

-1	117VAC PRIMARY
-2	240VAC PRIMARY

SEE NOTE 4
SEE NOTE 3
POLARITY OF C3, C3A, C7

- NOTES:
1. ALL RESISTOR VALUES IN OHMS UNLESS OTHERWISE STATED
 2. ALL CAPACITOR VALUES IN μ F UNLESS OTHERWISE STATED
 3. NOTE POLARITY OF TANTALUM CAPACITORS
 4. BEFORE INSTALLING Q3, Q4 CUTOFF OVERHANG AT FLAT

CAUTION: USE THERMAL JUNT COMPOUND WHEN MOUNTING Q1, Q6, Q8 TO ITEM 31.

9	ORANGE
8	ORANGE
7	RED
6	RED
5	BLACK
4	BLACK
3	BLACK
2	BLACK
1	VOLET

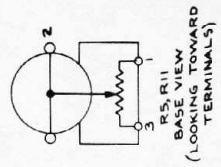

- NOTES:
1. UNLESS OTHERWISE SPECIFIED, ALL RESISTOR VALUES ARE IN OHMS. CAPACITOR VALUES ARE IN μ F (MICROFARADS) IN μ S (PICOFARADS)
 2. HIGHEST REF. DES. CB, CRT, E4, F1, P1, Q10, R24, S1, T1, Z1

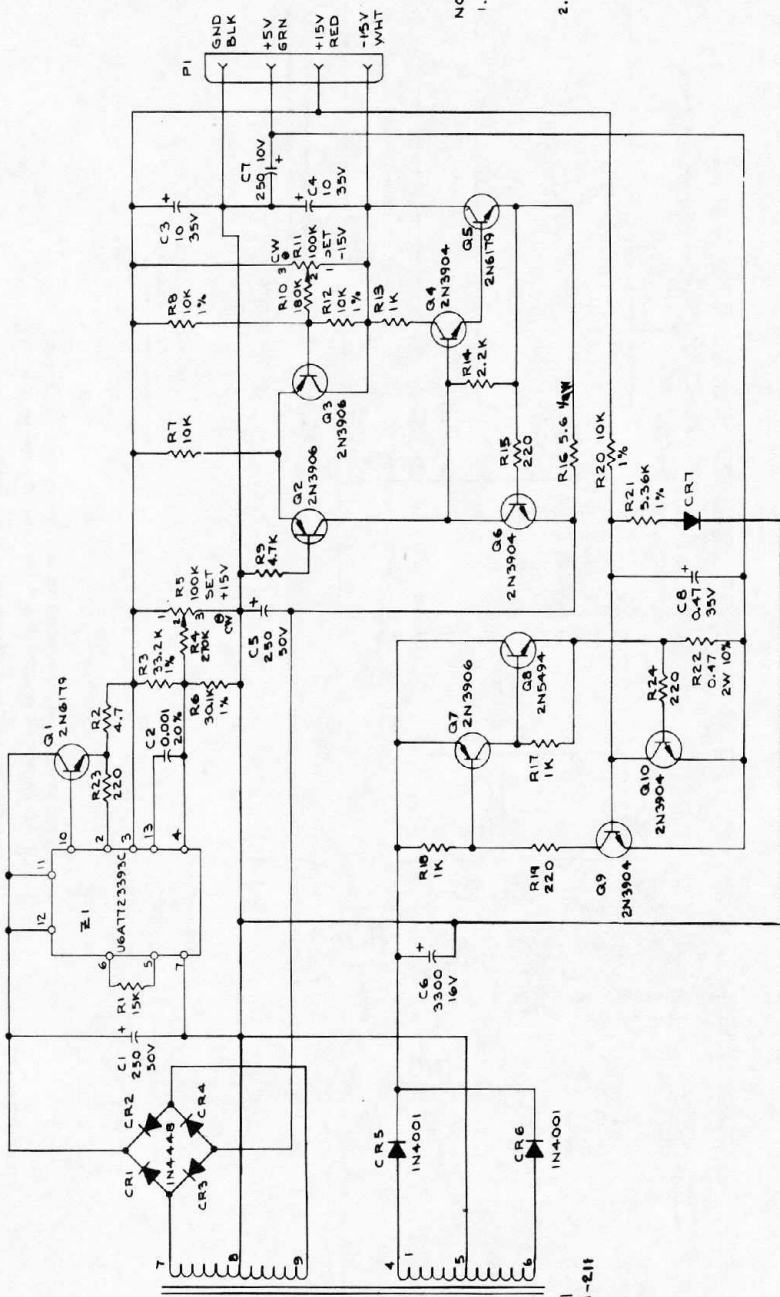

POWER SWITCH
(EXTERNAL TO PC BOARD)

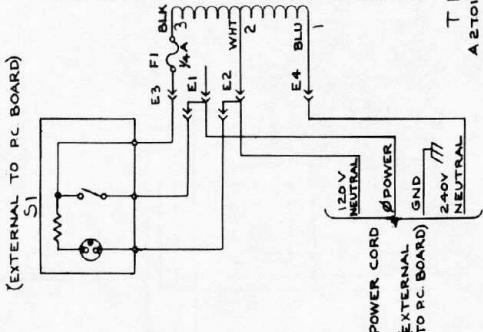

T 1
A2701-211

BOARD G-II SCHEMATIC
REVISED

MANUFACTURED UNDER U.S. PATENT
NUMBERS 3,930,429 AND 3,965,789.

PARTS LIST

BOARD A

REFERENCE	ARP PART NUMBER	ARP/MFG NUMBER	DESCRIPTION
Z7, Z19	5602104	C-8000-005-7405	I.C. HEX INVERTER - O/C COLL
Z14	5700401	B-2701-011-B	I.C. CERMET RESISTOR PACK
Z23,24,25	1400801	A-2801-009	I.C. OPERATIONAL AMP (LM301AN)
Z6	5602106	C-8000-005-7412	I.C. TRIPLE 3-I NAND GATE O/C COLL
Z5	1401901	C-8000-005-7403	I.C. QUAD 2-I NAND GATE O/C COLL
Z2,4,9	1401701	C-8000-005-7400	I.C. QUAD 2-I NAND GATE
Z22	1402801	C-8000-005-74121	I.C. ONE SHOT MULTIVIBRATOR
Z1,3,8	1402501	C-8000-005-7473	I.C. DUAL TYPE J-K FLIP FLOP
Z11,12	1402701	C-8000-005-7493	I.C. 4 BIT BINARY COUNTER
Z13,16	1402401	C-8000-005-7454	I.C. 4 WIDE 2-I A/O INVERT GATE
Z21	5601801	A2801-008	I.C. DUAL OP AMP (NSC SL19988)
Z18	1402101	C-8000-005-7410	I.C. TRIPLE 3-I NAND GATE
Z10,17	1401801	C-8000-005-7402	I.C. QUAD 2-I NOR GATE
Z20	5700501	A2701-057-1	I.C. CERMET RESISTOR PACK
Z15	5600701	A2701-057-1	I.C. PROGRAMMABLE R.O.M
CR1,2,3,4,5,6	1200301	IN4148	DIODE, SIGNAL
Q1	1304601	A2701-057-1B	TZ-81
Q2	1302401	2N5460	TSTR FIELD EFFECT P CHANNEL
Q6,7	1301701	2N5172	TSTR SI NPN
Q8	1302801	2N6076	TSTR SI PNP
Q5	1301601	2N4870	TSTR SI UNI JUNCTION
Q3,Q4	7502601	APL4027-008	TSTR ASSY NPN/PNP
C17,18	1100612	TAG00 10/35 50/20	CAP TANT 10uf 35V +50-20%
C4,5,15	1100601	TAG00 22/16 20/20	CAP TANT 22uf 16V 20%
C20	1100602	TAG00 3.3/20 10/10	CAP TANT 3.3uf 20V 10%
C19	1101104	225P22492XD3	CAP POLY .22uf 200V 10%
R29	1000901	U201R101B	TRIM POT 100 OHM
R24,37,49	1000909	U201R103B	TRIM POT 10K
R38	5700703	B-2801-006-3D	POT SLIDE 100K LIN
R40	5700702	B-2801-006-2D	POT SLIDE 100K LOG
R11	5700701	B-2801-006-1D	POT SLIDE 1M LOG
R32	5700704	B-2801-006-4D	POT SLIDE 1K LIN
P2	2200805	B2701-071-1B	PLUG TO PLUG ASSY 26 PIN 9"
P3	2200806	B2701-071-2B	PLUG TO PLUG ASSY 16 PIN 15"
S1	1900801	02-481-0001	SWITCH ROCKER DPTT

BOARD B

REFERENCE	ARP PART NUMBER	ARP/MFG NUMBER	DESCRIPTION
Z6	1400801	A-2801-009	I.C. OP AMP (NSC) AL19986
Z4	1401701	C-8000-005-7400	I.C. QUAD 2-I NAND GATE
Z5	1401901	C-8000-005-7403	I.C. QUAD 2-I NAND GATE O/C COLL
Z1	5600801	A2701-057-2	I.C. PROGRAMMABLE R.O.M.
Z2	5600901	A2701-057-3	I.C. PROGRAMMABLE R.O.M.
Z3	5601001	A2701-057-4	I.C. PROGRAMMABLE R.O.M.
Q1,4,6	1304601	TZ-81	TSTR SI NPN
Q3,7,8	1301701	2N5172	TSTR SI NPN
Q2,5	1302801	2N6076	TSTR SI PNP
CR1-27	1200301	IN4148	DIODE SI SIGNAL
C2	1101103	225P10491WD3	CAP POLY .1uf 10% 100V
C3	1100608	TAG00 1/35 10/10	CAP TANT 1uf 10% 35V
C12	1100611	TAG00 3.3/35 10/10	CAP TANT 3.3uf 10% 35V
J4,5	2101302	16-511-10	SOCKET 16 PIN
	2101301	14-511-10	SOCKET 14 PIN

BOARD C

REFERENCE	ARP PART NUMBER	ARP/MFG NUMBER	DESCRIPTION
Z1	1400401	B4023-006-2	I.C. OP TRANS AMP (RCA CA3080)
Z2,3	1401101	A-2801-008	I.C. OP AMP (NSC) SL19988
Z4	1402001	C-8000-005-7405	I.C. HEX INVERTER O/C COLL
Z5	1401901	C-8000-005-7403	I.C. QUAD 2-I NAND GATE O/C COLL
Z6	5601101	A2701-057-5	I.C. PROGRAMMABLE R.O.M.
Z7	5601201	A2701-057-6	I.C. PROGRAMMABLE R.O.M. BLUE
Z8	5601301	A2701-057-7	I.C. PROGRAMMABLE R.O.M. VIOLET
Q4,5,6,12	1301701	2N5172	TSTR SI NPN
Q11	1304601	TZ-81	TSTR SI NPN
Q1,2,3,7,8,9,10, 13,14	1302801	2N6076	TSTR SI PNP
CR1,2	1200301	IN4148	DIODE SI SIGNAL
R45	1000901	U201R101B	POT TRIM 100 OHM
R20,54	1000913	U201R503B	POT TRIM 50K
M1	7201001	4034-004-PL-C	ENCAPSULATED MODULE, V.C.F.
C43	1101102	225P47391WD3	CAP POLY .047uf 10% 100V
C31	1100143	LTMD	CAP CER .0022uf 10% 50V
C39	1100606	TAG00 .47/35 10/10	CAP TANT .47uf 10% 35V
C2,3,4	1100612	TAG00 10/35 20/20	CAP TANT 10uf 20% 35V
C41	1101104	225P-22492XD3	CAP POLY .22uf 200V 10%
	2102302	16-511-10	SOCKET 16 PIN

BOARD D

REFERENCE	ARP PART NUMBER	ARP/MFG NUMBER	DESCRIPTION
Z5	1400801	A2801-009	I.C. OP AMP (LM301AN)
Z3	1401101	A2801-008	I.C. DUAL OP AMP (LM1458)
Z2,4	1400501	CA3086	I.C. TSTR ARRAY NPN
Z1	5601401	A2701-057-8	I.C. PROGRAMMABLE R.O.M. GRAY
Q5	1301701	2N5172	TSTR SI NPN
Q1,2,3,4	1302801	2N6076	TSTR SI PNP
CR1-9	1200301	IN4148	DIODE SI SIGNAL
R20	5601802	B2801-010-2	POT ROT 100K LIN
C12	1100609	TAG00 1/35 20/20	CAP TANT 1uf 20% 35V
C14	1100610	TAG00 1.5/35 10/10	CAP TANT 1.5uf 10% 35V
C11	1100612	TAGpp 10/35 20/20	CAP TANT 10uf 20% 35V
C10	1100606	TAG00 .47/35 10/10	CAP TANT .47uf 10% 35V
S1-7	1901002	02-481-0010-B	SWITCH DPDT WHITE
P6	2200805	B2701-071-1B	PLUG TO PLUG ASSY 16 PIN 9"
P7	2200806	B2701-071-2B	PLUG TO PLUG ASSY 16 PIN 15"

BOARD E

REFERENCE	ARP PART NUMBER	ARP/MFG NUMBER	DESCRIPTION
Z7	1401701	C-8000-005-7400	I.C. QUAD 2-I NAND GATE
Z8	1401801	C-8000-005-7402	I.C. QUAD 2-I NOR GATE
Z6	1401901	C-8000-005-7403	I.C. QUAD 2-I NAND GATE O/C COLL
Z5	1402501	C-8000-005-7473	I.C. DUAL J-K FLIP FLOP
Z9	1402601	C-8000-005-7474	I.C. DUAL D TYPE FLIP FLOP
Z11	1402901	C-8000-005-74150	I.C. DATA SELECTOR
Z3	1403001	C-8000-005-74174	I.C. HEX D TYPE FLIP FLOP
Z1,2	1403101	C-8000-005-7242	I.C. QUAD 2-I EXCL NOR GATE

Z10	1403201	C-8000-005-8601	I.C. RETRIGGERABLE ONE SHOT
Z4	1402501	C-8000-005-7473	I.C. 4 BIT BINARY COUNTER
CR1	1200301	IN4148	DIODE SI SIGNAL
C1	11006102	TAG00 3,3/20 10/10	CAP TANT 3.3uf 10% 20V
J3	2101302	16-511-10	SOCKET 16 PIN
P4	2200803	B-2701-070-1-B	PLUG TO PLUG ASSY 14 PIN

BOARD F-II

REFERENCE	ARP PART NUMBER	ARP/MFG NUMBER	DESCRIPTION
Z3	1401701	C8000-005-7400	I.C. Quad 2 INPUT NAND GATE
Z1,2	1403701	SN74148	I.C. PRIORITY ENCODER
S1-15,17	1901001	02-481-0009B	SWITCH ROCKER DPDT BLACK
S16	1901002	02-481-0010B	SWITCH ROCKER DPDT WHITE
FORZ3	2101301	14-511-10	SOCKET DUAL IN LINE 14 PIN
FORZ1,2	2101302	16-511-10	SOCKET DUAL IN LINE 16 PIN
P5	2200804	B2701-070-2	PLUG TO PLUG ASSY 14 PIN

BOARD G

REFERENCE	ARP PART NUMBER	ARP/MFG NUMBER	DESCRIPTION
Z1	1401301	UGA7723393C	I.C. VOLTAGE REGULATOR
Q5,9,10	1301701	2N5172	TSTR SI PLASTIC NPN
Q4,7	1302801	2N6076	TSTR SI PLASTIC PNP
Q8	1302601	2N5494	TSTR SI PLASTIC NPN PWR
Q1,6	1303401	2N6179	TSTR SI PLASTIC NPN PWR
Q3	1302201	2N5367	TSTR SI PLASTIC PNP
Q2	1301801	2N5232	TSTR SI PLASTIC NPN
CR1,2,3,4,7	1200401	IN4448	DIODE SI LOW CURRENT
CR5,6	1200201	IN4001	DIODE SI MED CURRENT
R2	1000310	1-4-5P-4E7	RESISTOR CARB FILM 5.6OHM 5% 1/2W
R17	1000108	BWH-2-0,27OHM	RESISTOR WW 0,27OHM 10% 2W
R5-R13	1000915	U201R104B	POT TRIM 100K
C7	1100607	TAG00 .47/35 20/20	CAP TANT EPOXY .47uf 20% 35V
C2,3	1100612	TAG00 10/35 20/20	CAP TANT EPOXY 10uf 20% 35V
C8	1101701	B41283 250/10	CAP ELECTRO ALUM 250uf +50-10%
C4, C5	1101702	B41010 250/50	CAPACITOR, ELECTRO. 250 UF 10V
C6	1101501	16T3300	CAPACITOR, ELECTRO. 33 UF, 16V
T1	5702201	C-2701-028C	TRANSFORMER
F1	1700403	MDV-¼	FUSE PIGTAIL SLOW BLOW ¼A

BOARD F-III (PRO/DGX)

S1	1901002	02-481-001D	SWITCH ROCKER DPDT WHITE
S2 - 17	1902901	DIGITAST-ST	SWITCH PB SPDT
Z1 - 2	1403701	2N74148	IC ENCODER 8 LINE PRIORITY
Z3	1401701	2N7400	IC GATE 4 X 2I NAND
Z4	1400501	CA3086	IC TSTR ARRAY
Z5	1403001	2N74174	IC FF HEX TYPE D
Z6 - 7	1405601	2N74145	IC DECODER