

# AKAI SERVICE MANUAL



## PROGRAMMABLE MATRIX SYNTHESIZER

## MODEL VX600

CAUTION: Before servicing, to protect customer's program data from being damaged, save all data to IC memory card.

### SPECIFICATIONS

Model	Programmable matrix analog synthesizer	POWER SWITCH	
Key board	37-key C-C scale(with dynamics velocity and key pressure functions)	MEMORY PROTECT SWITCH	
Simultaneous sounds	6 voices	CONTRAST	
Sound source	12 VCO/2 VCO group	Connection terminals	
Display	40 characters x 8 lines,liquid crystal graphic display	INSTRUMENT	Special multi-connector for AKAI EW11000/EV1000
Internal memory	Battery back up type	EXTERNAL IN	Standard phone jack x2
Packet	10x20 programs	LINE OUT	Standard phone jack
Library	50 tones	PHONES	Standard stereo phone jack (monaural)
Program	40 programs	VOICE OUT	DIN /13 pin
Chord	20 patterns	PROGRAM	
External memory	Compatible with IC memory card	UP/DOWN	Standard stereo phone jack(for foot switch)
Packet	(AKAI BR-16/16K' bytes)	PEDAL 1	Standard stereo phone jack(for pedal switch)
Library	10x20 programs x2	PEDAL 2	Standard stereo phone jack(for pedal volume)
Library	50 tones x2	MIDI IN/OUT/THRU	DIN /5 pin
Program	40 programs x2	I/O PORT	For expansion.(cover is currently installed)
Chord	20 patterns x2	Power requiament	AC 100V, 50/60Hz for japan AC 120V, 60Hz for USA and canada AC 220V, 50Hz for europe except UK AC 240V, 50Hz for UK and australia
Function	BEND ADJUST/WIDTH GLIDE ADJUST/TIME BREATH ADJUST/SENSE VIBRATE VOLUME CONTROL KNOB CURSOR KEY(Δ ∇ ◀ ▶) TEN KEY MENU KEY ENTER KEY SOFT KEY	Power consumption	21 W
		External dimensions	602(W)x116(H) x305(D) mm
		Weight	8.2 kg

\* For improvement purposes, specifications and design are subject to change without notice.

## ★ SAFETY INSTRUCTIONS

### PRECAUTIONS DURING SERVICING

- Parts identified by the ⚠ (\*) symbol parts are critical for safety. Replace only with parts number specified.
- In addition to safety, other parts and assemblies are specified for conformance with such regulations as those applying to spurious radiation.  
These must also be replaced only with specified replacements.  
Examples: RF converters, tuner units, antenna selector switches, RF cables, noise blocking capacitors, noise blocking filters, etc.
- Use specified internal wiring. Note especially:
  - Wires covered with PVC tubing
  - Double insulated wires
  - High voltage leads
- Use specified insulating materials for hazardous live parts. Note especially:
  - Insulation Tape
  - PVC tubing
  - Spacers (Insulating Barriers)
  - Insulation sheets for transistors
  - Plastic screws for fixing microswitch (especially in turntable)
- When replacing AC primary side components (transformers, power cords, noise blocking capacitors, etc.), wrap ends of wires securely about the terminals before soldering.

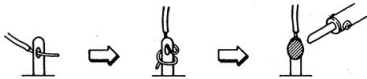

- Observe that wires do not contact heat producing parts (heatsinks, oxide metal film resistors, fusible resistors, etc.).

- Check that replaced wires do not contact sharp edged or pointed parts.
- Also check areas surrounding repaired locations.
- Use care that foreign objects (screws, solder droplets, etc.) do not remain inside the set.

### SAFETY CHECK AFTER SERVICING

After servicing, make measurements of leakage-current or resistance in order to determine that exposed parts are acceptably insulated from the supply circuit.

The leakage-current measurement should be done between accessible metal parts (such as chassis, ground terminal, microphone jacks, signal-input/output connectors, etc.) and the earth ground through a resistor of 1500 ohms paralleled with a 0.15  $\mu\text{F}$  capacitor, under the unit's normal working conditions. The leakage-current should be less than 0.5 mA rms AC.

The resistance measurement should be done between accessible exposed metal parts and power cord plug prongs with the power switch (if included) "ON". The resistance should be more than 2.2 Mohms.

### PRECAUTIONS FOR LITHIUM BATTERY

The lithium battery may explode when heated excessively. [OBSERVE THE FOLLOWING WHEN REPLACING]

- Replace with the same make and type only.
- Use soldering iron in "recommended way" only.
- Place battery in correct polarity.
- Do not short the terminals.
- Do not recharge battery.
- Do not dispose of battery in fire.



[DANGER]



[RECOMMENDED WAY]

## ★ INFORMATION

### SYMBOLS FOR PRIMARY DESTINATION

Alphabet indicates the destination of the units as listed below.

Symbols	Principal Destinations
[A]	USA
[B]	UK
[C]	Canada
[E]	Europe (except UK)
[J]	Japan
[S]	Australia
[V]	W. Germany only
[U]	Universal Area
[Y*]	Custom version

### VOLTAGE CONVERSION

(E, V, B, S Model only)

Before connecting the power cord. Set the VOLTAGE SELECTOR located on the bottom plate with a screw-driver so that the correct voltage is indicated.

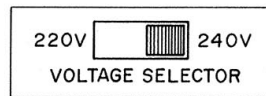

## I. CONTROL

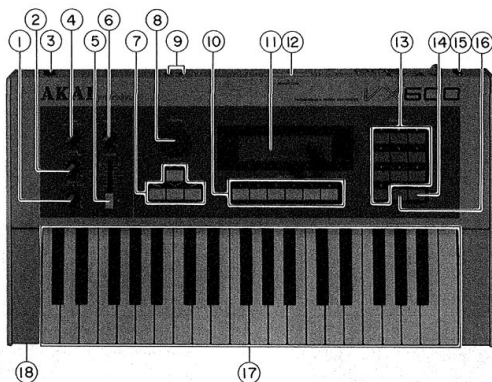

Fig. 1-1 View from the top

① BREATH ADJUST/SENSE control

This is used when using with the AKAI electric wind/valve instrument model EW11000/EV11000. There is a knob (ADJUST) to adjust the sensitivity of the breath sensor and a knob (SENSE) to set the operation point appropriate for the player's breath pressure.

② GLIDE ADJUST/TIME control

This is used when using with the AKAI electric wind/valve instrument model EW11000/EV11000. There is a knob (ADJUST) to adjust the sensitivity of the glide controllers, and a knob (TIME) to adjust the glide time.

③ INSTRUMENT connector

This terminal is used to connect the EW11000 or EV11000 unit when playing the AKAI electric wind/valve instrument. Use the connection cable included with the EW11000 or EV11000, or the AKAI EW-X70 (for the EW11000) or the AKAI EV-X70 (for the EV11000) extension cable.

④ BEND ADJUST/WIDTH control

This is used when using with the AKAI electric wind/valve instrument model EW11000/EV11000. There is a knob (ADJUST) to adjust the sensitivity of the bend controllers, and a knob (WIDTH) to adjust the bend width.

⑤ VOLUME control

This is used to adjust the output level of the VX600.

⑥ VIBRATE control

This knob is used to adjust vibrate and tremolo when using the AKAI electric wind/valve instrument.

⑦ CURSOR key

These keys are used to increase or decrease the "octave shift" and to move the "cursor".

⑧ CONTROL knob

This knob is used to set the "VALUE" of the various parameters, and scroll the "MENU". It is also used to "input characters" for tone names, library names, packet names, etc..

⑨ EXT IN

When playing with the external source such as a digital sampler, etc.. This external input terminal can be used to process the tone and volume of the external source with the VX600.

⑩ SOFT keys

These are "soft keys" which have different functions according to the screen which is displayed.

⑪ DISPLAY

This display is used to show the program menu, and various program editing screens.

⑫ MEMORY CARD port

This is the port for the "memory card". Use the AKAI "BR-16" memory cards.

⑬ TEN key

These keys are used to set the "VALUE" of the various parameters, input "LIBRARY NUMBERS" and "PACKET NUMBERS".

⑭ ENTER key

This key is used to call the mode specified by the cursor, and register items.

⑮ POWER switch

This switch used to turn the power ON and OFF.

⑯ MENU key

This is used to call the "MENU WINDOW".

⑰ KEY BOARD

This is a 37 key keyboard (C-C scale) which has dynamic velocity and key pressure functions.

⑱ PHONES jack

A headphone set can be used to monitor. The volume output to the headphone is adjusted with "VOLUME" control.

## II. DISASSEMBLY

In case of trouble, etc. necessitating dismantling, please dismantle in the order shown in the photographs. Reassemble in the reverse order.

### 1-1. HOW TO OPEN THE TOP(CONTROL) PANEL.

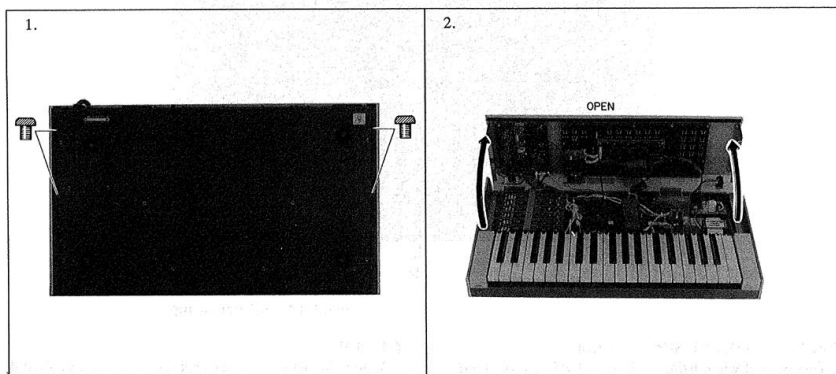

### 1-2. HOW TO DISMANTLE THE KEYBOARD BLOCK.

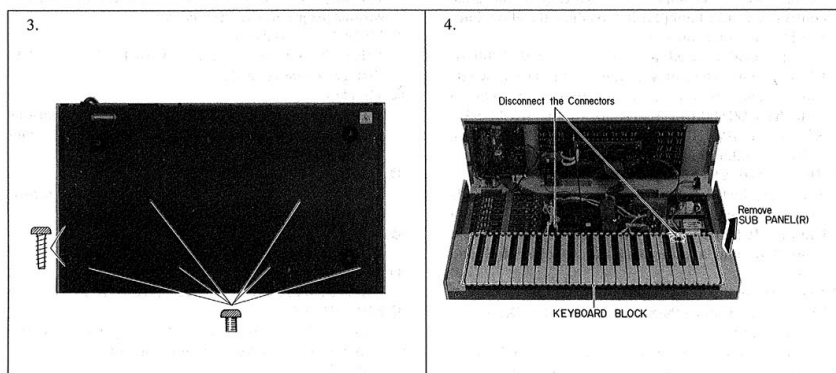

### III. PRINCIPAL PARTS LOCATION

---

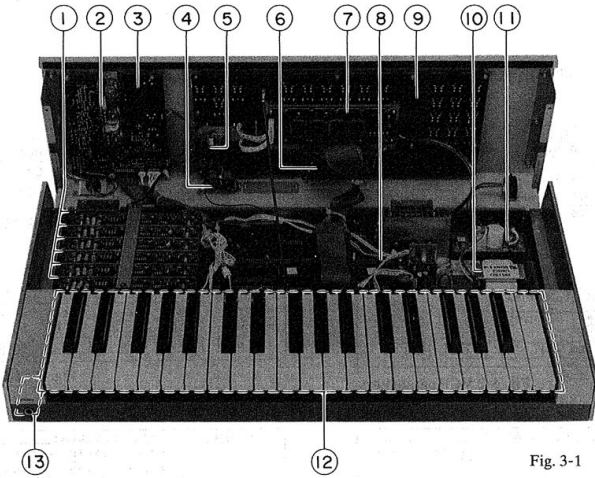

Fig. 3-1

- ① VOICE PCBs
- ② VR PCB
- ③ OPERATION (B) PCB
- ④ EXT IN JACK PCB
- ⑤ ENCODER PCB
- ⑥ MEMORY CARD PCB
- ⑦ LCD BLOCK

- ⑧ CPU PCB
- ⑨ OPERATION (A) PCB
- ⑩ POWER TRANSFORMER
- ⑪ FILTER PCB
- ⑫ KEYBOARD BLOCK
- ⑬ HEADPHONE PCB

# IV. ELECTRICAL ADJUSTMENT

## 4-1. BEFOR ADJUSTMENT

When adjusting the model VX600, each adjustment requires a particular setting of parameters and modulation matrix. Before adjustment, edit the library which used for the adjustment according to the following procedure and save them to the memory card.

[L01: For VIBRATE OFF-SET adjustment]

```

CARD-B      L01 [ E, VIBRAT ]
FREQ= 00 VCO-1 [SYNCOFF] VCO-2 FREQ= 00
FINE= 00 ----- BALANCE=50 ----- FINE= 00
WAVE= [N] [ ] [ ] [ ]
PW= 00 ----- PW= 00
[VCO] [FM] [EG] [LFO] [MOD] [QUIT]
    
```

Fig. 4-1 VCO parameters

```

CARD-B      L01 [ E, VIBRAT ]
<EG1> 00 00 80 80 80 40 80 80
<EG2> 00 00 80 80 80 40 80 80
<EG3> 00 20 30 30 80 40 80 00
[VCO] [VCF] [FM] [LFO] [MOD] [QUIT]
    
```

Fig. 4-4 EG parameters

```

CARD-B      L01 [ E, VIBRAT ]
CUTOFF=-----99-----VCF-----
PITCH=-----99-----HIGH PASS FILTER= 00
[ ] [ ] [ ] [ ] [ ] [ ]
[VCO] [FM] [EG] [LFO] [MOD] [QUIT]
    
```

Fig. 4-2 VCF parameters

```

CARD-B      L01 [ E, VIBRAT ]
<LFO1> WAVE SPEED DELAY DEPTH
[VCO] [VCF] [FM] [EG] [MOD] [QUIT]
    
```

Fig. 4-5 LFO parameters

```

CARD-B      L01 [ E, VIBRAT ]
FM-----VCA-----
DEPTH=00-----LEVEL=99
DESTINATION=-----UCO2=5OFF
[VCO] [VCF] [EG] [LFO] [MOD] [QUIT]
    
```

Fig. 4-3 FM/VCA parameters

```

CARD-B      L01 [ E, VIBRAT ]
---MOD---SOURCE---DEPTH---DESTINATION---
01: [ KEY GATE ] +99 [ VCA AMP ]
03: [ VIBRATE ] +80 [ VCO1.2 FRQ ]
[VCO] [VCF] [FM] [EG] [LFO] [QUIT]
    
```

Fig. 4-6 MOD. matrix

[L02: For AFTER TOUCH adjustment]

```

CARD-B      L02 [ PRESSURE ]
FREQ= 00 VCO-1 [SYNCOFF] VCO-2 FREQ= 00
FINE= 00 ----- BALANCE=50 ----- FINE= 00
WAVE= [N] [ ] [ ] [ ]
PW= 00 ----- PW= 00
[VCO] [FM] [EG] [LFO] [MOD] [QUIT]
    
```

Fig. 4-7 VCO parameters

```

CARD-B      L02 [ PRESSURE ]
<EG1> 00 00 80 80 80 40 80 80
<EG2> 00 00 80 80 80 40 80 80
<EG3> 00 20 30 30 80 40 80 00
[VCO] [VCF] [FM] [LFO] [MOD] [QUIT]
    
```

Fig. 4-10 EG parameters

```

CARD-B      L02 [ PRESSURE ]
CUTOFF=-----94-----VCF-----
RESONANCE=-----90-----HIGH PASS FILTER= 00
PITCH=-----90-----[ ] [ ] [ ] [ ]
[VCO] [FM] [EG] [LFO] [MOD] [QUIT]
    
```

Fig. 4-8 VCF parameters

```

CARD-B      L02 [ PRESSURE ]
<LFO1> WAVE SPEED DELAY DEPTH
[VCO] [VCF] [FM] [EG] [MOD] [QUIT]
    
```

Fig. 4-11 LFO parameters

```

CARD-B      L02 [ PRESSURE ]
FM-----VCA-----
DEPTH=00-----LEVEL=99
DESTINATION=-----UCO2=5OFF
[VCO] [VCF] [EG] [LFO] [MOD] [QUIT]
    
```

Fig. 4-9 FM/VCA parameters

```

CARD-B      L02 [ PRESSURE ]
---MOD---SOURCE---DEPTH---DESTINATION---
01: [ KEY GATE ] +99 [ VCA AMP ]
03: [ PRESSURE ] +48 [ CUTOFF ]
[VCO] [VCF] [FM] [EG] [LFO] [QUIT]
    
```

Fig. 4-12 MOD. matrix

[L03: For DAC OUTPUT LEVEL adjustment]

CARD-B		L03 [ V1 ]	
FREQ= 00	VCO-1	[SYNCOFF]	VCO-2 FREQ= 00
FINE= 00			FINE= 00
WAVE= [N]		BALANCE=50	
PW= 00			PW= 00
[VCO]	[FM]	[EG]	[LFO] [MOD] [QUIT]

Fig. 4-13 VCO parameters

CARD-B		L03 [ V1 ]	
CUTOFF=		VCF	HIGH PASS FILTER= 00
RESONANCE=	99		
PITCH FOLLOW=	00		
[VCO]	[FM]	[EG]	[LFO] [MOD] [QUIT]

Fig. 4-14 VCF parameters

CARD-B		L03 [ V1 ]	
FM		VCA	LEVEL=99
DEPTH=	00		
DESTINATION=			
UC02=	SOFF		
[VCO]	[VCF]	[EG]	[LFO] [MOD] [QUIT]

Fig. 4-15 FM/VCA parameters

CARD-B		L03 [ V1 ]	
<LEG1>	DLY	ATK	DCY1
<LEG2>	DCY2	SUS	RES
<LEG3>	DEP	VEL	
	00	00	00
	00	00	00
	20	30	60
	40	99	00
[VCO]	[VCF]	[FM]	[LFO] [MOD] [QUIT]

Fig. 4-16 EG parameters

CARD-B		L03 [ V1 ]	
<LF01>	WAVE	SPEED	DELAY
<LF02>		00	04
		20	00
			99
[VCO]	[VCF]	[FM]	[EG] [MOD] [QUIT]

Fig. 4-17 LFO parameters

CARD-B		L03 [ V1 ]	
MOD	SOURCE	DEPTH	DESTINATION
01:	[ KEY GATE ]	+99	[ VCA AMP ]
02:	[ KEY GATE ]	00	[ ]
[VCO]	[VCF]	[FM]	[EG] [LFO] [QUIT]

Fig. 4-18 MOD. matrix

[L04: For NOISE OUTPUT LEVEL adjustment]

CARD-B		L04 [ V2, NOISE ]	
FREQ= 00	VCO-1	[SYNCOFF]	VCO-2 FREQ= 00
FINE= 00			FINE= 00
WAVE= [N]		BALANCE=50	
PW= 00			PW= 00
[VCO]	[FM]	[EG]	[LFO] [MOD] [QUIT]

Fig. 4-19 VCO parameters

CARD-B		L04 [ V2, NOISE ]	
CUTOFF=		VCF	HIGH PASS FILTER= 00
RESONANCE=	99		
PITCH FOLLOW=	00		
[VCO]	[FM]	[EG]	[LFO] [MOD] [QUIT]

Fig. 4-20 VCF parameters

CARD-B		L04 [ V2, NOISE ]	
FM		VCA	LEVEL=99
DEPTH=	00		
DESTINATION=			
UC02=	SOFF		
[VCO]	[VCF]	[EG]	[LFO] [MOD] [QUIT]

Fig. 4-21 FM/VCA parameters

CARD-B		L04 [ V2, NOISE ]	
<LEG1>	DLY	ATK	DCY1
<LEG2>	DCY2	SUS	RES
<LEG3>	DEP	VEL	
	00	00	00
	00	00	00
	20	30	60
	40	99	00
[VCO]	[VCF]	[FM]	[LFO] [MOD] [QUIT]

Fig. 4-22 EG parameters

CARD-B		L04 [ V2, NOISE ]	
<LF01>	WAVE	SPEED	DELAY
<LF02>		00	04
		20	00
			99
[VCO]	[VCF]	[FM]	[EG] [MOD] [QUIT]

Fig. 4-23 LFO parameters

CARD-B		L04 [ V2, NOISE ]	
MOD	SOURCE	DEPTH	DESTINATION
01:	[ KEY GATE ]	+99	[ VCA AMP ]
02:	[ KEY GATE ]	00	[ ]
[VCO]	[VCF]	[FM]	[EG] [LFO] [QUIT]

Fig. 4-24 MOD. matrix

## 4-2. INSTRUMENT CONNECTION

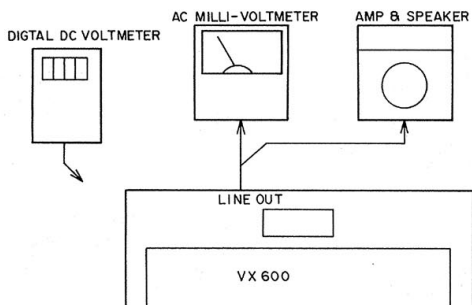
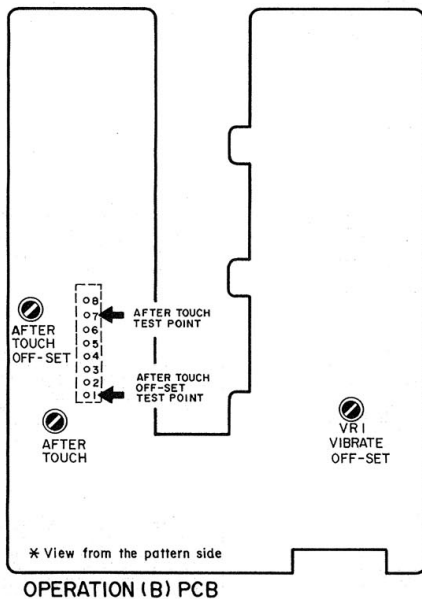

Fig. 4-25 Instrument connection

## 4-3. ADJUSTMENT OF THE OPERATION (B) PC BOARD.



OPERATION (B) PCB

Fig. 4-26 Adjustment points of the OPERATION (B) PCB.



#### 4-3-1. VIBRATE OFF-SET adjustment

- 1) Set the memory card which made in the step 4-1. BEFORE ADJUSTMENT, and select library to "L01 [ E, VIBRATE ]".
- 2) While pressing the "C5" key, turn the VIBRATE control knob fully clockwith and counter clockwith.
- 3) If the tone is changed, when the VIBRATE control knob is turning fully clockwith and counter clockwith, adjust VR1(VIBRATE OFF-SET) so that the tone is not changed.

#### 4-3-2. AFTER TOUCH adjustment

- 1) Select the library to "L02 [ PRESSURE ]" and connect a digital DC voltmeter between pin ① of the IC1(M5218L) and GND.
- 2) Adjust VR3(AFTER TOUCH OFF-SET) so that the reading on the digital DC voltmeter is 0 V.
- 3) Connect a DC voltmeter between pin ② of the IC1(M5218L) and GND. At this time confirm that the reading voltage is more than 4.8 V.
- 4) While pressing the lightest key by about 200g presure, adjust VR2(AFTER TOUCH) so that the reading voltage is decreased to nearly 0 V.

#### 4-4. ADJUSTMENT OF THE CPU PC BOARD

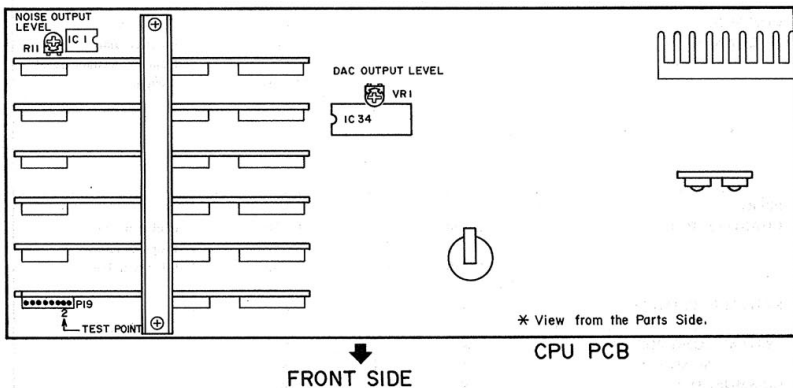

Fig. 4-27 Adjustment points of the CPU PCB

#### 4-4-1. DAC OUTPUT LEVEL adjustment

- 1) Select the library to "L03 [ V1, ]" and connect a digital DC voltmeter between pin ② of the connector P19 and GND (refer to Fig. 4-27).
- 2) Adjust VR1(DAC OUTPUT LEVEL) so that the reading on the digital DC voltmeter is 2.5 V.

#### 4-4-2. NOISE OUTPUT LEVEL adjustment

- 1) Select the library to "L04 [ V2, NOISE ]", and connect an AC milli-voltmeter to LINE OUT.
- 2) While pressing the any key, adjust R11(NOISE OUTPUT LEVEL) so that the reading on the AC milli-voltmeter is -8 dBm.

[NOTE]: Adjustment volume R11(NOISE OUTPUT LEVEL) is not included on some models.

## V. MIDI IMPLEMENTAION CHART

[PROGRAMABLE MATRIX SYNTHESIZER]

Model VX600

MIDI Implementation Chart Version : 1.00

FUNCTION	TRANSMITTED	RECOGNIZED	REMARKS
BASIC DEFAULT CHANNEL CHANGED	1 - 16 1 - 16	1 - 16 1 - 16	Memorized
MODE DEFAULT MESSAGES ALTERED	Mode 3	× × ×	
NOTE NUMBER : True voice	24 - 108	24 - 108	Octave shift
VELOCITY NOTE ON NOTE OFF	9nH V=1 - 127 9nH V=0 ,8nH	○ ○	
After KEY'S Touch CH'S	× ○	× ○	
PINCH BENDER	○	○	
CONTROL 4 CHANGE 7 64	○ ○ ○	○ ○ ○ 00 - 31	Foot pedal Main volume Damper, Sustain pedal Assignable
PROG CHANGE : TRUE #	1 - 20 1 - 40 1 - 50	1 - 20 1 - 40 1 - 50	Packet mode Program mode Library mdoe
SYSTEM EXCLUSIVE	×	×	
SYSTEM : SONG POS SONG SEL COMMON: TUNE	× × ×	× × ×	
SYSTEM : CLOCK REAL TIME : COMMANDS	× ×	× ×	
AUX : LOCAL ON/OFF ALL NOTES OFF MES- : ACTIVE SENSE SAGES : RESTE	× ○ × ×	× ○ × ×	
Notes			

MODE 1 : OMNI ON, POLY  
MODE 3 : OMNI OFF, POLY

MODE 2 : MONI ON, MONO  
MODE 4 : 4MONI OFF, MONO

○=YES  
×=NO

SERVICE MANUAL

## VI. PARTS LIST

### ATTENTION

- When placing an order for parts, be sure to list Part No., Model No. and the description of each part. Otherwise, the non-delivery of the part or the delivery of a wrong part may result.
- Please make sure that Part No. is correct when ordering. If not, a part different from the one you ordered may be delivered.
- Since the parts shown in Parts List of Preliminary Service Manual may have been the subject of changes, please use this Parts List for all future reference.

### HOW TO USE THIS PARTS LIST

- This Parts List lists those parts which are considered necessary for repairs. Other common parts, such as resistors and capacitors, are listed in the "Common List for Service Parts" from which these parts should be selected and stocked.
- The Recommended Spare Parts List shows those parts in the Parts List which are considered particularly important for service.
- Parts not shown in the Parts List and "Common List for Service Parts" will not in principle be supplied.
- How to read the Parts List.

#### a) Mechanism Block

### 2. HEAD BASE BLOCK

REF. NO.	PART NO.	DESCRIPTION
1	BH-T2023A320A	HEAD BASE BLOCK
2	HP-H2206A010A	HEAD R/P PR4-8FU C
3	ZS-477876	PAN20X03STL CMT
4	ZS-536488	BID20X08STL CMT
5	ZG-402895	SP CS ANGLE ADJUST

#### b) PC Board

### 6. MAIN PC BOARD

REF. NO.	PART NO.	DESCRIPTION
IC1	EI-324536	IC HD14049BP
IC2	EI-336801	IC MB8841-564M
C1A	EC-338399	C MMY V 223M 250AC [U,E,B,S]
C1B	EC-350949	C MMY V 223M 250DC [J]
C1C	EC-338397	C MMY V 223M 125AC [C,A]
X1	EI-318384	OSC XTAL NC-18C

**Symbols for primary destination**  
 [A] : AAL (U.S.A)      [S] : SAA (Australia)  
 [B] : BEAB (England) [U] : U/T (Universa  
 [C] : CSA (Canada)      Area  
 [E] : CEE (Europe)      [V] : VDE (W. Germany)  
 [J] : JPN (Janan)      [Y] : Custom Version

**SP (Service Parts) Classification**  
 These reference symbols correspond with component symbols in the Schematic Diagrams.

The available PC Board Blocks are listed separately.

- When Part No. is known, Parts Index at end of Parts List can be used to locate where that part is shown in Parts List by its Reference No. listed at right of Part No.

### WARNING

△(\*) INDICATES SAFETY CRITICAL COMPONENTS. FOR CONTINUED SAFETY, REPLACE SAFETY CRITICAL COMPONENTS ONLY WITH MANUFACTURE'S RECOMMENDED PARTS.

### AVERTISSEMENT

△(\*) IL INDIQUE LES COMPOSANTS CRITIQUES DE SÉCURITÉ. POUR MAINTENIR LE DEGRÉ DE SÉCURITÉ DE L'APPAREIL, NE REMPLACER QUE DES PIÈCES RECOMMANDÉES PAR LE FABRICANT.

## 1. RECOMMENDED SPARE PARTS

We suggest you to stock the following Recommended Spare Part items listed below since they can cover most of the routine service.

Ref. No.	Part No.	Description
1	*BT-383927J	TRANS POW L1023 C,A [C,A,Y1]
2	*BT-383928J	TRANS POW L1023 E,V,B,S [E,V,B,S]
3	*BT-383926J	TRANS POW L1023 J [J]
4	*BT-383935J	TRANS PULSE 2E16-1001-01
5	ED-376335	D SCHOTTKY SB02-03 T05
6	*ED-357036	D SILICON DBA20B-K15 100/ 2.0A
7	*ED-357038	D SILICON DBB10B 100/ 1.0A
8	ED-301911	D SILICON H DS448
9	ED-344280	D SILICON H GMA-01-FY2 F05
10	ED-346536	D ZENER H HZ7C3L
11	*EF-355385	FUSE BET T 250V 315MA [B]
12	*EF-355374	FUSE BET T 250V 500MA [B]
13	*EF-358974	FUSE BET T 250V 630MA [B]
14	*EF-695766	FUSE SEMKO T 250V 315MA [E,V,S]
15	*EF-593706	FUSE SEMKO T 250V 500MA [E,V,S]
16	*EF-601942	FUSE SEMKO T 250V 630MA [E,V,S]
17	*EF-306124	FUSE TSC A 250V 630MA [J]
18	*EF-309388	FUSE TSC A 250V 800MA [J]
19	*EF-305703	FUSE TSC 125V 630MA [C,A,Y1]
20	*EF-309391	FUSE TSC 125V 800MA [C,A,Y1]
21	EH-370520	COMP C EXF-P8102ZW
22	EH-351973	COMP R RKCI/8B4 472J
23	EH-353789	COMP R RKCI/8B6 103J
24	EH-359185	COMP R RKCI/8B8 103J
25	EH-379500	FILTER EMX EMC-EMT102BC
26	*EI-380920J	IC AN6531
27	*EI-380921J	IC AN6535
28	*EI-380919J	IC AN79L12
29	EI-380918J	IC CEM3374
30	EI-385445J	IC CEM3378
31	EI-389660	IC CXK5816FN-12L
32	EI-375437	IC LC3864NL-10
33	EI-378276	IC LC7981
34	EI-375347	IC MM74HC14N
35	EI-375345	IC MM74HC373N
36	EI-375439	IC MS206P
37	EI-353227	IC MS216L
38	EI-346071	IC MS218L-21
39	EI-349719	IC MS218P
40	*EI-359552	IC MS238L
41	EI-362598	IC MS239P
42	EI-364275	IC M74LS05P
43	EI-364247	IC NUM13600
44	EI-385444J	IC NMC27C256Q200 [BLANK ROM]
45	EI-389670J5	IC NMC27C256Q200 VX600-1.V1.15 (PROGRAMMED ROM)
46	EI-380948J	IC NMC27C84Q200 [BLANK ROM]
47	EI-388249J2	IC NMC27C84Q200 VX600-2.V1.12 (PROGRAMMED ROM)
48	EI-378297	IC PCM54HP
49	EI-364253	IC PST520D-2
50	EI-376178	IC SSM2300
51	EI-302233	IC TC4051SP
52	EI-200573	IC TC4095BP
53	EI-310036	IC TC4096BP
54	EI-380040	IC TC74HCU04P
55	EI-380037J1	IC TC74HC00AP
56	EI-380026J1	IC TC74HC04AP
57	EI-375222	IC TC74HC125P

Ref. No.	Part No.	Description
58	EI-356049	IC TC74HC139P
59	EI-375220	IC TC74HC154P
60	EI-360053	IC TC74HC175P
61	EI-360029	IC TC74HC244P
62	EI-360032J1	IC TC74HC245AP
63	EI-360047	IC TC74HC374P
64	EI-370487	IC TC74HC42P
65	EI-360028	IC TC74HC74P
66	EI-371671	IC UPD78C11G-044-36
67	EI-380939J	IC UPD78310G-36
68	EI-354146	IC UPD8253C-2
69	EI-364257	OSC XTAL NR-18
70	EM-382317J	IND LCD EDM1245633B
71	*EO-380068	COIL L F LF-2 B
72	*ER-200972	R FUSE H S10 ERD2FC 1/4W 33R0G
73	*ER-360725	R OMF H S12 FS 1W 221J
74	ES-380946J	ROTARY ENCORDER EC16B25D
75	ES-364255	SW SLIDE SSP322 [MEMORY PROTECT SW] SW TACT SKHHAM004A
76	ES-349474	VOLTAGE SELECTOR SW DETECTOR PC900V
77	ES-306430	TR 25B1142
78	ET-354167	TR 25C3245 D,E
79	*ET-375446	TR 25C330 U,V F05
80	ET-349883	TR 25C330 U,V F05
81	ET-380137	TR 25C3400 F05
82	ET-349592	TR 25C3400 F05
83	EV-385801J	VR ROTARY EWJCGAS22364B103B503 [BEND]
84	EV-365865	VR ROTARY V012LPH B202 L-20 [CONTRAST VR]
85	EV-365876	VR SLIDE V4513-2PVNB5 103 [VOLUME]
86	EZ-358816	BATTERY LITHIUM BR2032-1HF

## 2. P.C BOARD BLOCK

Ref. No.	Part No.	Description
1	BA-L1023A020A	PC CPU BLK VX600
2	BA-L1023A030A	PC VOICE BLK VX600
3	BA-L1023A040A	PC(4#)OPERATION BLK VX600

PC (#) OPERATION BLK CONSISTS OF FOLLOWING P.C BOARD.

- \* OPERATION (A) P.C BOARD
- \* OPERATION (B) P.C BOARD
- \* VR P.C BOARD
- \* OPERATION (D) P.C BOARD
- \* HEADPHONE P.C BOARD
- \* ENCORDER P.C BOARD
- \* OPERATION (G) P.C BOARD

## PARTS LIST

### 3. CPU P.C BOARD

Ref. No.	Part No.	Description
BT1	EZ-358816	BATTERY LITHIUM BR2032-1HF
EC122	EC-368716	C EC V CUT SR-AKY 102M 25.00C
C123	EC-368716	C EC V CUT SR-AKY 102M 25.00C
C126	EC-368719	C EC V CUT SR-TIK 472M 16.00C
CR1	EH-370520	COMP C EXF-P81022W
CR2	EH-359185	COMP R RKC1/88B 103J
CR3	EH-353789	COMP R RKC1/88B 103J
CR4	EH-351973	COMP R RKC1/88A 472J
D1	*ED-357038	D SILICON DBB10B 100/ 1.0A
D2	*ED-357038	D SILICON DBA20B-K15 100/ 2.0A
D4	ED-344280	D SILICON H GMA-01-FY2 F05
D5	ED-344280	D SILICON H GMA-01-FY2 F05
D6	ED-344280	D SILICON H GMA-01-FY2 F05
D7	ED-344280	D SILICON H GMA-01-FY2 F05
D8	ED-344280	D SILICON H GMA-01-FY2 F05
D9	ED-344280	D SILICON H GMA-01-FY2 F05
D10	ED-344280	D SILICON H GMA-01-FY2 F05
D11	ED-344280	D SILICON H GMA-01-FY2 F05
D12	ED-346536	D ZENER H HZ7C3L
D13	ED-301911	D SILICON H DS448
D14	ED-344280	D SILICON H GMA-01-FY2 F05
D15	ED-301911	D SILICON H DS448
D19	ED-344280	D SILICON H GMA-01-FY2 F05
D17	ED-344280	D SILICON H GMA-01-FY2 F05
D18	ED-344280	D SILICON H GMA-01-FY2 F05
D19	ED-344280	D SILICON H GMA-01-FY2 F05
D20	ED-344280	D SILICON H GMA-01-FY2 F05
D21	ED-301911	D SILICON H DS448
FL1	EH-379500	FILTER EMI EXC-EMT102BC
FL2	EH-379500	FILTER EMI EXC-EMT102BC
FL3	EH-379500	FILTER EMI EXC-EMT102BC
FL4	EH-379500	FILTER EMI EXC-EMT102BC
FL5	EH-379500	FILTER EMI EXC-EMT102BC
FL6	EH-379500	FILTER EMI EXC-EMT102BC
FL7	EH-379500	FILTER EMI EXC-EMT102BC
FL8	EH-379500	FILTER EMI EXC-EMT102BC
FL9	EH-379500	FILTER EMI EXC-EMT102BC
FL10	EH-379500	FILTER EMI EXC-EMT102BC
FL11	EH-379500	FILTER EMI EXC-EMT102BC
IC1	EI-349719	IC M5218P
IC2	EI-349719	IC M5218P
IC3	EI-310036	IC TC0A66BP
IC4	EI-353227	IC M5216L
IC5	EI-362588	IC M5238P
IC6	EI-364247	IC NJM13600
IC7	EI-362588	IC M5238P
IC8	EI-360047	IC TC74HC374P
IC9	EI-360047	IC TC74HC374P
IC10	EI-376178	IC SSM2300
IC11	EI-376178	IC SSM2300
IC12	EI-376178	IC SSM2300
IC13	EI-376178	IC SSM2300
IC14	EI-376178	IC SSM2300
IC15	EI-362588	IC M5238P
IC16	EI-364247	IC NJM13600
IC17	EI-362588	IC M5238P
IC18	EI-360047	IC TC74HC374P
IC19	EI-360047	IC TC74HC374P
IC20	EI-376178	IC SSM2300
IC21	EI-376178	IC SSM2300
IC22	EI-376178	IC SSM2300
IC23	EI-376178	IC SSM2300
IC24	EI-362588	IC M5238P
IC25	EI-364247	IC NJM13600
IC26	EI-362588	IC M5238P
IC27	EI-360047	IC TC74HC374P
IC28	EI-360047	IC TC74HC374P
IC29	EI-349719	IC M5218P
IC31	EI-360053	IC TC74HC175P
IC32	EI-364275	IC M74LS05P
IC33	EI-360037J1	IC TC74HC00AP
IC34	EI-376297	IC PCM54HP
IC35	EI-360047	IC TC74HC374P
IC36	EI-360032J1	IC TC74HC245AP
IC37	EI-375222	IC TC74HC125P
IC38	EI-360029	IC TC74HC244P

Ref. No.	Part No.	Description
IC39	EI-360029	IC TC74HC244P
IC40	EI-302233	IC TC40518P
IC41	EI-375345	IC MM74HC373N
IC42	EI-375345	IC MM74HC373N
IC43	EI-360053	IC TC74HC175P
IC44	EI-380939J	IC UPD78310G-36
IC45	EI-389670J5	IC NMC27C256Q200 VX600-1-V1.15 [PROGRAMMED ROM]
*IC45	EI-385444J	IC NMC27C256Q200 [BLANK ROM]
IC46	EI-371671	IC UPD78C11G-044-36
IC47	EI-389240J2	IC NMC27C64Q200 VX600-2-V1.12 [PROGRAMMED ROM]
*IC47	EI-380948J	IC NMC27C64Q200 [BLANK ROM]
IC48	EI-360026J1	IC TC74HC04AP
IC49	EI-356049	IC TC74HC139P
IC50	EI-360028	IC TC74HC47AP
IC51	EI-375437	IC L33664NL-10
IC52	EI-370487	IC TC74HC42P
IC53	EI-370487	IC TC74HC42P
IC54	EI-360040	IC TC74HC004P
IC55	EI-360047	IC TC74HC374P
IC56	EI-360037J1	IC TC74HC00AP
IC57	EI-375437	IC L33664NL-10
IC58	EI-369660	IC CXK5816PN-12L
IC59	EI-375220	IC TC74HC154P
IC60	EI-375220	IC TC74HC154P
IC61	EI-354146	IC UPD8263C-2
IC62	EI-375347	IC MM74HC14N
IC63	EI-378276	IC L7C981
IC64	*EI-359552	IC M5236L
IC65	*EI-380920J	IC AN6531
IC66	*EI-380921J	IC AN6535
IC67	*EI-380920J	IC AN6531
IC68	*EI-380921J	IC AN6535
IC69	EI-364253	IC PST520D-2
IC70	*EI-380919J	IC AN79L12
IC71	EI-346071	IC M5218L-21
J1	EJ-360771	DIN J TC5037-01-241 13P [VOICE OUT]
J2	EJ-354105	PHONE J 2P HLJ0520-110 6.3 [LINE OUT]
J3	EJ-379523	PHONE J 3P HLJ4305-3080 S.NUT [PROTECT SW]
J4	EJ-354105	PHONE J 2P HLJ0520-110 6.3 [UP/DOWN]
J5	EJ-379523	PHONE J 3P HLJ4305-3080 S.NUT [PRG]
J6	EJ-364256	DIN J M1704 3P [MIDI]
L1	EO-318365	COIL FIX 1 LAL04 102K
L2	EO-318365	COIL FIX 1 LAL04 102K
PH1	ET-354167	DETECTOR PC900V
P28	EJ-365834	PLUG RK-H341TD-0190 34P
P29	EJ-365891	OLUG RA-H261TD-0190 26P
R29	ER-306805	R CB H S15 FS RDS 1/2W 101J
R30	ER-306805	R CB H S15 FS RDS 1/2W 101J
R152	*ER-360725	R CMF H S12 FS 1W 221J
R165	*ER-200972	R FUSE H S10 ERD2FC 1/4W 33R0G
RL1	EO-348929	RELAY SIG 65A-237P 2TR 12V
SW1	ES-364255	SW SLIDE SSP32 [MEMORY PROTECT SW]
T1	*BT-38935J	TRANS PULSE ZE16-1001-01
TR1	ET-360137	TR 2SC3330 U/V F05
TR2	ET-360137	TR 2SC3330 U/V F05
TR3	ET-349883	TR 2SC3243 D,E
TR4	*ET-375446	TR 2SB1142
TR5	ET-360137	TR 2SC3330 U/V F05
TR6	ET-360137	TR 2SC3330 U/V F05
TR7	ET-349592	TR 2SC3400 F05
TR8	ET-349592	TR 2SC3400 F05
TR9	ET-349592	TR 2SC3400 F05
TR10	ET-349592	TR 2SC3400 F05
TR11	ET-349592	TR 2SC3400 F05
TR12	ET-349592	TR 2SC3400 F05

PARTS LIST

Ref. No.	Part No.	Description
VR1	EV-365665	VR ROTARY V012LPH B202 L=20 [CONTRAST VR]
VR2	EV-390045J	R S-FIX H RH0421C 0.20W 332
VR3	EV-390046J	R S-FIX H RH0421C 0.20W 224
X1	EI-364257	OSC X'TAL NR-18
W201	EW-380934J	WIRE ASSY VX600 W201 26P
1	EZ-200473	SILICON RUBBER SHEET TC-30
F2	*EF-306124	FUSE TSC A 250V 630MA [J]
F3	*EF-309388	FUSE TSC A 250V 800MA [J]
F4	*EF-309388	FUSE TSC A 250V 800MA [J]
F2A	*EF-305703	FUSE TSC 125V 630MA [C.A.Y1]
F3A	*EF-309391	FUSE TSC 125V 800MA [C.A.Y1]
F4A	*EF-309391	FUSE TSC 125V 800MA [C.A.Y1]
F2B	*EF-593706	FUSE SEMKO T 250V 500MA [E.V.S]
F3B	*EF-601942	FUSE SEMKO T 250V 630MA [E.V.S]
F4B	*EF-601942	FUSE SEMKO T 250V 630MA [E.V.S]
F2C	*EF-355374	FUSE BET T 250V 500MA [B]
F3C	*EF-358974	FUSE BET T 250V 630MA [B]
F4C	*EF-358974	FUSE BET T 250V 630MA [B]

#### 4. VOICE P.C BOARD

Ref. No.	Part No.	Description
C25	EC-306445	C MC V FM 221J 500DC
C26	EC-427948	C MC V FM 100J 500DC
C29	EC-306445	C MC V FM 221J 500DC
C31	EC-306445	C MC V FM 221J 500DC
D2	ED-344280	D SILICON H GMA-01-FY2 F05
D3	ED-344280	D SILICON H GMA-01-FY2 F05
D4	ED-344280	D SILICON H GMA-01-FY2 F05
D6	ED-344280	D SILICON H GMA-01-FY2 F05
IC1	EI-380918J	IC CEM5374
IC2	EI-349719	IC M5218P
IC3	EI-310036	IC TC4066BP
IC4	EI-200573	IC TC4053BP
IC5	EI-385445J	IC CEM5378
IC6	EI-349719	IC M5218P
IC7	EI-375439	IC M5206P
IC8	EI-349719	IC M5218P

#### 5. OPERATION (A) P.C BOARD

Ref. No.	Part No.	Description
D1	ED-301911	D SILICON H DS448
D2	ED-301911	D SILICON H DS448
D3	ED-301911	D SILICON H DS448
D4	ED-301911	D SILICON H DS448
D5	ED-301911	D SILICON H DS448
D6	ED-301911	D SILICON H DS448
D7	ED-301911	D SILICON H DS448
D8	ED-301911	D SILICON H DS448
D9	ED-301911	D SILICON H DS448
D10	ED-301911	D SILICON H DS448
D11	ED-301911	D SILICON H DS448
D12	ED-301911	D SILICON H DS448
D13	ED-301911	D SILICON H DS448
D14	ED-301911	D SILICON H DS448
D15	ED-301911	D SILICON H DS448
D16	ED-301911	D SILICON H DS448
D17	ED-301911	D SILICON H DS448
D18	ED-301911	D SILICON H DS448
D19	ED-301911	D SILICON H DS448
D20	ED-301911	D SILICON H DS448
D21	ED-301911	D SILICON H DS448
D22	ED-301911	D SILICON H DS448
SW1	ES-349474	SW TACT SKH-HAM004A
SW2	ES-349474	SW TACT SKH-HAM004A
SW3	ES-349474	SW TACT SKH-HAM004A
SW4	ES-349474	SW TACT SKH-HAM004A
SW5	ES-349474	SW TACT SKH-HAM004A
SW6	ES-349474	SW TACT SKH-HAM004A
SW7	ES-349474	SW TACT SKH-HAM004A
SW8	ES-349474	SW TACT SKH-HAM004A
SW9	ES-349474	SW TACT SKH-HAM004A
SW10	ES-349474	SW TACT SKH-HAM004A
SW11	ES-349474	SW TACT SKH-HAM004A
SW12	ES-349474	SW TACT SKH-HAM004A
SW13	ES-349474	SW TACT SKH-HAM004A
SW14	ES-349474	SW TACT SKH-HAM004A
SW15	ES-349474	SW TACT SKH-HAM004A
SW16	ES-349474	SW TACT SKH-HAM004A
SW17	ES-349474	SW TACT SKH-HAM004A
SW18	ES-349474	SW TACT SKH-HAM004A
SW19	ES-349474	SW TACT SKH-HAM004A
SW20	ES-349474	SW TACT SKH-HAM004A
SW21	ES-349474	SW TACT SKH-HAM004A
SW22	ES-349474	SW TACT SKH-HAM004A
TR1	ET-349592	TR 28C3400 F05
TR2	ET-349592	TR 28C3400 F05
TR3	ET-349592	TR 28C3400 F05

#### PARTS LIST

## 6. OPERATION (B) P.C BOARD

Ref. No.	Part No.	Description
D1	ED-376335	D SCHOTTKY SB02-03 T05
D2	ED-376335	D SCHOTTKY SB02-03 T05
D3	ED-344280	D SILICON H GMA-01-FY2 F05
D4	ED-344280	D SILICON H GMA-01-FY2 F05
D5	ED-376335	D SCHOTTKY SB02-03 T05
D6	ED-376335	D SCHOTTKY SB02-03 T05
D7	ED-376335	D SCHOTTKY SB02-03 T05
D8	ED-376335	D SCHOTTKY SB02-03 T05
D9	ED-376335	D SCHOTTKY SB02-03 T05
D10	ED-376335	D SCHOTTKY SB02-03 T05
D11	ED-376335	D SCHOTTKY SB02-03 T05
D12	ED-376335	D SCHOTTKY SB02-03 T05
D13	ED-376335	D SCHOTTKY SB02-03 T05
D14	ED-376335	D SCHOTTKY SB02-03 T05
D15	ED-376335	D SCHOTTKY SB02-03 T05
D16	ED-376335	D SCHOTTKY SB02-03 T05
D17	ED-359863	D LED LN81CV(LF) AK ORANGE
D18	ED-359863	D LED LN81CV(LF) AK ORANGE
D19	ED-359863	D LED LN81CV(LF) AK ORANGE
IC1	EI-346071	IC M5218L-21
IC2	EI-346071	IC M5218L-21
IC3	EI-346071	IC M5218L-21
IC4	EI-346071	IC M5218L-21
L1	EO-318365	COIL FIX T LAL04 102K
L2	EO-318365	COIL FIX T LAL04 102K
VR1	EV-387796J	VR ROTARY EVAJ-2KA056B14 B103 [VIBRATE]
VR2	EV-356582	R S-FIX H RH0615C 0.10W 473
VR3	EV-356582	R S-FIX H RH0615C 0.10W 473
VR4	EV-356582	R S-FIX H RH0615C 0.10W 473
VR5	EV-365876	VR SLIDE VJ4513-2PVNB5 103 [VOLUME]
W101	EW-380936J	WIRE ASSY VX600 W101 26P

## 7. VR P.C BOARD

Ref. No.	Part No.	Description
VR1	EV-385801J	VR ROTARY EWJCGAS22364B103B503 [BEND]
VR2	EV-385801J	VR ROTARY EWJCGAS22364B103B503 [GLIDE]
VR3	EV-385801J	VR ROTARY EWJCGAS22364B103B503 [BREATH]

## 8. OPERATION (D) P.C BOARD

Ref. No.	Part No.	Description
J1	EJ-380944J	SOCKET 75080950 34P
W109	EW-380947J	WIRE ASSY VX600 W109 34P

## 9. HEAD PHONE P.C BOARD

Ref. No.	Part No.	Description
J1	EJ-348846	PHONE J 3P HLJ0540-010 6.3

## 10. ENCODER P.C BOARD

Ref. No.	Part No.	Description
VR1	ES-380946J	ROTARY ENCODER EC16B25D

## 11. OPERATION (G) P.C BOARD

Ref. No.	Part No.	Description
J1	EJ-354105	PHONE J 2P HLJ0520-110 6.3
J2	EJ-354105	PHONE J 2P HLJ0520-110 6.3

## 12. FILTER P.C BOARD

Ref. No.	Part No.	Description
C2	*EC-358450	C CE V DNS102MBE B 102M 400AC
C3	*EC-358450	C CE V DNS102MBE B 102M 400AC
C4	*EC-338411	C CE V DE7 FZ 103P 400AC [EXCEPT J]
C5	*EC-358450	C CE V DNS102MBE B 102M 400AC
FL1	*EO-360068	COIL LF LF-2 B
F1	*EF-306124	FUSE TSC A 250V 630MA [J]
F1A	*EF-305703	FUSE TSC 125V 630MA [C.A.Y1]
F1B	*EF-695766	FUSE SEMKO T 250V 315MA [E.V.S]
F1C	*EF-355385	FUSE BET T 250V 315MA [B]

**FINAL ASSEMBLY BLOCK**

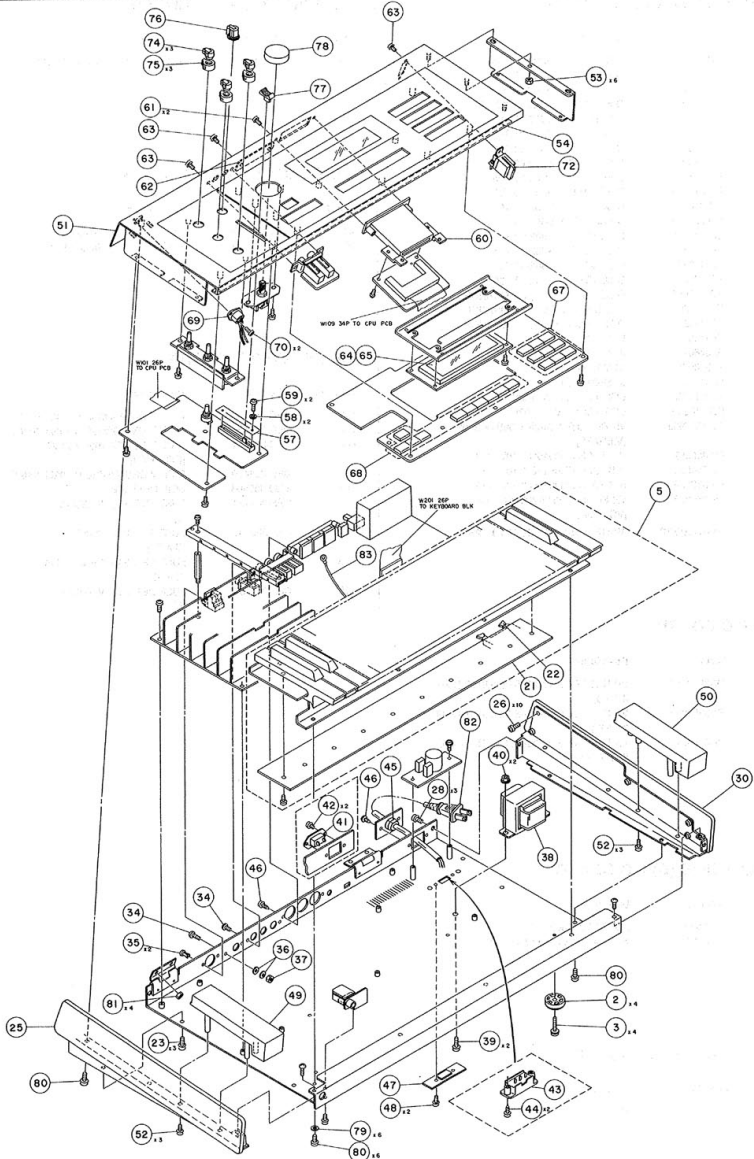

**PARTS LIST**



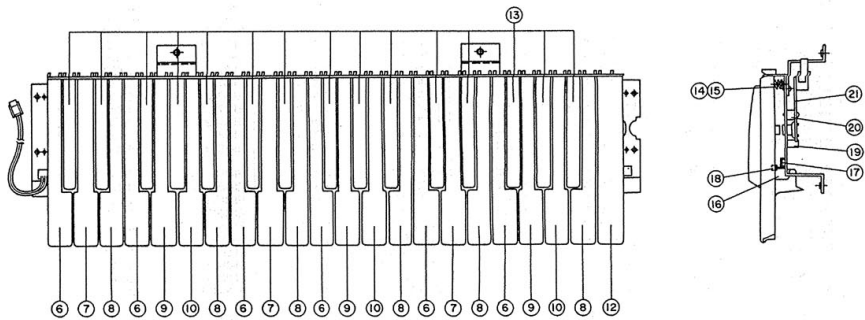

NOTE:  
Parts will not be supplied if they are not listed in the parts list,  
even if they appear on the assembling illustrations with reference  
No.

### 13. FINAL ASSEMBLY BLOCK

Ref. No.	Part No.	Description	Ref. No.	Part No.	Description		
2	SA-332850	FOOT ROUND SHAPED	49	SP-384038J	PANEL SUB(L)		
3	ZS-362533	ST PAN30X05STL CMT C080 [FOOT FIX]	50	SP-384039J	PANEL SUB(R)		
5	BK-383936J	KEYBOARD BLK ESK-832 37KEY	51	SP-383787J	PANEL FRONT PART		
6	SK-726278J	KEY WHITE CF K80	52	ZS-331532	PT BID30X08STL BNI N40STL CMT 1		
7	SK-726279J	KEY WHITE D K80	53	ZW-413188	54	SZ-384036J	MASK KEYBOARD
8	SK-726280J	KEY WHITE BE K80	57	SE-362389A-A	MASK VOLUME(A)		
9	SK-726281J	KEY WHITE G K80	58	ZW-321317	59	ZS-362286	FW21X040X05SPSL PAN20X02STL BNI
10	SK-726282J	KEY WHITE A K80	60	SE-383777J	ESCUTCHEON IC CARD		
12	SK-726277J	KEY WHITE CC K80	61	ZS-383937J	PT PAN30X08STL NI3		
13	SK-726283J	KEY BLACK E K80	62	SC-388713J	COVER CONNECTOR		
14	ZG-728398J	SP KEY BLACK K70BN27	63	ZS-593908	PAN30X06STL NI3		
15	ZG-728370J	SP KEY WHITE K70BN6	64	EM-382317J	IND LCD EDMIG245683B		
16	MZ-728371J	DAMPER K60DP79	65	EL-728382J	EDMIG245633B EL BACK LIGHT		
17	MZ-728372J	DAMPER K90DP27	67	SK-383388J	KNOB PUSH [DATA KNTRY]		
18	MB-727158J	K10 GUID GUM A	68	SK-384037J	KNOB PUSH(B) [SOFT/CURSOR KEY]		
19	MZ-728374J	ANGLE K30AG136	69	EJ-375424	PLUG EMC-TM		
20	ZW-728375J	SPEACER K30SS135	70	ZS-355818	ST BR28X04STL CMT SW SEESAW SDDTA1 T8.5 01-1 [SW POWER]		
21	BA-728376J	PC K60PB165	74	SK-383789J	KNOB DOUBLE(UPPER) PART [BEND/GLIDE/BREATH]		
22	EJ-365891	PLUG RA-H261TD-0190 26P	75	SK-383781J	KNOB DOUBLE(LOWER)		
23	ZS-388071J	ST BID40X06STL BNI	76	SK-383790J	KNOB SINGLE PART [VIBRATE]		
25	SP-383776J	COVER(L)	77	SK-383390J	KNOB SLIDE [VOLUME]		
26	ZS-417137	BID30X04STL CMT	78	SK-382429J	KNOB UPPER PART [CONTROL]		
28	ZS-341980	ST BID40X06STL BNI	79	ZW-273914	SW40		
30	SP-383786J	COVER SIDE(R)	80	ZS-537074	BID40X06STL BNI [KEYBOARD FIX]		
34	ZS-355511	BID30X06STL BNI	81	ZW-516993	N30STL CMT 1		
35	ZW-698308	RV NYL30X055 BL	82	*EW-365947	AC CORD 250 SKP210KS17B A [J]		
36	ZW-273802	TW30	82A	*EW-357931	AC CORD 3 CORES VM0033A SJT18A [C,Y1]		
37	ZW-516993	N30STL CMT 1	82B	*EW-366055	AC CORD 250 KP11WSJ18 UC [A]		
38	*BT-383926J	TRANS POW L1023 J [J]	82C	*EW-358629	AC CORD 2C KP4819C KS-17Y [E,V]		
38A	*BT-383927J	TRANS POW L1023 C,A [C,A,Y1]	82D	*EW-358631	AC CORD 2C KS-17 LTS2F BS [B]		
38B	*BT-383928J	TRANS POW L1023 E,V,B,S [E,V,B,S]	82E	*EW-358630	AC CORD 2C KP660 LTS2AF KS17 S [S]		
39	ZS-378447	ST BID40X10STL BNI [TRANS POWER FIX]	83	EW-382290	WIRE EARTH LUG 260MM 18AWG		
40	ZW-413267	N FRANGE 40STL CMT					
41	*EJ-358633	SOCKET INLET SOT-17 2P [J,E,V,B,S,Y.]					
42	ZS-311746	T2CTS30X06STL BNI					
43	*ES-306430	SW SLIDE J-S4013 #01 01-2 [VOLTAGE SELECTOR SW] [E,V,B,S]					
44	ZS-350934	PT BR030X08STL BNI					
45	EZ-302906	STRAIN RELIEF SR-6N-4 [C,A,Y.]					
46	ZS-447761	T2BR30X06STL BNI					
47	SC-383644J	COVER VOLTAGE SELECTOR [J,C,A,Y.]					
48	ZS-463353	T2BR30X08STL BNI					

PARTS LIST

# INDEX

Part No.	Ref. No.	Part No.	Ref. No.	Part No.	Ref. No.	Part No.	Ref. No.
BA-728376J	13-21	ED-376335	1-5	EI-349719	4-1C8	EI-376178	3-1C20
BA-L1023A020A	2-1	ED-376335	6-D1	EI-353227	1-37	EI-376178	3-1C21
BA-L1023A030A	2-2	ED-376335	6-D2	EI-353227	3-1C4	EI-376178	3-1C22
BA-L1023A040A	2-3	ED-376335	6-D5	EI-354146	1-68	EI-376178	3-1C23
BK-889896J	13-5	ED-376335	6-D6	EI-354146	3-1C61	EI-378276	1-33
BT-38926J	1-3	ED-376335	6-D7	EI-356049	1-58	EI-378276	3-1C63
BT-38926J	13-38	ED-376335	6-D8	EI-356049	3-1C49	EI-378297	1-48
BT-38927J	1-1	ED-376335	6-D9	EI-359552	1-40	EI-378297	3-1C34
BT-38927J	13-38A	ED-376335	6-D10	EI-359552	3-1C64	EI-38916J	1-29
BT-38928J	1-2	ED-376335	6-D11	EI-360026J1	1-56	EI-38918J	4-1C1
BT-38928J	13-38B	ED-376335	6-D12	EI-360026J1	3-1C5	EI-38919J	1-28
BT-38935J	1-4	ED-376335	6-D13	EI-360028	1-68	EI-38919J	3-1C70
BT-38935J	3-71	ED-376335	6-D14	EI-360028	3-1C50	EI-38920J	1-26
EC-306445	4-C25	ED-376335	6-D15	EI-360029	1-61	EI-38920J	3-1C55
EC-306445	4-C29	ED-376335	6-D16	EI-360029	3-1C8	EI-38920J	3-1C67
EC-306445	4-C31	EF-305703	1-19	EI-360029	3-1C39	EI-38921J	1-27
EC-358411	12-C4	EF-305703	3-F2A	EI-360032J1	1-62	EI-38921J	3-1C66
EC-358450	12-C2	EF-305703	12-F1A	EI-360032J1	3-1C36	EI-38921J	3-1C68
EC-358450	12-C3	EF-306124	1-17	EI-360037J1	1-55	EI-38933J	1-67
EC-358450	12-C5	EF-306124	3-F2	EI-360037J1	3-1C33	EI-38939J	3-1C44
EC-368716	3-C122	EF-306124	12-F1	EI-360037J1	3-1C56	EI-38948J	1-46
EC-368716	3-C123	EF-309398	1-18	EI-360040	1-54	EI-38948J	3-1C47
EC-368716	4-C126	EF-309398	3-F3	EI-360040	3-1C54	EI-38948J	3-1C48
EC-427948	4-C26	EF-309398	3-F4	EI-360047	1-63	EI-38544J	3-1C45
ED-301911	1-8	EF-309391	1-20	EI-360047	3-1C8	EI-38544J	1-30
ED-301911	3-1D3	EF-309391	3-F3A	EI-360047	3-1C9	EI-38544J	4-1C5
ED-301911	3-1D5	EF-309391	3-F4A	EI-360047	3-1C18	EI-38824J2	1-47
ED-301911	3-1D1	EF-355374	1-12	EI-360047	3-1C19	EI-389670J	3-1C47
ED-301911	5-01	EF-355374	3-F2C	EI-360047	3-1C27	EI-389670J3	1-45
ED-301911	5-02	EF-355385	1-11	EI-360047	3-1C28	EI-389670J3	3-1C45
ED-301911	5-03	EF-355385	12-F1C	EI-360047	3-1C35	EJ-34846	9-1J
ED-301911	5-04	EF-359874	1-13	EI-360053	3-1C55	EJ-354105	3-1J2
ED-301911	5-05	EF-359874	3-F3C	EI-360053	1-60	EJ-354105	3-1J4
ED-301911	5-06	EF-359874	3-F4C	EI-360053	3-1C31	EJ-354105	11-1J
ED-301911	5-07	EF-593706	1-15	EI-360053	3-1C43	EJ-354105	11-1J2
ED-301911	5-08	EF-593706	3-F2B	EI-362588	1-41	EJ-356363	13-41
ED-301911	5-09	EF-601942	1-16	EI-362588	3-1C5	EJ-380771	3-1J1
ED-301911	5-10	EF-601942	3-F3B	EI-362588	3-1C7	EJ-386256	3-1J6
ED-301911	5-11	EF-601942	3-F4B	EI-362588	3-1C15	EJ-386584	3-1P28
ED-301911	5-12	EF-695766	1-14	EI-362588	3-1C17	EJ-386581	3-1P9
ED-301911	5-D13	EF-695766	12-F1B	EI-362588	3-1C24	EJ-375424	13-69
ED-301911	5-D14	EH-351873	1-22	EI-362588	3-1C26	EJ-379529	3-1J3
ED-301911	5-D15	EH-351873	3-CR4	EI-364247	1-43	EJ-379523	3-1J5
ED-301911	5-D16	EH-353789	1-23	EI-364247	3-1C6	EJ-380944J	8-1J
ED-301911	5-D17	EH-353789	3-CR3	EI-364247	3-1C16	EJ-728377J	13-22
ED-301911	5-D18	EH-359185	1-24	EI-364247	3-1C25	EL-728382J	13-65
ED-301911	5-D19	EH-359185	3-CR2	EI-364253	1-48	EM-382317J	1-70
ED-301911	5-D20	EH-370520	1-21	EI-364253	3-1C69	EM-382317J	13-64
ED-301911	5-D21	EH-370520	3-CR1	EI-364257	1-69	EO-318365	3-1L1
ED-301911	5-D22	EH-379500	1-25	EI-364257	3-1X1	EO-318365	3-1L2
ED-344280	1-9	EH-379500	3-FL1	EI-364275	1-42	EO-318365	6-1L1
ED-344280	3-04	EH-379500	3-FL2	EI-364275	3-1C32	EO-318365	6-1L2
ED-344280	3-05	EH-379500	3-FL3	EI-369660	1-31	EO-360068	1-71
ED-344280	3-06	EH-379500	3-FL4	EI-369660	3-1C58	EO-360068	12-F11
ED-344280	3-07	EH-379500	3-FL5	EI-370487	1-64	EQ-348929	3-RL1
ED-344280	3-08	EH-379500	3-FL6	EI-370487	3-1C52	ER-200972	1-72
ED-344280	3-09	EH-379500	3-FL7	EI-371671	3-1C53	ER-200972	3-1R65
ED-344280	3-D10	EH-379500	3-FL8	EI-371671	1-66	ER-306905	3-R29
ED-344280	3-D11	EH-379500	3-FL9	EI-371671	3-1C46	ER-306905	3-R30
ED-344280	3-D14	EH-379500	3-FL10	EI-375220	1-59	ER-306725	1-73
ED-344280	3-D16	EH-379500	3-FL11	EI-375220	3-1C59	ER-306725	3-R152
ED-344280	3-D17	EI-200573	1-52	EI-375220	3-1C60	ES-306430	13-43
ED-344280	3-D18	EI-200573	4-1C4	EI-375222	1-57	ES-349474	1-76
ED-344280	3-D19	EI-302233	1-51	EI-375222	3-1C37	ES-349474	5-SW1
ED-344280	3-D20	EI-302233	3-1C40	EI-375345	1-35	ES-349474	5-SW2
ED-344280	4-D2	EI-310036	1-53	EI-375345	3-1C41	ES-349474	5-SW3
ED-344280	4-D3	EI-310036	3-1C3	EI-375345	3-1C42	ES-349474	5-SW4
ED-344280	4-D4	EI-310036	4-1C3	EI-375347	1-34	ES-349474	5-SW5
ED-344280	4-D5	EI-346071	1-38	EI-375347	3-1C62	ES-349474	5-SW6
ED-344280	6-D3	EI-346071	3-1C71	EI-375437	1-32	ES-349474	5-SW7
ED-344280	6-D4	EI-346071	6-1C1	EI-375437	3-1C51	ES-349474	5-SW8
ED-346536	1-10	EI-346071	6-1C2	EI-375437	3-1C57	ES-349474	5-SW9
ED-346536	3-1D2	EI-346071	6-1C3	EI-375439	1-36	ES-349474	5-SW10
ED-357036	1-6	EI-346071	6-1C4	EI-375439	4-1C7	ES-349474	5-SW11
ED-357036	3-1D2	EI-349719	1-39	EI-376178	1-50	ES-349474	5-SW12
ED-357036	1-7	EI-349719	3-1C1	EI-376178	3-1C10	ES-349474	5-SW13
ED-357036	3-1D1	EI-349719	3-1C2	EI-376178	3-1C11	ES-349474	5-SW14
ED-359863	6-D17	EI-349719	3-1C29	EI-376178	3-1C12	ES-349474	5-SW15
ED-359863	6-D18	EI-349719	4-1C2	EI-376178	3-1C13	ES-349474	5-SW16
ED-359863	6-D19	EI-349719	4-1C6	EI-376178	3-1C14	ES-349474	5-SW17

## PARTS LIST

Part No.	Ref. No.	Part No.	Ref. No.	Part No.	Ref. No.	Part No.	Ref. No.
ES-349474	5-SW18	SP-389776J	13-25				
ES-349474	5-SW19	SP-389785J	13-30				
ES-349474	5-SW20	SP-389787J	13-51				
ES-349474	5-SW21	SP-384036J	13-49				
ES-349474	5-SW22	SP-384039J	13-50				
ES-364255	1-75	SZ-384036J	13-54				
ES-364255	3-SW1	ZG-728389J	13-14				
ES-364478	13-72	ZG-728370J	13-15				
ES-380946J	1-74	ZS-311746	13-42				
ES-380946J	10-VR1	ZS-331532	13-52				
ET-349592	1-81	ZS-341980	13-28				
ET-349592	3-TR7	ZS-350934	13-44				
ET-349592	3-TR8	ZS-355511	13-34				
ET-349592	3-TR9	ZS-355818	13-70				
ET-349592	3-TR10	ZS-362266	13-59				
ET-349592	3-TR11	ZS-362533	13-3				
ET-349592	3-TR12	ZS-378447	13-39				
ET-349592	5-TR1	ZS-389937J	13-61				
ET-349592	5-TR2	ZS-388071J	13-23				
ET-349592	5-TR3	ZS-417137	13-26				
ET-349883	1-79	ZS-447761	13-46				
ET-349883	3-TR3	ZS-463353	13-48				
ET-354167	1-77	ZS-537074	13-80				
ET-354167	3-PH1	ZS-593908	13-63				
ET-360137	1-80	ZW-273802	13-36				
ET-360137	3-TR1	ZW-273914	13-79				
ET-360137	3-TR2	ZW-321317	13-58				
ET-360137	3-TR5	ZW-413188	13-53				
ET-360137	3-TR6	ZW-413267	13-40				
ET-375446	1-78	ZW-516993	13-37				
ET-375446	3-TR4	ZW-516993	13-81				
EV-356582	6-VR2	ZW-698308	13-35				
EV-356582	6-VR3	ZW-728375J	13-20				
EV-356582	6-VR4						
EV-365865	1-83						
EV-365865	3-VR1						
EV-365876	1-84						
EV-365876	6-VR5						
EV-385801J	1-82						
EV-385801J	7-VR1						
EV-385801J	7-VR2						
EV-385801J	7-VR3						
EV-387796J	6-VR1						
EV-390045J	3-VR2						
EV-390046J	3-VR3						
EW-357931	13-82A						
EW-358629	13-82C						
EW-358630	13-82E						
EW-358631	13-82D						
EW-362290	13-83						
EW-365947	13-82						
EW-368055	13-82B						
EW-380947J	8-W109						
EZ-200473	3-1						
EZ-302906	13-45						
EZ-358816	1-85						
EZ-358916	3-BT1						
MB-727158J	13-18						
MZ-728371J	13-16						
MZ-728372J	13-17						
MZ-728374J	13-19						
SA-332350	13-2						
SC-383644J	13-47						
SC-388713J	13-62						
SE-362389A-A	13-57						
SE-383777J	13-80						
SK-382429J	13-78						
SK-383388J	13-67						
SK-383390J	13-77						
SK-383781J	13-75						
SK-383789J	13-74						
SK-383790J	13-76						
SK-384037J	13-68						
SK-726277J	13-12						
SK-726278J	13-6						
SK-726279J	13-7						
SK-726280J	13-8						
SK-726281J	13-9						
SK-726282J	13-10						
SK-726283J	13-13						

**ABBREVIATIONS FOR THE SERVICE MANUAL**

ABBREVIATION	EXPLANATION	ABBREVIATION	EXPLANATION
ADC	Analogue to Digital Converter	MIDI	Musical Instrument Digital Interface
AMP (Amp)	AMPlifier	MINI	MINImum
BBD	Backet Brigade Diode	MIX	MIXer
BCD	Binary Code Decimal	MOD	MODulation
B.DOWN	Brak DOWN	M.WHEEL	MODulation WHEEL
B.UP	Back UP	OSC	OSCillator
CE	Chip Enable	RAM	Random Access Memory
CH	CHannel	RD	ReaD
COMP	COMParator	REG	REGulator
CONT	CONTrol	RESO	RESOnance
CV	Control Voltage	RL	ReLay
DAC	Digital to Analogue Converter	ROM	Read Only Memory
EG	Envelope Generator	S/H	Sample and Hold
EXT	EXTernal	SW	SWitch
FREQ	FREQuency	THRU	THRoUgh
HPF	High Pass Filter	TRANS	TRANSpose
INH	INHibit	U	Upper
INT	INTerrupt	VA	Voltage Analog
INV	INVerter	VCA	Voltage Controlled Amplifier
L	Lower	VCF	Voltage Controlled Filter
LFO	Low Frequency Oscillator	VR	Variable Resistor
MAX	MAXimum	VREF	REFerence Voltage
MEMO	MEMOry	WR	WRite

**AKAI ELECTRIC CO., LTD.**

12-14, 2-Chome, Higashi-Kojiya, Ohta-Ku, Tokyo, Japan  
 SERVICE DEPARTMENT TEL: Tokyo(745)9884 TOKYO TELEX: J26261

Printed No. 890321-A1-400

Printed Date: April 21, 1989

350 Printed in Japan

vx600