

CMC MIXERS: INTERNAL CONSTRUCTION
model CMC 24 illustrated

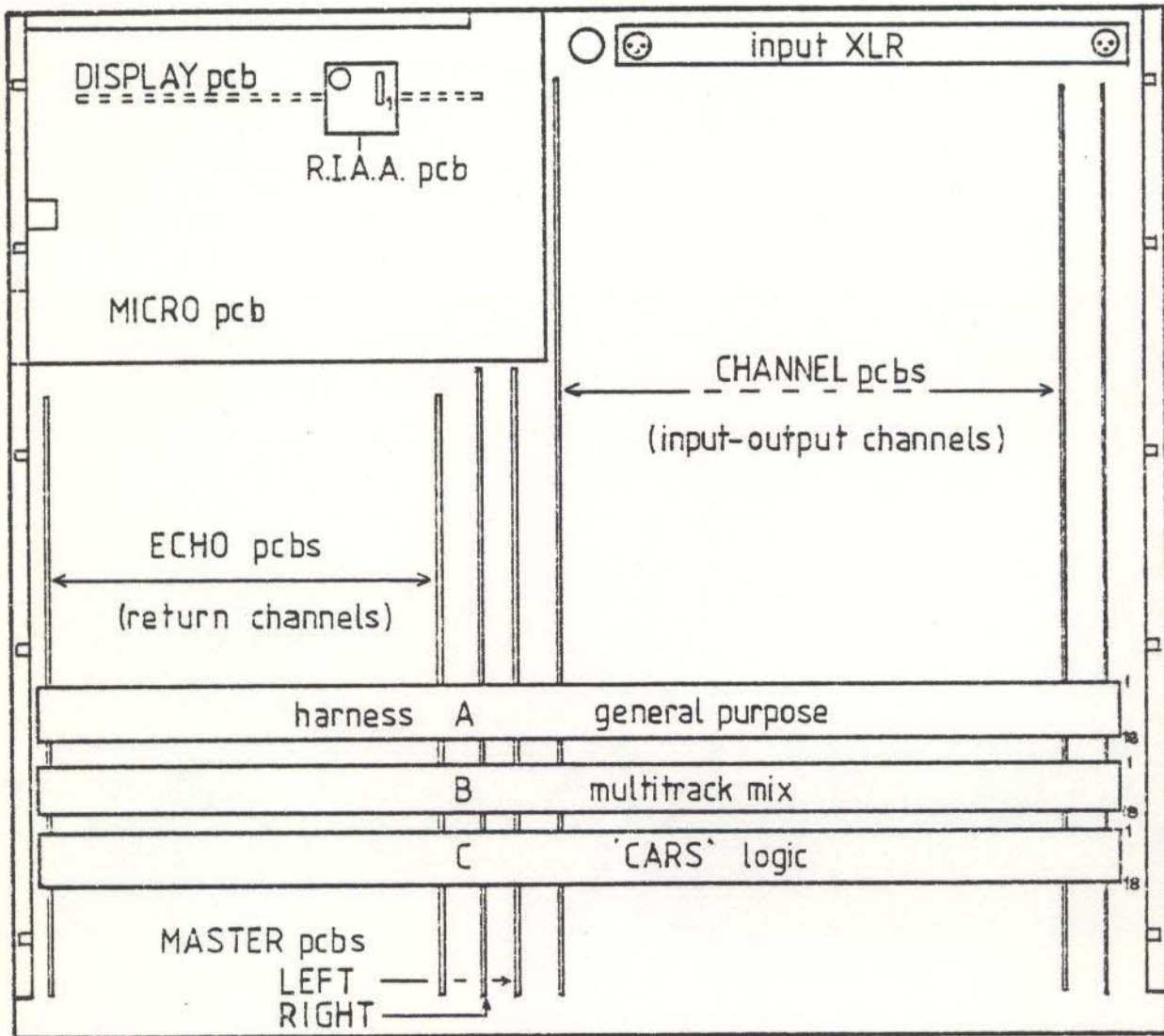

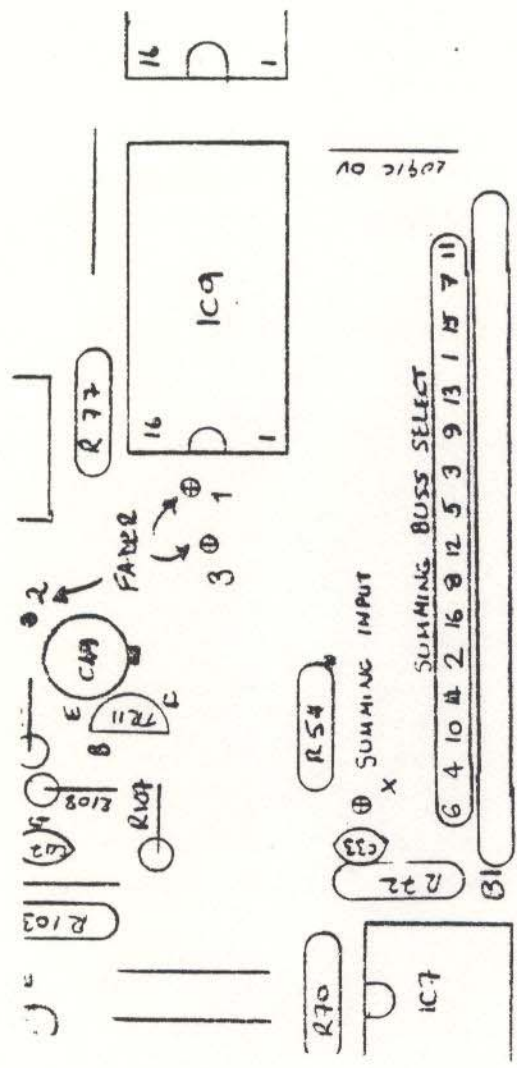

LINK X LOCATION ON CHANNEL PCB.

FIG. 1

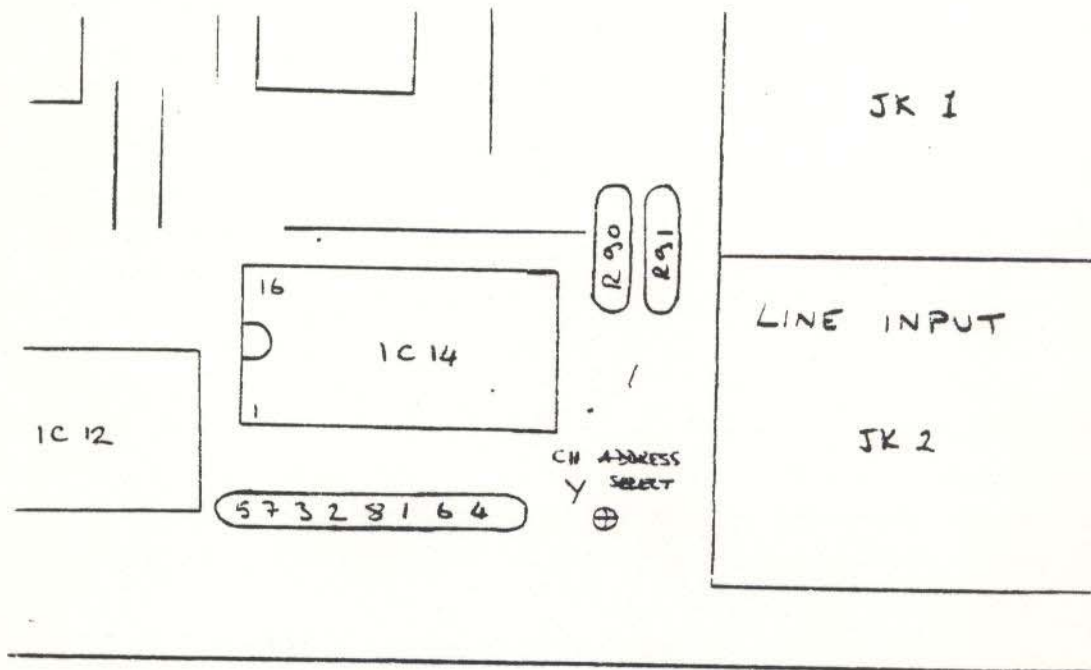

LINK Y LOCATION FOR CHANNEL P.C.B.

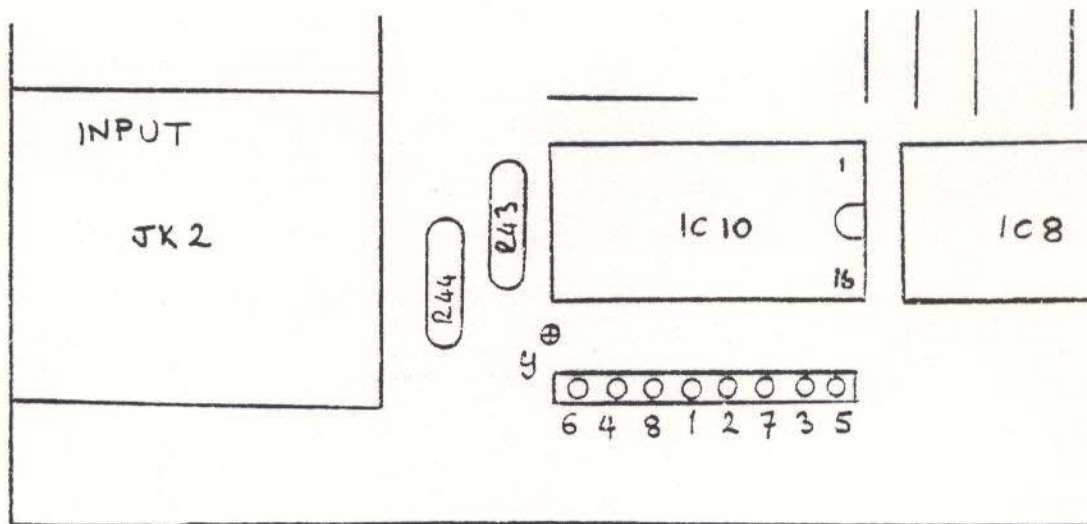

LINK Y LOCATION FOR ECHO P.C.B.

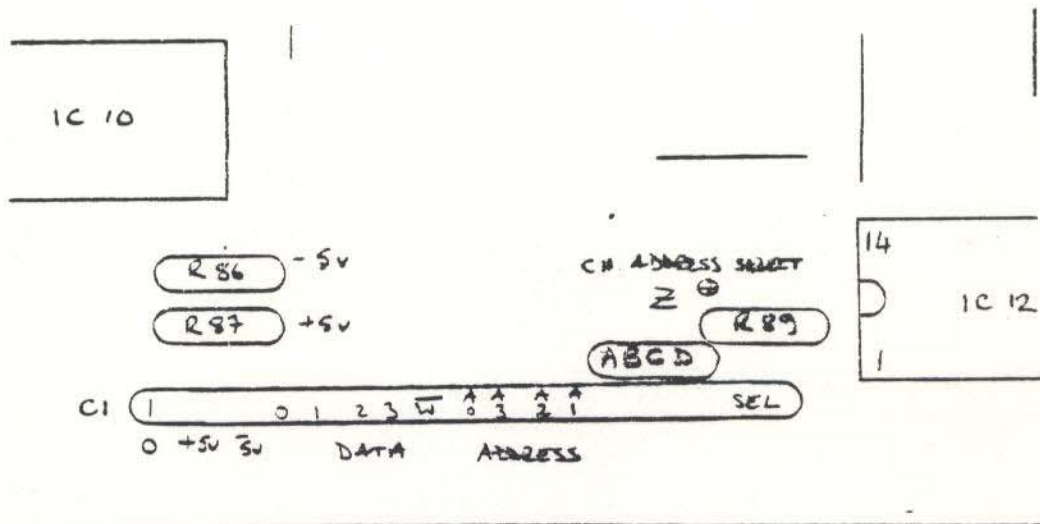

LINK Z LOCATION FOR CHANNEL P.C.B.

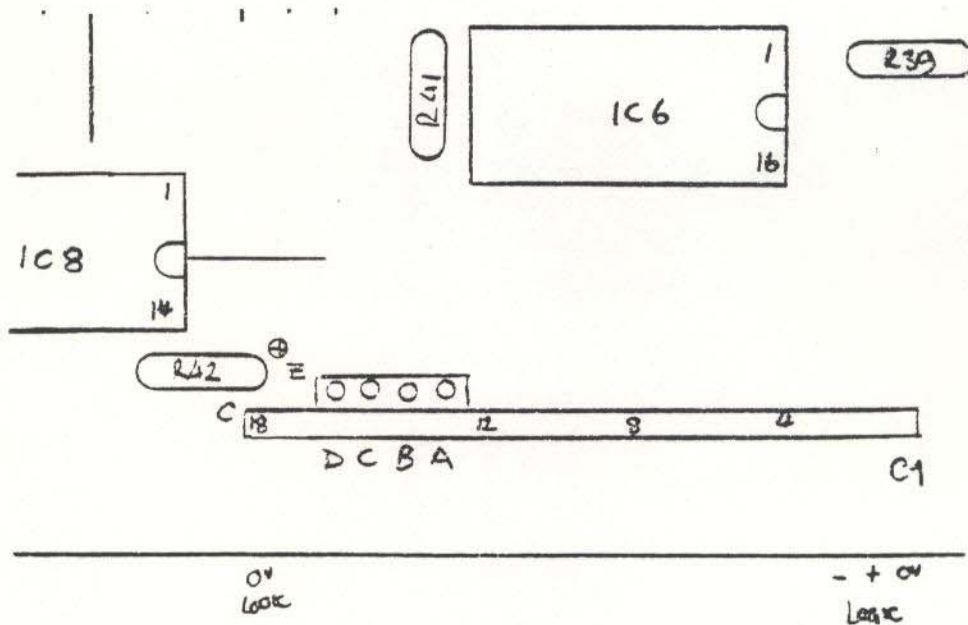

LINK Z LOCATION FOR ECHO P.C.B.

FIG. 3.

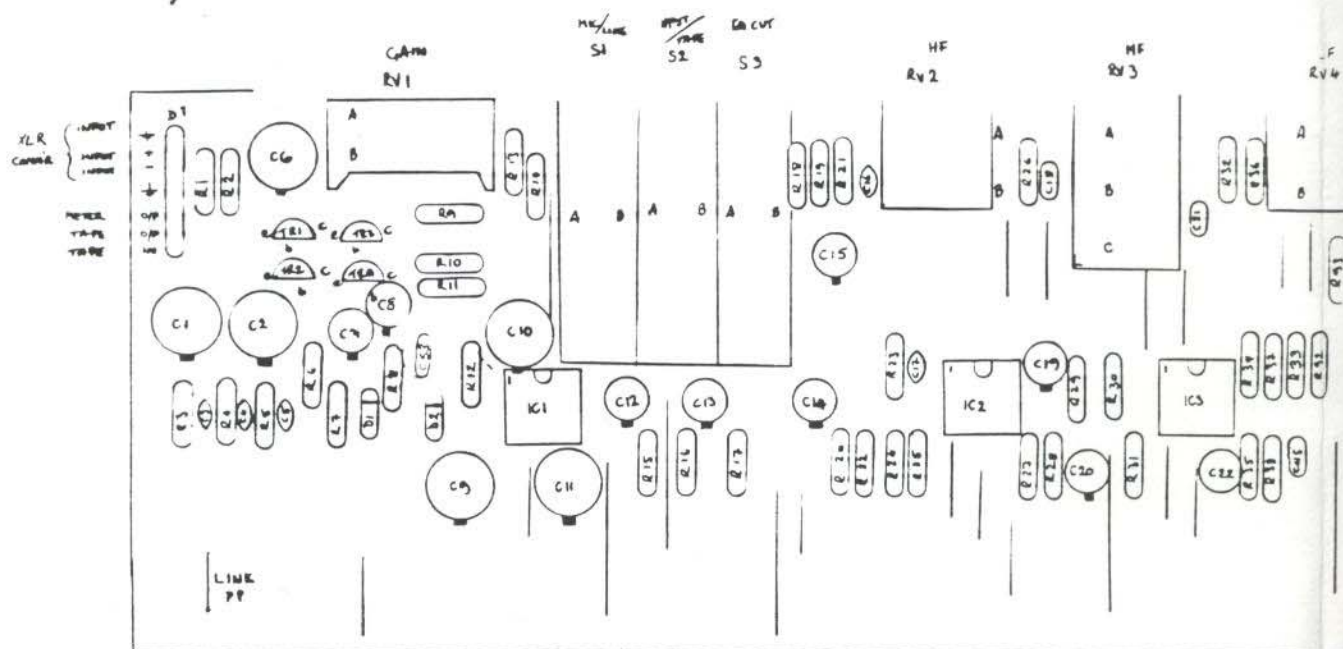

Channel PCB layout p1

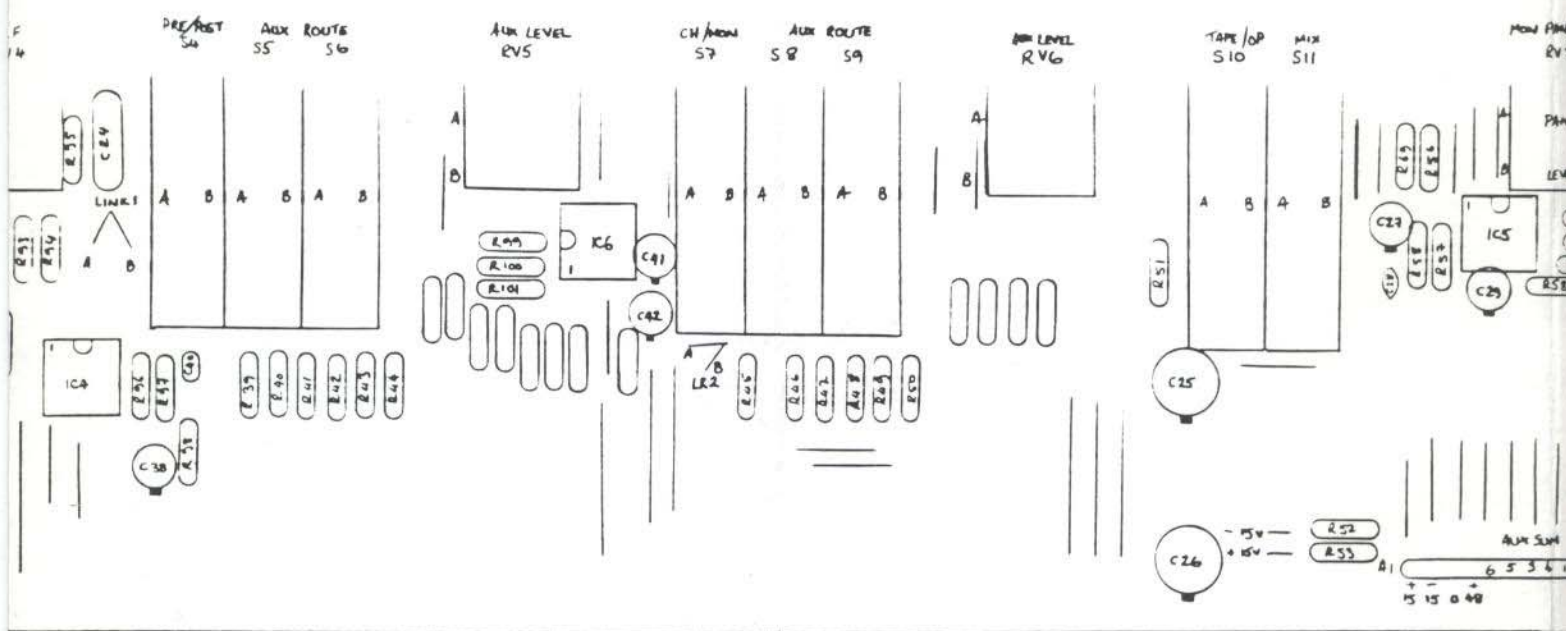

AHB CMC CHANNEL PCB COMPONENT OVERLAY 2:1

ANALOGUE SUPPLY

Channel PCB layout p2

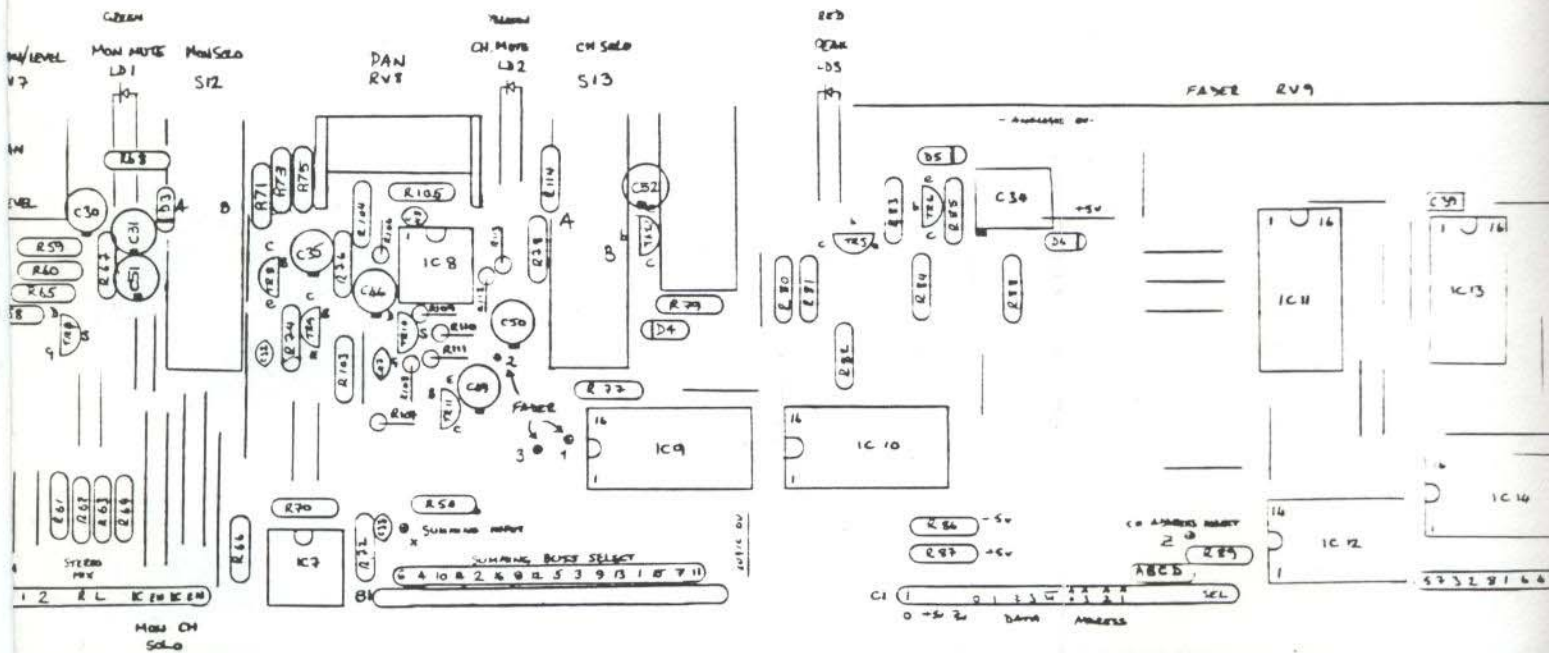

W102

19/9/84

AHB 69 SHIP ST
BRIGHTON BNI IAE

LOGIC SUPPLY

TO SET FOR CHANNELS 1-8 LK 2 →
 TO SET FOR CHANNELS 9-16 LK 2 →
 TO SET FOR CHANNELS 17-24 LK 8 →
 TO SET FOR CHANNELS 25-32 (17-24 ON CH3)

Channel PCB layout p3

FASER 2V9

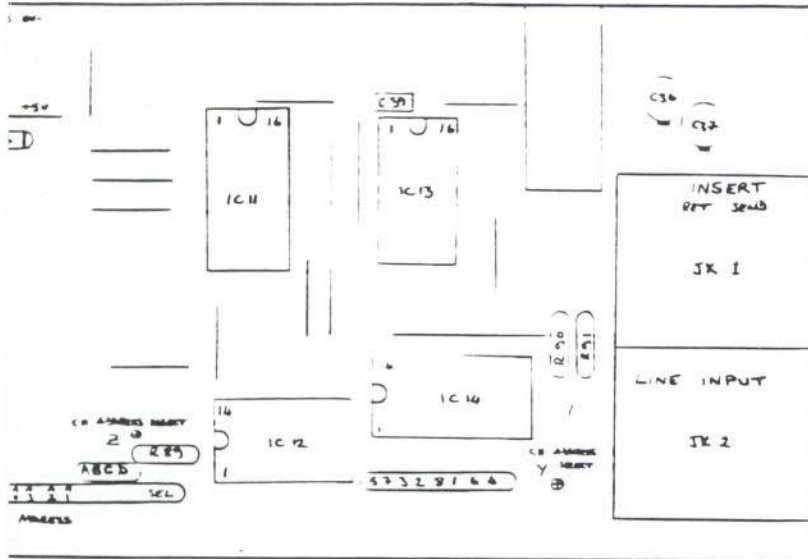

TO SET FOR CHANNELS 1-8 LK2 → A LK Y AS REQUIRED
 TO SET FOR CHANNELS 9-16 LK2 → B LK Y AS REQUIRED 1=9 8=16
 TO SET FOR CHANNELS 17-24 LK3 → C LK Y AS REQUIRED 1=17 8=24
 TO SET FOR CHANNELS 25-32 (17-24 ON CARD) LK3 → D LK Y AS REQUIRED 1=25 8=32
 (1=17 8=24 ON CARD)

Channel PCB layout p4

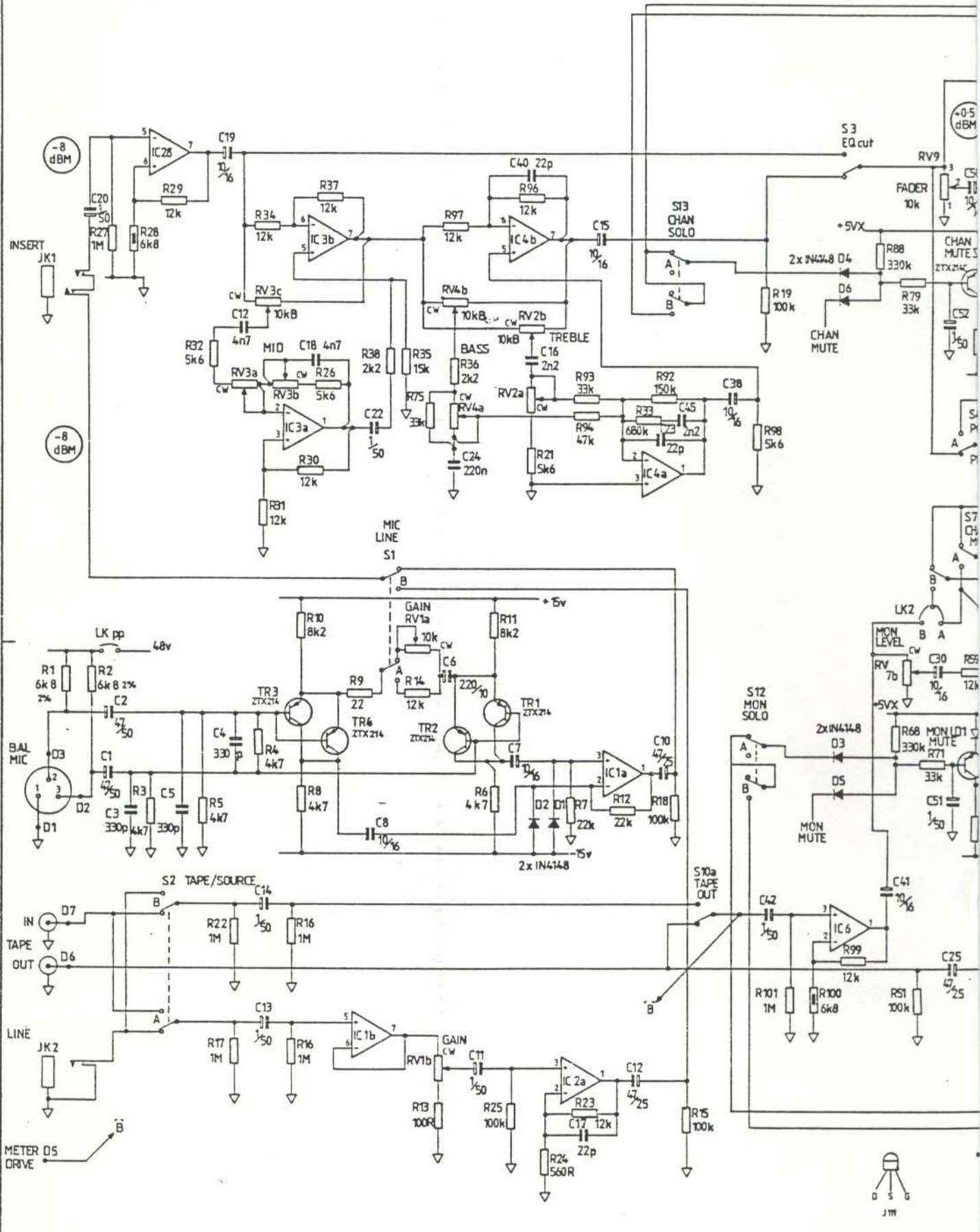

STANDARD NOTES			MATERIAL	TOLERANCES
ALL DIMENSIONS IN mm DO NOT SCALE DRAWING THIRD ANGLE PROJECTION REMOVE ALL BURRS & SHARP EDGES				
GMR	ORIGIN	17-984	SCALE	UNLESS STATED OTHERWISE
DRAWN	REVISION	DATE		

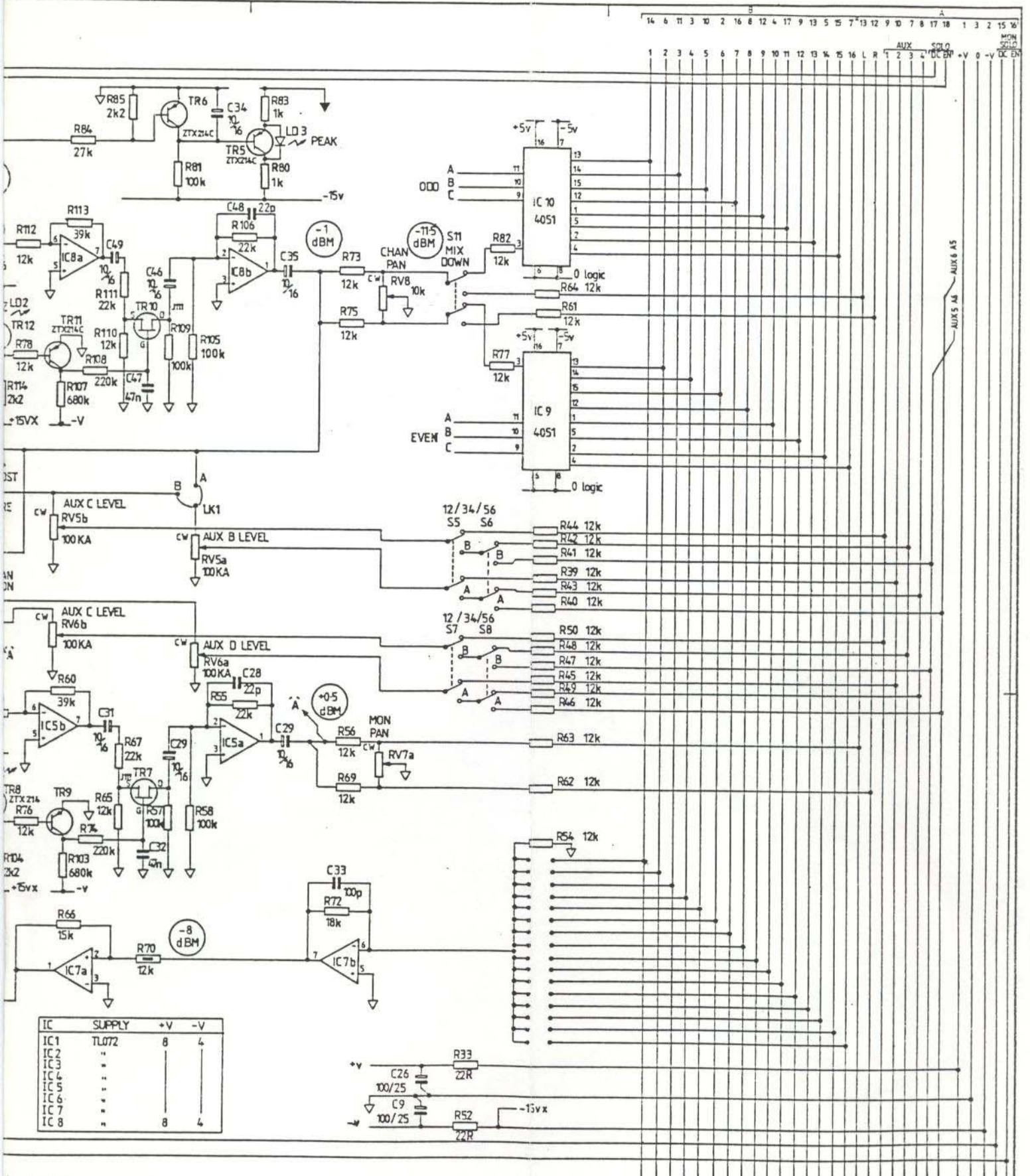

CHANGING THESE VALUES ALLOWS HIGH LEVEL OPERATION.

FINISH

NOTES
 CAPACITORS SHOWN VALUE/VOLTAGE
 ALSO SEE LOGIC CIRCUIT DIAGRAM
 MBD 113.

UNIT TITLE
 AHB CMC SERIES

DRAWING TITLE
 I/P / O/P CHANNEL
 CHANNEL PCB AG0104 ISS 3

AHB ALLEN & HEATH BRENNELL LTD.
 PROFESSIONAL AUDIO EQUIPMENT
 MANUFACTURERS

69 SHIP STREET BRIGHTON BN1 1AE TEL 0273-24928

DRAWING No. MBD 112 iss 2

CONNECTOR C

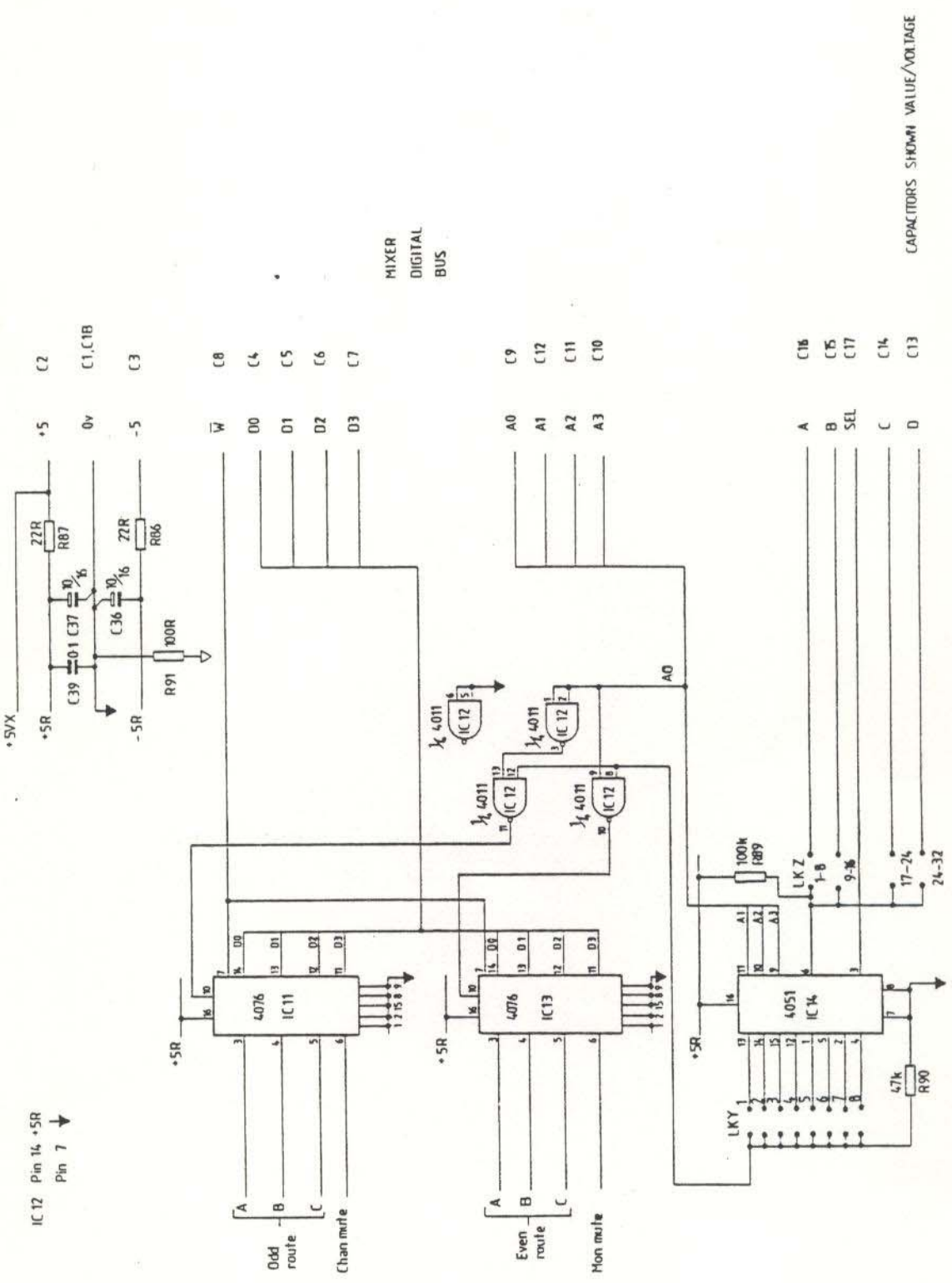

MIXER
DIGITAL
BUS

CAPACITORS SHOW VALUE/VOLTAGE

IC 12 Pin 14 +5R
Pin 7 ↓

DRAWN GMR		TRACED KRP		CHECKED	APPROVED	DATE 24-1-85	SCALE
AHB 69 SHIP STREET, BRIGHTON BN1 1AE Tel 0273 74928							
CMC SERIES LOGIC CONTROL FOR CHANNEL ON CHANNEL PCB AG0104 Iss 3							
ORIGIN		DATE		EXAMPLE		DATE	
ALTERATIONS							
DRAWING No. MBD 113 iss 1							

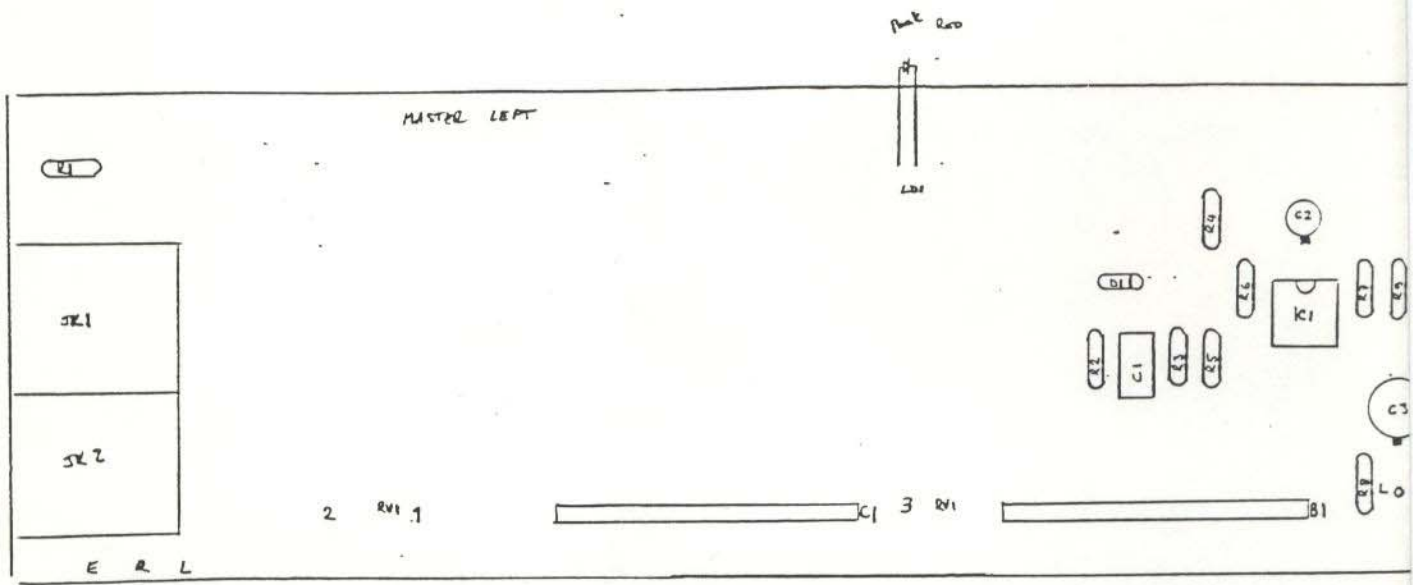

AHB CMC MASTER LEFT A90105 COMPONENT OVERLAY 2:1 8WO 96 1552

Master Left layout p1

4021

2

3

4

5

6

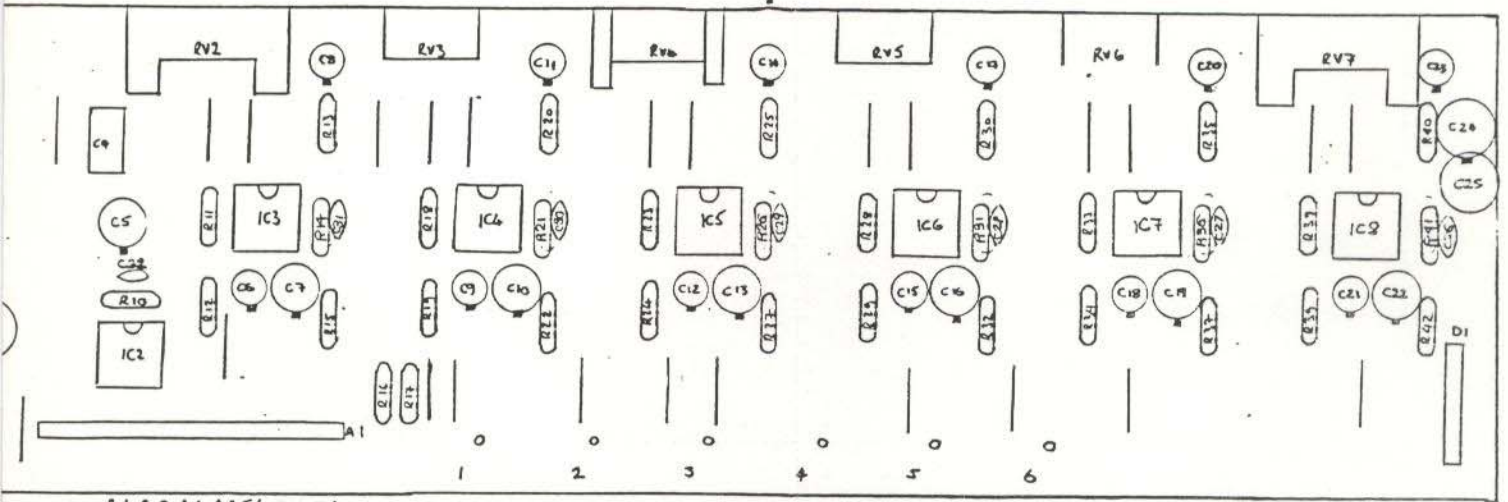

0 1 2 3 4 5 6 7 8 9 10 11 12 13 14 15 16 17 18 19 20 21 22 23 24 25 26 27 28 29 30 31 32 33 34 35 36 37 38 39 40 41 42 43 44 45 46 47 48 49 50 51 52 53 54 55 56 57 58 59 60 61 62 63 64 65 66 67 68 69 70 71 72 73 74 75 76 77 78 79 80 81 82 83 84 85 86 87 88 89 90 91 92 93 94 95 96 97 98 99 100

AHB. 67 SHIP ST. BEXINGTON

Master Left layout p2

Green

RED

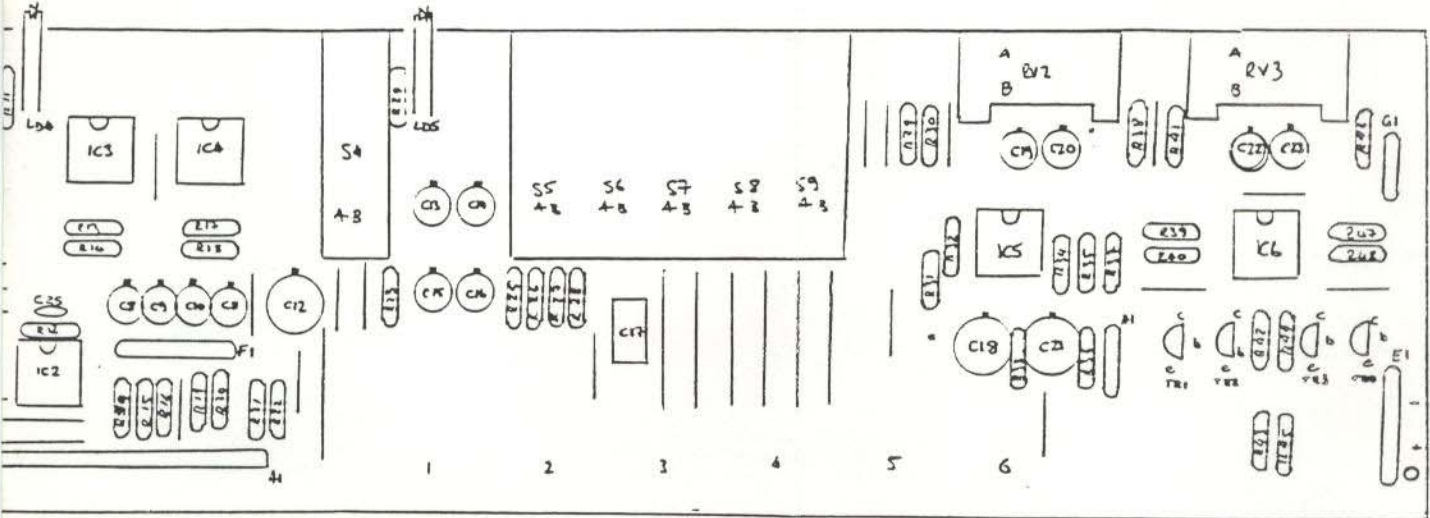

4th SEPTEMBER 1986

AWB LTD. 69 SHIP ST. BRIGHTON

Master Right layout p2

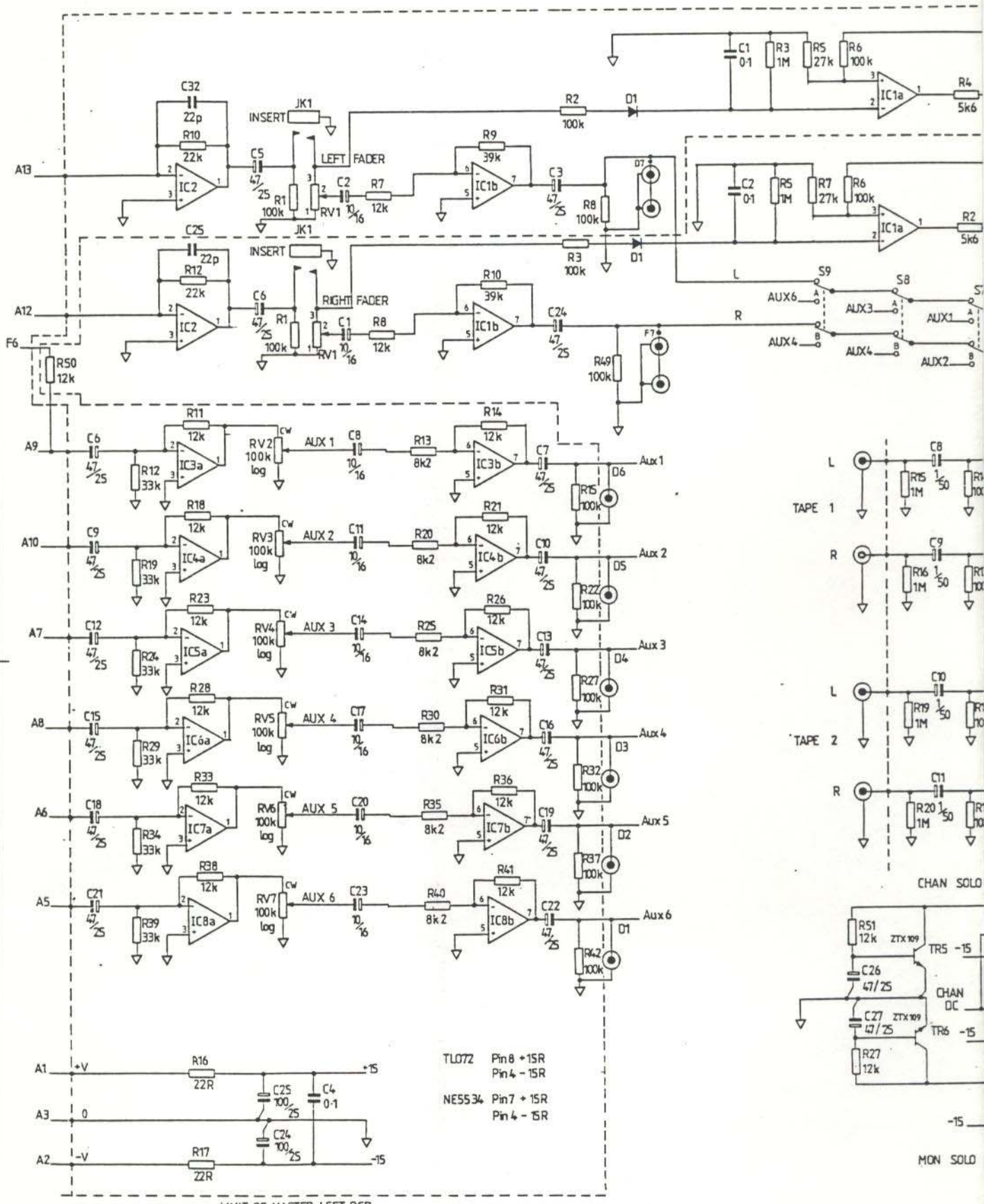

TL072 Pin 8 +15R
Pin 4 -15R
NE5534 Pin 7 +15R
Pin 4 -15R

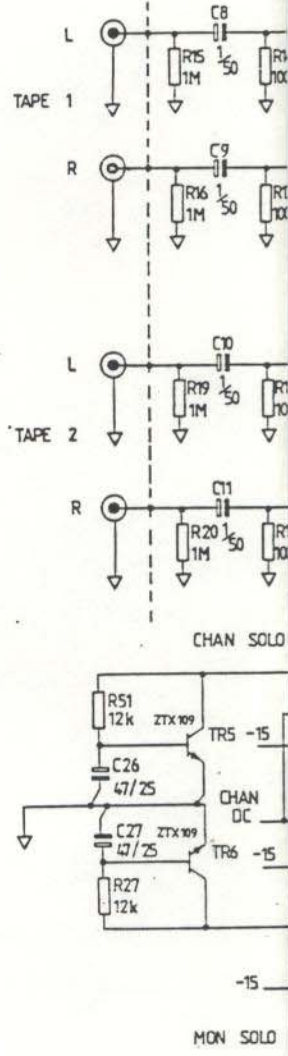

STANDARD NOTES			MATERIAL	TOLERANCES
ALL DIMENSIONS IN mm DO NOT SCALE DRAWING THIRD ANGLE PROJECTION REMOVE ALL BURRS & SHARP EDGES				
GMR			SCALE	UNLESS STATED OTHERWISE
ORIGIN	27-2 85	GMR		
DATE	REVISION	CHECKED		

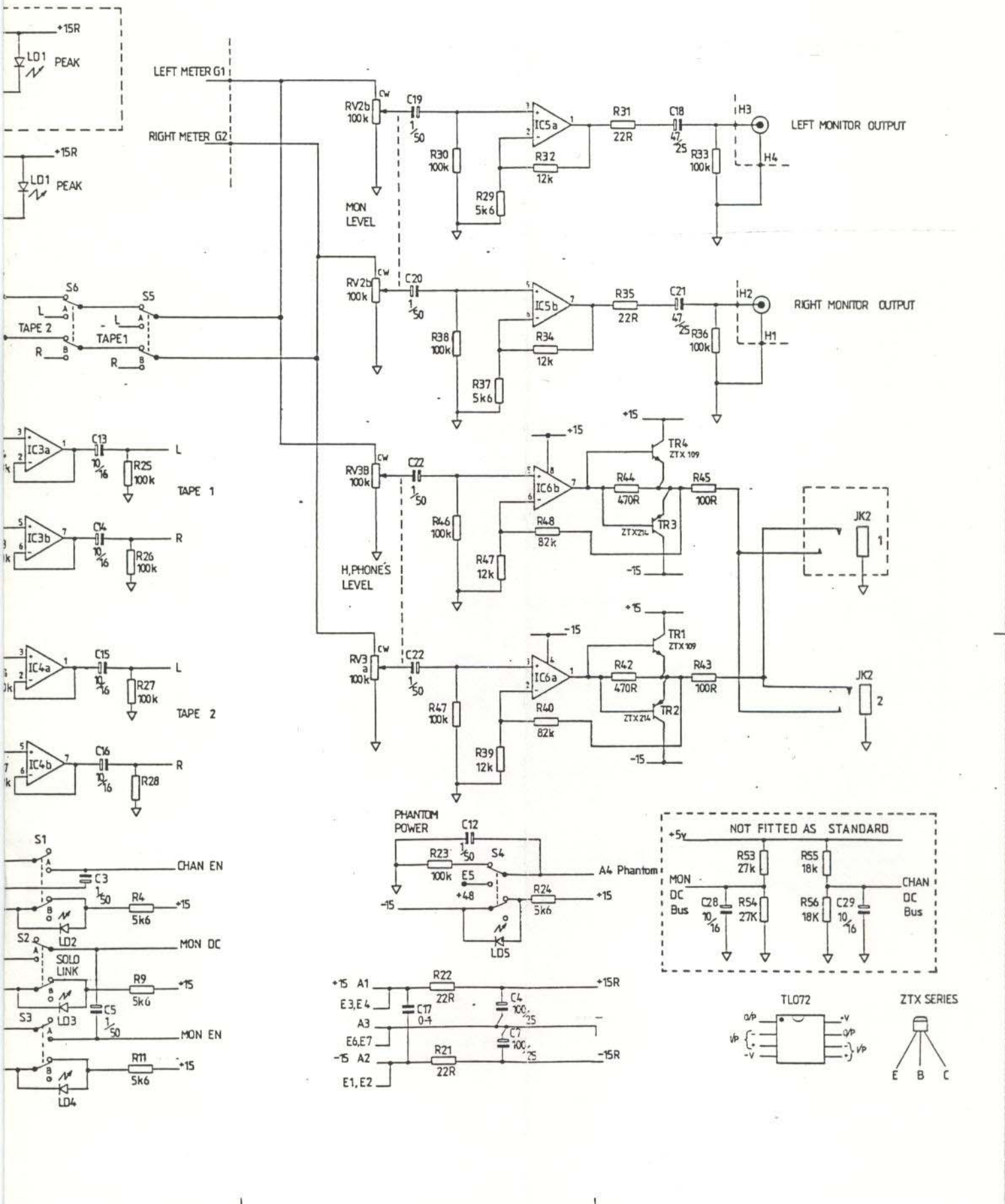

FINISH

NOTES
 CIRCUIT DETAILS INSIDE DOTTED LINE ARE ON MASTER LEFT PCB. AGO105 iss1.
 CIRCUIT DETAILS OUTSIDE DOTTED LINE ARE ON MASTER RIGHT PCB. AGO106 iss1.
 ALL PHONO CONNECTORS ON MICRO PCB. CAPACITORS SHOWN VALUE/VOLTAGE

UNIT TITLE
 AHB CMC SERIES

DRAWING TITLE
 MASTER LEFT AND RIGHT

ALLEN & HEATH BRENNELL LTD.
 PROFESSIONAL AUDIO EQUIPMENT MANUFACTURERS
 69 SHIP STREET BRIGHTON BN1 1AE TEL 0273 24928

DRAWING No. MBD 116 iss3

RIAA

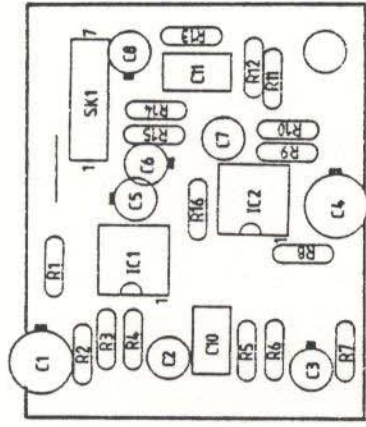
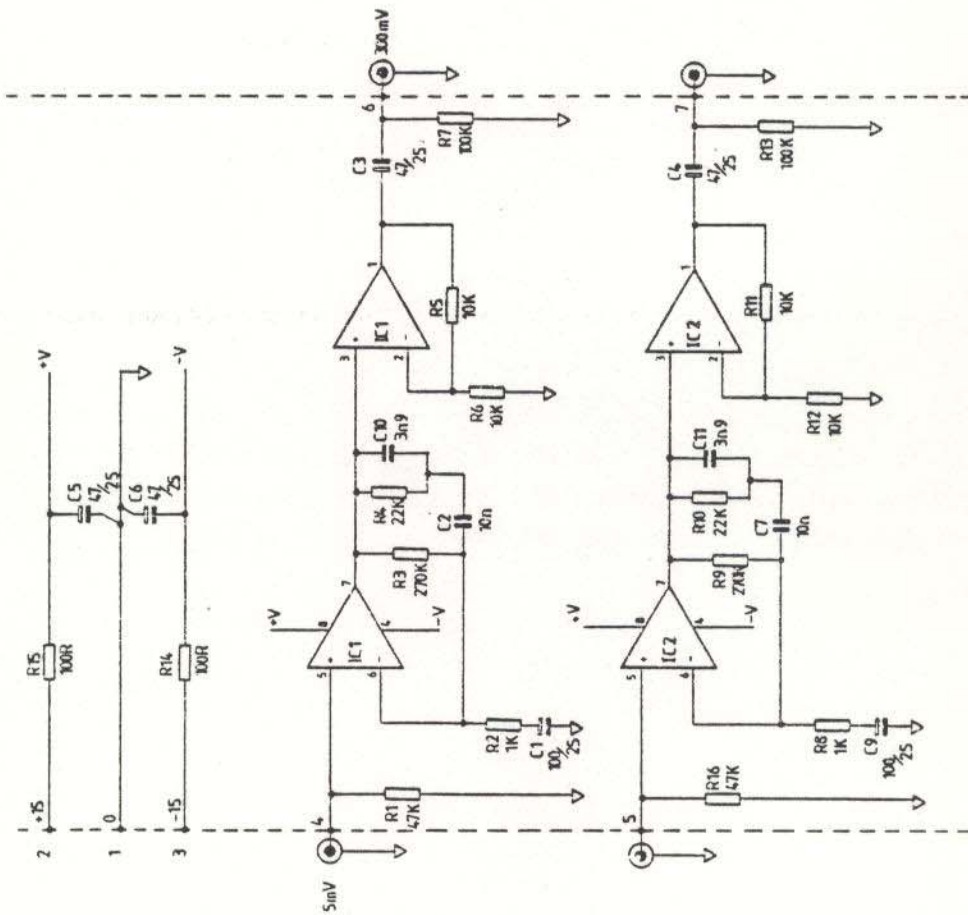

RIAA COMPONENT OVERLAY

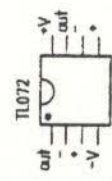

CAPACITORS SHOWN VALUE/VOLTAGE

CHC SERIES RIAA EQUALISED PHE-ATP RIAA PCB AG002 iss 1		A11B 69 SHIP STREET, BRIGHTON BN11AE Tel 0273 24928		DRAWN GMR	TRACED KRP	CHECKED TR	APPROVED	DATE 26.2.85	SCALE
ALTERATIONS									
ORIGIN	DESCRIPTION	CHECKED	DATE	26.2.85	DATE	DATE	DATE	DATE	DATE

DRAWING No. MBD111 iss 1

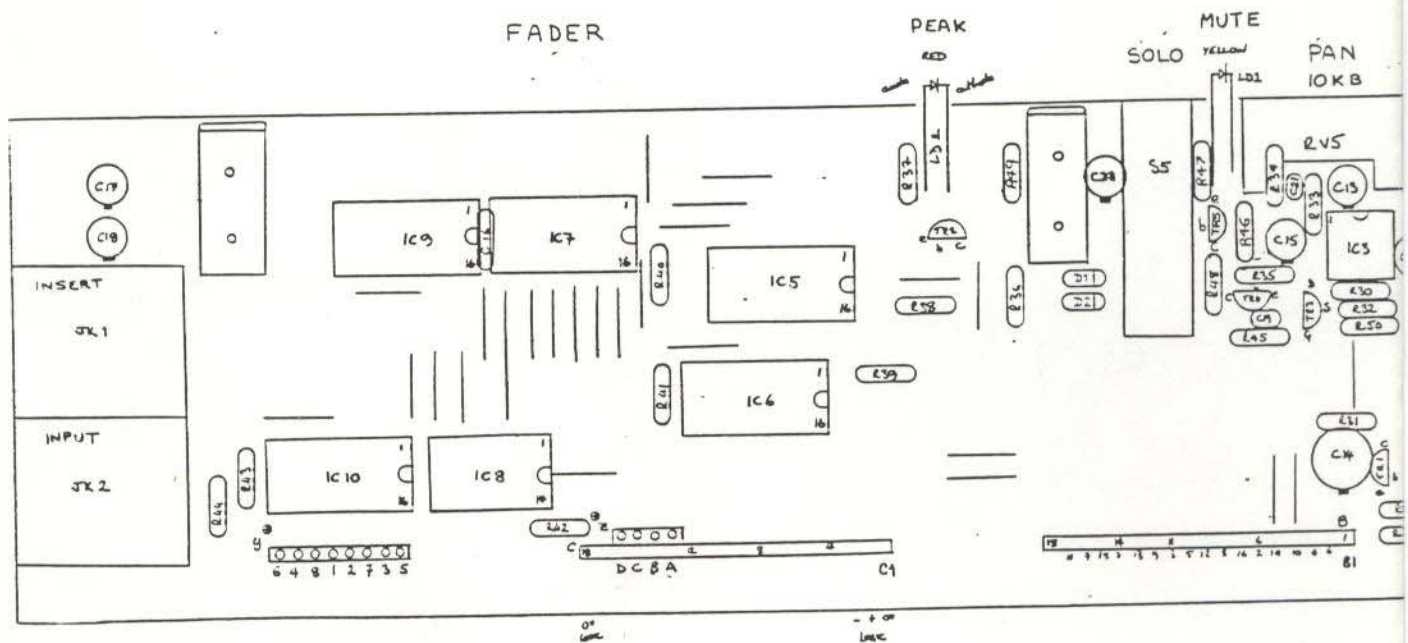

FOR CMC 16 LKZ → B LKY → 1=9 B=16
 FOR CMC 24 LKZ → D LKY → 1=17 B=24
 FOR CMC 32 LKZ → D LKY → 1=24 B=32

AHB CMC ECHO PCB COMPONENT OVER

Echo PCB layout p1

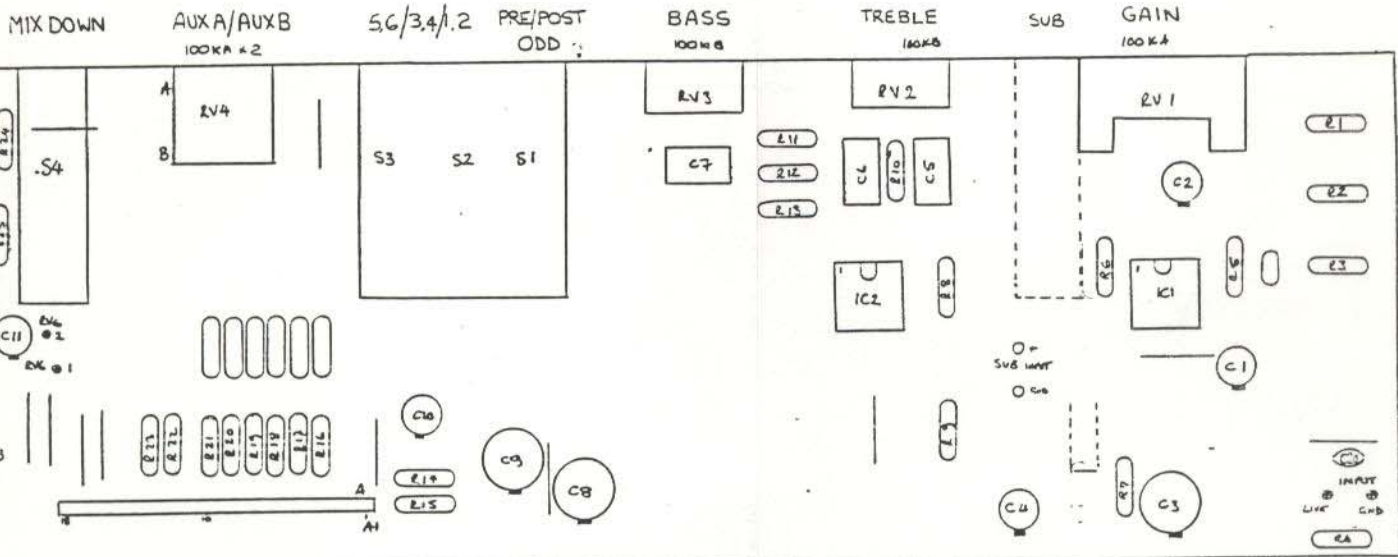

LAY 2:1 ISS3 BWO 93 19/9/84 AHB 69 SHIP ST: BRIGHTON BNI IAE

Echo PBC layout p2

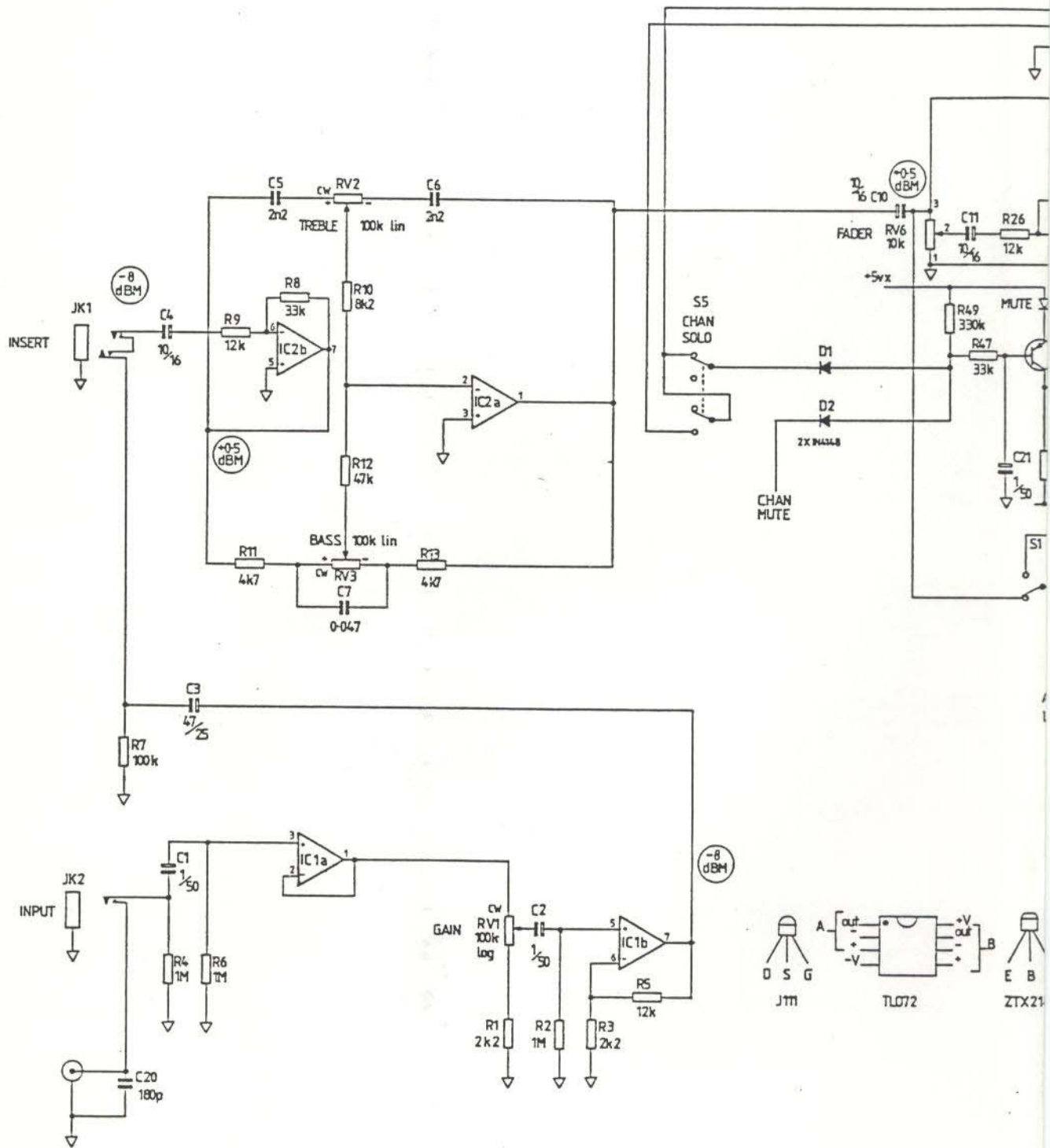

STANDARD NOTES			MATERIAL	TOLERANCES
ALL DIMENSIONS IN mm DO NOT SCALE DRAWING THIRD ANGLE PROJECTION REMOVE ALL BURRS & SHARP EDGES				
SCALE				
GMR	ORIGIN	17-8-84		
DR/wh	REVISION	DATE	CHECKED	

UNLESS STATED OTHERWISE

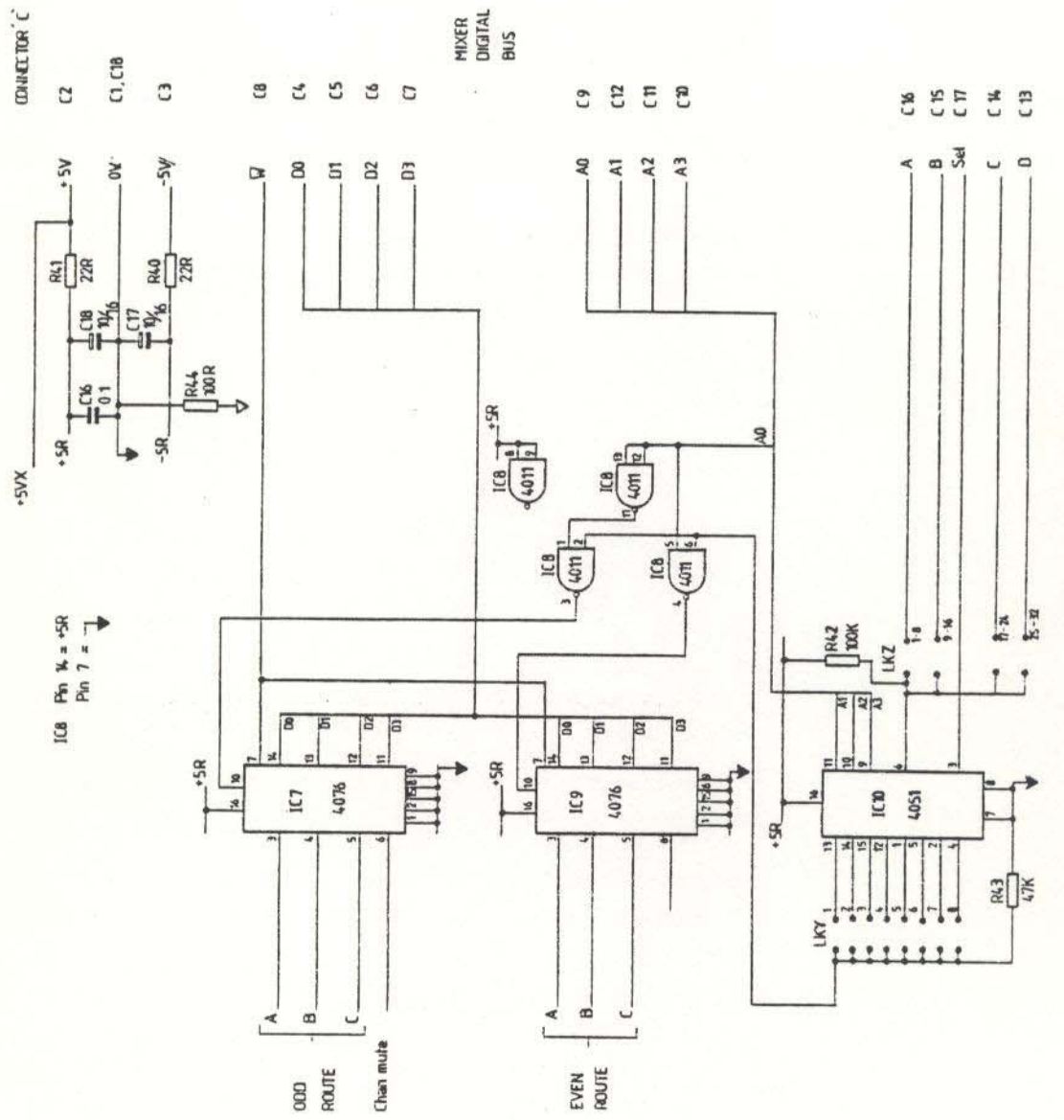

DRAWN	TRACED	CHECKED	APPROVED	DATE	SCALE
GHR	KRP			18/9/84	

AHD		69 SHIP STREET,		BRIGHTON BN1 1AE		Tel 0273-26928	
CHIC SERIES		LOGIC CONTROL FOR ECHO		ECHO PCB AG0103 ISS 2		DRAWING No. MBD115 iss 1	
ORIGIN	GHR	IB 984	CHIC DATE				
DESCRIPTION	ALTERATIONS						

Meters

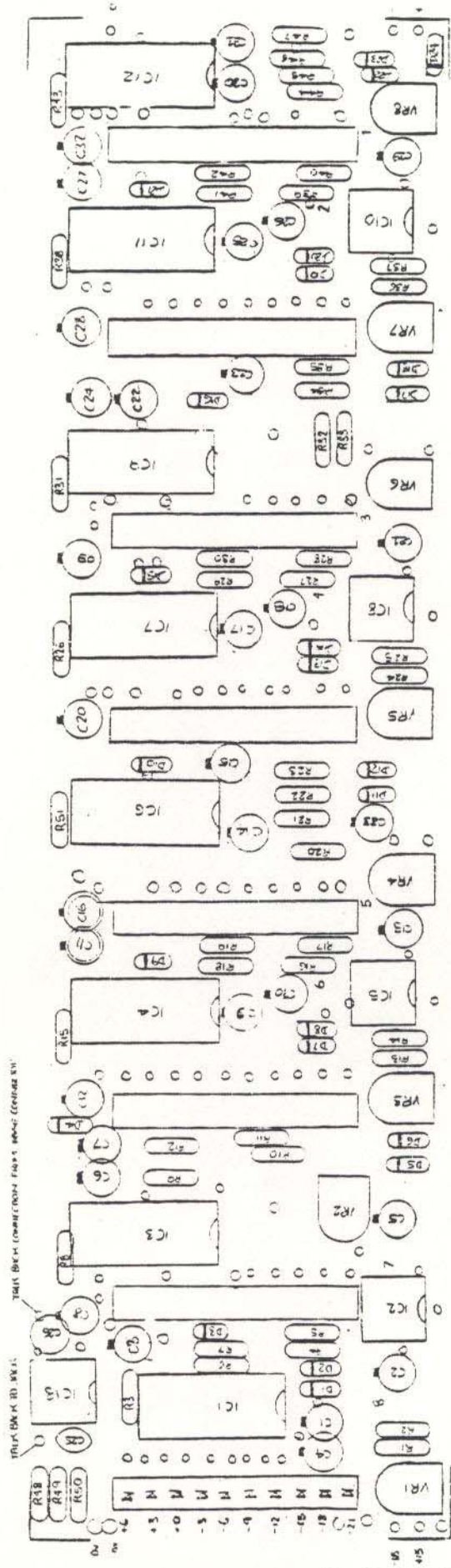

64106 METER POD PCB ISS 3 AGO109 AIB 69 SHIP DIRECT BRIGHTW

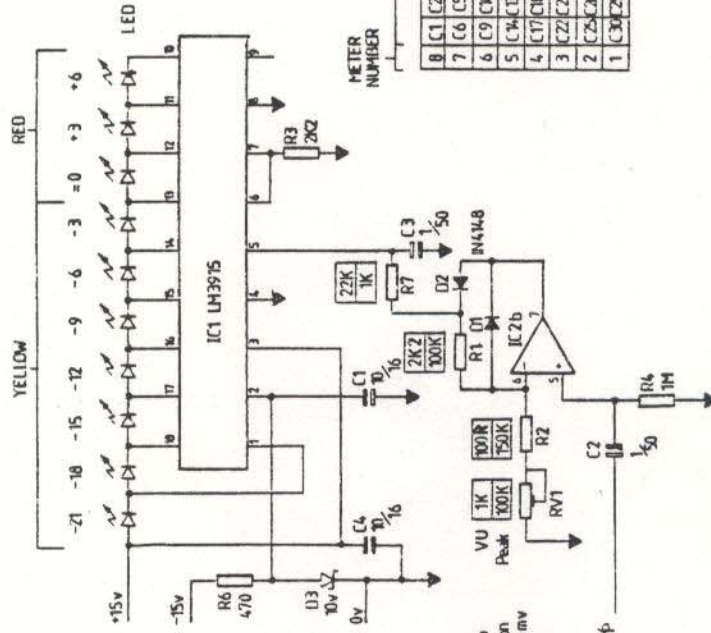

METER NUMBER	COMPONENT REFERENCE
8	C1 C2 C3 C4 RV1 D1 D2 D3 R1 R2 R3 R4 R6 R7 IC1 IC2 B
7	C6 C7 C8 RV2 D5 D6 D4 R10 R2 R6 R5 R9 R11 IC3 IC2 A
6	C9 C10 C11 C12 RV3 D8 D7 D9 R13 R14 R15 R16 R17 R18 R19 R20 R21 R22 R23 R24 R25 R26 R27 R28 R29 R30 R31 R32 R33 R34 R35 R36 R37 R38 R39 R40 R41 R42 R43 R44 R45 R46 R47 R48 R49 R50 R51 R52 R53 R54 R55 R56 R57 R58 R59 R60 R61 R62 R63 R64 R65 R66 R67 R68 R69 R70 R71 R72 R73 R74 R75 R76 R77 R78 R79 R80 R81 R82 R83 R84 R85 R86 R87 R88 R89 R90 R91 R92 R93 R94 R95 R96 R97 R98 R99 R100 R101 R102 R103 R104 R105 R106 R107 R108 R109 R110 R111 R112 R113 R114 R115 R116 R117 R118 R119 R120 R121 R122 R123 R124 R125 R126 R127 R128 R129 R130 R131 R132 R133 R134 R135 R136 R137 R138 R139 R140 R141 R142 R143 R144 R145 R146 R147 R148 R149 R150 R151 R152 R153 R154 R155 R156 R157 R158 R159 R160 R161 R162 R163 R164 R165 R166 R167 R168 R169 R170 R171 R172 R173 R174 R175 R176 R177 R178 R179 R180 R181 R182 R183 R184 R185 R186 R187 R188 R189 R190 R191 R192 R193 R194 R195 R196 R197 R198 R199 R200 R201 R202 R203 R204 R205 R206 R207 R208 R209 R210 R211 R212 R213 R214 R215 R216 R217 R218 R219 R220 R221 R222 R223 R224 R225 R226 R227 R228 R229 R230 R231 R232 R233 R234 R235 R236 R237 R238 R239 R240 R241 R242 R243 R244 R245 R246 R247 R248 R249 R250 R251 R252 R253 R254 R255 R256 R257 R258 R259 R260 R261 R262 R263 R264 R265 R266 R267 R268 R269 R270 R271 R272 R273 R274 R275 R276 R277 R278 R279 R280 R281 R282 R283 R284 R285 R286 R287 R288 R289 R290 R291 R292 R293 R294 R295 R296 R297 R298 R299 R300 R301 R302 R303 R304 R305 R306 R307 R308 R309 R310 R311 R312 R313 R314 R315 R316 R317 R318 R319 R320 R321 R322 R323 R324 R325 R326 R327 R328 R329 R330 R331 R332 R333 R334 R335 R336 R337 R338 R339 R340 R341 R342 R343 R344 R345 R346 R347 R348 R349 R350 R351 R352 R353 R354 R355 R356 R357 R358 R359 R360 R361 R362 R363 R364 R365 R366 R367 R368 R369 R370 R371 R372 R373 R374 R375 R376 R377 R378 R379 R380 R381 R382 R383 R384 R385 R386 R387 R388 R389 R390 R391 R392 R393 R394 R395 R396 R397 R398 R399 R400 R401 R402 R403 R404 R405 R406 R407 R408 R409 R410 R411 R412 R413 R414 R415 R416 R417 R418 R419 R420 R421 R422 R423 R424 R425 R426 R427 R428 R429 R430 R431 R432 R433 R434 R435 R436 R437 R438 R439 R440 R441 R442 R443 R444 R445 R446 R447 R448 R449 R450 R451 R452 R453 R454 R455 R456 R457 R458 R459 R460 R461 R462 R463 R464 R465 R466 R467 R468 R469 R470 R471 R472 R473 R474 R475 R476 R477 R478 R479 R480 R481 R482 R483 R484 R485 R486 R487 R488 R489 R490 R491 R492 R493 R494 R495 R496 R497 R498 R499 R500 R501 R502 R503 R504 R505 R506 R507 R508 R509 R510 R511 R512 R513 R514 R515 R516 R517 R518 R519 R520 R521 R522 R523 R524 R525 R526 R527 R528 R529 R530 R531 R532 R533 R534 R535 R536 R537 R538 R539 R540 R541 R542 R543 R544 R545 R546 R547 R548 R549 R550 R551 R552 R553 R554 R555 R556 R557 R558 R559 R560 R561 R562 R563 R564 R565 R566 R567 R568 R569 R570 R571 R572 R573 R574 R575 R576 R577 R578 R579 R580 R581 R582 R583 R584 R585 R586 R587 R588 R589 R590 R591 R592 R593 R594 R595 R596 R597 R598 R599 R600 R601 R602 R603 R604 R605 R606 R607 R608 R609 R610 R611 R612 R613 R614 R615 R616 R617 R618 R619 R620 R621 R622 R623 R624 R625 R626 R627 R628 R629 R630 R631 R632 R633 R634 R635 R636 R637 R638 R639 R640 R641 R642 R643 R644 R645 R646 R647 R648 R649 R650 R651 R652 R653 R654 R655 R656 R657 R658 R659 R660 R661 R662 R663 R664 R665 R666 R667 R668 R669 R670 R671 R672 R673 R674 R675 R676 R677 R678 R679 R680 R681 R682 R683 R684 R685 R686 R687 R688 R689 R690 R691 R692 R693 R694 R695 R696 R697 R698 R699 R700 R701 R702 R703 R704 R705 R706 R707 R708 R709 R710 R711 R712 R713 R714 R715 R716 R717 R718 R719 R720 R721 R722 R723 R724 R725 R726 R727 R728 R729 R730 R731 R732 R733 R734 R735 R736 R737 R738 R739 R740 R741 R742 R743 R744 R745 R746 R747 R748 R749 R750 R751 R752 R753 R754 R755 R756 R757 R758 R759 R760 R761 R762 R763 R764 R765 R766 R767 R768 R769 R770 R771 R772 R773 R774 R775 R776 R777 R778 R779 R780 R781 R782 R783 R784 R785 R786 R787 R788 R789 R790 R791 R792 R793 R794 R795 R796 R797 R798 R799 R800 R801 R802 R803 R804 R805 R806 R807 R808 R809 R810 R811 R812 R813 R814 R815 R816 R817 R818 R819 R820 R821 R822 R823 R824 R825 R826 R827 R828 R829 R830 R831 R832 R833 R834 R835 R836 R837 R838 R839 R840 R841 R842 R843 R844 R845 R846 R847 R848 R849 R850 R851 R852 R853 R854 R855 R856 R857 R858 R859 R860 R861 R862 R863 R864 R865 R866 R867 R868 R869 R870 R871 R872 R873 R874 R875 R876 R877 R878 R879 R880 R881 R882 R883 R884 R885 R886 R887 R888 R889 R890 R891 R892 R893 R894 R895 R896 R897 R898 R899 R900 R901 R902 R903 R904 R905 R906 R907 R908 R909 R910 R911 R912 R913 R914 R915 R916 R917 R918 R919 R920 R921 R922 R923 R924 R925 R926 R927 R928 R929 R930 R931 R932 R933 R934 R935 R936 R937 R938 R939 R940 R941 R942 R943 R944 R945 R946 R947 R948 R949 R950 R951 R952 R953 R954 R955 R956 R957 R958 R959 R960 R961 R962 R963 R964 R965 R966 R967 R968 R969 R970 R971 R972 R973 R974 R975 R976 R977 R978 R979 R980 R981 R982 R983 R984 R985 R986 R987 R988 R989 R990 R991 R992 R993 R994 R995 R996 R997 R998 R999 R1000



CAPACITORS SHOWN VALUE/VOLTAGE

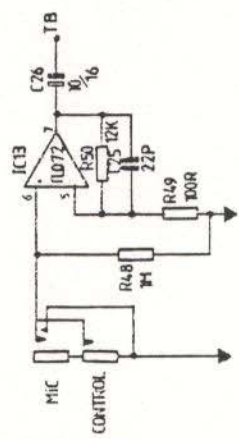

FOR PCB OVERLAY REFER TO DRAWING No BW 106
FOR FINAL ASSEMBLY REFER TO DRAWING No 489

ALTERATIONS		DESCRIPTION		DATE		APPROVED		CHECKED		APPROVED		DATE		SCALE	
1		ORIGIN		GMR	3.1.84								19.7.84		
No															

CMC SERIES
METER FCD. CIRCUIT
PCB AG0109 iss2

AHB
89 SHIP STREET,
BRIGLION BN114E
TEL 0273 24928

DRAWING No. MBD 121 iss1

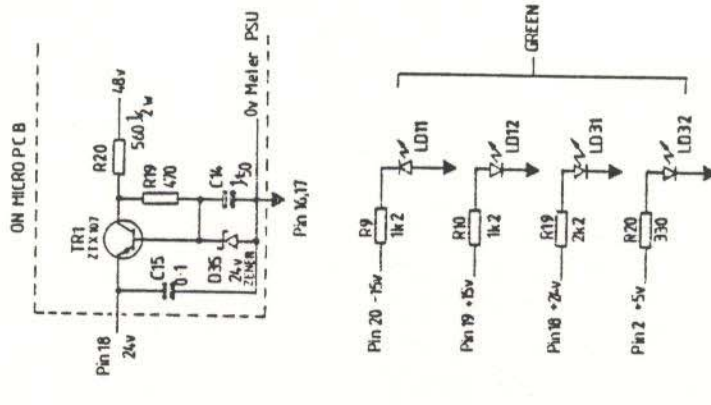
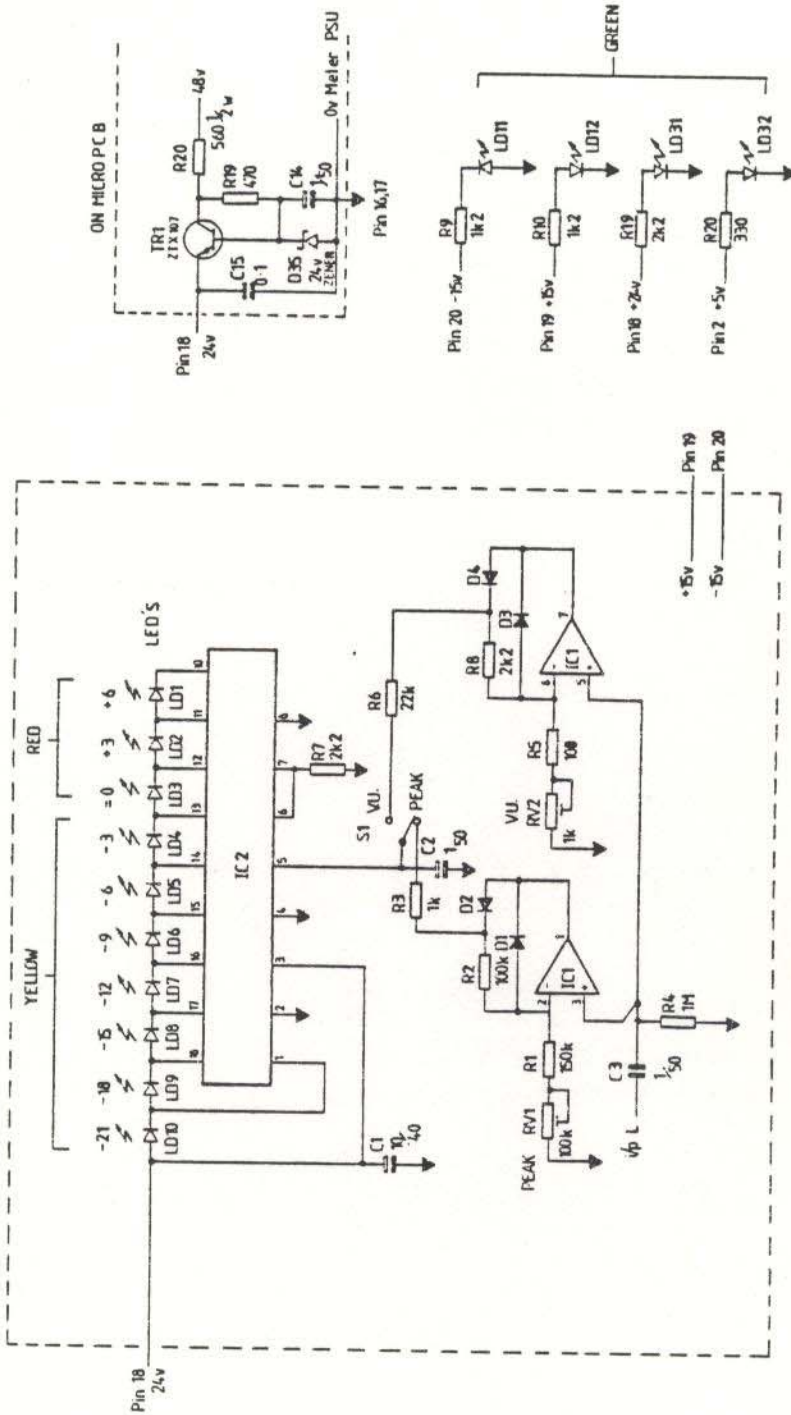

- D1 — D4 1N4148
 - IC 2 LM3915
 - IC 1 TL072
- RESET FOR SETTING
L & R METERS IN PEAK
AND VU MODES.

CCT Shows left bar meter
Right meter cct is identical
Right meter component ident as follow

Left	Right
C1	C1
R1	R1
RV1	RV1
D1	D1
IC1	IC1
LD1	LD1

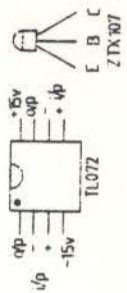

CAPACITORS SHOWN VALUE/VOLTAGE

ORIGIN	TRACED	CHECKED	APPROVED	DATE	SCALE
DESCRIPTION	GMR	KRP		6/2/85	
ALTERATIONS					
CMC SERIES					
CMC LEFT/RIGHT METER CIRCUIT					
FOR DISPLAY PCB AG0109 iss.B					
AHB 69 SHIP STREET BRIGHTON BN1 1AE Tel 0273 24928					
DRAWING No. MBD 117 iss 2					

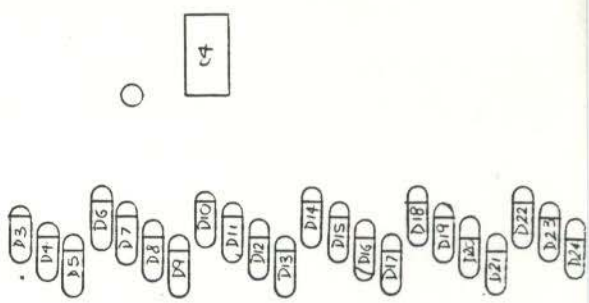
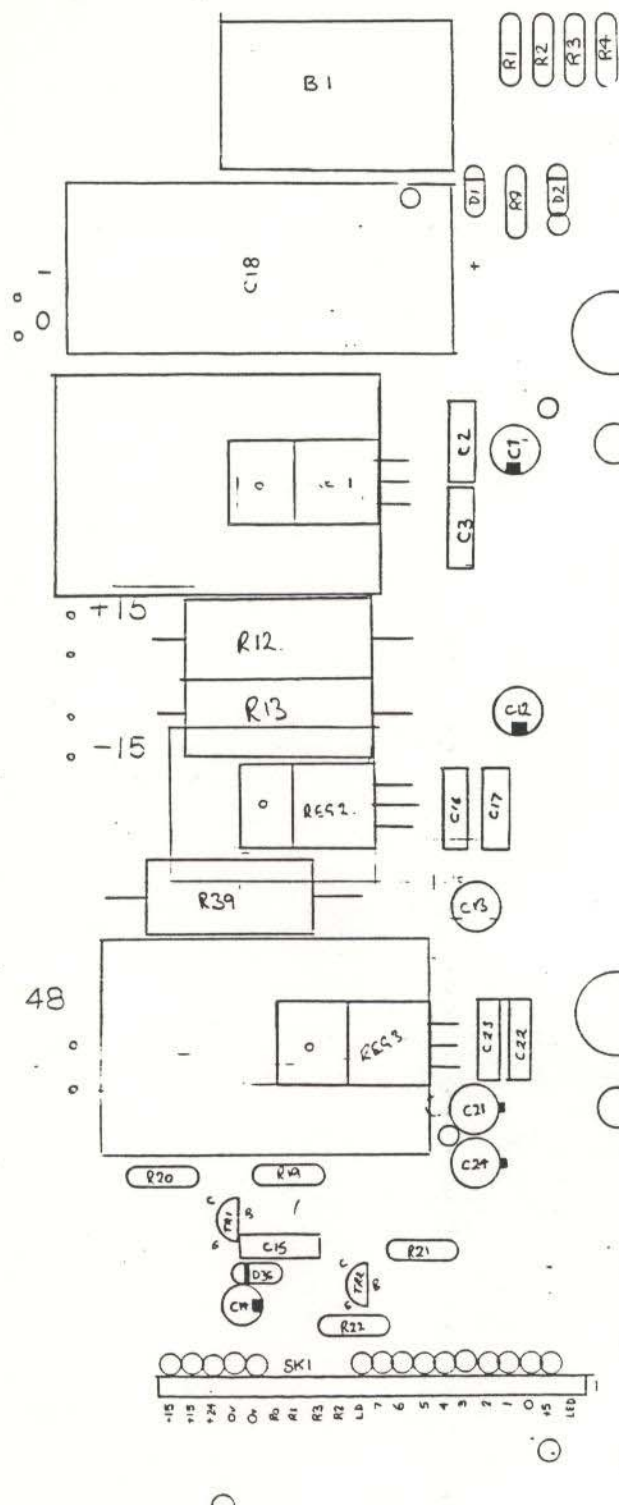

S1	S2	S3	S4	S5
S9	S10	S11	S12	S13

S17	S18	S19	S20	S21
S25	S26	S27	S28	S29

S33	S34	S35	S36	S37
-----	-----	-----	-----	-----

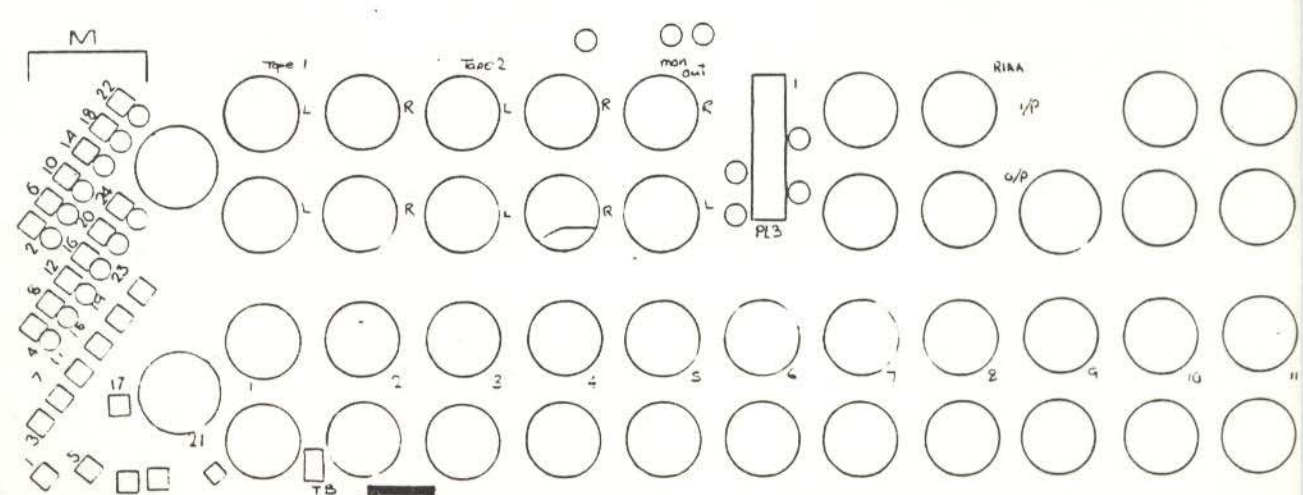
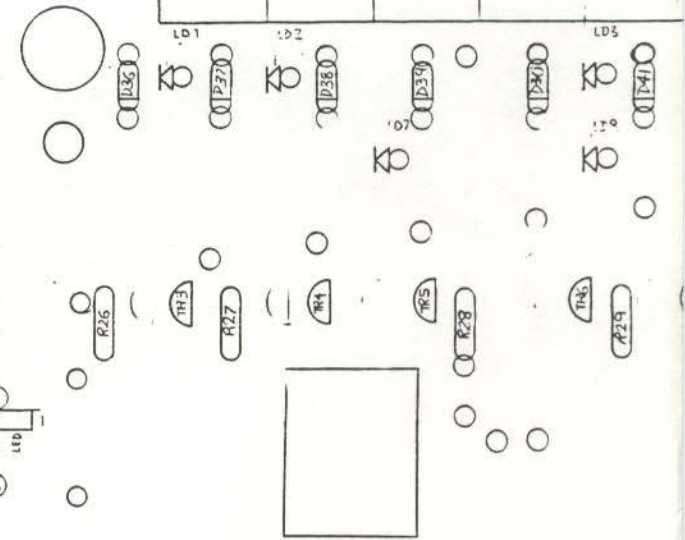
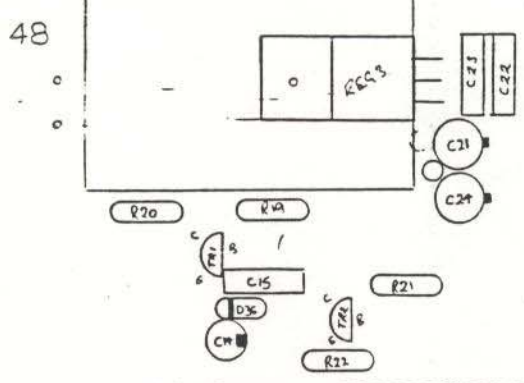

33

Mute + routing micro PCB layout p1

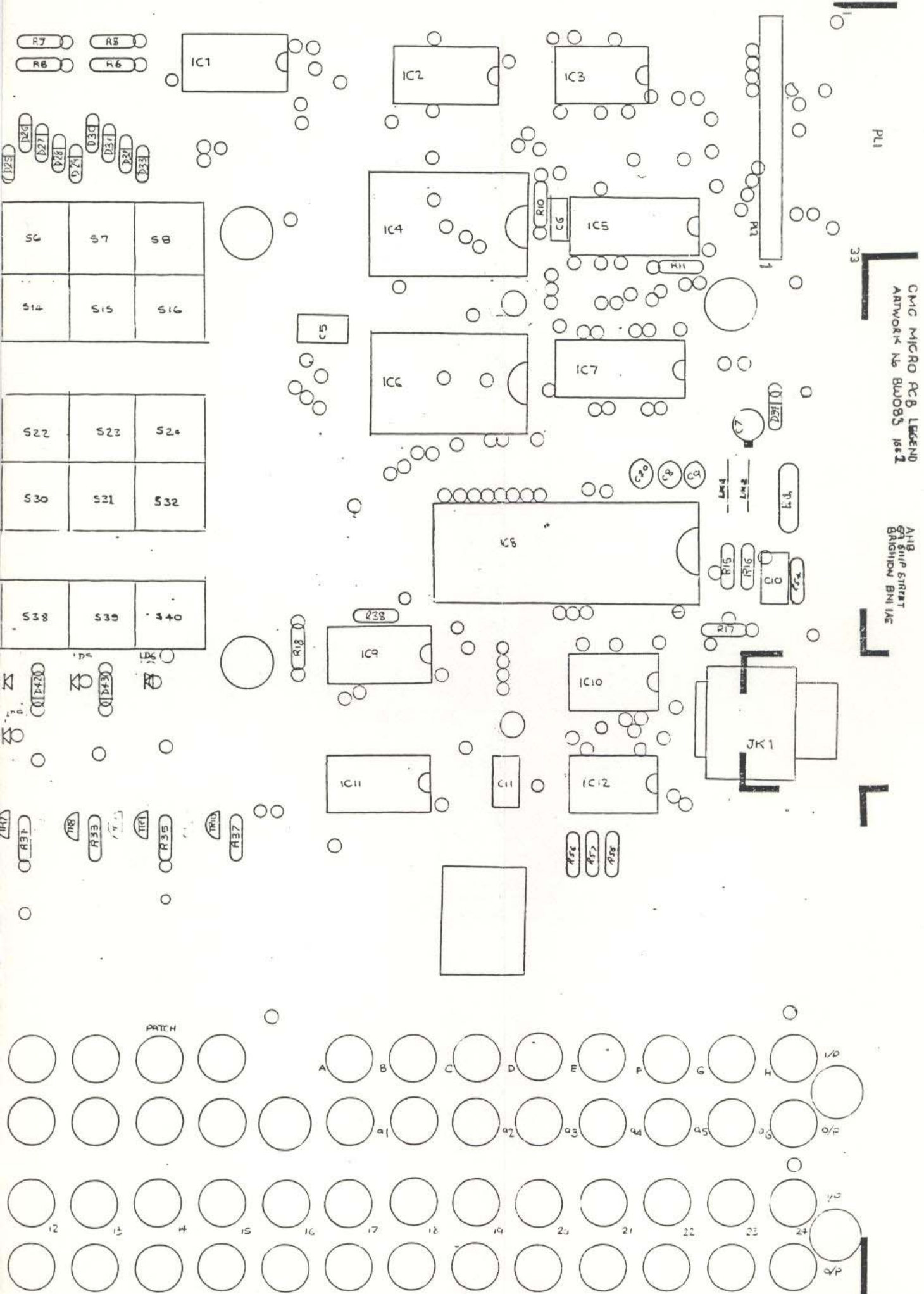

Mute + routing micro PCB layout p2

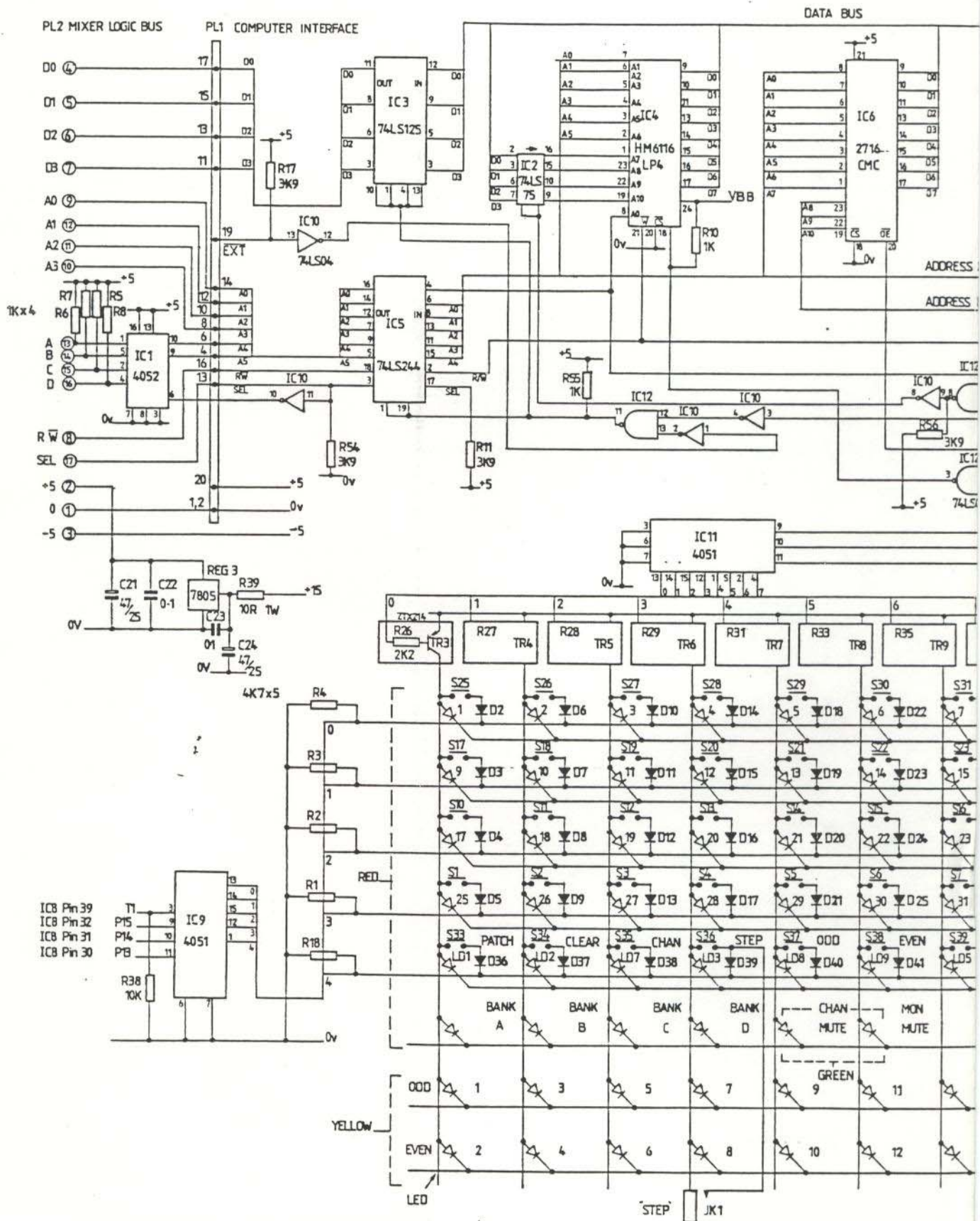

GMR		STANDARD NOTES		MATERIAL		TOLERANCES	
REG 3 ADDED	10 1 85	ALL DIMENSIONS IN mm	DO NOT SCALE DRAWING			GENERAL	±0.25 mm
INTERFACE MOD	28 11 84 GMR	THIRD ANGLE PROJECTION	REMOVE ALL BURRS & SHARP EDGES			HOLE CENTRES	±0.15 mm
ORIGIN	18984 GMR					HOLE SIZES	±0.10 mm
REVISION	DATE	CHECKED	SCALE			UNLESS STATED OTHERWISE	

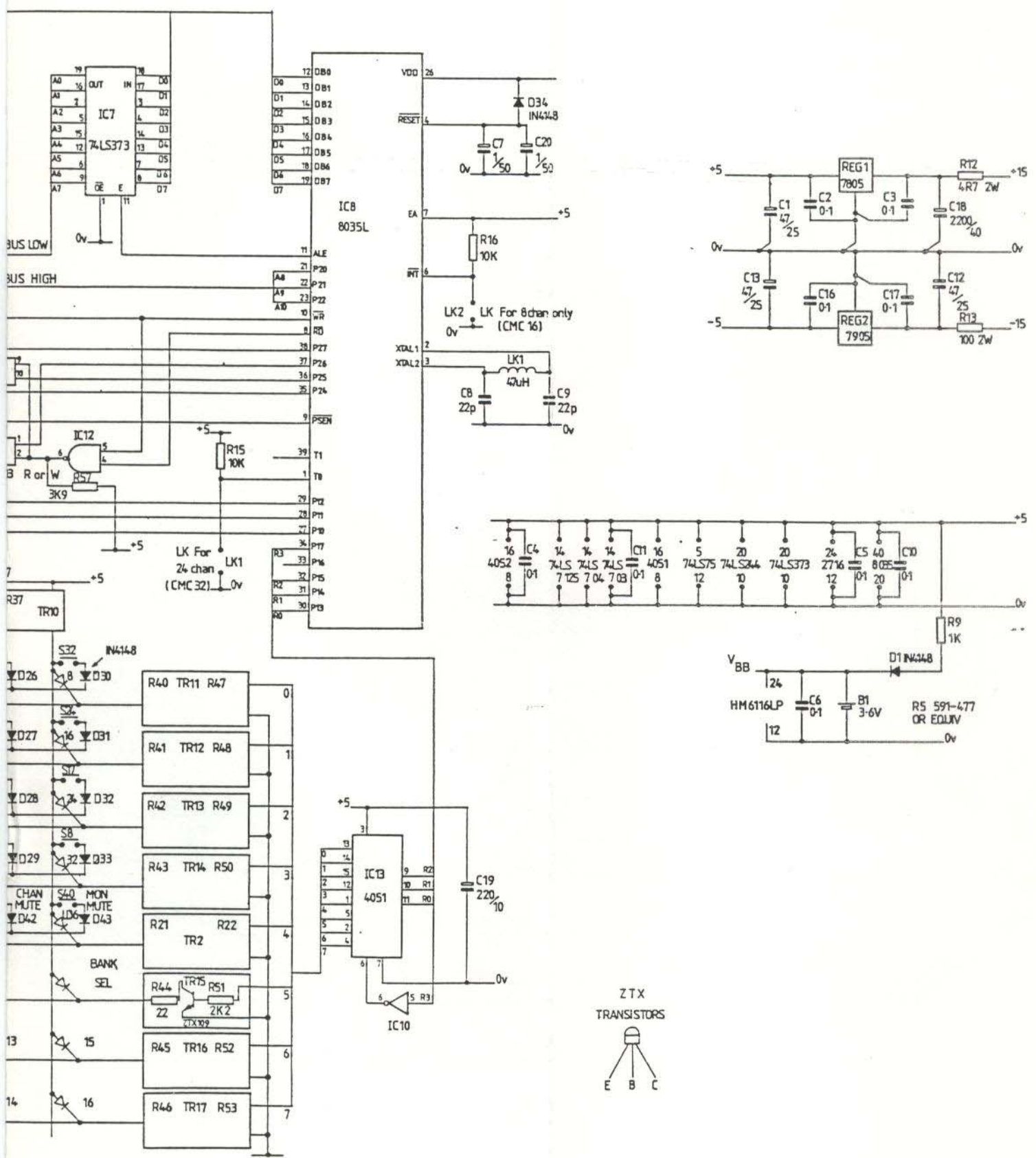

FINISH

NOTES
 CCT FOR CMC 1624, 32
 IC12 Changed from 74LS00 to 74LS03
 and second +5 Regulator added to micro
 pcb iss 2
 CAPACITORS SHOWN VALUE/VOLTAGE

UNIT TITLE
 CMC SERIES
DRAWING TITLE
 ROUTING AND MUTING CONTROLLER
 MICRO PCB AG0100 iss 2 DISPLAY PCB AG0101

AHB ALLEN & HEATH BRENNELL LTD.
 PROFESSIONAL AUDIO EQUIPMENT
 MANUFACTURERS
 69 SHIP STREET, BRIGHTON TEL 0273 24928
DRAWING No. MBD 110 iss 4

Sync system

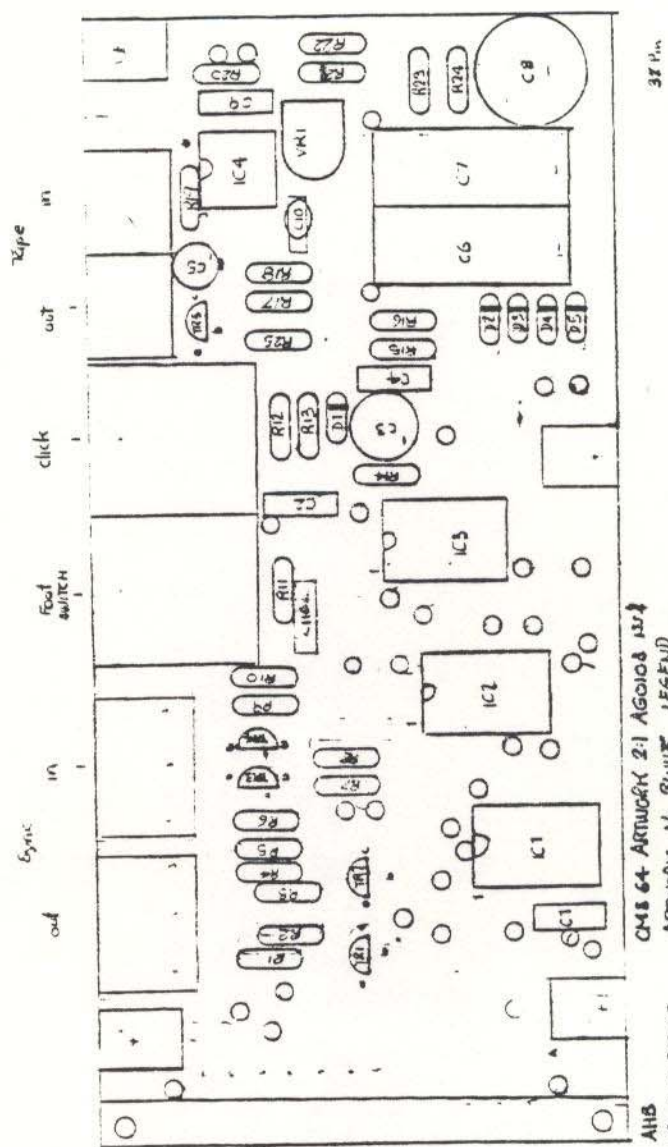

MS 64 ARTWORK 2:1 AGOLOS 127
ARTWORK No 61117 LEGEND

AHS
69 SHIP STREET,
BRIGHTON BN1 1AE
TEL 0273 24428

37 P.m

AHB
CMC SERIES
CMI 64 COMPONENT OVERLAY ISS 3

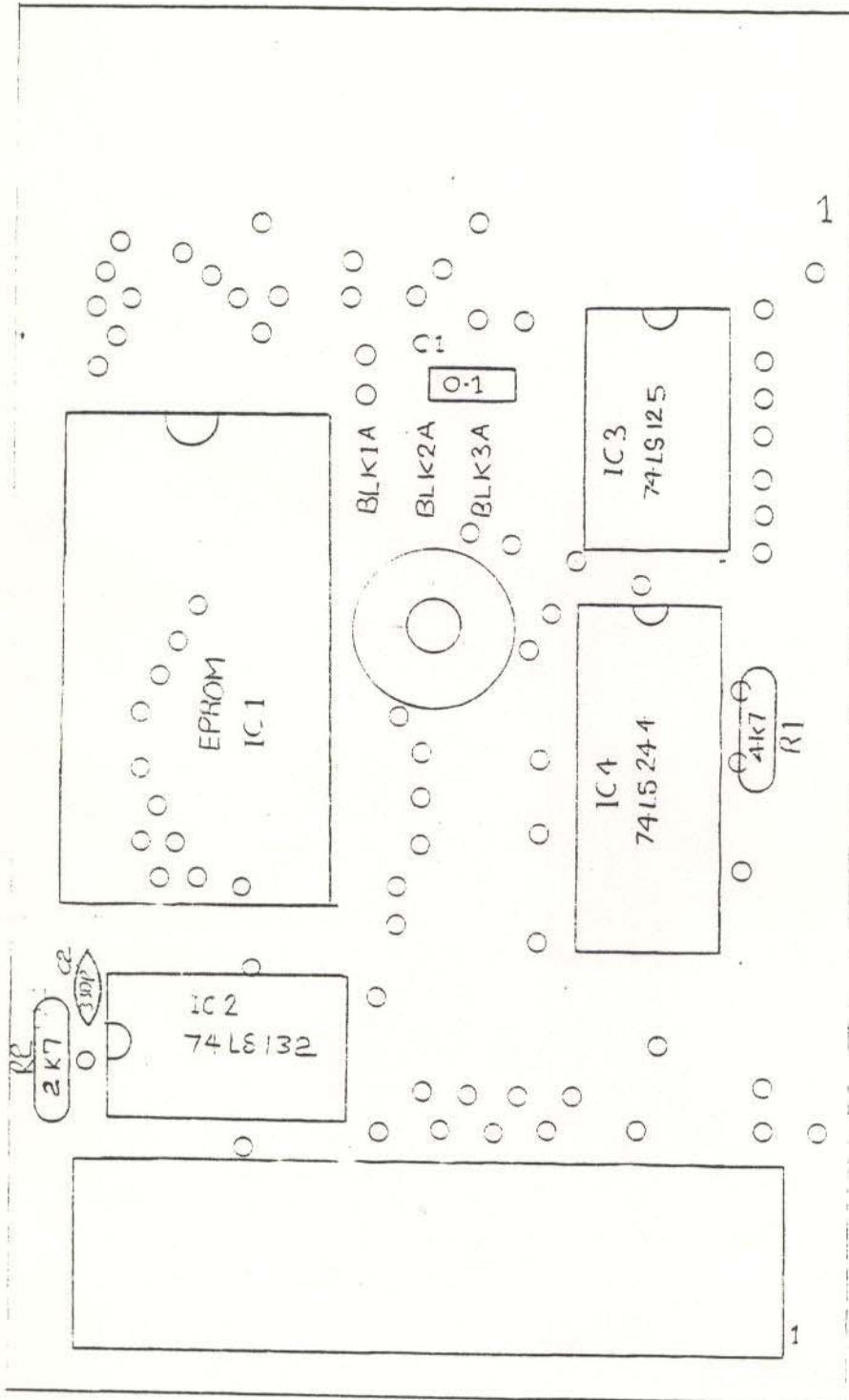

Computer interface

PINS 75

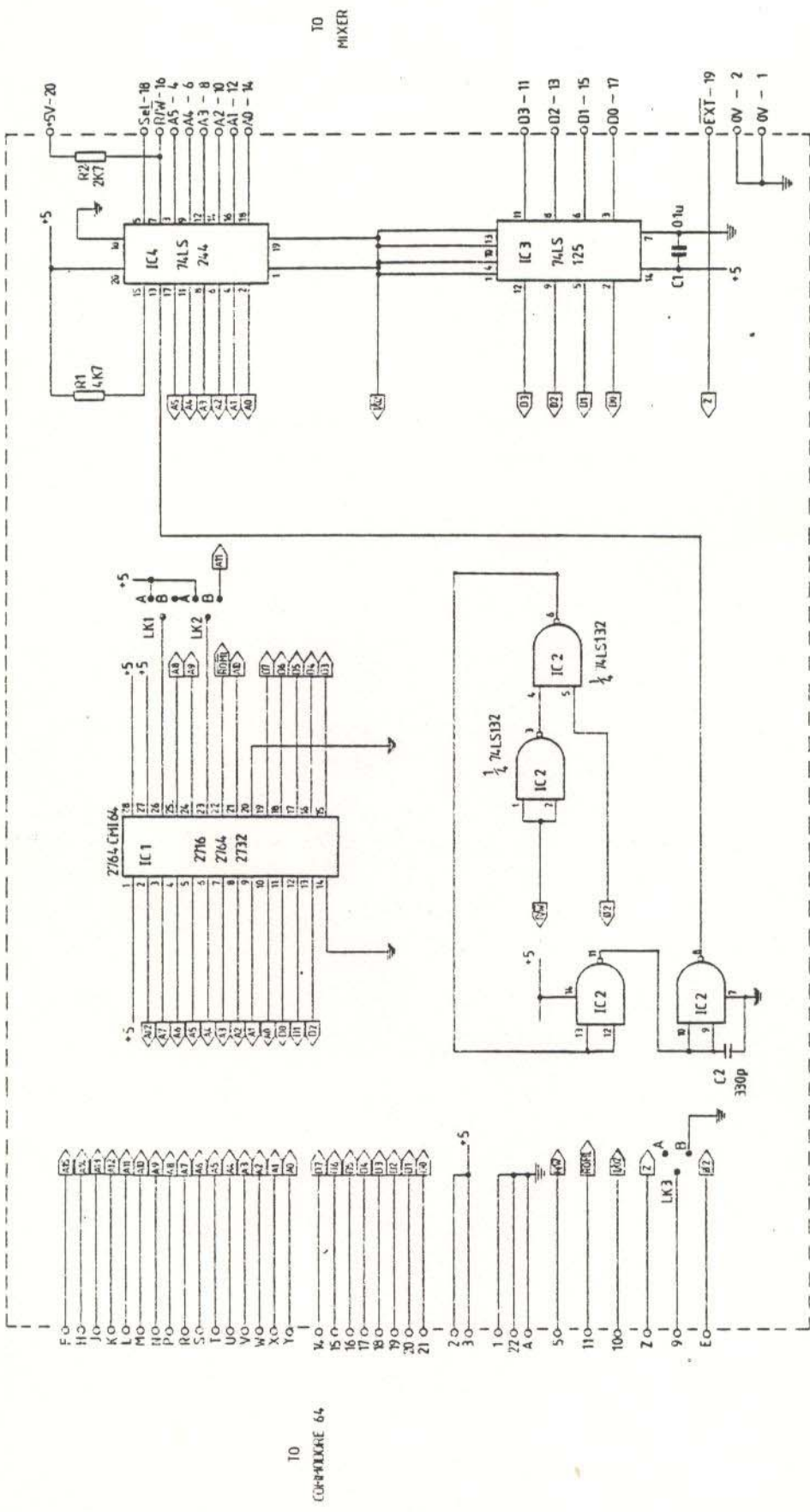

TO COMPARE 64

TO MIXER

- 7766 → Sited in lower 24 Pins 7766 → 28 Pins LK1 → A LK2 → B
- LK1 → A LK2 → A
- 7732 → Sited in lower 24 Pins LK3 A → CMI ROM DISABLED B → CMI ROM ENABLED
- LK1 → A LK2 → B

ALTERATIONS		CMC SERIES CMI 64 COMPUTER INTERFACE CIRCUIT PCB AG0107 Iss 3		AHB 69 SHIP STREET BRIGHTON BN1 1AE Tel 0273 26228		DRAWN GMR	TRACED KRP	CHECKED TR	APPROVED	DATE 2 3 85	SCALE
2	IC 2	CHANGED	ORIGIN								
1			DESCRIPTION								
2											

DRAWING No. MBD 118 iss 2

