

GL4

AUDIO MIXING CONSOLE

**ALLEN
&
HEATH**

**SERVICE
MANUAL**

PUBLICATION AP2109

INTRODUCTION

The information presented in this manual is intended for competent technical personnel to carry out service and product support for the *GL4*. We assume that the reader is familiar with the related electronic theory and audio terminology, and is able to carry out basic servicing, fault-finding and repair of audio equipment of this type. Service personnel should also be familiar with audio systems, mains earthing and power requirements, as well as handling precautions.

For further information on the operation and application of the *GL4* please refer to the **USER GUIDE** publication AP2108 supplied with each console.

Whilst we believe the information in this manual to be reliable we do not assume responsibility for inaccuracies. We also reserve the right to make changes in the interest of further product development.

SERVICE AND TECHNICAL SUPPORT

Under normal conditions the *GL4* does not require user maintenance or internal calibration. Any service work required should be carried out by qualified technical personnel only.

We are able to offer further product support through our worldwide distribution network. To help us provide the most efficient service please would you quote the console serial number in any communication regarding this product.

SAFETY WARNING !

Mains electricity is dangerous and can kill. Mains voltage is present within the console power supply unit. Do not remove the top cover with mains connected. Do not carry out any work within the unit while it is powered. High voltage components are insulated for safety but should not be touched with power applied. The mains voltage setting is factory wired and marked on the rear panel. Check that this matches your local mains supply. Check your mains wiring and earthing before switching on.

DO NOT REMOVE THE MAINS EARTH CONNECTION!

The console chassis is always connected to mains earth regardless of any settings of the Ground (earth) Lift option links.

This manual is printed in three sections:

SECTION A

provides all the technical information and service procedures as well as the fitting instructions and application notes for the *SYS-LINK* and *GL4-8S /M* kits. It also gives details how to order spare parts for the *GL4* console and *meterpod*, the *RPS10* power supply unit and the *RPSD* dual supply combiner/monitor. The contents of the *GL4* spares kits is also listed.

SECTION B

contains all the technical diagrams for the *GL4* console, the *meterpod* option and the *SYS-LINK* option. Any technical bulletins are also in this section. Technical information for the console power supply is given in Section C.

SECTION C

contains all the technical diagrams and information for the console power supply unit and the *RPSD* dual supply combiner/monitor. Spare parts and assemblies for the power supply are listed in Section A.

CONTENTS

SECTION A

TECHNICAL DESCRIPTION	2
STANDARD CONSOLE FORMATS & OPTIONS	3-4
DIMENSIONS FOR FLIGHTCASING	5
SPECIFICATION	6
REMOVING A CHANNEL, GROUP, L/R, or MASTER CIRCUIT BOARD	7
REMOVING THE MONO CIRCUIT BOARD	8
REMOVING A CONNECTOR CIRCUIT BOARD	9
GL4-8S /M FITTING INSTRUCTIONS	10-16
GL4 SYS-LINK FITTING INSTRUCTIONS	17-21
GL4 SYS-LINK APPLICATIONS NOTE	22-23
SPARE PARTS & ASSEMBLIES	24-28

SECTION B

TECHNICAL BULLETIN - Pre-fade Aux to Post EQ setting	
TECHNICAL BULLETIN - Bargraph LED meter glow	
FRONT PANEL LAYOUT	
REAR PANEL LAYOUT	
BLOCK DIAGRAM - MONO INPUT	
BLOCK DIAGRAM - STEREO INPUT	
BLOCK DIAGRAM - GROUP / AUX	
BLOCK DIAGRAM - AUX / MATRIX	
BLOCK DIAGRAM - MONITOR / TALKBACK	
BLOCK DIAGRAM - MUTE MICROPROCESSOR	
INTERNAL LAYOUT	
INTERNAL HARNESS LAYOUT - GL4-824	M000-026
INTERNAL HARNESS LAYOUT - GL4-832	M000-027
INTERNAL HARNESS LAYOUT - GL4-840	M000-028
MONO INPUT PCB COMPONENT IDENT	AG2001
MONO INPUT PCB CIRCUIT DIAGRAM	C2001
MONO INPUT CONNECTOR PCB COMPONENT IDENT	AG2006
MONO INPUT CONNECTOR DIAGRAM sheet 1	C2006
MONO INPUT CONNECTOR DIAGRAM sheet 2	C2006
STEREO INPUT PCB COMPONENT IDENT	AG2308
STEREO INPUT PCB CIRCUIT DIAGRAM	C2308
STEREO INPUT CONNECTOR PCB COMPONENT IDENT	AG2320
STEREO INPUT CONNECTOR DIAGRAM sheet 1	C2320
GROUP PCB COMPONENT IDENT	AG2002
GROUP CIRCUIT DIAGRAM sheet 1	C2002
GROUP CIRCUIT DIAGRAM sheet 2	C2002
LEFT/RIGHT PCB COMPONENT IDENT	AG2003
LEFT/RIGHT CIRCUIT DIAGRAM sheet 1	C2003
LEFT/RIGHT CIRCUIT DIAGRAM sheet 2	C2003
MASTER PCB COMPONENT IDENT	AG2004
MASTER CIRCUIT DIAGRAM	C2004
MONO/SLAVE PCB COMPONENT IDENT	AG2005A+B
MONO/SLAVE CIRCUIT DIAGRAM sheet 1	C2005

Schematics
published
separately

MONO/SLAVE CIRCUIT DIAGRAM sheet 2	C2005
MONO/SLAVE CIRCUIT DIAGRAM sheet 3	C2005
MONO/SLAVE CIRCUIT DIAGRAM sheet 4	C2005
MONO/SLAVE CIRCUIT DIAGRAM sheet 5	C2005
MASTER CONNECTOR PCB COMPONENT IDENT	AG2007
MASTER CONNECTOR DIAGRAM sheet 1	C2007
MASTER CONNECTOR DIAGRAM sheet 2	C2007
REAR CONNECTOR PCB EARTHING & MUTE BANK ASSIGNMENT	
METER PCB COMPONENT IDENT	AG2092
METER CIRCUIT DIAGRAM	C2092
SYS-LINK PCB COMPONENT IDENT	AG2210
SYS-LINK CIRCUIT DIAGRAM sheet 1	C2210
SYS-LINK CIRCUIT DIAGRAM sheet 2	C2210
CONSOLE POWER WIRING	M002-026C

SECTION C

TECHNICAL DESCRIPTION	
SERVICE ACCESS	
AC MAINS VOLTAGE SETTINGS	
RPS10 MAINS & DC WIRING	
RPS PCB COMPONENT IDENT	AG0256
RPS10 CIRCUIT DIAGRAM	C002-045
RPSD DUAL SUPPLY COMBINER / MONITOR	
RPSD INSTALLATION	
RPSD WIRING DIAGRAM	C002-056
RPSD PCB COMPONENT IDENT	AG2255
RPSD PCB CIRCUIT DIAGRAM	C2255

GL4-24

SECTION A

A

All metal chassis with aluminium extrusions to provide rigidity along the console length. The front panels are non-modular with 8 channel input blocks and a master panel incorporating 3 groups (left, right, mono) and master sections. The connectors are row and column mounted with individual connectors mounted on circuit boards in blocks of 8. The connector into the main console is via a 16 pin D-sub connector. The chassis is constructed from aluminium extrusions. The top touch front panel is designed to be easily cleaned.

SERVICE PROCEDURES

The GL4 is manufactured using the latest components and is designed to be reliable and robust. When operated correctly the normal performance of the console is maintained. The console is designed to be serviceable and the service procedures are detailed in this section.

Audio inputs and outputs are detailed in this section. All unbalanced connectors are line level 3 pin 1/2" jack sockets with low impedance outputs (e.g. 600 Ohm). The balanced connectors are XLR and the L and R outputs are electrically balanced (balanced outputs). The 24 pin D-sub connector is used to interface the console to external equipment. All outputs are low impedance and the console is designed to drive a range of equipment. All inputs and outputs are detailed in this section.

GL4-840

CAUTION !

TO AVOID DAMAGE TO INTERNAL COMPONENTS BY MISHANDLING AND/OR MISCONNECTION, ONLY TECHNICALLY COMPETENT PERSONNEL SHOULD ATTEMPT SERVICE WORK ON THIS CONSOLE.

When possible, disconnect connections for the L/R, MONO, AUX SENDS, L/R and MONO outputs to minimise noise pick-up. Avoid routing cables near to mains or lighting cables. Do not connect units or power supplies etc. The use of low impedance sources significantly reduces interference pick-up. Check the cables for correct wiring to avoid problems with phase reversal and unstable connections. The GL4 follows the convention for XLR pin 1 and jack pin 2 (signal hot (-)).

GL4-840PL PART LOADED

MAKE SURE THAT THE -HY SWITCHES ARE OFF WHEN THE CHANNEL INPUT XLR ARE CONNECTED TO NON-PHANTOM POWER MICROPHONES OR LIVE SOURCES.

If ground loop noise is present, connect the cable earth to the console earth. If the output may be connected to unbalanced inputs, connect the cable earth to the console earth (-) to V.E. ground.

TECHNICAL DESCRIPTION

The ALLEN & HEATH *GL4* is an 8 bus Front-of-House and 10 bus On-stage Monitor mixer. It can also be configured for full 8 track, stereo and mono recording. Standard formats are 24, 32 and 40 channels with an optional full length meterpod. *SYSLINK* expander system and *RPSD* dual supply combiner / monitor.

CONSTRUCTION

All metal chassis with aluminium extrusions to provide rigidity along the console length. The front panels are non modular with 8 channel input blocks and a master panel incorporating 8 groups, left, right, mono and master sections. The connectors are rear panel mounted with input connectors mounted on circuit boards in blocks of 8. The connectors in the master section are mounted on a single circuit board. The chassis base can easily be removed to gain service access. The soft touch front armrest is incorporated into the front extrusion running along the length of the console.

THE CIRCUIT COMPONENTS

The *GL4* is manufactured using high performance industry standard linear op-amp, digital and discrete semiconductor circuit devices. In particular the switches and potentiometers have proven to be durable and problem free. When operated correctly the normal performance of the unit introduces no noticeable audio signal degradation.

AUDIO INPUTS AND OUTPUTS

All XLR connector inputs and outputs are balanced. All unbalanced connections are line level 3-pole ¼" jack sockets with low impedance outputs and high impedance inputs. The channel mic and line inputs, and the L-R and Mono outputs are electronically balanced (differential). The SSM2142 differential output driver is used to balance the outputs. To use these with unbalanced equipment the -ve signal should be linked to 0V in the cable or input connector. All outputs are low impedance and thus capable of driving several high impedance inputs simultaneously. All inputs and outputs are in phase.

THE PFL/AFL SYSTEM

The console PFL (AFL) switches send pre- (post)-fade signals to the PFL (AFL) mix buses. These signals are switched with 4053 CMOS gates located on the MONO circuit board (PCB No: AG2005A). The supply for the 4053 is $\pm 7.5V$ DC and is derived locally from the $\pm 16V$. The gates are switched when a PFL or AFL switch is selected.

EARTHING THE AUDIO SYSTEM

The console chassis is connected to mains earth via the DC power cable. **FOR SAFETY REASONS NEVER REMOVE THE EARTH WIRE FROM THE POWER SUPPLY UNIT MAINS PLUG.** The console audio 0V may be connected to mains earth by linking the chassis 0V and audio 0V terminals on the rear connector panel. To prevent mains borne and external interference pick-up on the audio signal it is important that this audio 0V is connected to a good noise-free mains earth, either through the audio cable screens or by linking to a local earth. Multiple earth paths cause earth (ground) loops which may result in audible hum and interference. These may be avoided by making sure that there is only one path to earth from each piece of equipment, disconnecting audio cable screens at one end if necessary.

INTERCONNECTIONS

Where possible use balanced connections for the CHANNEL inputs, AUX SENDs, L/R and MONO outputs to minimise noise pick-up. Avoid running audio cables near to mains or lighting cables, thyristor dimmer units or power supplies etc. These may cause audible hum and buzz. The use of low impedance sources significantly reduces interference pick-up. Check the cables for correct wiring to avoid problems with phase reversal and unreliable connection. The *GL4* follows the convention for XLR pin 2 and jack tip = signal hot (+).

Always use balanced cables when connecting to phantom powered microphones.

MAKE SURE THAT THE +48V SWITCHES ARE OFF WHEN THE CHANNEL INPUT XLRs ARE CONNECTED TO NON-PHANTOM POWERED MICROPHONES OR LINE SOURCES.

If ground loops cause problems, connect the cable screen at one end only. Balanced outputs may be connected to unbalanced inputs and vice versa by linking the signal cold (-) to 0V ground.

STANDARD CONSOLES

All consoles supplied with separate RPS10 rack mount power unit.

Optional RPSD dual supply combiner / monitor.

Optional VU meterpod and optional SYS-LINK expander system.

GL4-24 24 inputs

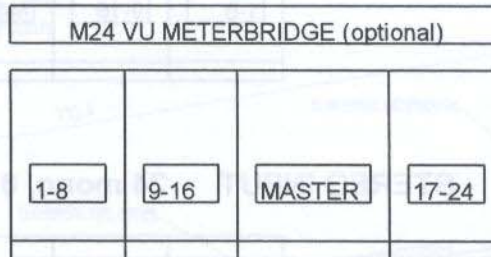

GL4-32 32 inputs

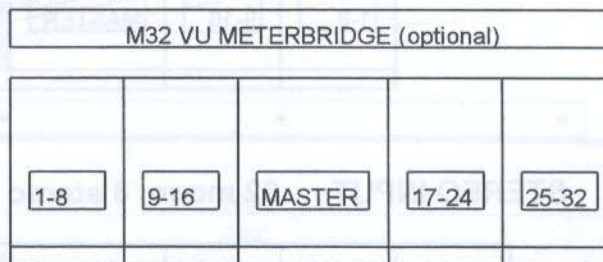

GL4-840 40 inputs

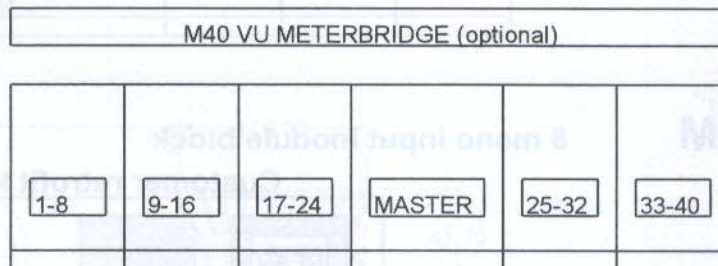

GL4-832PL PART LOADED 24 inputs, 1x blank panel

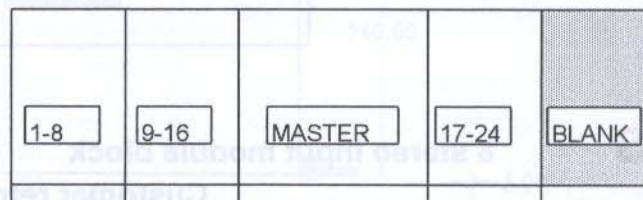

GL4-840PL PART LOADED 32 inputs, 1x blank panel

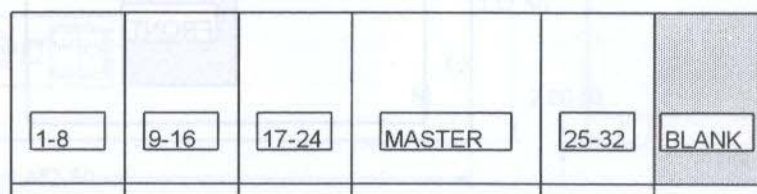

GL4-824ST STEREO INPUT 16 mono, 8 stereo inputs

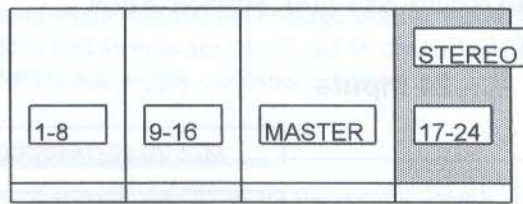

GL4-832ST STEREO INPUT 24 mono, 8 stereo inputs

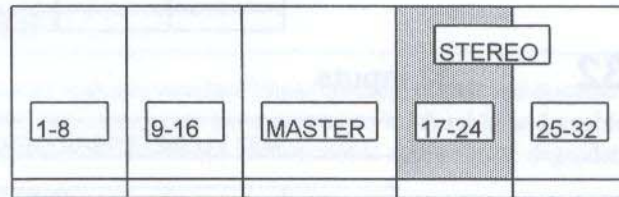

GL4-840ST STEREO INPUT 32 mono, 8 stereo inputs

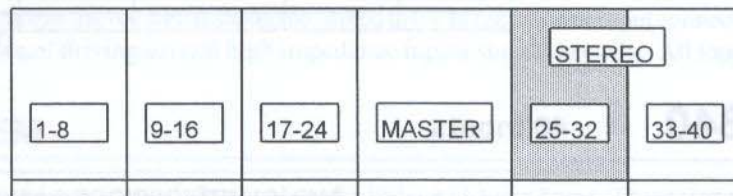

GL4-8M 8 mono input module block

Customer retrofit kit option

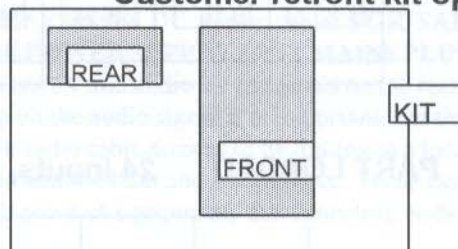

GL4-8S 8 stereo input module block

Customer retrofit kit option

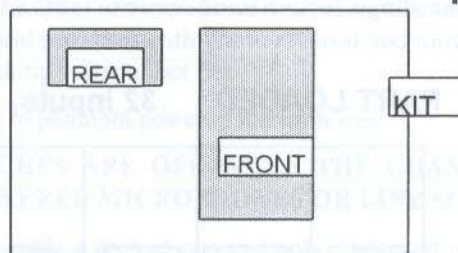

DIMENSIONS

The diagrams below give the dimensions for flightcasing the console and power supply unit.

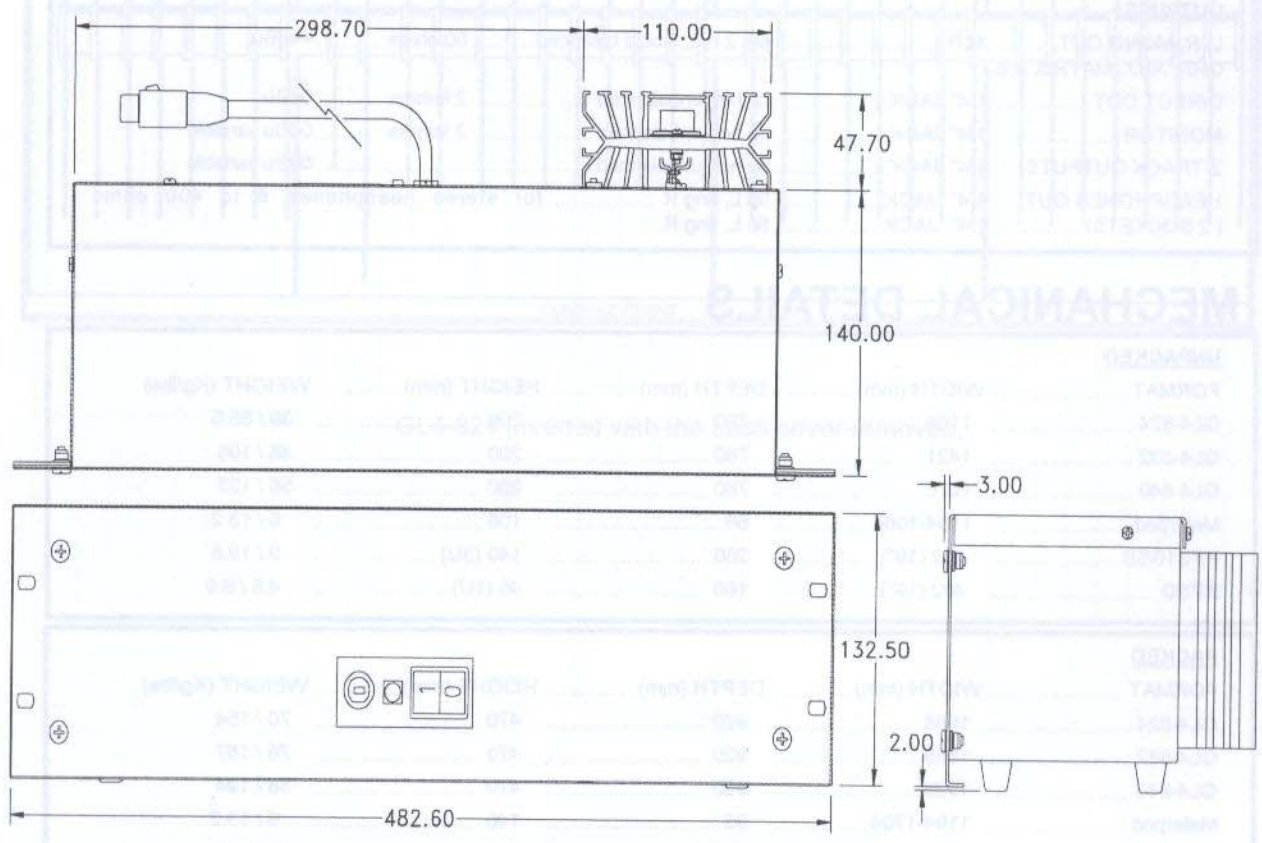
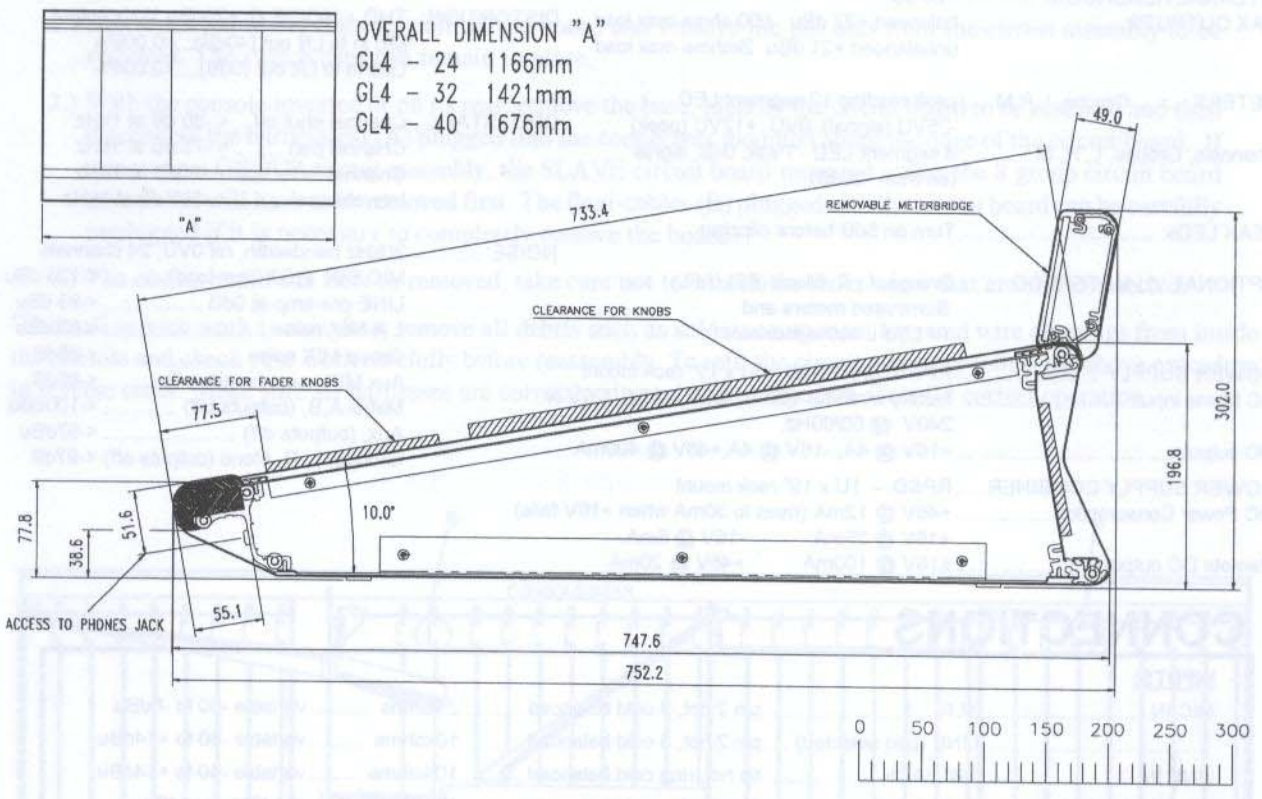

SPECIFICATION

0 dBu = 0.775 Volts RMS

0 dBV = 1 Volt RMS

Line level options: +4dBu (high level), 0dBu, -10dBV (300mV low level)

INTERNAL OPERATING LEVEL: -2 dBu

INTERNAL HEADROOM: +23 dB

MAX OUTPUTS: balanced +27 dBu 600 ohms max load
..... unbalanced +21 dBu 2kohms max load

METERS: Groups, L,R,M peak reading 12 segment LED
..... -25VU (signal), 0VU, +12VU (peak)

Channels, Groups, L, R, M 3 segment LED - Peak, 0dB, signal
(on from -20dB)

PEAK LEDs: Turn on 5dB before clipping

OPTIONAL VU METERPOD Groups, L, R, Mono (PFL/AFL)
..... illuminated meters and
..... PFL/AFL active indicator

POWER SUPPLY RPS10 or RPS5B - 3U x 19" rack mount
AC Mains input: factory wired for 100V, 110V, 120V, 220V or
..... 240V @ 50/60Hz.

DC output: +16V @ 4A, -16V @ 4A, +48V @ 400mA

POWER SUPPLY COMBINER RPSD - 1U x 19" rack mount

DC Power Consumption +48V @ 12mA (rises to 30mA when +16V fails)
..... +16V @ 25mA -16V @ 5mA.

Remote DC output ±16V @ 100mA +48V @ 20mA

FREQUENCY RESPONSE: 20Hz to 30kHz +0/-1dB

DISTORTION: THD + NOISE @ +20dBu 1kHz output
Mic in to LR out (40dB).....<0.006%
Line in to LR out (0dB).....<0.006%

CROSSTALK: Channel shut off ... < -80 dB at 1kHz
Channel pan < -75 dB at 1kHz
Channel fader down<-90dB at 1kHz
Interchannel < -100 dB at 1kHz

NOISE: 20kHz bandwidth, ref 0VU, 24 channels
MIC EIN (150 Ohm load) <-128 dBu
LINE pre-amp at 0dB <-93 dBu
L R MIX noise <-83 dBu
Group MIX noise <-85dB
Aux MIX noise (sends off) <-85dB
Matrix A,B, (outputs off) <-100dBu
Aux, (outputs off) <-97dBu
Groups, L, R, Mono (outputs off) <-97dB

CONNECTIONS

INPUTS:

MIC IN XLR pin 2 hot, 3 cold balanced 2 kohms variable -60 to -6dBu
..... LINE (pad selected) pin 2 hot, 3 cold balanced 10kohms variable -40 to +14dBu
LINE IN 1/4" JACK tip hot, ring cold balanced 10 kohms variable -40 to +14dBu
AUX RETURN IN 1/4" JACK tip hot, ring cold balanced 10 kohms -10dBV or +4dBu
INSERTS 1/4" JACK tip send, ring return unbalanced 0dBu, Outputs -2dBu
2-TRACK INPUT 1/4" JACK unbalanced 10 kohms variable -10dBV

OUTPUTS:

L, R, MONO OUT, XLR pin 2 hot, 3 cold balanced 50 ohms +4dBu .
GRP, AUX, MATRIX A,B
DIRECT OUT 1/4" JACK tip hot, unbalanced 2 kohms 0dBu
MONITOR 1/4" JACK tip hot, unbalanced 2 kohms 0dBu variable
2-TRACK OUTPUTS 1/4" JACK tip hot, unbalanced 0dBu variable
HEADPHONES OUT 1/4" JACK tip L, ring R for stereo headphones 8 to 400 ohms
(2 SOCKETS) 1/4" JACK tip L, ring R

MECHANICAL DETAILS

UNPACKED

FORMAT	WIDTH (mm)	DEPTH (mm)	HEIGHT (mm)	WEIGHT (Kg/lbs)
GL4-824	1166	780	200	39 / 85.5
GL4-832	1421	780	200	48 / 106
GL4-840	1676	780	200	56 / 123
Meterpod	1154-1664	56	106	6 / 13.2
RPS10/5B	482 (19")	260	140 (3U)	9 / 19.8
RPSD	482 (19")	180	45 (1U)	4.5 / 9.9

PACKED

FORMAT	WIDTH (mm)	DEPTH (mm)	HEIGHT (mm)	WEIGHT (Kg/lbs)
GL4-824	1668	920	470	70 / 154
GL4-832	1668	920	470	76 / 167
GL4-840	1923	920	470	88 / 194
Meterpod	1194-1704	96	146	6 / 13.2
RPS10/5B	520	400	320	11 / 24.2
RPSD	520	400	115	6 / 13.2

REMOVING A CHANNEL, GROUP, L/R, or MASTER CIRCUIT BOARD

Before beginning any service work, remove all power to the console and disconnect any signal cables where necessary. Service work is best carried out with the console inverted or positioned upright on its rear with the connectors removed. Ensure adequate lighting and use the correct tools. Access to the CHANNEL, GROUP, L/R or MASTER circuit board is as follows:

- 1.) Before inverting the console, pull off the knobs and remove the pot nuts from the circuit assembly to be removed. The switch caps can remain in place.
- 2.) With the console inverted or on its rear, remove the base, identify the circuit board to be removed and then disconnect the harness(es) (A) plugged into the connectors mounted along the edge of the circuit board. If removing a GROUP circuit assembly, the SLAVE circuit board mounted across the 8 group circuit board assemblies will have to be removed first. The flexi-cables (B) plugged into the circuit board can be carefully unplugged if it is necessary to completely remove the board.
- 3.) The circuit board can now be removed, take care not to stretch the fader wires that are still connected.

When all service work is complete, remove all debris such as solder, component legs and wire clippings from inside the console and check your work carefully before reassembly. To refit the circuit assembly follow the above procedure in reverse order. Make sure all harnesses are correctly aligned and plugged on. Test for correct operation.

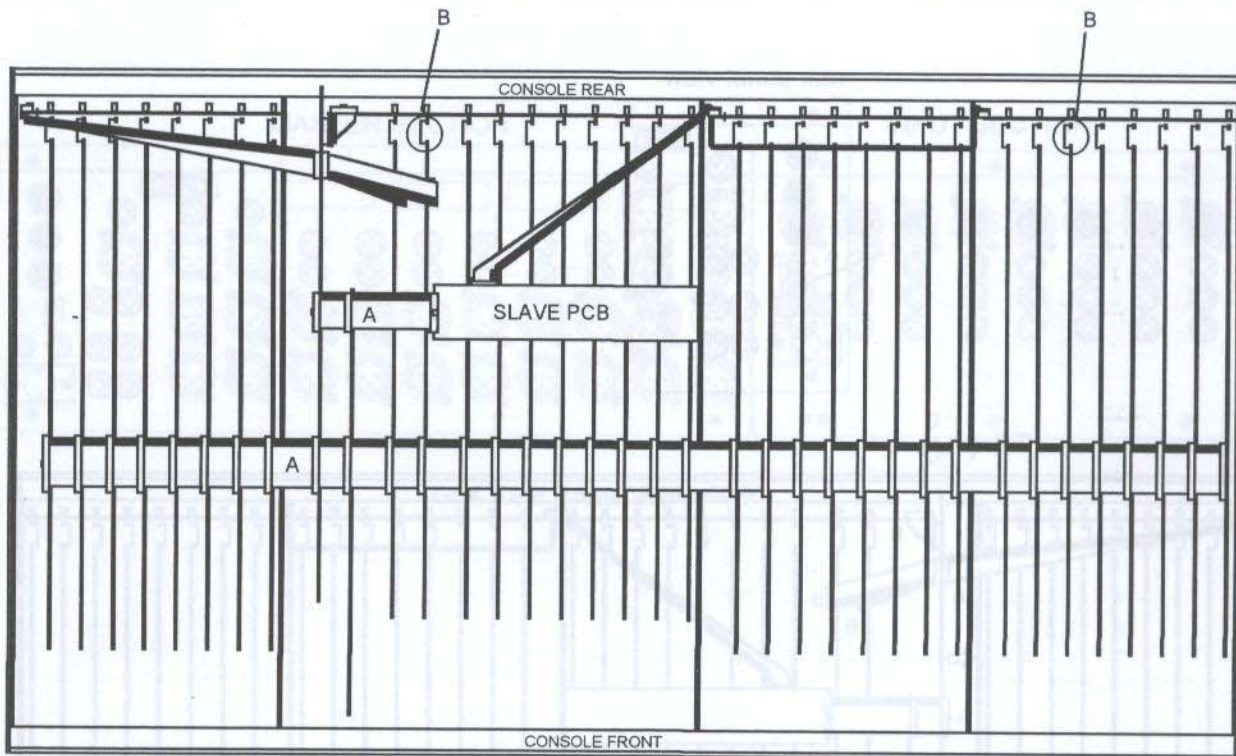

GL4-824 inverted with the base cover removed.

REMOVING THE MONO CIRCUIT BOARD

Before beginning any service work remove all power to the console and disconnect any signal cables where necessary. Service work is best carried out with the console inverted or positioned upright on its rear with the connectors removed. Ensure adequate lighting and use the correct tools. Access to the MONO circuit board is as follows:

- 1.) Before inverting the console, pull off the knobs and remove the pot nuts from the MONO section. The switch caps can remain in place.
- 2.) With the console inverted or on its rear, remove the base, identify the MONO circuit board and then disconnect the three harnesses (A) plugged into the connectors mounted along the edge of the circuit board. The harnesses (B) plugged into the back of the circuit board **cannot** be removed and must be disconnected at the other end.
- 3.) Working from the rear of the console, remove the screw (C) near to the MIDI channel assign switches on the rear connector panel. The circuit board can now be removed by first tilting the board to the right to clear the two earth terminals and then freeing the board from the front panel. It may be necessary to reposition the power XLR wiring if it hinders the removal of the MONO circuit board. Take care not to stretch the fader and power wires that are still connected. Also make sure that the two power resistors in the power XLR wiring are positioned clear of any wiring.

When all service work is complete, remove all debris such as solder, component legs and wire clippings from inside the console and check your work carefully before reassembly. To refit the MONO circuit assembly follow the above procedure in reverse order. Make sure all harnesses are correctly aligned and plugged on. Test for correct operation.

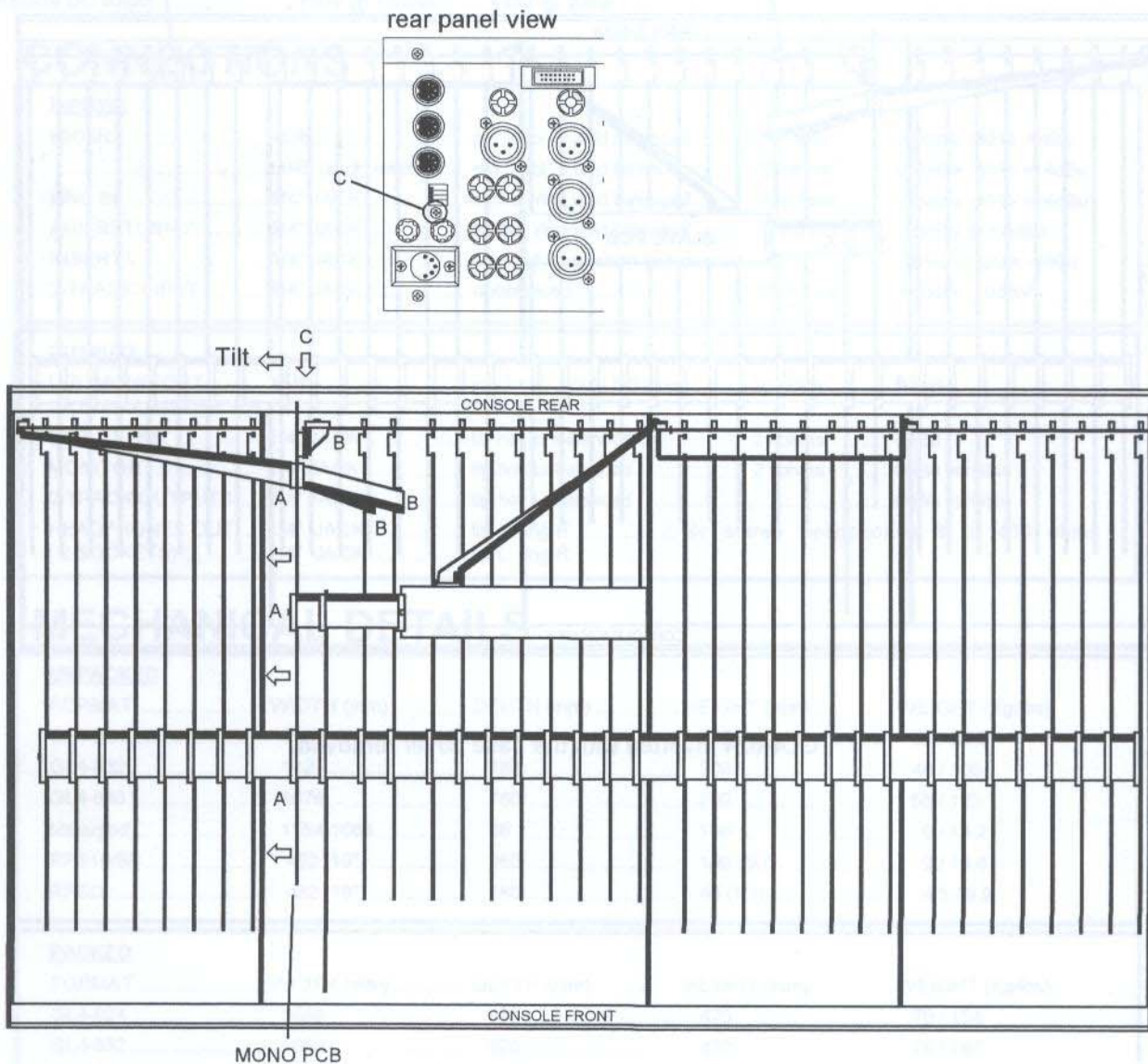

GL4-824 inverted with the base cover removed.

REMOVING A CONNECTOR CIRCUIT BOARD

Before beginning any service work, remove all power to the console and disconnect any signal cables where necessary. Service work is best carried out with the console inverted on a clean work surface suitably covered to protect the console cosmetics. Ensure adequate lighting and use the correct tools. Access to the connector circuit boards is as follows:

- 1.) With the console inverted, remove the base. Identify which connector board is to be removed and then disconnect the harnesses to it.
- 2.) Working from the rear of the console remove the screws (A) fixing the XLR connectors to the panel but do not remove the screws (B) fixing the panel to the chassis. Using a coin or other implement rotate the jack socket nuts (C) through 45 degrees in a counter-clockwise direction. On consoles with serial numbers after 621468 the jack nuts are 12mm hex nuts. Remove the jack nuts.
- 3.) The circuit board can now be freed from the rear panel **but** before lifting the circuit board clear, carefully release the green earth wire running between the row of jack sockets.
- 4.) If the circuit assembly is to be completely removed, the green earth wire will have to be desoldered and the flexi-links will have to be carefully unplugged.

When all service work is complete, remove all debris such as solder, component legs and wire clippings from inside the console and check your work carefully before reassembly. To refit the connector circuit assembly follow the above procedure in reverse order. Make sure all harnesses are correctly aligned and plugged on. Test for correct operation.

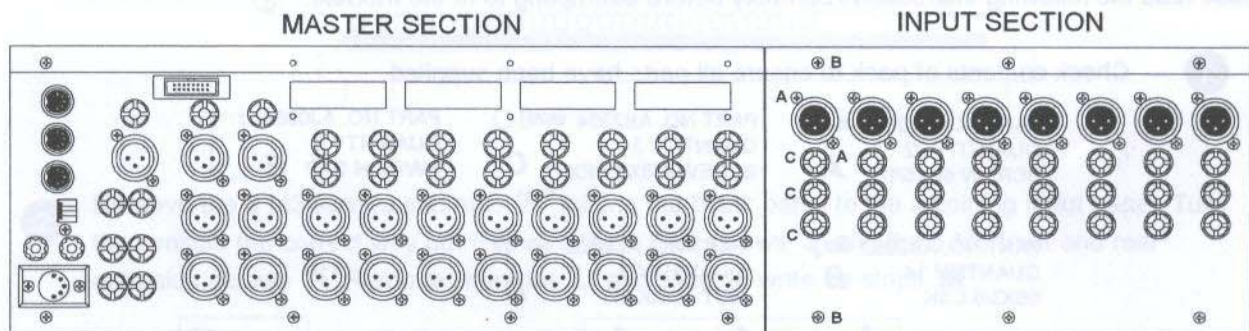

GL4 Rear Panel View.

GL4-8S / M

PART NO.s GL4-8S
GL4-8M



8 CHANNEL STEREO OR MONO MODULE FOR GL4 PART LOADED MODELS

AP2299 ISSUE 1

FITTING INSTRUCTIONS

INTRODUCTION

The GL4-8S and GL4-8M are 8 channel input blocks (stereo and mono respectively) for fitting to GL4 Part Loaded Models. They are not suitable for expanding a standard GL4 console. Please read the following instructions carefully before attempting to fit the module.

- 1** Check contents of pack to ensure all parts have been supplied.

PART NO. AB2084)
QUANTITY 22
SCREW 6BX5/16 **A**

PART NO. AB2304)
QUANTITY 3
SCREW M3X8 HEX **C**

PART NO. AJ0364)
QUANTITY 8
SWITCH CAP **E**

PART NO. AB2082)
QUANTITY 14
NUT 6BX3/8 CSK **B**

PART NO. AB0102)
QUANTITY 3
NUT LOCK M3 **D**

CONNECTOR PANEL WITH
FLEXI CABLES IDC HARNESS
FITTED **F**

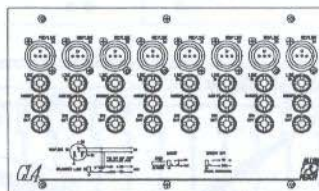

THESE
FITTING
INSTRUCTIONS

FRONT PANEL ASSEMBLY **G**

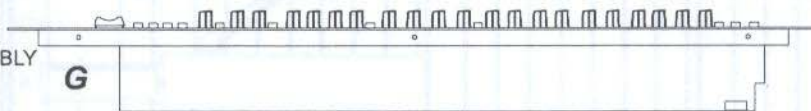

- 2** Tools required

SOLDER

1-POINT POZI

HEX KEY 4mm

5.5mm AF SPANNER X 2

FINE TIP SOLDERING IRON

FLAT POINT SCREWDRIVER

LONG NOSE PLIERS

REMOVAL OF BLANK PANELS

Disconnect GL4 from Power Supply Unit and cables before fitting the module

- 1 Ensure you have a good work surface and clear area before starting work. Remove the optional Meterbridge if fitted. Carefully invert the console. Remove 6B screws 'A' and base panel 'N' as shown.

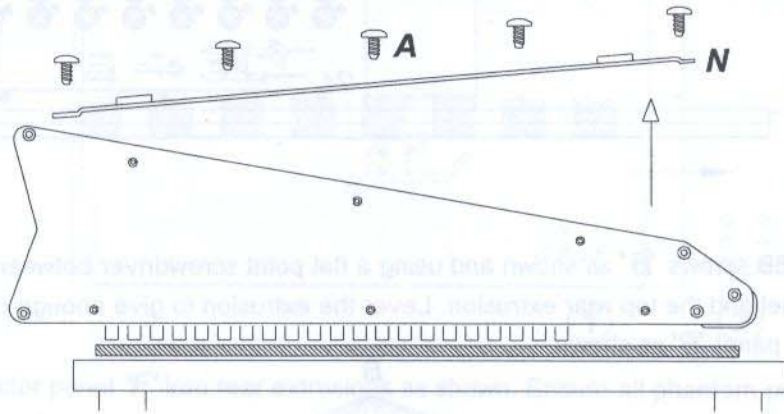

- 2 Remove the 3 M3 screws and nuts 'H' joining the blank panel to the adjoining input panel. Turn the console the correct way up. Remove the 3 8AB screws 'J' and the 5 M6 front and rear extrusion screws 'K'. Remove side trim 'L' and slide off write on strips 'M'.

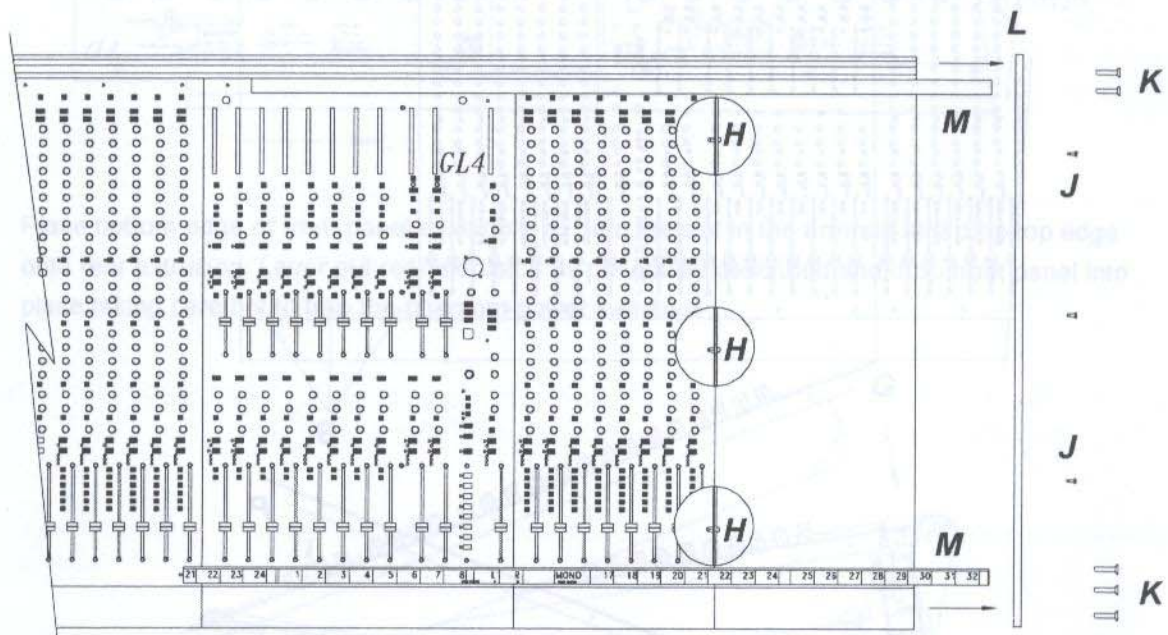

- 3 Remove the 6 6B screws 'A' attaching the blank connector panel to the rear extrusions and slide out as shown.

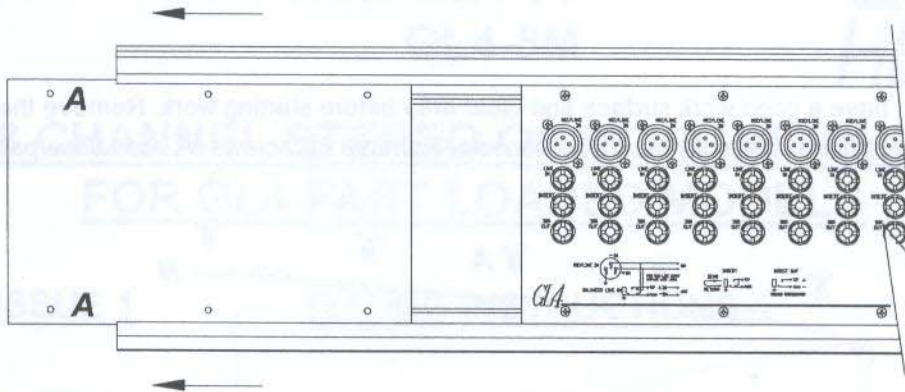

- 4 Remove the 6B screws 'B' as shown and using a flat point screwdriver between the flanges of the blank panel and the top rear extrusion. Lever the extrusion to give enough clearance to lift out the blank panel 'P' as shown.

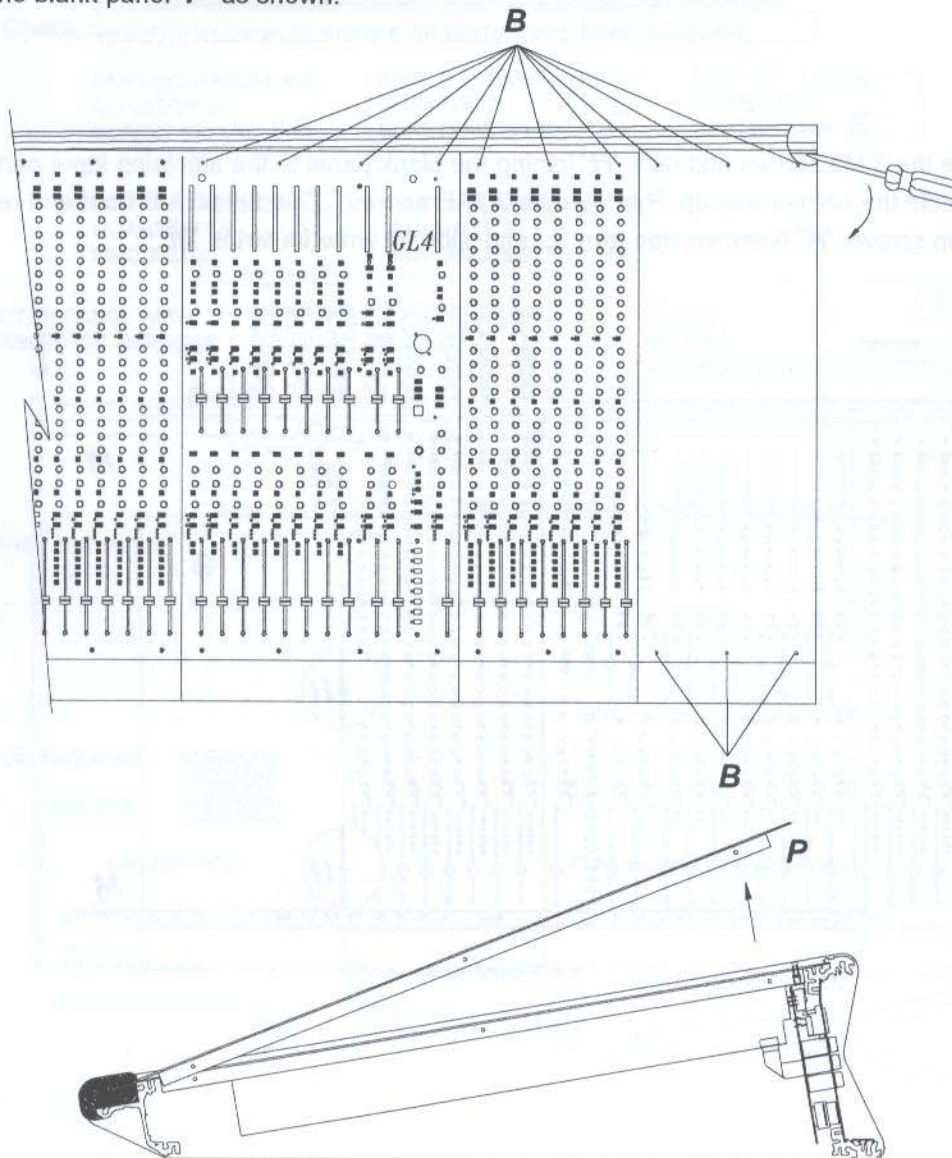

INSTALLATION OF MODULE

1 Fit channel assignment link as shown dependent on the final size of expanded console.

- ① 32 channel console
- ② 40 channel console

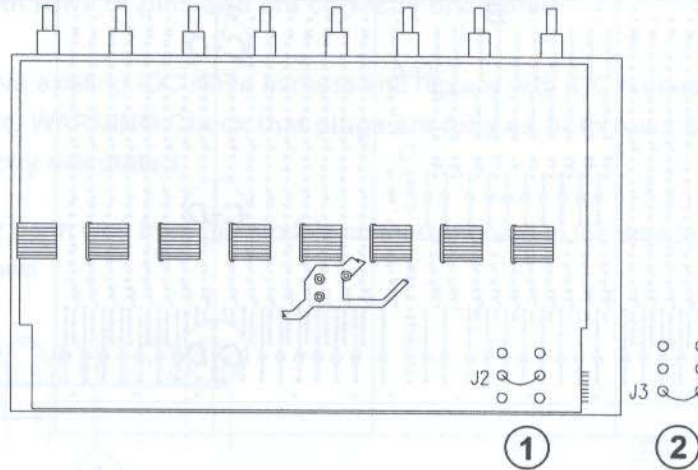

2 Slide connector panel 'F' into rear extrusions as shown. Ensure all phantom power switches 'Q' are pressed.

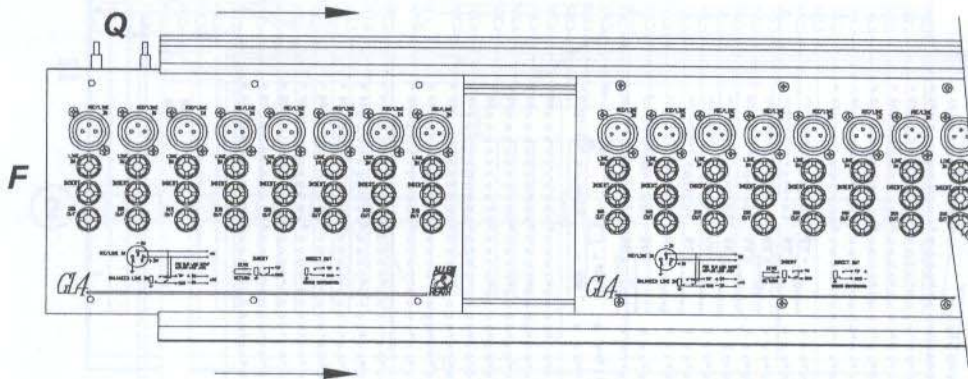

3 Place bottom edge of front panel assembly 'G' into the slot in the armrest and drop top edge onto rear extrusion. Lever out rear extrusion as previously described and drop front panel into place taking care not to trap the phantom power switches.

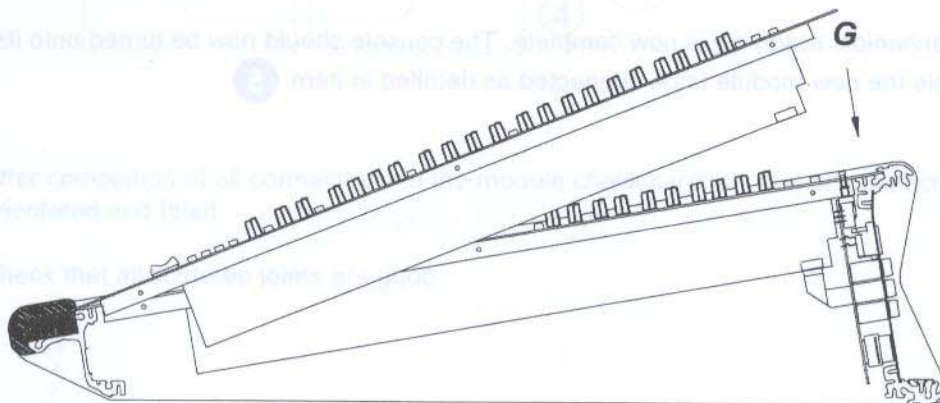

- 3
- 1 Temporarily fit side trim 'L' to align holes.
 - 2 Fit M3 Hex screws 'C' and nuts 'D' provided as shown
 - 3 Replace all panel screws 'A' and 'B'.

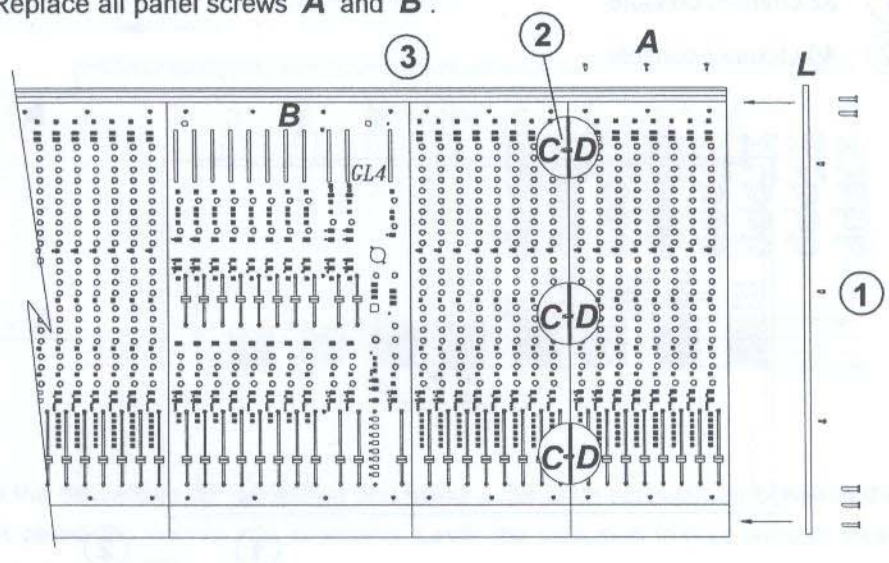

- 4 Remove side trim 'L'. Replace write on strips 'M' and replace side trim 'L'.

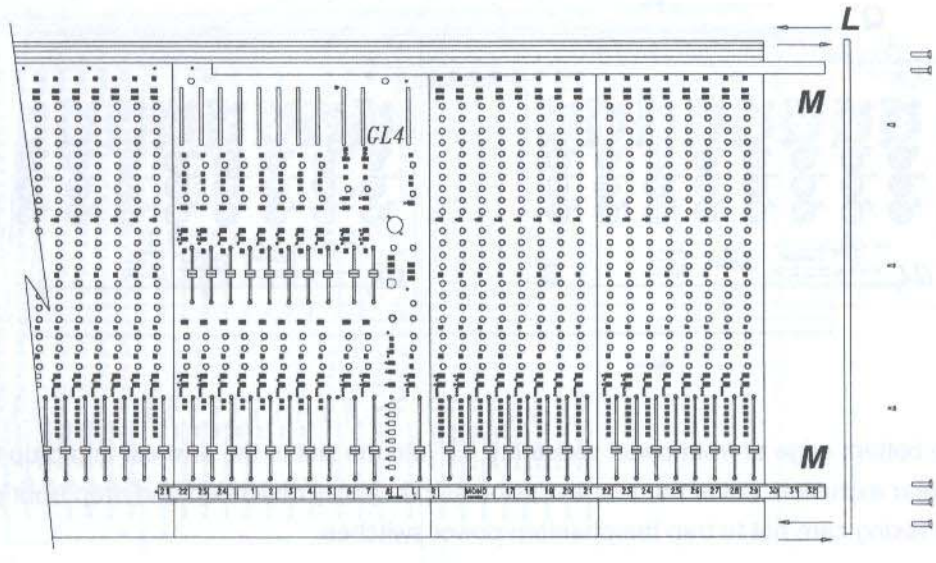

The mechanical assembly is now complete. The console should now be turned onto its front to enable the new module to be connected as detailed in item 5

- 5 Connect module to console as detailed below.
- 1 Connect the 12 way Flexi cables to the corresponding input boards as shown on existing inputs.
 - 2 Disconnect the end of the main harness from the original input boards, unwrap and reconnect to the input boards on the module. **WARNING Check that plugs are fully on both rows of pins and are correctly orientated.**
 - 3 Remove existing IDC slave harness and replace with IDC harness supplied with the module. **WARNING Check that plugs are fully on both rows of pins and are correctly orientated.**
 - 4 Solder earth wire from the module connector board to the adjacent connector board as shown.

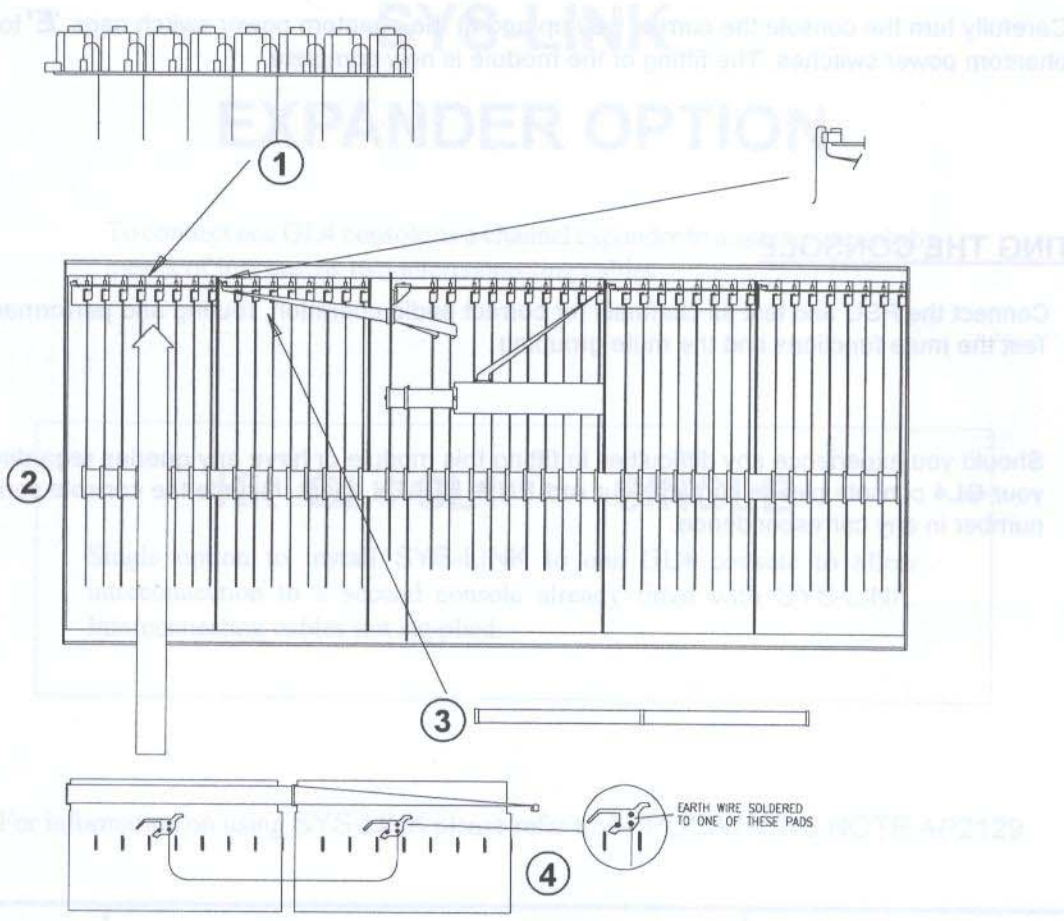

After completion of all connections to the module check carefully that all connectors are correctly orientated and fitted.

Check that all soldered joints are good.

- 6 Replace base panel 'N' using 6B screws 'A'.

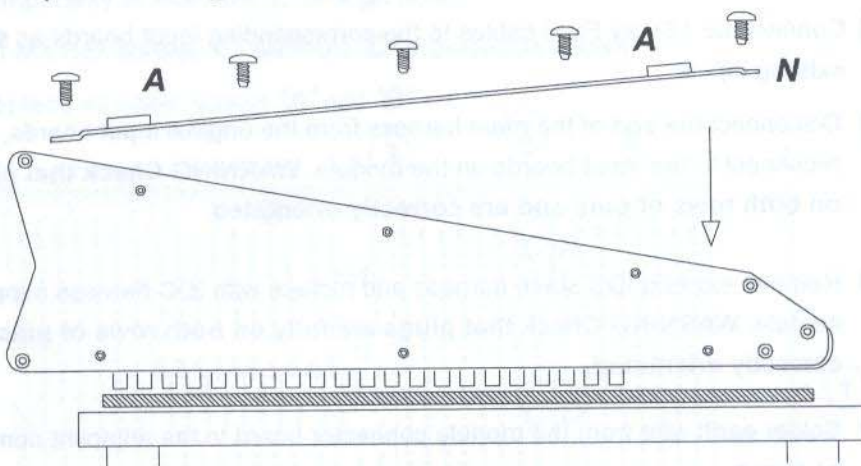

- 7 Carefully turn the console the correct way up and fit the phantom power switch caps 'E' to the phantom power switches. The fitting of the module is now complete.

TESTING THE CONSOLE

Connect the PSU and test all channels for correct audio operation, routing and performance. Test the mute functions and the mute grouping.

Should you experience any difficulties in fitting this module or have any queries regarding your **GL4** console please contact your **ALLEN & HEATH** agent. Include the console serial number in any correspondence.



GL4

MIXING CONSOLE

SYS-LINK EXPANDER OPTION

To connect one GL4 console as a channel expander to a second console by means of just one or two interconnecting cables.

Kit GL4-SL1 = SINGLE

Single option to install SYS-LINK to one GL4 console to allow interconnection to a second console already fitted with SYS-LINK. Interconnecting cables not supplied.

For information on using SYS-LINK please refer to APPLICATIONS NOTE AP2129

FITTING INSTRUCTIONS

Publication AP2128

Issue 1 Jan 95

FITTING THE GL4 SYS-LINK EXPANDER OPTION

1 CHECK THE CONTENTS :

GL4-SL1

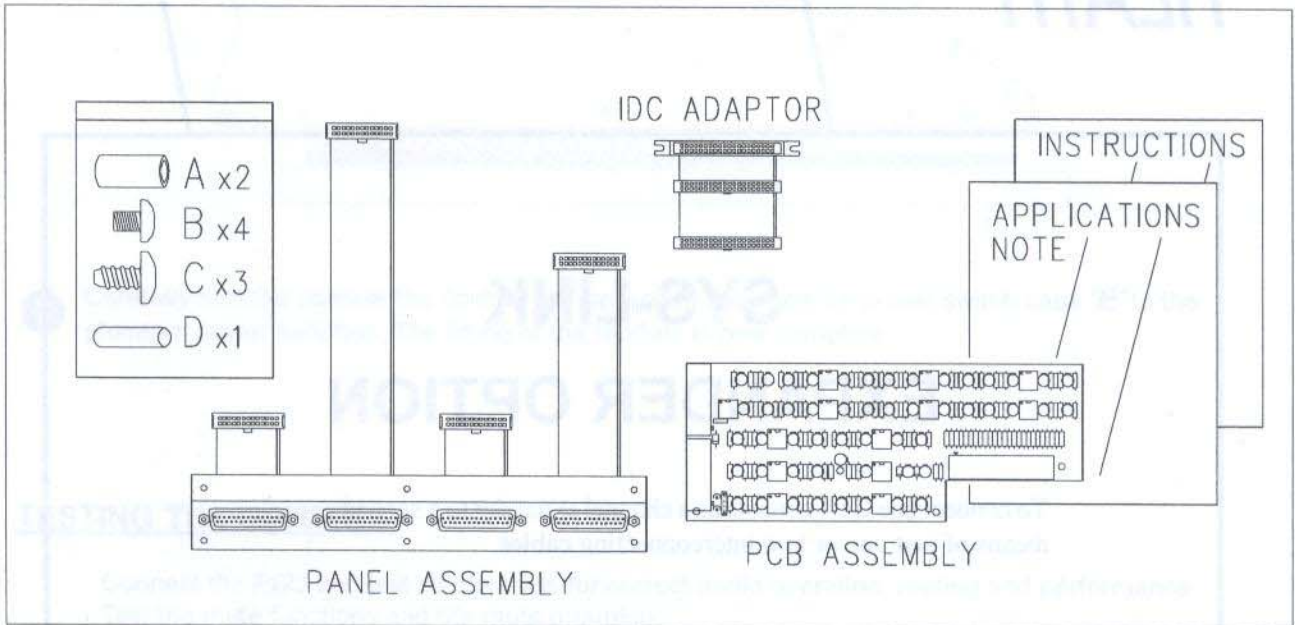

2 PREPARE :

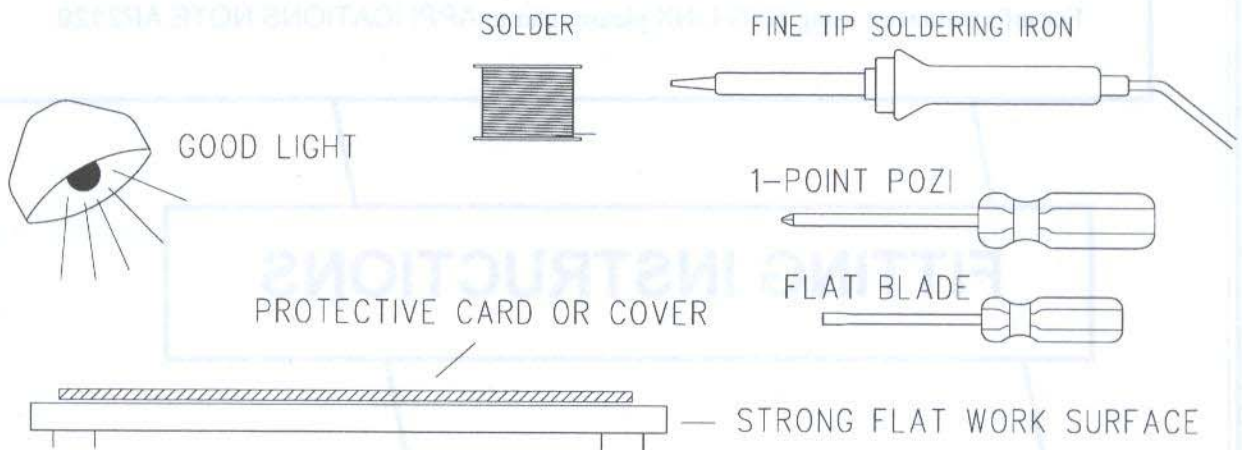

3 REMOVE THE BASE :

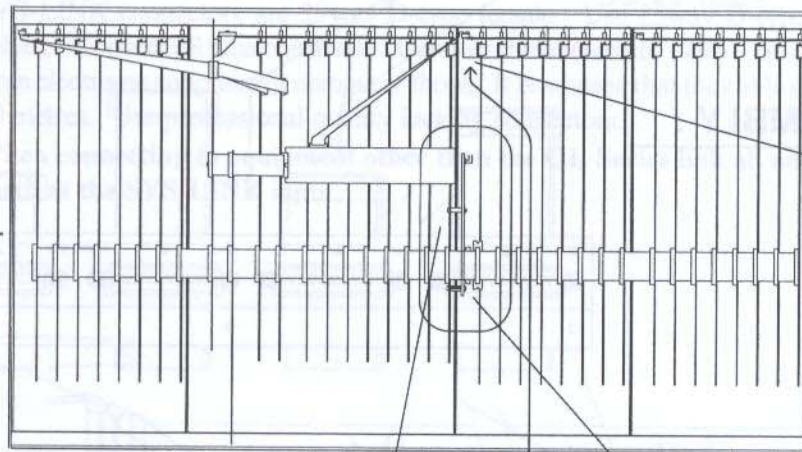
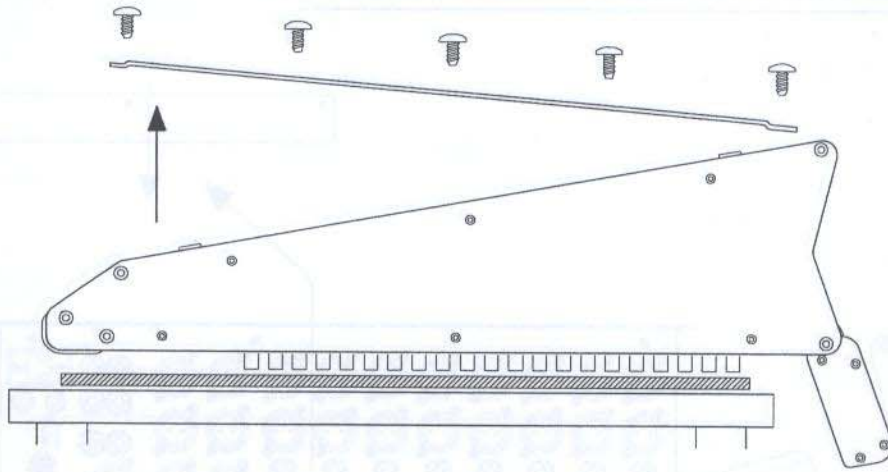

INPUT CONN PCB

SOLDER BLUE WIRE TO PAD SHOWN (+48V)

GL4 IDC

IDC ADAPTOR

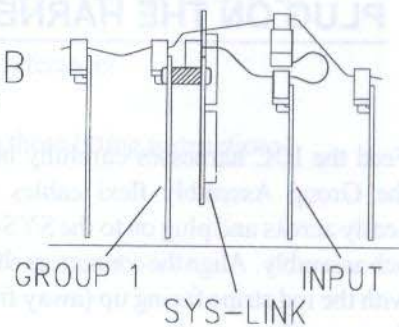
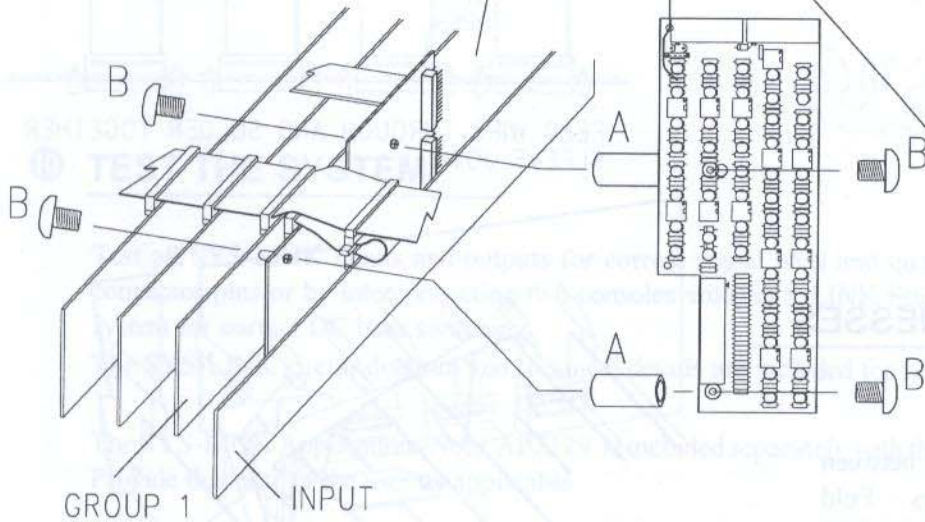

4 FIT THE PCB ASSEMBLY :

5 REMOVE THE BLANKING PLATE :

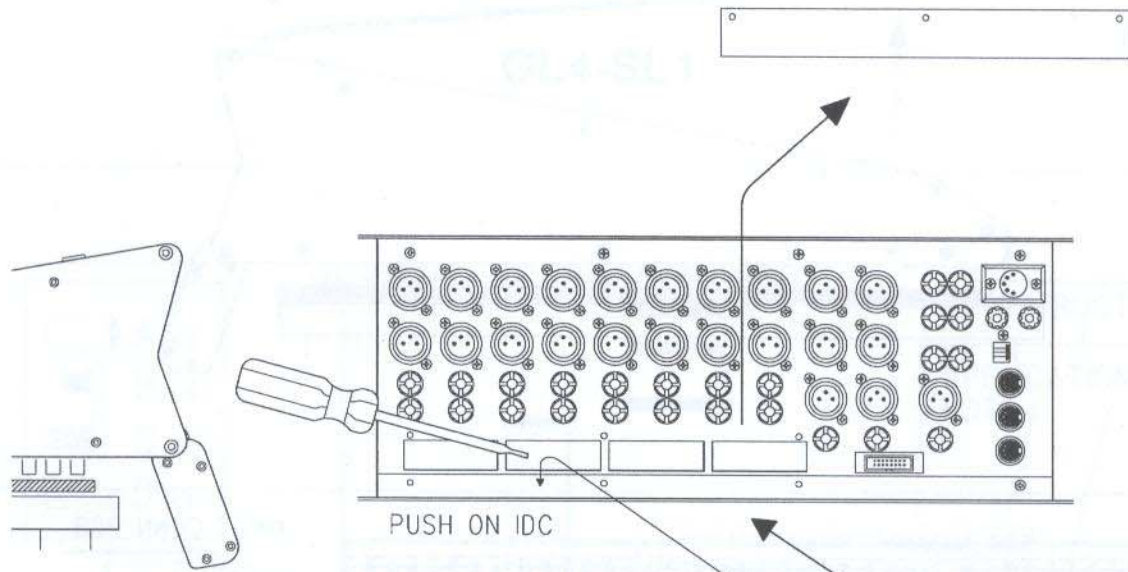

6 FIT THE PANEL ASSEMBLY :

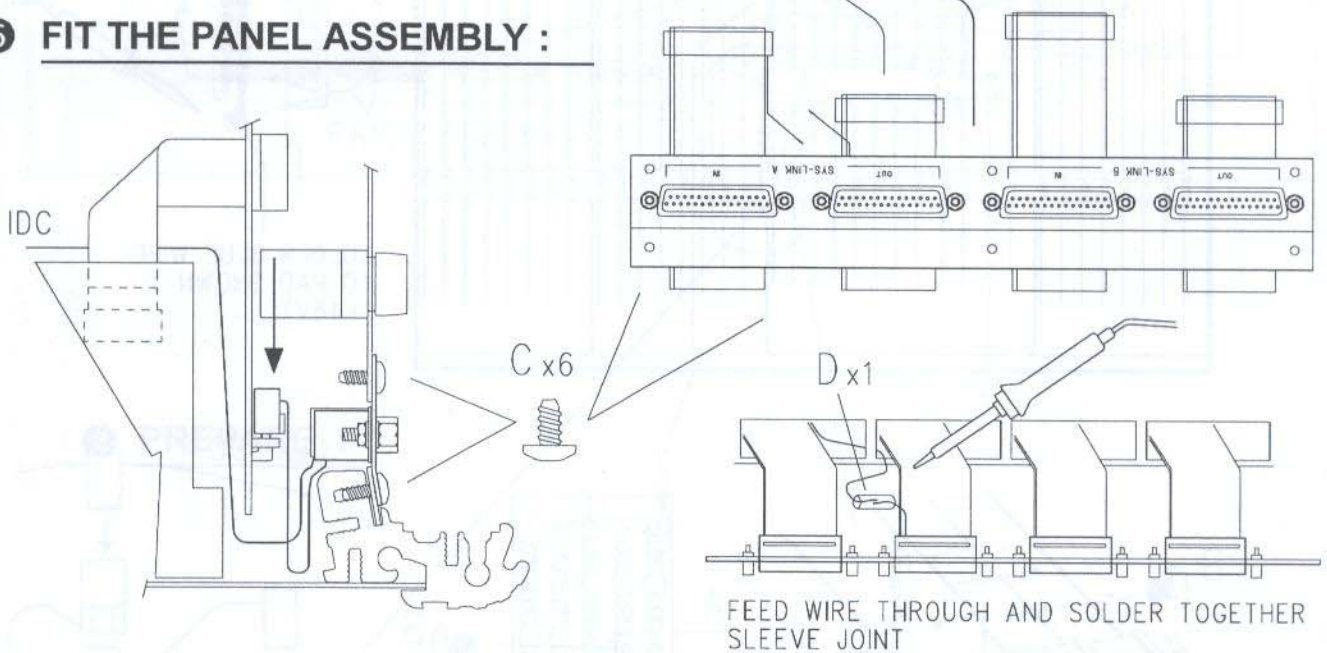

7 PLUG ON THE HARNESSES :

Feed the IDC harnesses carefully between the Group Assembly flexi cables. Fold neatly across and plug on to the SYS-LINK pcb assembly. Align the connectors correctly with the red stripe facing up (away from the front panel).

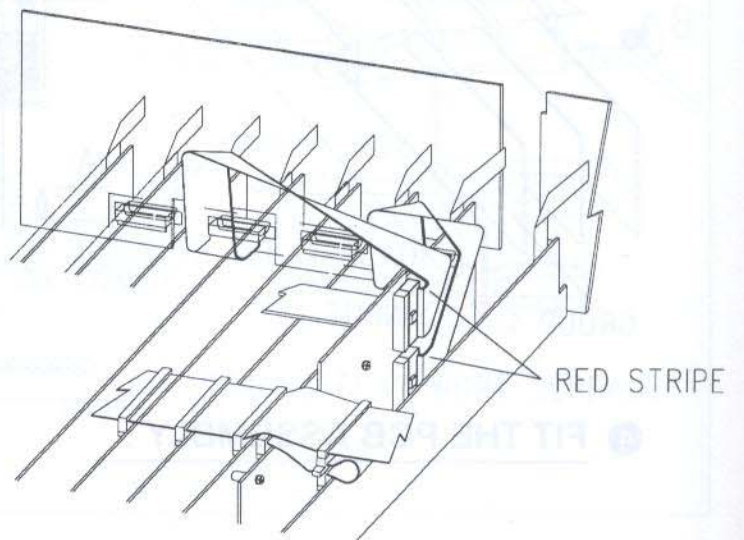

8 REFIT THE BASE:

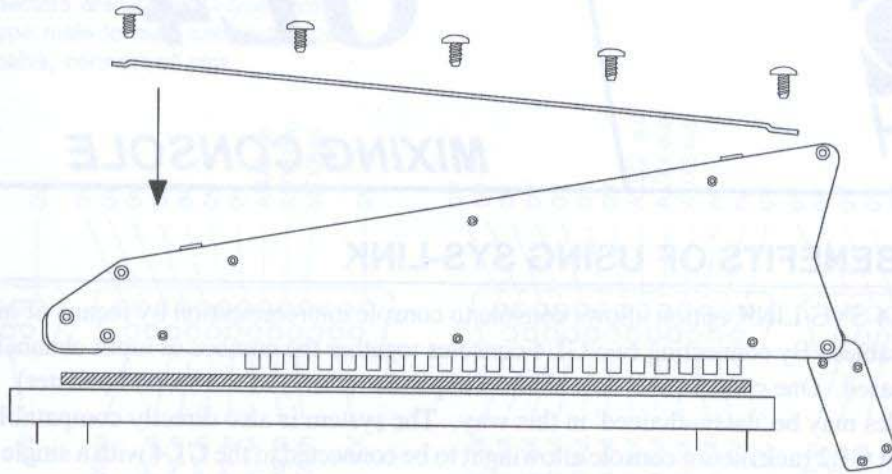

9 PLUG ON THE INTERCONNECTING CABLES:

SYS-LINK connectors are 25way D-type female. Use 25way D-type male to male connector cables. Connect all pins one to one. Connect shield (screen) to 0V. Standard cables are available from electronic suppliers or computer shops. It is advised that the cable is a screened type less than 10 metres. Use professional quality locking connectors.

When connecting to equipment other than the GL Series link all unused audio inputs to 0V earth at the SYS-LINK input.

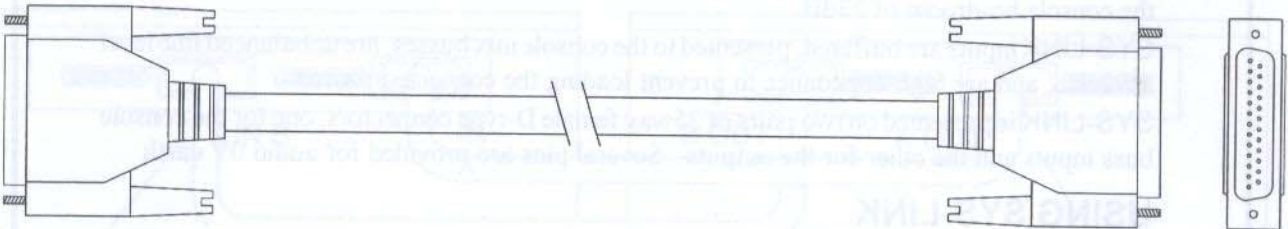

10 TEST THE SYSTEM:

Test all SYS-LINK inputs and outputs for correct signal level and quality by probing the D-connector pins or by interconnecting two consoles with SYS-LINK fitted. Test the PFL/AFL system for correct DC buss switching.

The SYS-LINK circuit diagram and technical details are included for reference.

The SYS-LINK Applications Note AP2129 is included separately with these fitting instructions. Provide this note to the user as applicable.

Please refer any queries to your Allen & Heath appointed service agent.



GL4

MIXING CONSOLE

THE BENEFITS OF USING SYS-LINK

The GL4 SYS-LINK option allows console to console interconnection by means of just one or two cables. By connecting two GL4 consoles together the number of input channels may be increased. One console acts as a channel expander (slave) of the second (master). Up to 3 consoles may be 'daisy-chained' in this way. The system is also directly compatible with the A&H GL2 rack mount console allowing it to be connected to the GL4 with a single cable. Plugging consoles together using SYS-LINK connects the signals directly to the console busses so avoiding the use of the main console outputs and channel inputs for the master / slave connection. All the console channels are available to the user for input sources.

SYS-LINK CONNECTIONS

SYS-LINK connects all the console main busses including L, R, 8 Groups, 10 Aux sends, and 2 matrix. The PFL/AFL system is also interconnected such that operating PFL/AFL on the slave console activates the master console monitor system. Operating PFL/AFL on the master does not activate the slave monitor system which may be used for 'local' monitoring if required. SYS-LINK connects the PFL/AFL audio mix and DC control buss.

SYS-LINK outputs are taken **pre-fader** so that the slave console output connectors may be used for sub-mix or 'zone' feeds if required. All output signals are unbalanced, low impedance and operate at a line level of -2dBu to prevent problems with audio interference and to maintain the console headroom of 23dB.

SYS-LINK inputs are buffered, presented to the console mix busses, are unbalanced line level at -2dBu, and are high impedance to prevent loading the connected source.

SYS-LINK is presented on two pairs of 25way female D-type connectors, one for the console buss inputs and the other for the outputs. Several pins are provided for audio 0V earth.

USING SYS-LINK

Connect consoles using two standard 25way male to male D-type cables, available from electronic suppliers or computer shops (25line male to male). It is advised that this cable is a screened type if longer than 1 metre, no longer than 10 metres in total, and that professional quality locking connectors are used. Connect all pins one to one with the screen to 0V.

Connect the slave console SYS-LINK output to the master console SYS-LINK input.

SYS-LINK may also be used to connect the GL4 to other audio equipment. Make sure that all unused inputs (except the P/AFL DC inputs) are linked to 0V earth at the SYS-LINK input to prevent audible interference from connected audio signals. Connect line level signals of around -2dBu. The GL4 PFL/AFL system may be activated by switching the P/AFL DC input to 0V earth through a 15k ohm resistor.

For information on fitting SYS-LINK please refer to FITTING INSTRUCTIONS AP2128

SYS-LINK APPLICATIONS NOTE

Publication **AP2129**

Issue 1 Jan 95

CONSOLE TO CONSOLE CONNECTION USING SYS-LINK

SYS-LINK connectors are 25way D-type female.
Use 25way D-type male to male connector cable.
Use screened cable, connect all pins.

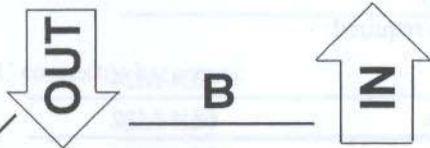
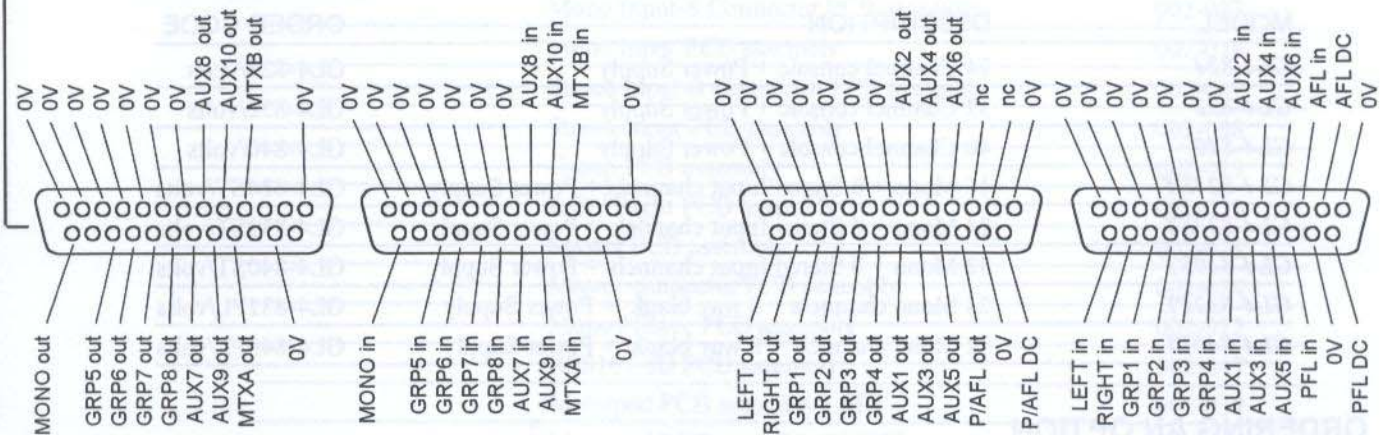

Line level output at -2dBu
Unbalanced, in-phase
Low impedance <75 ohm
P/AFL DC output is open collector sink to 0V through 15k.
All outputs are **pre-fader**

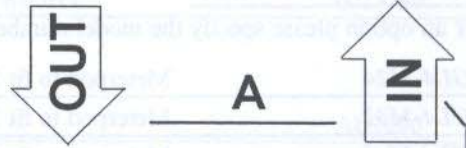

Line level input at -2dBu
Unbalanced, buffered, in-phase
High impedance = 10k ohm
P/AFL DC input for pulldown to 0V through 15k resistor.
When connecting to equipment other than GL Series link all unused audio inputs to 0V earth at the SYS-LINK input.

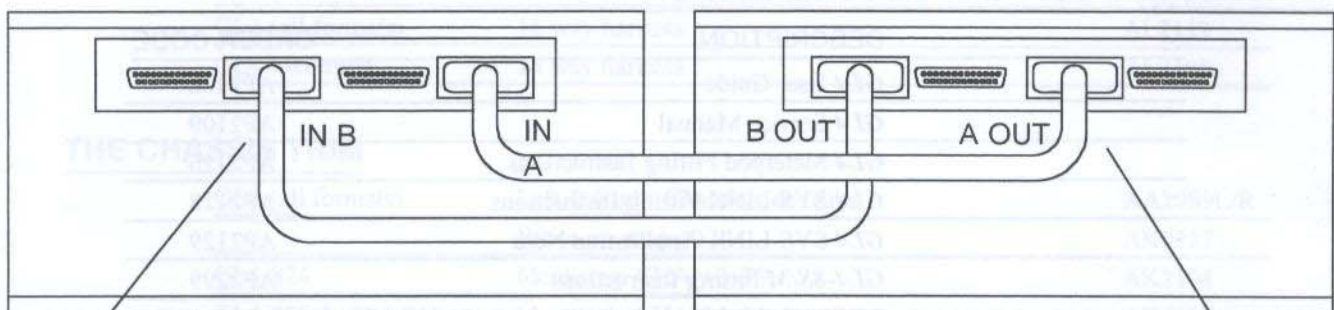

MASTER GL4

SLAVE GL4

B to link GRP 5-8, AUX 7-10, MTX A-B, MONO

A to link GRP 1-4, AUX 1-6, L, R, P/AFL

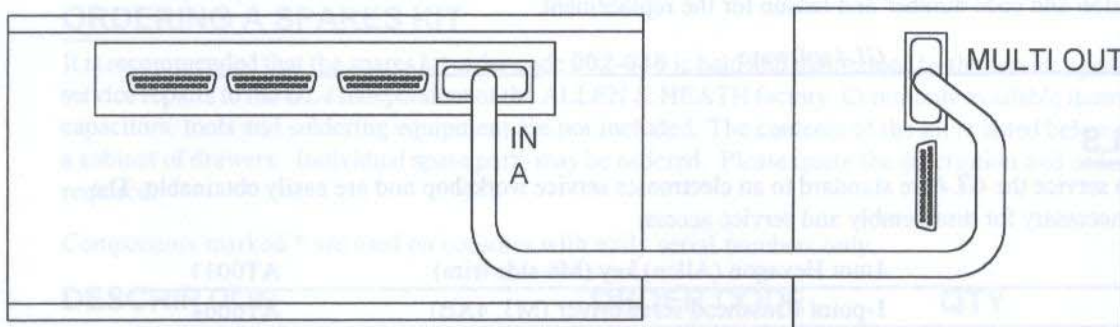

MASTER GL4

SLAVE GL2

ORDERING SPARE PARTS

ORDERING A CONSOLE

To order a new console please specify the model number and AC mains voltage required. Refer to the section: Standard Consoles for more detail

MODEL	DESCRIPTION	ORDER CODE
<i>GL4-824</i>	24 Channel console + Power Supply	GL4-824/volts
<i>GL4-832</i>	32 Channel console + Power Supply	GL4-832/volts
<i>GL4-840</i>	40 Channel console + Power Supply	GL4-840/volts
<i>GL4-824ST</i>	16 Mono + 8 Stereo Input channels + Power Supply	GL4-824ST/volts
<i>GL4-832ST</i>	24 Mono + 8 Stereo Input channels + Power Supply	GL4-832ST/volts
<i>GL4-840ST</i>	32 Mono + 8 Stereo Input channels + Power Supply	GL4-840ST/volts
<i>GL4-832PL</i>	24 Mono channels + 8 way blank + Power Supply	GL4-832PL/volts
<i>GL4-840PL</i>	32 Mono channels + 8 way blank + Power Supply	GL4-840PL/volts

ORDERING AN OPTION

To order an option please specify the model number and AC mains voltage required:

<i>GL4-M24</i>	Meterpod to fit 24 channel console	GL4-M24
<i>GL4-M32</i>	Meterpod to fit 32 channel console	GL4-M32
<i>GL4-M40</i>	Meterpod to fit 40 channel console	GL4-M40
<i>GL4-8M</i>	8 Mono Input channels + rear connector panel kit	GL4-8M
<i>GL4-8S</i>	8 Stereo Input channels + rear connector panel kit	GL4-8S
<i>GL4-SL1</i>	GL4 SYS-LINK kit	GL4-SL1
<i>RPSD</i>	Dual supply Combiner / Monitor	RPSD

MANUALS AND SUPPORT DOCUMENTATION

DESCRIPTION	ORDER CODE
<i>GL4</i> User Guide	AP2108
<i>GL4</i> Service Manual	AP2109
<i>GL4</i> Meterpod Fitting Instructions	AP2126
<i>GL4</i> SYS-LINK Fitting Instructions	AP2128
<i>GL4</i> SYS-LINK Application Note	AP2129
<i>GL4-8S/M</i> Fitting Instructions	AP2299
<i>RPS10</i> User Manual	AP2142
<i>RPSD</i> User Manual	AP2263

SOFTWARE EPROM

To order a replacement EPROM, please contact ALLEN & HEATH and notify us of your console serial number, its present EPROM version and code number and reason for the replacement.

GL4 software

SERVICE TOOLS

The tools required to service the *GL4* are standard to an electronics service workshop and are easily obtainable. The following items are necessary for disassembly and service access:

4mm Hexagon (Allen) key (M6 side trim)	AT0033
1-point Crosshead screwdriver (M3, 4AB)	AT0004
2-point Crosshead screwdriver (M4, 6AB)	AT0004
10mm Nutdriver	
15mm Nutdriver (jack nuts, potentiometer nuts)	

ORDERING AN ASSEMBLY

The following assemblies are supplied fully tested. Please note that several of these need to be assigned according to their position in the console. This is done by soldering wire links or assignment pads. It is best to check the assignment settings of the assembly you are replacing before removing it from the console. Please quote the description and order code for the part required.

Printed circuit (PCB) assemblies:

Mono Input-8 Connector PCB assembly	002-023
Mono Input PCB assembly	002-018
Stereo Input-8 Connector PCB assembly	002-069
Stereo Input PCB assembly	002-068
Group PCB assembly	002-019
Left / Right PCB assembly	002-020
Master PCB assembly	002-021
Master connector PCB assembly	002-024
Mono / Slave PCB assembly	002-022
RPS10 / 5B PCB assembly	002-047
Meterpod PCB assembly LEFT	002-039
Meterpod PCB assembly RIGHT	002-040

IDC connector harnesses:

GL4-824	40 way Main harness	AL2096
GL4-832	40 way Main harness	AL2097
GL4-840	40 way Main harness	AL2098
GL4-824	16 way Slave-1 harness	AL2101
GL4-824 & GL4-832	16 way Slave-2 harness	AL2102
GL4-840	16 way Slave-3 harness	AL2103
GL4-832 & GL4-840	16 way Slave-4 harness	AL2221
GL4 (all formats)	26 way Master harness	AL2099
GL4 (all formats)	16 way harness	AL2119
GL4 Meterpod	16 way harness	AL2100

THE CHASSIS TRIM

GL4 (all formats)	Left & Right Chassis side trims	AA2089L/R
	Write-on strip 10'	AK0327
GL4-824	Ident strip CHAN 1-16	AK2104
GL4-832 & GL4-840	Ident strip CHAN 1-24	AK2107
GL4-824 & GL4-832	Ident strip GRP 1- CHAN 32	AK2106
GL4-840	Ident strip GRP 1- CHAN 40	AK2105
GL4 Meterpod	Left & Right Meterpod side trims	AA2090L/R

ORDERING A SPARES KIT

It is recommended that the spares kit order code **002-036** is held and maintained by the service agent to enable in-field service repairs to the *GL4* independent of the ALLEN & HEATH factory. Commonly available items such as resistors, capacitors, tools and soldering equipment are not included. The contents of the kit is listed below and is supplied in a cabinet of drawers. Individual spare parts may be ordered. Please quote the description and order code for the part required.

Components marked * are used on consoles with early serial numbers only.

DESCRIPTION	ORDER CODE	QTY
-------------	------------	-----

Fixings:

Screw 4AB x 5/16" Pan Pozi Black	AB0057	10
----------------------------------	--------	----

Screw 4AB x 5/16" CSK Pozi Black	AB0059	10
Screw 6B x 5/16" Pan Pozi Black	AB2084	10
Screw 8B x 5/16" CSK Pozi Black	AB2085	10
Screw 6B x 1/4" CSK Pozi zinc	AB2083	10
Screw 6B x 3/8" CSK Pozi zinc	AB2082	10
Screw M6 x 20mm CSK Allen Black	AB0310	5
Screw M3 x 5mm CSK Pozi Black	AB0070	10
Screw M3 x 8mm Pan Pozi Black	AB0073	10
Screw M3 x 8mm CSK Pozi Black	AB0074	5
Nylock Nut M3	AB0102	5
Fixing for D type connector	AB2189	10
Joint Block	AB0253	2

Knobs and caps:

Knob Yellow & Grey 11mm D	AJ2079	10
Knob Dark Grey & Grey 11mm D	AJ2078	10
Knob Green & Grey 11mm D	AJ2077	10
Knob Blue & Grey 11mm D	AJ2075	10
Knob Brown & Grey 11mm D	AJ2080	10
Knob Red & Grey 11mm D	AJ2074	10
Fader Knob 11mm White+Black line	AJ8078	10
Fader Knob 11mm Red+White line	AJ8079	5
Fader Knob 11mm Yellow+White line	AJ8080	5
Fader Knob 11mm Blue+White line	AJ8081	5
*Fader Knob 11mm Blue+White line	AJ0391	-
*Fader Knob 11mm Yellow+White line	AJ0390	-
*Fader Knob 11mm Red+White line	AJ0389	-
*Fader Knob 11mm White+Black line	AJ0388	-
Button 5.5mm Square Grey	AJ0363	10
Button 5.5mm Square Red	AJ0364	10
Button 5.5mm Square White	AJ0373	10
Button 10x5mm Rectangular Grey	AJ0093	10
Button 10x5mm Rectangular White	AJ0094	10
Button 10x5mm Rectangular Red	AJ0095	10
Button 10x5mm Rectangular Black	AJ0096	5
Button 12.5mm Square Black	AJ0348	2

Faders, Potentiometers, switches, and connectors:

10KA fader 100mm	AI8001	10
10KA x 2 fader 100mm (stereo)	AI8002	5
10KA fader 60mm	AI8054	5
20KK (203K)	AI8003	5
20KK (203K 14mm wide)	AI8007	5
20KB (203B) centre click	AI8004	5
20KB x 2 (203B 14mm wide) centre click	AI8064	3
10KC x 2 (103C 14mm wide)	AI0150	5
10KAC x 2 (103AC 14mm wide)	AI8008	5
200KC x 2 (204C)	AI8005	5
200KC x 2 (204C 14mm wide)	AI8009	5
Pot Nut 9mm	AB8050	10
Switch 2PCO Latching	AL0162	5
Switch 2PCO Momentary	AL0374	5
Switch 4PCO Latching	AL0333	5
Jack Socket Vertical PCB Mount + nut	AL8072	5
Jack Socket Nut (circular)	AL8083	5
Jack Socket Vertical PCB Mount + Hex nut	AL8082	5
Jack Socket Headphone	AL0328	1
XLR 3 Pin Female Vertical PCB Mount	AL8074	5
XLR 3 Pin Male Vertical PCB Mount	AL8077	5

LEDs and Semiconductors:

LED 3mm T1 Green	AE0085	5
LED 3mm T1 Yellow	AE0084	5
LED 3mm T1 Red	AE0086	5
LED Bar Rectangular Green 4way	AE0303	2
LED Bar Rectangular Red 4way	AE2116	2
LED Bar Rectangular 3Green/1Red 4way	AE2117	2
Transistor 2SB737 PNP	AE8069	5
Transistor BC549 NPN	AE0020	3
Transistor 2N4403 PNP	AE0273	5
Transistor BC214 PNP	AE0031	3
Transistor J111N FET	AE0083	5
IC NE5532N Dual Op Amp	AE0221	5
IC TL072CP Dual Op Amp	AE0046	5
IC LM339N Quad Comparator	AE0071	2
IC CMOS 4051B	AE0118	1
IC CMOS 4053B	AE0117	1
IC CMOS 4099B	AE0238	1
IC SSM2142P Bal Out Driver	AE0302	3
IC 6N136 Opto isolator	AE0222	1
IC TTL 74LS373N	AE0140	1
IC TTL 74LS138N	AE0248	1
IC Regulator 7805 (+5V DC)	AE0308	2

POWER SUPPLY:

Lamp Neon	AL0200	2
Mains Fuse 20mm T1.6A (UK, EC)	AL0466	5
Mains Fuse 20mm T3.15A (USA)	AL0464	5
Mains Fuse 20mm T6.3A (DC)	AL0395	5
Transformer 225VA	AM0907	-
Bridge Rectifier 25A 200V	AE0239	1
Transistor MJ3001	AE0240	2
Thyristor TIC126M	AE0272	1
IC Adjustable Regulator 783 (+48V DC)	AE0214	2
IC Regulator UA723CN (+/-16V DC)	AE0056	2
Fuseholder 20mm Panel Mount	AL0578	1

RPSD:

Mains Fuse 20mm T5.0A	AL2270	-
Mains Filter IEC 6A	AL2260	-
Mains Outlet IEC 3 Pin	AL2261	-
Mains Switch Rocker 0-1	AL0587	-
LED 5mm T1¾ Tri-colour	AE2258	-
Zener Diode BZX85 5V6	AE0012	-
RPSD Packing assembly	002-058	-
RPSD DC Supply cable	002-060	-
RPSD IEC to IEC Mains Lead	AH2262	-

METERPOD:

Preset 10K (calibrate)	AC0250	-
Meter VU+bulb	AD0011	2
Bulb (VU meter)	AD0013	5
Spacer PCB M3	AB0331	-
Screw 6B x 5/16" Pan Pozi Black	AB2084	5
Screw M6 x 12mm SKT Hex Black (Grub)	AB2087	3
Screw M4 x 12mm CSK Hex Black	AB2086	10

Miscellaneous:

GL4-824 Packing assembly	002-033	-
GL4-832 Packing assembly	002-034	-
GL4-840 Packing assembly	002-035	-
*Flex cable 11 way 90mm	AH8053	-
*Flex socket 11 way 90deg	AL8052	-
*Flex socket 11 way straight	AL2019	-
Flex cable 12 way 90mm	AH2228	5
Flex socket 12 way 90deg	AL2226	-
Flex socket 12 way straight	AL2227	-
Ferrite Bead Axial	AF0610	-

To: _____
From: CD
Date: 20 July 1992

To: _____
From: ARL
Date: 20 July 1992

SECTION B

B

Subject: ED Setting tables

TECHNICAL DIAGRAMS

Due to a number of errors in the original diagram, the following changes were made to the diagram. The link option in the top right corner of the diagram is now identified as the link option in the top right corner of the diagram. The link option in the top right corner of the diagram is now identified as the link option in the top right corner of the diagram. The link option in the top right corner of the diagram is now identified as the link option in the top right corner of the diagram.

CAUTION !

TO AVOID DAMAGE TO INTERNAL COMPONENTS BY MISHANDLING AND/OR MISCONNECTION, ONLY TECHNICALLY COMPETENT PERSONNEL SHOULD ATTEMPT SERVICE WORK ON THIS CONSOLE.

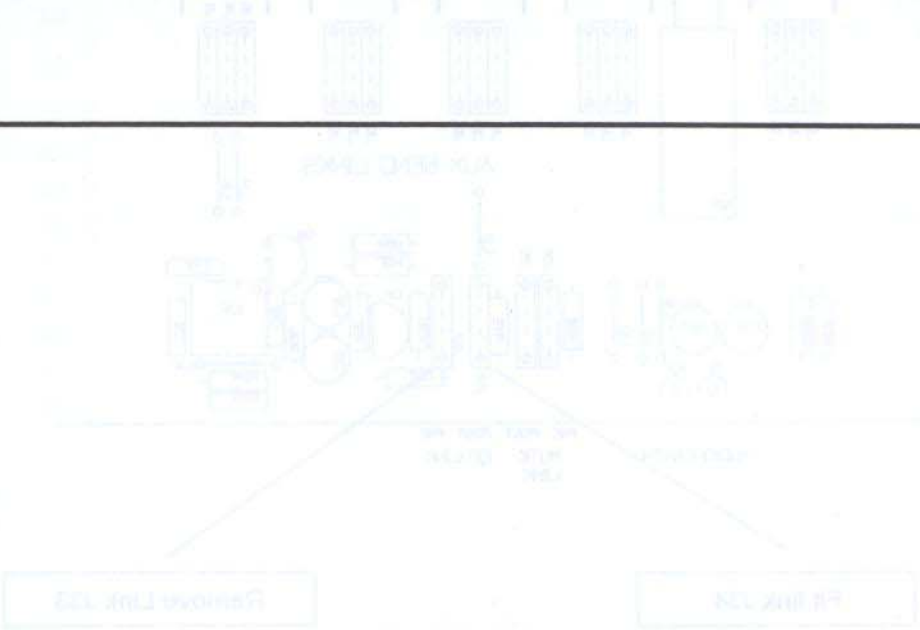

TECHNICAL BULLETIN



To:
From: ARJ
Date: 20 July, 1995

Subject: **GL4 Pre - Fade Aux to Post EQ Setting**

Due to a number of enquiries requesting information on changing the Pre - Fade Aux sends from pre to post EQ, all GL4 consoles built after serial number 621292 are configured post EQ as standard. Anyone wishing to change earlier consoles to post EQ should observe the following procedure.

With the console inverted on a suitably sized clean work surface, free of parts and debris, and with a cloth to protect the console cosmetics, remove the base. The link option for pre/post EQ is located at the top edge, and in the approximate centre of each input PCB (see diagram), and can be identified by the legend " EQ- PR PO " printed on the solder side of the PCB. Carefully remove the links from the PR positions and after clearing any solder from the component pads, solder new links to the positions marked PO. Thoroughly check your work, especially for solder shorts, before refitting the base.

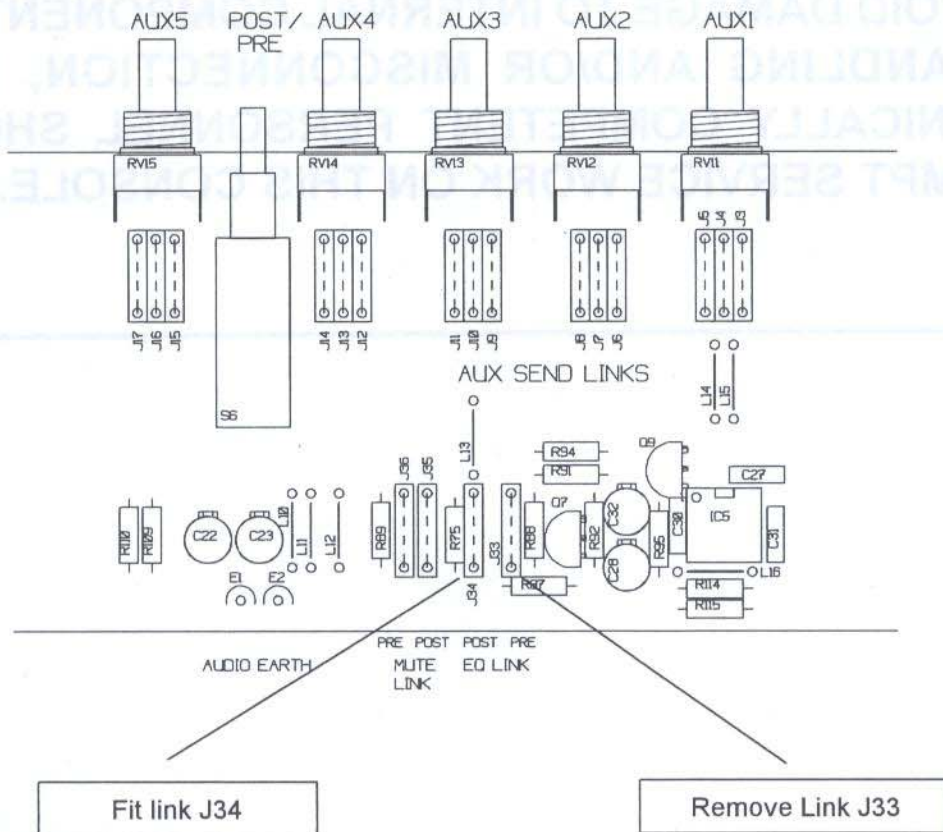

TECHNICAL BULLETIN

To:
From: CD
Date: 20 July, 1995

Subject: **GL4 Led Meter Glow**

It has been noticed that on some consoles a few of the bargraph meter Leds may occasionally glow with no signal present. This is usually in groups of four Leds on the same meter. This normally clears after a short while or after the console has been switched off and on again.

This effect is caused by component characteristics. It may be easily cured by adding a suppression capacitor to the current drive transistor associated with the meter.

With the console inverted on a suitably sized clean work surface, clear of parts and debris, remove the base and locate the PCB assembly to be modified.

A 40nF (0.04uF or near value) capacitor should be soldered between the 2N4403 (Q10) transistor collector and the +VB power rail. This can be done by soldering the capacitor between the 339 IC (IC8 nearest the transistor) pins 2 and 3. Make sure the joints are good and the capacitor legs do not short out and components.

Check your work and refit the base. Test that the meters operate correctly.

FRONT PANEL LAYOUT

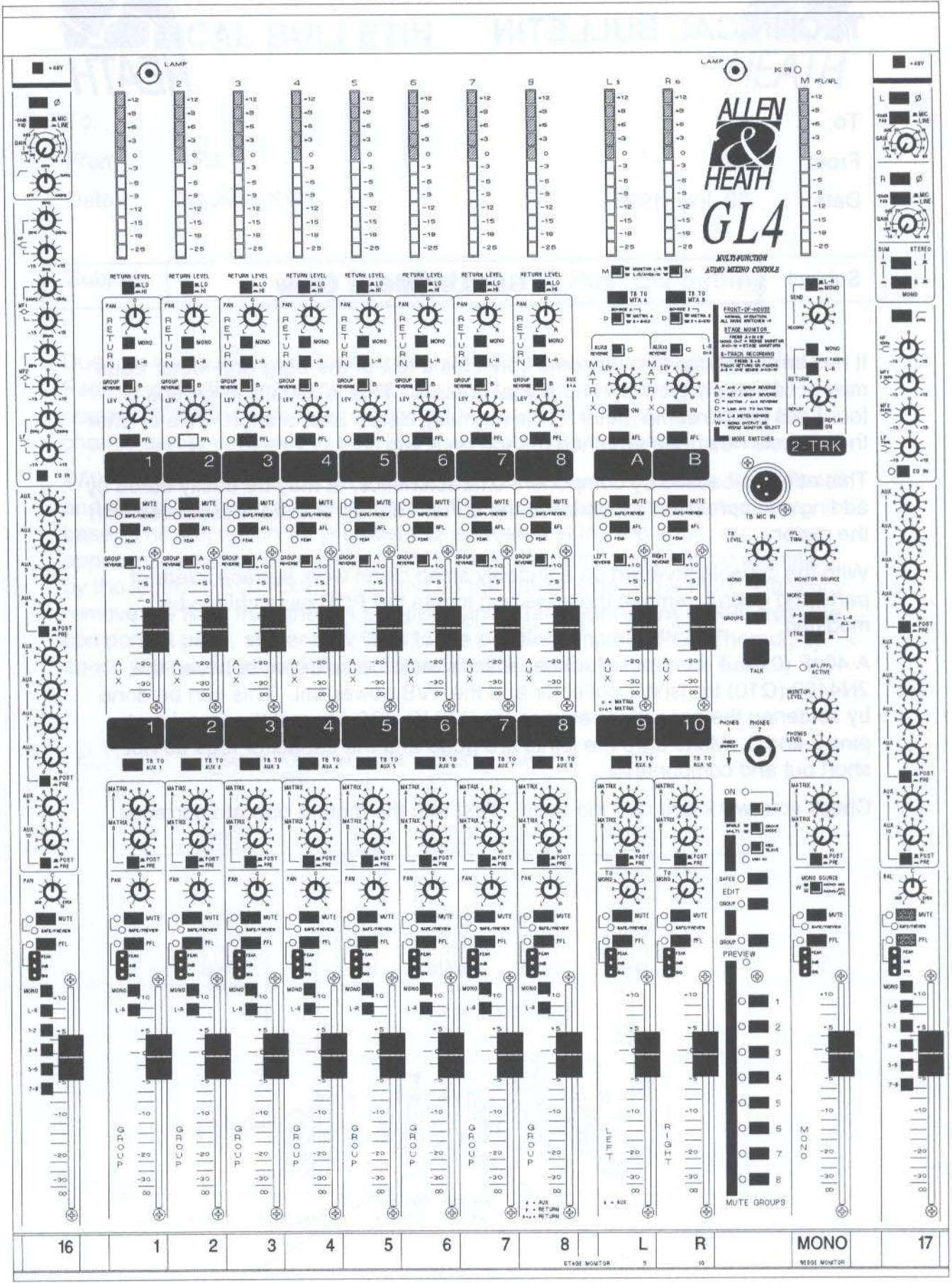

REAR PANEL LAYOUT

MASTER SECTION

INPUT SECTION

MONO

STEREO

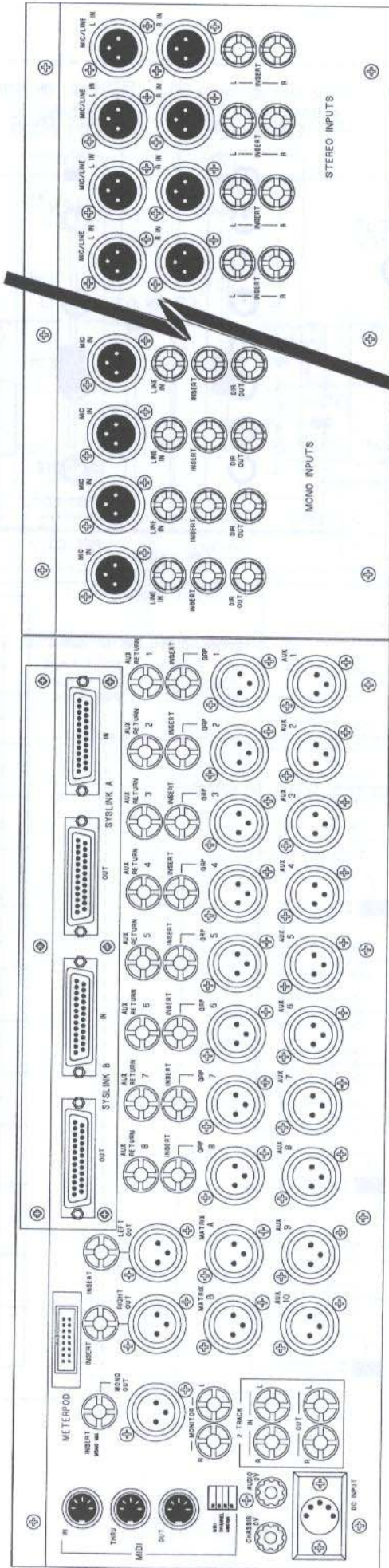

FRONT PANEL LAYOUT MONO INPUT SECTION

SHEET 1 OF 6

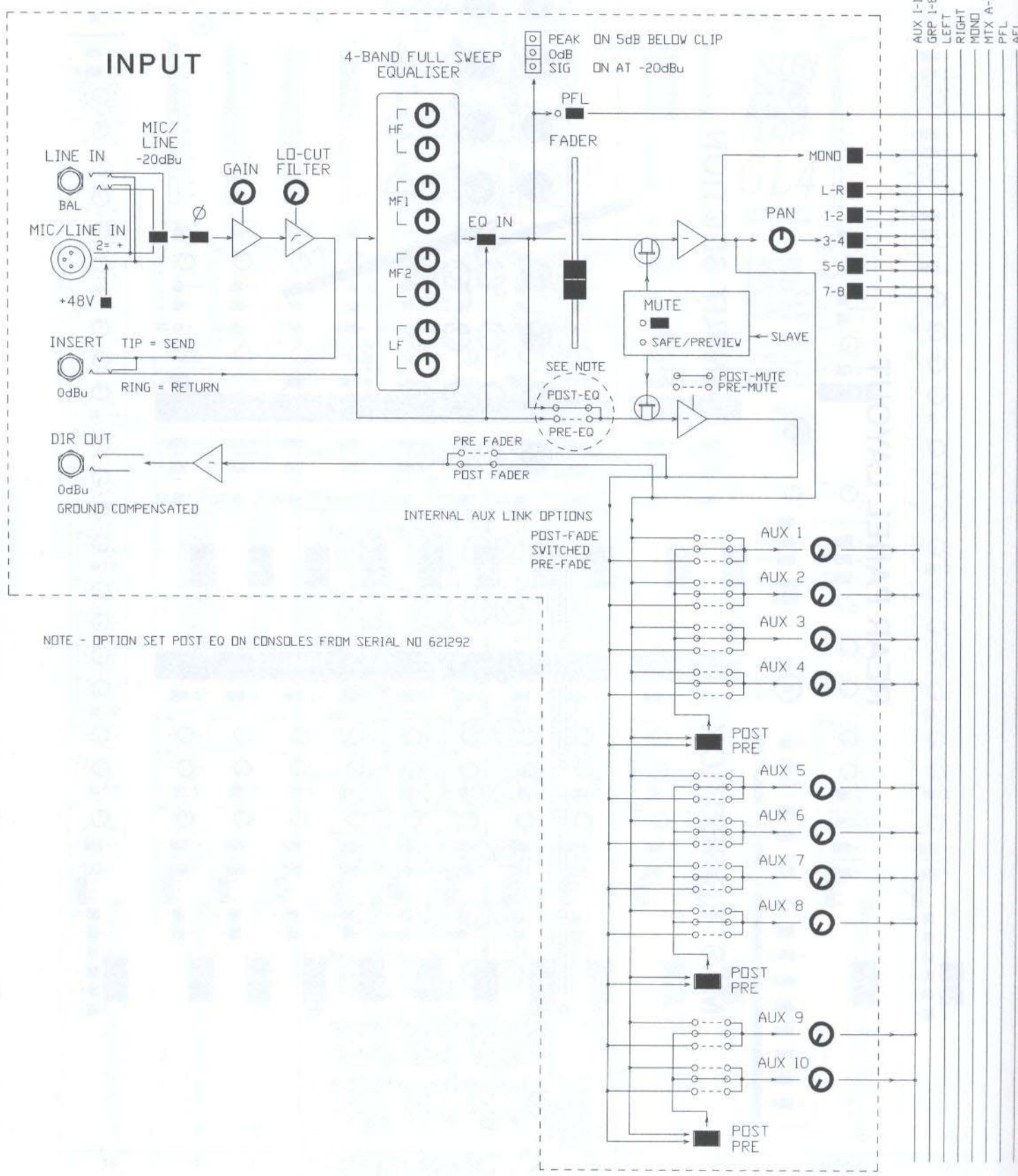

NOTE - OPTION SET POST EQ ON CONSOLES FROM SERIAL NO 621292

STEREO INPUT SECTION

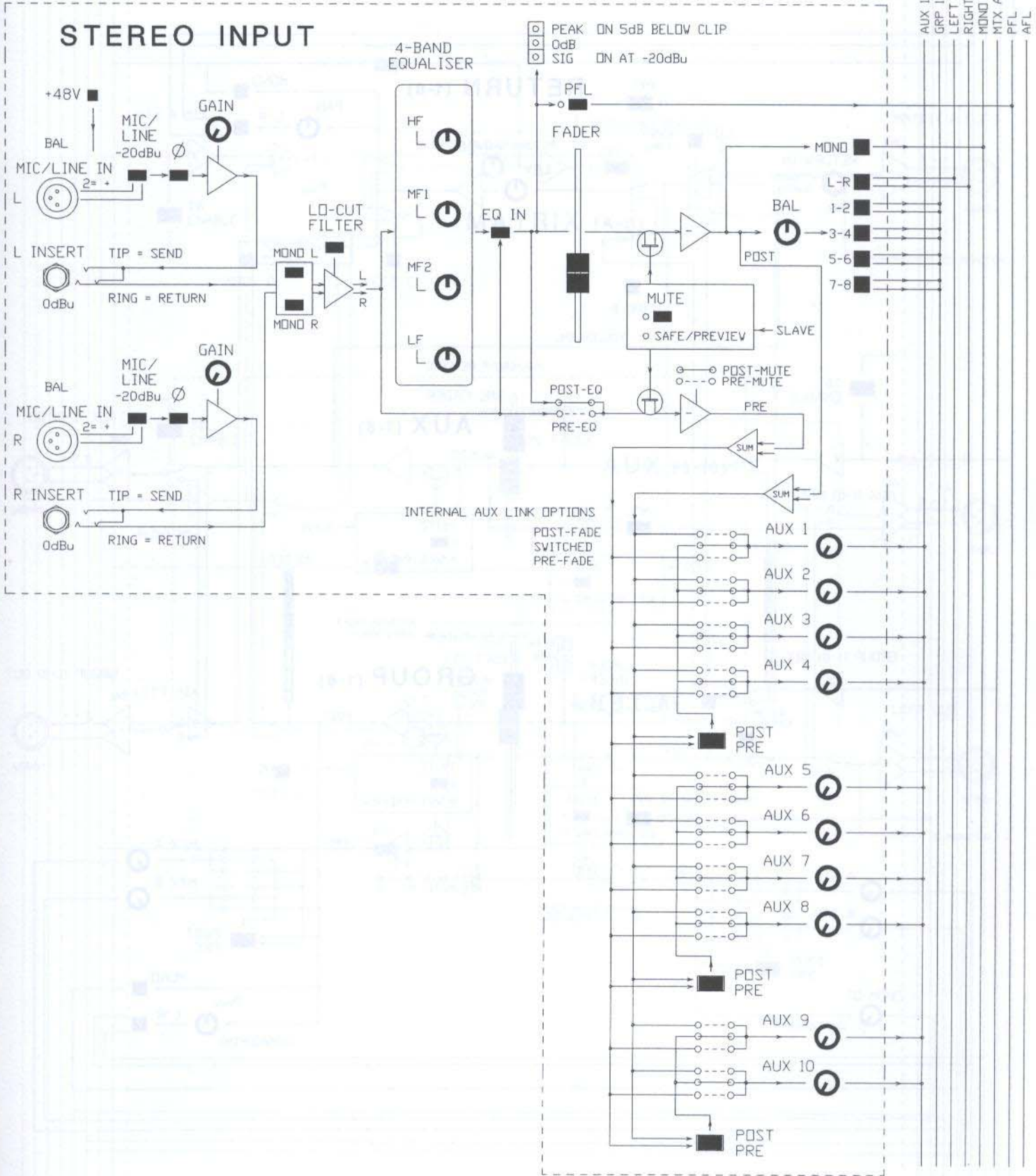

GROUP / AUX SECTION

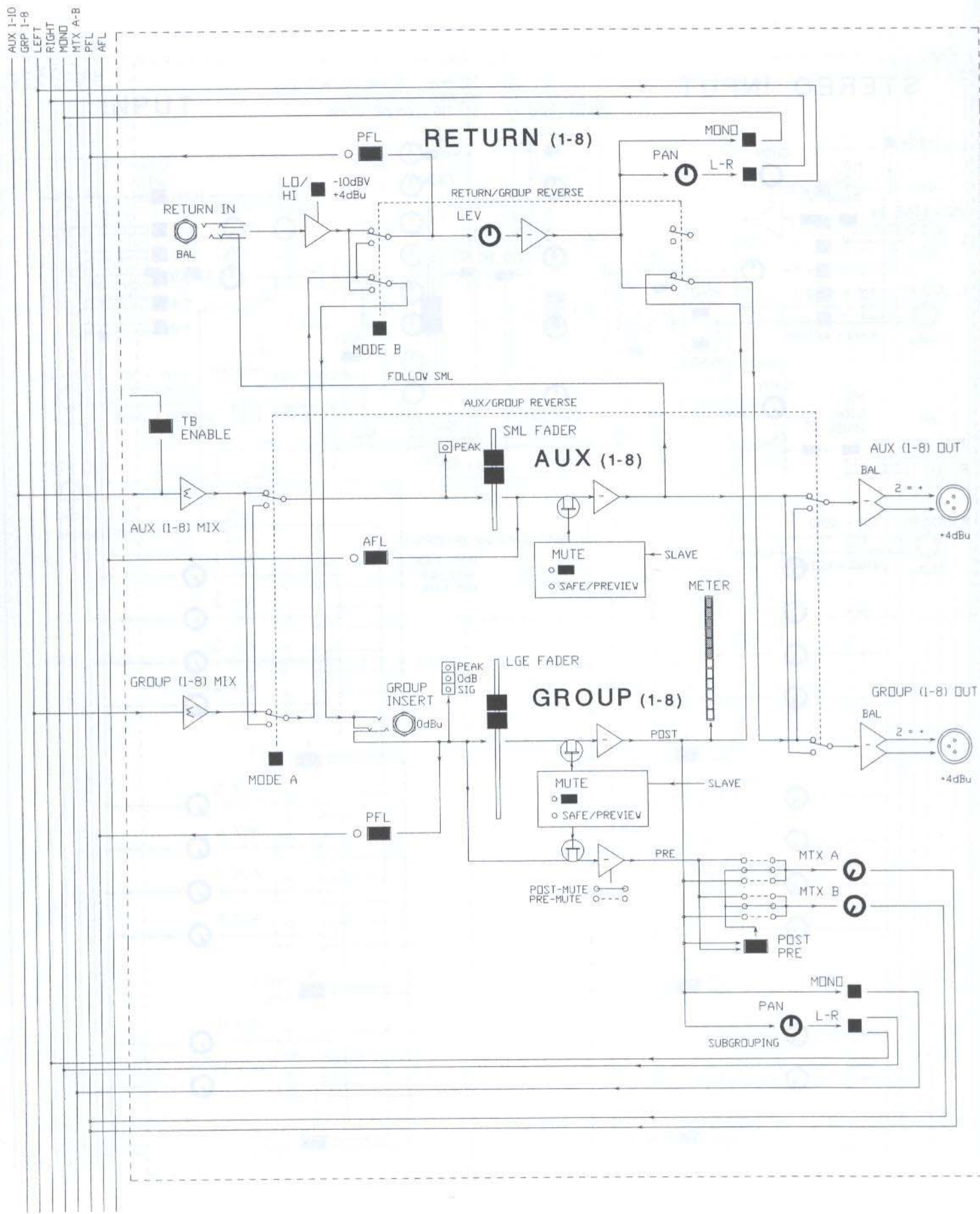

AUX / MATRIX SECTION

AUX 1-10
GRP 1-8
LEFT
RIGHT
MONO
MTX A-B
PFL
AFL

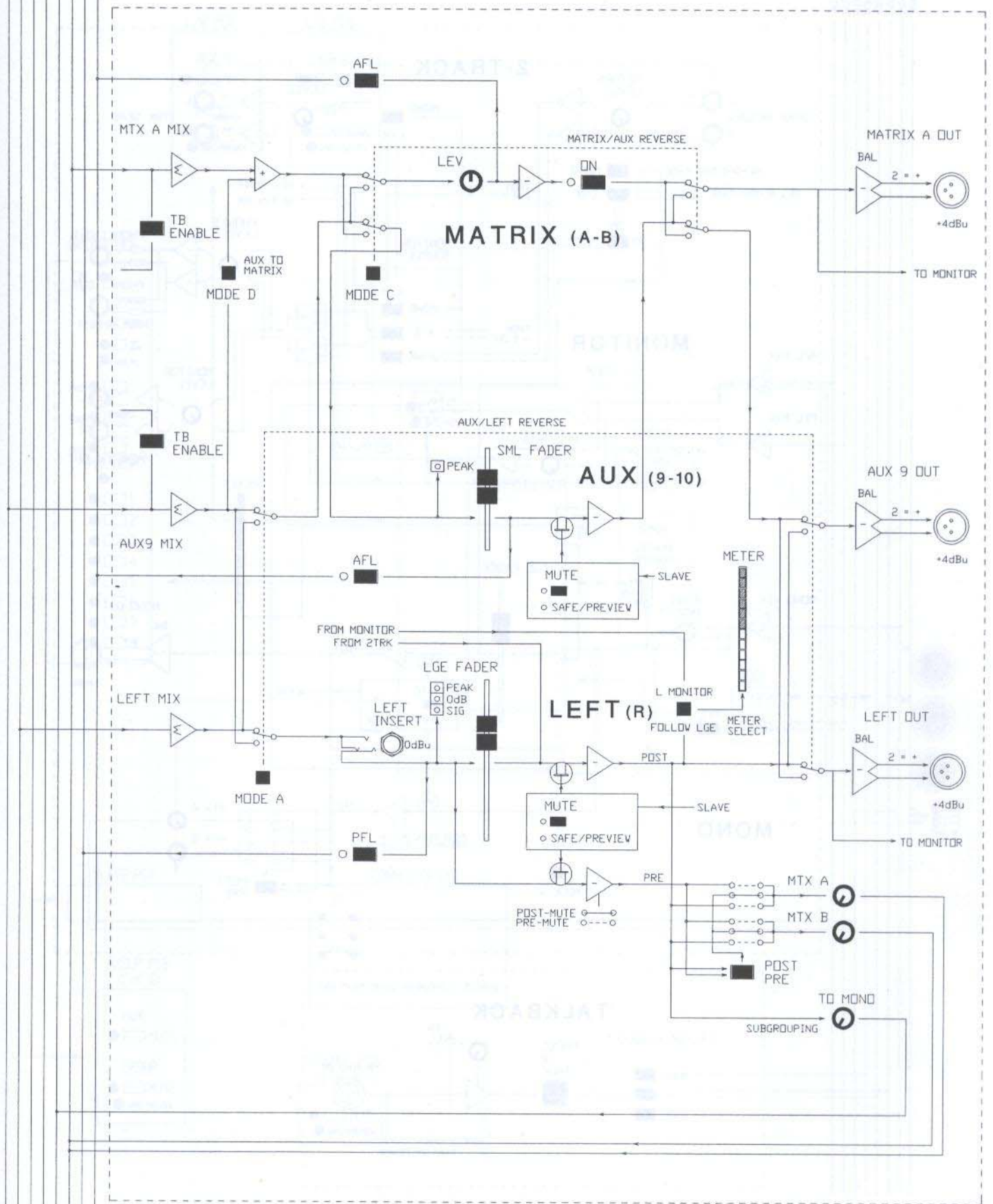

MONITOR / TALKBACK SECTION

AUX 1-10
GRP 1-8
LEFT
RIGHT
MONO
MTX A-B
PFL
AFL

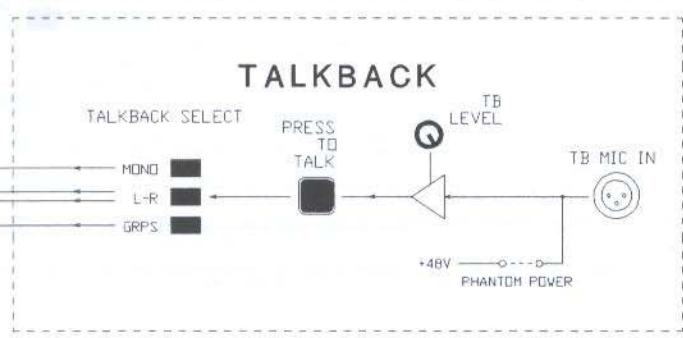
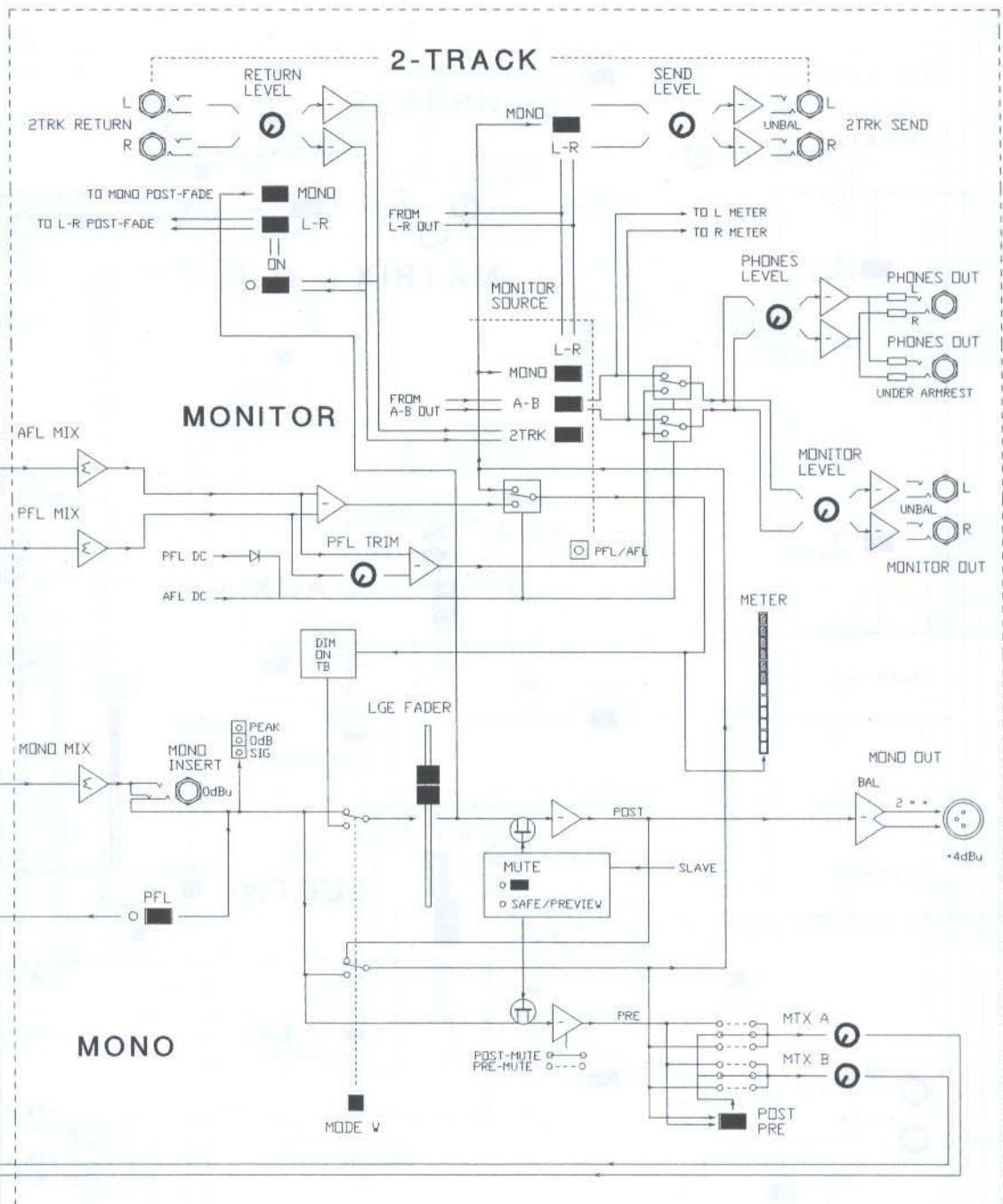

MUTE PROCESSOR SECTION

SHEET 6 OF 6

3000-0001 Rev. 01/91 (New Reference Model)

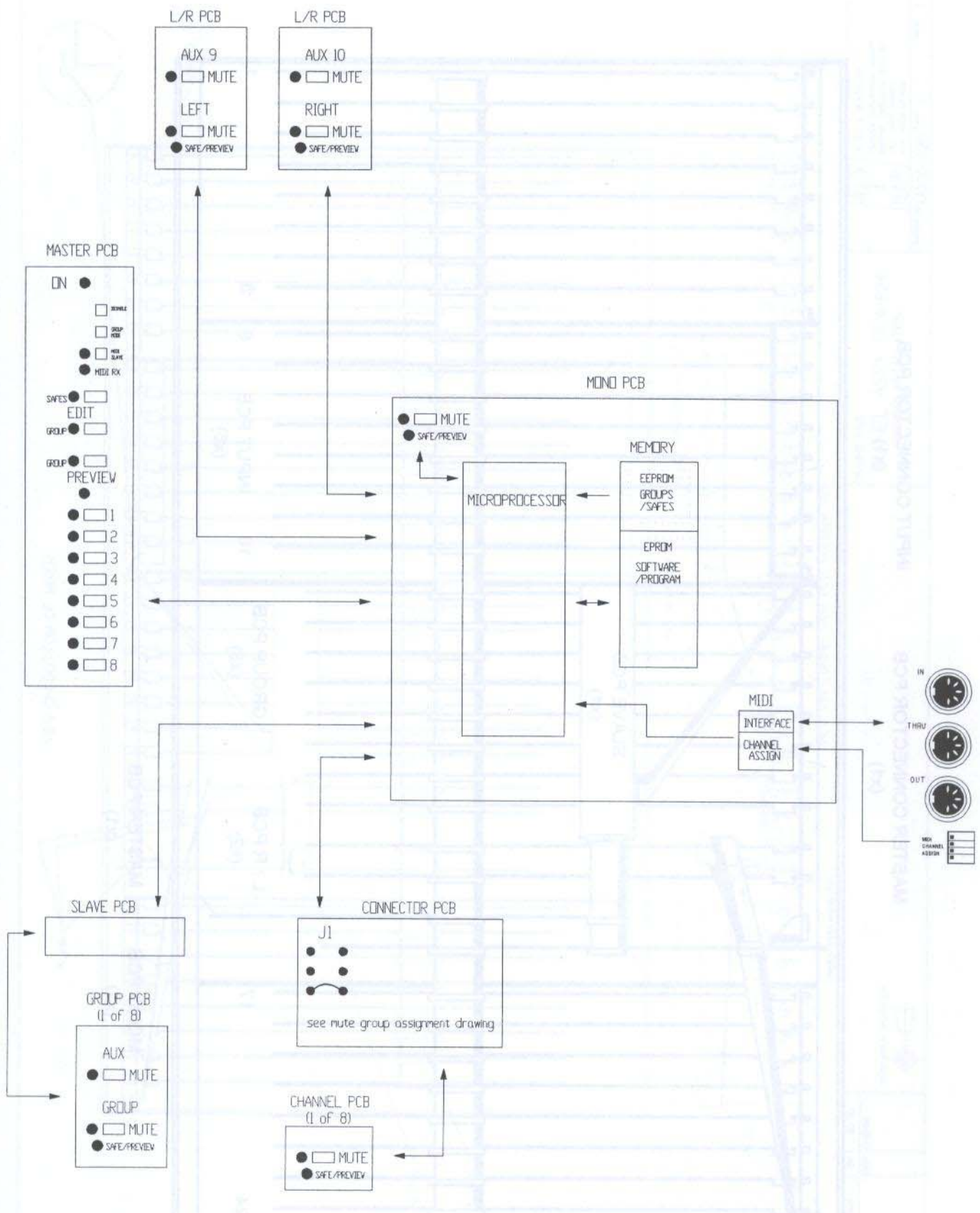

GL4-824 INTERNAL LAYOUT

Console inverted with the base removed.

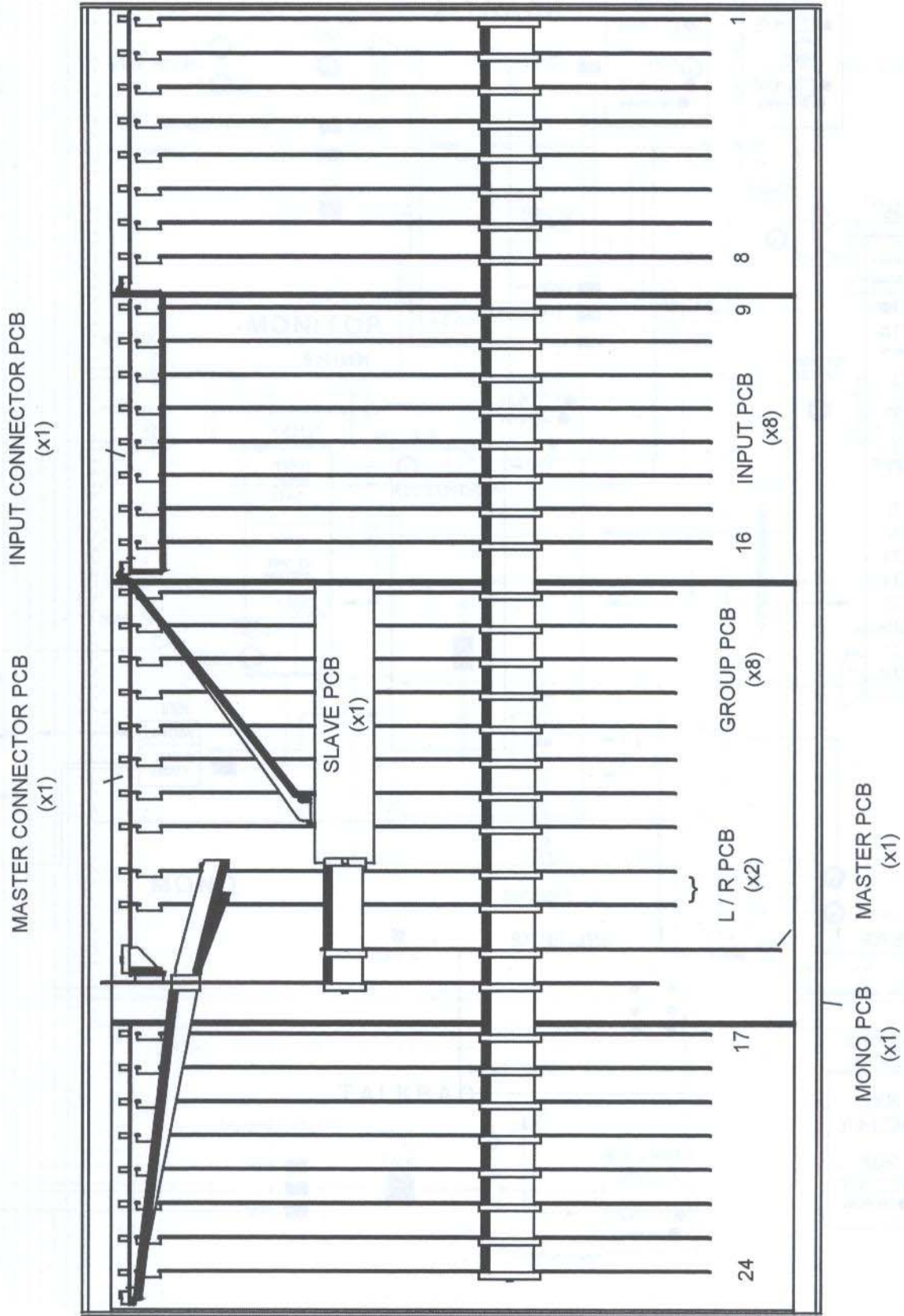

VIEW ON BOTTOM OF MIXER

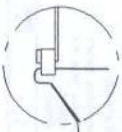

AH18053

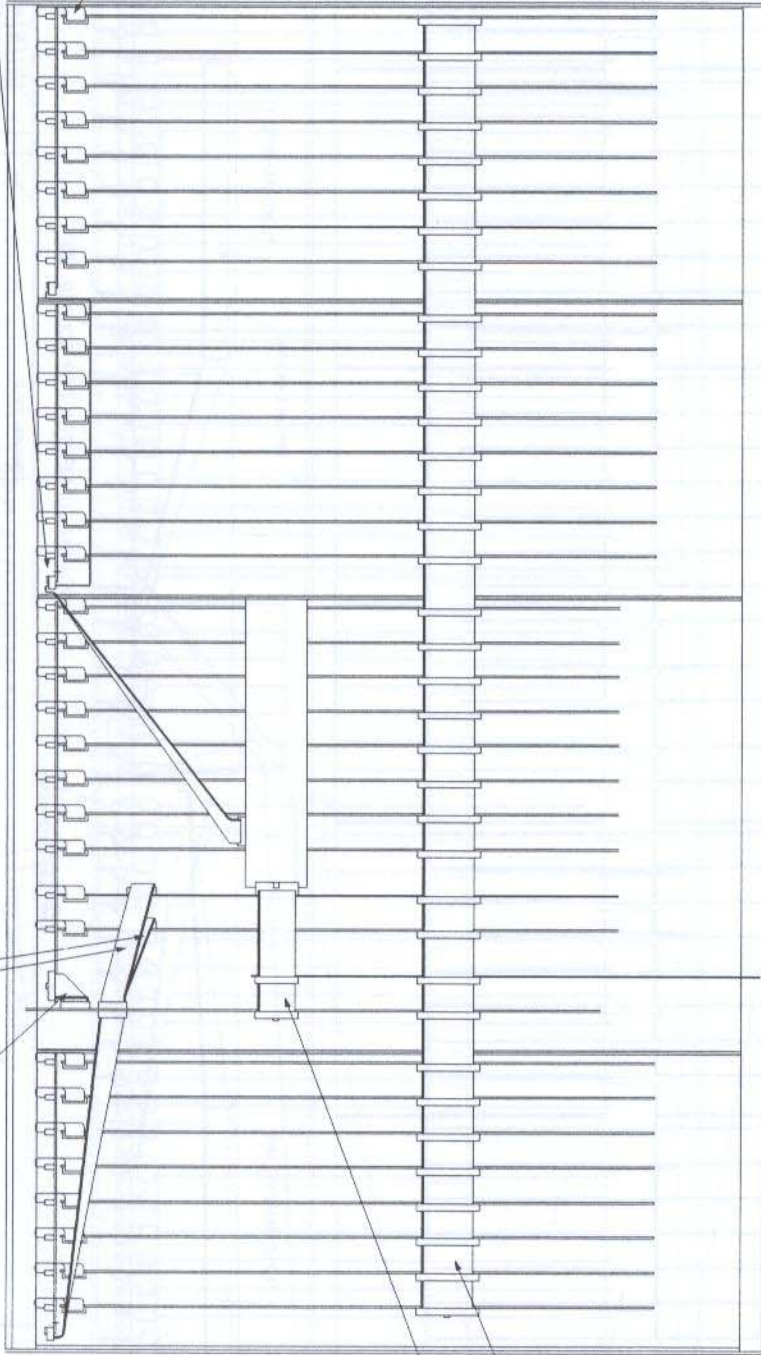

AL2189

AL2099

AL2096

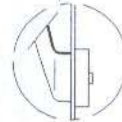

AL2101

THICK LINE IS RED STRIFE
AL2102 (MARKED LH)

VIEW ON CONNECTOR PCB SOLDER SIDE

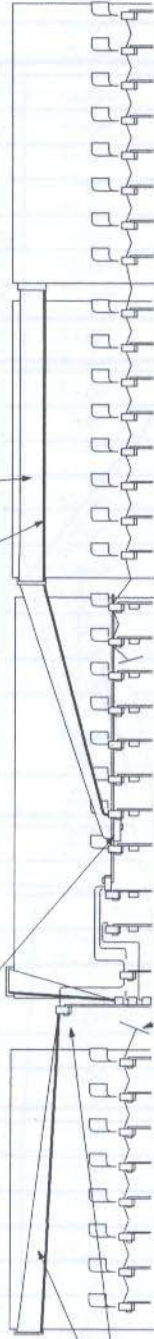

HARNESSE BUSHING BROKEN FOR
CLARITY ALONG WATER SECTION

THIRD ANGLE PROJECTION



ISSUE	REVISION	BY	DATE
1		DRP	10-10-94

DRAWING TITLE
PANEL ASSY GL4-824
 HARNESSE INSTALLATION

ALLEN & HEATH LTD
 KERNICK INDUSTRIAL ESTATE,
 PENRYN, CORNWALL TR10 9LU
 TEL. 0326 272070
 FAX. 0326 272097

DRAWING NO. M000-026

ISSUE

1

AI

GL4-832 INTERNAL

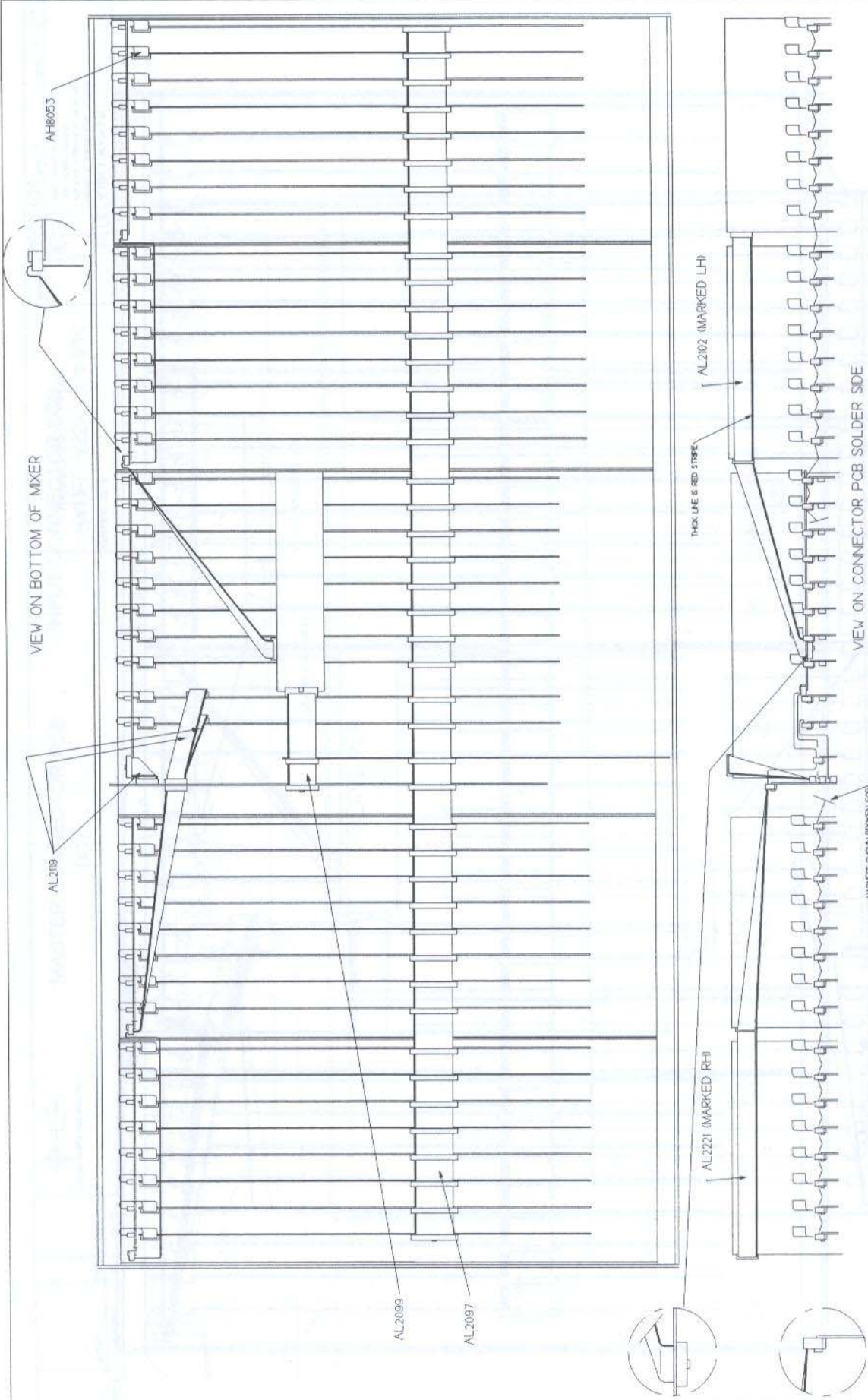

VIEW ON BOTTOM OF MIXER

AH8053

AL2189

AL2099

AL2087

AL2221 (MARKED RH)

THICK LINE & RED STRIP

AL2102 (MARKED LHI)

VIEW ON CONNECTOR PCB SOLDER SIDE

HARNES SHOULD BE OPEN FOR CLARITY ALONG MASTER SECTION

ISSUE	REVISION	BY	DATE
1	ORIG	DRP	13-10-94

THIRD ANGLE PROJECTION



DRAWING TITLE
PANEL ASSY GL4-832
 HARNES INSTALLATION

ALLEN & HEATH
 ALLEN & HEATH LTD
 SERVICES INDUSTRIAL ESTATE
 PEABY, CORNWALL TR10 0U
 TEL. 0285 372070
 FAX. 0285 372097

DRAWING No. M000-027 Sheet 1

ISSUE 1 A

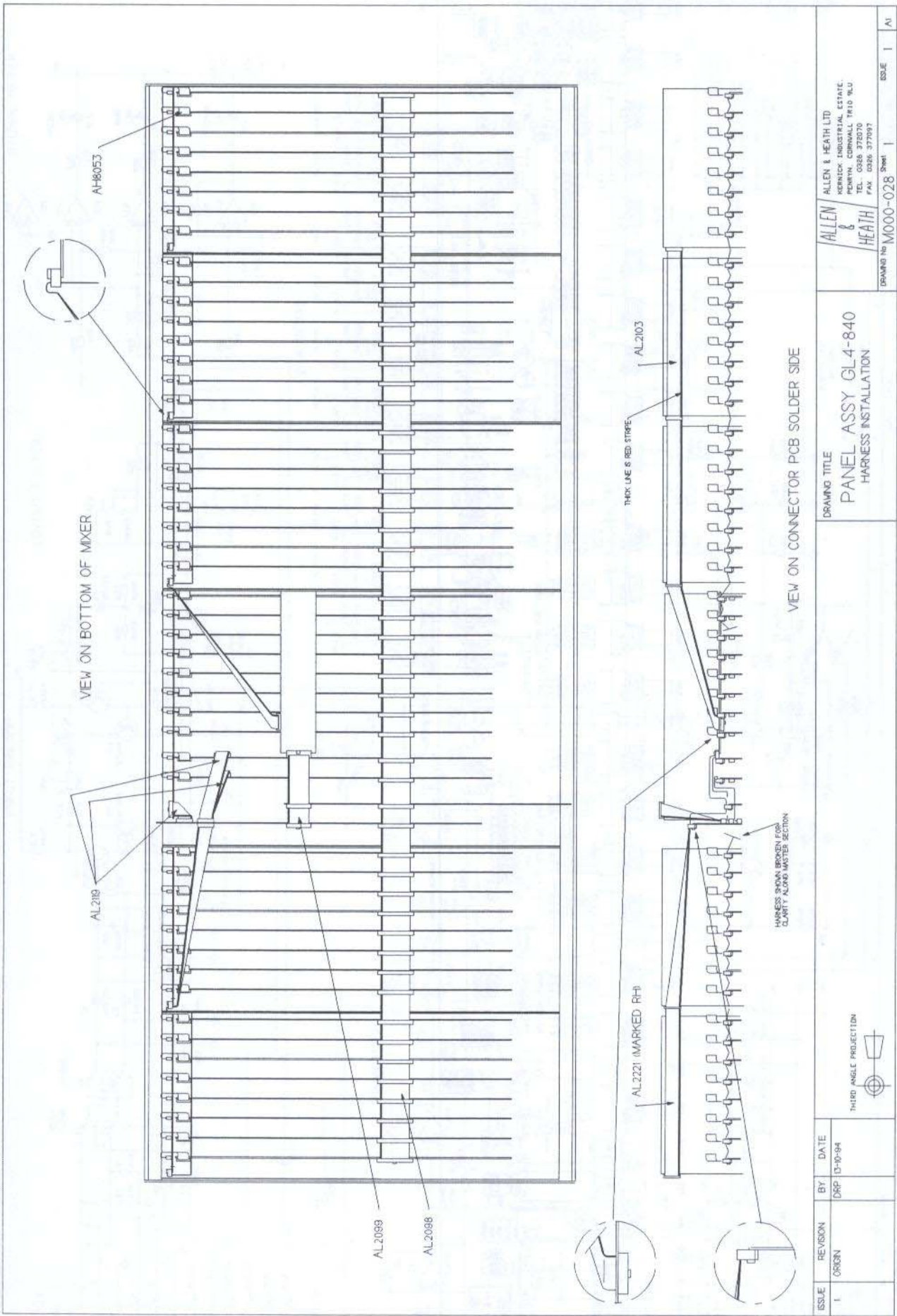

ISSUE	REVISION	BY	DATE	 THIRD ANGLE PROJECTION
1	ORIG	DRP	13-10-94	
DRAWING TITLE				ALLEN & HEATH LTD KENNICK INDUSTRIAL ESTATE, PENRYN, CORNWALL TR10 9LU TEL. 0208 375070 FAX. 0208 377997
PANEL ASSY GL4-840 HARNESS INSTALLATION				
DRAWING No M000-028 Sheet 1				ISSUE 1 AI