

OPERATING
INSTRUCTIONS

SPEECH INPUT EQUIPMENT

- ★ RACKMOUNT
- ★ PORTABLE

OUTSTANDING FEATURES

- 5 inputs, 2 outputs.
- Full flexibility with 5 mixer, master, bass, treble, illumination, VU Range and AC power controls.
- Compact—Occupies 3 rack units (5¼").
- Plug-in microphone AND line (output) transformers.
- High gain (97 db) High output (+18 dbm)
- Shielded power transformer for low noise level.
- DC heater supply for low noise level.
- Germanium and selenium rectifiers for long-term reliability.
- Hinged front panel for immediate access WITHOUT interrupting program connections.
- Non-glare panel with write-in strips for channel identification.
- VU meter accessory installed in minutes WITHOUT soldering.
- Range switch adjusts normal level indication of VU indicator for output levels of 0, +4, +8, +12 VU. (0 level = 1 milliwatt.)
- Prewired XL connector accessory converts screw terminals for portable use — installs WITHOUT soldering in minutes.
- Equalization for reluctance type phono pickup (RIAA) on channels 3 and 4 by means of PLUG-IN equalizer assembly.
- Leather-bound carrying case accessory for portable use — provides microphone and cable storage.
- Lightweight portability — less than 22 pounds with ALL accessories.
- Attenuator coupling networks DOUBLE blocked using MYLAR capacitors for silent control action.
- AB MOLDED composition potentiometers standard equipment.
- Convertible to step-type attenuators.
- Meets FCC requirements for FM broadcast.

- NEW RELEASE
- REPRINT RELEASE WITH NO CHANGES
- REPRINT RELEASE WITH CHANGES



A Subsidiary of Ling-Temco-Vought, Inc.
© 1961 · ALTEC LANSING CORPORATION

1515 S. Manchester Ave., Anaheim, Calif.

New York, Los Angeles

12874-3

LITHO IN U.S.A. G-F ABCDEF

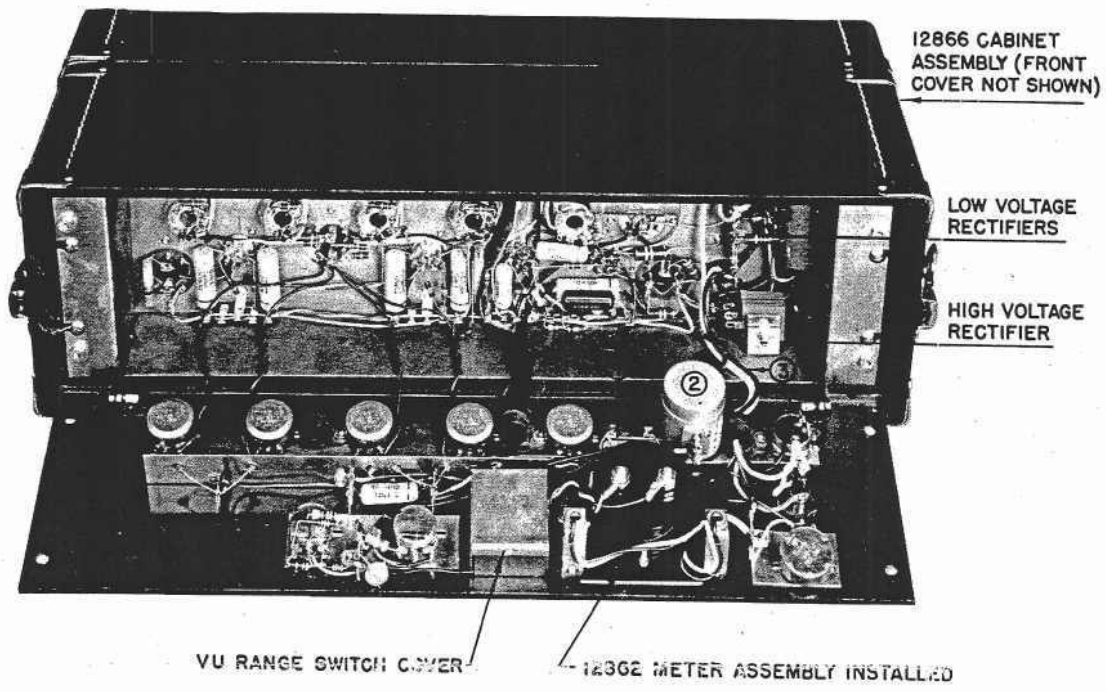
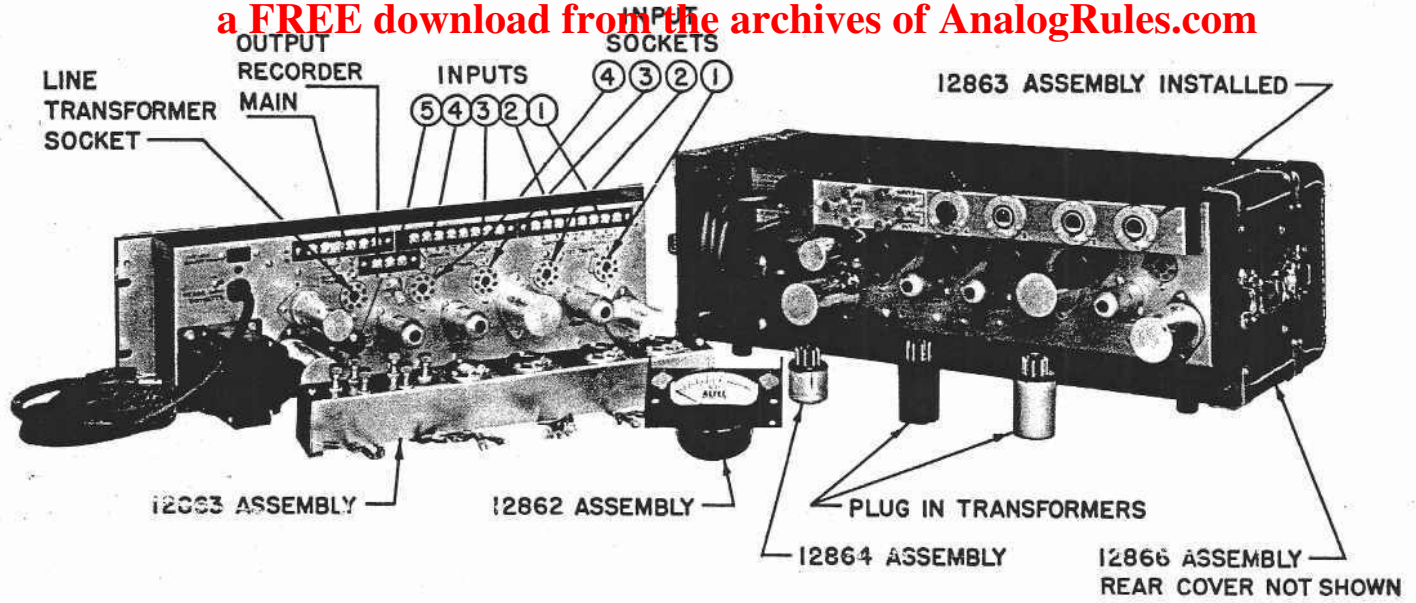

INPUT CONNECTIONS, CHANNEL 1, 2, 3 & 4

Each channel input has four terminals (see photo) to provide various impedance combinations. Directly below each channel input terminal is the octal socket which will have a shorting link, 4722 mic transformer or the 12864 phono adapter (channels 3 and 4 only). Make connections as shown below.

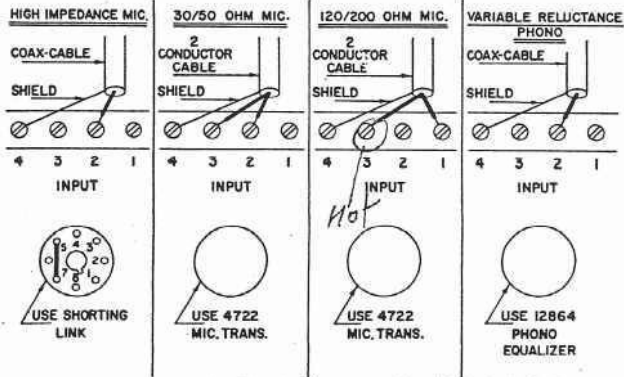

INPUT CONNECTIONS, CHANNEL 5

Channel 5 connections are just below the input-output terminals (see photograph). This is a high level input for use with line level signals, tape machine outputs, tuner outputs, high level ceramic phono cartridge outputs or other signals of .02 volts or more. It is a grounded input. If line isolation is required, a repeat coil such as the 15036 or the 15095 line transformer must be mounted externally.

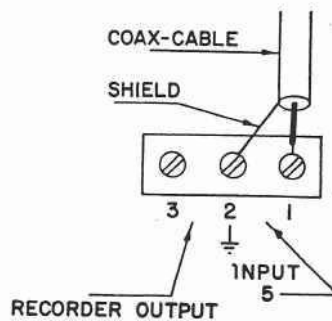

SPECIAL INPUT CONNECTIONS

- High level unbalanced input on mic channel.
A pad is required for this connection. It may be made of two 1/2 watt resistors mounted on an octal plug base as shown.
Install plug in octal socket and make input connections as shown for high impedance microphone.

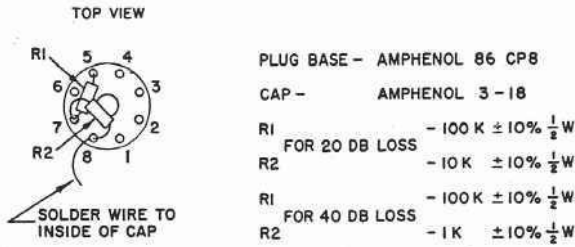

- High level balanced input on microphone channel using 4722 transformer for line isolation.

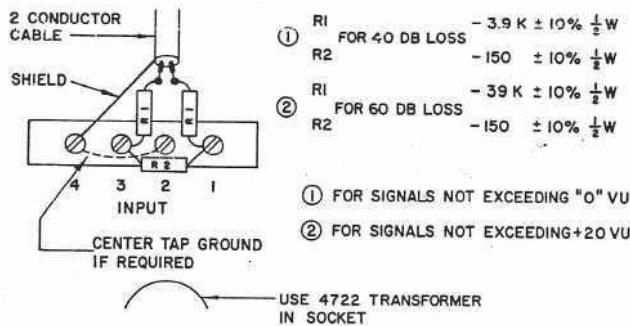

OUTPUT CONNECTIONS

Line Output

Terminals 1, 2, 3, and 4 on the output terminal strip (see photograph) are for loads of 150 and 600 ohms when the 15095 line transformer is used. Connect as shown.

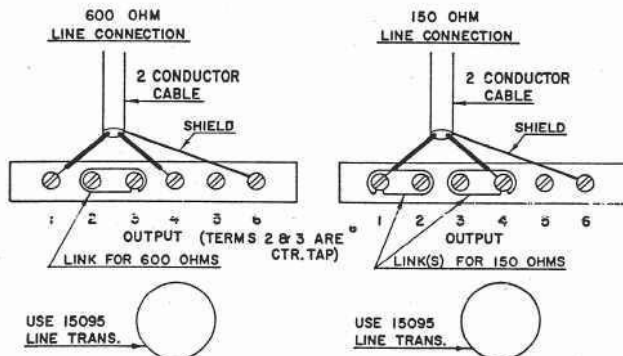

Compressor amplifiers connected between the 1567A and following power amplifiers will provide excessive gain which must be attenuated. The following adjustment procedure is suggested:

- Set 1567A operating controls at "normal" settings.
- With a typical signal feeding the 1567A, adjust attenuation at the input of the compressor amplifier to provide the desired amount of compression. If a control is not provided on the equipment an attenuator or a fixed pad must be added.
- Adjust power amplifier gain control for the desired loudspeaker level.

IT IS IMPERATIVE THAT EXCESSIVE GAIN IS ATTENUATED AT THE POINTS INDICATED ABOVE RATHER THAN

BY GREATER LOSS SETTINGS OF THE MIXER AND MASTER GAIN CONTROLS.

NOISE OR MICROPHONEISM ASSOCIATED WITH THE 1567A WILL BE CAUSED IN MOST EVERY INSTANCE BY FAILURE TO FOLLOW THE ABOVE PROCEDURES.

Direct Output

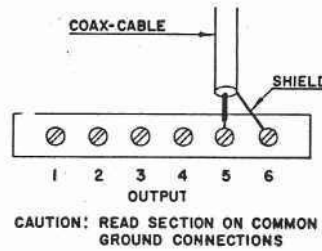

The 1567A can directly drive high impedance power amplifiers such as the 1568A, 1569A, 1570A, 128A, etc. without using the 15095 line transformer. The impedance of the direct output is about 1100 ohms providing good performance over as much as 25 feet of 29 mmf per foot coax-cable. When this connection is used special attention must be given to ground interconnections or hum will result. Be sure to read the section on common ground connections.

Paralleling Outputs (2 or more 1567A Amplifiers)

- Direct Output: Place 15,000 ohm carbon resistor in series with each amplifier output.
- 600 Ohm Output (with 15095 line transformer): Place 560 ohm carbon resistor in series with each amplifier output.
- 150 Ohm Output (with 15095 line transformer): Place 150 ohm carbon resistor in series with each amplifier output.

Note: On 150 and 600 ohm connections where the lines are balanced (not grounded at either end) the resistor values may be halved and two used, one in series with each side of the line for more accurate balance.

Recorder Output

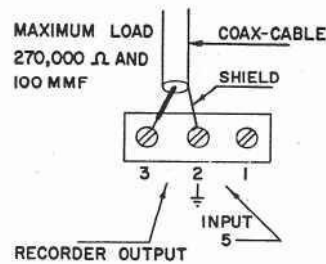

This output can be used to feed signals to tape recorders having an input impedance of 270,000 ohms or more. The interconnecting cable should have a total capacitance of not more than 100 mmf. This is about equivalent to three feet of high grade coax-microphone cable. Before making this connection, be sure to read the section on common ground connections.

COMMON GROUND CONNECTIONS

The circuit ground in the 1567A is connected to the chassis at the input, to prevent RF or other noise picked up on shields of microphone cable from being detected and amplified by the system. Any additional connection between circuit and chassis or ground will cause system hum. When the 1567A is connected to a power amplifier without an isolating transformer (15095 or equivalent), the circuit to chassis connection at the power amplifier must be removed. It is necessary when doing this to make sure that the two chassis remain electrically connected. If the chassis are mounted in the same rack or cabinet or if the 3 wire power cord of one is inserted in the convenience outlet of the other or if both are inserted in outlets providing a third wire ground, the inter-chassis connection will be automati-

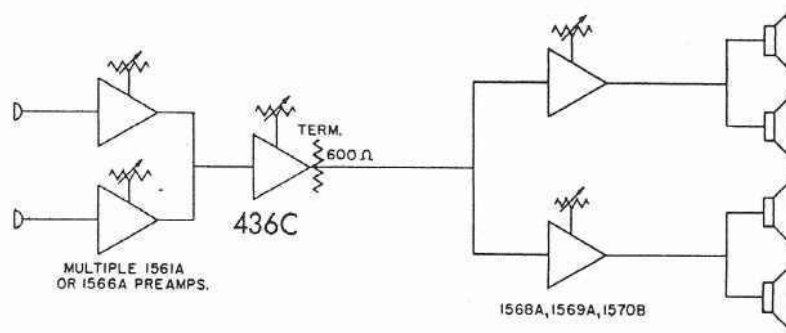

Figure 2

The 436C Compressor Amplifier connected to the high impedance input of the Altec 1568A, 1569A, or 1570B: Terminate 436C with 600 ohms. Line to power amplifiers may be 1,000 feet of 30 mmf/ft cable for 1 db loss at 10 kc.

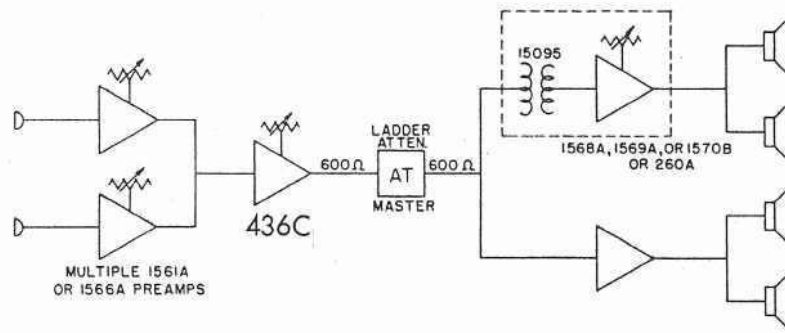

Figure 3

Illustrating the use of a master in compressor output of 436C for control of volume. Added control is essential when Altec 260A amplifier is used.

PARTS LIST

C2,3,5,6	.022mfd, 400v., Micamold Tropicap IMP4-S22	R14	7,000 ohms, 5 watt; axial leads
C4	1mfd, 200v., Hopkins (1P2D)	P1,A-B	Volume Control, Altec 13021-1
C7	80mfd, 350v., Mallory FP-138	P2	Pot., 1 megohm; Altec 14289-1
C8	8-40-10mfd, 200-450-450v., Mallory FP-370	P3	Pot., 25,000 ohms; Altec 14288-1
R3,4	47,000 ohms, $\pm 1\%$, 1/2 watt, deposited carbon	T1	Input transformer; Altec 4651A
R5,6	1 megohm, $\pm 10\%$, 1/2 watt	T2	Output transformer; Altec 16402
R7	220 ohms, $\pm 10\%$, 1/2 watt	T3	Power transformer; Altec 6216
R8	34 ohms, $\pm 1\%$, 1/2 watt, deposited carbon	M1	Meter, Altec 6049
R9	270,000 ohms, $\pm 10\%$, 1/2 watt	PL1	Pilot Lamp; Mazda #44
R10, 11	220,000 ohms, $\pm 10\%$, 1/2 watt	F1	1/2 ampere; 3AG Fuse
R12	33,000 ohms, $\pm 10\%$, 1/2 watt	S1	Power Switch; Altec 12180-1
R13	10,000 ohms, $\pm 10\%$, 1/2 watt	Rectifier	Sarkes-Tarzian 58-D
		V1	6BC8 Vacuum Tube
		V2	6CG7 Vacuum Tube
		V3	6AL5 Vacuum Tube

cally made. In the case of portable tape recorders where the case insulates the metal chassis from ground, the circuit-chassis connection need not be removed unless the power cord has a 3 prong grounding type plug. In this event the circuit-chassis ground or the power line ground must be removed.

Single conductor coaxial cable is used for the unbalanced connections described above. The shield of the coax cable is connected to the amplifier input or output "common" terminal at each end. Two conductor shielded cable is used for interconnection when line transformers are used (15095 or equivalent). In this case circuit-chassis grounds are not disturbed and the cable shields should be connected at one end only.

VU METER ACCESSORY

The 12862 VU meter assembly consists of a bracket and meter. To install, open the 1567A front panel, remove the pilot light holders, two screws and two nuts from the rear side of the pilot light mounting bracket. Discard the light shield and mounting bracket. Mount the meter in the new bracket with the bracket flanges facing toward the front of the meter. Place the assembly over the studs on the panel and secure with the original nuts and washers. Remount the pilot lights in the bracket cutouts and attach the leads, which are under the VU Range Switch cover, to the meter. Be sure to replace the VU Range switch cover. This completes the installation.

CONNECTOR ASSEMBLY

The 12863 Connector assembly provides 4 XL type connectors for the four low level inputs and binding posts for channel 5 high level input, the recorder output and the line output connections. It is installed by laying the connector assembly on the top edge of the chassis and placing the spade lugs on the connector and binding post wires, under the input-output terminal screws, which provide the impedances selected (see section on input and output connections). When the connections have been made, the assembly is rotated to cover the terminals and attached by means of the two captive screws at the ends of the assembly. The spade lugs must be positioned so that the strain relief sleeves do not prevent the assembly from seating on the chassis. The connectors which are provided in the assembly are Cannon XLR-3-13. Cannon XLR-3-12SC plugs are required to mate with them.

CARRYING CASE ASSEMBLY

The 12866 Assembly consists of a fitted case having two covers, two brackets and eight screws furnished as loose parts. The 1567A mounts on the brackets when they are attached to the ends of the cabinet. The brackets are fastened to the cabinet using four of the screws furnished. The other four screws are used to fasten the amplifier chassis to the brackets. Caution—do not mix the four panel screws furnished as part of the 1567A with the case mounting screws. Both are the same type but different lengths. The panel screws must not be greater than $\frac{1}{4}$ inch in length whereas the case screws are $\frac{3}{8}$ inch in length.

The rear case cover has a small slot along one edge to allow input, output and power cables to pass when the cover is attached. The cover may be installed with the slot on the bottom or the top to accommodate cable passage in either direction.

OPERATION

Normal Settings —

For average input signals mixer and master gain controls should be set for a loss of 14 db in each. With these

settings, average microphone levels will produce "0" VU line levels. When high gain power amplifiers such as the 1568A and 1569A follow the 1567A, the gain control on the power amplifier must be set for sufficient attenuation to prevent overdriving the loudspeakers. It is important that the loss be taken in the power amplifier rather than in the master control of the 1567A in order to preserve optimum signal to noise ratio.

Tone Controls —

These provide both boost and attenuation of bass and treble. The normal or flat position is obtained when the knob markers are straight up corresponding to the center position spot on the panel.

Write-in Blocks —

The bleached aluminum area on the control panel above each mixer knob can be written on with soft lead pencil to identify the channel use. To remove writing use a damp cloth—never use a pencil eraser or other abrasive material as the surface will become shiny and unsuitable.

SERVICING

Failure

In event of failure, the trouble can best be localized by means of D.C. voltage measurements. Nominal voltage values are marked on the schematic diagram. Deviations from the marked values as large as $\pm 20\%$ can be expected at the vacuum tube elements and should be considered normal.

Hum

With exception of the output (6CG7) all tube heaters are on D.C. and should contribute no hum. Should hum appear in the output, common connections as described above should be checked and other AC operated devices mounted nearby should be switched "Off" to be sure that magnetic flux field from their power supplies are not at fault. The panel cable marked (3) in the interior view photograph should be examined to see that it does not fold close to the coupling condenser marked (1) when the panel is closed. This cable carries AC current and can couple hum into the other circuits.

SPECIAL MODIFICATIONS

Step Type Attenuators

Miniature Daven or equivalent step type attenuators not exceeding $1\frac{3}{8}$ " diameter and $1\frac{1}{8}$ " depth can be mounted in place of the pots supplied. Typical mounting is shown in the interior view photograph where the attenuator marked (2) replaces the master gain control. When installing, be sure to locate the terminals as shown.

Mixer Controls—Daven CP 124X (20 steps 2 db/step last steps tapered to infinity—no detent)

Master Control—Daven CP 124Y (20 steps 2 db/step last steps tapered to infinity—no detent) (Shaft length— $\frac{3}{16}$ " beyond bushing)

Channel "Off-On" Switches

Mallory LC 250 MPAC-PP or Clarostat type 47 controls with AG-17 switches may be used in place of the standard mixer controls to provide individual channel switches. Install the pot in the normal manner then connect one switch terminal to the pot ground and the other to the pot input. When the mixer knob is pulled "Out" from the panel the channel is switched "Off." Pushing the knob in turns the channel "On."

when an accessory plug (12864) is used in the microphone transformer socket.

For portable use, an adapter converts the screw type input terminals to XL connectors with binding post connections for output. A fitted, leather-bound, carrying case (see photo) with comfortable luggage type handle is available. The space within the top cover is divided into three compartments: the larger to store cables and the two smaller, which are felt lined, to safely carry microphones. All three are covered by an inner lid.

CIRCUIT DESCRIPTION

Each low level input connects to a standard octal socket for use with the 4722 microphone transformer or other accessory. The signal from each input is amplified by one half of a dual triode and fed into a mixing potentiometer. Premium quality Mylar condensers are used to couple tube circuits to potentiometers since the smallest amount of leakage current will contribute to noisy control operation. As shown in the block diagram, a feedback path is provided around input amplifiers #3 and #4 for use with the 12864 plug-in equalizer to provide the RIAA reproduction curve. A fifth high level channel is connected directly to a mixing potentiometer. The output of all 5 potentiometers are combined in a mixing network and connected to a booster amplifier consisting of one half of a dual triode tube. To elimi-

nate the possibility of contact potential current from the grid circuit of the booster stage contributing to mixer control noise, the grid circuit is isolated from the mixer network with a Mylar blocking condenser. Thus, the controls are "double blocked."

The booster output is connected to terminals labeled RECORDER OUTPUT and to the bass and treble equalizer network. A master gain control, also double blocked, follows the equalizer network and controls the final 2 stage negative feedback line amplifier. The line amplifier output has three branches. One connects directly to an output terminal pair. The second to an octal socket and in turn to four output terminals labeled LINE OUTPUT, and the third to the VU attenuator, switch and meter accessory. When the 15095 transformer is installed in the octal socket, 150 or 600 ohm load impedances are available at the line output terminals. Simultaneous use of both outputs is provided by this double terminal arrangement. The VU multiplier is connected directly to the amplifier output rather than to the line side of the output transformer so that the VU meter may be used even though the 15095 transformer is not used. Very little compromise is made in the resistive termination of the meter even though the range multiplier is of a simple type. In the most sensitive position ("0" VU) the meter termination is 3450 ohms (11½% low) and in the least sensitive position, 4150 ohms (6.4% high), maintaining suitable ballistic characteristics.

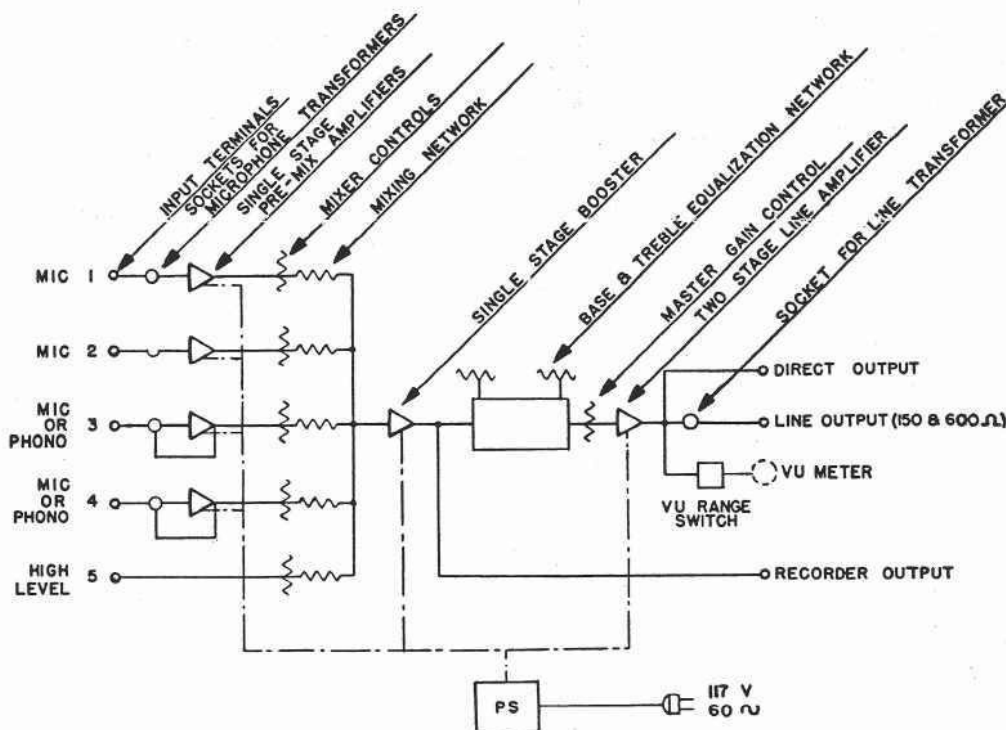

SPECIFICATIONS

Type:	Mixer Amplifier
Gain:	97 db max., channels 1-2-3-4 55 db max., channel 5 (17 mv input for 0 dbm output)
Power Output:	+18 dbm or 50 v open circuit
Frequency Response:	±1 db 30-15,000 cps
Input Impedance:	1 megohm channels 1-2-3-4; .25 megohm channel 5
Source Impedance:	30/50 and 120/200 ohms, channels 1-2-3-4 with 4722 Plug-in Microphone Transformer
Load impedance,	
Max. Output:	15,000 ohms to infinity. 150 and 600 ohms with 15095 Plug-in Line Transformer.
Recorder Output:	At least 270,000 ohms, 100 mmf max. capacity
Noise Level:	Equivalent input noise —123 dbm Output noise —68 dbm with master gain control closed
Controls:	5 mixer, master, bass, treble and illumination controls, VU range, power switch
Power Supply:	117 volts, 60 cps, 20 watts
External Power Available:	117 volt ac receptacle on chassis
Tubes:	3 — 12AX7, 1 — 6CG7
Dimensions:	5¼" H x 19" W x 6¾" D
Color:	Dark Green
Weight:	10¾ lbs.
Accessories:	12862 VU Meter assembly 12864 Phono Equalizer assembly 12863 XL Connector assembly 12866 Portable carrying case 4722 Plug-in Microphone Transformer 15095 Plug-in Line Transformer

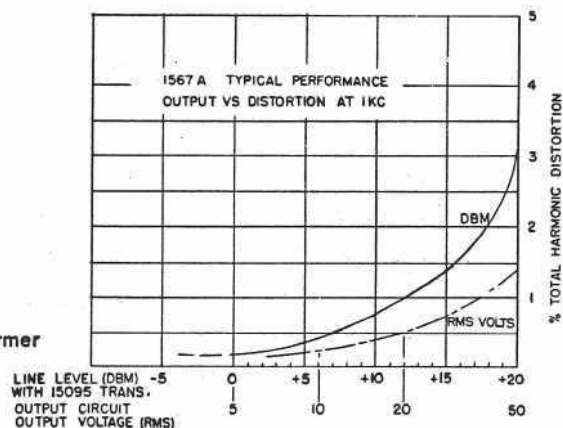

GENERAL DESCRIPTION

The 1567A is a five-channel mixer amplifier having four low level and one high level inputs. Front panel controls include 5 mixers, master, bass, treble, VU range, illumination and power. The entire unit, including its AC operated power supply is constructed on a standard rack chassis, occupying only 5¼ inches of mounting space.

Its design is such that the hinged front panel may be opened without interrupting program. Sufficient space has been allowed to install miniature step-type attenuators in place of the molded composition controls which are standard equipment.

The control panel has raised abrasion resistant characters with bleached "write-in" blocks for channel identification. Background areas are etched and colored in a non-glare easy-eye green.

The AC operated power supply has a shielded power transformer to limit stray flux fields. It uses selenium rectifiers for the plate and germanium rectifiers for the heater supply. A standard 3 wire cord and attachment cap are provided for connection to the AC line. A convenience out-

let on the rear of the chassis is controlled by the equipment power switch. The four low level inputs may be used with high impedance microphones using the coupling link provided or with low impedance microphones by substituting plug-in transformers for the coupling links. The output may be connected directly to a load or isolated by means of a plug-in line transformer. An additional output, unaffected by tone and master gain controls, is provided for supplying signal to tape recorders. Various accessory items provide unusual flexibility in operation and application. A VU meter accessory can be installed in minutes without soldering. Its multipliers and range switch are a standard part of the 1567A. The switch, in addition to "OFF," adjusts the normal level indication of the volume indicator to correspond to output levels of 0, +4, +8, or +12 VU into 150 or 600 ohm loads using the 15095 line transformer. The VU meter may be used as an output indicator also, without the 15095 line transformer, in which case normal indication with the range switch in the "0" position corresponds to an output of 4 volts.

Inputs #3 and #4 are wired to provide RIAA equalization for magnetic reluctance type phonograph pickups

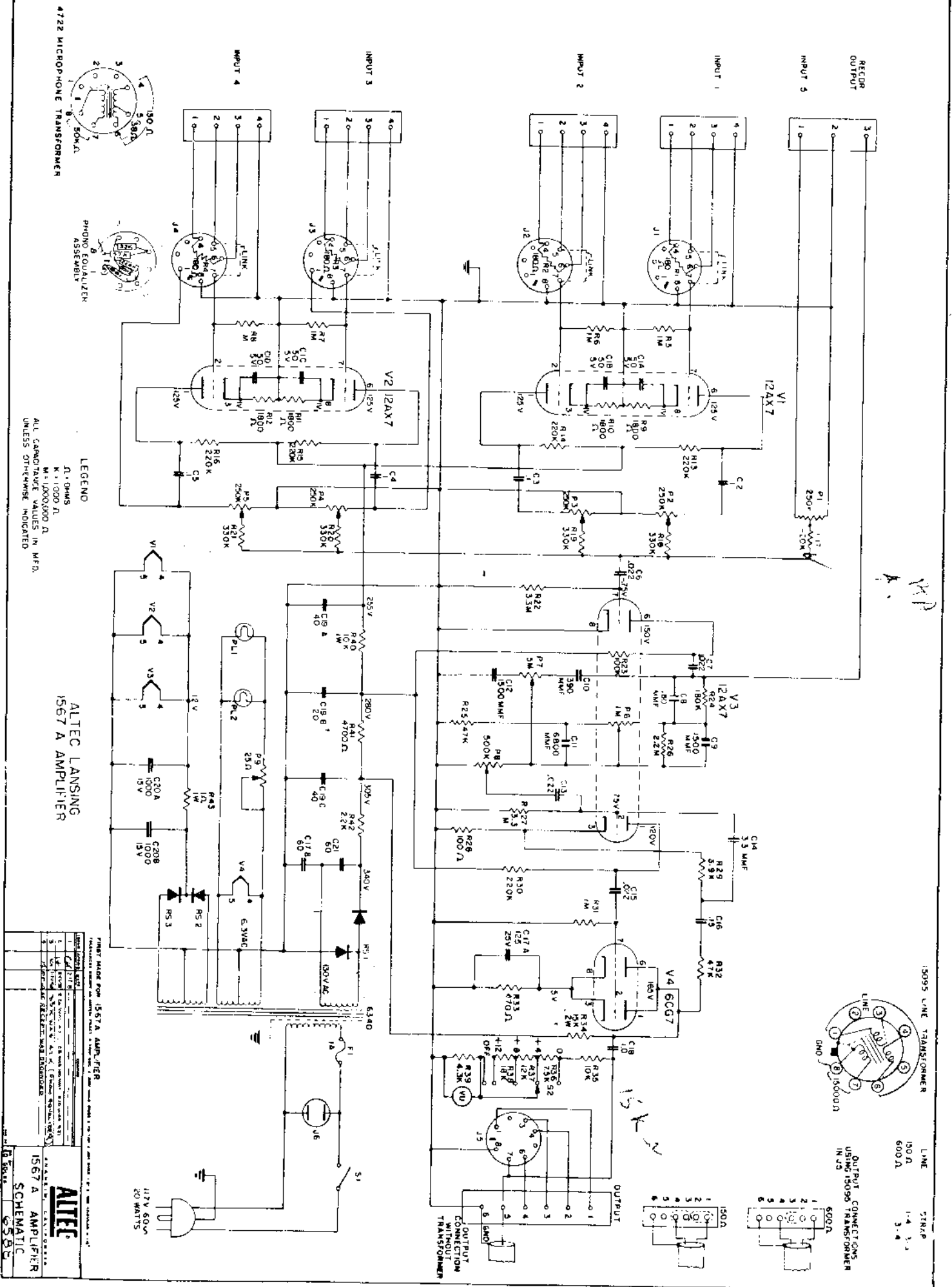

4722 MICROPHONE TRANSFORMER

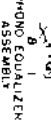

PHONO EQUALIZER ASSEMBLY

LEGEND

- Q - DIODES
- K - 1000 Ω
- M - 100000 Ω
- Ω - 1000 Ω

ALL CAPACITANCE VALUES IN P.F.D. UNLESS OTHERWISE INDICATED

ATTEC LANSING 1567 A AMPLIFIER

1567A AMP. FILTER

1567 A AMPLIFIER SCHEMATIC

15095 LINE TRANSFORMER

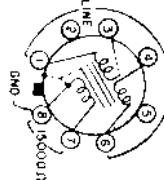

OUTPUT CONNECTIONS USING 15095 TRANSFORMER IN J5

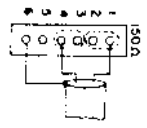
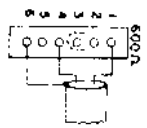

OUTPUT CONNECTION TRANSFORMER

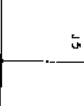

PRINTED BOARD FOR 1567A AMP. FILTER

NO.	DESCRIPTION	QTY.	REMARKS
1	1567A AMP. FILTER	1	
2	1567A AMP. FILTER	1	
3	1567A AMP. FILTER	1	
4	1567A AMP. FILTER	1	
5	1567A AMP. FILTER	1	

ATTEC LANSING 1567 A AMPLIFIER SCHEMATIC

a **FREE** download from the archives of **AnalogRules.com**
1567A Mixer Amplifier

1567A

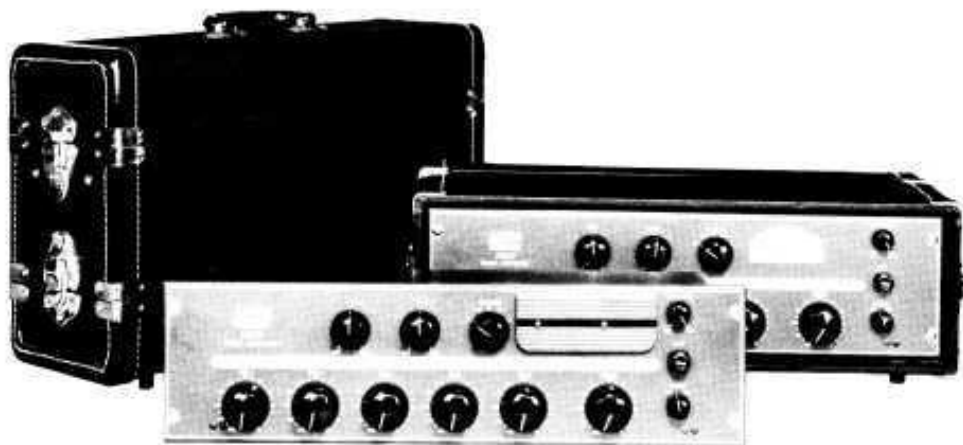

- 5 inputs**
- 2 outputs**
- Great flexibility**
- Input matchers**
- High gain**
- Compact**
- Low noise level**
- Meets FCC FM requirements**
- Installs without soldering**

The 1567A is a Mixer Amplifier of exceptional flexibility for use in public address systems and broadcast studios or as a remote, portable mixer. It has four low level inputs and one high level input each with individual volume controls, a master gain control, separate bass and treble tone controls, a power switch, illumination control and facility for an accessory VU meter.

An outstanding feature of the 1567A is its input versatility. As supplied, each of the four low level inputs are connected to receive high impedance microphones. Installation of the 4722 plug-in transformer converts any of the inputs to low impedance. Insertion of the 12864 accessory plug will convert either of two low level inputs to phono facility and provide the proper RIAA equalization for magnetic pickups.

Two outputs are provided; the main output which may be connected directly to a high impedance load or isolated by the addition of the 15095 plug-in line transformer for low impedance lines; the second output is provided for supplying signal to tape recorders and is unaffected by the master gain and tone controls.

Additional accessory items include a portable carrying case which incorporates microphone and cable storage space, a VU meter assembly which can be installed without soldering and for which multiplier and range switches have been provided in the 1567A, and an adapter which converts the screw terminals of the 1567A to XL input connectors and binding post output terminals. As supplied, the mixer is equipped with molded composition attenuators, however, sufficient space has been provided for the installation of miniature step-type units.

Installation and service time have been cut to the minimum by the use of screw terminals and the pre-wired three-conductor power cord. No soldering is required to install either the 1567A or any of its accessories. The hinged front panel gives full access to all components without interrupting operation of the unit.

The performance of this self powered mixer amplifier exceeds FCC requirements for both AM and FM broadcasting. With its outstanding flexibility it will be found the most economical mixer for every quality application, tailored to exact requirements.



A Subsidiary of Ling-Altec Electronics, Inc.

1515 S. Manchester Ave., Anaheim, Calif.

New York, Los Angeles

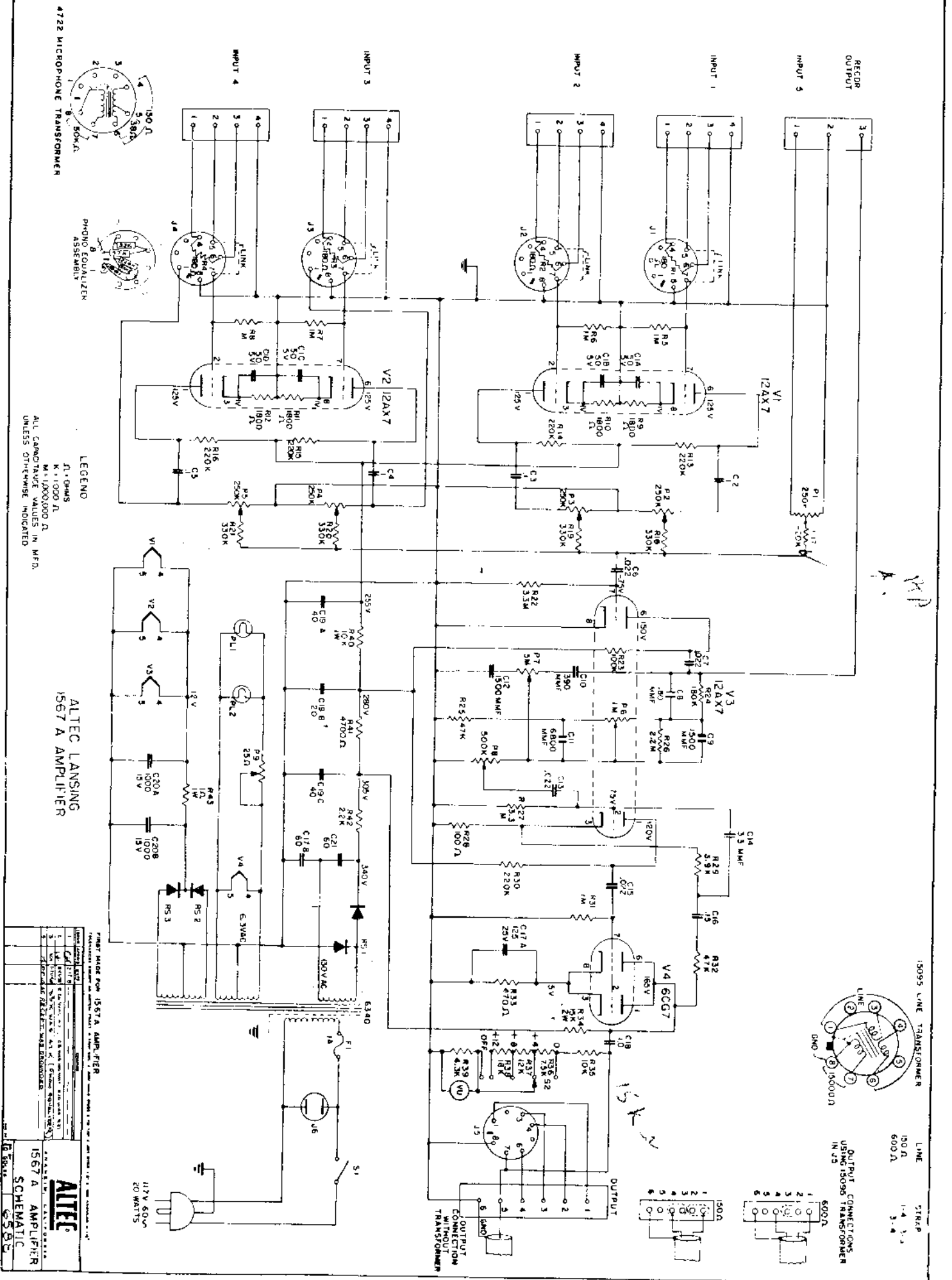

4722 MICROPHONE TRANSFORMER

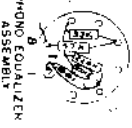
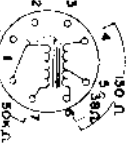

LEGEND

N-1000Ω
 M-10000Ω
 K-1000Ω
 L-10000Ω
 ALL CAPACITANCE VALUES IN MFD.
 UNLESS OTHERWISE INDICATED

ATTEC LANSING
 1567 A AMPLIFIER

1567A AMP. FILTER

ATTEC
 1567 A AMPLIFIER
 SCHEMATIC

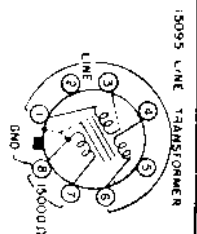

15095 LINE TRANSFORMER
 LINE 150Ω
 600Ω
 1-4 3-4
 5-4
 OUTPUT CONNECTIONS
 USING 15095 TRANSFORMER
 IN J5
 500Ω
 1-4 3-4
 5-4

OUTPUT CONNECTION TRANSFORMER

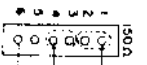

1567A AMP. FILTER

ITEM NO.	DESCRIPTION	QTY.	REMARKS
1	12AX7	4	
2	6CG7	1	
3	15095 LINE TRANSFORMER	1	
4	4722 MICROPHONE TRANSFORMER	1	
5	PHONO EQUALIZER ASSEMBLY	1	
6	1567A AMP. FILTER	1	

117V 60W
 20 WATTS

