

Service *Manual*

MODEL: A500.2

CONTENT

1. Introduction.....	1
2. Specification.....	2
3. Schematic Diagram.....	3
4. Wiring Diagram.....	9
5. Printed Circuit Board.....	10
6. Exploded View & Mechanical Parts List.....	11
7. Electrical Parts List.....	13

1. Introduction

- 1.5U 1/2 rack, stereo high power amplifier.
- Fantastic audio quality even with extremely high volume levels.
- Solid and durable, can be mounted into a cabinet.
- User-controllable clip limiter.
- 2×480 Watts on 4 ohms (EIAJ)
- Balanced XLR inputs and 1/4"TRS jack to ensure noiseless long wiring.
- Neutrik Speak-on connectors for output.
- Front panel LED indicators for signal, limit and clip.
- Accurate gain control.
- Independent thermal overload protection on each channel automatically protects amplifier and speakers.
- Single channel over-heat protection.

2. Specification

MODEL	A500.2 DRAGONFLY
20Hz 20KHz@0.1%THD, Stereo Mode	
8 ohms per channel(EIAJ)	260W
4 ohms per channel(EIAJ)	480W
4 ohms per channel(RMS)	245W (at THD 1%)
Input Sensitivity @4 ohms	+3dBu
Controls	FRONT: Power switch, CH1 & CH2 LEVEL knobs
	REAR: CH1 & CH2 LIMITER
Indicators (per channel)	Power-On: Green LED
	Clip: Red LED
	Limit: Yellow LED
	Signal: Green LED
Connectors of each channel	Input: COMBO connector
	Output: NEUTRIK Speak-on connector
Power Supply	190-240 Vac~50Hz / 95-120Vac~60Hz
Dimension	314W x 208.5D x 66.6H mm / 12.4" x 8.2" x 2.6"
Net Weight	3.85 kg (8.49lb)

3. Schematic Diagram

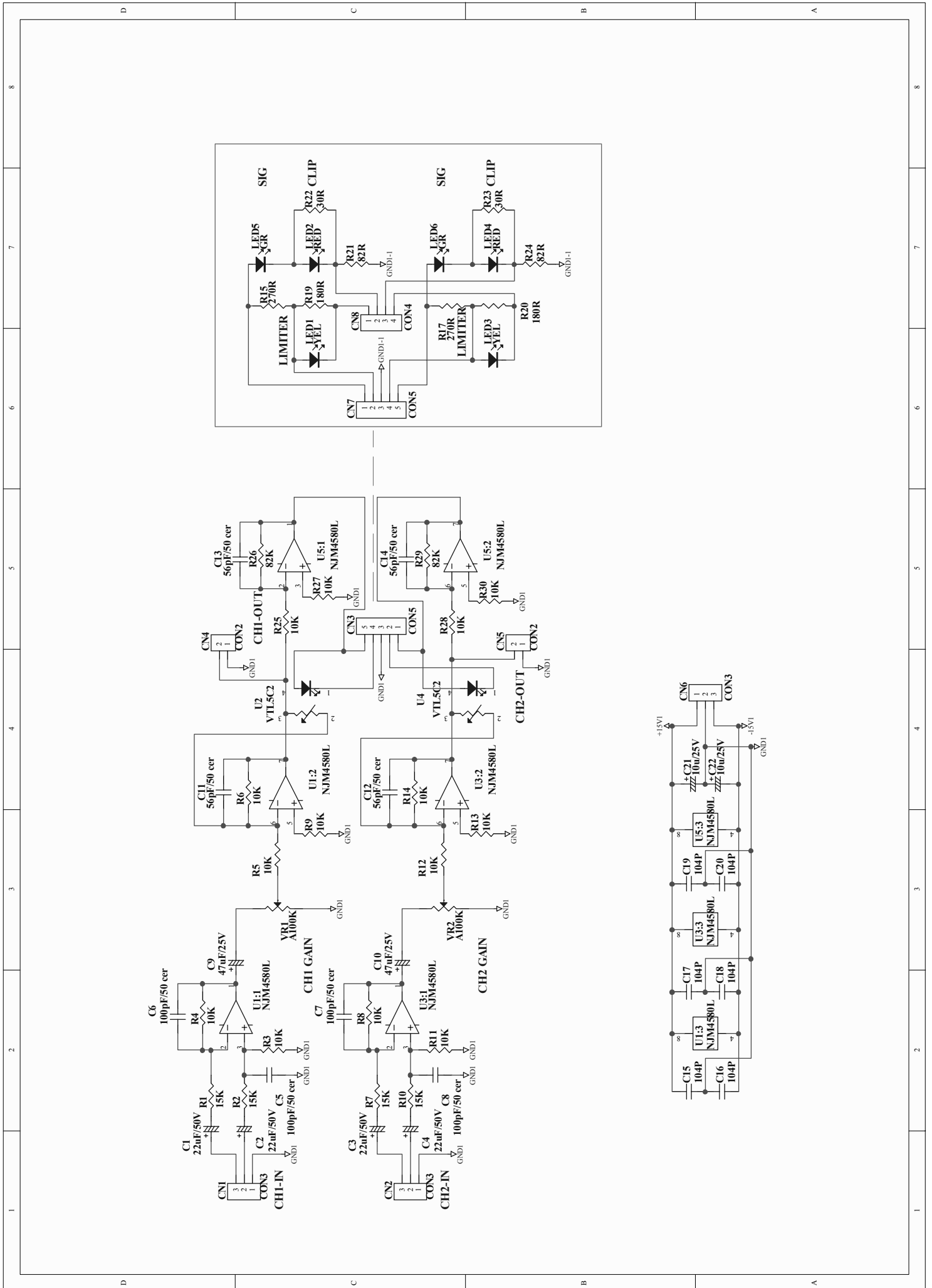

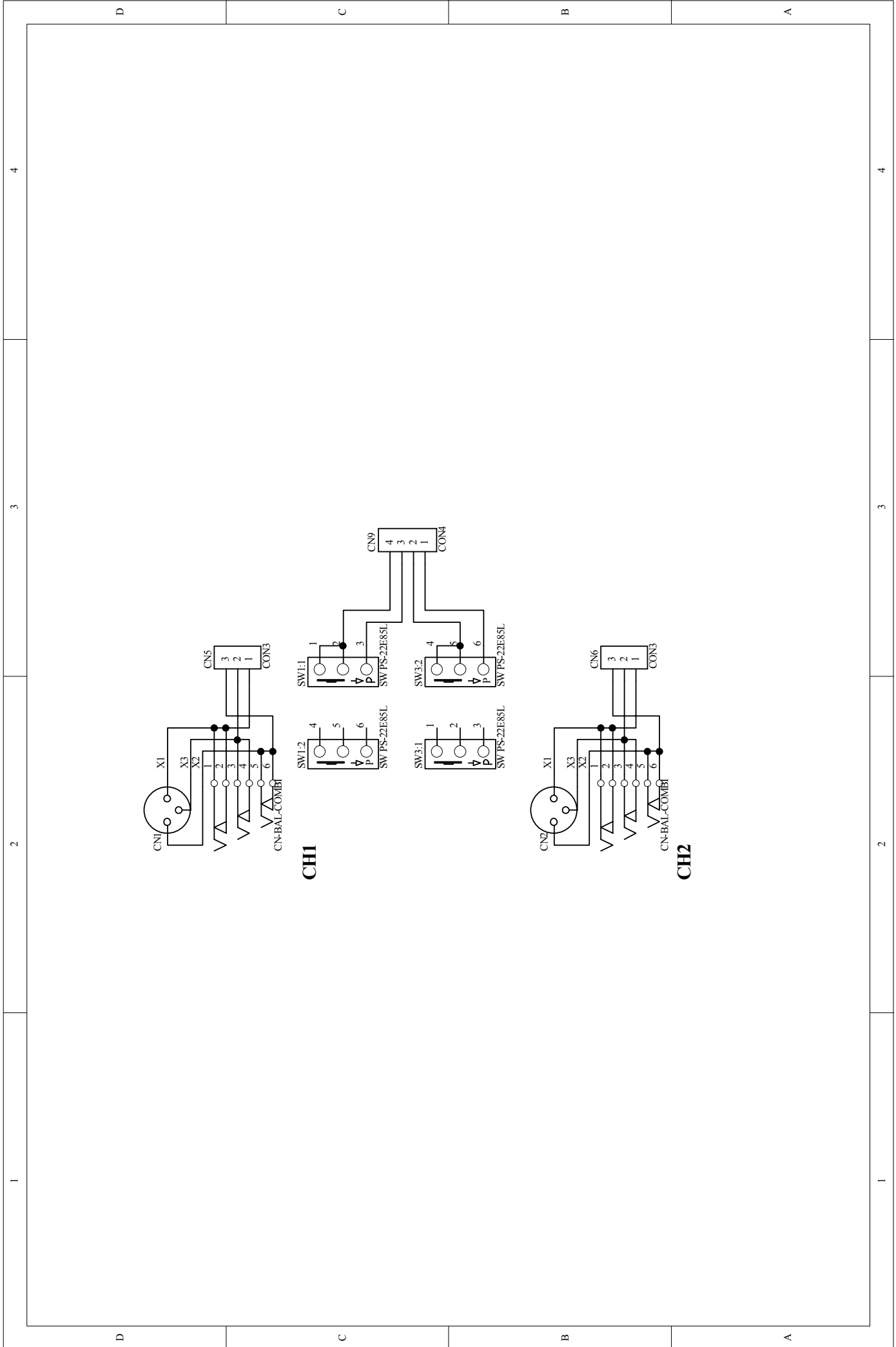

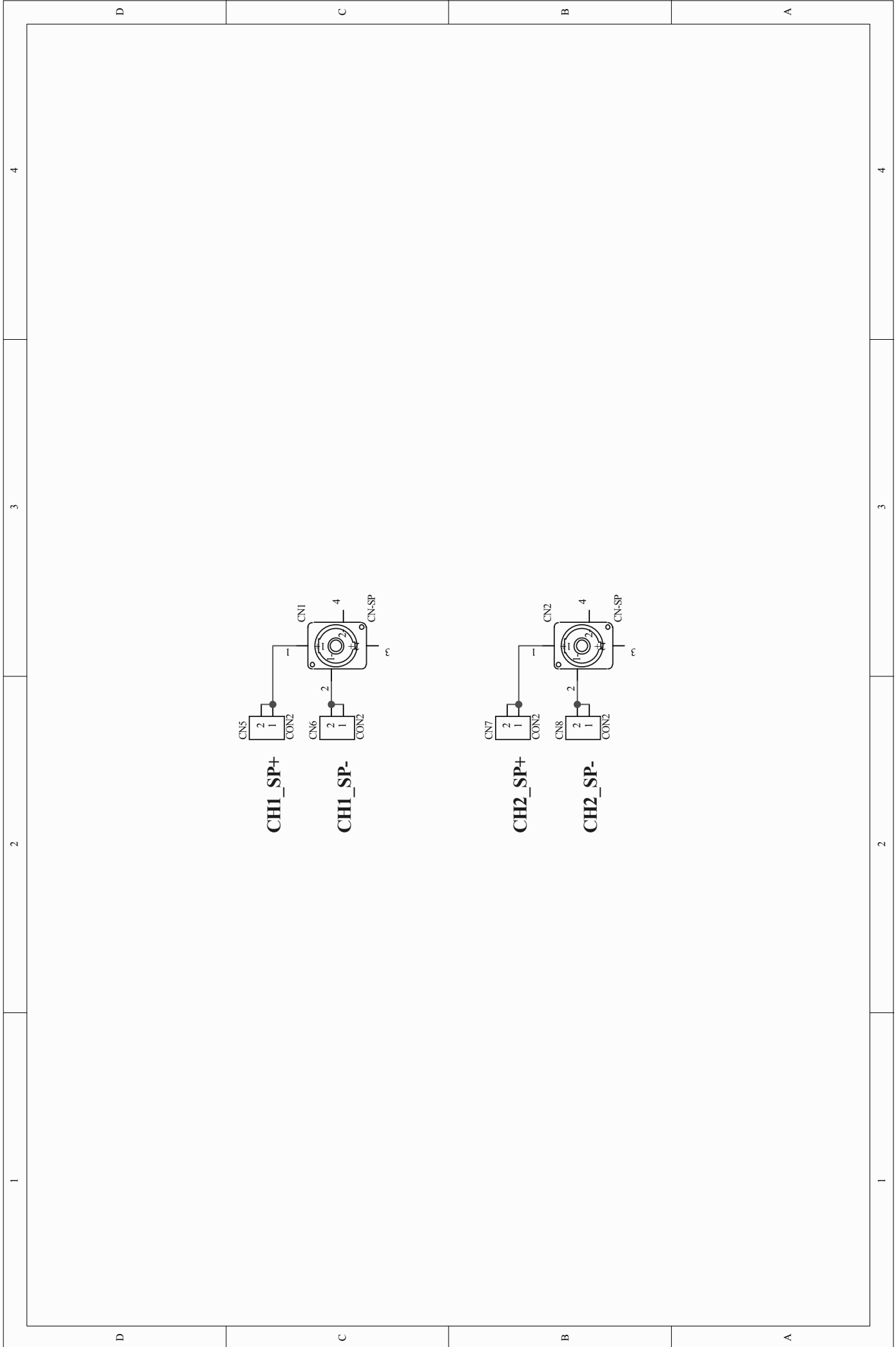

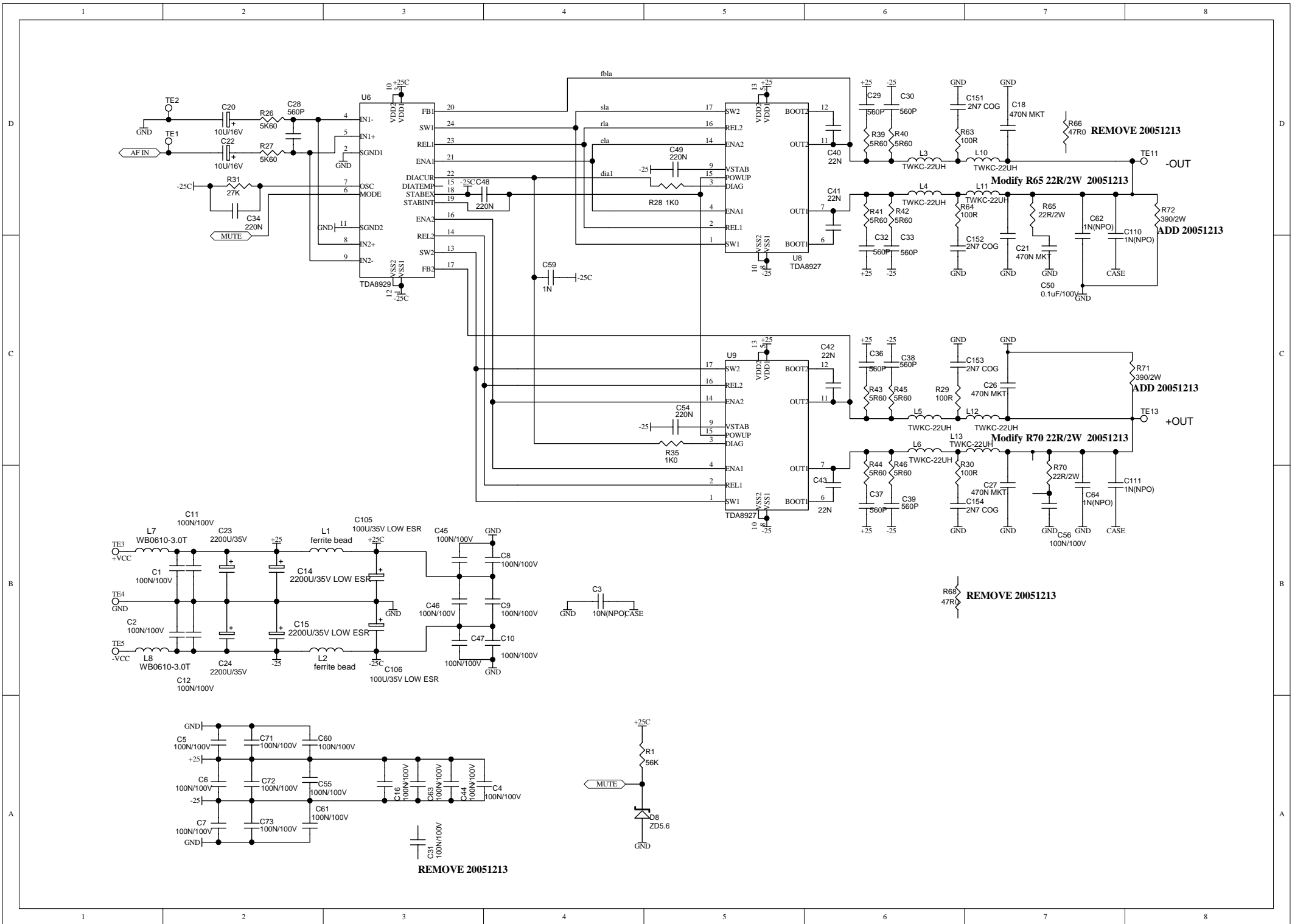

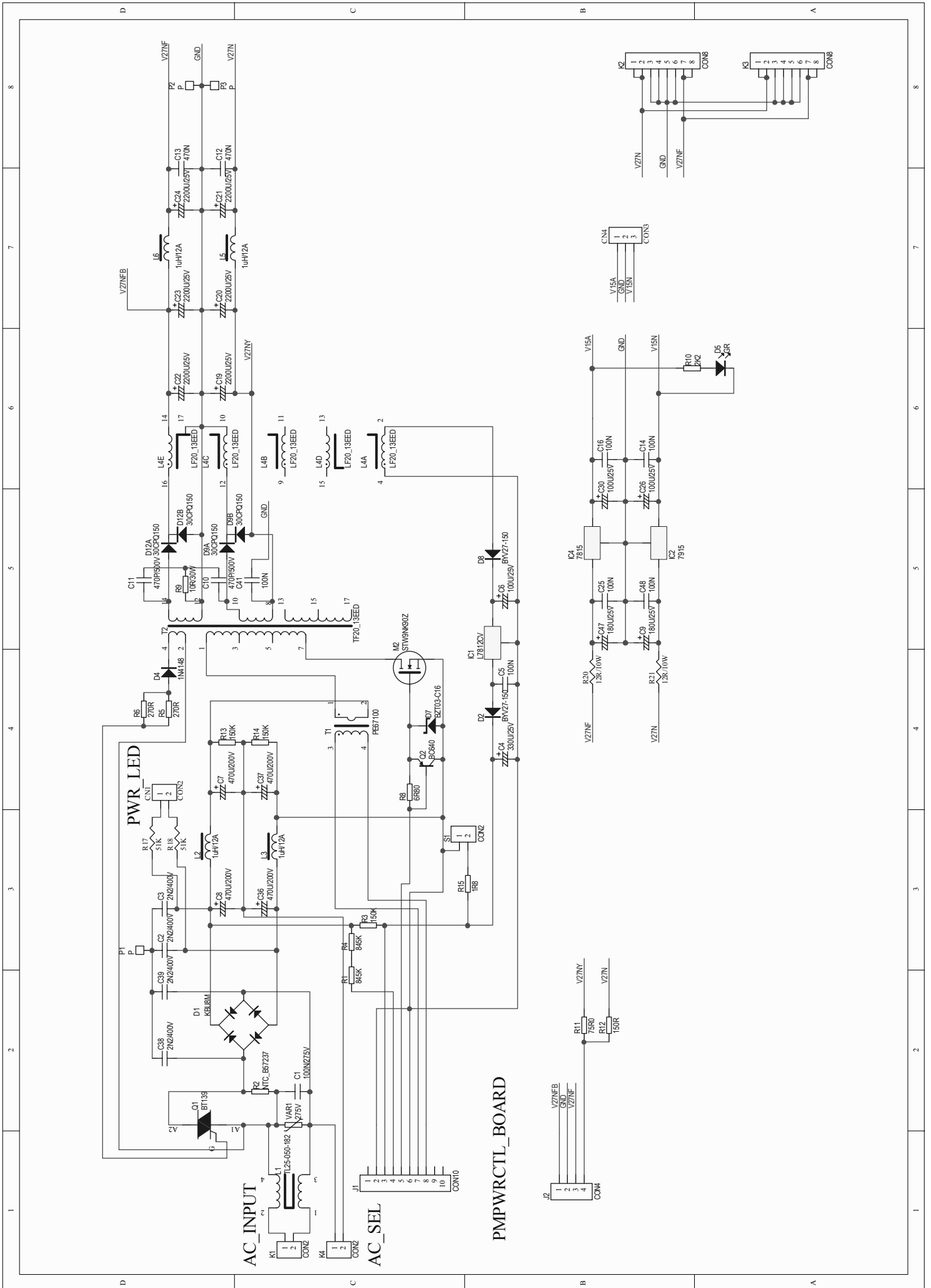

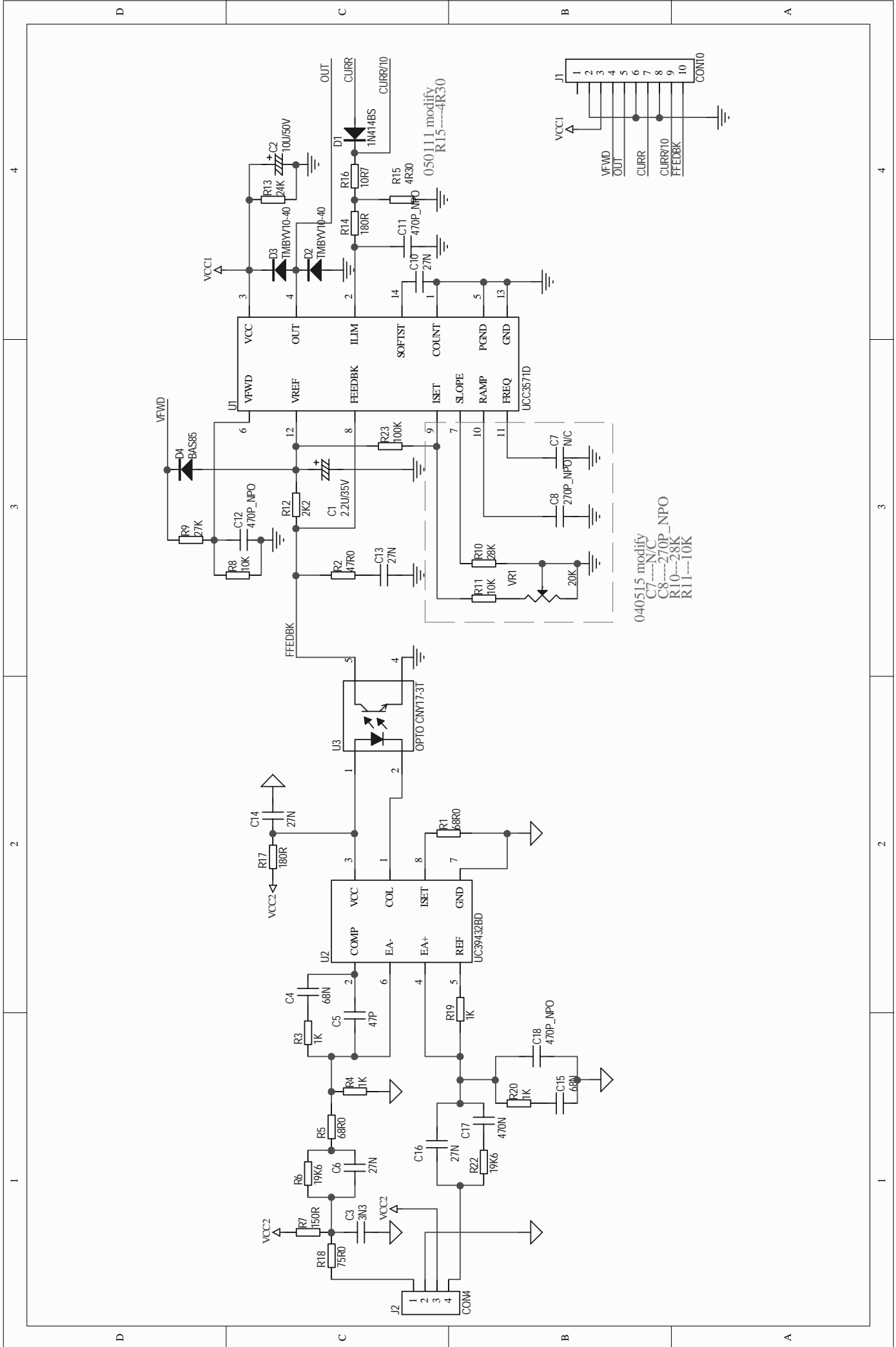

040515 modify
 C7----N/C
 C8----270P_NPO
 R10----28K
 R11----10K

4. Wiring Diagram

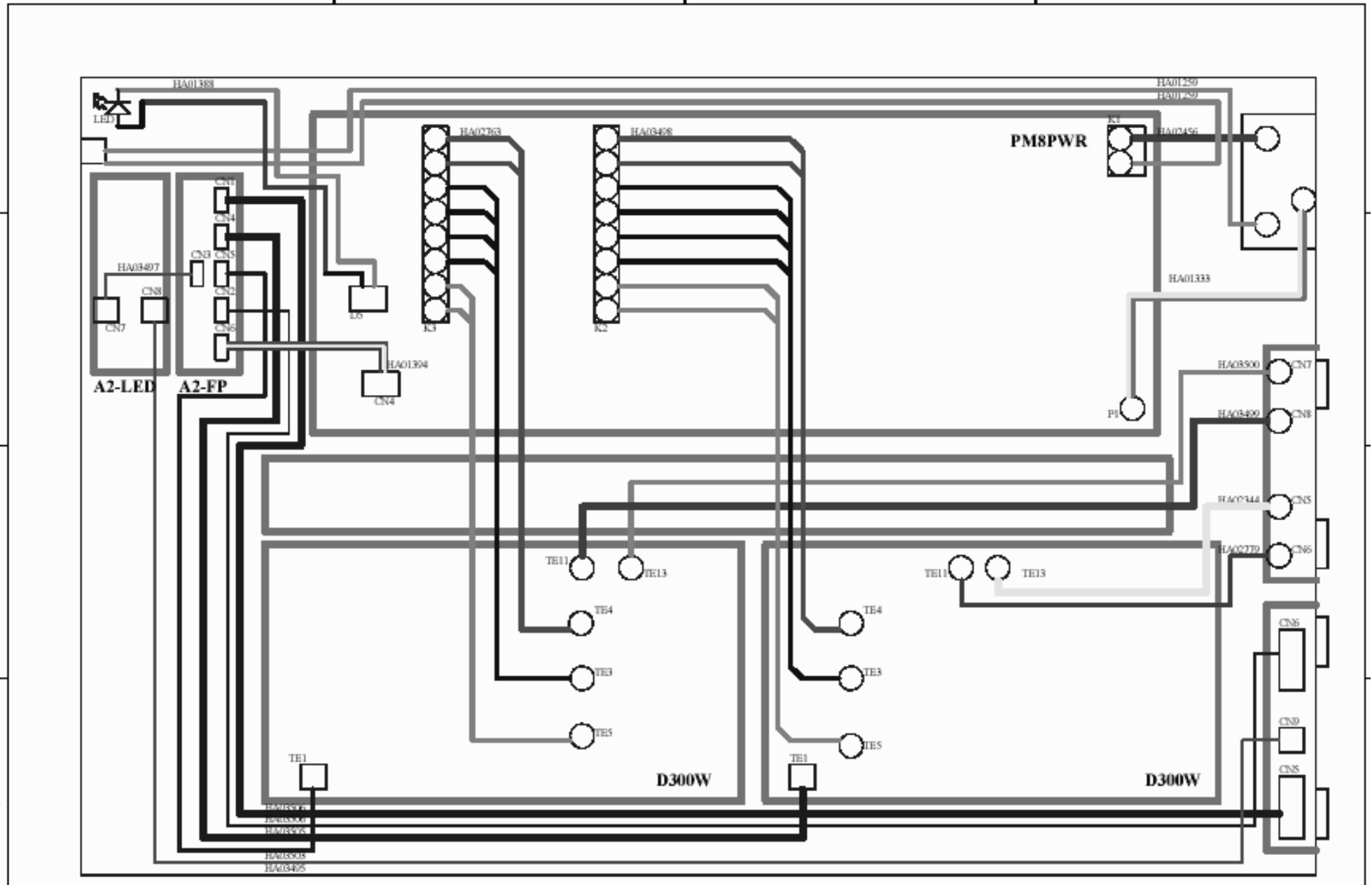

5. Printed Circuit Board

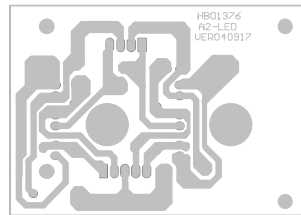
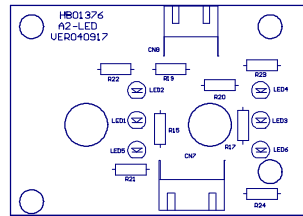
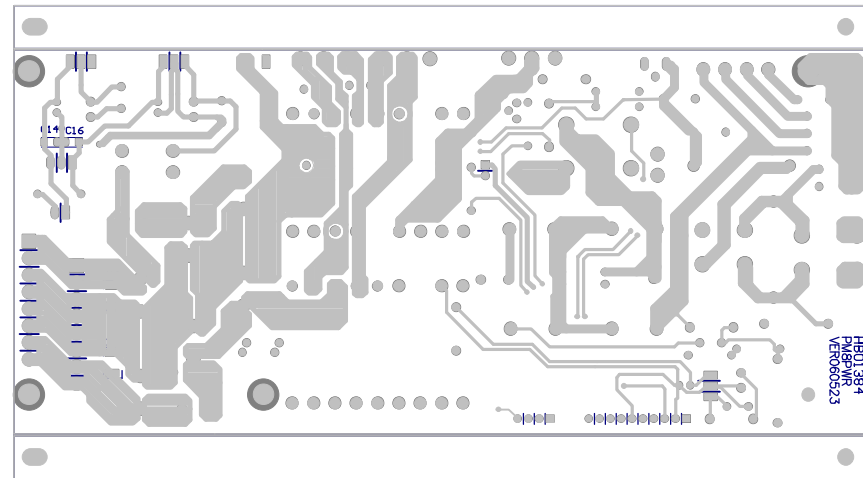
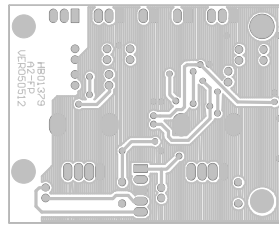
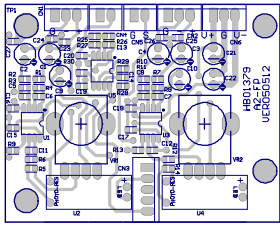

PCB:PM8PWR BOTTOM LAYER BOTTOM OVERLAY BOTTOM SOLDER

PCB:A2-LED TOP OVERLAY

PCB:A2-LED
BOTTOM LAYER
BOTTOM SOLDER

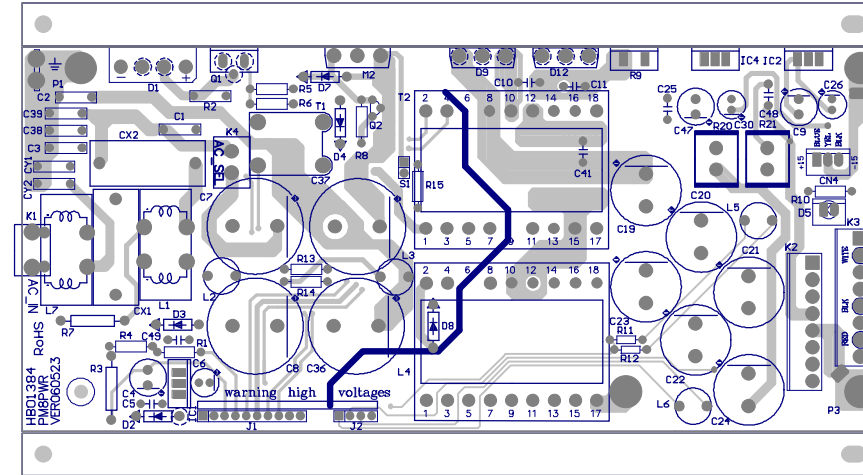
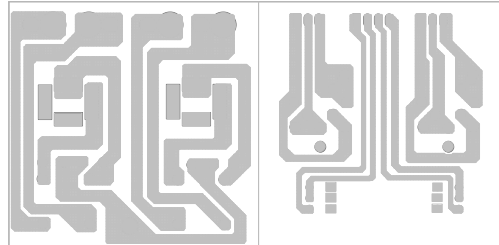
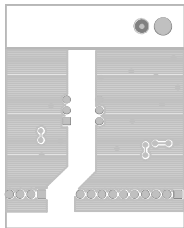

PCB:PM8CTL
BOTTOM LAYER
BOTTOM SOLDER

PCB:A2-IN
BOTTOM LAYER
BOTTOM SOLDER

PCB:PM8PWR TOP LAYER TOP OVERLAY TOP SOLDER

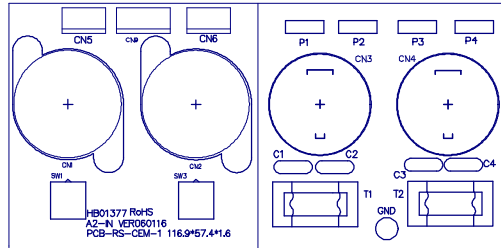
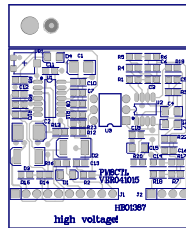

PCB:PM8CTL
TOP LAYER
TOP OVERLAY
TOP SOLDER

PCB:A2-IN
TOP OVERLAY

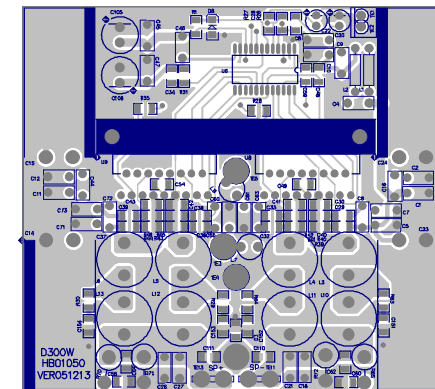
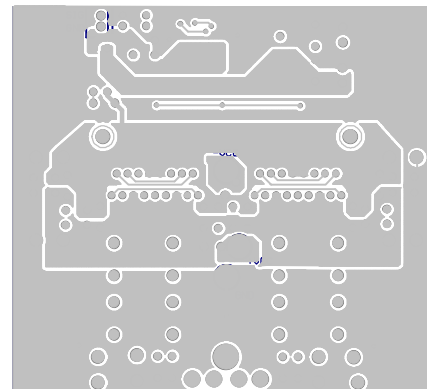

PCB:D300W
BOTTOM LAYER
BOTTOM SOLDER

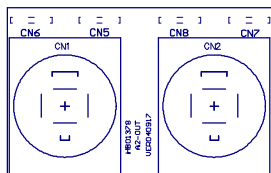

PCB:A2-OUT
TOP OVERLAY

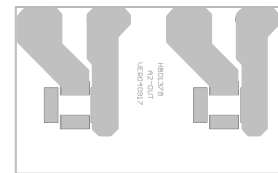

PCB:A2-OUT
BOTTOM LAYER
BOTTOM SOLDER

TOP LAYER
TOP OVERLAY
TOP SOLDER

6. Exploded View & Mechanical Parts List

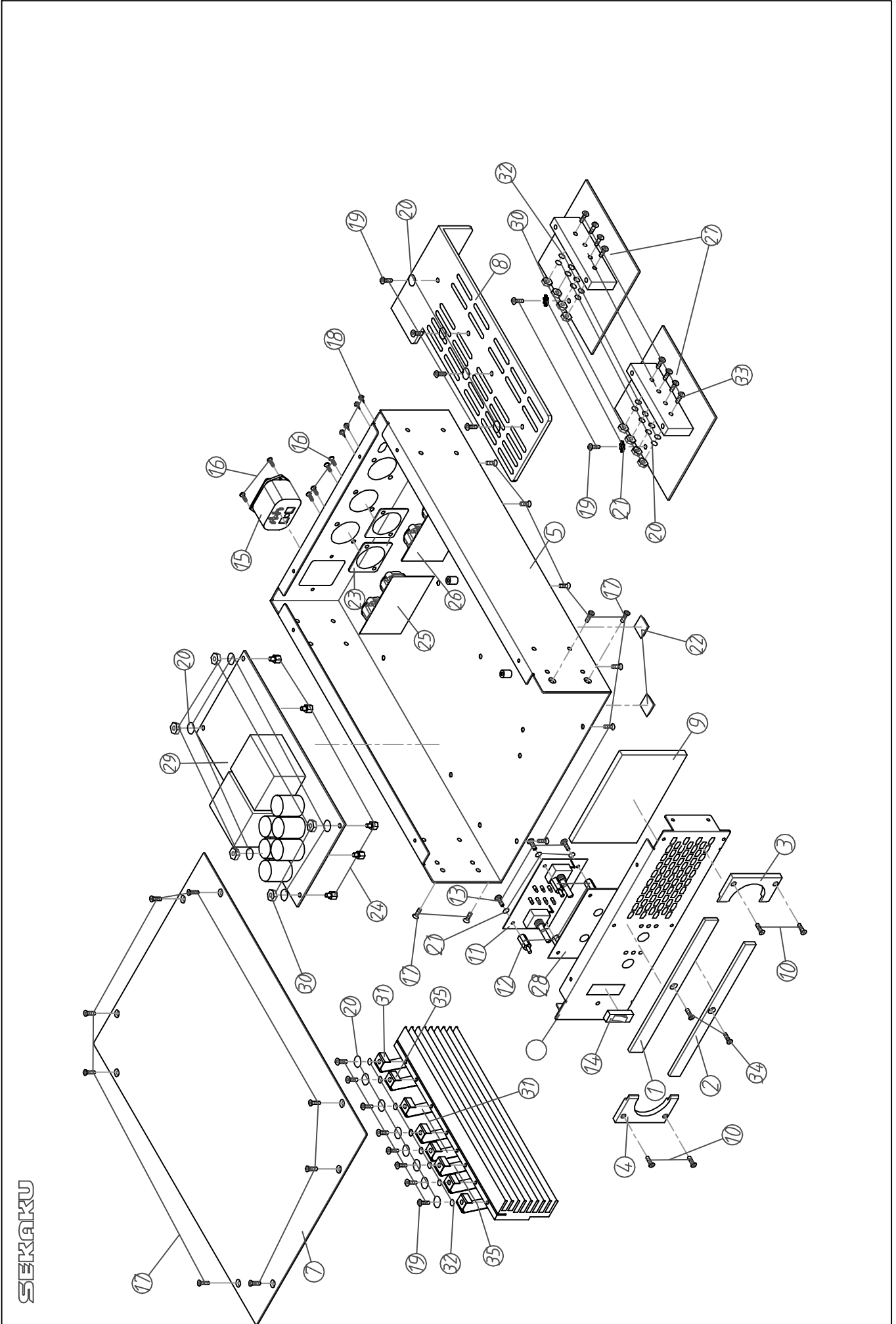

Part List

Mechanical Parts List				
No.	Item NO.	Item Description	Specification	pcs
1	MJ00476	cushion	A500.2 top_V1.0	1
2	MC00476	top cover	A500.2 bottom_V1.0	1
3	MI02593	front panel	A1000.4 right_V1.0	1
4	MI02595	front panel	A1000.4 left_V1.0	1
5	MB03849	rear chassis	208.5*64.8*308	1
6	MA00813	panel	205.5*63.6*12	1
7	MC00675	top cover	A500.2 DRAGONFLY_V1.0	1
8	MI02588	barrier	A500.2 210*90*31.8_V1.0	1
9	NI03389	net	A500.2 96*61.6*5t_V1.0	1
10	MG00578	Ni screw	M3*10*0.5PH_V1.0	4
11	HK04930	K-PC board	P-A2FP-DIP	1
12	MG00251	copper pillar	M3*17.5*0.5PH	4
13	MG00041	black plated screw-pill	M3*6	4
14	HI00031	power switch	R415KKETOF	1
15	HC00423	AC socket (FUSE socket enclosed)	6A power supply filter with EMI	1
16	MG00042	black plated screw-pan head	M3*10	6
17	MG00025	black plated screw-pan head	M3*6	26
18	MG00061	black plated screw-pill	M3*10	4
19	MG00162	Ni screw-pill	M3*8	14
20	MF00037	spring washer	3* 5*1t	25
21	MF00014	shake proof washer	3* 6.5*0.5t	6
22	NI00498	self-adhesive cushion	12.7*7*6mm(SF-005)	4
23	MJ00942	fixed bracket	CS12/600	2
24	MG00247	copper pillar	M3*10*0.5PH	5
25	HK04933	K-PC board	P-A2OUT	1
26	HK04929	K-PC board	P-A2IN	1
27	HK04669	K-PC board	P-D300W-DIP(A500.2)	2
28	HK04932	K-PC board	P-A2LED	1
29	HK04928	K-PC board	P-PM8PWR-DIP(A500.2)	1
30	ME00015	nut	3mm	13
31	MK00081	spring piece-black plated	0.4*12*13*28.5mm	4
32	MF00030	Ni washer	3* 8*0.8t	16
33	MG00163	Ni screw	M3*8	8
34	MG00281	Ni screw	M3*6	2
35	MK00080	stator-black plated	0.4*10*12*35mm	4

7. Electrical Parts List

No.	Part No.	Description	Specification	Remark
1	SA00052	L.E.D	φ3 round(green)long foot 26	
2	NI00498	self-adhere foot cushion	12.7*7*6mm(SF-005)	
3	NI00360	knob	φ15*15mm	
4	NI00262	sleeve	φ5*25mm	
5	NI00258	sleeve	φ5*1000mm	
6	NI00218	cable tie	ALT-102SB	
7	NI00222	sleeve	φ1.5*30mm	
8	NI00221	sleeve	1.5φ*1000mm	
9	NF02069	instruction	A500.2 ALTO_V1.4	
10	NH00149	paper	889*640mm	
11	NI03389	net	A500.2 96*61.6*5t_V1.0	
12	NI01863	key-RS	φ5.5*W10*7.5	
13	NI01862	key	5.5*5.5*14.5_V1.1	
14	NE11347	label	ALTO PI	
15	NH00334	cone paper	0.040*1m	
16	NF00061	assurance card	ALTO	
17	NB03378	carton	A500.2 ALTO_V1.0	
18	NB03372	cushion	A500.2_V1.0	
19	NB03381	gift carton	A500.2 ALTO_V1.0	
20	ND00148	silicone sleeve	φ12*90mm	
21	ND00026	silicone sleeve	100*20	
22	ND00150	silicone sleeve	φ12*150mm	
23	ND00026	silicone sleeve	100*20	
24	MI02593	front board	A1000.4 right_V1.0	
25	MI02594	front board	A1000.4 right_V1.0	
26	MI02959	front board	6*40*1M(1M/0.59kg) A500.2_V1.0	
27	MI02588	barrier	A500.2 210*90*31.8_V1.4	
28	MJ00057	AL plate-RS	3.0t*2000*1000mm 16.32kg	
29	MI02603	front board	A500.2 DRAGONFLY left ALTO_V1.0	
30	MI02595	front board	A1000.4 left	
31	MI02596	front board	A1000.4 left_V1.0	
32	MI02959	front board	6*40*1M(1M/0.59kg) A500.2_V1.0	
33	NA00279	clip-chain bag	0.04t*100*150mm_V1.0	
34	NA00123	PE bag	0.04t*580*300mm	
35	NA00137	clip-chain bag	5*7	
36	MJ00476	cushion	A500.2 up_V1.1	
37	MJ00477	cushion	A500.2 up_V1.2	
38	MJ00057	AL plate-RS	3.0t*2000*1000mm 16.32kg	
39	MJ00478	cushion	A500.2 down_V1.1	
40	MJ00479	cushion	A500.2 down_V1.2	
41	MJ00057	AL plate-RS	3.0t*2000*1000mm 16.32kg	
42	MG00025	screw	M3*6	

No.	Part No.	Description	Specification	Remark
43	MG00027	screw	M3*12	
44	MG00281	screw	M3*6	
45	MG00041	screw	M3*6	
46	MG00031	screw	M4*12	
47	MG00061	screw	M3*10	
48	MG00161	screw	M3*6	
49	NE02717	label	MADE IN CHINA	
50	NH00038	paper	0.115*1M	
51	NI00028	membrane	0.110*1M	
52	MG00162	screw	M3*8	
53	MF00037	washer	φ3.2*φ5.5*1t	
54	MF00038	washer	φ4*φ7*1t	
55	MF00048	washer	φ4*φ8*0.5t	
56	ME00016	color nut	4m/m	
57	MD00608	protective cover	32*32mm	
58	MF00014	washer	φ3*φ6.5*0.5t	
59	MC00675	top cover	A500.2 DRAGONFLY_V1.3	
60	MC00671	top cover	A500.2	
61	MC00670	top cover	1.2t*208.5*308*1.2 A500.2_V1.5	
62	MJ00059	single light board	1.2*2135*1220 24.54kg	
63	AE00055	solvent	solvent	
64	AE00060	paint	4534	
65	MB03849	chassis	A500.2 DRAGONFLY_V1.6	
66	MB03843	chassis	A500.2	
67	MB03844	chassis	1.2t*208.5*64.8*308 A500.2_V1.5	
68	MJ00059	single light board	1.2*2135*1220 24.54kg	
69	ME00038	iron pillar	6.35*M3*8.4_V1.3	
70	ME00001	screw pillar	M4*10*0.7PH	
71	AE00055	solvent	solvent	
72	AE00060	paint	4534	
73	MH02000	magnet	VDGUF-90B	
74	MG00578	screw	M3*10*0.5PH_V1.0	
75	MG00251	copper pillar	M3*17.5*0.5PHsingle,length23.5	
76	MG00243	copper pillar	M3*5*0.5PH	
77	MA00813	panel	A500.2 DRAGONFLY_V1.1	
78	MA00757	panel	A500.2	
79	MA00760	panel	1.0t*205.5*63.6*12 A500.2_V1.6	
80	MJ00058	single light board	1*2135*1220 20.45kg	
81	ME00184	iron pillar	A200.2 M3*11.2*0.5PH*φ5.8_V1.0	
82	AE00055	solvent	solvent	
83	AE00067	paint	2514	
84	HK04932	PC board	P-A2LED	

No.	Part No.	Description	Specification	Remark
85	HB01376	PCB	A2-LED(3*3)_VER040917	
86	RA00168	fixed resistor 1/4W	30Ω M type	R22,R23
87	RA00181	fixed resistor 1/4W	82Ω M type	R21,R24
88	RA00191	fixed resistor 1/4W	180Ω M type	R19,R20
89	RA00196	fixed resistor 1/4W	270Ω M type	R15,R17
90	SA00052	L.E.D	φ3 round(green)long foot 26	LED5,LED6
91	SA00053	L.E.D	φ3 round(red)long foot 26mm	LED2,LED4
92	SA00054	L.E.D	3m/m round(yellow)long foot 26	LED1,LED3
93	HC00067	connector(male)	4P 2.5mm 90°	CN8
94	HC00069	connector(male)	5P 2.5mm 90°	CN7
95	NI01781	LED spacer support	LEDS-8 8mm	VR12
96	AC00179	tin without lead	M705E Sn 3Ag-0.5Cu	VR13
97	HK04930	PC board	P-A2FP-DIP	VR10
98	CB00143	electrolytic capacitor	10uF/63V φ5*11mm	C21,C22
99	CB00029	electrolytic capacitor	22uF/35V φ5*11mm	C1,C2,C3,C4
100	CB00039	electrolytic capacitor	47uF/25V φ5*11mm	C9,C10
101	HC00076	connector(male)	2P 2.5mm 180°	CN4,CN5
102	HC00077	connector(male)	3P 2.5mm 180°	CN1,CN2,CN6
103	HC00079	connector(male)	5P 2.5mm 180°	CN3
104	RC00209	potentiometer	A10KΩ RV110-40E1-225A-A14	VR1,VR2
105	AC00179	tin without lead	M705E Sn 3Ag-0.5Cu	
106	HK02231	Photodiode	P-photosensitive resistance+φ5LLED	U2,U4
107	RH00020	photosensitive resistance	VT90N1	
108	SA00201	L.E.D	φ5 red(LI3330/A)	R223
109	NI02779	sleeve	φ9*30mm	
110	NI00274	sleeve	φ9*1000mm	R203,R204,R218,R220,R222
111	HK04931	PC board	P-A2FP-SMD	R217
112	HB01379	PCB	A2-FP(3*3)_VER050512	R216
113	RD00101	SMD fixed resistor 1/10W	10KΩ ±5% 0603	R3,R4,R5,R6,R8,R9,R11,R12,R13,R14,R25,R27,R28,R30
114	RD00103	SMD fixed resistor 1/10W	15KΩ ±5% 0603	R1,R2,R7,R10
115	RD00115	SMD fixed resistor 1/10W	82KΩ ±5% 0603	R26,R29
116	CI00056	SMD ceramic capacitor 0603	56PF/50V NPO ±5%	C11,C12,C13,C14
117	CI00059	SMD ceramic capacitor 0603	100PF/50V NPO ±5%	C5,C6,C7,C8,C23,C24,C25,C26
118	CI00071	SMD ceramic capacitor 0603	0.01uF/50V X7R ±10%	C27
119	CI00075	SMD ceramic capacitor 0603	0.1uF/50V Y5V +80,-20%	C15,C16,C17,C18,C19,C20
120	SG00122	SMD integrated circuit	NJM4580M-TE3	U1,U3,U5
121	AE00449	solder material without lead	9308/Sn Ag Cu	R154,R155
122	HI00289	thermal switch	NO55 U-A	
123	HJ00006	dessicant	30g	
124	HE00043	fan	DC12V/0.12A 40*40*15mm 330mm JST2P	R49,R50,R57,R58
125	HI00031	power switch-RS	R415KKETOF	R136,R137

No.	Part No.	Description	Specification	Remark
126	HC00423	FUSE holder	4A (EMI-power filter)	R134,R135
127	HD00018	glass tube fuse	6.3A 250V ϕ 5.2*20mm CCEE/CSA/S/UL/VDE	R19,R20,R21,R22,R61,R62,R63,R64,R65,R66,R67,R68,R69,R70
128	HA01394	row-wire connector wiring	3P-3P 120	
129	HA01388	row-wire connector wiring	2P 100	
130	HA00861	power cord Europe 3P	LT-312+LT-501	R25,R26,R33,R34,R35,R36,R37,R38,R39,R40,R41,R42,R205,R206,R207,R209
131	HA00370	wire	80mm black L5R5	R79,R80
132	HA03501	single terminal wiring	300mm UL1015 18AWG red	R77,R78
133	HA03503	wire	2P-2P 300mm UL1185 26AWG	R152,R153
134	HA03495	wire	4P-4P 500mm UL1007 28AWG	R131
135	HA03497	wire	5P-5P 50mm UL1007 28AWG	R1,R2,R3,R4,R5,R6,R7,R8,R9,R10
136	HA03724	wire	90mm UL1015 18AWG	R23,R24,R27,R28
137	HA03505	wire	2P-2P 400mm UL1185 26AWG	R213
138	HA03498	wire	8P 280mm UL1007 18AWG	R129,R130
139	HA02911	wire	3P-3P 200mm UL2547 28AWG brown	C36,C37,C38,C39,C40,C41
140	HA02522	wire	2P 120mm UL1007 28AWG red black	C69,C70
141	HA02763	wire	8P 200mm UL1007 18AWG	C76,C77
142	AD00012	twin adhesive	90*120mm_V1.0	C1,C2,C3,C4
143	HA04008	connecter 2.5	3P-3P 500mm UL2547 28AWG blue	C32,C33,C34,C35
144	MH02001	magnet	VDT17.5X9.5X12.7	C48,C49,C50,C63
145	HA03506	wire	3P-3P 500mm UL2547 28AWG	C6,C7,C11,C46
146	NI03787	mount	TH-2	
147	NE13784	label	A500.2_V1.0	C24,C25,C26,C27,C28,C29,C30,C31
148	NI00014	membrane	0.035*1M	
149	NH00012	bond paper	0.04*1M	
150	HK04669	PC board	P-D300W-DIP(A500.2)	IC7,IC8,IC15
151	CB00021	electrolytic capacitor	10uF/16V ϕ 4*5mm	C20,C22
152	CB00162	electrolytic capacitor	100uF/35V 105°C TL ϕ 8*11mm	C105,C106
153	CB00164	electrolytic capacitor	2200uF/35V 105°C TL ϕ 16*32mm	C14,C15,C23,C24
154	CF00042	metal-film capacitor MSC	0.47uF/63V 5% CASE02	C18,C21,C26,C27
155	CN00045	fixed inductance	TWLC-220K	L3,L4,L5,L6,L10,L11,L12,L13
156	CN00069	inductance-EMI SUPPRESSOR	TB36-13-850485	L1,L2
157	HC00324	connect terminal	6.5m/m (PC250)	TE11,TE13
158	ME00015	color nut	3m/m	
159	MF00132	MIC jack	ϕ 3* ϕ 8*0.8t_v1.0	
160	MF00030	washer	ϕ 3.5* ϕ 8*0.8t_V1.0	
161	MJ00067	single light board	0.8t*2135*1220mm 18.69kg	J9,J10,J11,J12,J19,J20,J21,J22,J33,J34,J35,J36,J52,J53,J78,J80,J81,J84,J85,J86,J87,J88,J89,J90,J91,J92,J93,J94,J96,J97,J98,J99,J100,J101,J102,J103
162	MF00037	washer	ϕ 3.2* ϕ 5.5*1t	
163	MG00357	screw	M3*18	
164	MG00461	copper pillar	M3*7.3*0.5PH	
165	MI01836	heat-sink	65*24*8 PM-12	C29,C31

No.	Part No.	Description	Specification	Remark
166	SD00257	integrated circuit	ADU27_V1.1	U8,U9
167	SD00148	integrated circuit	TDA8927J/N1	CN1,CN3
168	NI02597	knob	3M#1350Y 10mm*66M	CN4
169	NC00027	mica	ADP 69*19*0.1t_V1.1	CN2
170	AC00179	tin without lead	M705E Sn 3Ag-0.5Cu	L1,L2
171	HK00494	PC board	P-D300W-SMD	X3
172	CI00141	SMD ceramic capacitor 1206	0.0027uF/50V X7R ±10%	C151,C152,C153,C154
173	CI00042	SMD ceramic capacitor 1206	0.001uF/50V NPO	C59,C62,C64,C110,C111
174	CI00045	SMD ceramic capacitor 1206	0.022uF/50V X7R ±5%	C40,C41,C42,C43
175	CI00134	SMD ceramic capacitor 1206	0.01uF/50V NPO ±5%	C3
176	CI00136	SMD ceramic capacitor 1206	560PF/50V NPO ±5%	C28,C29,C30,C32,C33,C36,C37,C38,C39
177	CI00138	SMD ceramic capacitor 1206	0.22uF/50V X7R ±10%	C34,C48,C49,C54
178	HB01050	PCB	D300W(1*4)_VER051213	
179	RD00132	SMD fixed resistor 1/4W	47Ω ±5% 1206	R65,R66,R68,R70
180	RD00133	SMD fixed resistor 1/4W	100Ω ±5% 1206	R29,R30,R63,R64
181	RD00245	SMD precise resistor 1/4W	1.00KΩ ±1% 1206	R28,R35
182	RD00249	SMD precise resistor 1/4W	5.60KΩ ±1% 1206	R26,R27
183	RD00417	SMD precise resistor 1/4W	27.0KΩ ±1% 1206	R31
184	RD00429	SMD precise resistor 1/4W	5.60Ω ±1% 1206	R39,R40,R41,R42,R43,R44,R45,R46
185	RD00433	SMD precise resistor 1/4W	56.0KΩ ±1% 1206	R1
186	SE00017	SMD zener diode	1/2W 5.6V(RLZ5.6B) LL-34	D8
187	SG00293	integrated circuit	ADU29_V1.1	U6
188	SG00150	SMD integrated circuit	TDA8929T	
189	CI00154	SMD ceramic capacitor 1206	0.1uF/100V X7R ±10%	C50,C56
190	AE00449	solder material without lead	9308/Sn Ag Cu	D2,D5
191	CN00149	inductance	WB0610-3.0T	L7,L8
192	HC00076	connector(male)	2P 2.5mm 180°	TE1
193	CF00031	metal-film capacitor	0.1uF/100V	C4,C6,C9,C16,C44,C46,C55,C63,C72,C5,C7,C60,C61,C71,C73,C8,C10,C45,C47,C1,C2,C11,C12
194	RA00007	metal-oxide-film resistor 1W	22Ω	R65,R70
195	RA00060	metal-oxide-film resistor 3W	390Ω RSS P type	R71,R72
196	HK04933	PC board	A SERIES CONNECT(500.2)	
197	HB01378	PCB	A SERIES CONNECT PCB VER060112	J4
198	AC00179	tin without lead	M705E Sn 3Ag-0.5Cu	
199	RA00111	fixed resistor 1/2W	51Ω M type	L1
200	HC00076	connector(male)	2P 2.5mm 180°	CN3,CN4,CN5
201	HC00077	connector(male)	3P 2.5mm 180°	CN1,CN2
202	CB00064	electrolytic capacitor	470uF/16V φ10*12mm	C1
203	HK04929	PC board	P-A2IN	
204	HB01377	PCB	A2-IN VER060116	CN2
205	HC00077	connector(male)	3P 2.5mm 180°	CN5,CN6
206	HC00078	connector(male)	4P 2.5mm 180°	CN9

No.	Part No.	Description	Specification	Remark
207	HI00162	push-button switch	2 paragraphs 6p PS-22E8552L	SW1,SW3
208	AC00179	tin without lead	M705E Sn 3Ag-0.5Cu	
209	HC00582	balance MIC jack	NCJ6FI-V (NEUTRIK)	CN1,CN2
210	HA02189	single terminal wiring	100mm	GND
211	CA00034	ceramic capacitor	470PF Y5E	C1,C2,C3,C4
212	CN00158	common mode inductance	L-560uH/4A(ADP502)	T1,T2
213	HA02779	single terminal wiring	270mm UL1015 18AWG black	P4
214	HA02344	single terminal wiring	250mm UL1015 18AWG	P3
215	HA03500	single terminal wiring	350mm UL1015 18AWG white	P2
216	HA03499	single terminal wiring	350mm UL1015 18AWG black	P1
217	HC00442	speaker socket	NL4MP (NEUTRIK)	CN3,CN4
218	MJ00942	fixed bracket	CS12/600	CN3,CN4
219	MJ00061	iron board	1*2135*1220 20.45kg	R1,R10,R11,R12,R2,R3,R4,R5,R6,R7,R8,R9
220	HK04928	PC board	P-PM8PWR-DIP(A500.2)	R31,R32,R33,R34
221	CB00130	electrolytic capacitor	100uF/25V 105 SH ϕ 6*11mm	C26,C30,C6
222	CB00131	electrolytic capacitor	180uF/25V 105 WL ϕ 8*11mm	C9,C47
223	CB00132	electrolytic capacitor	330uF/25V 105 LZ ϕ 8*15mm	C4
224	CB00133	electrolytic capacitor	470uF/200V 85 LP ϕ 22*40mm	C36,C37,C7,C8
225	CB00164	electrolytic capacitor	2200uF/35V 105°C TL ϕ 16*32mm	C19,C20,C21,C22,C23,C24
226	CG00056	X2 capacitor	0.47uF/275VAC	CX1
227	CG00065	X2-capacitor MPX	1.0uF/275V VDE/UL/CSA	CX2
228	CG00028	metal oxide varistors	CNR-14D391K	C1
229	CG00030	X1/Y2 capacitor	2200PF/400V Y5V \pm 20% Y2CAP	C2,C3,C38,C39,CY1,CY2
230	CG00033	metal oxide varistors	B57237-S100-M	R2
231	CN00150	common inductance	TC2208-15mH/V644	L1
232	CN00151	common inductance	TC2208-20mH/V645	L7
233	CH00027	laminated capacitor	0.1uF/100V X7R PH5mm	C25,C41,C5,C48,C49
234	CH00028	laminated capacitor	470PF/100V X7R PH5mm	C10,C11
235	CN00058	inductance	1UH/12A(CR4F-302817)	L2,L3,L5,L6
236	RA00573	precise resistor 1/4W	150K Ω M type	R13,R14
237	RA00727	precise resistor 1/8W	75.0 Ω M type	R11
238	RA00728	precise resistor 1/8W	150 Ω M type	R12
239	RA00729	precise resistor 1/4W	1.80 Ω M type	R15
240	RA00730	precise resistor 1/4W	6.80 Ω M type	R8
241	RA00731	precise resistor 1/4W	270 Ω M type	R5,R6
242	RA00733	precise resistor 1/4W	845K Ω M type	R4,R1
243	RA01440	precise resistor 1/2W	1M Ω	R7
244	RA00735	precise resistor 30W	10.0 Ω TO-126 MP930-10.0-1%	R9
245	SA00004	high speed diode	2A/100V BYV27-200,113	D2,D8
246	SA00007	bridge rectifier	8A KBU-806 comb type	D1
247	SA00093	rectifier diode	1N4148 0.5A	D4
248	SA00159	rectifier diode	1A/1000V IN4007	D3

No.	Part No.	Description	Specification	Remark
249	SA00146	zener diode	3W 16V BZT03-C16	D7
250	SA00147	diode	30A/150V IR30CPQ150	D12,D9
251	SB00056	Bidirectional S.C.R	double direct s.c.r	Q1
252	SB00109	transistor	BC640	Q2
253	SD00066	integrated circuit	L7812CV(TO-220)(ST)	IC1
254	TC00118	transformer	PE-67100	T1
255	TC00203	transformer	4022-369-7449.2	L4
256	TC00202	transformer	27-12-648	T2
257	TC00168	transformer	27-12-648	
258	HI00176	thermal switch	OP62/100 /145mm	
259	RA00701	fixed resistor 1/4W	2.2KΩ M type	R10
260	RA00870	chassis bracket 5W	12Ω SQM type	R20,R21
261	HC00076	connector(male)	2P 2.5mm 180°	D5
262	HC00175	connector(male)	4P 3.96mm 180°	
263	HC00077	connector(male)	3P 2.5mm 180°	CN4
264	MF00014	washer	φ3*φ6.5*0.5t	C59,C62,C64,C110,C111
265	SD00077	integrated circuit-RS	L7815CV(TO-220)(ST)(MOROCCO)	IC4
266	SD00079	integrated circuit	L7915CV(TO-220)(ST)	IC2
267	MI02598	heat-sink	A1000.4 21*50*190 0.3kg_V1.3	C28,C29,C30,C32,C33,C36,C37,C38,C39
268	MI03119	heat-sink	21*50*1M+5(1M/1.6KG)_V1.0	C34,C48,C49,C54
269	MK00080	battery cover	0.4*10*12*35mm PM8-PWR_V1.1	Q1,D9,D12,R9,IC4,IC2
270	NI01877	silicone sleeve	φ10*28mm T0.45mm	R65,R66,R68,R70
271	NI03044	silicone sleeve	φ14*35 T0.45mm	R29,R30,R63,R64
272	MG00041	screw	M3*6	
273	MF00037	washer	φ3.2*φ5.5*1t	R26,R27
274	MF00132	MIC jack	φ3*φ8*0.8t_v1.0	R31
275	MF00030	washer	φ3.5*φ8*0.8t_V1.0	R39,R40,R41,R42,R43,R44,R45,R46
276	MJ00067	single light board	0.8t*2135*1220mm 18.69kg	R1
277	MG00244	copper pillar	M3*10*0.5PH	D8
278	MG00162	screw	M3*8	
279	AC00179	tin without lead	M705E Sn 3Ag-0.5Cu	
280	HK04217	PC board	P-PM8PWR-SMD	C50,C56
281	HB01384	PCB-RS	PM8PWR_VER060523	
282	CI00095	SMD ceramic capacitor 1206	0.1uF/50V X7R	C14,C16
283	CI00118	SMD ceramic capacitor 1812	0.47uF/50V X7R	C12,C13
284	AE00449	solder material without lead	9308/Sn Ag Cu	4,C6,C9,C16,C44,C46,C55,C63,C72,C5,C7,C60,C61,C71,C73,C8,C10,C45,C47,C1,C2,C11,C12
285	CN00036	bead coil	T-3.5*1.2*5.2(22-06)	R65,R70
286	RA01009	fixed resistor 1W	130K P type	R3
287	MK00122	spring piece	1.2t*17*16*21(ML000007)_V1.1	D1,M2
288	SB00182	transistor	STW12NK90Z(TO247)/(ST)	M2
289	NC00852	mica-RS	25*40mm	

No.	Part No.	Description	Specification	Remark
290	HK04594	PC board	P-PM8CTL-DIP	
291	HC00416	connector	2.54 90° 4P	J2
292	HC00417	connector	2.54 90° 10P	J1
293	SB00111	Photodiode	CNY17-3.300(QTC)	U3
294	HK04595	PC board	P-PM8CTL-SMD	
295	HB01387	PCB	PM8CTL(2*5)_VER041015	
296	CI00012	SMD ceramic capacitor 0805	47PF/50V NPO	C5
297	CI00019	SMD ceramic capacitor 0805	470PF/50V NPO ±5%	C11,C12,C18
298	CI00026	SMD ceramic capacitor 0805	0.0033uF/50V X7R ±10%	C3
299	CI00097	SMD ceramic capacitor 0805	0.027uF/50V X7R ±10%	C10,C13,C14,C16,C6
300	CI00107	SMD ceramic capacitor 0805	270PF/50V NPO ±5%	C8
301	CI00120	SMD ceramic capacitor 1206	0.068uF/25V X7R 50V±10%	C15,C4
302	CI00124	SMD ceramic capacitor 1206	0.47uF/25V Y5V-1206(3216)	C17
303	CI00125	SMD ceramic capacitor 1210	10uF/16V Y5V-1210(3225)	C2
304	CL00003	SMD tantalum capacitor	2.2uF/16V case A	C1
305	RD00232	SMD precise resistor 1/8W	2.20KΩ ±1% 0805	R12
306	RD00239	SMD precise resistor 1/8W	24.0KΩ ±1% 0805	R13
307	RD00507	SMD precise resistor 1/8W	4.30Ω ±1% 0805	R15
308	RD00372	SMD precise resistor 1/8W	10.7Ω ±1% 0805	R16
309	RD00373	SMD precise resistor 1/8W	47.0Ω ±1% 0805	R2
310	RD00374	SMD precise resistor 1/8W	68.0Ω ±1% 0805	R1,R5
311	RD00375	SMD precise resistor 1/8W	75.0Ω ±1% 0805	R18
312	RD00376	SMD precise resistor 1/8W	150Ω ±1% 0805	R7
313	RD00377	SMD precise resistor 1/8W	180Ω ±1% 0805	R14,R17
314	RD00378	SMD precise resistor 1/8W	1.00KΩ ±1% 0805	R19,R20,R3,R4
315	RD00380	SMD precise resistor 1/8W	10.0KΩ ±1% 0805	R8,R11
316	RD00383	SMD precise resistor 1/8W	27.0KΩ ±1% 0805	R9,R10
317	RD00403	SMD precise resistor 1/8W	100KΩ ±1% 0805	R23
318	RD00434	SMD precise resistor 1/8W	19.6KΩ ±1% 0805	R22,R6
319	SE00011	SMD rectifier diode	RLS4148 0.5A (LL-34)	D1
320	SE00032	SMD diode	SS14	D2,D3
321	SE00033	SMD rectifier diode	BAS85(S0D80DC)	D4
322	SG00124	SMD integrated circuit	UC39432BD	U2
323	SG00181	SMD integrated circuit	UCC35701D(TI)	U1
324	RF00005	SMD semi-fixed resistor	20K 3314J-1-203E	VR1
325	AE00449	solder material without lead	9308/Sn Ag Cu	
326	AC00179	tin without lead	M705E Sn 3Ag-0.5Cu	
327	RA00242	fixed resistor 1/4W	10KΩ M type	R0
328	HC00324	connect terminal	6.5m/m (PC250)	P1
329	MG00042	screw	M3*10	