

Service Manual

Model: ALTO GATE

AUDIO INTERACTIVE / QUAD EXPANDER / GATE



www.altoproaudio.com

Version: 1.1

CONTENTS

- 1. Specification**
- 2. Block Diagram**
- 3. Schematic Diagram**
- 4. Printed Circuit Board**
- 5. Wiring Diagram**
- 6. Test Procedure**
- 7. Electrical Parts List**
- 8. Exploded Views & Mechanical Parts List**
- 9. Notes**

1. SPECIFICATIONS

SPECIFICATIONS FRO ALTO GATE

AUDIO INPUT

Connectors	XLR and 1/4 jack
Type	RF filtered , servo-balanced input
Max. Input Level	+21 dBu balanced and unbalanced
Impedance	50kOhm balanced , 25kOhm unbalanced
CMRR	typ. 40 dB, >55dB@1KHz

AUDIO OUTPUT

Connectors	XLR and 1/4 jack
Type	Electronically servo-balanced output stage
Max. Output Level	+21 dBu balanced and unbalanced
Impedance	60 Ohm balanced , 30 Ohm unbalanced

FUNCTION SWITCHES

Monitor	monitors the side-chain key signal
Couple	activates FlexLink function
Mode	gate/expander switch
Filter	activates the side-chain Filter

INDICATORS

Gain Reduction	8-segment LED display : 1/3/6/10/15/20/30/40 dB
" - " indicator	signal is above threshold
" Hold " indicator	signal is reaches threshold
" + " indicator	signal is below threshold
LED indicator for each function switch	

GATE SECTION

Type	UTR (Ultra Transient Response) gate
Range	variable (0 to -80 dB)
Threshold	variable (BYPASS to +10dBu)
Attack	program dependent
Hold	variable (0 to 4sec)
Release	variable (0.05 to 4 sec)

EXPANDER SECTION

Type	IRC (Interactive Ratio Control) expander
Attack	program dependent
Ratio	variable (1:1 to 1:4)

PARAMETRIC SC FILITER

Frequency	variable (100 Hz to 10KHz)
Bandwidth	variable (2.3 to 0.7 Oct.)

SYSTEM SPECIFICATIONS

Frequency Response	10Hz to 100KHz +/- 3 dB (RANGE TO - 80 dB)
Noise	>90dBu , unweighted , 22Hz to 22KHz
THD	0.02% typ. @+4dBu , 1KHz , GAIN 1
IMD	0.01% typ. SMPTE
Crosstalk	<-100 dB , 22Hz to 22KHz

POWER SUPPLY

AC 95-120 Vac~60Hz	Fuse : 400mA (slow blow)
AC 210-240 Vac~50Hz	Fuse : 200mA (slow blow)

POWER CONSUMPTION

18 Watts

DIMENSIONS

483(W) * 194.5(D) * 44(H) mm (19 * 7.7 * 1.7)

WEIGHT

3.3kg

2. Block Diagram

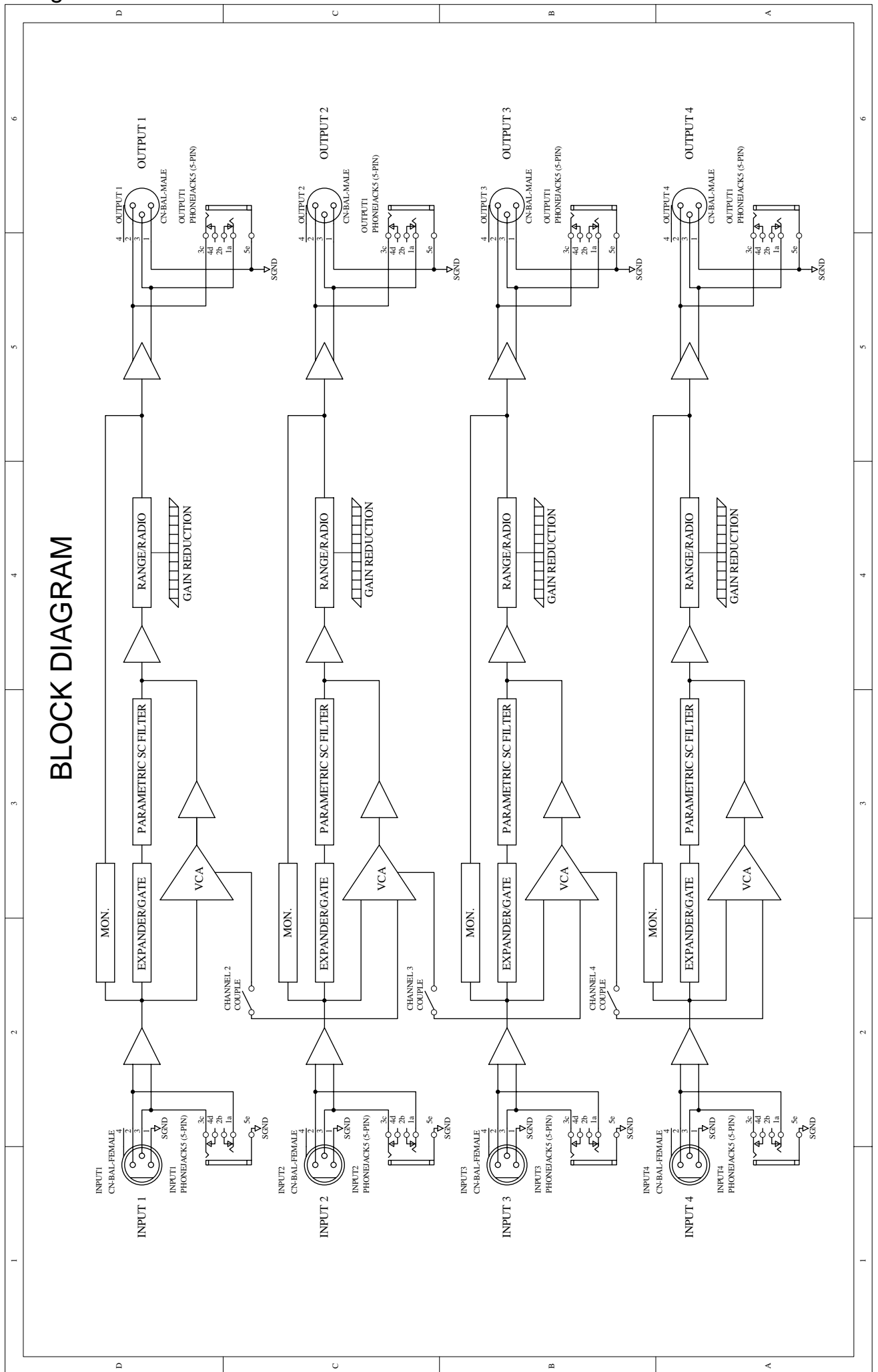

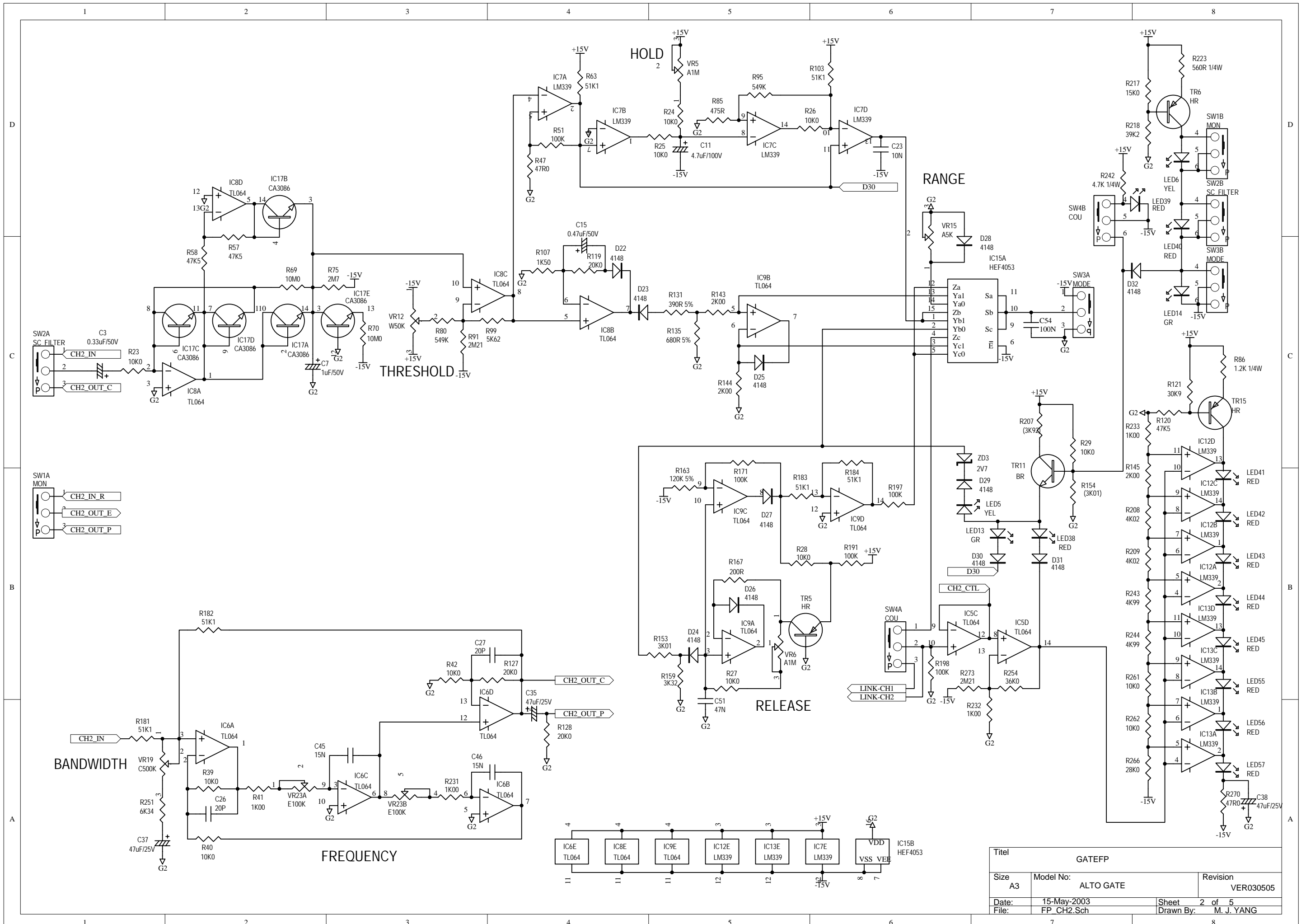

Titel			GATEFP		
Size	Model No:	ALTO GATE		Revision	VER030505
Date:	15-May-2003	Sheet	2 of 5		
File:	FP.CH2.Sch	Drawn By:	M. J. YANG		

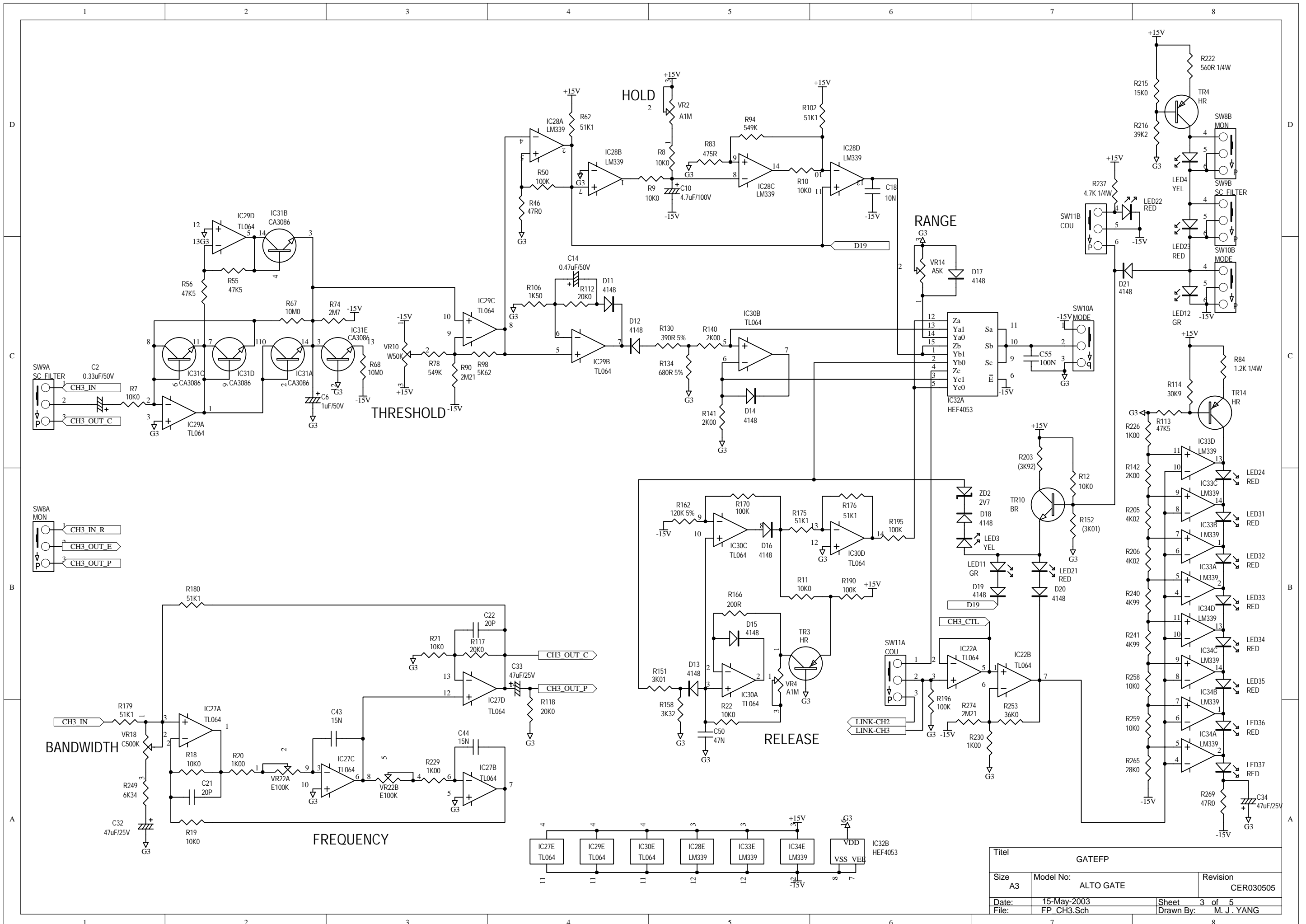

Titel			GATEFP		
Size	Model No:	Revision			
A3	ALTO GATE	CER030505			
Date:	15-May-2003	Sheet	3 of 5		
File:	FP_CH3.Sch	Drawn By:	M. J. YANG		

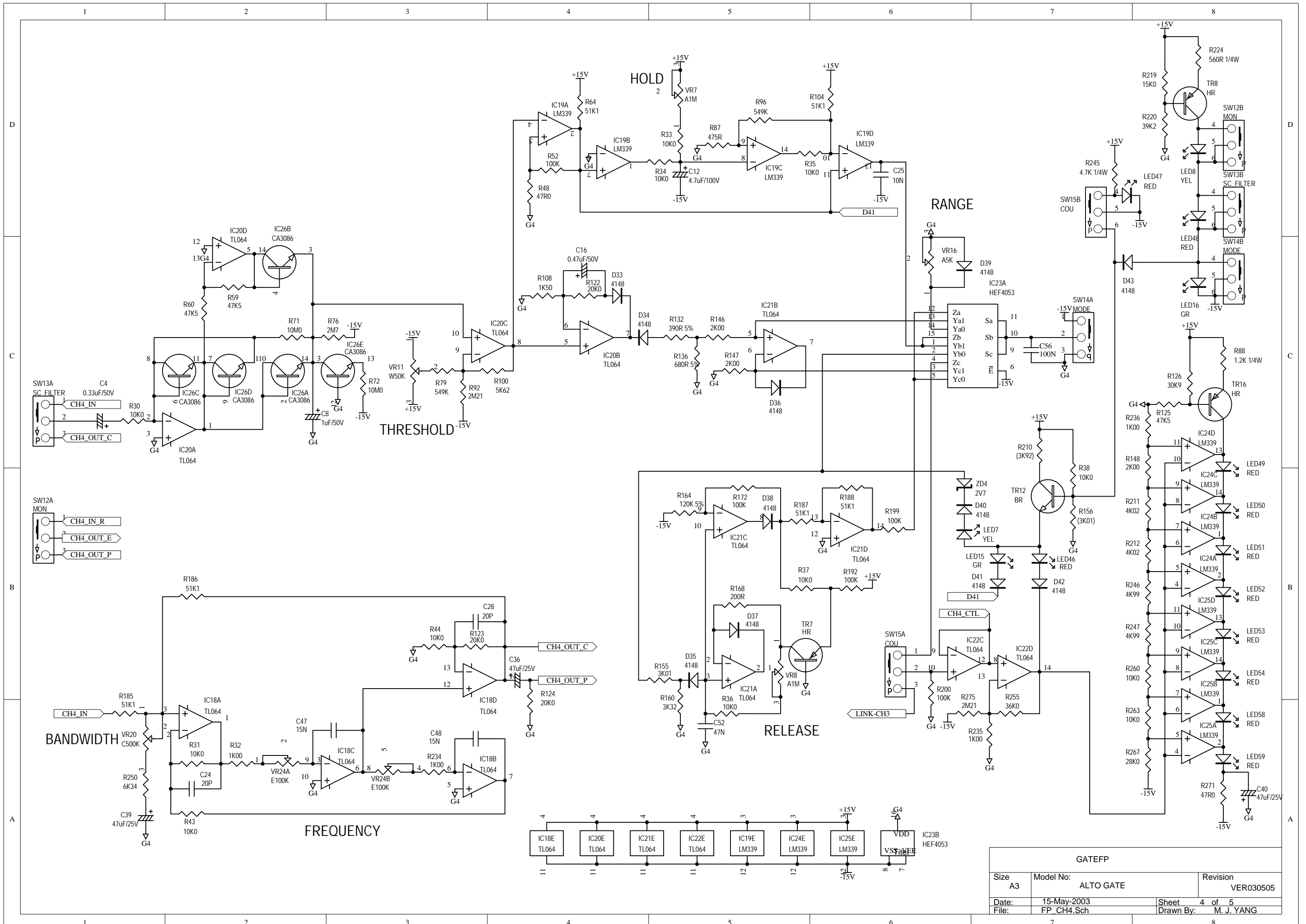

GATEFP		
Size A3	Model No: ALTO GATE	Revision VER030505
Date: 15-May-2003	Sheet 4 of 5	
File: FP.CH4.Sch	Drawn By: M. J. YANG	

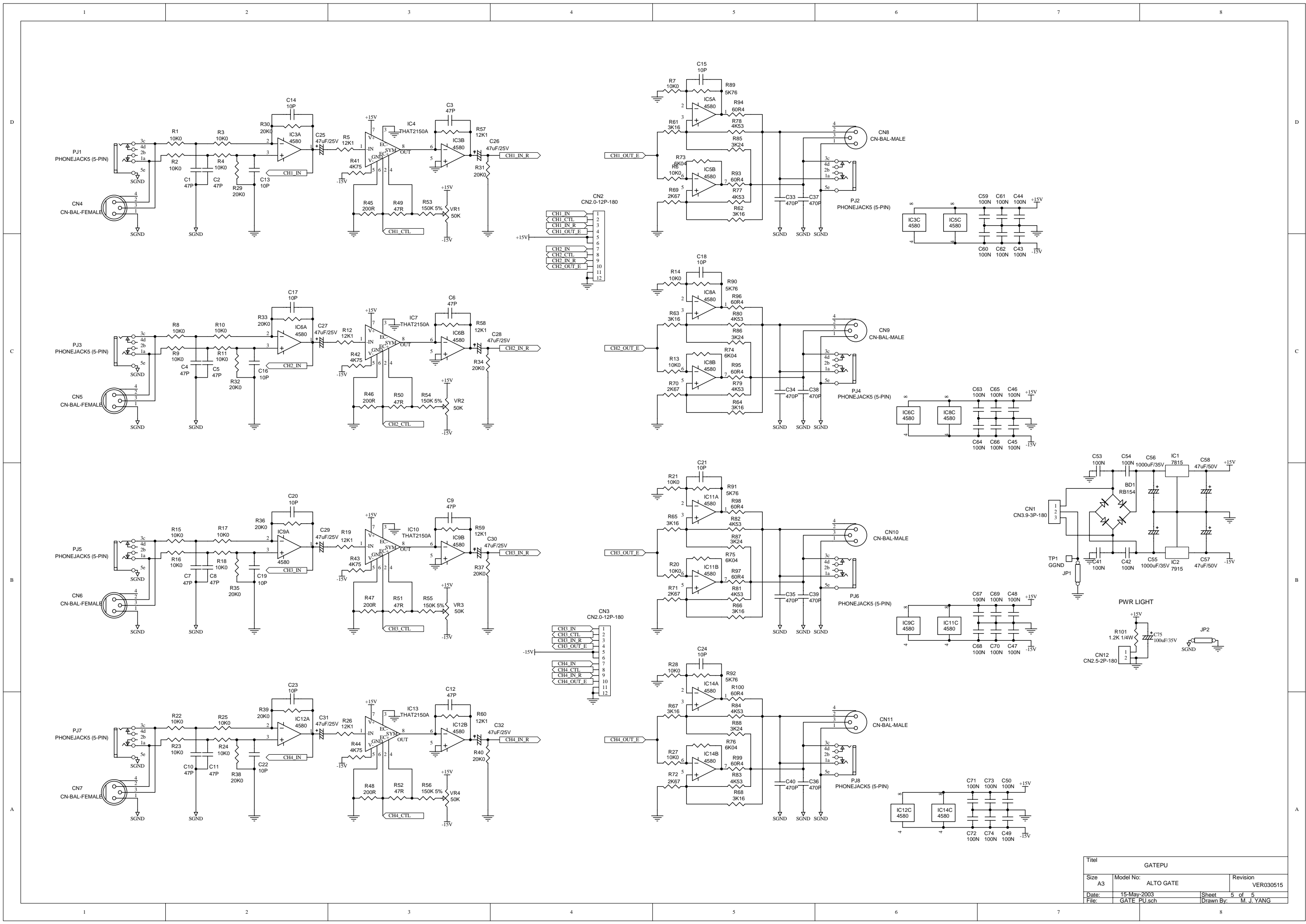

Title			GATEPU		
Size	A3	Model No:	ALTO GATE	Revision	VER030515
Date:	15-May-2003	Sheet	5 of 5		
File:	GATE_PU.sch	Drawn By:	M. J. YANG		

4. Printed Circuit Board

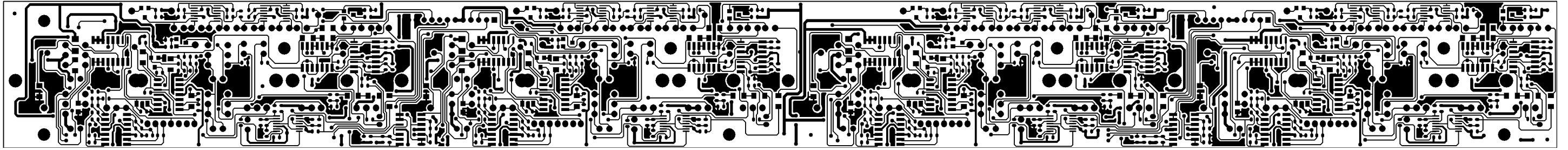

PCB : GATEFP Top Layer

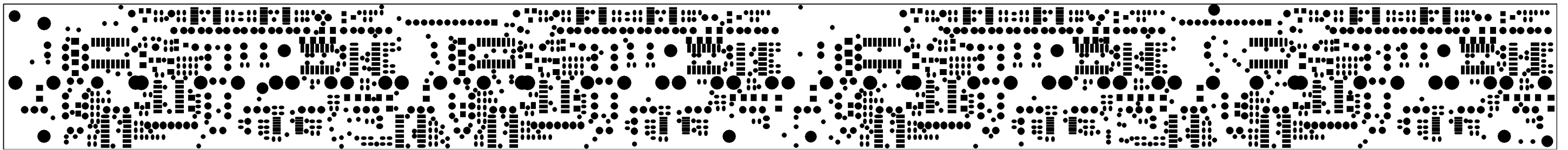

PCB : GATEFP Top Solder Mask

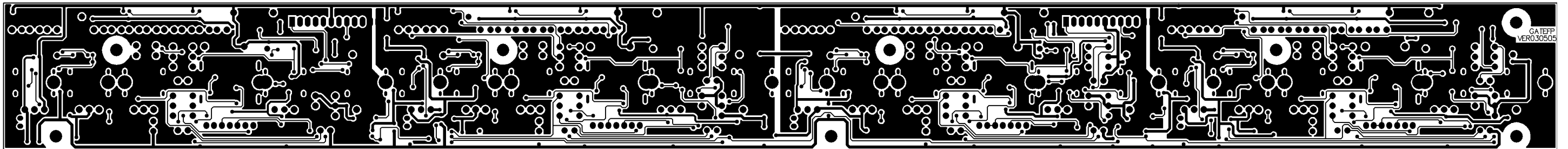

PCB : GATEFP Bottom Layer

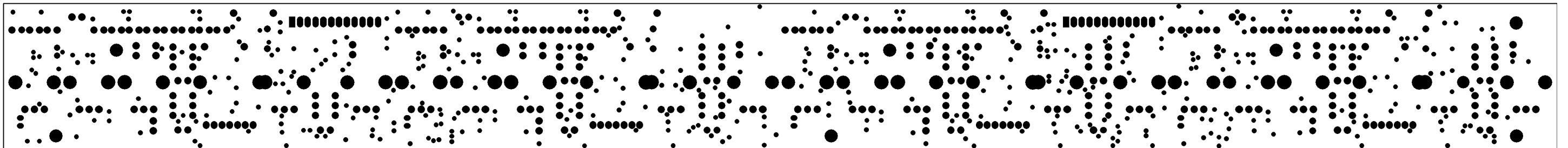

PCB : GATEFP Bottom Solder Mask

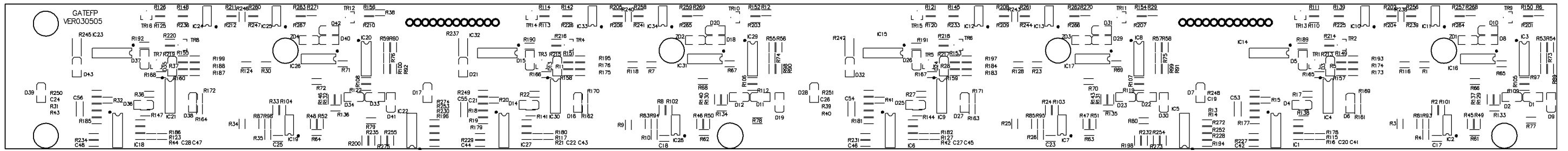

PCB: GATEFP Top Overlay

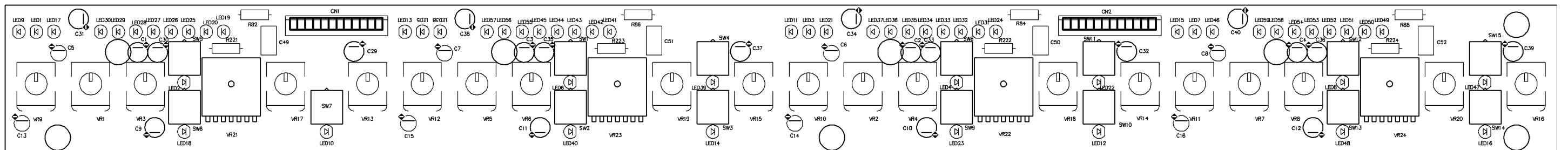

PCB : GATEFP Bottom Overlay

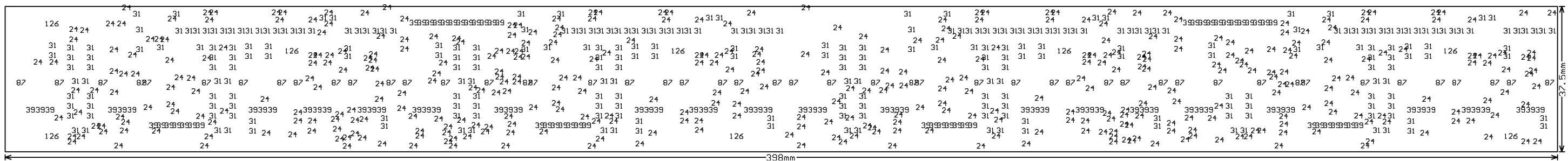

PCB : GATEFP Drill Drawing Plots

Layer Pair : TopLayer to BottomLayer

ASCII File : NCDrillOutput.TXT

EIA File : NCDrillOutput.DRL

Tool	Hole Size	Hole Count Plated	Tool Travel
T1	24mil (0.6096mm)	403	142.06 Inch (3608.43 mm)
T2	31mil (0.7874mm)	288	117.84 Inch (2993.14 mm)
T3	39mil (0.9906mm)	112	76.99 Inch (1955.50 mm)
T4	87mil (2.2098mm)	48	50.14 Inch (1273.56 mm)
T5	126mil (3.2004mm)	8	NPTH 78.39 Inch (1991.05 mm)
Totals		859	465.42 Inch (11821.68 mm)

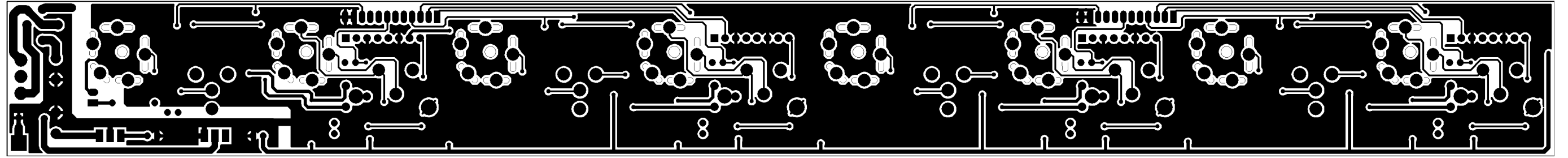

PCB : GATEPU Top Layer

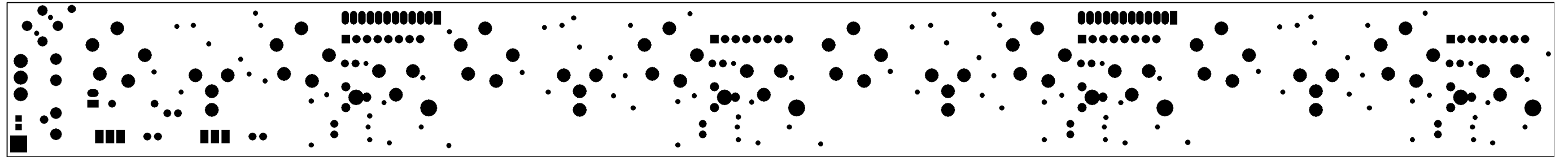

PCB : GATEPU Top Solder Mask

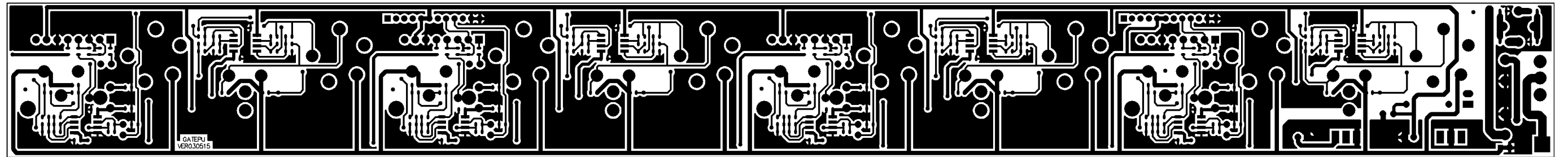

PCB : GATEPU Bottom Layer

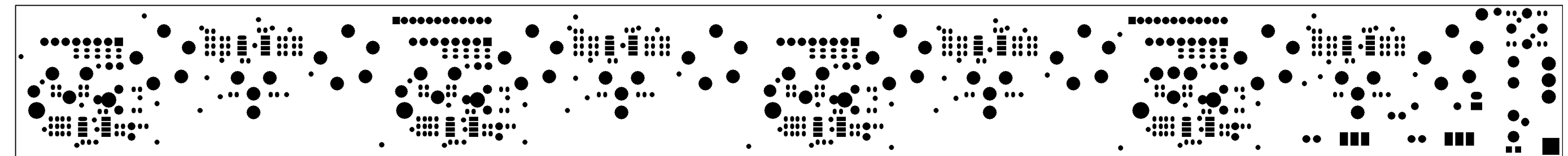

PCB : GATEPU Bottom Solder Mask

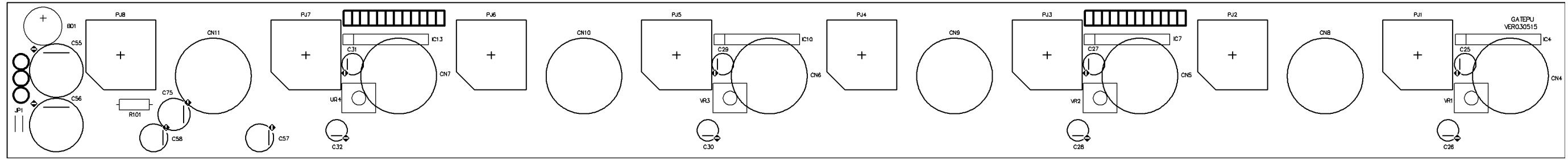

PCB: GATEPU Top Overlay

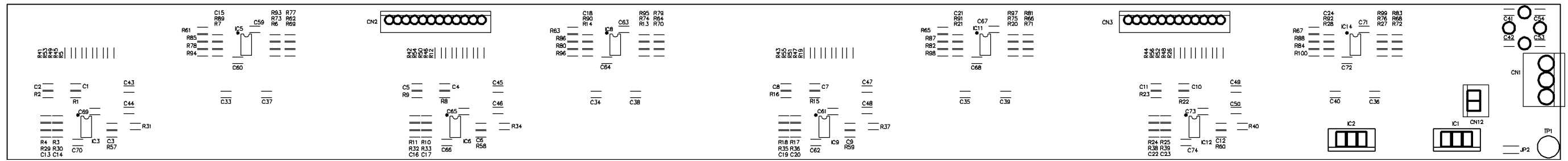

PCB : GATEPU Bottom Overlay

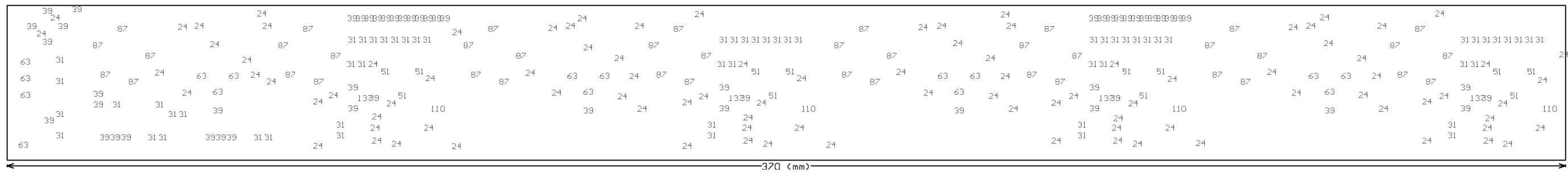

PCB : GATEPU Drill Drawing Plots

Layer Pair : TopLayer to BottomLayer
 ASCII File : NCDrillOutput.TXT
 EIA File : NCDrillOutput.DRL

Tool	Hole Size	Hole Count Plated	Tool Travel
T1	24mil (0.6096mm)	96	61.48 Inch (1561.53 mm)
T2	31mil (0.7874mm)	60	42.82 Inch (1087.64 mm)
T3	39mil (0.9906mm)	54	43.70 Inch (1110.06 mm)
T4	51mil (1.2954mm)	12	36.00 Inch (914.33 mm)
T5	63mil (1.6002mm)	16	35.99 Inch (914.06 mm)
T6	87mil (2.2098mm)	40	42.08 Inch (1068.78 mm)
T7	110mil (2.794mm)	4	33.78 Inch (857.94 mm)
T8	137mil (3.4798mm)	4	NPTH 33.32 Inch (846.30 mm)
Totals		286	329.16 Inch (8360.64 mm)

GATEFP

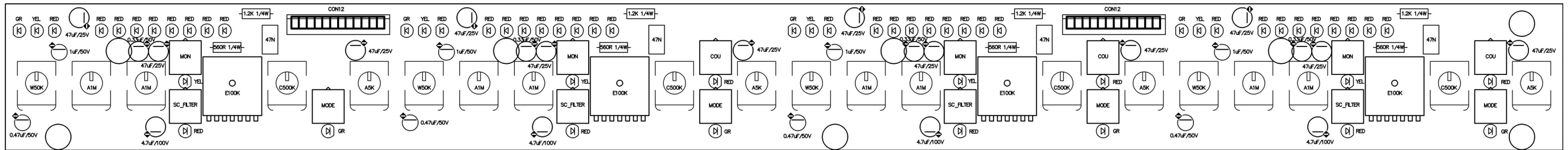
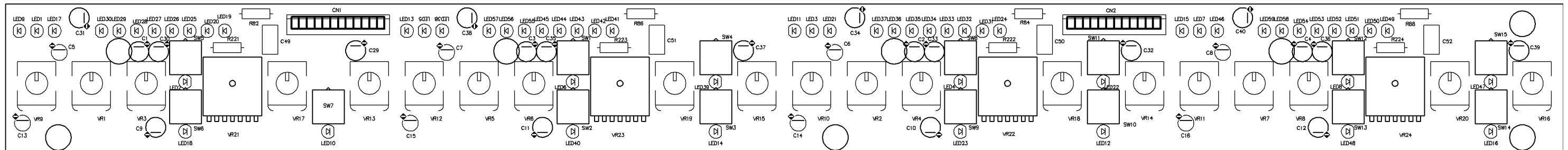
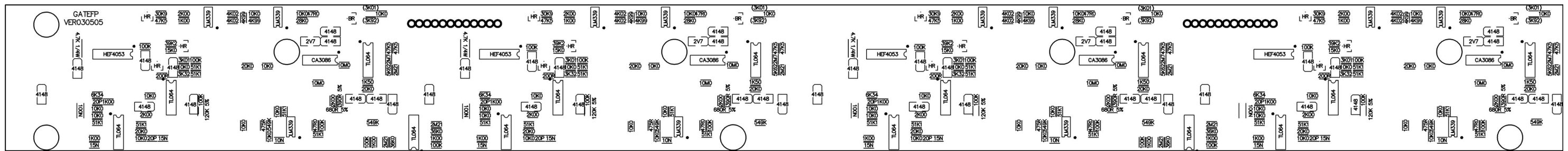
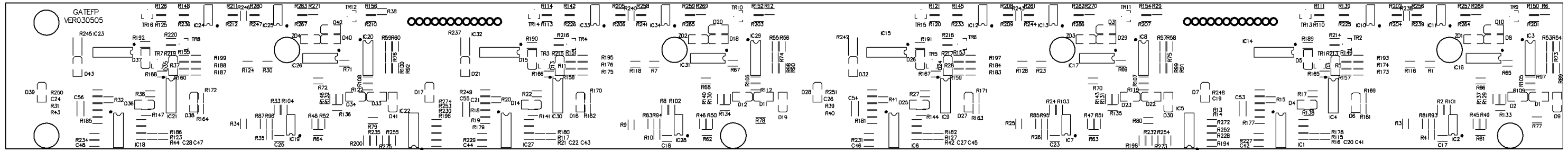

ALTO GATE Wiring Diagram

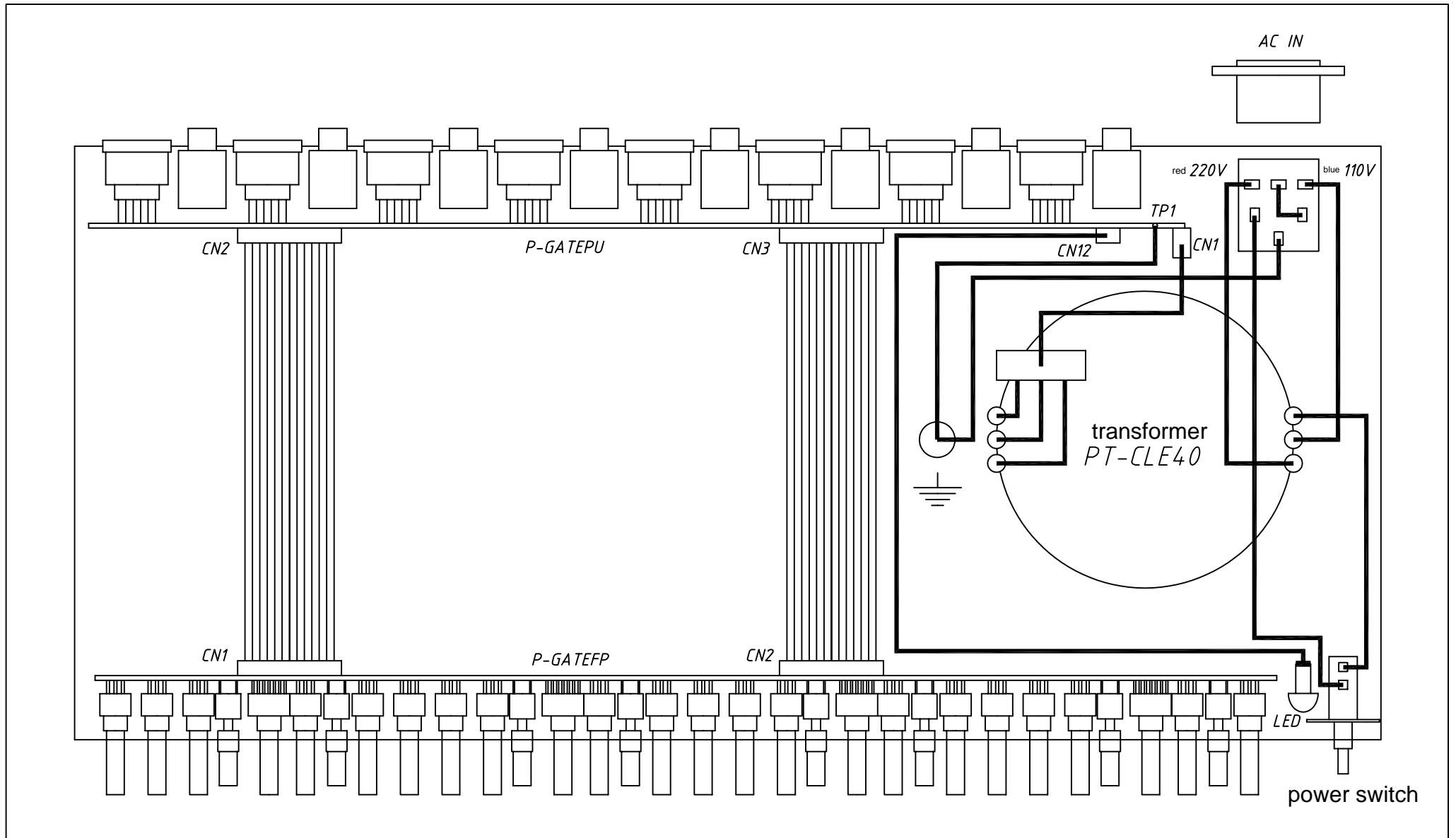

7. Electrical Parts List

SEKAKU ELECTRON INDUSTRY CO.,LTD

IEBO_P02

IEBO_P02

Multi-Level BOM Structure Listing

Report No.: IEBO_P02
Prepared by 010003[楊明仁]

Date 2003/07/31
Page No.: 1 / 12

Item No. PF00325 Version
DESCRIPTION: ALTO GATE
ALTO GATE ALTO 230V 歐規 無

UNIT: PCS
Date: 2003/05/21

Version	Item No Item Descri	Loss %	Ver.	Unit	Cardinal Usage Rate	Effective Date @:Phantom Layer Attrition Rate
-0001-----	MA03793 panel			PCS	1.0000	2003/05/21 1 N
-0001-----	ALTO GATE				0.00	%
-0001-----	MA03792 panel			PCS	1.0000	2002/11/11 1 N
-0001-----	ALTO GATE				0.00	%
-0001-----	MA03791 panel			PCS	1.0000	2003/07/22 1 Y
-0001-----	ALTO GATE				0.00	%
-0001-----	MA04251 panel			PCS	1.0000	2003/07/22 1 N
-0001-----	ALTO GATE				0.00	%
-0001-----	MI01279 panel			PCS	1.0000	2003/07/22 1 Y
-0001-----	44.2*17.5*483				0.00	%
-0002-----	MB02549 rear board			PCS	1.0000	2003/05/21 1 N
-0001-----	ALTO GATE				0.00	%
-0001-----	@MB02547 rear board			PCS	1.0000	2002/09/30 1 N
-0001-----	ALTO GATE				0.00	%
-0001-----	MB02546 rear board			PCS	1.0000	2002/09/30 1 N
-0001-----	ALTO GATE				0.00	%
-0001-----	MJ00058 iron board			PCS	1.0000	2002/09/30 95 N
-0001-----	1*2135*1220 20.45kg			KG	0.00	%
-0003-----	MI01625 front board			PCS	1.0000	2003/05/21 1 N
-0001-----	ALTO GATE				0.00	%
-0001-----	MJ00058 iron board			PCS	1.0000	2003/05/20 137 Y
-0001-----	1*2135*1220 20.45kg			KG	0.00	%
-0004-----	MB00522 bottom board			PCS	1.0000	2003/05/21 1 N
-0001-----	CLE2.0				0.00	%
-0001-----	MB00520 bottom board			PCS	1.0000	2003/01/15 1 N
-0001-----	CLE2.0				0.00	%
-0001-----	MB00521 bottom board			PCS	1.0000	2002/04/15 1 N
-0001-----	CLE2.0				0.00	%
-0001-----	MJ00059 iron board			PCS	1.0000	2002/04/15 24 N
-0001-----	1.2*2135*1220 24.54kg			KG	0.00	%
-0002-----	ME00001 screw			PCS	7.0000	2002/10/29 1 N
-0003-----	M4*10*0.7PH				0.00	%
-0001-----	MI01357 fixed board			PCS	1.0000	2002/10/29 1 N
-0001-----	CLE2.0				0.00	%
-0001-----	MJ00063 Zn-plated board			PCS	1.0000	2002/04/14 2542 N
-0001-----	1.2*2135*1220 24.54kg			KG	0.00	%
-0005-----	MC00209 top cover			PCS	1.0000	2003/05/21 1 N
-0001-----	CLE2.0				0.00	%
-0001-----	MC00207 top cover			PCS	1.0000	2003/01/20 1 N
-0001-----	CLE2.0				0.00	%
-0001-----	MC00208 top cover			PCS	1.0000	2002/04/14 1 N
-0001-----	CLE2.0				0.00	%
-0001-----	MJ00059				1.0000	2002/04/14

Multi-Level BOM Structure Listing

Report No.: IEBO_P02
 Prepared by 010003[楊明仁]

Date 2003/07/31
 Page No.: 2 / 12

Item No. PF00325 Version
 DESCRIPTION: ALTO GATE
 ALTO GATE ALTO 230V 歐規 無

UNIT: PCS
 Date: 2003/05/21

Version	Item No Item Descri	Loss %	Ver.	Unit	Cardinal Usage Rate Attrition	Effective Date @:Phantom Layer Rate
0006	TD00118 transformer PT-CLE40(include FUSE102)			PCS	1.0000 1 0.00 %	2003/05/21 N
0007	SD00077 integrated circuit 7815(TO-220) IC1			PCS	1.0000 1 0.00 %	2003/05/21 N
0008	SD00079 integrated circuit 7915(TO-220) IC2			PCS	1.0000 1 0.00 %	2003/05/21 N
0009	NI01876 LED spacer support 7.6*4.5*184			PCS	2.0000 1 0.00 %	2003/05/21 N
0010	NI01156 button φ 3*W6*18.3			PCS	15.0000 1 0.00 %	2003/05/21 N
0011	NI01178 pass light pillar φ 3.1*85			PCS	3.0000 1 0.00 %	2003/05/21 N
0012	NI00362 knob (COOL GRAY 8C/white)			PCS	24.0000 1 0.00 %	2003/05/21 N
0013	NI00896 knob cover φ 8.5*4 072C			PCS	24.0000 1 0.00 %	2003/05/21 N
0014	NI02085 power switch φ 22*9.69			PCS	1.0000 1 0.00 %	2003/05/21 N
0015	NI02408 bracket φ 15*2.7mm 白 CONTROL30			PCS	24.0000 1 0.00 %	2003/05/21 N
0016	HC00015 AC outlett (S)315-B (AC select)			PCS	1.0000 1 0.00 %	2003/05/21 N
0017	HD00023 fuse(T) 200mA 250V φ 5.2*20mm CSA/S/UL/VDE			PCS	1.0000 1 0.00 %	2003/05/21 N
0018	NI00308 key φ 15*17			PCS	1.0000 1 0.00 %	2003/05/21 N
0019	NI01159 switch cap φ 6*2.5 YELLOW C			PCS	1.0000 1 0.00 %	2003/05/21 N
0020	HI00023 alimentation SW SDDL B 1007U			PCS	1.0000 1 0.00 %	2003/05/21 N
0021	SA00065 L.E.D LG2043 green			PCS	1.0000 1 0.00 %	2003/05/21 N
0022	MG00041 screw M3*6			PCS	8.0000 1 0.00 %	2003/05/21 N
0023	MG00162 screw M3*8			PCS	2.0000 1 0.00 %	2003/05/21 N
0024	MG00025 screw M3*6			PCS	13.0000 1 0.00 %	2003/05/21 N
0025	MG00042 screw M3*10			PCS	4.0000 1 0.00 %	2003/05/21 N

Multi-Level BOM Structure Listing

Report No.: IEBO_P02
 Prepared by 010003[楊明仁]

Date 2003/07/31
 Page No.: 3 / 12

Item No. PF00325 Version
 DESCRIPTION: ALTO GATE
 ALTO GATE ALTO 230V 歐規 無

UNIT: PCS
 Date: 2003/05/21

Version	Item No Item Descri	Loss %	Ver.	Unit	Cardinal Usage Rate	Effective Date @:Phantom Layer Attrition Rate
0027	MG00061 screw M3*10			PCS	16.0000 1 0.00 %	2003/05/21 N
0028	MG00111 screw pill 4*30			PCS	1.0000 1 0.00 %	2003/05/21 N
0029	ME00015 colour nut 3m/m			PCS	2.0000 1 0.00 %	2003/05/21 N
0030	ME00016 colour nut 4m/m			PCS	2.0000 1 0.00 %	2003/05/21 N
0031	ME00060 socket nut JY-6351G-02-250			PCS	8.0000 1 0.00 %	2003/05/21 N
0032	MF00061 washer JY-6351G-02-250			PCS	8.0000 1 0.00 %	2003/05/21 N
0033	MF00019 washer φ 4* φ 12*1t			PCS	1.0000 1 0.00 %	2003/05/21 N
0034	MF00037 washer φ 3* φ 5*1t			PCS	4.0000 1 0.00 %	2003/05/21 N
0035	MF00038 washer φ 4* φ 7*1t			PCS	2.0000 1 0.00 %	2003/05/21 N
0036	MF00048 washer φ 4* φ 8*0.5t			PCS	2.0000 1 0.00 %	2003/06/17 N
0037	NI00443 rubber coil φ 20* φ 60*2tB			PCS	1.0000 1 0.00 %	2003/05/21 N
0038	HA01638 row-wire connector wiring 2P 280			PCS	1.0000 1 0.00 %	2003/05/21 N
0039	HA01798 P.V.C wiring UL1617 AWG22 250 black			PCS	1.0000 1 0.00 %	2003/05/21 N
0040	HA01835 P.V.C single wave wired UL1617 80 brown			PCS	1.0000 1 0.00 %	2003/05/21 N
0041	HA01333 single terminal wiring CF:W76 150mm UL1015 18AWG green/yellow			PCS	1.0000 1 0.00 %	2003/05/21 N
0042	HA00861 power cord Europe 3P LT-312+LT-501			PCS	1.0000 1 0.00 %	2003/05/21 N
0043	@NI00240 sleeve φ 2.5*10mm			PCS	2.0000 1 0.00 %	2003/05/21 N
0001	NI00239 sleeve φ 2.5*1000mm			M	10.0000 1000 0.00 %	2002/06/04 N
0044	@NI00252 sleeve φ 4*20mm			PCS	8.0000 1 0.00 %	2003/05/21 N
0001	NI00248 sleeve φ 4*1000mm			M	20.0000 1000 0.00 %	2002/06/04 N
0045	MJ00123 heat-sink(white) 65*18*4 SCX-P234			PCS	1.0000 1 0.00 %	2003/05/21 N
0001	MJ00120				1.0000	2002/12/23

Multi-Level BOM Structure Listing

Report No.: IEBO_P02
 Prepared by 010003[楊明仁]

Date 2003/07/31
 Page No.: 4 / 12

Item No. PF00325 Version
 DESCRIPTION: ALTO GATE
 ALTO GATE ALTO 230V 歐規 無

UNIT: PCS
 Date: 2003/05/21

Version	Item No Item Descri	Loss %	Ver.	Unit	Cardinal Usage Rate Attrition	Effective Date @:Phantom Layer Rate
└0001-----	MJ00070 AL board 4*2440*1220 32.40kg			PCS KG	1.0000 1400 0.00	2002/04/16 N %
└0046-----	NC00005 silicone insulator TO-220 square type			PCS	2.0000 1 0.00	2003/05/21 N %
└0047-----	NI02249 caushion TW-1(TO-220)			PCS	2.0000 1 0.00	2003/05/21 N %
└0048-----	NI00218 cable tie-black ALT-102SB			PCS	3.0000 1 0.00	2003/05/21 N %
└0049-----	NI00501 foot cushion 12.7*9*3t(SF-004)			PCS	4.0000 1 0.00	2003/05/21 N %
└0050-----	NA00137 clip-chain bag 5*7			PCS	1.0000 1 0.00	2003/05/21 N %
└0051-----	NA00123 PE bag 0.04t*580*300mm			PCS KG	1.0000 1 0.00	2003/05/21 N %
└0052-----	HJ00006 desiccant 30g			PCS	1.0000 1 0.00	2003/05/21 N %
└0053-----	NF01357 instruction ALTO GATE ALTO			PCS	1.0000 1 0.00	2003/05/21 N %
└0054-----	NB02488 colour box ALTO GATE ALTO			PCS	1.0000 1 0.00	2003/07/03 N %
└0055-----	NB02163 barrier X23,34,40			PCS	1.0000 1 0.00	2003/05/21 N %
└0056-----	NB02164 barrier X23,34,40			PCS	1.0000 1 0.00	2003/05/21 N %
└0057-----	NB02088 box (1H) ALTO 19"			PCS	1.0000 4 0.00	2003/05/21 N %
└0058-----	NF00061 assurance card ▲LTO			PCS	1.0000 1 0.00	2003/05/21 N %
└0059-----	NE06154 label ALTO-Q			PCS	4.0000 1 0.00	2003/05/21 N %
└0001-----	NH00012 bond paper 0.04*1M			M	1.0000 80 0.00	2003/02/10 N %
└0002-----	NI00014 membrane 0.035*1M			M	1.0000 80 0.00	2003/02/10 N %
└0060-----	NE05004 label ALTO			PCS	4.0000 1 0.00	2003/05/21 N %
└0061-----	NE02717 label MADE IN CHINA			PCS	2.0000 1 0.00	2003/05/21 N %
└0001-----	NI00067 R-25#透明龍 cellophane paper			M	1.0000 700 0.00	2003/01/30 N %
└0002-----	NI00027 membrane 0.105*1M			M	1.0000 700 0.00	2003/01/30 N %
└0062-----	HK03921				1.0000	2003/05/21

Multi-Level BOM Structure Listing

Report No.: IEBO_P02
 Prepared by 010003[楊明仁]

Date 2003/07/31
 Page No.: 5 / 12

Item No. PF00325 Version
 DESCRIPTION: ALTO GATE
 ALTO GATE ALTO 230V 歐規 無

UNIT: PCS
 Date: 2003/05/21

Version	Item No Item Descri	Loss %	Ver.	Unit	Cardinal Usage Rate	Effective Date @:Phantom Layer Attrition Rate
0001	RA00678 resistor 560Ω M type R221,R222,R223,R224			PCS	4.0000 1 0.00 %	2003/05/21 N
0002	RA00215 fixed resistor 1/4W 1.2KΩ M type R82,R84,R86,R88			PCS	4.0000 1 0.00 %	2003/05/21 N
0003	CC00034 mylar capacitor 0.047uF/50V C49,C50,C51,C52			PCS	4.0000 1 0.00 %	2003/05/21 N
0004	CB00126 capacitor 0.33uF/50V φ 5*11 C1,C2,C3,C4			PCS	4.0000 1 0.00 %	2003/05/21 N
0005	CB00004 electrotytic capacitor 0.47uF/50V φ 4*7 C13,C14,C15,C16			PCS	4.0000 1 0.00 %	2003/05/21 N
0006	CB00009 electrolytic capacitor 1uF/50V φ 4*7 C5,C6,C7,C8			PCS	4.0000 1 0.00 %	2003/05/21 N
0007	CB00016 electrotytic capacitor 4.7uF/100V C9,C10,C11,C12			PCS	4.0000 1 0.00 %	2003/05/21 N
0008	CB00039 electrotytic capacitor 47uF/25V C29,C30,C32,C33,C35,C36,C37,C39			PCS	8.0000 1 0.00 %	2003/07/04 N
0009	SA00071 L.E.D φ 3 green LVG2340/A LED9,LED10,LED11,LED12,LED13,LED14,LED15,LED16			PCS	8.0000 1 0.00 %	2003/05/21 N
0010	SA00072 L.E.D φ 3 red LI2340/A LED17,LED18,LED19,LED20,LED21,LED22,LED23,LED24,LED25, LED26,LED27,LED28,LED29,LED30,LED31,LED32,LED33,LED34, LED35,LED36,LED37,LED38,LED39,LED40,LED41,LED42,LED43, LED44,LED45,LED46,LED47,LED48,LED49,LED50,LED51,LED52, LED53,LED54,LED55,LED56,LED57,LED58,LED59			PCS	43.0000 1 0.00 %	2003/05/21 N
0011	SA00073 L.E.D φ 3 yellow LVY2340/A LED1,LED2,LED3,LED4,LED5,LED6,LED7,LED8			PCS	8.0000 1 0.00 %	2003/05/21 N
0012	NI01772 LED間隔柱 LEDS-7 7mm LED10,LED12,LED14,LED18,LED16,LED23,LED40,LED48			PCS	8.0000 1 0.00 %	2003/05/21 N

Multi-Level BOM Structure Listing

Report No.: IEBO_P02
 Prepared by 010003[楊明仁]

Date 2003/07/31
 Page No.: 7 / 12

Item No. PF00325 Version
 DESCRIPTION: ALTO GATE
 ALTO GATE ALTO 230V 歐規 無

UNIT: PCS
 Date: 2003/05/21

Version	Item No Item Descri	Loss %	Ver.	Unit	Cardinal Usage Rate	Effective Date @:Phantom Layer Attrition Rate
-0005-----	RD00282 resistor 1.00KΩ ±1% 0603 R15,R20,R32,R41,R227,R228,R229,R230,R231,R232,R234, R235			PCS	12.0000 1 0.00 %	2003/06/17 N
-0006-----	RD00201 SMDprecise resistor 1/10W 1.50KΩ ±1% 0603 R105,R106,R107,R108			PCS	4.0000 1 0.00 %	2003/05/21 N
-0007-----	RD00203 SMDprecise resistor 1/10W 2.00KΩ ±1% 0603 R137,R138,R139,R140,R141,R142,R143,R144,R145,R146, R147,R148			PCS	12.0000 1 0.00 %	2003/05/21 N
-0008-----	RD00385 resistor 3.01KΩ ±1% 0603 R149,R151,R153,R155			PCS	4.0000 1 0.00 %	2003/05/21 N
-0009-----	RD00357 resistor 3.32KΩ ±1% 0603 R157,R158,R159,R160			PCS	4.0000 1 0.00 %	2003/05/21 N
-0010-----	RD00364 resistor 4.02KΩ ±1% 0603 R202,R204,R205,R206,R208,R209,R211,R212			PCS	8.0000 1 0.00 %	2003/05/21 N
-0011-----	RD00209 SMDprecise resistor 1/10W 4.99KΩ ±1% 0603 R238,R239,R240,R241,R243,R244,R246,R247			PCS	8.0000 1 0.00 %	2003/05/21 N
-0012-----	RD00365 resistor 5.62KΩ ±1% 0603 R97,R98,R99,R100			PCS	4.0000 1 0.00 %	2003/05/21 N
-0013-----	RD00287 resistor 6.34KΩ ±1% 0603 R248,R249,R250,R251			PCS	4.0000 1 0.00 %	2003/05/21 N
-0014-----	RD00214 SMDprecise resistor 1/10W 10.0KΩ ±1% 0603 R1,R2,R3,R4,R5,R6,R7,R8,R9,R10,R11,R12,R13,R14,R16, R17,R18,R19,R21,R22,R23,R24,R25,R26,R27,R28,R29,R30, R31,R33,R34,R35,R36,R37,R38,R39,R40,R42,R43,R44,R256, R257,R258,R259,R260,R261,R262,R263			PCS	48.0000 1 0.00 %	2003/05/21 N
-0015-----	RD00218 SMDprecise resistor 1/10W 15.0KΩ ±1% 0603 R213,R215,R217,R219			PCS	4.0000 1 0.00 %	2003/05/21 N
-0016-----	RD00219 SMDprecise resistor 1/10W 20.0KΩ ±1% 0603			PCS	12.0000 1 0.00 %	2003/05/21 N

Component Remark

Multi-Level BOM Structure Listing

Report No.: IEBO_P02
 Prepared by 010003[楊明仁]

Date 2003/07/31
 Page No.: 8 / 12

Item No. PF00325 Version
 DESCRIPTION: ALTO GATE
 ALTO GATE ALTO 230V 歐規 無

UNIT: PCS
 Date: 2003/05/21

Version	Item No Item Descri	Loss %	Ver.	Unit	Cardinal Usage Rate	Effective Date @:Phantom Layer Attrition Rate
0017-----	RD00302 resistor 28.0KΩ ±1% 0603 R264,R265,R266,R267			PCS	4.0000 1 0.00 %	2003/05/21 N
0018-----	RD00421 resistor 30.9KΩ ±1% 0603 R111,R114,R121,R126			PCS	4.0000 1 0.00 %	2003/05/21 N
0019-----	RD00407 resistor 36.0KΩ ±1% 0603 R252,R253,R254,R255			PCS	4.0000 1 0.00 %	2003/05/21 N
0020-----	RD00317 resistor 39.2KΩ ±1% 0603 R214,R216,R218,R220			PCS	4.0000 1 0.00 %	2003/05/21 N
0021-----	RD00290 resistor 47.5KΩ ±1% 0603 R53,R54,R55,R56,R57,R58,R59,R60,R110,R113,R120,R125			PCS	12.0000 1 0.00 %	2003/05/21 N
0022-----	RD00371 resistor 51.1KΩ ±1% 0603 R61,R62,R63,R64,R101,R102,R103,R104,R173,R174,R175, R176,R177,R178,R179,R180,R181,R182,R183,R184,R185, R186,R187,R188			PCS	24.0000 1 0.00 %	2003/05/21 N
0023-----	RD00224 SMDprecise resistor 1/10W 100KΩ ±1% 0603 R49,R50,R51,R52,R169,R170,R171,R172,R189,R190,R191, R192,R193,R194,R195,R196,R198,R199,R200,R197			PCS	20.0000 1 0.00 %	2003/05/21 N
0024-----	RD00389 resistor 549KΩ ±1% 0603 R77,R78,R79,R80,R93,R94,R95,R96			PCS	8.0000 1 0.00 %	2003/05/21 N
0025-----	RD00387 resistor 2.21MΩ ±1% 0603 R89,R90,R91,R92,R272,R273,R274,R275			PCS	8.0000 1 0.00 %	2003/05/21 N
0026-----	RD00390 resistor 10MΩ ±1% 0603 R65,R66,R67,R68,R69,R70,R71,R72			PCS	8.0000 1 0.00 %	2003/05/21 N
0027-----	RD00077 SMDfixed resistor 1/10W 390Ω ±5% 0603 R129,R130,R131,R132			PCS	4.0000 1 0.00 %	2003/05/21 N
0028-----	RD00080 SMDfixed resistor 1/10W 680Ω ±5% 0603 R133,R134,R135,R136			PCS	4.0000 1 0.00 %	2003/05/21 N
0029-----	RD00117				4.0000	2003/05/21

Multi-Level BOM Structure Listing

Report No.: IEBO_P02
 Prepared by 010003[楊明仁]

Date 2003/07/31
 Page No.: 9 / 12

Item No. PF00325 Version
 DESCRIPTION: ALTO GATE
 ALTO GATE ALTO 230V 歐規 無

UNIT: PCS
 Date: 2003/05/21

Version	Item No Item Descri	Loss %	Ver.	Unit	Cardinal Usage Rate	Effective Date @:Phantom Layer Attrition Rate
0030	RD00127 SMDfixed resistor 1/10W 2.7MΩ ±5% 0603 R73,R74,R75,R76			PCS	4.0000 1 0.00	2003/05/21 N %
0031	RD00140 SMDfixed resistor 1/4W 4.7KΩ ±5% 1206 R237,R242,R245			PCS	3.0000 1 0.00	2003/05/21 N %
0032	CI00109 SMD0603 ceramic capacitor 20PF/50v NPO ±5% C19,C20,C21,C22,C24,C26,C27,C28			PCS	8.0000 1 0.00	2003/05/21 N %
0033	CI00071 SMDceramic capacitor0603 0.01uF/50V X7R ±10% C17,C18,C23,C25			PCS	4.0000 1 0.00	2003/05/21 N %
0034	CI00093 SMD0603 ceramic capacitor 0.015uF/50V X7R ±10% C41,C42,C43,C44,C45,C46,C47,C48			PCS	8.0000 1 0.00	2003/05/21 N %
0035	CI00029 SMDceramic capacitor0805 0.1uF/50V Y5V C53,C54,C55,C56			PCS	4.0000 1 0.00	2003/05/21 N %
0036	SE00011 SMD rectifier diode RLS4148 0.5A (LL-34) D1,D2,D3,D4,D5,D6,D7,D8,D9,D10,D11,D12,D13,D14,D15, D16,D17,D18,D19,D20,D21,D22,D23,D24,D25,D26,D27,D28, D29,D30,D31,D32,D33,D34,D35,D36,D37,D38,D39,D40,D41, D42,D43			PCS	43.0000 1 0.00	2003/05/21 N %
0037	SE00014 SMD zener diode 1/2W 2.7V(RLZ5.1B) LL-34 ZD1,ZD2,ZD3,ZD4			PCS	4.0000 1 0.00	2003/05/21 N %
0038	SF00010 SMD transistor 2SC2412K(R)(MMBT3904LT1) TR9,TR10,TR11,TR12			PCS	4.0000 1 0.00	2003/05/21 N %
0039	SF00004 SMD transistor 2SA1036K(R)(MMBT3906LT1) TR1,TR2,TR3,TR4,TR5,TR6,TR7,TR8,TR13,TR14,TR15,TR16			PCS	12.0000 1 0.00	2003/05/21 N %
0040	SG00119 SMD integrated circuit CA3086M96 IC16,IC17,IC26,IC31			PCS	4.0000 1 0.00	2003/05/21 N %
0041	SG00107 SMDintegrated circuit TL064CDT IC1,IC3,IC4,IC5,IC6,IC8,IC9,IC18,IC20,IC21,IC27,IC29, IC30,IC22			PCS	14.0000 1 0.00	2003/05/21 N %

Multi-Level BOM Structure Listing

Report No.: IEBO_P02
 Prepared by 010003[楊明仁]

Date 2003/07/31
 Page No.: 10 / 12

Item No. PF00325 Version
 DESCRIPTION: ALTO GATE
 ALTO GATE ALTO 230V 歐規 無

UNIT: PCS
 Date: 2003/05/21

Version	Item No Item Descri	Loss %	Ver.	Unit	Cardinal Usage Rate Attrition	Effective Date @:Phantom Layer Rate
0042-----	SG00116 SMD積體電路 BA10339FV E2 IC2,IC7,IC10,IC11,IC12,IC13,IC19,IC24,IC25,IC28,IC33, IC34			PCS	12.0000 1 0.00 %	2003/05/21 N
0043-----	SG00183 integrated circuit HEF4053BTR(PHILIPS) IC14,IC15,IC23,IC32			PCS	4.0000 1 0.00 %	2003/05/21 N
0044-----	RD00283 resistor 1.58KΩ ±1% 0603 R225,R226,R233,R236			PCS	4.0000 1 0.00 %	2003/06/17
0023-----	CB00111 電解電容 47uF/25V 105°C φ6*7mm 高溫標準品 C31,C34,C38,C40			PCS	4.0000 1 0.00 %	2003/07/05
0063-----	HK03923 PC board P-GATEPU-DIP			PCS	1.0000 1 0.00 %	2003/05/21 N
0001-----	RA00215 fixed resistor 1/4W 1.2KΩ M type R101			PCS	1.0000 1 0.00 %	2003/05/21 N
0002-----	RC00171 resistor 50KΩ φ6 EVND8A VR1,VR2,VR3,VR4			PCS	4.0000 1 0.00 %	2003/05/21 N
0003-----	CB00039 electrotytic capacitor 47uF/25V C25,C26,C27,C28,C29,C30,C31,C32			PCS	8.0000 1 0.00 %	2003/05/21 N
0004-----	CB00041 electrotytic capacitor 47uF/50V C57,C58			PCS	2.0000 1 0.00 %	2003/05/21 N
0005-----	CB00049 electrolytic capacitor 100uF/35V C75			PCS	1.0000 1 0.00 %	2003/05/21 N
0006-----	CB00073 electrolytic capacitor 1000uF/35V φ13*20mm C55,C56			PCS	2.0000 1 0.00 %	2003/05/21 N
0007-----	SD00015 integrated circuit THAT2150A IC4,IC7,IC10,IC13			PCS	4.0000 1 0.00 %	2003/05/21 N
0008-----	SA00001 bridge rectifier 1A/400V RB154 BD1			PCS	1.0000 1 0.00 %	2003/05/21 N

Multi-Level BOM Structure Listing

Report No.: IEBO_P02
 Prepared by 010003[楊明仁]

Date 2003/07/31
 Page No.: 11 / 12

Item No. PF00325 Version
 DESCRIPTION: ALTO GATE
 ALTO GATE ALTO 230V 歐規 無

UNIT: PCS
 Date: 2003/05/21

Version	Item No Item Descri	Loss %	Ver.	Unit	Cardinal Usage Rate	Effective Date @:Phantom Layer Attrition Rate
	TP1					
0010	HC00392 shape male JY-5030-030G 180° CN8,CN9,CN10,CN11			PCS	4.0000 1 0.00 %	2003/05/21 N
0011	HC00126 MIC jack for balance JY-5042-030G female plug 180° CN4,CN5,CN6,CN7			PCS	4.0000 1 0.00 %	2003/05/21 N
0012	HC00125 MIC jack JY-6351G-02-250 PJ1,PJ2,PJ3,PJ4,PJ5,PJ6,PJ7,PJ8			PCS	8.0000 1 0.00 %	2003/05/21 N
0013	HC00076 row-wire header 2P 2.5mm 180° CN12			PCS	1.0000 1 0.00 %	2003/05/21 N
0014	HC00261 row-wire header 12P 2.0mm 180° CN2,CN3			PCS	2.0000 1 0.00 %	2003/05/21 N
0015	HC00089 row-wire header 3P 3.9mm 180° CN1			PCS	1.0000 1 0.00 %	2003/05/21 N
0016	HK03924 K-PCB P-GATEPU-SMD			PCS	1.0000 1 0.00 %	2003/05/21 N
0001	HB00929 pc board GATEPU(1*4)_VER030503			PCS	1.0000 1 0.00 %	2003/05/21 N
0002	RD00298 resistor 47.0Ω ±1% 0603 R49,R50,R51,R52			PCS	4.0000 1 0.00 %	2003/05/21 N
0003	RD00297 resistor 60.4Ω ±1% 0603 R93,R94,R95,R96,R97,R98,R99,R100			PCS	8.0000 1 0.00 %	2003/05/21 N
0004	RD00277 resistor 200Ω ±1% 0603 R45,R46,R47,R48			PCS	4.0000 1 0.00 %	2003/05/21 N
0005	RD00271 SMD fixed resistor 1/10W 2.67KΩ ±1% 0603 R69,R70,R71,R72			PCS	4.0000 1 0.00 %	2003/05/21 N
0006	RD00363 resistor 3.16KΩ ±1% 0603 R61,R62,R63,R64,R65,R66,R67,R68			PCS	8.0000 1 0.00 %	2003/05/21 N
0007	RD00285			---	4.0000	2003/05/21

Multi-Level BOM Structure Listing

Report No.: IEBO_P02
 Prepared by 010003[楊明仁]

Date 2003/07/31
 Page No.: 12 / 12

Item No. PF00325 Version
 DESCRIPTION: ALTO GATE
 ALTO GATE ALTO 230V 歐規 無

UNIT: PCS
 Date: 2003/05/21

Version	Item No Item Descri	Loss %	Ver.	Unit	Cardinal Usage Rate	Effective Date @:Phantom Layer Attrition Rate
0008-----	RD00286 resistor 4.53KΩ ±1% 0603 R77,R78,R79,R80,R81,R82,R83,R84			PCS	8.0000 1 0.00	2003/05/21 N %
0009-----	RD00386 resistor 4.75KΩ ±1% 0603 R41,R42,R43,R44			PCS	4.0000 1 0.00	2003/05/21 N %
0010-----	RD00299 resistor 5.76KΩ ±1% 0603 R89,R90,R91,R92			PCS	4.0000 1 0.00	2003/05/21 N %
0011-----	RD00300 resistor 6.04KΩ ±1% 0603 R73,R74,R75,R76			PCS	4.0000 1 0.00	2003/05/21 N %
0012-----	RD00214 SMDprecise resistor 1/10W 10.0KΩ ±1% 0603 R1,R2,R3,R4,R6,R7,R8,R9,R10,R11,R13,R14,R15,R16,R17, R18,R20,R21,R22,R23,R24,R25,R27,R28			PCS	24.0000 1 0.00	2003/05/21 N %
0013-----	RD00301 resistor 12.1KΩ ±1% 0603 R5,R12,R19,R26,R57,R58,R59,R60			PCS	8.0000 1 0.00	2003/05/21 N %
0014-----	RD00219 SMDprecise resistor 1/10W 20.0KΩ ±1% 0603 R29,R30,R31,R32,R33,R34,R35,R36,R37,R38,R39,R40			PCS	12.0000 1 0.00	2003/05/21 N %
0015-----	RD00118 SMDfixed resistor 1/10W 150KΩ ±5% 0603 R53,R54,R55,R56			PCS	4.0000 1 0.00	2003/05/21 N %
0016-----	CI00047 SMDceramic capacitor0603 10PF/50V NPO ±5% C13,C14,C15,C16,C17,C18,C19,C20,C21,C22,C23,C24			PCS	12.0000 1 0.00	2003/05/21 N %
0017-----	CI00055 SMDceramic capacitor0603 47PF/50V NPO ±5% C1,C2,C3,C4,C5,C6,C7,C8,C9,C10,C11,C12			PCS	12.0000 1 0.00	2003/05/21 N %
0018-----	CI00063 SMDceramic capacitor0603 470PF/50V NPO ±5% C33,C34,C35,C36,C37,C38,C39,C40			PCS	8.0000 1 0.00	2003/05/21 N %
0019-----	CI00075 SMDceramic capacitor0603 0.1uF/50V Y5V +80,-20% C43,C44,C45,C46,C47,C48,C49,C50,C59,C60,C61,C62,C63, C64,C65,C66,C67,C68,C69,C70,C71,C72,C73,C74			PCS	24.0000 1 0.00	2003/05/21 N %
0020-----	SG00122				8.0000	2003/05/21

8. Exploded Views & Mechanical Parts List

機種:ALTO GATE
圖號:ALTOGATE-00
日期:2003/5/12

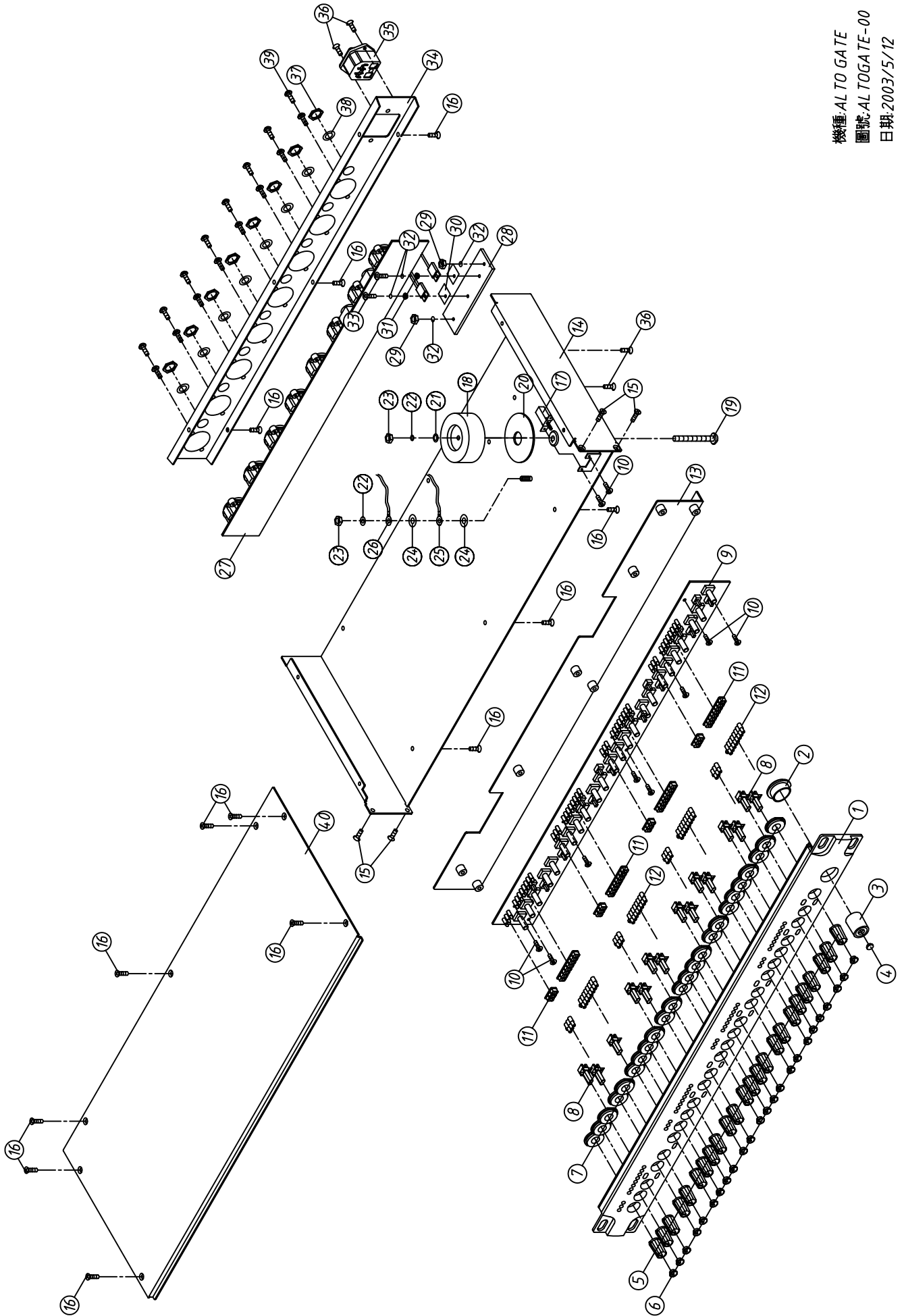

		Mechanical Parts List		
Model No.		ALTO GATE		
NO	Item No	Item Description		pcs
1	MA03793	panel	ALTO GATE	1
2	NI02085	power switch	φ 22*9.69	1
3	NI00308	φ 22*9.69	φ 15*17	1
4	NI01159	switch cap	φ 6*2.5 YELLOW C	1
5	NI00362	knob	(COOL GRAY 8C/white)	24
6	NI00896	knob cover	φ 8.5*4 072C	24
7	NI02408	bracket	φ 15*2.7mm 白 CONTROL30	24
8	NI01156	button	φ 3*W6*18.3	15
9	HB00928	pc board	GATEFP(1*4)_VER030505	1
10	MG00041	screw	M3*6	10
11	NI01876	LED spacer support	7.6*4.5*184	2
12	NI01178	pass light pillar	φ 3.1*85	3.5
13	MI01625	front board	ALTO GATE	1
14	MB00522	bottom board	CLE2.0	1
15	MG00045	screw	M3*7	4
16	MG00025	screw	M3*6	13
17	HI00023	alimention SW	SDDL B 1007U	1
18	TD00118	transformer	PT-CLE40(include FUSE102)	1
19	MG00111	screw	pill 4*30	1
20	NI00443	rubber coil	φ 20* φ 60*2tB	1
21	MF00019	washer	φ 4* φ 12*1t	1
22	MF00038	φ 4* φ 12*1t	φ 4* φ 7*1t	2
23	ME00016	colour nut	4m/m	2
24	MF00048	washer	φ 4* φ 8*0.5t	2
25	HA01333	single terminal wiring CF:W76	150mm UL1015 18AWG green/yellow	1
26	HA02190	wire	150mm	1
27	HB00929	pc board	GATEPU(1*4)_VER030503	1
28	MJ00123	heat-sink(white)	65*18*4 SCX-P234	1
29	ME00015	colour nut	3m/m	2
30	NC00005	silicone insulator	TO-220 square type	2
31	NI02249	caushion	TW-1(TO-220)	2
32	MF00037	washer	φ 3* φ 5*1t	4
33	MG00162	screw	M3*8	2
34	MB02549	rear board	ALTO GATE	1
35	HC00015	AC outlett	(S)315-B (AC select)	1
36	MG00042	screw	M3*10	4
37	ME00060	socket nut	JY-6351G-02-250	8
38	MF00061	washer	JY-6351G-02-250	8
39	MG00061	screw	M3*10	16
40	MC00209	top cover	CLE2.0	1