

Owner's Guide

for the



Ampeg

B4R

Bass Amplifier



Made in the U.S.A. by



Ampeg



TABLE OF CONTENTS

- Important Safeguards and Precautions 2
- Introduction 3
- Features 3
- The Front Panel Controls and Their Use 4,5
- The Rear Panel 6,7
- Connections: Mono Bridged 8
 - Dual Mono 8
 - Biamp, Full Range and Lows 8
 - Biamp, Highs and Lows 9
 - Biamp With Second Amplifier 9
- Some Suggested Settings 10
- Rack Mounting 10
- Troubleshooting 11
- System Block Diagram 11
- Technical Specifications back cover

Important Safeguards and Precautions:

All Ampeg products are designed for continuous safe operation, as long as common sense is used and steps are taken to help avoid certain problems. Abiding by the following rules can help prevent damage to your amplifier, yourself and others.

- The amplifier is equipped with a three-pronged AC power cord. To reduce the risk of electrical shock, **NEVER** remove or otherwise attempt to defeat the ground pin of the power cord.
- Connect the amplifier **ONLY** to a properly grounded AC outlet of the proper voltage for your amp.
- Avoid sudden temperature extremes, rain and moisture. Also, avoid sudden and intense impact. (If the unit has been subjected to any of the preceding abuses, have it looked at by an authorized service center.)
- **NEVER** set the amplifier on a support that might give out under its weight.
- Whenever using tall or stacked speaker cabinets, use them **ONLY** on a level surface. **NEVER** set tall or stacked cabinets on a surface with more than a five degree incline since tipping or falling could occur, possibly causing serious injuries.
- Always keep the total speaker impedance at or above the rated load.
- Unplug the amplifier before cleaning it. **NEVER** spray liquid cleaners onto the amplifier. Wipe it with a slightly dampened, lint-free cloth to remove dirt and film.
- Don't use the amplifier if it has sustained damage to the chassis, controls, or power cord. Refer the unit to an authorized service center for inspection.
- Amplifiers capable of producing high volume levels are also capable of inflicting permanent hearing loss or damage, if the exposure to such levels is prolonged. Such damage is progressive and irreversible!

CAUTION

RISK OF ELECTRIC SHOCK
DO NOT OPEN

CAUTION: TO REDUCE THE RISK OF ELECTRIC SHOCK, DO NOT REMOVE COVER. NO USER-SERVICEABLE PARTS INSIDE. REFER SERVICING TO QUALIFIED SERVICE PERSONNEL.

ATTENTION

RISQUE D'ELECTROCUTION
NE PAS OUVRIR

ATTENTION: POUR REDUIRE D'ELECTROCUTION NE PAS ENLEVER LE COUVERCLE. AUCUNE PIECE INTERNE N'EST REPRABLE PAR L'UTILISATEUR. POUR TOUTE REPARATION, S'ADRESSER A UN TECHNICIEN QUALIFIE.

VORSICHT

ELEKTRISCHE SCHLAGEGFAHR
NICHT OFFENEN

VORSICHT: ZUR MINIMIERUNG ELEKTRISCHER SCHLAGEGFAHR NICHT DEN DECKEL ABENHMEN. INTERNE TEILE KONNEN NICHT VOM BENUTZER GEWARTET WERDEN. DIE WARTUNG IS QUALIFIZIERTEM WARTUNGSPERSONAL ZU UBERLASSEN.

THIS EQUIPMENT HAS BEEN DESIGNED AND ENGINEERED TO PROVIDE SAFE AND RELIABLE OPERATION. IN ORDER TO PROLONG THE LIFE OF THE UNIT AND PREVENT ACCIDENTAL DAMAGES OR INJURY, PLEASE FOLLOW THESE PRECAUTIONARY GUIDELINES:

WARNING: TO REDUCE THE RISK OF ELECTRIC SHOCK, DO NOT OPEN CHASSIS; DO NOT DEFEAT OR REMOVE THE GROUND PIN OF THE POWER CORD; CONNECT ONLY TO A PROPERLY GROUNDED AC POWER OUTLET.

CAUTION: TO REDUCE THE RISK OF FIRE OR ELECTRIC SHOCK, DO NOT EXPOSE THIS EQUIPMENT TO RAIN OR MOISTURE.

CAUTION: NO USER-SERVICEABLE PARTS INSIDE. REFER SERVICING TO QUALIFIED SERVICE PERSONNEL.

CAUTION: OUR AMPLIFIERS ARE CAPABLE OF PRODUCING HIGH SOUND PRESSURE LEVELS. CONTINUED EXPOSURE TO HIGH SOUND PRESSURE LEVELS CAN CAUSE PERMANENT HEARING IMPAIRMENT OR LOSS. USER CAUTION IS ADVISED AND EAR PROTECTION IS RECOMMENDED IF UNIT IS OPERATED AT HIGH VOLUME. The chart below shows the U.S. Government Occupational Safety and Health Administration (OSHA) regulations which were in effect at the time of this publication for permissible noise exposure, per 29CRF1910, Table G-16.

SOUND LEVEL dBA SLOW RESPONSE	DURATION PER DAY IN HOURS	SOUND LEVEL dBA SLOW RESPONSE	DURATION PER DAY IN HOURS
90	8	102	1-1/2
92	6	105	1
95	4	110	1/2
97	3	115	1/4 or less
100	2		

According to OSHA, any exposure in excess of those listed above could result in some hearing loss.

EXPLANATION OF GRAPHICAL SYMBOLS:



"DANGEROUS VOLTAGE"
"DANGER HAUTE TENSION"
"GEFAHRLICHE SPANNUNG"



"IT IS NECESSARY FOR THE USER TO REFER TO THE INSTRUCTION MANUAL"
"REFERREZ-VOUS AU MANUAL D'UTILISATION"
"UNBEDINGT IN DER BETRIEBUNGSANLEITUNG NACHSCHLAGEN"



An Introduction to your new Ampeg B4R Bass Amplifier

Thank you for making one of the best choices you will ever make for your musical career – choosing one of the finest bass amps available, the Ampeg B4R. This versatile and powerful bass amplifier delivers up to 1350 watts of unsurpassed musical power, and offers several outstanding features.

All of the features and controls of your B4R are covered in detail within the pages of this owner's guide. We recommend going over them before you use the amplifier.

Features

In the world of high performance bass amps, Ampeg amplifiers stand alone. In true Ampeg tradition, the B4R offers you more power, performance and flexibility than any other bass amplifier in its class. The outstanding features of your new amplifier, features which set it apart from the competition, are listed below.

- **DUAL SEPARATE POWER AMPLIFIERS:** Operate in true stereo or mono bridged mode for even greater output power (page 6,8,9).
- **BIAMP CAPABLE:** Adjustable crossover frequency control. Low-to-high frequency balance control (page 5,8,9).
- **5-POSITION STYLE CONTROL:** Take your pick from five different tone variations to best suit your playing style (page 4).
- **TEXTURE CONTROL:** Changes your tone for a more aggressive sound (page 4).
- **9-BAND GRAPHIC EQ:** Switchable at front panel or with a footswitch, you can use this as a "second channel" for bass solos, or to shape your sound to your own exacting standards. An independent level control lets you adjust the Graphic EQ volume. (page 5).
- **EFFECTS MIX:** Varies the amount of external effects mixed into the signal (page 4,5).
- **TUNER OUT JACK:** Allows connection to an electronic tuner and provides an "always live" monitor feed even when the output is muted (page 7).
- **HEAVY-DUTY SPEAKER JACKS:** For more reliable connections at higher outputs and for mono bridged connections: dual binding posts (domestic units) or Speakon® jacks (export units) (page 6,7).
- **BALANCED AND UNBALANCED LINE OUTPUTS:** Independent level control. Balanced XLR and unbalanced 1/4" output jacks. Switchable pre or post EQ (page 7).
- **EFFECTS LOOP:** Connect your effects here for increased intensity and quieter operation (page 7).
- **POWER AMP IN/PREAMP OUT:** Two separate loops, one for each channel: a separate preamp may be connected to the Power Amp In jack, and the Preamp Out jack may be connected to a slave amp (page 6,7).
- **FOOTSWITCH CONTROL:** Use a footswitch to activate the Graphic EQ and the Mute feature (page 6,7).
- **CIRCUIT BREAKER PROTECTION:** A heavy duty resettable circuit breaker provides protection against fault conditions (page 6).



The Front Panel Controls and Their Use

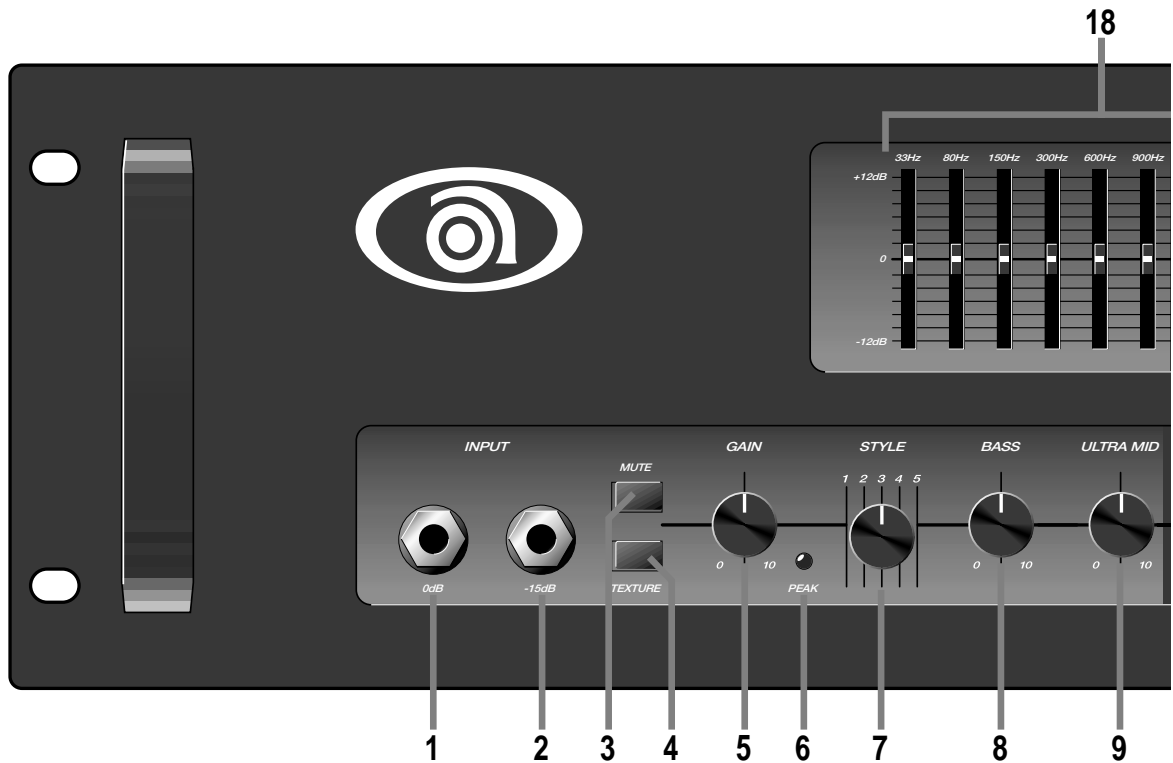

1. 0dB INPUT: The signal output from an instrument (active or passive – typically passive) or a line level signal may be connected here by means of a shielded instrument cable. The signal at this jack is sent into the preamp at full amplitude.

2. -15dB INPUT: The signal output from an instrument (active or passive – typically active) or a line level signal may be connected here by means of a shielded instrument cable. The signal at this jack is padded 15dB before it is sent into the preamp.

3. MUTE: This switch, when depressed, mutes all outputs *except* the Tuner Out (#41). A footswitch can also control muting if the Mute switch on the front panel is left in the “out” position. (The front panel switch is still active with a footswitch connected.) This is excellent for tuning your bass with an electronic tuner without having to adjust any levels or turn down your house volume.

4. TEXTURE: This switch adds a “tube emulation” stage which changes the tone for a more aggressive sound. Using the Texture switch, you can overdrive the amplifier without typical (and harsh-sounding) solid state clipping.

5. GAIN: This control sets the level of the signal entering the preamp stage. Adjust this control until the Peak LED (#6) flashes on strong signal peaks (but is not illuminated constantly while playing). To obtain the best signal to noise ratio, set the Gain control as described above and adjust the Master (#14) to obtain the desired volume level.

6. PEAK LED: This LED will illuminate when the signal entering the preamp stage is near the clipping level. Adjust the Gain control (#5) until a strong signal from your instrument causes this LED to flicker.

7. STYLE: This five-position switch allows you to vary the tone of the amplifier. The following table lists each of the different settings – experiment with the Style and other EQ controls (#8,9,10,18,19) for the results which suit you best.

POSITION 1: Fully “scooped” mids (mid cut)

POSITION 2: Traditional passive tone setting

POSITION 3: Basically flat

POSITION 4: Boosted high end

POSITION 5: Basically flat with low end roll off – for loud playing without “muddiness”

8. BASS: This is the primary low frequency control which allows 12dB of cut or boost at 50Hz. The low frequency output is flat at the center position.

9. ULTRA MID: This is the primary midrange control which allows 7dB of cut at 400Hz or boost at 800Hz. The midrange output is flat at the center position.

10. TREBLE: This is the primary high frequency control which allows 18dB of cut or boost at 5kHz. The high frequency output is flat at the center position.

11. EFFECTS MIX: This control varies the mix between the direct (dry) signal and the effects (wet) when the effects loop (#39,40) is used. Full counterclockwise results in all direct signal (no effect) and full clockwise gives all effect and no direct signal. The clockwise position is equivalent to a series effects loop and should be used with such devices as limiters and equalizers.



The Front Panel Controls and Their Use – Con't.

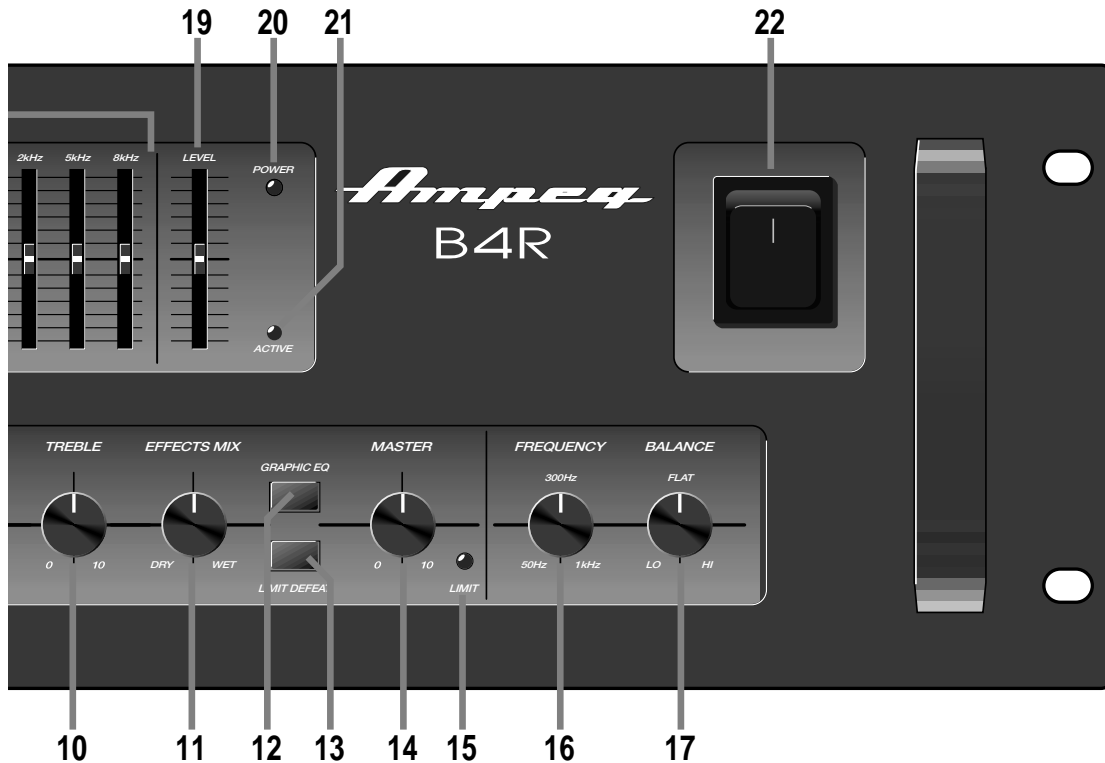

12. GRAPHIC EQ: This switch activates the graphic equalizer. When a footswitch is used, this switch is disabled.

13. LIMIT DEFEAT: The B4R employs internal limiter circuits to help keep the power amplifier's output clean at extreme volume levels. (All amplifiers may begin to clip their output signals as they approach maximum output levels, resulting in potentially speaker-damaging distortion.) These circuits may be disabled by depressing this switch. This may result in an increase in output power, but also increases the possibility of distortion. Use discretion whenever playing with the Limit circuits off.

14. MASTER: This control sets the overall output level of the amplifier. For the lowest possible noise level, adjust the Gain control as described in #5 and use this control to obtain the desired volume level.

15. LIMIT LED: This LED will flash any time the internal limit circuit is called upon to keep the amplifier's output signal clean. This indicates that the amplifier is nearing full output and the limiter is keeping it from clipping the output signal.

16. FREQUENCY: This control sets the crossover point between the Biamp High and Biamp Low Outputs when using the amplifier in the biamp mode.

17. BALANCE: This control adjusts the relative level between the low and high frequency biamp signals when using the amplifier in the biamp mode.

18. 9-BAND GRAPHIC EQ: These sliders control the amplitude of the frequencies indicated above each control. The center position of each control is flat: sliding the control upward will increase the output level of that frequency; sliding the control downward will decrease it.

The Graphic EQ can be used in two ways: 1) To fine tune your sound, make small adjustments at the desired frequencies and leave the EQ on throughout the entire session. (This is great for adapting to varying room acoustics when going from club to club, etc.) 2) For a completely different sound, make larger adjustments and only activate the EQ when you want a "second channel" sound (such as during bass solos).

19. LEVEL: This is the output volume control for the Graphic EQ and only affects the signal when the EQ is engaged. If the EQ'd signal is too soft, slide the Level control up; if it's too loud, slide the control down.

20. POWER LED: This LED glows green when the Power switch (#22) is ON.

21. ACTIVE LED: This LED illuminates when the EQ is on.

22. POWER: This heavy-duty rocker switch applies the power to the amplifier: the amp is ON when the top of the switch is depressed, OFF when the bottom of the switch is depressed.



The Rear Panel

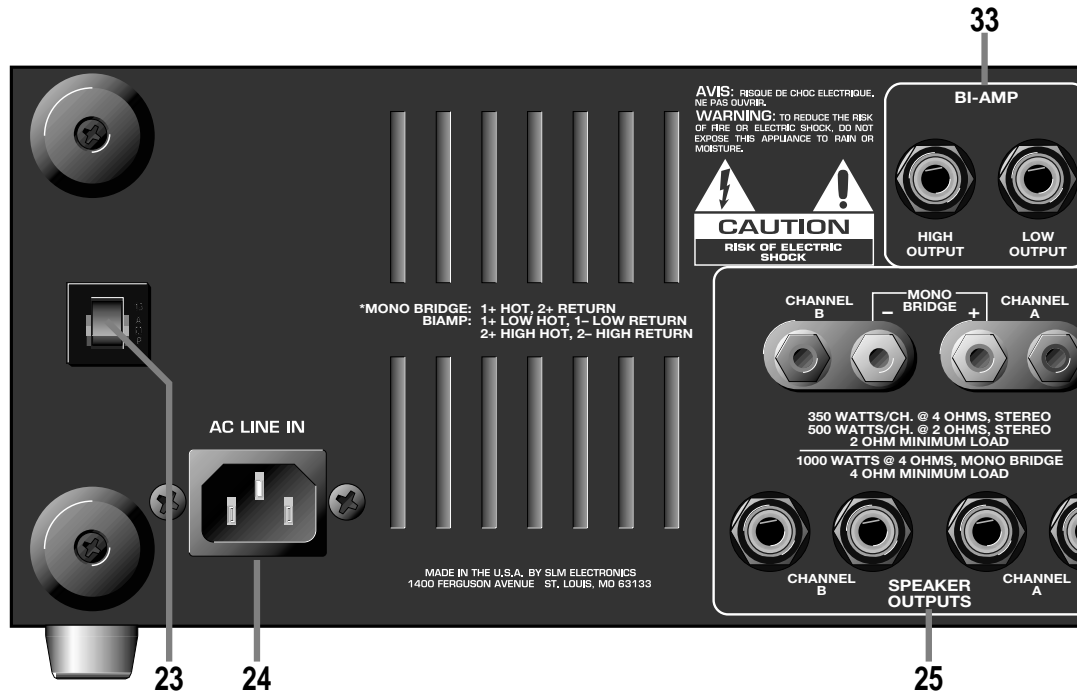

23. CIRCUIT BREAKER: The B4R employs an AC line circuit breaker to help protect against damage due to excessive current demands. If the amplifier stops working, check the circuit breaker. If it has opened, the button will be protruding and showing a contrasting color. You can reset the circuit breaker by pushing it in until it latches. The breaker must cool down for a short time before the button will latch. If the circuit breaker opens repeatedly, have the amplifier checked by a qualified service person.

24. AC LINE IN: Firmly insert the supplied AC power cord into this socket until it is fully seated. Plug the male end of the cord into a grounded AC outlet. *DO NOT DEFEAT THE GROUND PRONG OF THE AC PLUG!*

25. SPEAKER OUTPUTS: The 1/4" jacks offer a convenient method of connecting to speaker cabinets using cables terminated with 1/4" plugs. However, when using the amplifier at or near its full output power, using the five-way binding posts (domestic units) or Speakon® jacks (export units) is recommended. The binding posts/Speakon® jacks *must* be used when operating in the Mono Bridged mode. (See pages 8 and 9.)

26. FULL RANGE/BIAMP: This switch determines how the signal is sent to the internal amplifiers. In the Full Range position (switch out), a full range signal is sent to both amp chan-

nels. In the Biamp position (switch in), the low frequencies are sent to Channel A and the high frequencies are sent to Channel B. (See pages 8 and 9.)

NOTE: When Biamping, the Stereo/Mono switch (#27) must be set to Stereo. (See pages 8 and 9.)

27. STEREO/MONO: This switch sets the operating mode of the amplifier. In the "out" position the amplifier is in the Stereo Mode; with the switch in the "in" position the amplifier is in the Mono Bridged Mode. (See pages 8 and 9.)

28,30. POWER AMP INPUTS: These jacks connect directly to the power amp for use with external preamps. When using external sources, connect the OUTPUT of the sources to these jacks using shielded instrument cables to feed the signals into the power amp sections. The internal signal is disconnected when a plug is inserted. In the Mono Mode, Channel A = Input. In the Biamp Mode, Channel A = Low Input, Channel B = High Input. (See pages 8 and 9.)

29,31. PREAMP OUTPUTS These jacks are direct preamp outputs for use with external power amplifiers, mixing boards, external effects, etc. Connect the external unit inputs to these jacks using shielded instrument cables.



The Rear Panel – Con't.

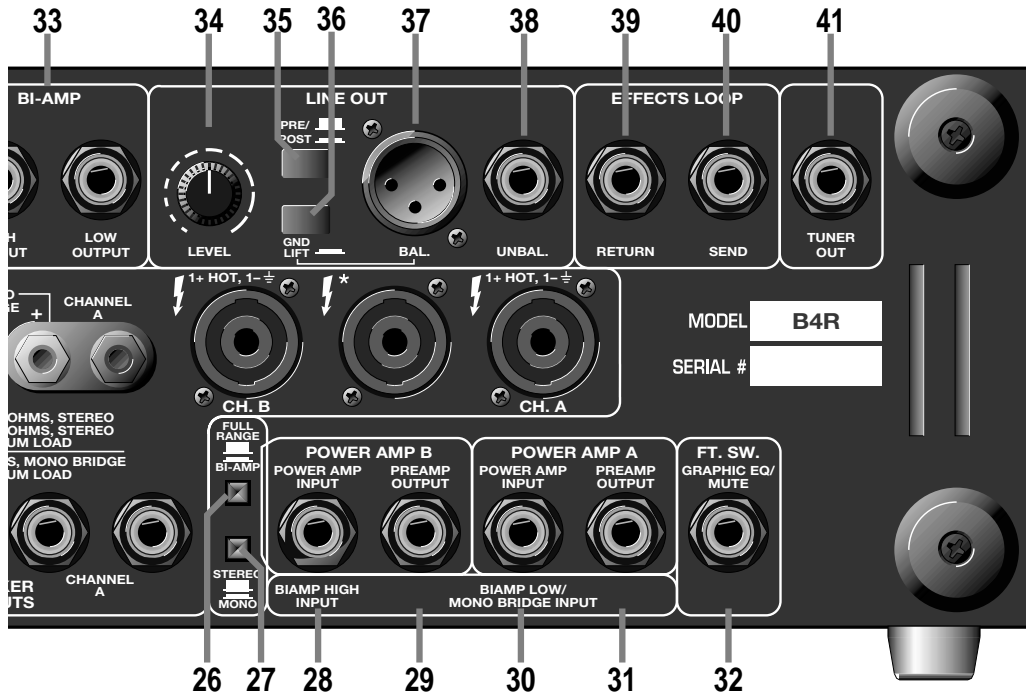

32. FOOTSWITCH: Connect a two button footswitch to this jack for remote Mute and EQ On/Off control. On the stereo 1/4" plug, the tip controls Mute and the ring controls EQ On/Off. When a footswitch is connected, the Mute switch (#3) can still be used; however, the EQ switch (#12) is disabled.

33. BIAMP HIGH/LOW OUTPUTS: When using the amplifier in the biamp mode, the Biamp High Out jack carries the high frequency signal and the Biamp Low Out jack carries the low frequency signal. (See pages 8 and 9.)

34. LINE OUT LEVEL: This controls the strength of the signal at the Line Out jacks (#37,38) and works independently from the Master control (#14).

35. LINE OUT PRE/POST SWITCH: The signal at the Line Out jacks can be set to either Pre or Post EQ with this switch. With the switch in the OUT position, the signal at the jacks will be Pre-EQ. This is a direct output not affected by any preamp tone settings. With the switch IN, the signal is Post-EQ and is controlled and modified by the tone controls, Graphic EQ and the effects loop.

36. LINE OUT GROUND LIFT: This switch disconnects the ground pin of the line Out XLR jack (#37), which may help

reduce residual hum and buzz sometimes picked up in line out signal cables. The ground is lifted when the switch is depressed.

37,38. LINE OUT JACKS: These jacks supply a pre-Master, line level signal for connection to a house mixing board, recording console or external amplifier(s). The XLR-type jack (#37) provides a *balanced* signal; the 1/4" jack (#38) provides an *unbalanced* signal. The signal level at these jacks is controlled by the Line Out Level control (#34) and is governed by the Pre/Post switch (#35).

39. EFFECTS LOOP RETURN: When using external effects, connect the effect's output into this jack using a shielded instrument cable.

40. EFFECTS LOOP SEND: When using an external signal processor, connect this jack to the input of the effect using a shielded instrument cable.

41. TUNER OUT: This jack is provided for connection to an electronic tuner and is always "live," even when the Mute switch (#3) is engaged, allowing for "silent tuning" as well as a monitor feed which remains active when the house mix is muted.



Connections:

In the example shown below, the B4R's two internal power amplifiers are bridged together to produce maximum output power.

Set the Stereo/Mono Bridge switch to the IN (Mono Bridged) position and connect the system as follows:

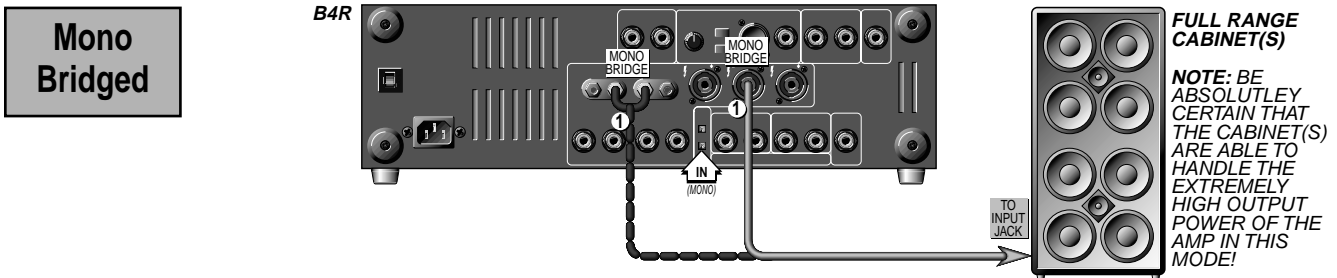

- 1: Connect a heavy duty speaker cable terminated with a Speakon® connector or dual banana plugs from the B4R's Mono Bridge / Biamp Output jack to the input jack of a speaker cabinet capable of handling the extremely high output power. (Speakon®: pin 1 +, 2 +; Banana: Mono +, Mono -.)

In the example shown below, the B4R's two internal power amplifiers will each power a set of full range cabinets.

Set the Stereo/Mono Bridge switch to the OUT (Stereo) position and connect the system as follows:

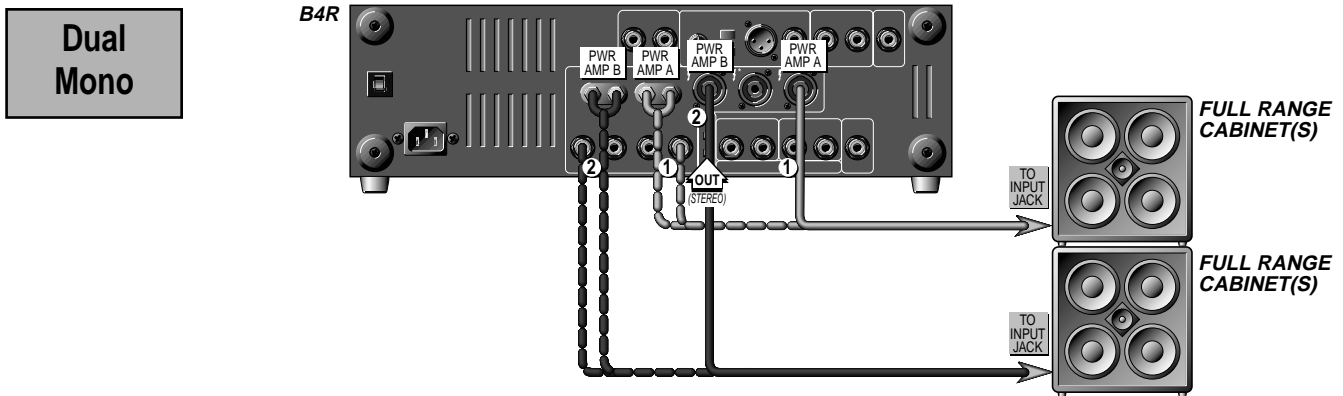

- 1: Connect a speaker cable from the B4R's Power Amp A Speaker Output jack to the input jack(s) of a set of full range speakers.
- 2: Connect a speaker cable from the B4R's Power Amp B Speaker Output jack to the input jack(s) of another set of full range speakers.

In the example shown below, the B4R's two internal power amplifiers will power both a full range cabinet and a low frequency cabinet. The crossover point is determined by the Biamp Frequency control (#16).

Set the Stereo/Mono Bridge switch to the OUT (Stereo) position and connect the system as follows:

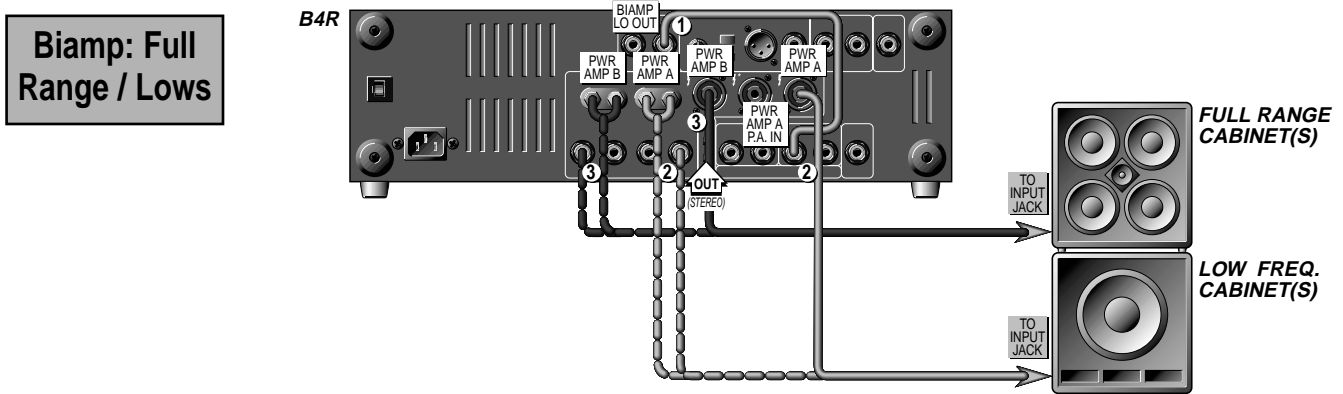

- 1: Connect a shielded cable from the B4R's Biamp Low Out jack to its Power Amp A Power Amp In jack.
- 2: Connect a speaker cable from the B4R's Power Amp A Speaker Output jack to the input jack of the low frequency cabinet(s).
- 3: Connect a speaker cable from the B4R's Power Amp B Speaker Output jack to the input jack of the full range cabinet(s).

In the example shown below, the B4R's two internal power amplifiers will power both a high frequency cabinet and a low frequency cabinet. The crossover point is determined by the Frequency control (#16).

Set the Stereo/Mono Bridge switch to the OUT (Stereo) position and connect the system as follows:

**Biamp:
Highs / Lows**

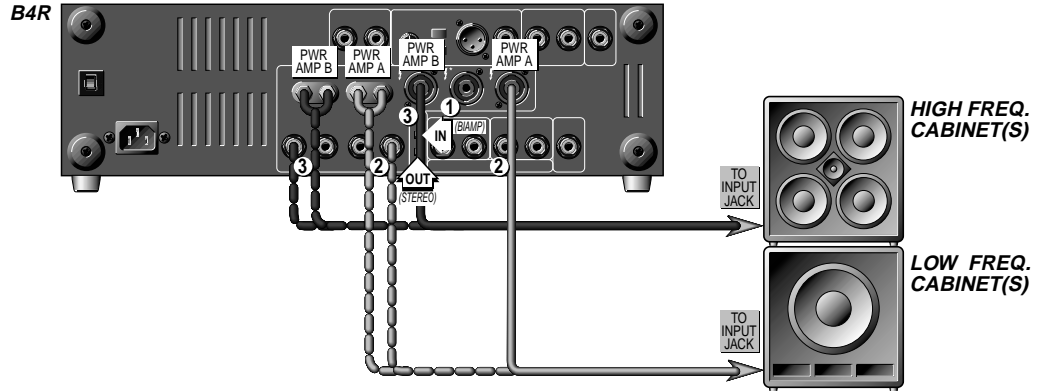

- 1: Set the Full Range/Biamp switch to the IN (Biamp) position.
- 2: Connect a speaker cable from the B4R's Power Amp A Speaker Output jack to the input jack of the low frequency cabinet(s).
- 3: Connect a speaker cable from the B4R's Power Amp B Speaker Output jack to the input jack of the high frequency cabinet(s).

In the example shown below, the B4R's two internal power amplifiers are bridged together and will power the low frequency cabinet(s). A second amplifier will be used to power the high frequency cabinet(s). The crossover point is determined by the Frequency control (#16).

Set the Stereo/Mono Bridge switch to the IN (Mono Bridge) position and connect the system as follows:

**Biamp with a
Second Amp**

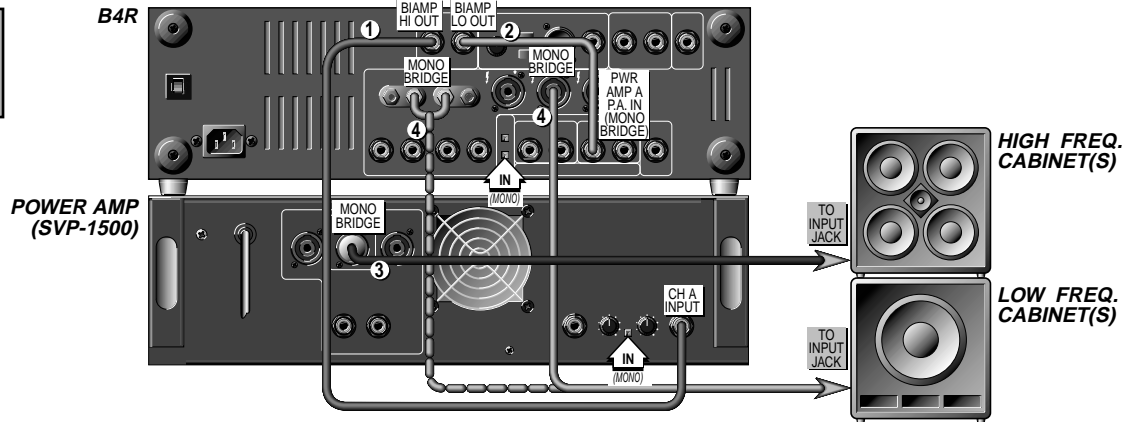

- 1: Connect a shielded cable from the B4R's Biamp High Output jack to the Input jack of the High Frequency power amplifier.
- 2: Connect a shielded cable from the B4R's Biamp Low Output jack to its Power Amp A Input jack.
- 3: Connect the high frequency power amp's Speaker Output jack to the input jack(s) of the high frequency cabinet(s). (Observe amplifier's minimum load rating!)
- 4: Connect a heavy duty speaker cable terminated with a Speakon® connector or dual banana plugs from the B4R's Mono Bridge / Biamp Output jack to the input jack of the low frequency speaker cabinet. (Speakon®: pin 1 +, 2 -; Banana: Mono -, Mono +.)

Speakon® is a registered trademark of Neutrik AG.



Some Suggested Settings

Since so many variables affect the actual sound of any system, the following settings are offered as starting points to help you find the exact sounds your playing demands. When using the B4R, please keep in mind the following points:

- The Gain control should be adjusted until the peak LED flashes on strong signals. (This level will vary, depending on your instrument and playing style.)
- The Master control should be set to produce the appropriate output volume level.
- The Graphic EQ can be used to further fine-tune these basic suggested setting, to extend the frequency response of the cabinet being used, to compensate for room acoustics, or to act like a “second channel”

ROCK:

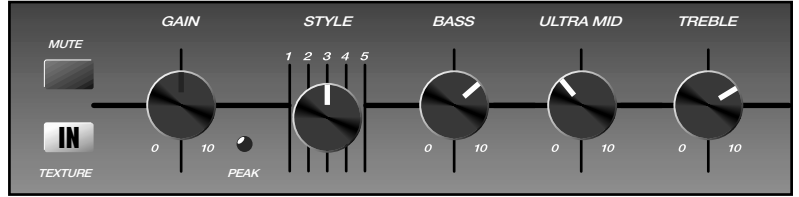

JAZZ:

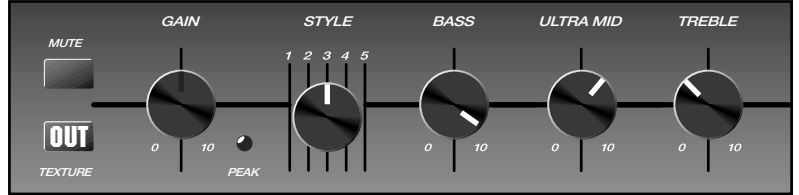

COUNTRY:

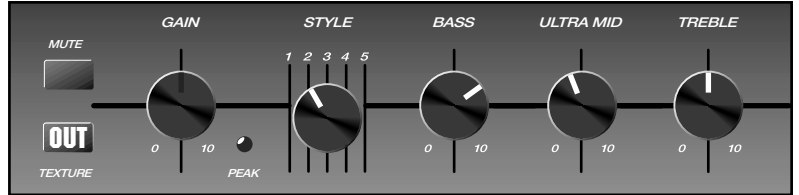

BRIGHT:

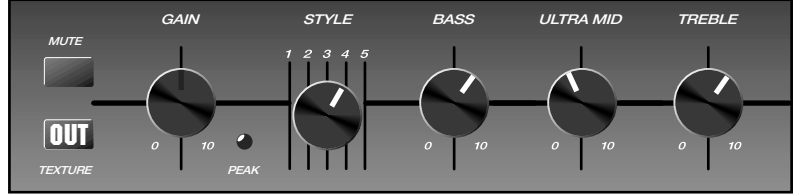

FUNK “POPPING:”

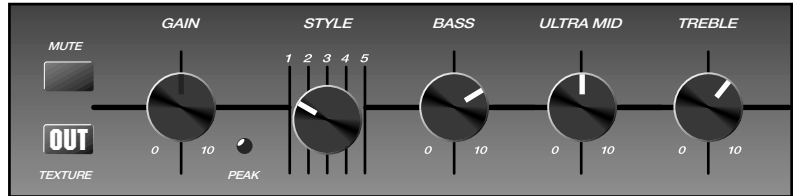

Rack Mounting

When mounting the amplifier into a rack, the four bottom feet should be removed to maintain the three rack space height of the amplifier. Be sure to keep the feet and their attachment bolts for future use. If the feet are reinstalled, never use screws which will protrude farther into the amplifier than the original hardware.

The rack must be a high quality enclosure capable of securely supporting the weight of the amplifier. Tighten the mounting screws securely through the amplifier’s face plate, into the rack rails. Check the rack and mounting screws occasionally to ensure a continually safe and secure installation.

Troubleshooting

In the unlikely event that your B4R should malfunction, take a few minutes to troubleshoot it before you call for service. You can save yourself time and money by doing it yourself, and often the problem is something quite simple.

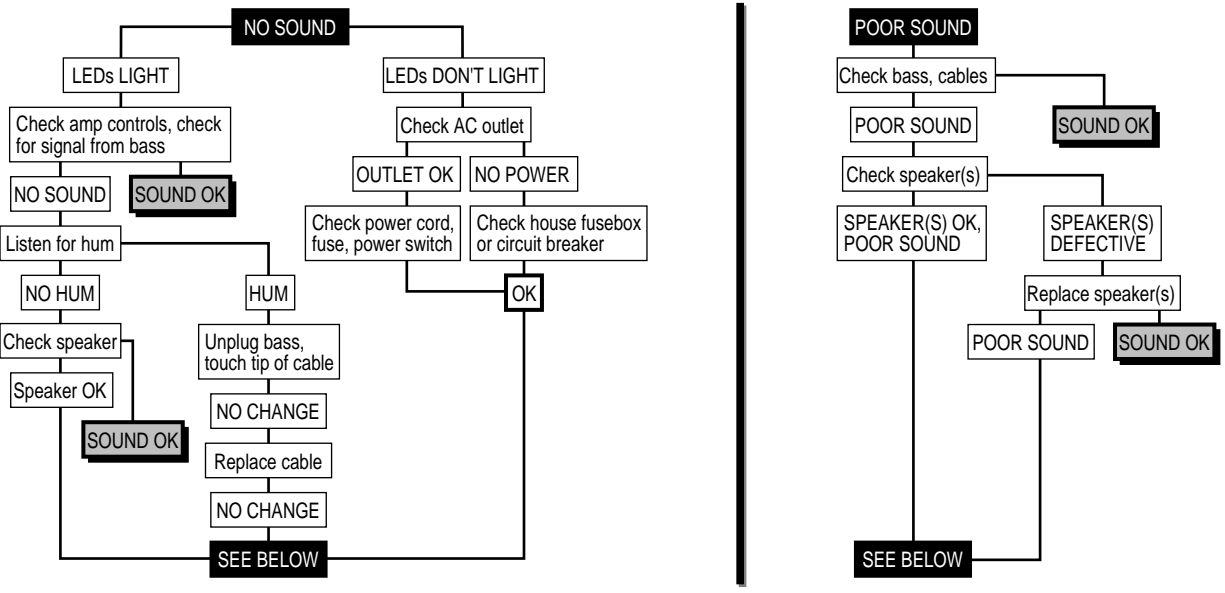

If the problem isn't covered above, or if the steps lead you here, then contact your Ampeg dealer for service information. Also, you should refer your amp to an authorized service center if it gets dropped, has liquid spilled into it, or sustains damage to its power cord (see page 2).

System Block Diagram

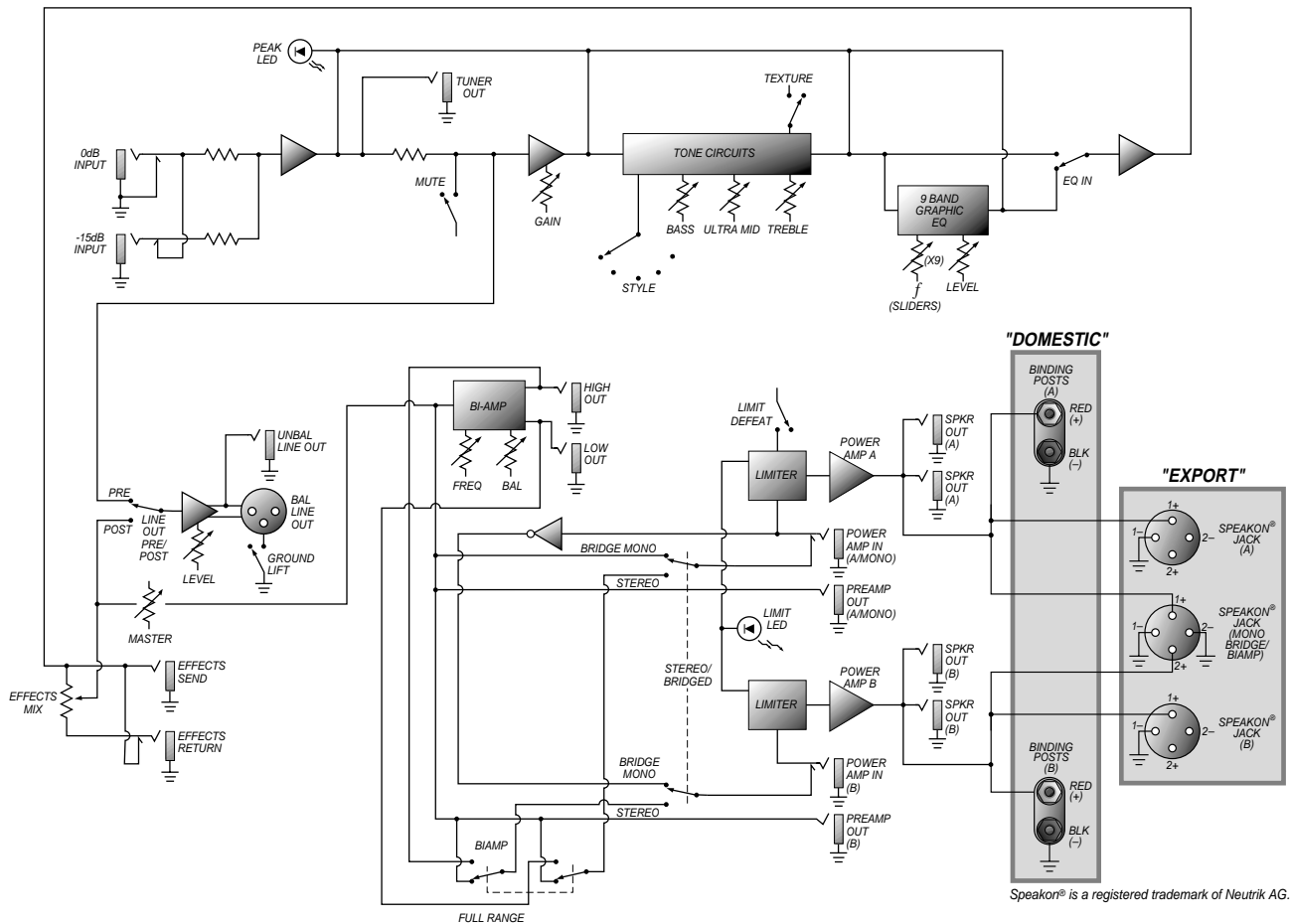

Speaker® is a registered trademark of Neutrik AG.



Technical Specifications

OUTPUT POWER RATING	1350 Watts Mono-Bridged @ 4 Ohms (1000 Watts Continuous) 840 Watts Mono-Bridged @ 8 Ohms (680 Watts Continuous) 2 x 675 Watts @ 2 Ohms (500 Watts Continuous) 2 x 420 Watts @ 4 Ohms (340 Watts Continuous) 2 x 255 Watts @ 8 Ohms (205 Watts Continuous)
<hr/>	
TONE CONTROL RANGE	Bass: ±12dB @ 50Hz Ultra Mid: +7dB @ 800Hz, -7dB @400Hz Treble: ±18dB @ 5kHz
<hr/>	
GRAPHIC EQ LEVEL	±6dB
<hr/>	
GRAPHIC EQ RANGE	33Hz: ±15dB 80Hz: ±10dB 150Hz: ±8dB 300Hz: ±8dB 600Hz: ±8dB 900Hz: ±8dB 2kHz: ±8dB 5kHz: ±10dB 8kHz: ±12dB
<hr/>	
SIGNAL TO NOISE RATIO	75dB typical
<hr/>	
FOOTSWITCH JACK	Graphic EQ On/Off, Mute On/Off – Tip = Mute, Ring = EQ
<hr/>	
POWER REQUIREMENTS	Domestic: 120VAC, 60Hz, 800VA Export: 100/115VAC 50/60Hz, 800VA 230VAC, 50/60Hz, 800VA
<hr/>	
SIZE AND WEIGHT	19/17.4"W x 5.6"H (with feet) x 15.5"D; 43 lbs

Ampeg reserves the right to change specifications without notice.

