

User's Guide for the

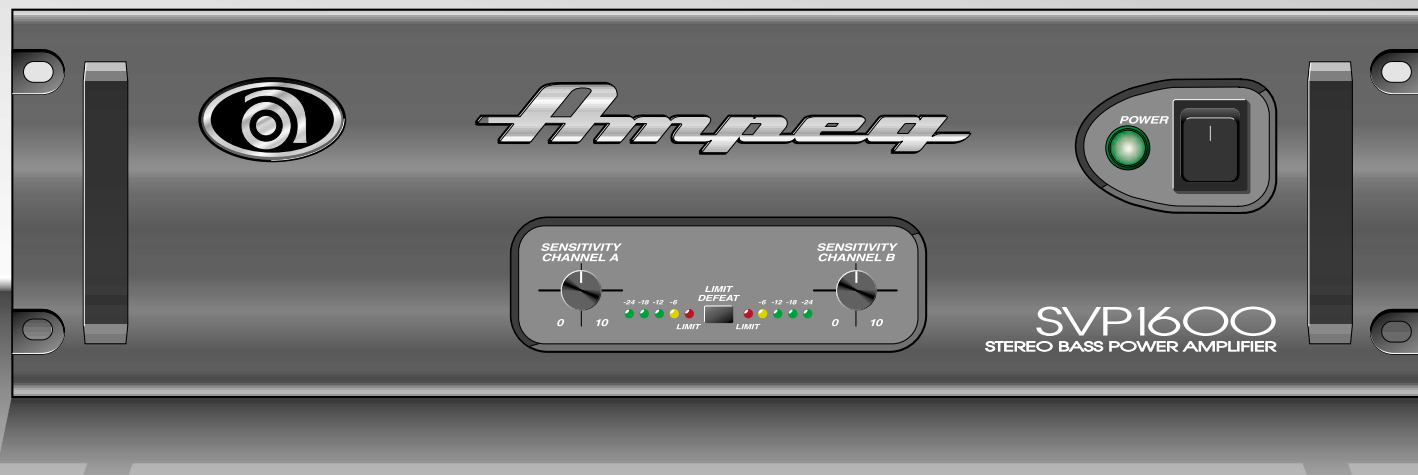

SVP1600

STEREO BASS POWER AMPLIFIER



Ampeg® is Proudly Made in America



TABLE OF CONTENTS

Important Safeguards and Precautions	2
Introduction	3
Features	3
The Front Panel	4
The Rear Panel	5
Operation: Mono Bridged Mode	6
Dual Mono Mode	6
Stereo Mode	7
System Block Diagram	7
Technical Specificationsback cover

Important Safeguards and Precautions:

All Ampeg products are designed for continuous safe operation, as long as common sense is used and steps are taken to help avoid certain problems. Abiding by the following rules can help prevent damage to your equipment, yourself, and others.

- The unit is equipped with a three-pronged AC power cord. To reduce the risk of electrical shock, **NEVER** remove or otherwise attempt to defeat the ground pin of the power cord.
- Connect the unit **ONLY** to a properly grounded AC outlet of the proper voltage for your unit.
- Avoid sudden temperature extremes, rain and moisture. Also, avoid sudden and intense impact. (If the unit has been subjected to any of the preceding abuses, have it looked at by an authorized service center.)
- **NEVER** set the unit on a support that might give out under its weight.
- Always keep the total speaker impedance at or above the rated load.
- Unplug the unit before cleaning it. **NEVER** spray liquid cleaners onto the unit. Wipe it with a slightly dampened, lint-free cloth to remove dirt and film.
- Do not use the unit if it has sustained damage to the chassis, controls, or power cord. Refer the unit to an authorized service center for inspection.
- Audio equipment capable of producing high volume levels are also capable of inflicting permanent hearing loss or damage, if the exposure to such levels is prolonged. Such damage is progressive and irreversible! Consider using quality hearing protection devices.

	CAUTION RISK OF ELECTRIC SHOCK DO NOT OPEN	
<small>WARNING: TO REDUCE THE RISK OF FIRE OR ELECTRIC SHOCK, DO NOT EXPOSE THIS APPARATUS TO RAIN OR MOISTURE. TO REDUCE THE RISK OF ELECTRIC SHOCK, DO NOT REMOVE COVER. NO USER-SERVICEABLE PARTS INSIDE. REFER SERVICING TO QUALIFIED SERVICE PERSONNEL.</small>		

	PRECAUCION RIESGO DE CORRIENTAZO NO ABRA	
<small>PRECAUCION: PARA REDUCIR EL RIESGO DE INCENDIOS O DESCARGAS ELECTRICAS, NO PERMITA QUE ESTE APARATO QUEDA EXPUESTO A LA LLUVIA O LA HUMEDAD. PARA DISMINUIR EL RIESGO DE CORRIENTAZO, NO ABRA LA CUBIERTA. NO HAY PIEZAS ADEENTRO QUE EL USUARIO PUEDE REPARAR. DEJE TODO MANTENIMIENTO A LOS TECNICOS CALIFICADOS.</small>		

	ATTENTION RISQUE D'ELECTROCUTION NE PAS OUVRIR	
<small>ATTENTION: PROTEGEZ CET APPAREIL DE LA PLUIE ET DE L'HUMIDITE AFIN D'EVITER TOUT RISQUE D'INCENDIE OU D'ELECTROCUTION. POUR REDUIRE D'ELECTROCUTION NE PAS ENLEVER LE COUVERCLE. AUCUNE PIECE INTERNE N'EST REPARABLE PAR L'UTILISATEUR. POUR TOUTE REPARATION, S'ADRESSEZ A UN TECHNICIEN QUALIFIE.</small>		

IMPORTANT SAFETY INSTRUCTIONS

- READ, FOLLOW, HEED, AND KEEP ALL INSTRUCTIONS AND WARNINGS.
- DO NOT OPERATE NEAR ANY HEAT SOURCE AND DO NOT BLOCK ANY VENTILATION OPENINGS ON THIS APPARATUS. FOR PROPER OPERATION, THIS UNIT REQUIRES 3" (75CM) OF WELL VENTILATED SPACE AROUND HEATSINKS AND OTHER AIR FLOW PROVISIONS IN THE CABINET.
- DO NOT USE THIS APPARATUS NEAR SPLASHING, FALLING, SPRAYING, OR STANDING LIQUIDS.
- CLEAN ONLY WITH LINT-FREE DAMP CLOTH AND DO NOT USE CLEANING AGENTS.
- ONLY CONNECT POWER CORD TO A POLARIZED. SAFETY GROUNDED OUTLET WIRED TO CURRENT ELECTRICAL CODES AND COMPATIBLE WITH VOLTAGE, POWER, AND FREQUENCY REQUIREMENTS STATED ON THE REAR PANEL OF THE APPARATUS.
- PROTECT THE POWER CORD FROM DAMAGE DUE TO BEING WALKED ON, PINCHED, OR STRAINED.
- UNPLUG THE APPARATUS DURING LIGHTNING STORMS OR WHEN UNUSED FOR LONG PERIODS OF TIME.
- ONLY USE ATTACHMENTS, ACCESSORIES, STANDS, OR BRACKETS SPECIFIED BY THE MANUFACTURER FOR SAFE OPERATION AND TO AVOID INJURY.
- WARNING: TO REDUCE THE RISK OF ELECTRIC SHOCK OR FIRE, DO NOT EXPOSE THIS UNIT TO RAIN OR MOISTURE.
- SERVICE MUST BE PERFORMED BY QUALIFIED PERSONNEL.
- OUR AMPLIFIERS ARE CAPABLE OF PRODUCING HIGH SOUND PRESSURE LEVELS. CONTINUED EXPOSURE TO HIGH SOUND PRESSURE LEVELS CAN CAUSE PERMANENT HEARING IMPAIRMENT OR LOSS. USER CAUTION IS ADVISED AND EAR PROTECTION IS RECOMMENDED IF UNIT IS OPERATED AT HIGH VOLUME.



EXPLANATION OF GRAPHICAL SYMBOLS:
 EXPLICACION DE SIMBOLOS GRAFICOS:
 EXPLICATION DES SYMBOLES GRAPHIQUES:

= "DANGEROUS VOLTAGE"
 "VOLTAJE PELIGROSO"
 "DANGER HAUTE TENSION"

= "IT IS NECESSARY FOR THE USER TO REFER TO THE INSTRUCTION MANUAL"
 "ES NECESARIO QUE EL USUARIO SE REFIERA AL MANUAL DE INSTRUCCIONES."
 "REFERREZ-VOUS AU MANUAL D'UTILISATION"



An Introduction to your Ampeg SVP1600 Stereo Bass Power Amplifier:

The harmonically rich sound and legendary performance of the AMPEG SVT4 PRO are the heart of the SVP1600 Stereo Bass Power Amplifier. This versatile and powerful bass amplifier delivers up to 1600 watts of unsurpassed power for any musical application.

All of the features and controls of your SVP1600 are covered in detail within the pages of this user's guide. We recommend going over them before you use the amplifier.

Features:

In the world of high performance bass amps, Ampeg's SVT amplifiers stand alone. In true Ampeg tradition, the SVP1600 offers you more power, performance and flexibility than any other stereo bass power-amplifier in its class. Listed below are some of the outstanding features of your new amplifier - features which set it apart from the competition!

- **DUAL SEPARATE POWER AMPLIFIERS:** Operate in true stereo, dual mono, or mono bridge mode for even greater output power (page 6,7)
- **SEPARATE SENSITIVITY CONTROLS:** Each channel has its own independent input Sensitivity control for optimum signal matching (page 4)
- **SEPARATE LED METERS:** Each channel features a four stage LED meter to monitor the output signal level (page 4)
- **SPEAKON® JACKS:** For more reliable connections at higher outputs and for mono bridge connections (in addition to 1/4" speaker out jacks) (page 5)
- **INTERNAL LIMITER:** Built in protection against overdrive distortion at full power - can be switched out if desired (page 4)
- **PARALLEL OUTPUT JACKS:** Drive two SVP1600 amplifiers from one input signal for the most incredible stage rig imaginable (page 5)
- **CIRCUIT BREAKER PROTECTION:** A heavy duty resettable circuit breaker provides protection against fault conditions (page 5)



The Front Panel:

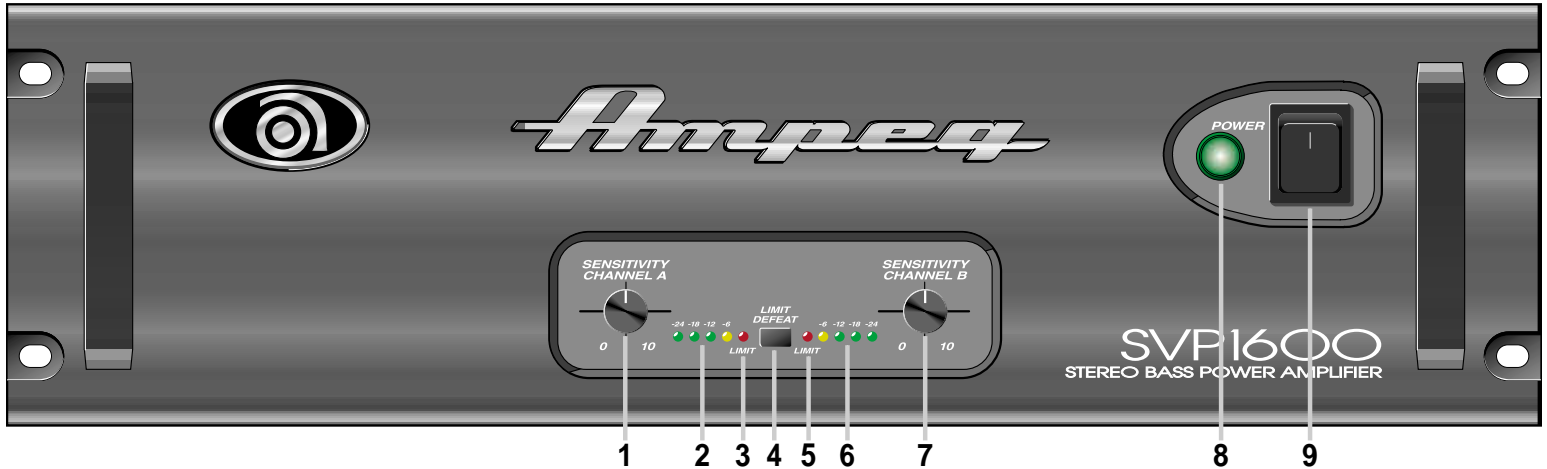

1. SENSITIVITY CHANNEL A: Use this control to adjust the input sensitivity for Channel A.

2. CHANNEL A LED METER: Use this LED meter to monitor the output signal level for Channel A.

3. CHANNEL A LIMIT LED: This LED illuminates when the output signal level for Channel A triggers the internal Limit circuits. If this LED illuminates constantly, reduce the input signal level going to the Power Amp A Input (#18) and/or turn down the Sensitivity Channel A control (#1).

4. LIMIT DEFEAT: The SVP1600 employs internal limit circuits to help keep the power amplifier's output clean at extreme volume levels. (All amplifiers may begin to clip their output signals as they approach maximum output levels, resulting in potentially speaker-damaging distortion.) These circuits may be disabled by depressing the Limit Defeat switch, which may result in an increase in output power but with the possibility of distortion. Use discretion whenever playing with the Limit circuits off.

5. CHANNEL B LIMIT LED: This LED illuminates when the output signal level for Channel B triggers the internal Limit circuit. If this LED illuminates constantly, reduce the input signal level going to the Power Amp B Input (#15) and/or turn down the Sensitivity Channel B control (#7).

6. CHANNEL B LED METER: Use this LED meter to monitor the output signal level for Channel B.

7. SENSITIVITY CHANNEL B: Use this control to adjust the input sensitivity for Channel B.

8. POWER INDICATOR: This lamp illuminates when the amplifier is powered up.

9. POWER SWITCH: Use this switch to turn the amplifier on (top of the switch depressed) and off (bottom of the switch depressed).

IMPORTANT: This unit employs forced air cooling by means of an internal fan. The rear and side ventilation slots must remain unobstructed when operating this amplifier. When mounting the unit in a rack make sure there is ample room for proper air circulation. The rack must be constructed and positioned in such a manner to allow proper air flow and the exhausting of hot air away from the rack at all times.



The Rear Panel:

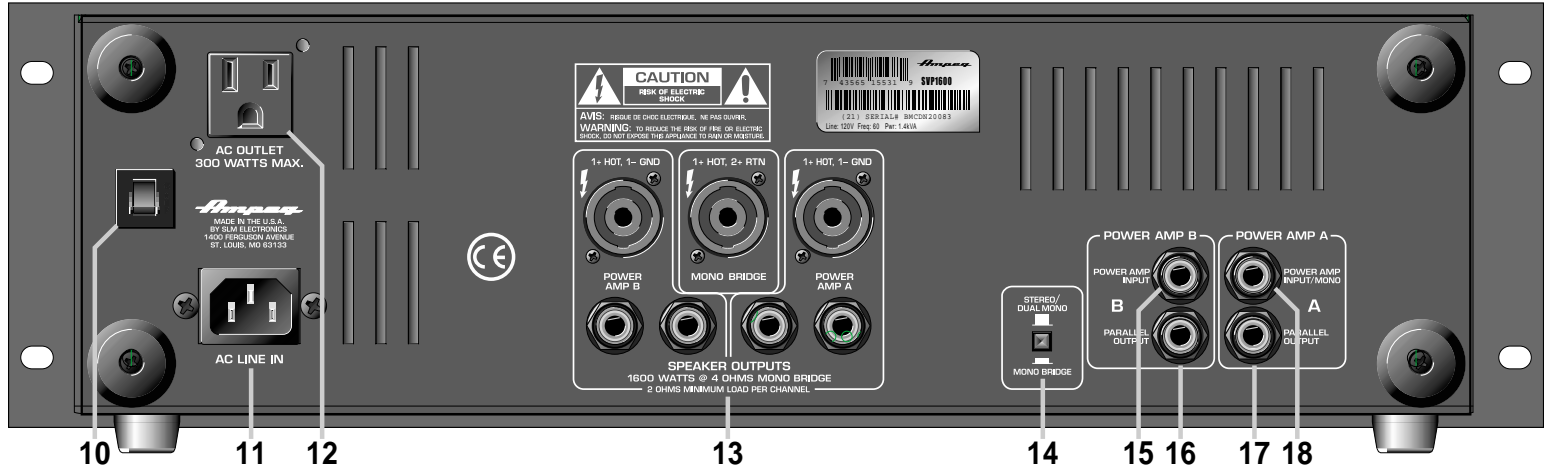

10. CIRCUIT BREAKER: The SVP1600 employs an AC line circuit breaker to help protect against damages due to excessive current demands. If the amplifier stops working, check the circuit breaker. If it has opened, the button will be protruding and showing a contrasting color. You can reset the circuit breaker by pushing it in until it latches. The breaker must cool down for a short time before the button will latch. If the circuit breaker opens repeatedly with no signal input, have the amplifier checked by a qualified service person.

11. AC LINE IN: Firmly plug the female end of the supplied AC power cord into this socket, pushing it completely until it is firmly seated. Plug the male end of the cord into a grounded AC outlet. *DO NOT DEFEAT THE GROUND PRONG OF THE AC PLUG!*

12. AC OUTLET (Domestic units only): This unswitched outlet lets you connect any AC powered device (such as a preamp or an effects unit) up to a maximum of 300 watts. The jack is "hot" whenever the amplifier is plugged into a live AC outlet, regardless of the setting of the amplifier's Power switch.

13. SPEAKER OUTPUTS: The Speakon® Jacks: Use of these heavy-duty connectors is recommended when playing at full output levels. Connect the amplifier to your speaker cabinet(s) using heavy gauge speaker cables terminated with properly wired Speakon® connectors. (See the text above these jacks for their pinout information.)

The 1/4" Jacks: These mono 1/4" jacks (two per channel, wired in parallel) offer you a convenient method of connecting the amplifier to your speaker(s) using cables terminated with 1/4" plugs. (Whenever playing at full output levels, it is recommended that you use the Speakon® jacks.)

14. STEREO/DUAL MONO / MONO BRIDGE: Use this switch to

set the operating mode of the amplifier. When the switch is out, the amplifier is in the Stereo or Dual Mono Mode; when the switch is depressed the amplifier is in the Mono Bridge Mode.

In the Stereo mode, use the Power Amp A input (#18) and the Sensitivity Channel A control (#1) for the LEFT channel, and the Power Amp B input (#15) and the Sensitivity Channel B control (#7) for the RIGHT channel. This is recommended since the Sensitivity Channel A control is positioned on the left of the amplifier and the Sensitivity Channel B control is positioned on the right. (Left controls left, right controls right...)

15. POWER AMP B POWER AMP INPUT: When operating the SVP1600 in the Stereo mode, use this jack to connect the right channel input signal to the amplifier.

16. POWER AMP B PARALLEL OUTPUT: Use this jack to send the Power Amp B Input signal to the Power Amp B Power Amp Input jack of a second SVP1600 amplifier. This jack is active when the SVP1600 is operated in either the Stereo or Dual Mono mode.

17. POWER AMP A PARALLEL OUTPUT: Use this jack to send the Power Amp A Input signal to the Power Amp A Power Amp Input jack of a second SVP1600 amplifier. This jack is active when the SVP1600 is operated in any mode.

18. POWER AMP A POWER AMP INPUT: When operating the SVP1600 in the Stereo mode, use this jack to connect the left channel input signal to the amplifier. When operating the SVP1600 in the Dual Mono or Mono Bridge mode, use this jack to connect the mono input signal to the amplifier.



SVP1600 Stereo Bass Power Amplifier

Operation: Mono Bridge Mode:

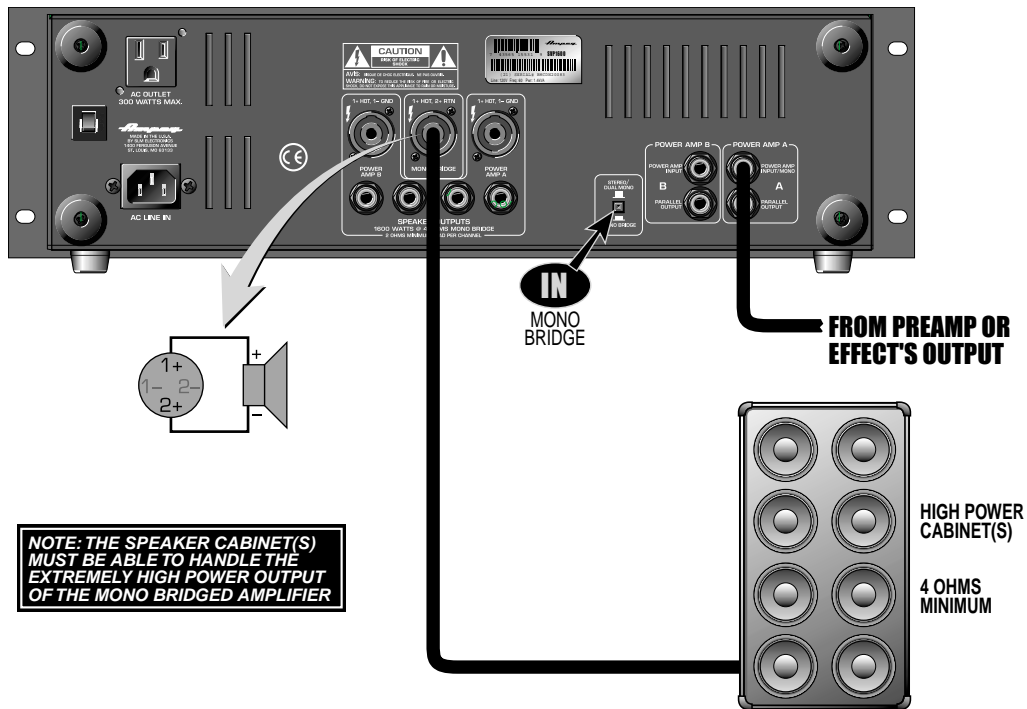

Set the Stereo/Dual Mono / Mono Bridge switch to the Mono Bridge position (switch in/depressed). Connect a shielded signal cable from the Output of your Preamp or Effect to the Power Amp A Power Amp Input jack. Connect a speaker cable from the SVP1600's Mono Bridge Speaker Output jack to the input jack(s) of the speaker(s). **NOTE: The Speaker® cable must be wired as follows: 1+ = hot, 2+ = return.**

Operation: Dual Mono Mode:

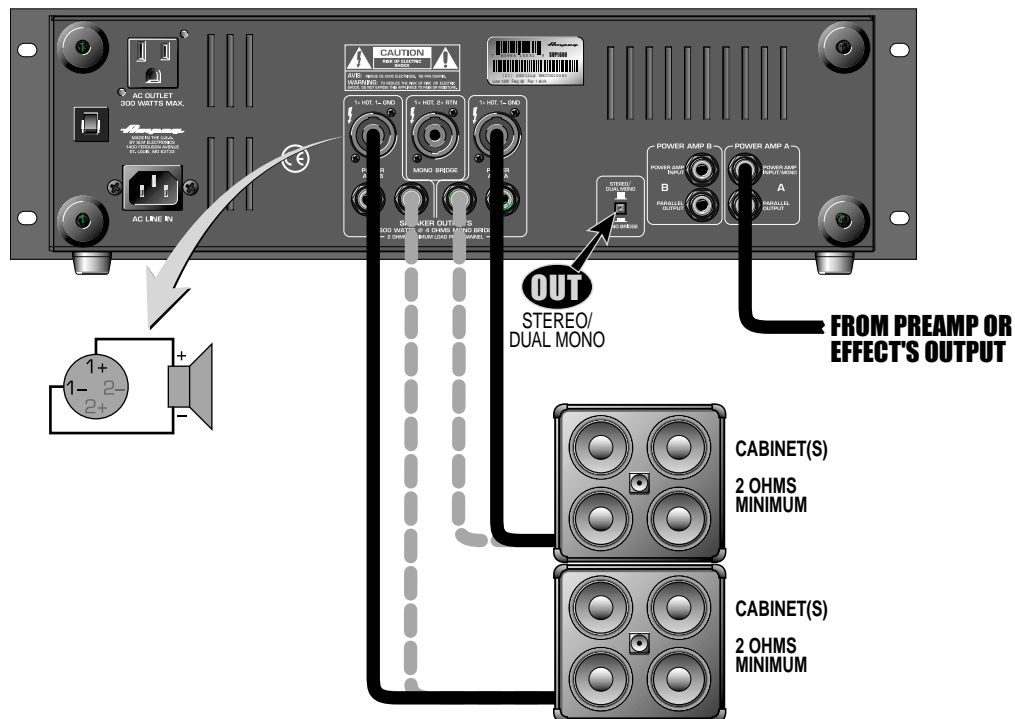

Set the Stereo/Dual Mono / Mono Bridge switch to the Stereo/Dual Mono position (switch out). Connect a shielded signal cable from the Output of your Preamp or Effect to the Power Amp A Power Amp Input jack. Connect a speaker cable from the SVP1600's Power Amp A Speaker Output jack to the input jack(s) of one (set) of the speakers. Connect a speaker cable from the SVP1600's Power Amp B Speaker Output jack to the input jack(s) of the other speaker(s). **NOTE: The Speaker® cable must be wired as follows: 1+ = hot, 1- = ground.**



SVP1600 Stereo Bass Power Amplifier

Operation: Stereo Mode:

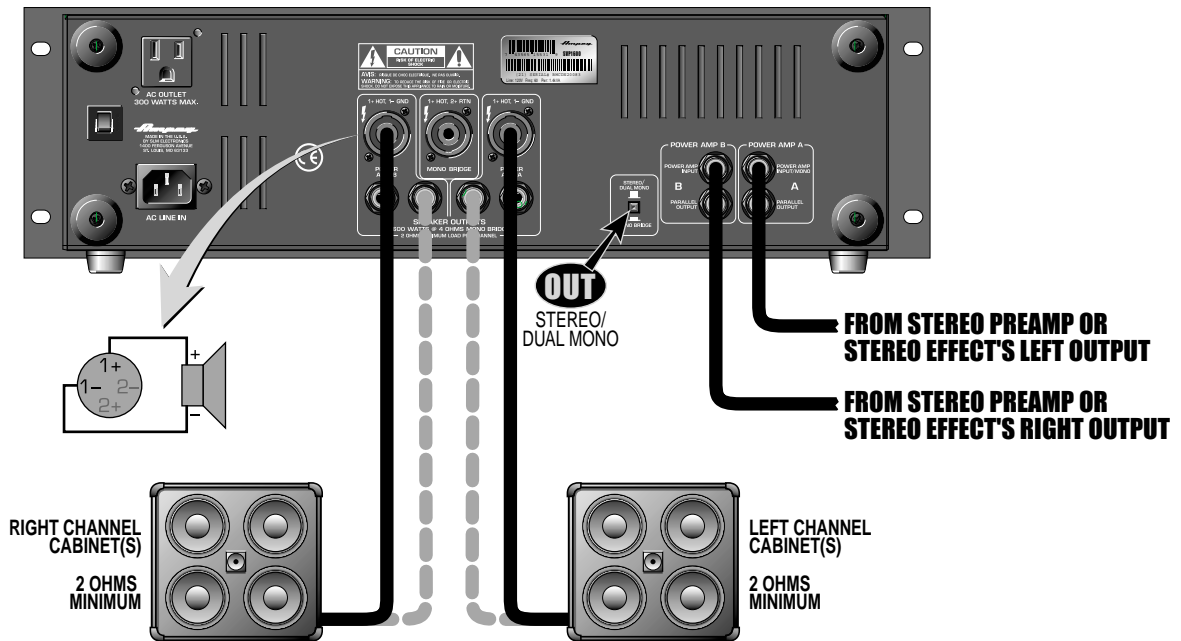

Set the Stereo/Dual Mono / Mono Bridge switch to the Stereo/Dual Mono position (switch out).

Connect a shielded signal cable from the Left Output of your Stereo Preamp or Stereo Effect to the Power Amp A Power Amp Input jack. Connect a shielded signal cable from the Right Output of your Stereo Preamp or Stereo Effect to the Power Amp B Power Amp Input jack. Connect a speaker cable from the SVP1600's Power Amp A Speaker Output jack to the input jack(s) of the Left Channel speaker(s). Connect a speaker cable from the SVP1600's Power Amp B Speaker Output jack to the input jack(s) of the Right Channel speaker(s).

NOTE: The Speakon® cable must be wired as follows: 1+ = hot, 1- = ground.

System Block Diagram:

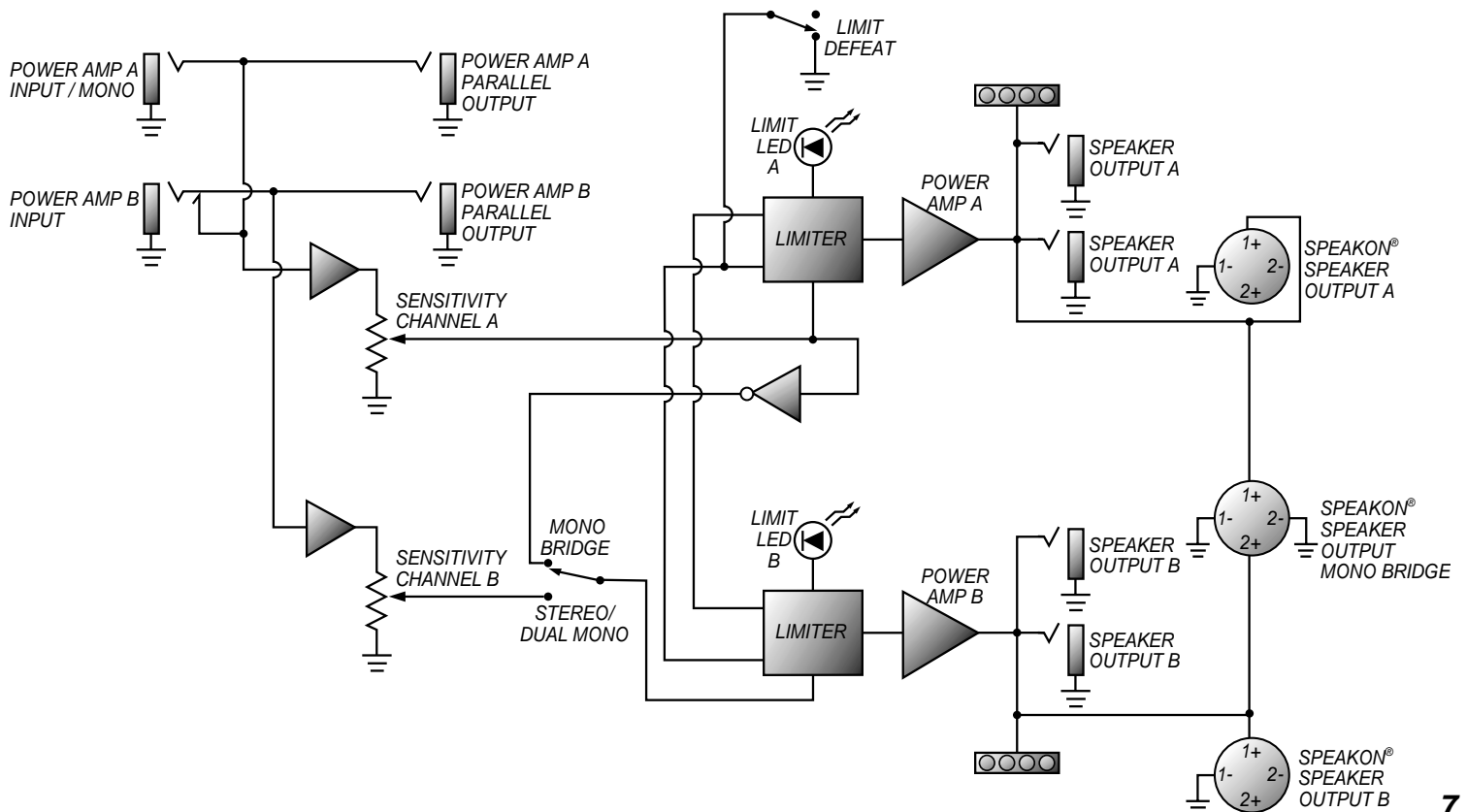



SVP1600 Stereo Bass Power Amplifier

Technical Specifications

OUTPUT POWER RATING	1600 Watts Mono-Bridged @ 4 Ohms (1200 Watts Continuous) 1200 Watts Mono-Bridged @ 8 Ohms (900 Watts Continuous) 2 x 900 Watts @ 2 Ohms (600 Watts Continuous) 2 x 625 Watts @ 4 Ohms (490 Watts Continuous) 2 x 350 Watts @ 8 Ohms (300 Watts Continuous)
FREQUENCY RESPONSE	-3dB @ 25Hz and 50kHz
TOTAL HARMONIC DISTORTION	5% @ full power
SLEW RATE	> 30V/μs (stereo)
SIGNAL TO NOISE RATIO	> 90dB typical
INPUT IMPEDANCE	220k ohm
INPUT SENSITIVITY	0.5V RMS
DAMPING FACTOR	> 300
OUTPUT CONNECTIONS	(2) 1/4" phone jacks, (1) Speakon® per channel; (1) Speakon® for Mono Bridge
PROTECTION CIRCUITRY	Over-temp and Current Limited
COOLING	Internal fan
POWER REQUIREMENTS	120VAC, 60Hz, 1.4kVA 100/115VAC 50/60Hz, 1.4kVA 240VAC, 50/60Hz, 1.4kVA
SIZE AND WEIGHT	19/17.4"W x 5.6"H (with feet) x 15.5"D; 39 lbs

Declaration Of Conformity

#32, Effective 01-01-2001

Manufacturer's Name: SLM Electronics
Production Facility: 1901 Congressional Drive, St. Louis, MO 63146, USA
Production Facility: 700 Hwy 202 W, Yellville, AR 72687, USA
Shipping Facility: 1400 Ferguson Ave., St. Louis, MO 63133, USA
Office Facility: 1400 Ferguson Ave., St. Louis, MO 63133, USA

Product Type: Audio Amplifier

Complies with the following Standards:

Safety: EN60065, E60065, C22.2, UL6500 and/or UL813
EMC: Directive 89/336/EEC, EN55103, EN55013, EN61000, and/or FCC 47CFR 15B cIA

Supplementary information provided by:
 SLM Electronics - R & D Engineering
 1901 Congressional Drive, St Louis, MO 63146, USA
 Tel.: 314-569-0141, Fax: 314-569-0175

Ampeg reserves the right to change specifications without notice.



www.ampeg.com

Ampeg is proudly Made in America. ©2003 SLM Electronics, 1400 Ferguson Avenue, St. Louis, MO 63133 U.S.A.

P/N 47-617-51 • 091103

