

**301/601**

# **Schematic Manual**

**B I A M P<sup>®</sup>**  

---

**S Y S T E M S**

**10074 SW Arctic Drive      Beaverton, OR 97005      503-641-7287**

REVISED	DESCRIPTION	DATE	BY
C	099-01	12/22/62	SK
C	099-01	REWORK RECORDS W/REV. NO. NUMBERS	

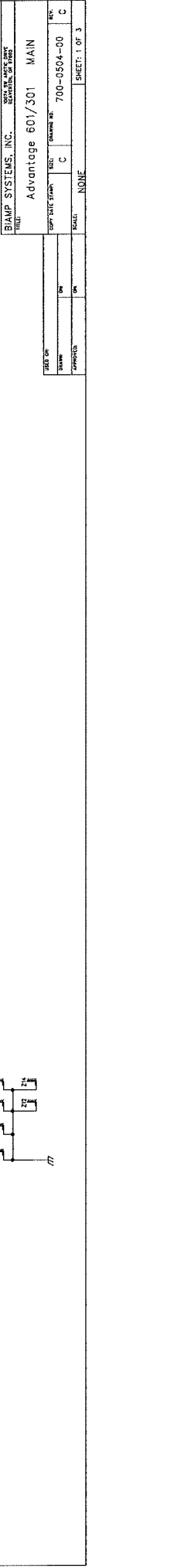
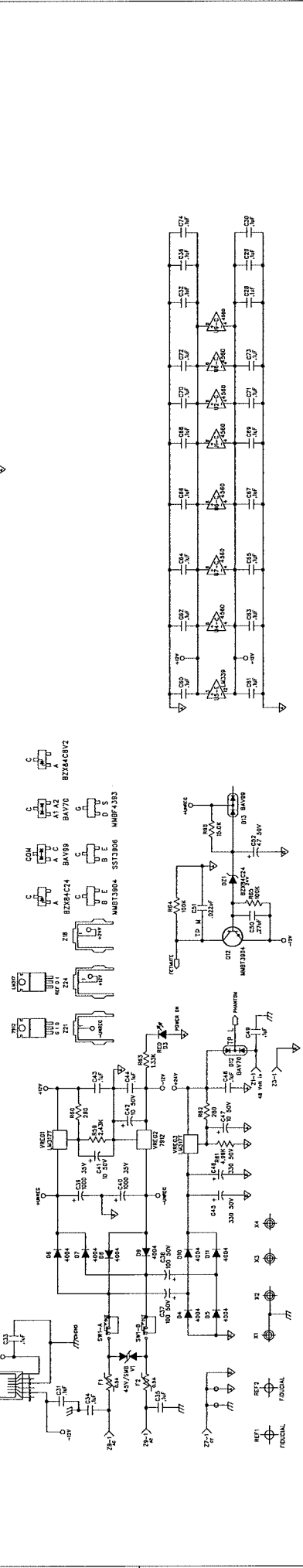
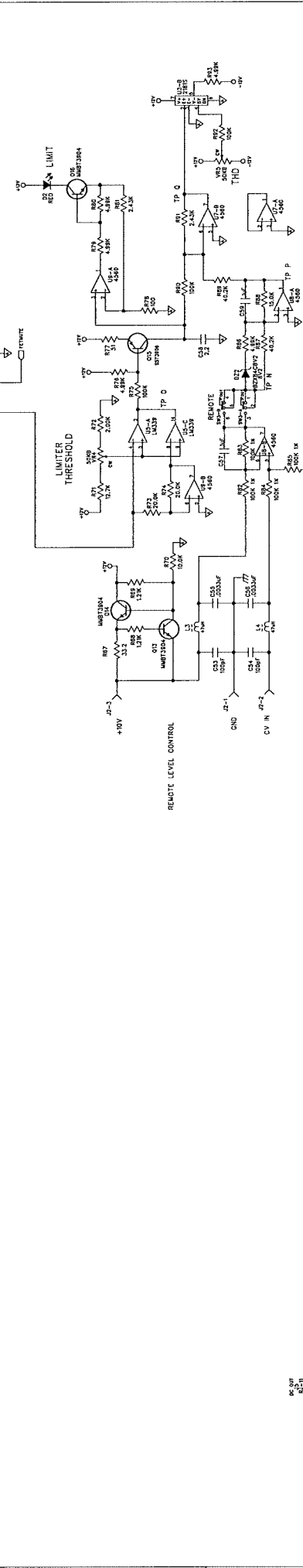
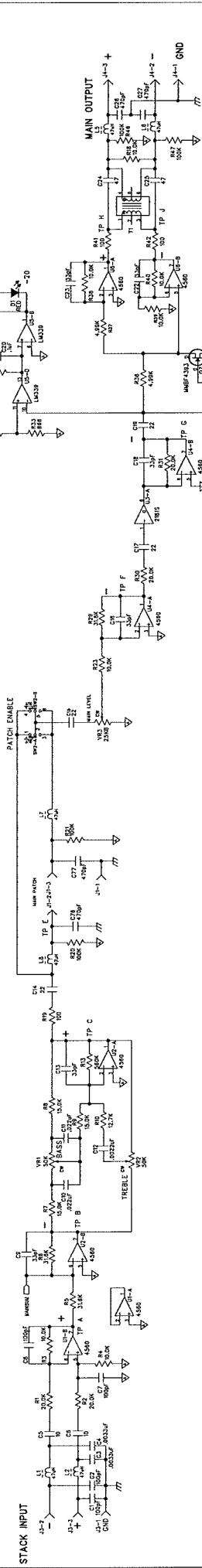

BIAMP SYSTEMS, INC.		700-0504-00	
TRIAL		MAIN	
DATE	REV.	SCALE	SHEET: 1 OF 3
09/22/62	C	NONE	



REVISED	DESCRIPTION:	DATE:	BY:

6

5

4

3

2

1

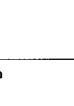
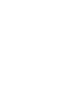
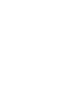
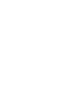
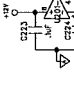
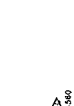
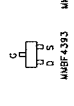
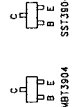
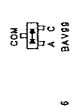
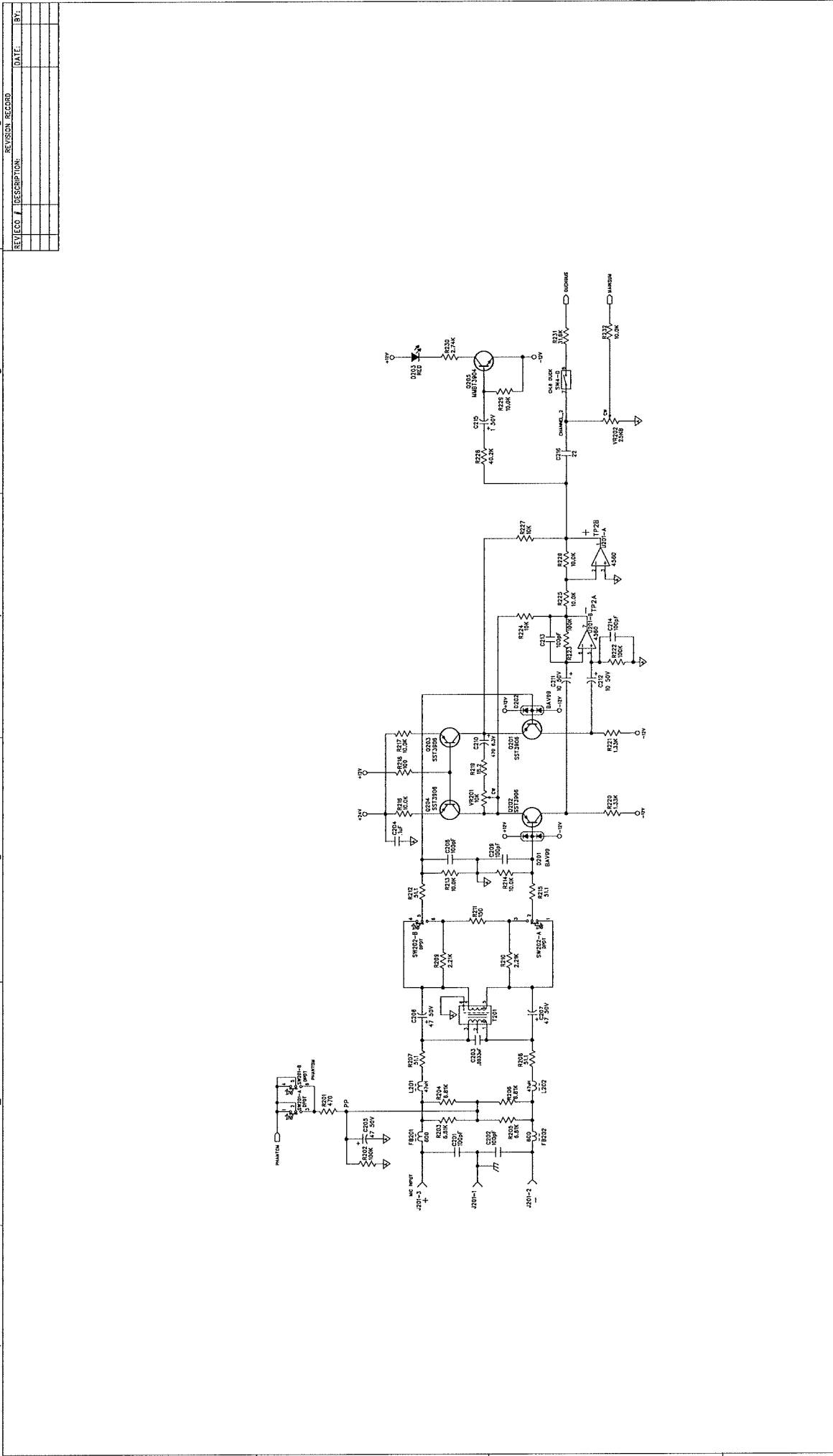

BIAMP SYSTEMS, INC.		DRAWING NO.		REV.	
700-3504-00		Channel 2		C	
DATE		SCALE		SHEET	
C		NONE		4	

REV	DATE
C	

REV	DATE
C	

REV	DATE
C	

REV	DATE
C	

REV	DATE
C	

REV	DATE
C	

REV	DATE
C	

REV	DATE
C	

REV	DATE
C	

REV	DATE
C	

REV	DATE
C	

REV	DATE
C	

REV	DATE
C	

REV	DATE
C	

REV	DATE
C	

REV	DATE
C	

REV	DESCRIPTION	DATE	BY

6

5

4

3

2

1

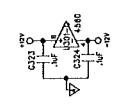
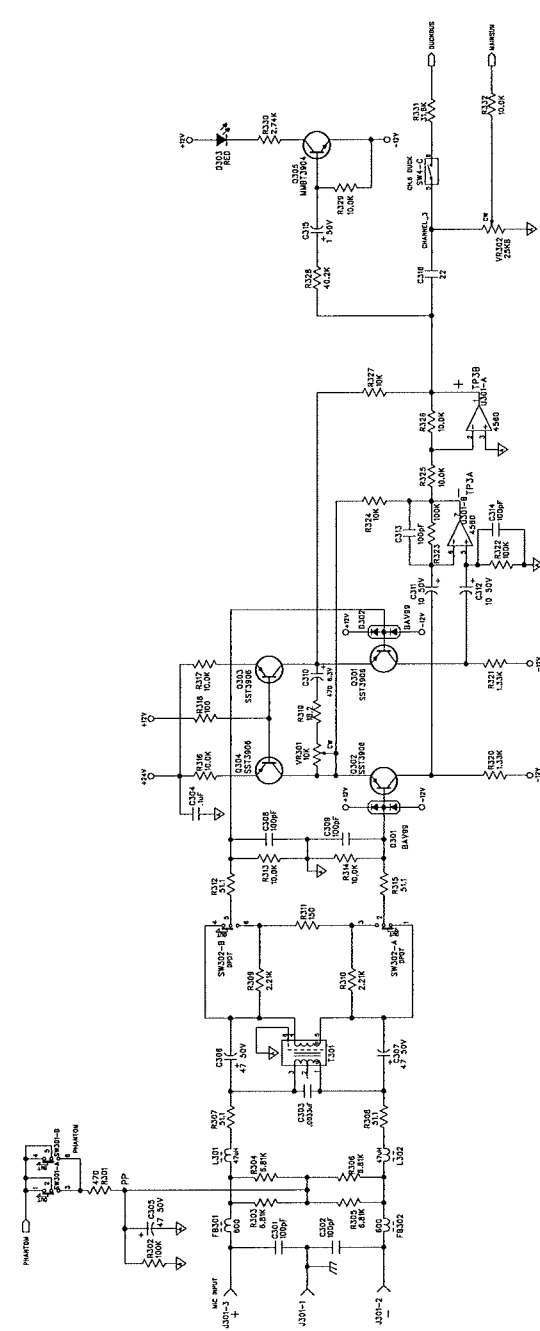

BIAMP SYSTEMS, INC.		800 N. W. 40th ST. MIAMI, FL 33149	
FILE: Advantage 601 Channel 3			
DEPT. DATE STAMP:	REV.:	DRAWING NO.:	REV.:
C	C	700-0504-00	C
SCALE:	NONE	SHEET:	5

FIELD NO.:	DATE:
DRAWING APPROVED:	DRAWER:

REV. NO.	DESCRIPTION	DATE	BY:
6	REVISION REQUIRED		

1 2 3 4 5

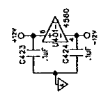
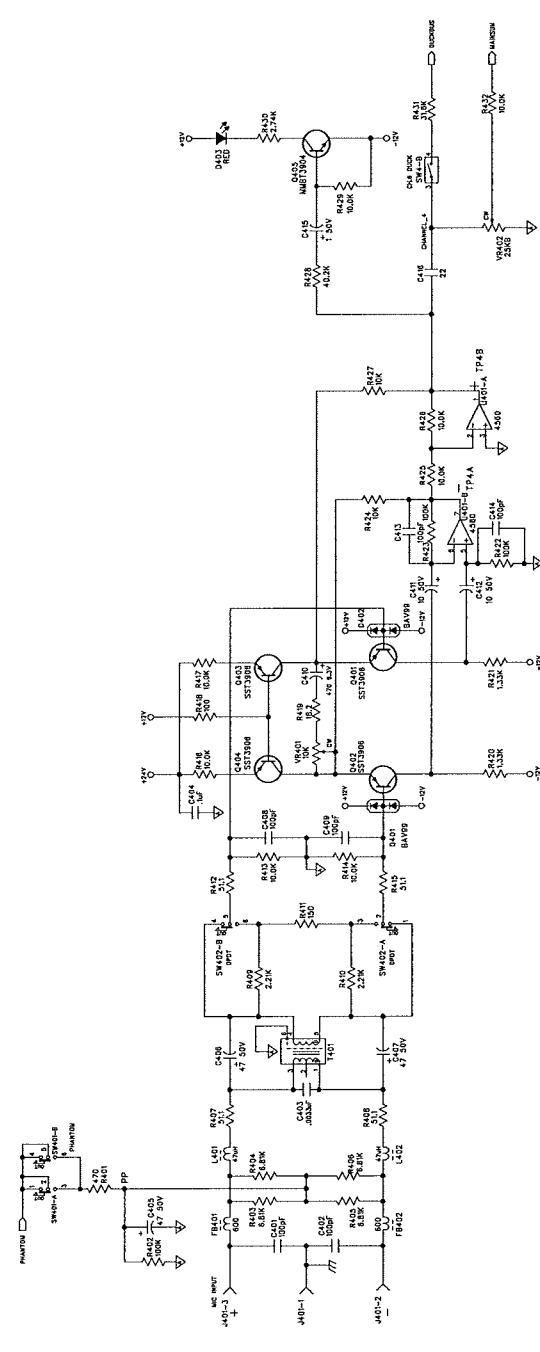

BIAMP SYSTEMS, INC.		800 WILSON AVENUE, SUITE 100 SUNNYVALE, CALIF. 94085	
FILE:	Advantage 601/301 Channel 4	DATE:	
COPY DATE STAMP:		SIZE:	C
SCALE:	NONE	DRAWING NO.:	700-0504-00
DESIGNER:		APPROVER:	
DATE:		SCALE:	NONE
		SHEET: 6	



REV.	DESCRIPTION	DATE	BY:
6	REVISION RECORD		

6

5

4

3

2

1

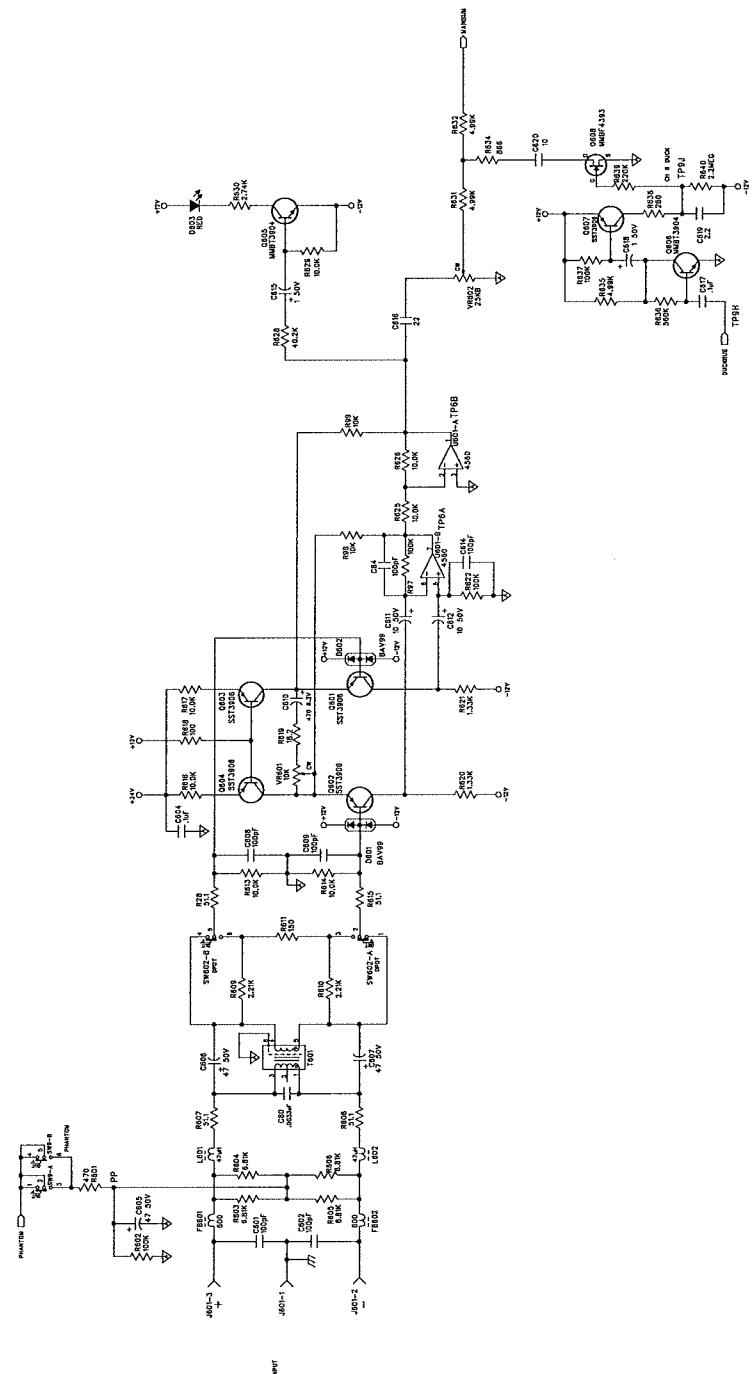

BIAMP SYSTEMS, INC.	DATE: 10/1/77	BY: JTB
THEIR: 1000 W. 10TH ST. DENVER, CO. 80202		
MODEL: 601/301 Channel 6		
FORM NO: 700-0504-00		
SCALE: C		
NOTE: NONE		

USED ON:	DATE:	BY:
700-0504-00		
700-0504-00		
700-0504-00		

FORM NO:	DATE:	BY:
700-0504-00		
700-0504-00		
700-0504-00		

FORM NO:	DATE:	BY:
700-0504-00		
700-0504-00		
700-0504-00		

FORM NO:	DATE:	BY:
700-0504-00		
700-0504-00		
700-0504-00		

FORM NO:	DATE:	BY:
700-0504-00		
700-0504-00		
700-0504-00		

FORM NO:	DATE:	BY:
700-0504-00		
700-0504-00		
700-0504-00		

FORM NO:	DATE:	BY:
700-0504-00		
700-0504-00		
700-0504-00		

FORM NO:	DATE:	BY:
700-0504-00		
700-0504-00		
700-0504-00		

FORM NO:	DATE:	BY:
700-0504-00		
700-0504-00		
700-0504-00		

FORM NO:	DATE:	BY:
700-0504-00		
700-0504-00		
700-0504-00		

FORM NO:	DATE:	BY:
700-0504-00		
700-0504-00		
700-0504-00		

FORM NO:	DATE:	BY:
700-0504-00		
700-0504-00		
700-0504-00		

FORM NO:	DATE:	BY:
700-0504-00		
700-0504-00		
700-0504-00		

FORM NO:	DATE:	BY:
700-0504-00		
700-0504-00		
700-0504-00		

FORM NO:	DATE:	BY:
700-0504-00		
700-0504-00		
700-0504-00		

FORM NO:	DATE:	BY:
700-0504-00		
700-0504-00		
700-0504-00		

FORM NO:	DATE:	BY:
700-0504-00		
700-0504-00		
700-0504-00		