

BF-3(T)

Flanger

SERVICE NOTES

Issued by RJA

SPECIFICATIONS.....2
 EXPLODED VIEW3
 PARTS LIST.....4
 TEST MODE.....7
 CIRCUIT BOARD.....10
 CIRCUIT DIAGRAM.....12

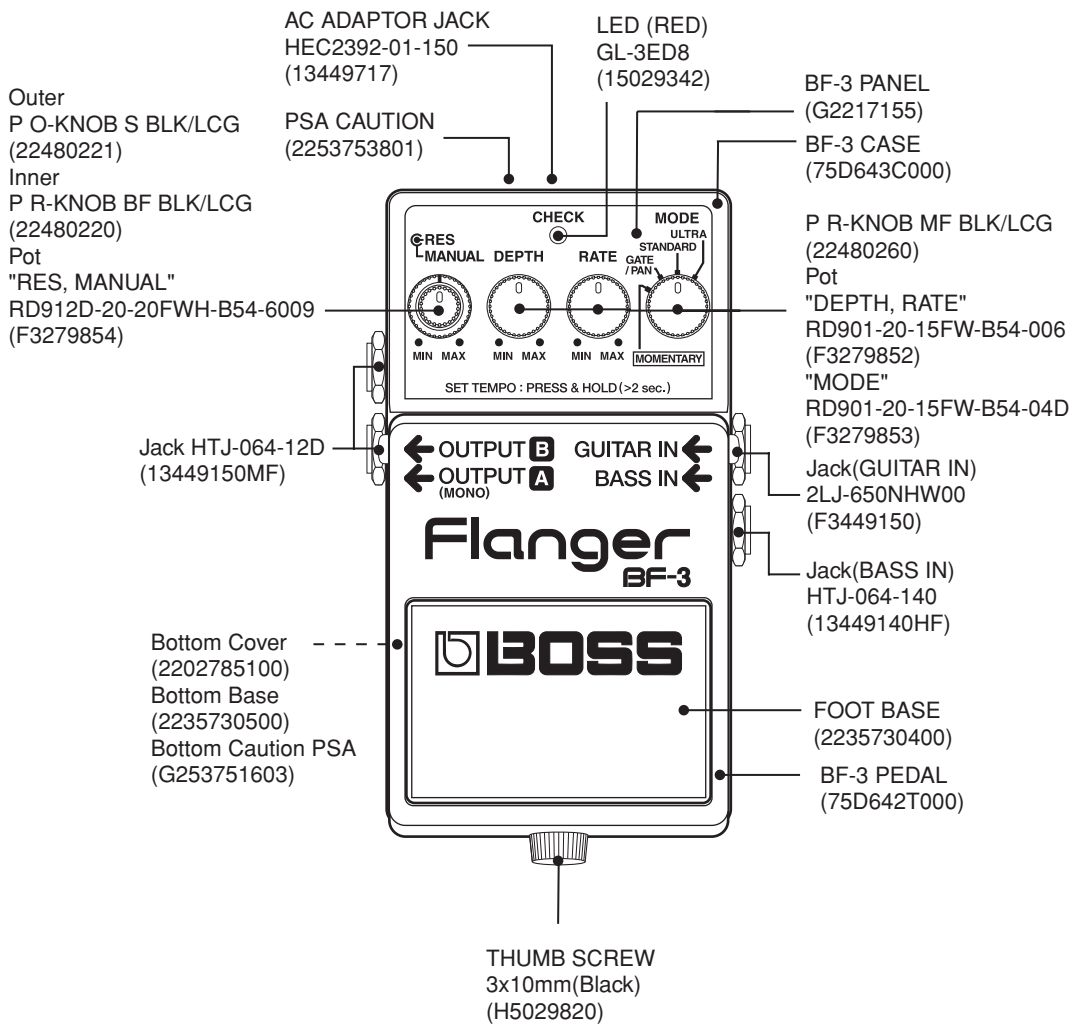

Copyright © 2002 ROLAND CORPORATION

All rights reserved. No part of this publication may be reproduced in any form without the written permission of ROLAND CORPORATION.

SPECIFICATIONS

Owner's Manual English (#G6017305)
Dry battery (9 V type) S-006P/9 V (6F22/9 V)

BF-3: Flanger

- Nominal Input Level
-20 dBu
- Input Impedance
1 M ohm
- Nominal Output Level
-20 dBu
- Output Impedance
1 k ohm
- Recommended Load Impedance
10 k ohm or greater
- Delay Time
0.3 mS -- 14.4 mS (GUITAR IN)
0.3 mS -- 6.3 mS (BASS IN)
- LFO Speed
100 mS -- 18 S
- Residual Noise
-95 dBu (IHF-A Typ.)
- Controls
Pedal Switch, MANUAL Knob, RES (resonance) Knob, DEPTH Knob,
RATE Knob, MODE Knob
- Indicator
CHECK Indicator (Serves also as tempo and battery check indicator)
- Connectors
GUITAR IN Jack, BASS IN Jack, OUTPUT A (MONO) Jack, OUTPUT B
Jack, AC adaptor Jack (DC 9 V)
- Power Supply
DC 9 V: Dry battery (9 V type) S-006P/9 V (6F22/9 V)
Dry battery (9 V type) 6AM6/9 V (alkaline)
AC Adaptor (PSA-series: optional)
- Current Draw
40 mA (DC 9 V)

* *Expected battery life under continuous use:*
Carbon: 3 hours Alkaline: 10 hours
These figures will vary depending on the actual conditions of use.

- Dimensions
73 (W) x 129 (D) x 59 (H) mm
2-7/8 (W) x 5-1/8 (D) x 2-3/8 (H) inches
- Weight
420 g /15 oz (including Battery)
- Accessories

* *The battery that was supplied with the unit is for temporary use-intended primarily for testing its operation.*

- Options
AC Adaptor PSA-Series

* *0 dBu = 0.775 Vrms*

* *In the interest of product improvement, the specifications and/or appearance of this unit are subject to change without prior notice.*

EXPLODED VIEW

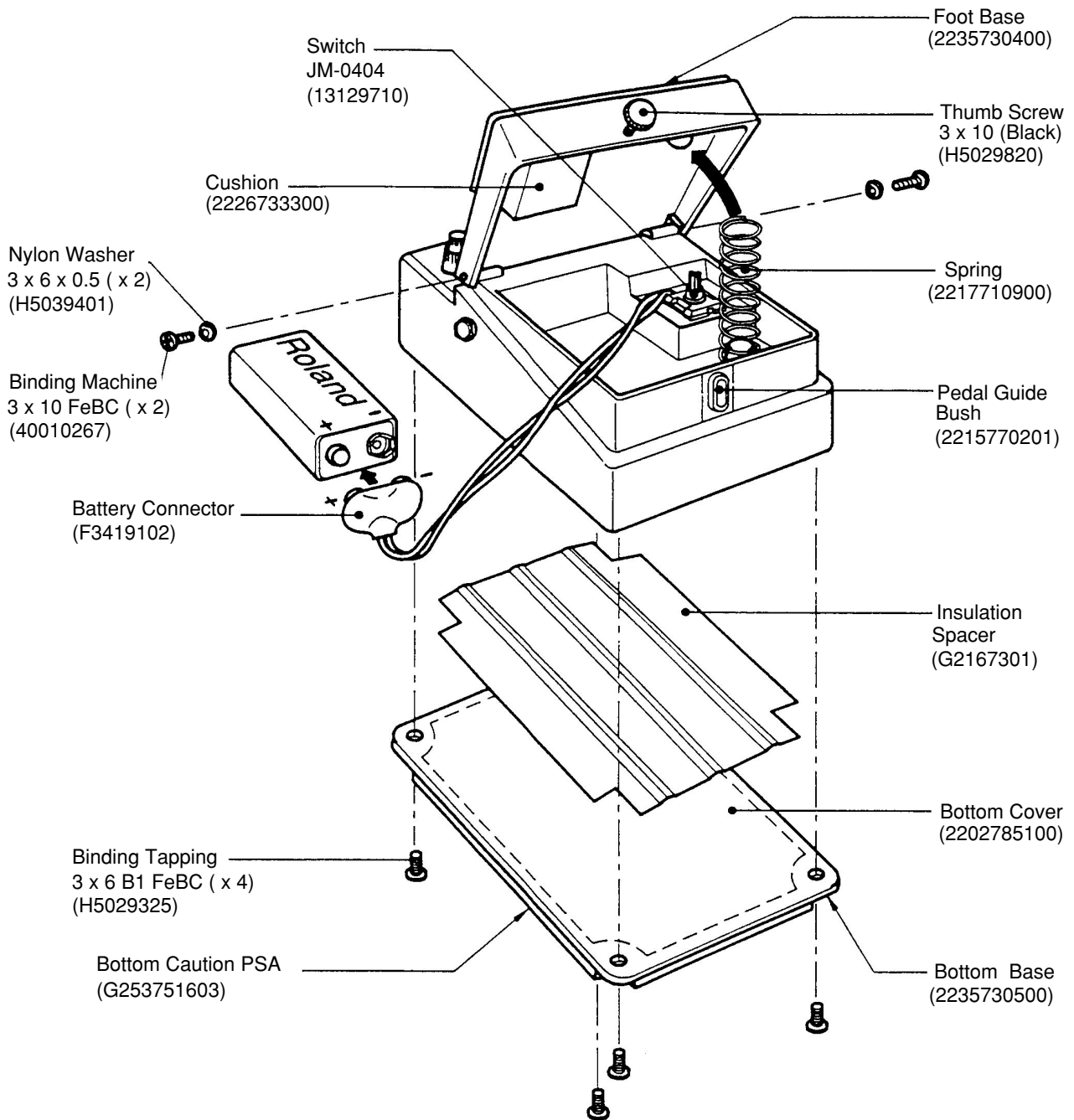

PARTS LIST

SAFETY PRECAUTIONS:

The parts marked Δ have safety-related characteristics. Use only listed parts for replacement.

CONSIDERATION ON PARTS ORDRING

When ordering any parts listed in the parts list, please specify the following items in the order sheet.

	QTY	PART NUMBER	DESCRIPTION	MODEL NUMBER
Ex.	10	22575241	Sharp Key	C-20/50
	15	2247017300	Knob (orange)	DAC-15D

Failure to completely fill the above items with correct number and description will result in delayed or even undelivered replacement.

NOTE: The parts marked # are new. (initial parts)

CASING

	2235730500	BOTTOM BASE	235-305	1
	2235730400	FOOT BASE (PEDAL MAT)	235-304	1
	2202785100	BOTTOM COVER	202-851	1
#	75D643C000	CASE		1
#	G2217155	PANEL		1
#	75D642T000	PEDAL		1

KNOB,BUTTON

	22480260	P R-KNOB	MF BLK/LCG	3
	22480220	P R-KNOB (INTERNAL)	(SS) BF BLK/LCG	1
	22480221	P O-KNOB (EXTERNAL)	(OUTER) S BLK/LCG	1

SWITCH

	13129710	JM-0404	SWITCH (PUSH)	SW1	1
--	----------	---------	---------------	-----	---

JACK,EXT TERMINAL

	13449150MF	HTJ-064-12D	PHONE JACK (STEREO)	JK2	1
	13449140MF	HTJ-064-14D	JACK (STEREO)	JK4	1
	13449105MF	HTJ-064-14I	JACK	JK5	1
#	F3449150	2LJ-650NHW00	GUITAR IN	JK3	1
	13449717	HEC2392-01-150	ADAPTOR JACK	JK1	1

PWB ASSY

#	75D643I000	IN JACK ASSY		1
#	75D6439001	MAIN BOARD ASSY		1
#	75D643O000	OUT JACK ASSY		1

IC

#	02897778	S-80130ALMC-JAP-T2	RESET IC	IC8	1
	02565501	TC220CCA0AF-B01(MR3)	IC (DSP)	IC5	1
	01906156	S-8520E33MC-BJS-T2	IC (DC-DC REGULATOR)	IC7	1
#	02898690	MN101C427RH BF-3 V1.00(MASK)	IC (CPU)	IC6	1
	15189261	M5218AFP-600E	IC (BIPOLAR OP AMP)	IC1	1
	00346445	NJM2100M(TE3)	IC (BIPOLAR OP AMP)	IC2	1
	02451434	AK4552VT	IC (AD/DA)	IC4	1

TRANSISTOR

	15309104	2SA1586-GR(TE85R)	TRANSISTOR	Q11,Q12	2
	15319108	2SC-3324GR-TE85R	TRANSISTOR	Q6,Q9	2
	15319107	2SC4116-GR(TE85R)	TRANSISTOR	Q2,Q7,Q10,Q13	4
	F5329502	2SJ190	FET	Q14	1
#	F5329530	FET 2SK879Y	FET	Q1,Q3,Q5,Q8	4
	15329103T0	2SK880-GR(TE85R)	FET	Q4	1

DIODE

	15029342	GL3ED8	LED	LED1	1
#	F5339201	GS1G	DIODE	D2,D3	2
	15339121	1SS301(TE85R)(CHIP)	DIODE	DA1,DA2	2
	F5339137	SS14 VF=0.45V	DIODE	D4	1

RESISTOR

	00566867	RPC05T 100 J	MTL.FILM RESISTOR	R29	1
	00567156	RPC05T 102 J	MTL.FILM RESISTOR	R14,R31,R51,R53	4
	00567289	RPC05T 103 J	MTL.FILM RESISTOR	R8,R13,R18,R25,R28,R35,R45,R47,R60,R61,R64,R	12
	00567412	RPC05T 104 J	MTL.FILM RESISTOR	R19,R36,R37,R38,R52	5

RESISTOR					
	00567556	RPC05T 105 J	MTL.FILM RESISTOR	R1,R3,R10,R15,R16,R17,R21,R32,R34,R50,R71	11
	00567067	RPC05T 221 J	MTL.FILM RESISTOR	R40,R42	2
	00567190	RPC05T 222 J	MTL.FILM RESISTOR	R46	1
	00567323	RPC05T 223 J	MTL.FILM RESISTOR	R4,R6,R7,R11,R22,R30,R43,R44	8
	00567334	RPC05T 273 J	MTL.FILM RESISTOR	R49	1
	00567367	RPC05T 393 J	MTL.FILM RESISTOR	R41	1
	00566967	RPC05T 470 J	MTL.FILM RESISTOR	R63,R70	2
	00567389	RPC05T 563 J	MTL.FILM RESISTOR	R2,R5,R9,R12,R20,R23,R27,R39	8
	F5429365	10K OHM F RANK (1%)	CHIP RESISTOR	R26	1
	F5429386	150K F (1608TYPE)	CHIP RESISTOR	R24	1
POTENTIOMETER					
#	F3279852	RD901-20-15FW-B54-006	POTENTIOMETER	VR2,VR3(RATE, DEPTH)	2
#	F3279853	RD901-20-15FW-B54-04D	POTENTIOMETER	VR4(MODE)	1
#	F3279854	RD912D-20-20FWH-B54-6009	POTENTIOMETER	VR1(RES MANUAL)	1
CAPACITOR					
#	13549329M0	ECQ-B1H104KF3	POLYEST. CAPACITOR	C6	1
#	01674690	ECJ1VF1E683Z(1608TYPE)	CHIP CAPACITOR	C53	1
	13639546M0	ECEA1CKA100B 10UF/16V	CHEMICAL CAPACITOR	C8,C9,C12,C13,C17,C20,C22,C25,C26	9
	13639550M0	ECEA1CKA101B 100UF/16V	CHEMICAL CAPACITOR	C30,C37,C40,C44	4
	13639549M0	ECEA1CKA470B	CHEMICAL CAPACITOR	C18,C41,C42,C51	4
	13639602M0	ECEA1HKA010B UF 50V	CHEMICAL CAPACITOR	C1,C10,C11,C23,C24,C28	6
	01674701	ECJ1VF1E104Z 0.1UF/16VK	CERAMIC CAPACITOR(CHIP)	C19,C21,C27,C29,C31,C33,C34,C35,C36,C38,C39,	21
	01674512	ECJ1VB1H222K	CERAMIC CAPACITOR	C2,C5,C14	3
	01674689	ECJ1VF1H473Z	CERAMIC CAPACITOR	C3,C15	2
	01674334	ECUV1H101JCV	CERAMIC CAPACITOR	C4,C7,C16	3
	01674467	ECUV1H102JCV	CERAMIC CAPACITOR	C62	1
	01674201	ECUV1H180JCV	CERAMIC CAPACITOR	C56	1
	01674212	ECUV1H220JCV	CERAMIC CAPACITOR	C57	1
INDUCTOR,COIL,FILTER					
	F2449209	SLF7032T-151MR29-2(150UH)	COIL	L3	1
	F2449210	SLF7032T-4R7M1R7-2(4.7UH)	COIL	L2	1
CRYSTAL,RESONATOR					
	02673278	CX-49G 11.2896MHZ	CRYSTAL	X1	1
WIRING,CABLE					
#	G3477166	FLAT CABLE	7P-100X6X6 P=2.0		1
#	G3477165	FLAT CABLE	3P-70X6X6 P=2.0		1
SCREWS					
	H5029820	SCREW M3X10	THUMB SCREW		1
	H5029325	SCREW 3X6	PAN HEAD TAPTITE-2 BZC		5
	H5039205	WASHER 12.5X9.5X0.5/0.9	INTERNAL TOOTH FENI		4
	H5039510	NUT M9X12X2	FENI		4
#	H501941301	SCREW 3X10MM	BINDING MACHINE FEBC		2
	H5039104	JACK WASHER M9.2X14X1.6	AL		1
	22137709	JACK SPACER M9.6X14X1.0			1
#	H5039401	NYLON WASHER 3X6X0.5			2
	H5039112	WASHER M9			4
	40010267	SCREW 3X10	BINDING MACHINE FEBZC		2
PACKING					
	G2627738	INNER BOX			1
#	G2627141	PACKING CASE			1
MISCELLANEOUS					
#	F2559702	POLYSWITCH	RXE010	R100	1
#	H2369451	LED SPACER	LEDH-5 5MM 3P		1
	G253751603	BOTTOM CAUTION PSA	FCC/CE/C-TICK/EMC GRY		1
	40016512	INSULOK TIE	80M/M T-18S		2
	2226733300	CUSHION	267-333		1
	2253753801	PSA CAUTION	253-538		1
	2215770201	PEDAL GUIDE BUSH	215-702		1
	2217710900	COIL SPRING	214-109		1
	F3419102	BATTERY CONNECTOR			1
	G2267201	CUSHION (A)			1
	22257257	EARTH TERMINAL		ET1,ET2	2
	G2167301	INSULATION SPACER			1

ACCESSORIES (Standard)

#	G6017304	OWNER'S MANUAL	JAPANESE	1
#	G6017305	OWNER'S MANUAL	ENGLISH	1

TEST MODE

Instruments and Other Items Required

- Oscillator
- Oscilloscope
- Noise meter
- 47 k ohm short-plug
- Monitor speaker

Test Items

1. DSP, CPU Check
2. RES Volume Check (LED check included)
3. MANUAL Volume Check (LED check included)
4. DEPTH Volume Check (LED check include)
5. RATE Volume Check (LED check included)
6. CODEC (DAC) Check (MODE volume and jack-switch checks included)
7. CODEC (ADC) Lch Check (MODE volume check included)
8. CODEC (ADC) Rch Check (MODE volume and battery-operation checks included)
9. Noise Check

How to Enter Test Mode

1. Set all volume controls at their minimum positions.
2. Connect a DC plug to the adapter jack while pressing the pedal.
3. "CHECK" (amber) lights up, and you are in Test mode.

NOTE

You cannot enter Test mode unless all the volume controls are at their minimum positions. You cannot enter Test mode if the minimum values of all the volume controls are not detected due to some defect or other cause.

NOTE

As for how to test only a specific item skipping other test items, refer to "5. How to Test a Specific Item Only" described below after contents of tests are explained.

Contents of Tests

1. Check of DSP and CPU

1. Release pedal.
2. The system checks the DSP and CPU automatically. "CHECK" LED (green) lights up if no problem is found; "CHECK" (red) blinks if an error is found.
3. Check waveforms output from both OUTPUTs A and B on the oscilloscope.
Input square waves (200 Hz, 1 Vp-p) into GUITAR IN from the oscillator, and check that the same square waves (200 Hz, 1 Vp-p, DSP through) as shown in the figure are output.

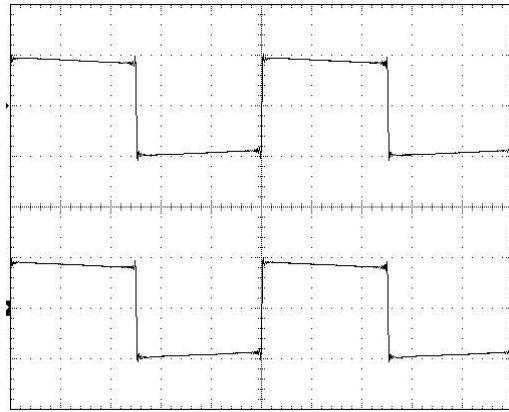

500 mV/DIV, 1 ms/DIV

4. If "CHECK" LED (green) is lit, you are already in the next step of testing.

* If "CHECK" LED (red) blinks, operation stops, and you cannot go to the next step. Possible causes include defect related to the DSP or CPU, and defective soldering. Remove the DC plug from the adapter jack, and turn off the power of the machine.

2. RES Volume Check(LED check included)

1. Turn the volume control from the minimum position to the middle and then to the maximum position clockwise. The "CHECK" LED changes from green to amber, and then to green.
2. When the volume control reaches the maximum position, "CHECK" (green) light up, and the MANUAL volume check starts automatically.

* The maximum RES volume value and the minimum MANUAL volume value are detected at the same time. Check the RES volume with the MANUAL volume control at the minimum position.

3. MANUAL Volume Check (LED check included)

1. Turn the volume control from the minimum position to the middle and then to the maximum position clockwise. The "CHECK" LED changes from green to amber, and then to green.
2. When the volume control reaches at maximum position, "CHECK" (green) lights up, and the DEPTH volume check starts automatically.

NOTE

The maximum MANUAL volume value and the minimum DEPTH volume value are detected at the same time. Check MANUAL volume with the DEPTH volume control at the minimum position.

4. DEPTH Volume Check(LED check included)

1. Turn the volume control from the minimum position to the middle and then to the maximum position clockwise. The "CHECK" LED changes from green to amber, and then to green.
2. When the volume control reaches the maximum position, "CHECK" (green) lights up, and the RATE volume check starts automatically.

NOTE

The maximum DEPTH volume value and the minimum RATE volume value are detected at the same time. Check DEPTH volume with the RATE volume control at the minimum position.

5. RATE Volume Check(LED check included)

1. Turn the volume control from the minimum position to the middle and then to the maximum position clockwise. The "CHECK" LED changes from green to amber, and then to green.
2. When the volume control reaches the maximum position, "CHECK" (green)lights up.

6. CODEC (DAC) Check(Check of MODE volume and jack-switch included)

1. Position MODE volume at "GATE/PAN".
2. Check that "CHECK" LED (amber) is lit.
3. Connect a plug to GUITAR IN. (Waves are output even if no signal is input.)
4. Check the waveforms output from both OUTPUTs A and B on the oscilloscope.
Check that the output waveforms are the same square waves (200 Hz, 1 Vp-p) as those shown in the figure.

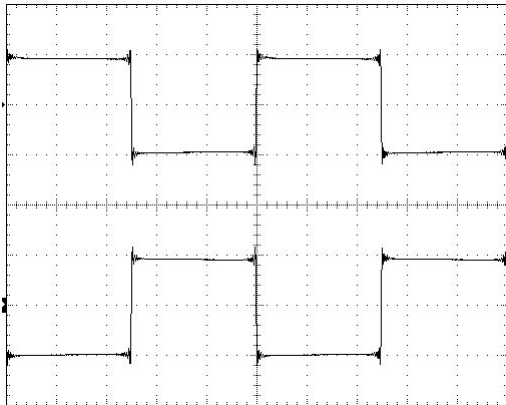

500mV/DIV, 1mS/DIV

5. To check the GUITAR IN jack-switch, remove the plug from GUITAR IN and connect it to BASS IN.
6. Check the waveforms output from both OUTPUTs A and B on the oscilloscope. Check that the output waveforms are the same square waves (400 Hz, 1 Vp-p) as those shown in the figure.

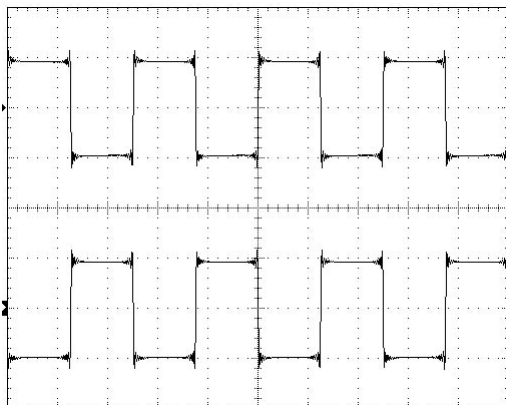

500 mV/DIV, 1 mS/DIV

7. To check the OUTPUT B jack-switch, remove the plug from OUTPUT B.
8. Check the waveforms output from OUTPUT A on the oscilloscope.

Check that the output waveforms are the same step-like waves (1Vp-p) as those shown in the figure.

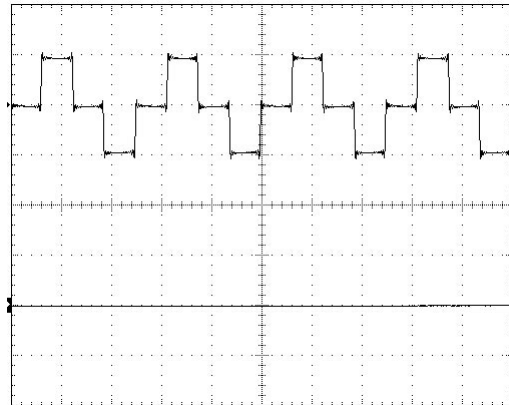

500 mV/DIV, 1 mS/DIV

7. CODEC (ADC) Lch Check (MODE volume check included)

1. Set MODE volume at "STANDARD".
2. Check that "CHECK" LED (green) is lit.
3. Input 1kHz, -20dB sine waves into BASS IN from the oscillator.
4. Check the waveforms output from both OUTPUTs A and B on the oscilloscope.
Check that the output waveforms are the same as those shown in the figure.

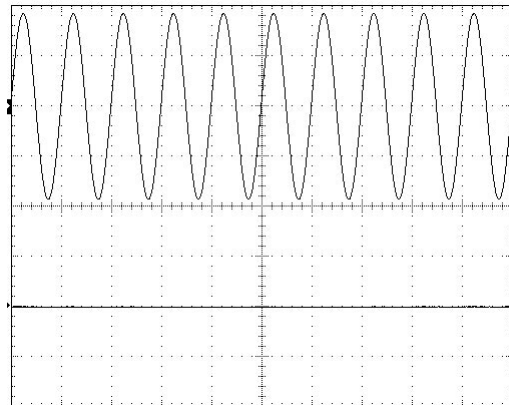

OUTPUT A : 50mV/DIV, OUTPUT B : 500mV/DIV, 1mS/DIV

5. Measure the output levels of both OUTPUTs A and B with a noise meter (JIS-A).
Check that the output from OUTPUT A is between -22.5 dbm and -20.5 dBm, and the output from OUTPUT B is -100 dBm or lower.

8. CODEC (ADC) Rch Check(Check of MODE volume and battery operation included)

1. Set MODE volume at "ULTRA".
2. Check that "CHECK" LED (amber) is lit.
3. Input 1kHz, -20dB sine waves into BASS IN from the oscillator.

4. Check the waveforms output from both OUTPUTs A and B on the oscilloscope.
Check that the output waveforms are the same as those shown in the figure and that they are not distorted.

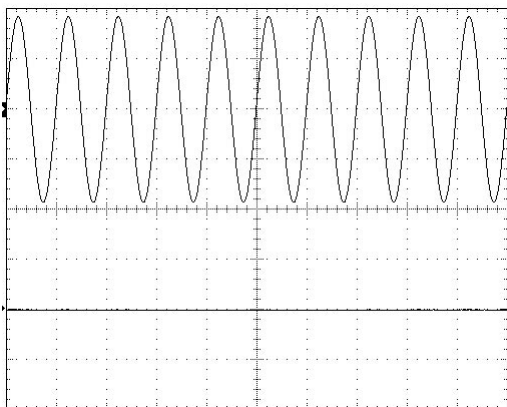

OUTPUT A : 50 mV/DIV, OUTPUT B : 500 mV/DIV, 1mS/DIV

5. Measure the output levels of both OUTPUTs A and B with a noise meter (JIS-A).
Check that the output levels are the same as those shown in Test Item 7 above.
6. Remove the DC plug quickly from the adapter jack, and check battery operation.

NOTE

Remove the plug quickly, or the machine will be reset. If the machine is reset every time you remove the plug, the adapter jack contact or some other part may be defective.

7. Check that the same waveforms are output and that "CHECK" LED (red) is lit.

NOTE

If the battery is exhausted, LED will light up gloomily.

8. Check again that the output waveforms are not distorted.
9. Remove the plug from BASS IN, and check that the "CHECK" LED goes out with no waveforms shown (power off).

9. Noise Check

1. Connect a DC plug to the adapter jack, and a 47 k Ω short-plug to GUITAR IN.
2. Set all the volume controls at to their maximum positions.
3. Check that "CHECK" LED (red) is lit.
4. Measure the residual noise of both OUTPUTs A and B with a noise meter (JIS-A).
Check that the noise is -92 dBm or lower.
5. Press the pedal to turn off the "CHECK" LED (to form a bypass).
6. Measure the residual noise of both OUTPUTs A and B with a noise meter (JIS-A).
Check that the noise is -100 dBm or lower.
7. Connect a monitor speaker to OUTPUT.
8. Drop the machine twice from a height of 10 cm to apply it shock.
Check that no abnormal noise occurs.
9. Turn the pedal on and off and turn each volume control, then check that no abnormal noise occurs.

How to Exit Test Mode

1. Press the pedal to exit Test mode.
During volume checks 2 through 5, however, you exit volume check if you press the pedal.
Press the pedal again to exit Test mode.

NOTE

If an error is found during the DSP or CPU check mentioned in Test Item 1 above, you cannot exit Test mode by pressing the pedal. Remove the DC plug from the adapter jack, and turn off the power of the machine.

NOTE

The noise check mentioned in "9. Noise check" above is not done in Test mode, it is done in Normal mode.

How to Test a Specific Item Only

1. Enter Test mode.
2. Release pedal. The system checks the DSP and CPU automatically as mentioned in "1. Check of DSP and CPU" above. The "CHECK" LED (green) light up if no problem is found.
3. Choose the next test item you want with MODE volume.

MOMENTARY: 2. - 5. Volume check
GATE/PAN: 6. CODEC(DAC)check
STANDARD: 7. CODEC(ADC)L ch check
ULTRA: 8. CODEC(ADC)R ch check

NOTE

You can only do a volume check in the following order: RES -> MANUAL -> DEPTH -> RATE.

NOTE

If you do the noise check mentioned in "9. Noise check" above, don't enter Test mode, but do it in Normal mode after turning on the power of the machine.

NOTE

Be sure to check all the test items before you ask for repair or when you check and service the machine.

CIRCUIT BOARD

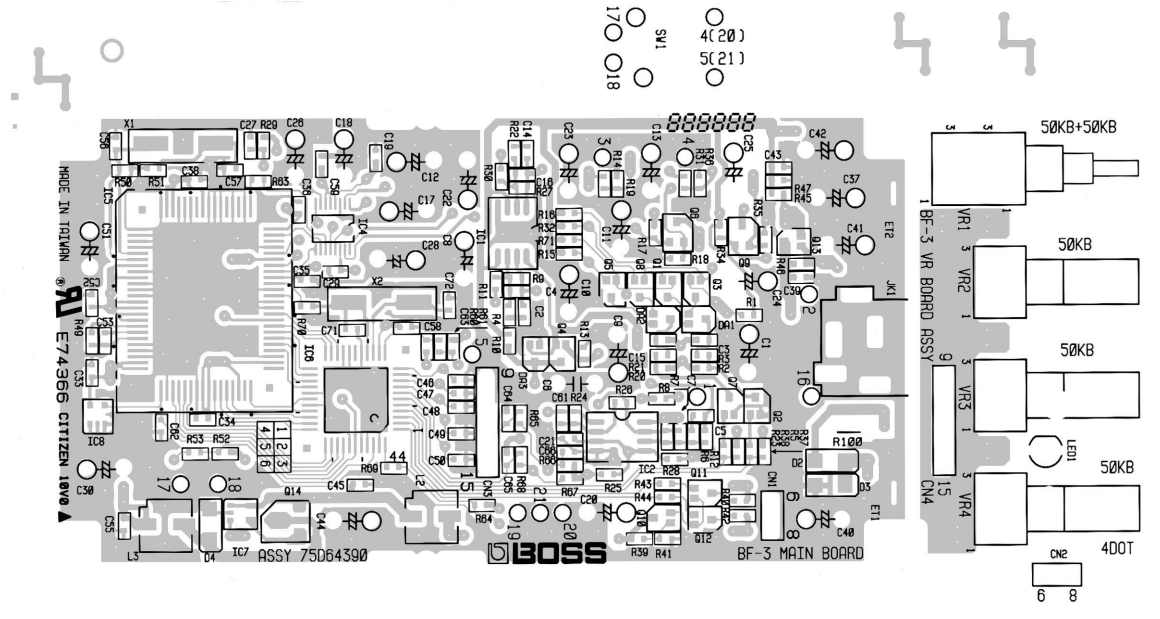

View from components side

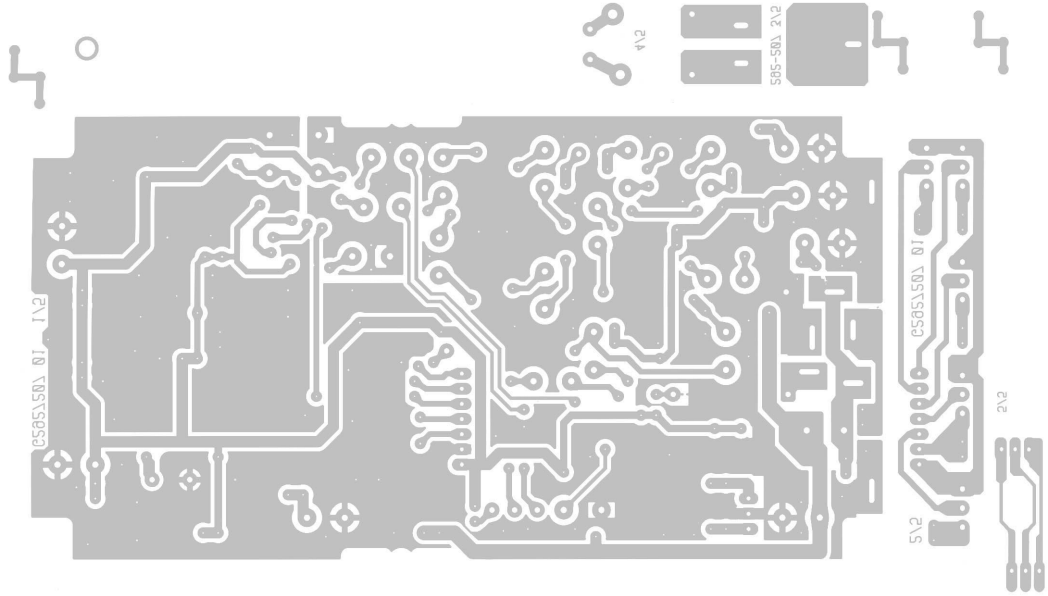

View from foil side

CIRCUIT DIAGRAM

