

DD-7

Digital Delay

SERVICE NOTES

Issued by RJA

Table of Contents

Cautionary Notes	2	Verifying the Version Number	8
Main Specifications	3	Performing a Factory Reset	8
Location of Controls	4	Updating the System	8
Location of Controls Parts List	4	Test Mode	9
Exploded View	5	Circuit Board (Main Board)	17
Exploded View Parts List	5	Circuit Diagram (Main Board: Analog)	18
Parts List	6	Circuit Diagram (Main Board: Digital)	20

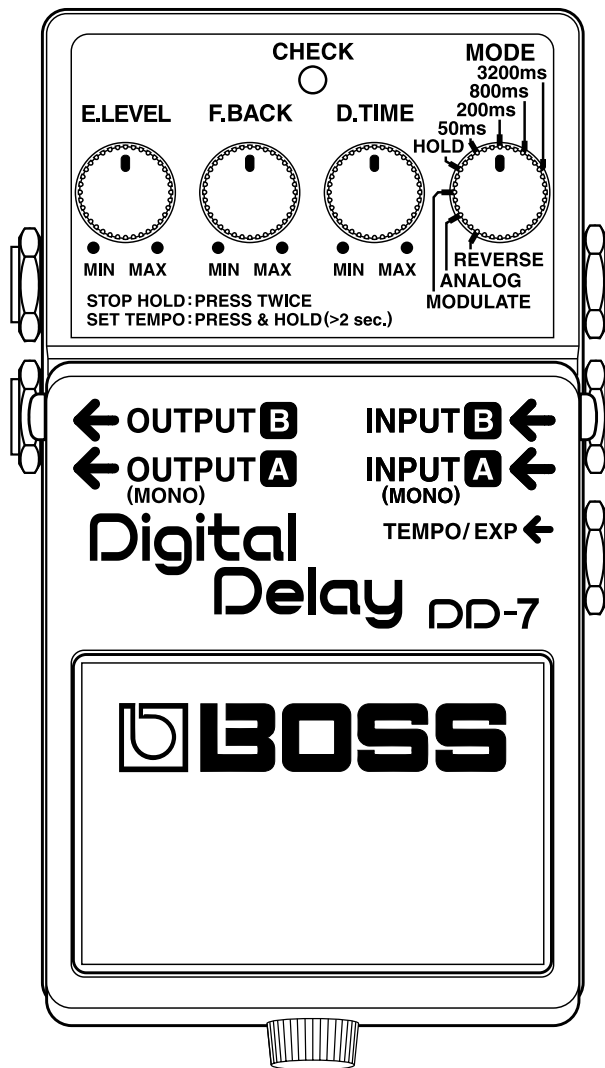

Copyright © 2008 Roland Corporation

All rights reserved. No part of this publication may be reproduced in any form without the written permission of Roland Corporation.

Cautionary Notes

Before beginning the procedure, please read through this document. The matters described may differ according to the model.

No User Data

This product cannot save user data. Backing up user data during servicing is not required.

Parts List

A component whose part code is ***** cannot be supplied as a service part because one of the following reasons applies.

- Because it is supplied as an assembled part (under a different part code).
- Because a number of circuit boards are grouped together and supplied as a single circuit board (under a different part code).
- Because supply is prohibited due to copyright restrictions.
- Because reissuance is restricted.
- Because the part is made to order (at current market price).

Circuit Diagram

In the circuit diagram, "NIU" is an abbreviation for "Not in Use," and "UnPop" is an abbreviation for "Unpopulated." They both mean non-mounted components. The circuit board and circuit board diagram show silk-screened indications, but no components are mounted.

Main Specifications

DD-7: Digital Delay

Nominal Input Level

-20 dBu

Input Impedance

1 M Ω

Nominal Output Level

- 20 dBu

Output Impedance

1 k Ω

Recommended Load Impedance

10 k Ω or greater

Delay Time

1 ms to 6400 ms

* Values may vary according to the mode and connections.

Maximum Recording Time

40 seconds (in HOLD mode)

Controls

Pedal switch

E.LEVEL knob, F.BACK knob, D.TIME knob, MODE knob

Indicator

CHECK indicator

(Used for indication of TEMPO, HOLD, and to check battery)

Connectors

INPUT-A (MONO) jack, INPUT-B jack

OUTPUT-A (MONO) jack, OUTPUT-B jack

TEMPO/EXP jack, AC adaptor jack (DC 9 V)

Power Supply

DC 9 V:

Dry battery 6F22 (9 V) type (carbon)

Dry battery 6LR61 (9 V) type (alkaline)

AC Adaptor (PSA-series: optional)

Current Draw

55 mA (DC 9 V)

Expected battery life under continuous use:

Carbon: 1.5 hours

Alkaline: 6 hours

* These figures will vary depending on the actual conditions of use.

Dimensions

73 (W) x 129 (D) x 59 (H) mm

2-7/8 (W) x 5-1/8 (D) x 2-3/8 (H) inches

Weight

440 g / 1 lb (including battery)

Accessories

Owner's Manual English (#G2507366R0)

Mode Sticker (#G2547154R0)

Application Sticker (#G2547160R0)

Leaflet ("USING THE UNIT SAFELY," "IMPORTANT NOTES," and "Information") (#*****)

Dry battery /9 V type (6LR61) (#*****)

* The battery that was supplied with the unit is for temporary use-intended primarily for testing the unit's operation.

We suggest replacing this with an alkaline dry cell.

Options

AC adaptor (PSA-series)

* 0 dBu = 0.775 Vrms

* In the interest of product improvement, the specifications and/or appearance of this unit are subject to change without prior notice.

Location of Controls

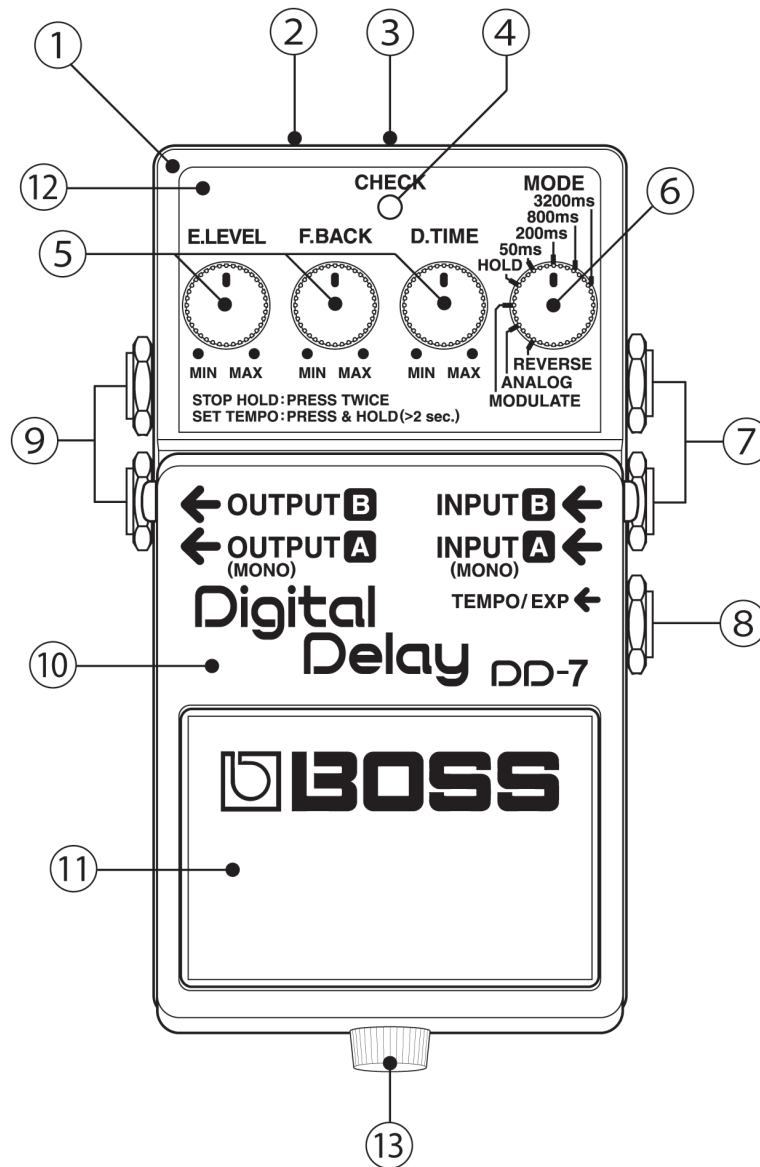

Location of Controls Parts List

No.	Part Code	Part Name	Description	Q'ty
1	75E593C0R0	CASE		1
2	G2537516R0	PSA CAUTION	CE 9V N225	1
3	13449717	ADAPTOR JACK	HEC2392-01-150	1
4	F5029423R0	LED	L-3VEGW	1
5	G2477127R0	ROUND KNOB	D-CUT (BLUE/BLACK)	3
	F3279852R0	POTENTIOMETER	RD901-20-15FW-B54-006	3
6	G2477127R0	ROUND KNOB	D-CUT (BLUE/BLACK)	1
	F3229206R0	POTENTIOMETER	RD901-20-15FW-B50K-08Q7 8CLIC	1
7	F3449150R0	JACK (STEREO+SW)	2LJ-650NHW00	2
8	03344701	6.5MM JACK	HTJ-064-12DS	1
9	13449140R0	JACK(STEREO)	HTJ-064-14D	2
10	75E592T0R0	PEDAL		1
11	22357304R0	PEDAL PLATE		1
12	G2217798R0	PANEL PLATE		1
13	40125101	THUMB SCREW	M3X10 FE ZC	1

Exploded View

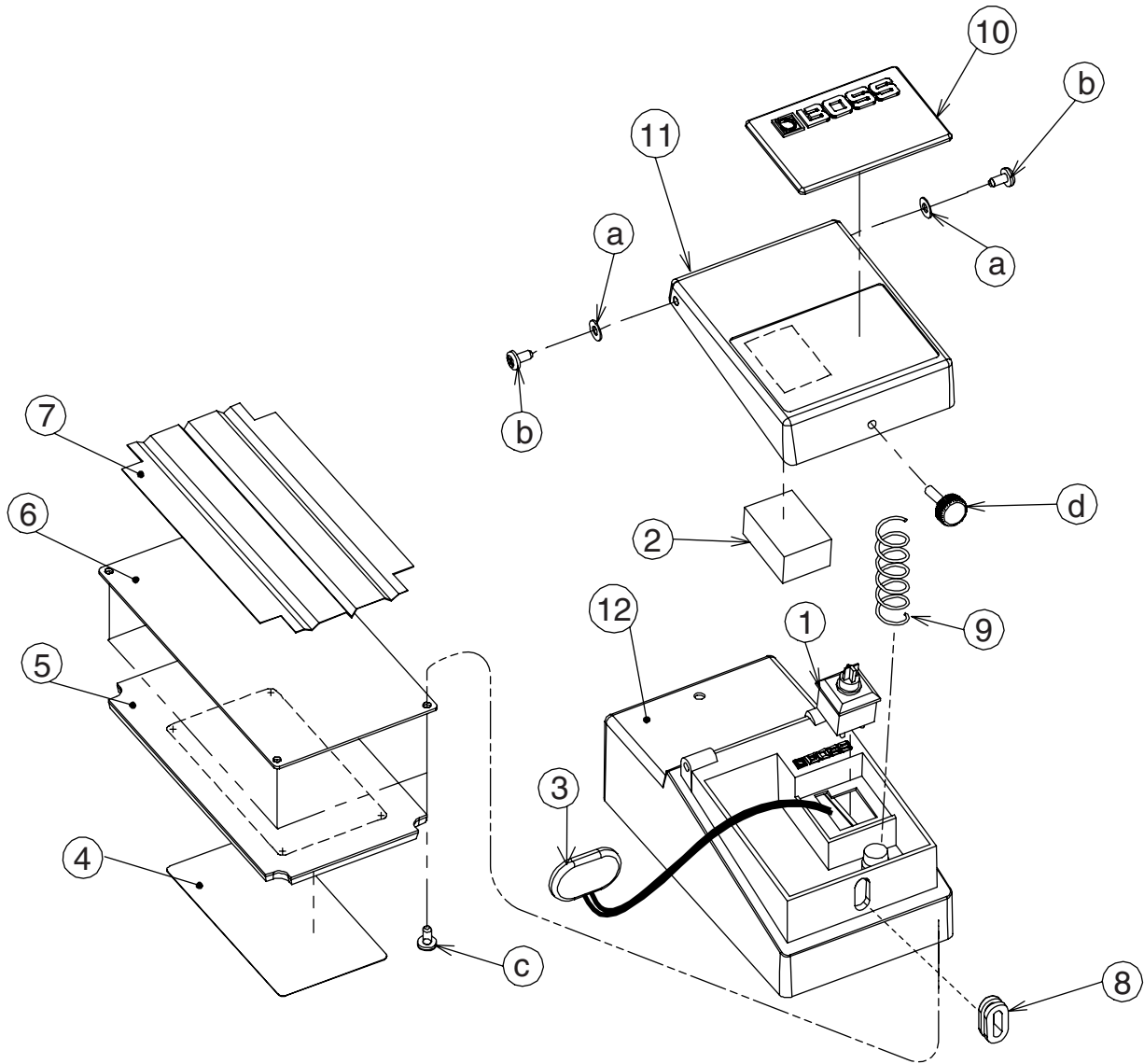

Exploded View Parts List

No.	Part Code	Part Name	Description	Q'ty
1	13129710R0	SWITCH(PUSH)	JM-0404	1
2	22267333R0	CUSHION		1
3	F3419102R0	BATTERY CONNECTOR	006P BATTERY SNAP	1
4	G2537516R0	PSA CAUTION	CE 9V N225	1
5	22357305R0	BOTTOM BASE		1
6	22027851R0	BOTTOM COVER		1
7	G2167301R0	INSULATING SHEET		1
8	22157702R0	PEDAL GUIDE BUSH		1
9	22177109R0	COIL SPRING		1
10	22357304R0	PEDAL PLATE		1
11	75E592T0R0	PEDAL		1
12	75E593C0R0	CASE		1
a	40125134	NYLON WASHER 3X6X0.5		2
b	H5019413R0	SCREW M3X10	BINDING MACHINE FEBC	2
c	H5029325R0	SCREW 3X6	B1FEBC	4
d	40125101	THUMB SCREW	M3X10 FE ZC	1

Parts List

SAFETY PRECAUTIONS:

The parts marked Δ have safety-related characteristics. Use only listed parts for replacement.

Due to one or more of the following reasons, parts with parts code ***** cannot be supplied as service parts.

- Part supplied only as a component in a complete assembly
- Copyright does not permit the part to be supplied
- Part is sold commercially

NOTE: The parts marked # are new. (initial parts) The description "Q'TY" means a necessary number of the parts per one product.

CASING				
	22357305R0	BOTTOM BASE		1
	22027851R0	BOTTOM COVER		1
#	75E593C0R0	CASE		1
#	G2217798R0	PANEL PLATE		1
#	75E592T0R0	PEDAL		1
	22357304R0	PEDAL PLATE		1
KNOB, BUTTON				
#	G2477127R0	ROUND KNOB	D-CUT (BLUE/BLACK)	4
JACK, EXT TERMINAL				
	03344701	6.5MM JACK	HTJ-064-12DS	1
#	F3449150R0	JACK (STEREO+SW)	2LJ-650NHW00	2
	13449140R0	JACK (STEREO)	HTJ-064-14D	2
	13449717	ADAPTOR JACK	HEC2392-01-150	1
SWITCH				
	13129710R0	SWITCH(PUSH)	JM-0404	1
PWB ASSY				
#	75E593P0R1	MAIN SHEET ASSY		1
		* This unit includes the following parts.		
	*****	MAIN BOARD		
	*****	VR BOARD		
	*****	INPUT BOARD		
	*****	CTL BOARD		
	*****	LED BOARD		
DIODE				
	F5029423R0	LED	L-3VEGW	1
RESISTOR				
	F5399101R0	MTL.FILM RESISTOR	0J (1608TYPE)	12
#	F5429516R0	MTL.FILM RESISTOR	1R0 J(1608TYPE)	12
POTENTIOMETER				
	F3279852R0	POTENTIOMETER	RD901-20-15FW-B54-006	3
#	F3229206R0	POTENTIOMETER	RD901-20-15FW-B50K-08Q7 8CLIC	1
CONNECTOR				
	F3419102R0	BATTERY CONNECTOR	006P BATTERY SNAP	1
WIRING, CABLE				
#	F3487015R0	WIRING	YELLOW 110X6EX6E (EXP)	1
	H4009408R0	WIRING 1007	WHITE 85X6X3	1
#	F3477063R0	WIRING	RIBBON CABLE 6P X80MM	1
	H4009498R1	WIRING 1P	VIOLET L=160MM	1
#	H4009305R0	WIRING	ORANGE 100X3X6 (OUTPUT)	1
	F3467053R0	WIRING 1007-26X3P	L=65MM CONNECT X 1	1
#	H4009610R0	WIRING	GREY 100X3X6 (OUTPUT)	1
	H4009499R1	WIRING 1P	GREEN L=160MM	1
	H4009597R0	WIRING 1007	BROWN 105X6X3	1
#	H4009458R0	WIRING	BLACK 45X6X6 (INPUT)	1
#	F3467058R1	INPUT WIRING	BOARD IN CONNECTOR	1

SCREWS				
	H5039158R0	WASHER M9X14X0.5T	NI	5
	40125101	THUMB SCREW	M3X10 FE ZC	1
	40125134	NYLON WASHER 3X6X0.5		2
	22137709R0	WASHER 9.6X14X1.0		1
#	G2137403R0	WASHER	HALF MOON SHAPE	1
	H5019413R0	SCREW M3X10	BINDING MACHINE FEBC	2
	H5029325R0	SCREW 3X6	B1FEBC	5
	H5039205R0	TOOTH WASHER	9.1X13	5
	H5039510R0	NUT M9X12X2T NI		5
	H5039521R0	NUT M7		4
PACKING				
	G2627738R0	INNER BOX		1
#	G2627793R0	PACKING CASE		1
MISCELLANEOUS				
	H2369451R0	LED SPACER	LEDH-5 5MM 3P	1
	G2537516R0	PSA CAUTION	CE 9V N225	1
	22177109R0	COIL SPRING		1
	22267333R0	CUSHION		1
	G2167301R0	INSULATING SHEET		1
	22157702R0	PEDAL GUIDE BUSH		1
	22257257R0	EARTH TERMINAL		2
ACCESSORIES (Standard)				
#	G6017474R0	OWNER'S MANUAL	JAPANESE	1
#	G2507366R0	OWNER'S MANUAL	ENGLISH	1
#	G2547154R0	MODE LABEL		1
#	G2547160R0	APPLICATION LABEL		1

Verifying the Version Number

1. Connect an AC adaptor.
2. Turn down all controls all the way counterclockwise.
3. Holding down the foot pedal and inserting a plug into the INPUT jack makes the CHECK LED light up.
 - * *Continue holding down the pedal until the LED goes dark.*

After approximately 2 seconds, the CHECK LED goes dark.

- * *The CPU and DSP checks are performed before the LED goes dark as just described. If a problem is found in the CPU, DSP, or the like, the LED may not go out.*

After approximately 1 second the CHECK LED flashes, and the number of flashes indicates the version.

1 flash:	Ver. 1.00
2 flashes:	Ver. 1.01
3 flashes:	Ver. 1.02

4. After the version display, execution shifts to the Test Mode.

Performing a Factory Reset

This product has no factory-reset feature.

Updating the System

A system update cannot be performed for this product. If an update is required, replace with an updated circuit board.

Test Mode

Items Required

- Oscillator x 2
- Oscilloscope x 1
- Noise meter x 2
- AC adaptor (PSA series device or 9 V DC power source) x 1
- Powered monitor x 2
- Expression pedal (EV-5) x 1
- 47-k Ω short plug x 2

Entering the Test Mode

1. Refer to the figure below and connect the measuring equipment to a connector other than the INPUT jack.

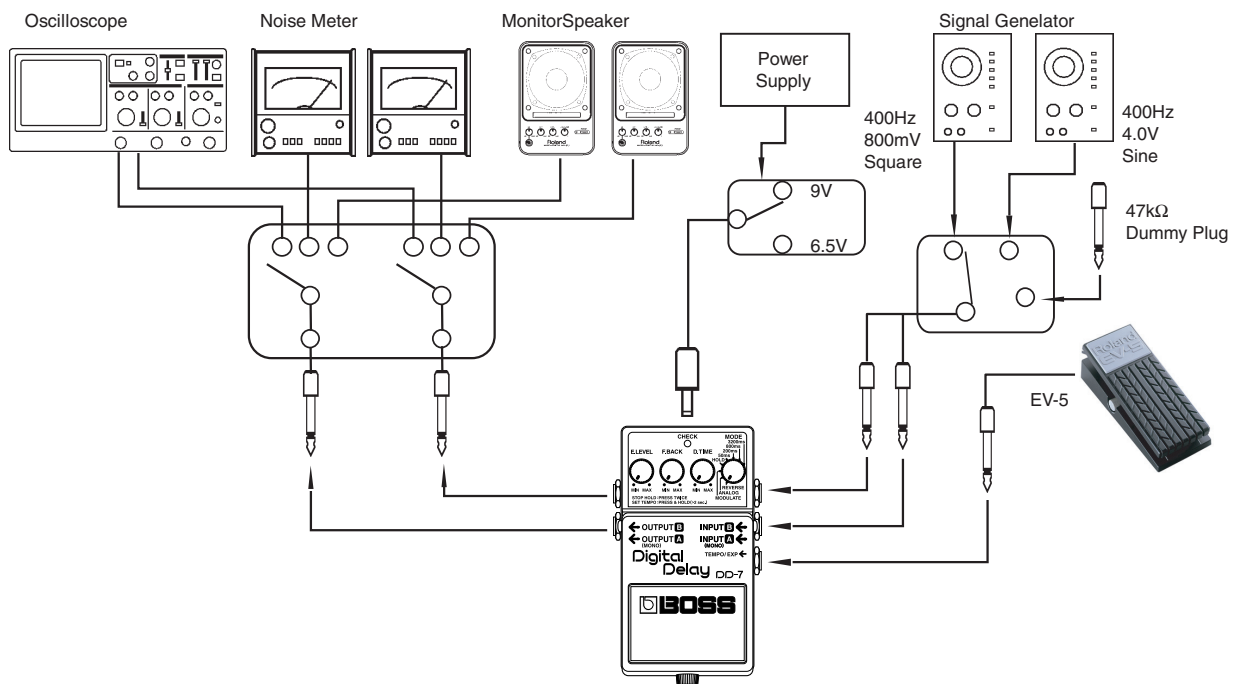

2. Turn down all controls all the way counterclockwise.
3. Holding down the foot pedal and inserting a plug into the INPUT jack makes the CHECK LED light up.

* Continue holding down the foot pedal until the LED goes dark.

After approximately 2 seconds, the CHECK LED goes dark.

* The CPU and DSP checks are performed before the LED goes dark as just described. If a problem is found in the CPU, DSP, or the like, the LED may not go out.

After approximately 1 second the CHECK LED flashes, and the number of flashes indicates the version.

1 flash: Ver. 1.00
 2 flashes: Ver. 1.01
 flashes: Ver. 1.02

4. Release the foot pedal.

Quitting the Test Mode

Pull out the plug from the INPUT jack and switch off the power.

Test Items

1. VR Check (E.LEVEL) (p. 10)
2. VR Check (F.BACK) (p. 10)
3. VR Check (D.TIME) (p. 11)
4. VR Check (MODE) (p. 12)
5. DA Check (EXP [Expression Pedal] Check) (p. 13)
6. DSP Through Check (INPUT B Check) (p. 14)
7. DSP Through Check (INPUT A Check) (p. 14)
8. DSP Through Check (OUTPUT A Check) (p. 15)
9. DSP Through Check (OUTPUT B Check) & CLIP Check (p. 15)
10. Residual Noise Check (p. 16)
11. Battery Operation Check (p. 16)

1. VR Check (E.LEVEL)

Make the connections shown below to the INPUT and OUTPUT jacks on the DD-7, using the settings indicated.

INPUT A: Input a rectangular wave at 400 Hz, 800 mVp-p.

INPUT B: Input a rectangular wave at 400 Hz, 800 mVp-p.

OUTPUT A: Connect the oscilloscope.

OUTPUT B: Connect the oscilloscope.

Set the oscilloscope to 500 mV/DIV, 1 ms/DIV, and coupling: DC.

1. Verify that the E.LEVEL control is turned down counterclockwise all the way. The CHECK LED lights up orange.

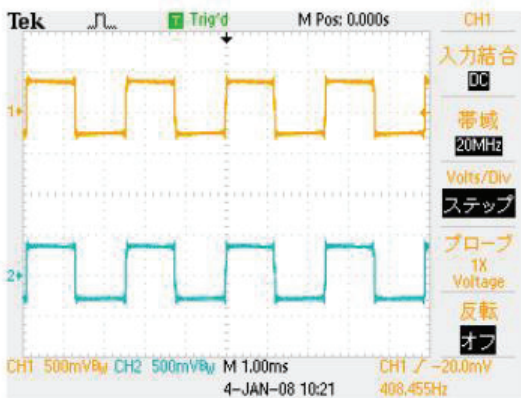

2. With the E.LEVEL control turned down counterclockwise all the way, turn it clockwise to the 9 o'clock position. Verify that the CHECK LED goes dark.
3. Turning the control all the way counterclockwise again makes the CHECK LED light up red.

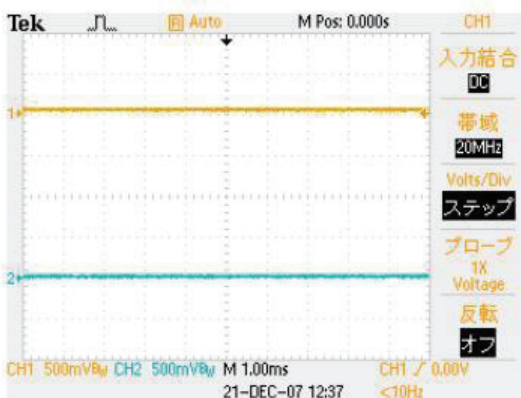

4. Adjust the E.LEVEL control to the 12 o'clock position. With the control turned down counterclockwise all the way, turn it clockwise to the 12 o'clock position, and verify that the CHECK LED goes dark. At the 12 o'clock position, the LED lights up red.

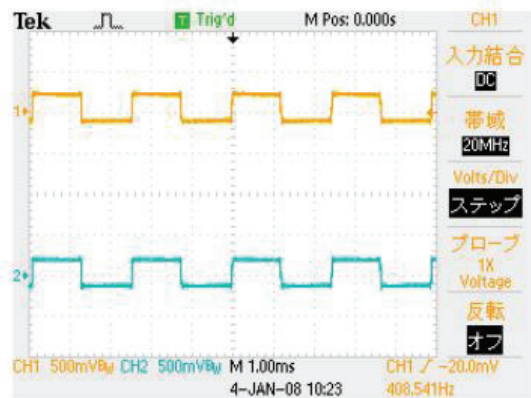

5. Turn the E.LEVEL control clockwise all the way. Verify that while the control is being turned all the way clockwise from the 12 o'clock position, the CHECK LED stays dark. When the control has been turned clockwise all the way, the LED lights up red.

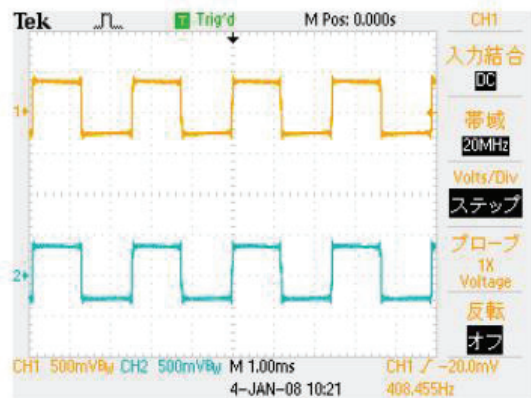

2. VR Check (F.BACK)

Make the connections shown below to the INPUT and OUTPUT jacks on the DD-7, using the settings indicated.

INPUT A: Input a rectangular wave at 400 Hz, 800 mVp-p.

INPUT B: Input a rectangular wave at 400 Hz, 800 mVp-p.

OUTPUT A: Connect the oscilloscope.

OUTPUT B: Connect the oscilloscope.

Set the oscilloscope to 500 mV/DIV, 1 ms/DIV, and coupling: DC.

1. Verify that the F.BACK control is turned down counterclockwise all the way. The CHECK LED lights up orange.

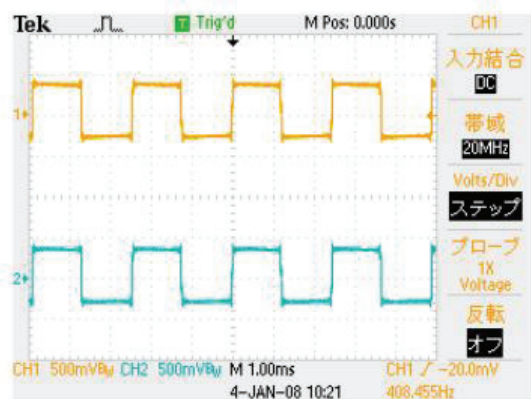

- With the F.BACK control turned down counterclockwise all the way, turn it clockwise to the 9 o'clock position. Verify that the CHECK LED goes dark.
- Turning the control all the way counterclockwise again makes the CHECK LED light up red.

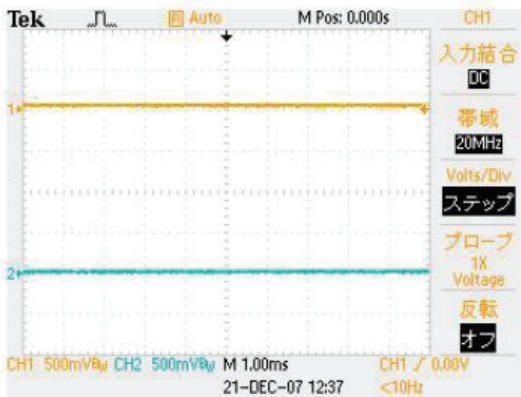

- Adjust the F.BACK control to the 12 o'clock position. With the control turned down counterclockwise all the way, turn it clockwise to the 12 o'clock position, and verify that the CHECK LED goes dark. At the 12 o'clock position, the LED lights up red.

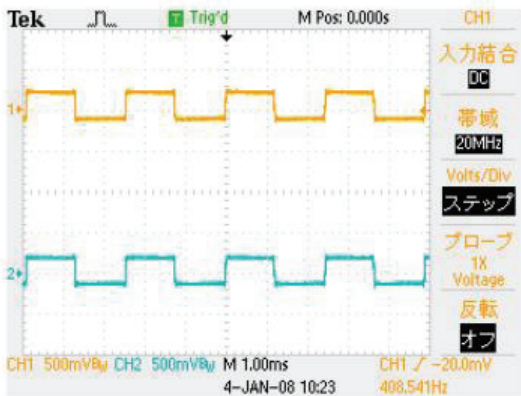

- Turn the F.BACK control clockwise all the way. Verify that while the control is being turned all the way clockwise from the 12 o'clock position, the CHECK LED stays dark. When the control has been turned clockwise all the way, the LED lights up red.

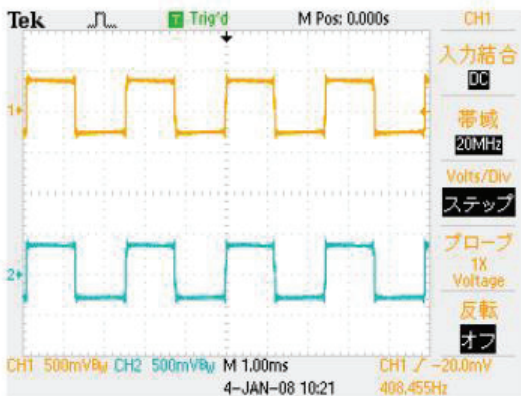

3. VR Check (D.TIME)

Make the connections shown below to the INPUT and OUTPUT jacks on the DD-7, using the settings indicated.

- INPUT A: Input a rectangular wave at 400 Hz, 800 mVp-p.
 - INPUT B: Input a rectangular wave at 400 Hz, 800 mVp-p.
 - OUTPUT A: Connect the oscilloscope.
 - OUTPUT B: Connect the oscilloscope.
- Set the oscilloscope to 500 mV/DIV, 1 ms/DIV, and coupling: DC.

- Verify that the D.TIME control is turned down counterclockwise all the way. The CHECK LED lights up orange.

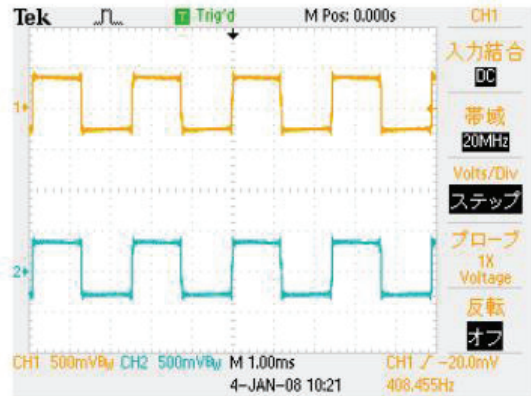

- With the D.TIME control turned down counterclockwise all the way, turn it clockwise to the 9 o'clock position. Verify that the CHECK LED goes dark.
- Turning the control all the way counterclockwise again makes the CHECK LED light up red.

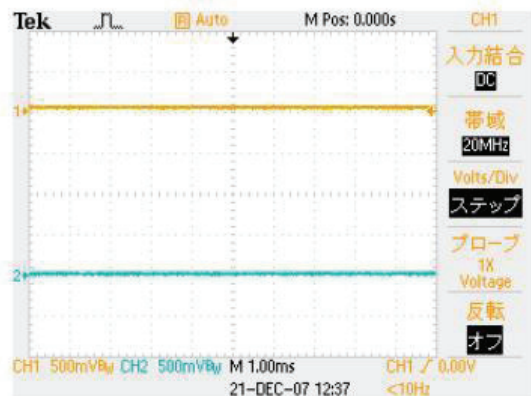

- Adjust the D.TIME control to the 12 o'clock position. With the control turned down counterclockwise all the way, turn it clockwise to the 12 o'clock position, and verify that the CHECK LED goes dark. At the 12 o'clock position, the LED lights up red.

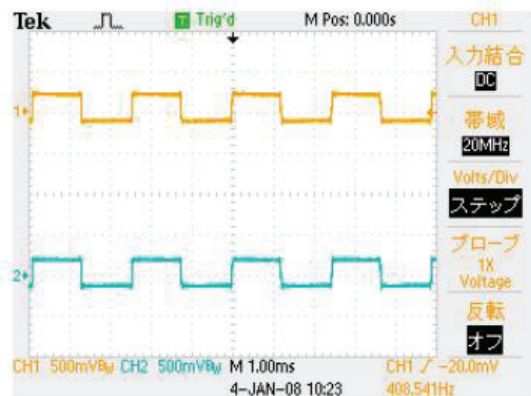

- Turn the D.TIME control clockwise all the way. Verify that while the control is being turned all the way clockwise from the 12 o'clock position, the CHECK LED stays dark. When the control has been turned clockwise all the way, the LED lights up red.

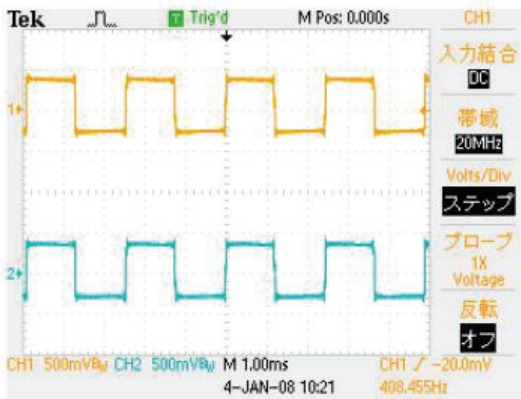

4. VR Check (MODE)

Make the connections shown below to the INPUT and OUTPUT jacks on the DD-7, using the settings indicated.

- INPUT A: Input a rectangular wave at 400 Hz, 800 mVp-p.
 - INPUT B: Input a rectangular wave at 400 Hz, 800 mVp-p.
 - OUTPUT A: Connect the oscilloscope.
 - OUTPUT B: Connect the oscilloscope.
- Set the oscilloscope to 500 mV/DIV, 1 ms/DIV, and coupling: DC.

- Verify that the MODE control is at the **REVERSE** position. Verify that waveforms like those shown in the figure below are output. The CHECK LED lights up orange.

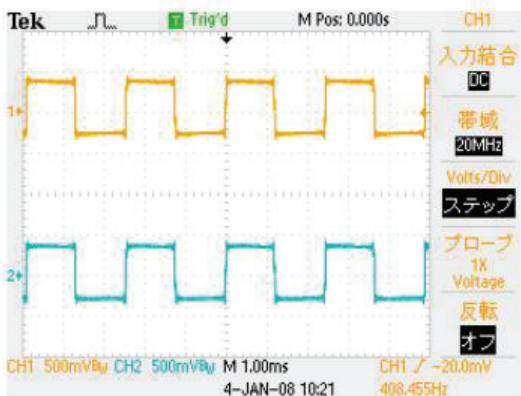

- Adjust the MODE knob to the **ANALOG** position. Verify that waveform output stops. The CHECK LED goes dark.

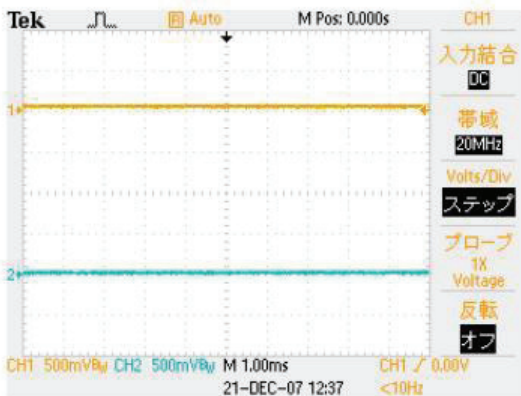

- Adjust the MODE knob to the **MODULATE** position. Verify that waveforms like those shown in the figure below are output. The CHECK LED lights up orange.

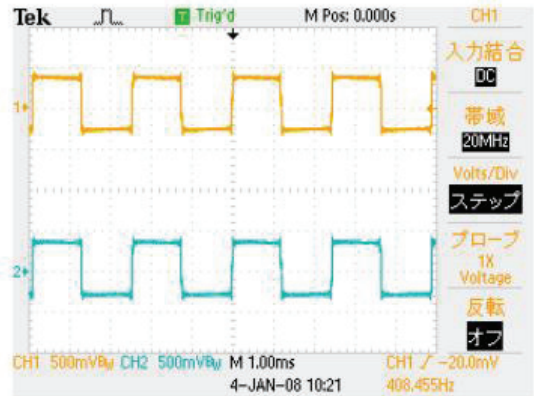

- Adjust the MODE control to the **HOLD** position. Verify that waveform output stops. The CHECK LED goes dark.

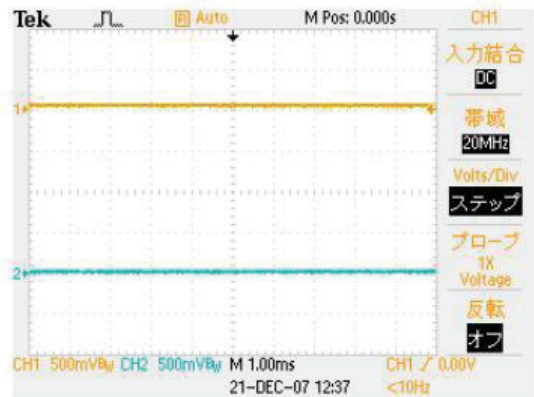

- Adjust the MODE control to the **50 ms** position. Verify that waveforms like those shown in the figure below are output. The CHECK LED lights up orange.

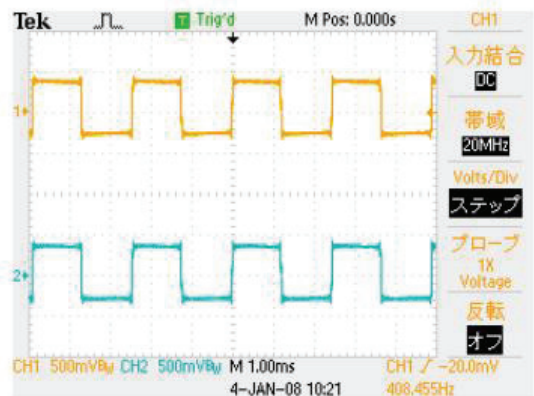

- Adjust the MODE control to the **200 ms** position. Verify that waveform output stops. The CHECK LED goes dark.

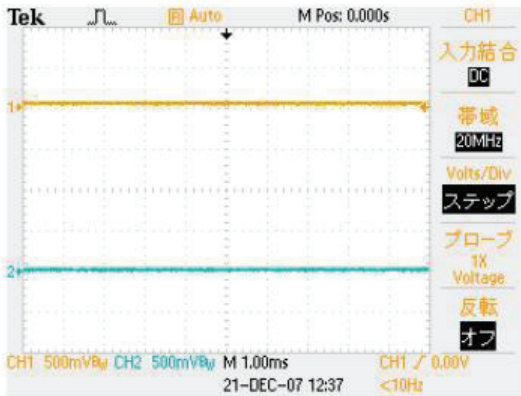

- Adjust the MODE control to the **800 ms** position. Verify that waveforms like those shown in the figure below are output. The CHECK LED lights up orange.

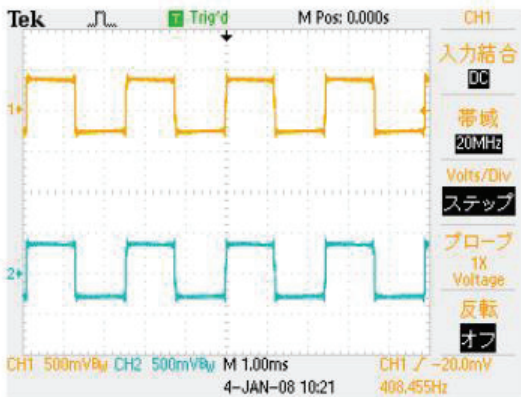

- Adjust the MODE control to the **3,200 ms** position. Verify that waveform output stops. The CHECK LED goes dark.

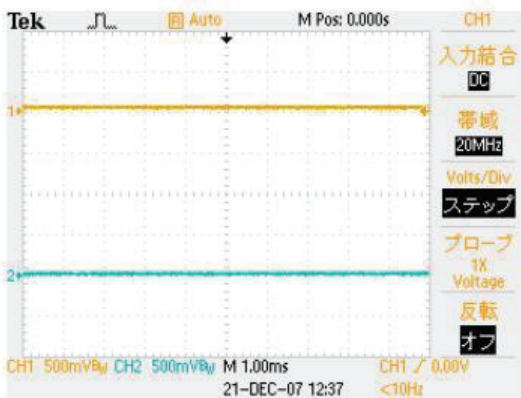

5. DA Check (EXP [Expression Pedal] Check)

Make the connections shown below to the INPUT and OUTPUT jacks on the DD-7, using the settings indicated.

- INPUT A: Input a rectangular wave at 400 Hz, 800 mVp-p.
 - INPUT B: Input a rectangular wave at 400 Hz, 800 mVp-p.
 - OUTPUT A: Connect the oscilloscope.
 - OUTPUT B: Connect the oscilloscope.
- Set the oscilloscope to 500 mV/DIV, 1 ms/DIV, and coupling: DC.

- Adjust the MODE control to the **800 ms** position. Verify that the CHECK LED is lighted up orange.
- Connect the EV-5 to the TEMPO/EXP jack. Verify that the CHECK LED is lighted up red.

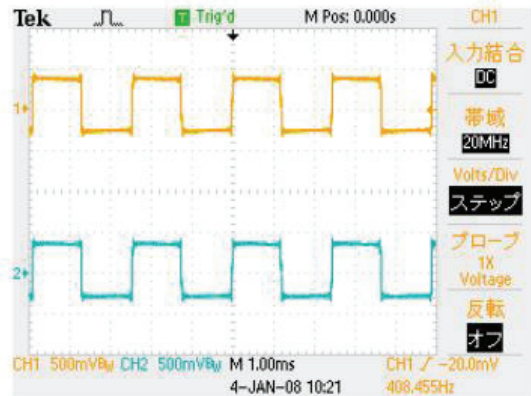

- Depress the heel of the EV-5 pedal all the way.

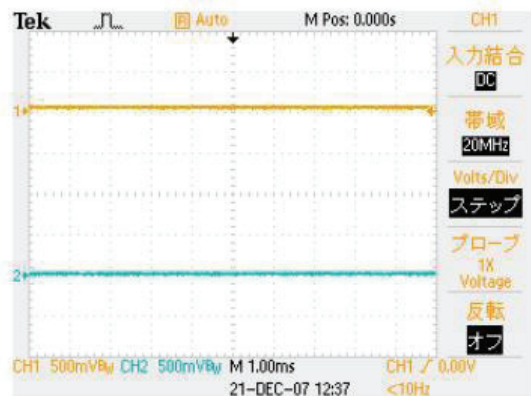

- Depress the toe of the EV-5 pedal, and stop when the intermediate position is reached. Verify that the CHECK LED is lighted up green.

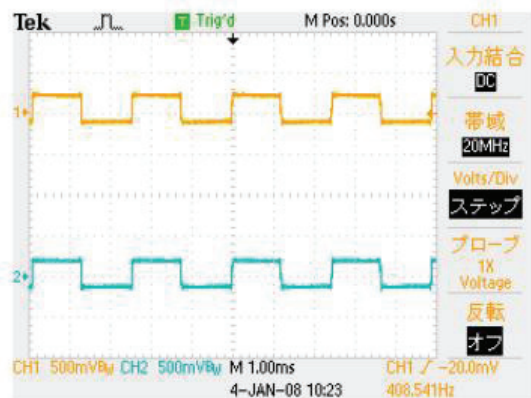

- Depress the toe of the EV-5 pedal all the way. Verify that the CHECK LED is lighted up red.

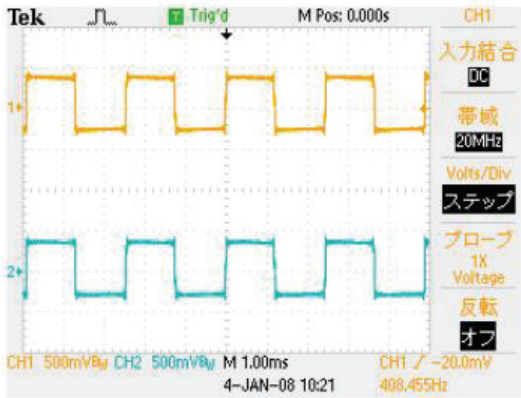

- Insert the plug into the INPUT B jack. Verify that the CHECK LED goes dark.

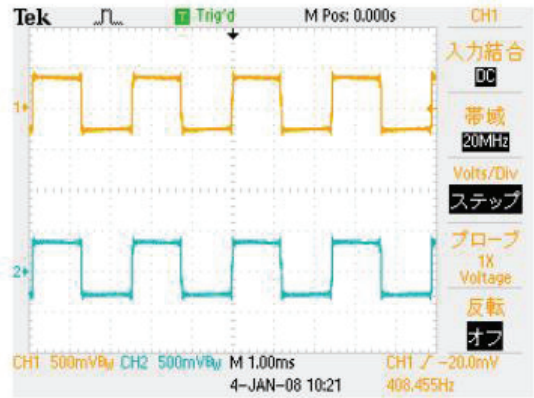

- Unplug the EV-5 from the jack.

6. DSP Through Check (INPUT B Check)

Make the connections shown below to the INPUT and OUTPUT jacks on the DD-7, using the settings indicated.

- INPUT A: Input a rectangular wave at 400 Hz, 800 mVp-p.
 - INPUT B: Input a rectangular wave at 400 Hz, 800 mVp-p.
 - OUTPUT A: Connect the oscilloscope.
 - OUTPUT B: Connect the oscilloscope.
- Set the oscilloscope to 500 mV/DIV, 1 ms/DIV, and coupling: DC.

- Adjust the MODE control to the **200 ms** position. Verify that the CHECK LED goes dark.

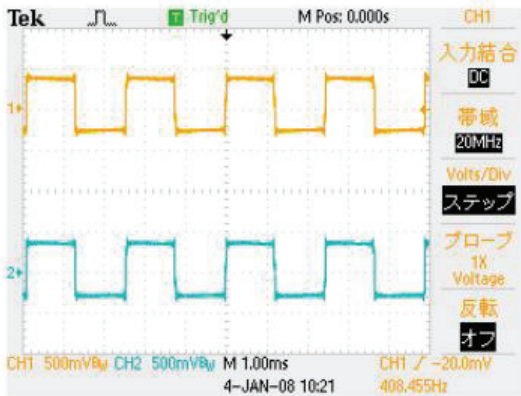

- Disconnect the plug from the INPUT B jack. Verify that the CHECK LED lights up green.

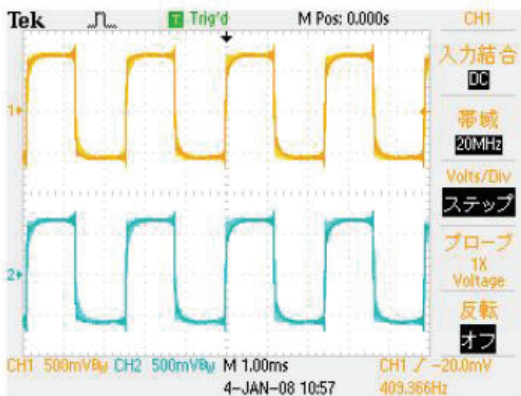

If the waveforms grow larger, operation is correct. If the waveforms show no change, operation is faulty.

7. DSP Through Check (INPUT A Check)

Make the connections shown below to the INPUT and OUTPUT jacks on the DD-7, using the settings indicated.

- INPUT A: Input a rectangular wave at 400 Hz, 800 mVp-p.
 - INPUT B: Input a rectangular wave at 400 Hz, 800 mVp-p.
 - OUTPUT A: Connect the oscilloscope.
 - OUTPUT B: Connect the oscilloscope.
- Set the oscilloscope to 500 mV/DIV, 1 ms/DIV, and coupling: DC.

- Adjust the MODE control to the **50 ms** position. Verify that the CHECK LED lights up orange.

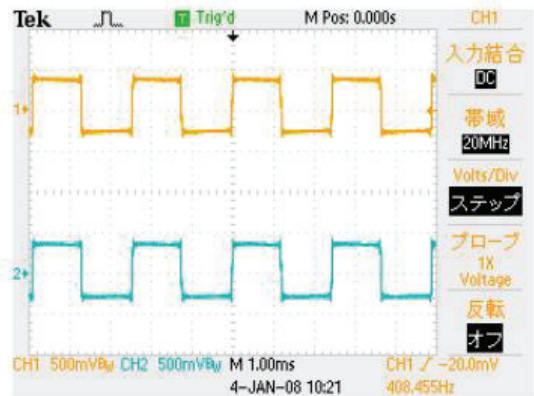

- Disconnect the plug from the INPUT A jack. Verify that the CHECK LED lights up red.

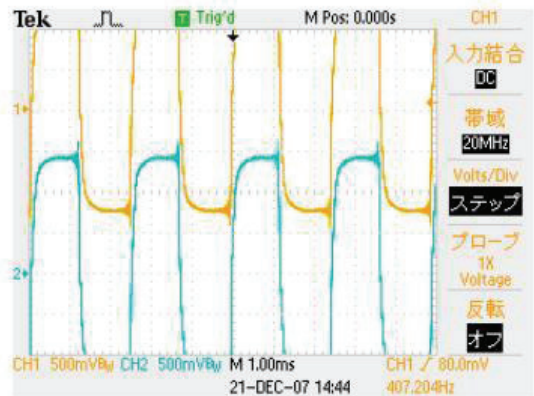

If the waveforms grow larger, operation is correct. If the waveforms show no change, operation is faulty.

3. Insert the plug into the INPUT A jack.
Verify that the CHECK LED lights up orange.

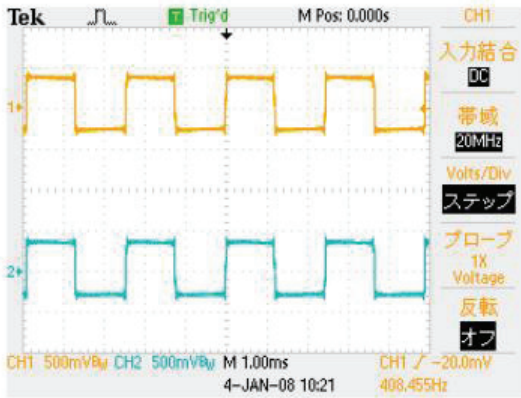

3. Insert the plug into the OUTPUT A jack.
Verify that the CHECK LED goes dark.

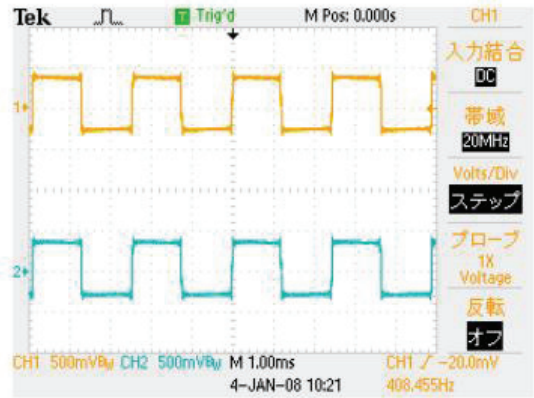

8. DSP Through Check (OUTPUT A Check)

Make the connections shown below to the INPUT and OUTPUT jacks on the DD-7, using the settings indicated.

- INPUT A: Input a rectangular wave at 400 Hz, 800 mVp-p.
 - INPUT B: Input a rectangular wave at 400 Hz, 800 mVp-p.
 - OUTPUT A: Connect the oscilloscope.
 - OUTPUT B: Connect the oscilloscope.
- Set the oscilloscope to 500 mV/DIV, 1 ms/DIV, and coupling: DC.

1. Adjust the MODE control to the **HOLD** position.
Verify that the CHECK LED has gone dark.

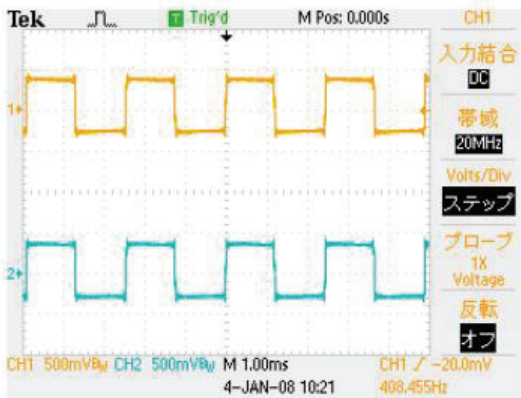

2. Disconnect the plug from the **OUTPUT A** jack.
Verify that the CHECK LED lights up green.

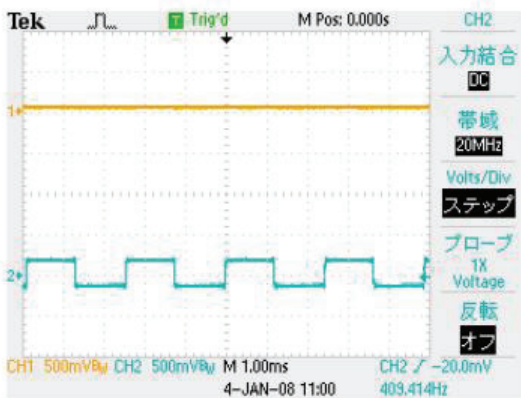

9. DSP Through Check (OUTPUT B Check) & CLIP Check

Make the connections shown below to the INPUT and OUTPUT jacks on the DD-7, using the settings indicated.

- INPUT A: Input a sine wave at 400 Hz, 4.0 V p-p.
 - INPUT B: Input a sine wave at 400 Hz, 4.0 V p-p.
 - OUTPUT A: Connect the oscilloscope.
 - OUTPUT B: Connect the oscilloscope.
- Set the oscilloscope to 2.0 V/DIV, 1 ms/DIV, and coupling: DC.

1. Adjust the MODE knob to the **MODULATE** position.
Verify that the CHECK LED lights up orange.
Verify that the waveforms are not clipped.

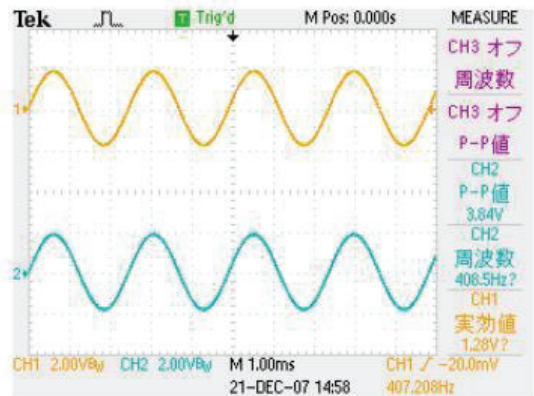

2. Disconnect the plug from the **OUTPUT B** jack.
Verify that the CHECK LED lights up red.

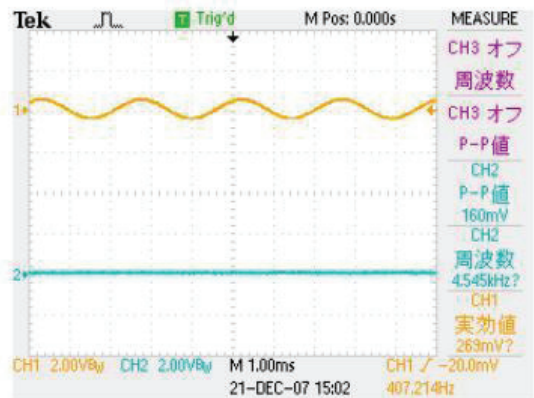

3. Insert the plug into the OUTPUT B jack.
Verify that the CHECK LED lights up orange.

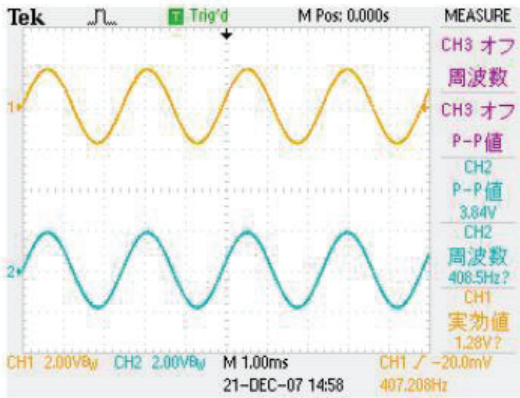

4. Adjust the MODE knob to the **ANALOG** position.
Verify that the CHECK LED lights up orange.
Verify that the waveforms are not clipped.

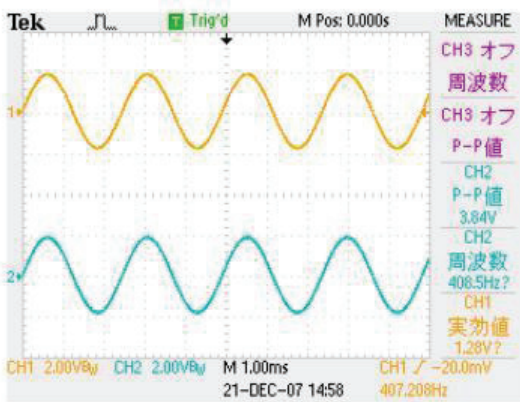

5. Disconnect the plug from the OUTPUT B jack.
Verify that the CHECK LED lights up red.

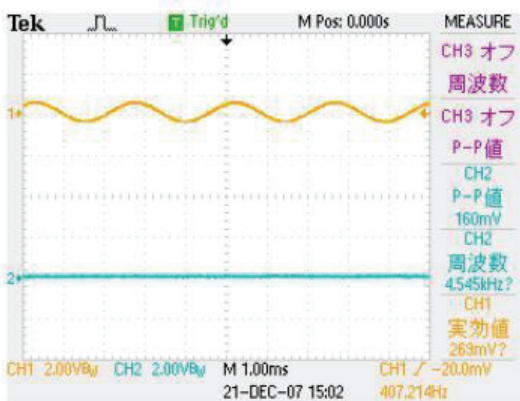

6. Insert the plug into the OUTPUT B jack.
Verify that the CHECK LED lights up orange.

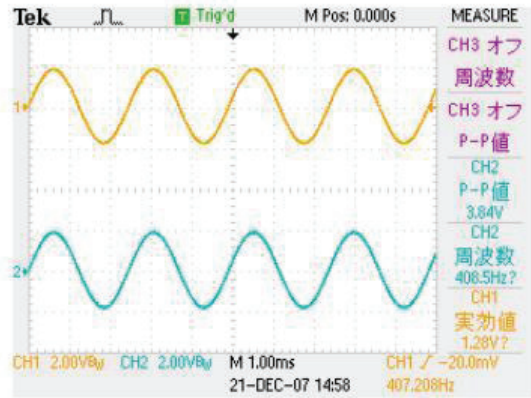

7. Adjust the MODE control to the **REVERSE** position.
Verify that the CHECK LED lights up orange.
Verify that the waveforms are not clipped.

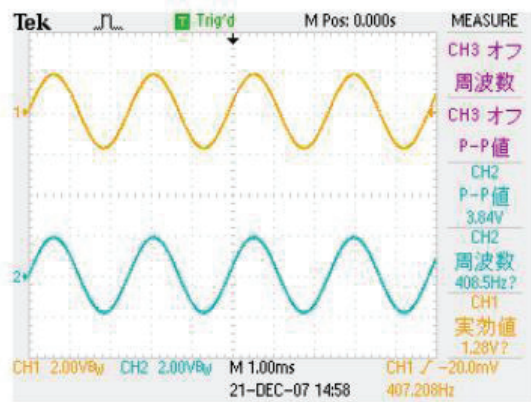

10. Residual Noise Check

Make the connections shown below to the INPUT and OUTPUT jacks on the DD-7.

- INPUT A: Connect a 47-kΩ dummy plug.
- INPUT B: Connect a 47-kΩ dummy plug.
- OUTPUT A: Connect a noise meter (JIS-A) and monitor speaker.
- OUTPUT B: Connect a noise meter (JIS-A) and monitor speaker.

1. Adjust the MODE knob to the **ANALOG** position.
Verify that the CHECK LED goes dark.
Verify that residual noise is **-93.0 dB** or less.
Verify that no audible noise or shock noise is present.
2. Adjust the MODE control to the **REVERSE** position.
Verify that the CHECK LED lights up orange.
Verify that residual noise is **-99.0 dB** or less.
Verify that no audible noise or shock noise is present.
3. Detach the plugs from the INPUT A and INPUT B jacks and switch off the power.

11. Battery Operation Check

1. Insert batteries into the battery compartment, connect the AC adaptor (to INPUT A), and switch on the power.
Make sure the CHECK LED lights up.

2. Rapidly disconnect the AC adaptor and verify battery operation.

* Failing to disconnect rapidly triggers a reset. If reset occurs repeatedly, a problem such as faulty contact in the AC adaptor jack may be present. If the CHECK LED is dark, check the battery voltage.

Circuit Board (Main Board)

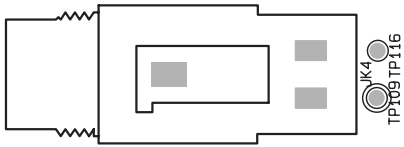
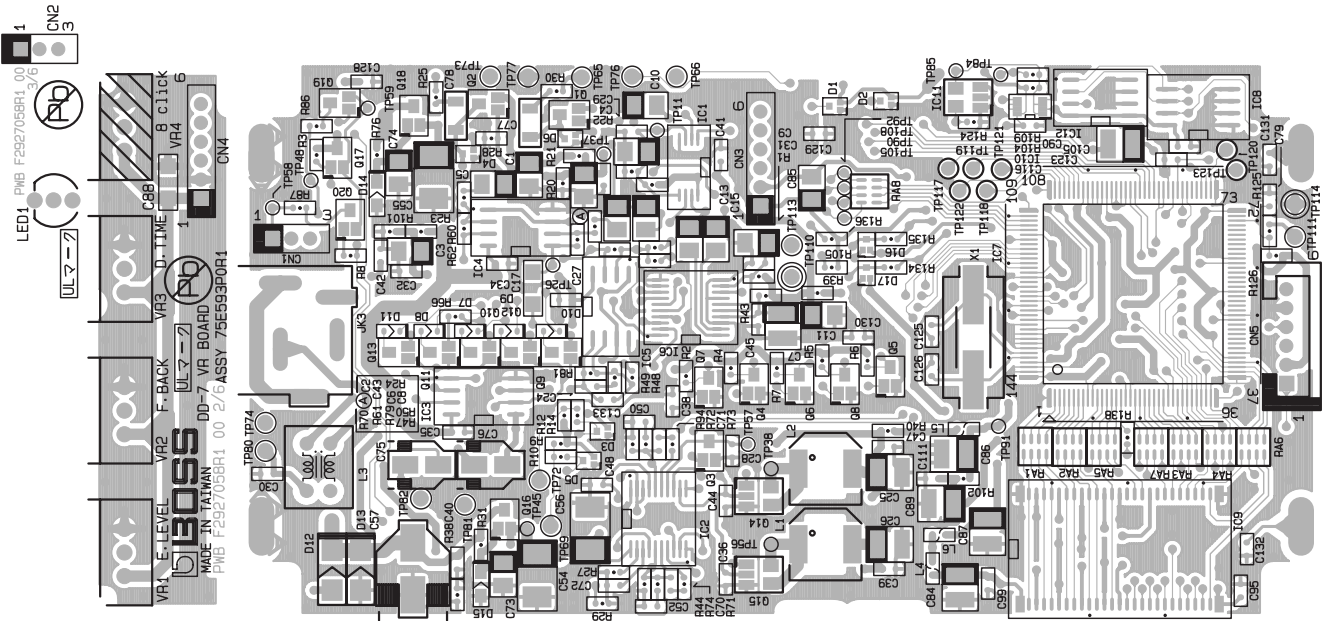

View from components side

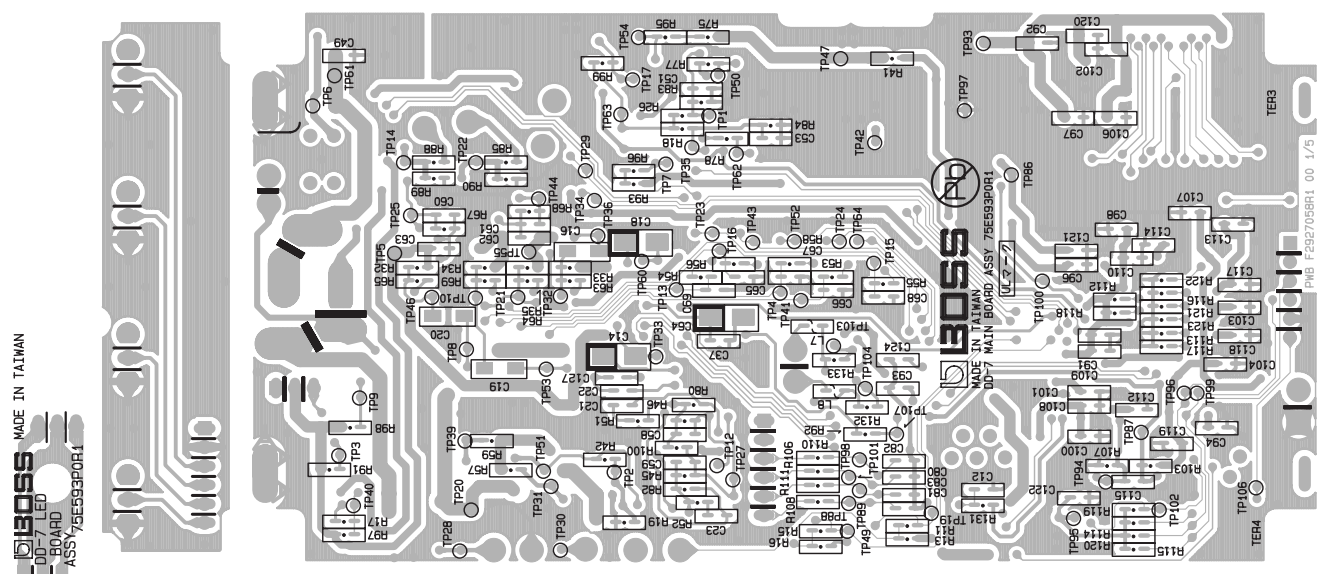
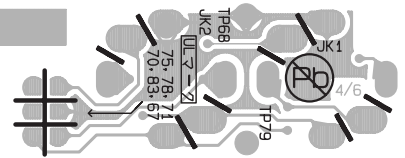
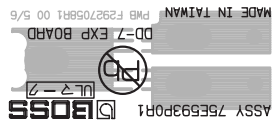

View from foil side

Circuit Diagram (Main Board: Analog)

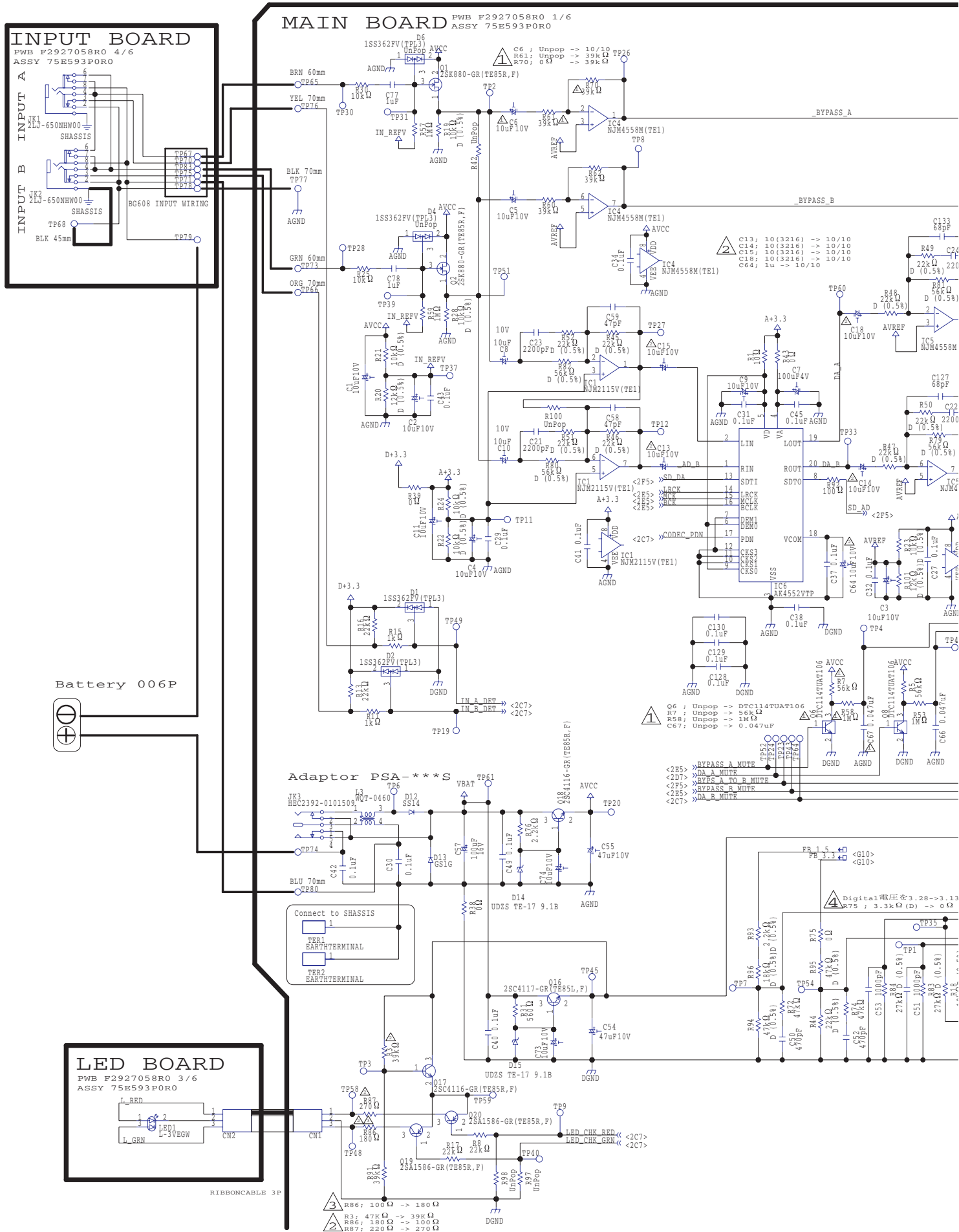

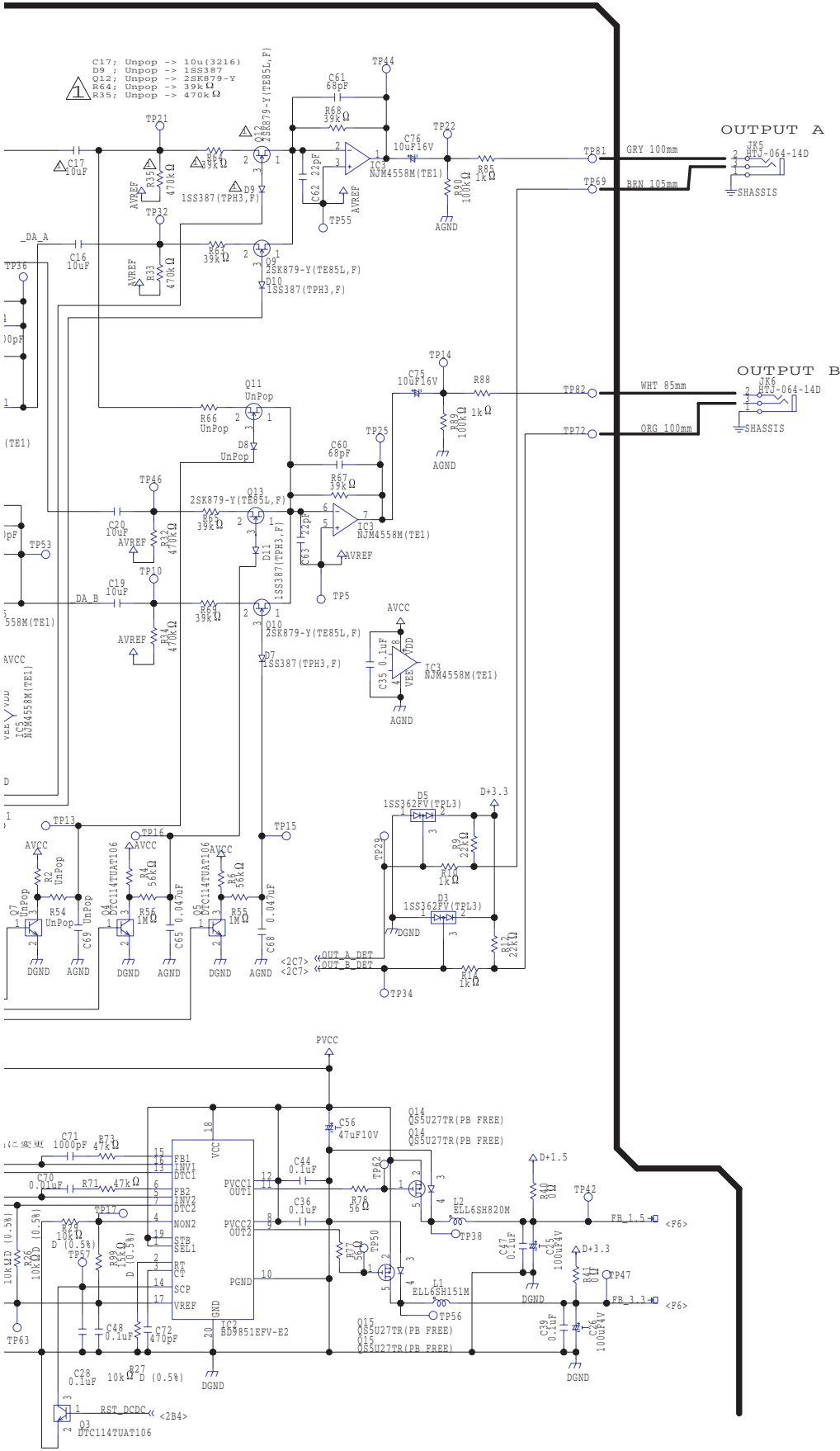

Circuit Diagram (Main Board: Digital)

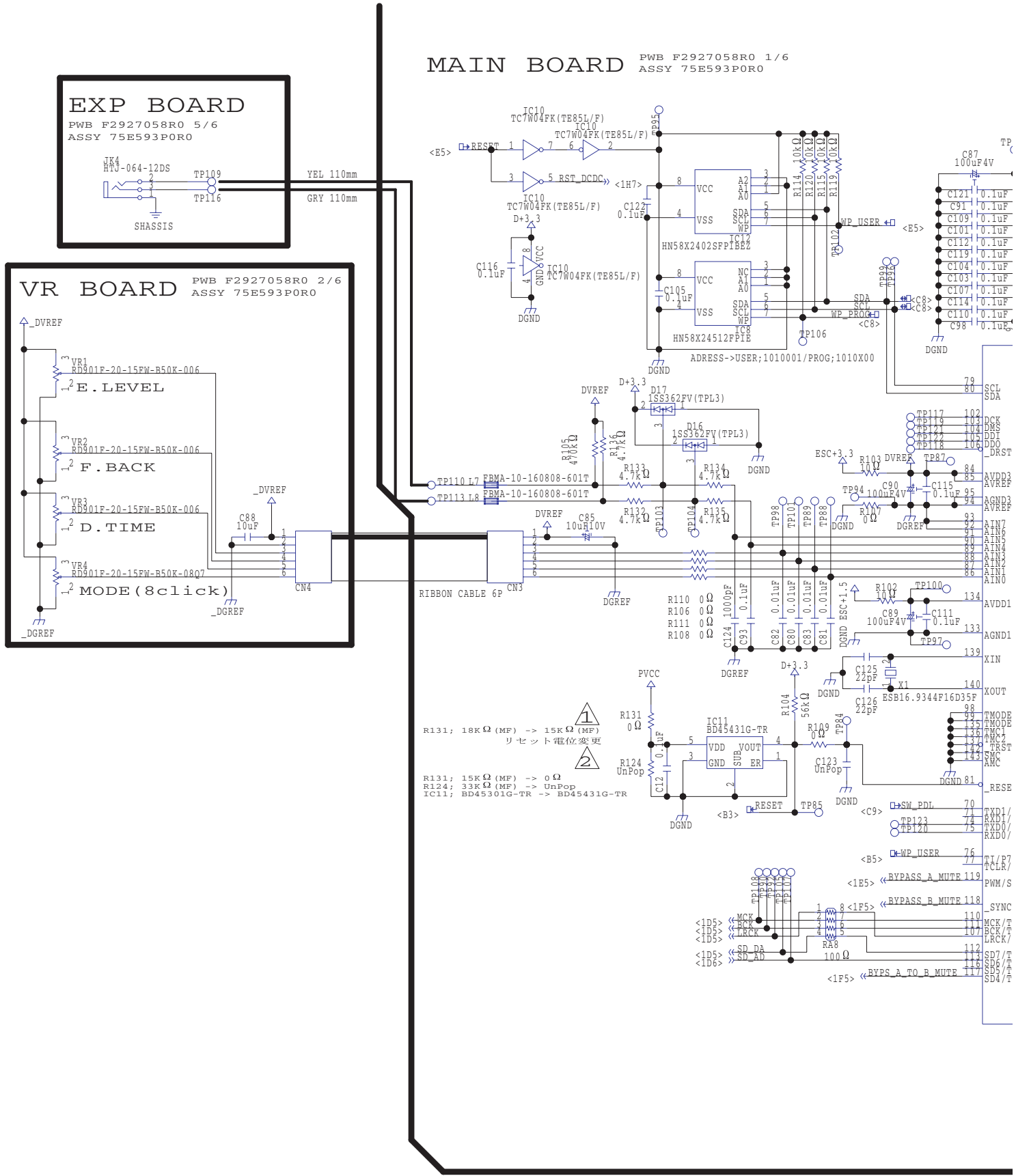

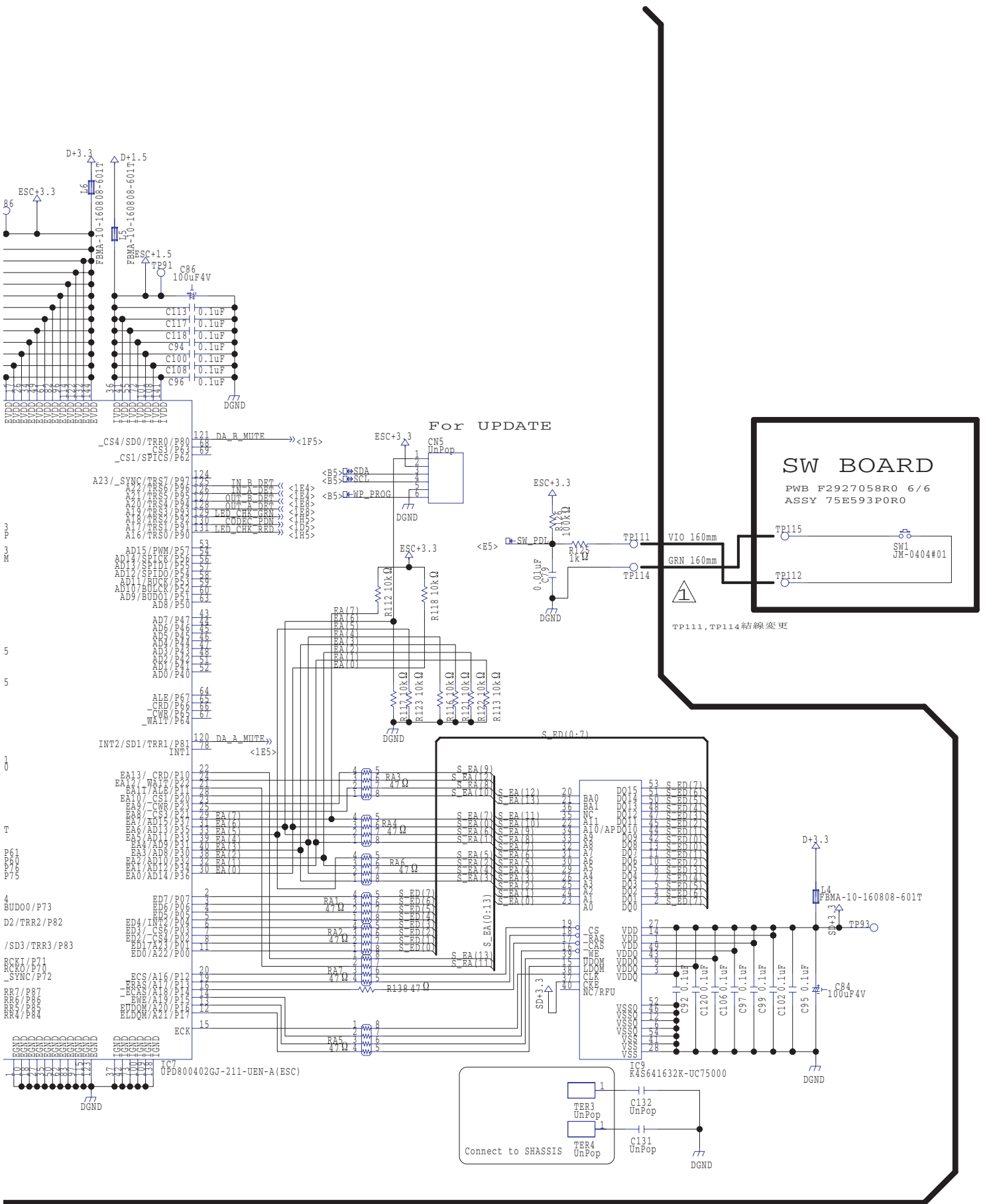

MEMO

Roland