

BOSS PH-2

SERVICE NOTES

First Edition

SPECIFICATIONS

Power Source	9V DC (Battery, or AC Adaptor)	Gain	Unity
Current Draw	20mA (max.) at 9V	Input Impedance	1MΩ
Phase Shift	12 stages (2160°)	Output Load Impedance	more than 10kΩ
LFO Speed	14s to 100ms	Dimensions	70(W) x 55(H) x 125(D) mm 2-3/4"(W) x 2-3/16"(H) x 4-15/16"(D)
Residual Noise	less than -80dBm (IHF-A)	Weight	410 g/14 oz.
Maximum Input	-5dBm		

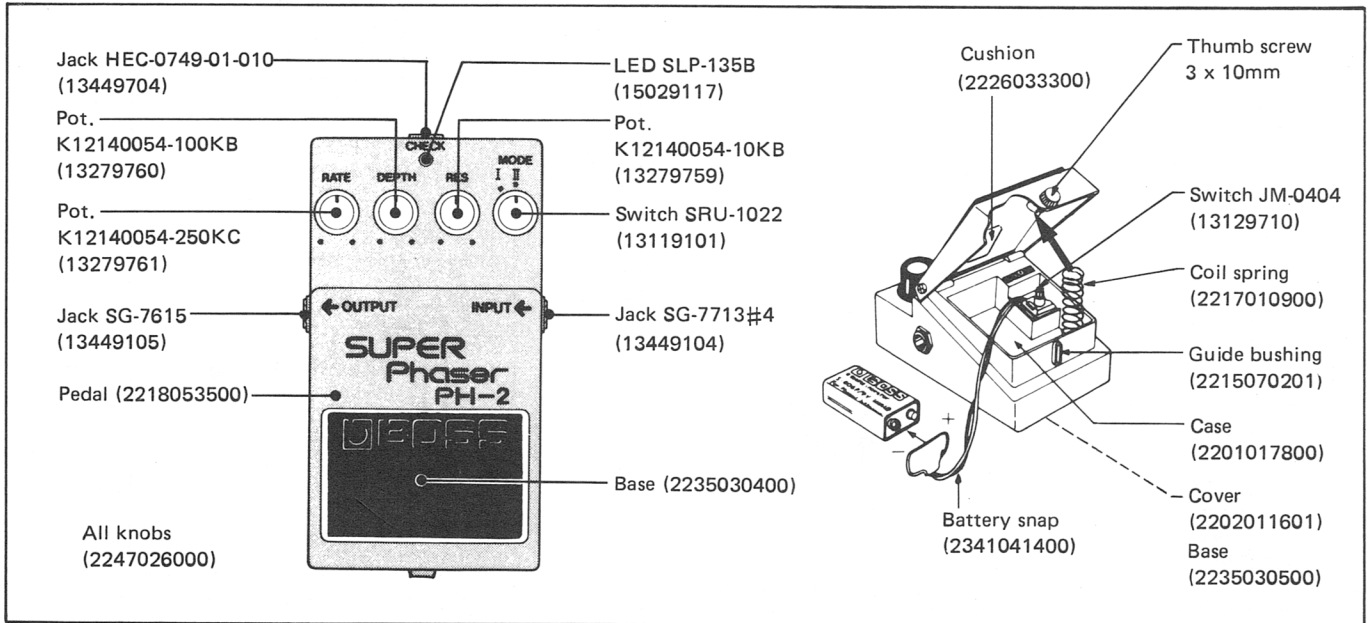

PARTS LIST

2201017800	Case	
2218053500	Pedal	
2202011601	Cover	bottom
2235030500	Base	bottom
2235030400	Base (pedal mat)	
2215070201	Guide bushing	
2247026000	Knob	
2341041400	Battery snap	
2226033300	Cushion	
2217010900	Coil spring	

JACK

13449704	HEC-0749-01-010	AC adaptor
13449105	SG-7615	OUTPUT
13449104	SG-7713#4	INPUT

SWITCH

13129710	JM-0404	KEY
13119101	SRU 1022	MODE

POTENTIOMETER

13279759	K12140054	10KB	RES
13279760	K12140054	100KB	DEPTH
13279761	K12140054	250KC	RATE
13299311	EVN-31CA00B14		trimmer

PCB

7522651000	MAIN board
	(pcb 2291098500-1/2)
7522652000	VR board
	(pcb 2291098500-2/2)
2291049600	LED mounting, less parts

SEMICONDUCTOR







15229801	IR3109	operational transconductance amp
15219128	NE571	compander
15159129	HD14053BP	triple 2-channel analog multiplexer
15189115	IR9022	dual low-power OP amp
15189136	M5218L	OP amp
15139101	2SK30A(TM)-Y	FET
15129108	2SC945-P	transistor
15019103	1S2473	diode
15019209	S5500G	diode
15019526	RD5.6EB-3	zener
15029117	SLP-135B	LED

ADJUSTMENT AND CHECKING

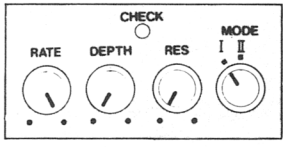
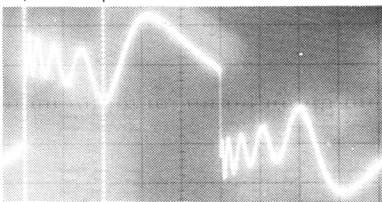
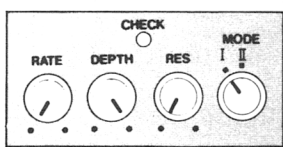
1. Feed the test signal to INPUT of the PH-2.
2. Connect the scope to OUTPUT of the PH-2.
3. Push Pedal once if the LED is unlit (EFFECT OFF).

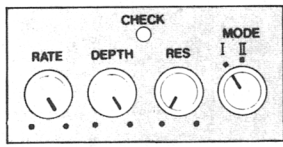
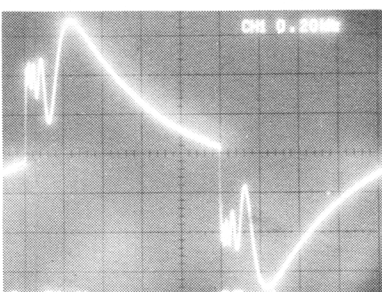
NOTE: The indicator fails to light when the DC is below 6V.

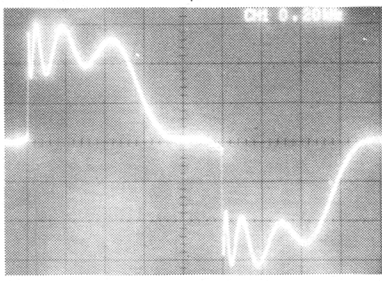
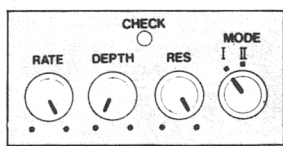
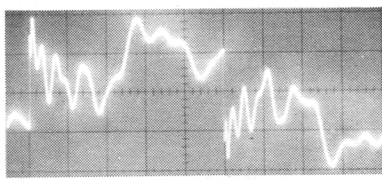
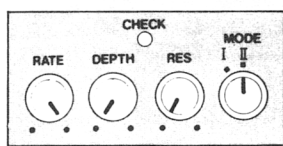
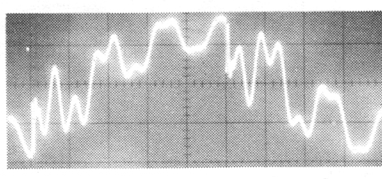
The amplitudes in the table are taken with accurate 9V source and will vary as the voltage fluctuates.

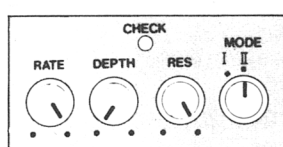
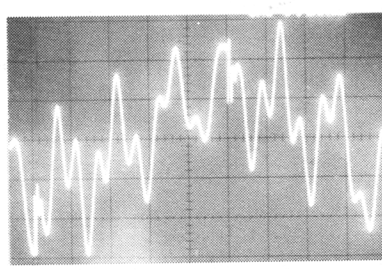
CHECK	INPUT	SET CONTROLS	WAVEFORM & REMARK
FILTER	 200Hz 200mVp-p		50mV/div; 0.5ms/div.  Adjust RT-1 on VR Board for T=1ms. NOTE: DEPTH remains slightly effective even at FCCW position; the waves will jitter.
LFO		  	   The waveform will vary between the extremes shown in photos, respectively. Sweep rate should be 14s with RATE at FCCW and 100ms at FCW.
RESONANCE MODE I			
MODE II			
RESONANCE MODE II			

VR BOARD

7522652000

(pcb 2291098500-2/2)

MAIN BOARD

7522651000

(pcb 2291098500-1/2)

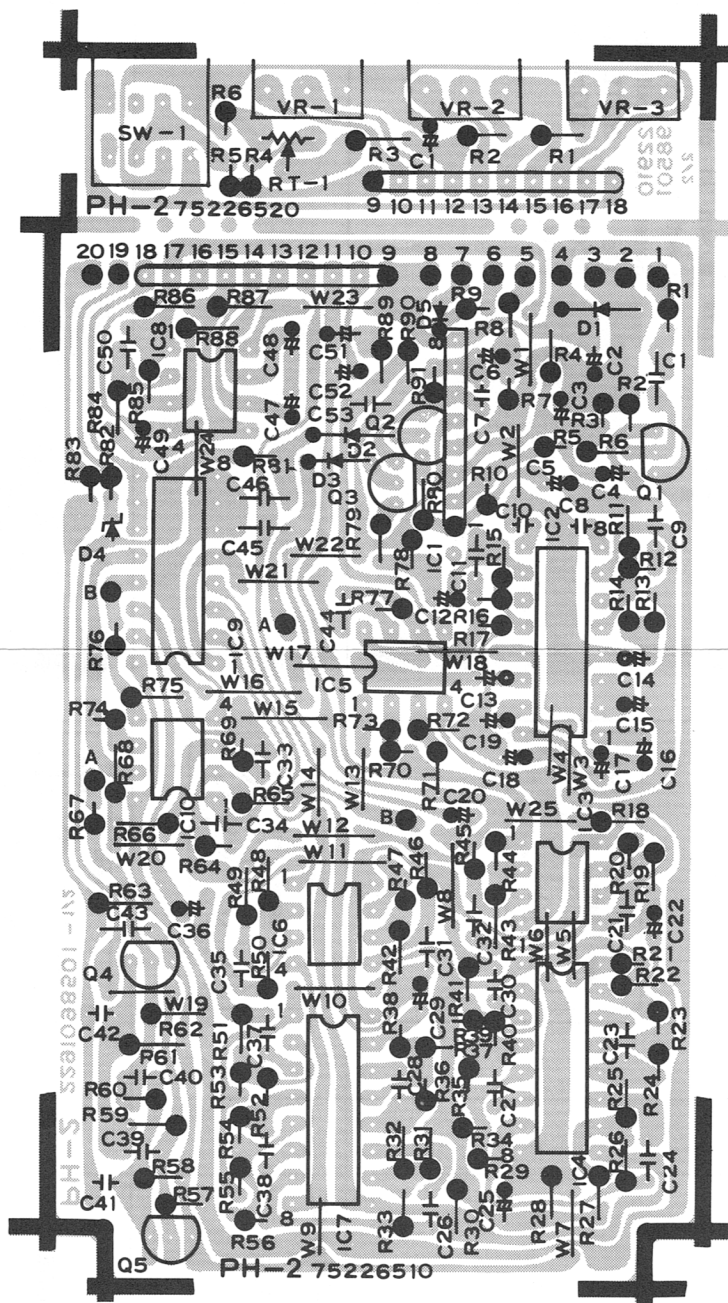

MINIATURE COMPONENTS

RESISTOR

R16U 1/6W Vertical forming

13809173T0	100
13809177T0	150
13809189T0	470
13809191T0	560
13809205T0	2.2K
13809213T0	4.7K
13809215T0	5.6K
13809221T0	10K
13809223T0	12K
13809227T0	18K
13809229T0	22K
13809233T0	33K
13809237T0	47K
13809239T0	56K
13809241T0	68K
13809245T0	100K
13809269T0	1M

ELECTROLYTIC CAPACITOR

	µF/V	
13639276J0	0.47/50	SRA50VBR47
13629402	1/50	SRE50VB1
13629346	10/16	SRE16VB10
13629309	47/6.3	SRE6.3VB47B3
13629345	4.7/16	SRE16VB4R7
13629150J0	100/16	SRA16VB100MF
13629128J0	33/10	SRA10VB33

CIRCUIT DIAGRAM

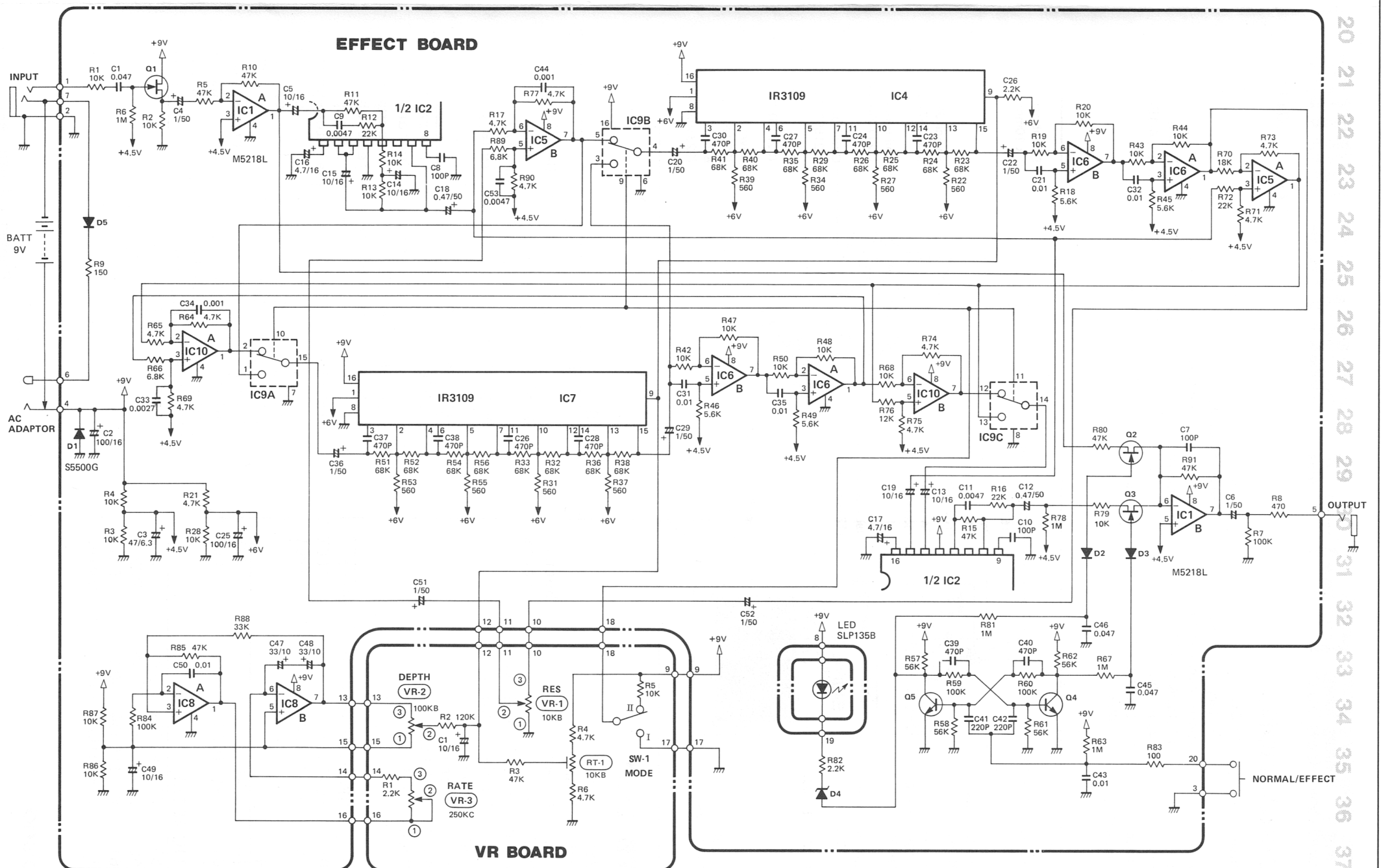

IC2	NE571	Q1, 2, 3	2SK30A-Y	D1	S5500G
IC3, 5, 6, 8, 10	IR9022	Q4, 5	2SC945-P	D2, 3, 5	1S2473
IC9	HD14053			D4	RD5.6EB-3

PH-2 ELECTRICAL PARTS CHANGE INFORMATION

EFFECTIVE SERIAL NUMBER -- 497100

FOR NOISE REDUCTION

CHANGE TO:

R65	4.7K	12K
R66	6.8K	4.7K
R68	10K	5.6K
R70	18K	6.8K
R72	22K	8.2K
R74	4.7K	10K
R76	12K	22K
R79	10K	27K
R89	6.8K	5.6K
C12	0.47/50	0.1/50

COMPATIBLE PARTS

CHANGE TO:

IC2: NE571 NE571(UPC1571) OR NE570 (15219108)

IC 3,5,8,10:
IR9022 IR9022 OR TL022 (15189115)