

CARVER

P R O F E S S I O N A L

MODEL PM-600 Magnetic-Field Power Amplifier

Owner's Manual

IMPORTANT NOTICE
Please read carefully!

This amplifier was originally manufactured by Carver Corporation. There are references contained within this manual to addresses and telephone numbers that should no longer be used to obtain technical support or factory service.

For any assistance with this product please contact:

Carver Professional
A Division of Phoenix Gold International, Inc.
9300 North Decatur
Portland, Oregon 97203
Tel. 503.978.3344
Fax 503.978.3302

1. Safety Instructions

1. Read Instructions — All the safety and operation instructions should be read before the Carver Component is operated.

2. Retain Instructions — The safety and operating instructions should be kept for future reference.

3. Heed Warnings — All warnings on the Component and in these operating instructions should be followed.

4. Follow Instructions — All operating and other instructions should be followed.

5. Water and Moisture — The Component should not be used near water - for example, near a bathtub, washbowl, kitchen sink, laundry tub, in a wet basement, or near a swimming pool, etc.

6. Ventilation — The Component should be situated so that its location or position does not interfere with its proper ventilation. For example, the Component should not be situated on a bed, sofa, rug, or similar surface that may block any ventilation openings; or placed in a built-in installation such as a bookcase or cabinet that may impede the flow of air through ventilation openings.

7. Heat — The Component should be situated away from heat sources such as radiators, or other devices which produce heat.

8. Power Sources — The Component should be connected to a power supply only of the type described in these operation instructions or as marked on the Component.

9. Power Cord Protection — Power-supply cords should be routed so that they are not likely to be walked upon or pinched by items placed upon or against them, paying particular attention to cords at plugs, convenience receptacles, and the point where they exit the Component.

10. Cleaning — The Component should be cleaned only as recommended in this manual.

11. Non-use Periods— The power cord of the Component should be unplugged from the outlet when unused for a long period of time.

12. Object and Liquid Entry — Care should be taken so that objects do not fall into and liquids are not spilled into the inside of the Component.

13. Damage Requiring Service — The Component should be serviced only by qualified service personnel when:

- A. The power-supply cord or the plug has been damaged; or
- B. Objects have fallen, or liquid has spilled into the Component; or
- C. The Component has been exposed to rain; or
- D. The Component does not appear to operate normally or exhibits a marked change in performance; or
- E. The Component has been dropped, or its cabinet damaged.

14. Servicing — The user should not attempt to service the Component beyond those means described in this operating manual. All other servicing should be referred to qualified service personnel.



CAUTION
RISK OF ELECTRIC SHOCK
DO NOT OPEN



**CAUTION: TO REDUCE THE RISK OF ELECTRIC SHOCK
DO NOT REMOVE COVER (OR BACK)
NO USER-SERVICEABLE PARTS INSIDE
REFER SERVICING TO QUALIFIED PERSONNEL**



The lightning flash with arrowhead symbol within an equilateral triangle is intended to alert the user to the presence of uninsulated "dangerous voltage" within the product's enclosure, that may be of sufficient magnitude to constitute a risk of electric shock to persons.



The exclamation point within an equilateral triangle is intended to alert the user of the presence of important operating and maintenance (servicing) instructions in the literature accompanying the appliance.

PORTABLE CART WARNING



Carts and stands - The Component should be used only with a cart or stand that is recommended by the manufacturer. A Component and cart combination should be moved with care. Quick stops, excessive force, and uneven surfaces may cause the Component and cart combination to overturn.

15. To prevent electric shock, do not use this polarized plug with an extension cord, receptacle or other outlet unless the blades can be fully inserted to prevent blade exposure.

Pour prévenir les chocs électriques ne pas utiliser cette fiche polarisée avec un prolongateur, un prise de courant ou une autre sortie de courant, sauf si les lames peuvent être insérées à fond sans laisser aucune partie à découvert.

16. Grounding or Polarization — Precautions should be taken so that the grounding or polarization means of the Component is not defeated.

17. Internal/External Voltage Selectors — Internal or external line voltage selector switches, if any, should only be reset and re-equipped with a proper plug for alternate voltage by a qualified service technician. See an Authorized Carver Dealer for more information.

18. Attachment Plugs for Alternate Line Voltage (Dual voltage models only) — See your Authorized Carver Dealer for information on the attachment plug for alternate voltage use. This pertains to dual-voltage units only.

WARNING – TO REDUCE THE RISK OF FIRE OR ELECTRIC SHOCK, DO NOT EXPOSE THIS APPLIANCE TO RAIN OR MOISTURE.

Table of Contents

1. Introduction	4	I/O Wiring	9
About This Manual	4	XLR Connector Polarity	9
Notational Conventions	4	Output Connector Wiring	9
2. Special Features	5	Ground Lift Strap	10
Magnetic Field Amplifiers	5	Interior Switch Settings	10
Direct 70V Output Capability	5	Bridging Operation	10
Clipping Eliminator	5	XLR Connector Polarity	10
Protection Circuitry	5	Clipping Eliminator	10
Remote Turn On/Off	5	Using the PM-600	11
Specifications	6	Using the PM-600 to drive 70V	
3. Front and Rear Panel Features	6	Distribution Systems	11
Front Panel	6	THX® Installations	11
Rear Panel	6-7	5. Technical Information	12
4. Installation	7	Theory of Operation	12
Mechanical Considerations	7	Low Level Circuitry	12
Rear Support for Road Applications	7	Power Amplifier Circuitry	12
Cooling Requirements	8	Power Supply Circuitry	13
AC Power Considerations	8	Display Circuit	14
Line Voltage Conversion	8	Schematic Diagrams	15-19
Remote Power Sequencing	8	6. In Case of Difficulty	22
Magnetic Flux Leakage Considerations	9	7. Warranty Information	23

A Message from Bob Carver

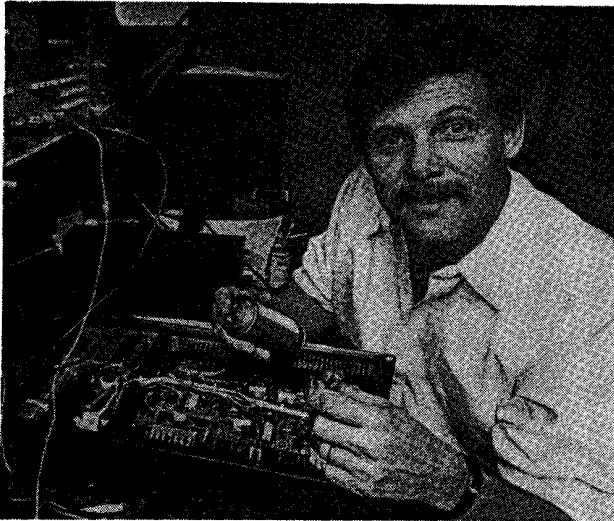

Congratulations on the purchase of your professional PM-600 Amplifier. It represents the latest technology in Carver's patented Magnetic Field Power Supply. This efficient supply, coupled with a unique amplifier design, provide you with the very best in performance. Because of the specially-designed protection systems, you can be assured your valuable speakers and amplifier will be protected.

Its lightweight and rugged construction makes it ideal for touring and permanent installations. A growing range of add-on card modules are available to further enhance the PM-600's versatility. These include the PMX 2-way Electronic Cross-over, PG-2 Dual-Zone Paging Module, PMT-2 Balanced Input as well as external 70.7-volt transformers. Consult your Carver dealer for more information.

We are proud of our track record for excellent performance and proven reliability. The high standards Carver products provide embodies the quality that our customers have come to expect.

Bob Carver

Introduction

About This Manual

The manual is divided into the following sections:

Introduction — Introduces the PM-600 and describes the manual and the notational conventions used in the manual.

Special Features — Describes the features that make the PM-600 unique and lists the specifications.

Front and Rear Panel Features — Describes every knob, button, switch, and connector on the front and rear panels of the PM-600.

Installation — Covers all aspects of installation: mechanical, electrical, and thermal.

Technical Information — Describes the PM-600's circuit design. Includes the procedure for changing the AC power mains voltage. The schematic diagrams can be found here.

In Case of Difficulty — Describes what to do if the PM-600 won't operate.

Warranty Information — Tells what to do when you need to contact the factory for repair or repair parts.

Notational Conventions

Several notational conventions are used in this manual. Some paragraphs may use **Note**, **Caution**, or **Warning** as a heading. These headings have the following meaning:

Note — Identifies information that needs extra emphasis. A Note generally supplies extra information to help you use the amplifier more effectively.

Caution — Identifies information that, if not heeded, may cause damage to the amplifier or other equipment in your system.

WARNING — Identifies information that, if ignored, may be hazardous to your health or that of others.

2. Special Features

The PM-600 has several design features that set it apart from the competition:

- Patented Magnetic Field Amplifier circuitry
- Direct 70V output capability
- Clipping eliminator circuitry
- Protection circuitry
- Remote/manual sequential power on/off

Magnetic Field Amplifiers

A Carver Magnetic Field Amplifier is the synergism of a highly-efficient, multiple-rail power amplifier and an equally high-efficiency regulated power supply. Using regulated power supplies for audio amplifiers is nothing new; the difference in the PM-600 is in the power transformer and how it is driven. Conventional amplifiers require the power transformer to be energized 100% of the time that the amplifier is in use. A magnetic field amplifier's power transformer is inside a voltage regulator's feedback loop; it is only fully on when needed for full power output. At all other times, the power transformer operates only enough to keep the main filter capacitors charged to plus and minus 73 volts. This allows a considerable reduction in the size and weight of the power transformer; two of the principal reasons for the small size and light weight of the PM-600.

The amplifier circuitry uses a triple-rail power supply design. This design minimizes the voltage dropped across each of the output transistors, minimizing their heat dissipation. In turn, reducing the heat dissipation allows a reduction in the size and bulk of the heat sinks used to transfer this heat to the surrounding air. This combination of a magnetic field power supply and a high-efficiency output stage yields an amplifier with a high power to weight ratio.

Direct 70V Output Capability

In bridging mode, the PM-600 can produce sufficient output voltage to drive 70-volt distribution systems without using a step-up transformer at the amplifier. The amplifier can deliver 624-watts to the 70-volt system. Transformers are still required at each loudspeaker (as is the case with all 70-volt systems). By re-calculating the tap power ratings on the step-down transformers used at the

loudspeaker end, the PM-600 can deliver additional power beyond 625 watts.

Clipping Eliminator

In addition to sounding bad, clipped waveforms kill loudspeakers. This fact of life is made more true by the practice of using large amplifiers for increased headroom. When an amplifier clips, the output waveform contains large amounts of harmonics which extend both above and below the fundamental frequency. This can be potentially destructive to any high-frequency driver. The clipping eliminator works by sensing the onset of amplifier clipping and reducing the input signal level to limit the distortion in the output signal to less than one percent THD with up to 8 dB of overdrive. The action is similar to that of a limiter. The clipping eliminator is sensitive to clipping regardless of cause: excessive input drive, power line sag, low load impedances, etc.

Protection Circuitry

The PM-600 has specially designed protection circuitry that protects the amplifier from abnormal load conditions, as well as protecting the load from an abnormal amplifier. The amplifier includes the following protective measures:

- Input RFI filtering
- Power line filtering
- Load protection from DC output
- Amplifier protection from sustained current limiting caused by severe overdrive or abnormally low load impedances
- Thermal overload protection.

The front-panel CLIP/PROTECT LED indicators in the output display illuminate when any of the protection circuits are activated. The remaining LED's in the output display indicate the relative signal level at each output and the powering status of the amplifier.

Remote Turn On/Off

The PM-600 can be remotely turned on and off by a +5 to +15 volt DC signal voltage applied to the remote terminals on the rear panel. An additional terminal supplies a delayed +11 volt DC turn-on signal for use by another amplifier. By using these terminals, an entire rack/system of Carver amplifiers may be turned on in sequence, without danger

of tripping circuit breakers or causing power surges. If one amplifier in the sequence should become inoperative and blow its line fuse, the amplifier sending it +11 volts will supply enough DC voltage "through" the inoperative amplifier to keep the amplifiers after it operating. This will assure continuous operation in the unlikely event that one or more amplifier should fail.

Specifications

Power Output 20-20kHz	
8 ohms, both ch driven	200W
4 ohms, both ch driven	300W
8 ohms mono bridged	700W
70V mono bridged	625W
Distortion	0.5% THD @ 1kHz
Bandwidth	+0, -3 dB, 5Hz-80kHz
Frequency Response ...	+0, -0.5 dB, 20 Hz-20 kHz
IM Distortion (SMPTE)	Less than 0.1%
Gain	28.5 dB
Input Sensitivity (full output)	
.....	1.5V RMS, +5.74 dBu
Input Impedance	30 kilohms balanced or
	unbalanced (non-inverting "+" input)
.....	15 kilohms unbalanced (inverting "-" input)
Input Overload	4.36V/+15 dBu
Slew Rate	25 V/μSec
Damping Factor	150 @ 1 kHz
Output Noise (A weighted)	
.....	-106 dB, ref 40V output
EMI/RFI Noise Filtering	
.....	0.15-30 MHz normal and common mode
Inputs (balanced, differential):	
	Barrier strip, XLR, 1/4 inch tip-ring-sleeve
	phone jack; all parallel connected.
Dimensions (HWD inches)	
.....	3.5 x 19 x 11.56 (13.75 overall)
.....	2U rack space
Net Weight	22.5 lbs. (10.2 kg)
Shipping Weight	25.9 lbs. (11.7 kg)
Power Requirements	120 V, 50-60 Hz
Power Consumption	
.....	1000 Watts at full power into 8 ohms
.....	55 Watts at idle

Features and Specifications are subject to change without notice.

3. Front and Rear Panel Features

Front Panel

The following paragraphs describe the controls, switches, jacks, and displays found on the front panel of the PM-600. Refer to Figure 1.

1. POWER switch.

2. SEQUENCE switch. Enables the remote sequencing feature of the PM-600. The POWER switch must be set to the OFF position. A +5 to +15 Volt DC signal applied to the rear panel RECEIVE terminal turns the amplifier on. Removing this voltage turns the amplifier off.

3. LEFT and RIGHT level Controls. 11-step attenuators that adjust the relative output level of the PM-600. The amount of attenuation corresponds to the front-panel marking, in dB.

4. LED Output Status Display. 7 LED's (per channel) indicate the status of the amplifier. The bottom, green LED's indicate power-on. The five, red LED's indicate the output power level of the amplifier in dB relative to maximum output. The top, yellow LED's indicate the onset of clipping. The yellow LED's also indicate activation of the amplifier's protection circuits.

Rear Panel

The following paragraphs describe the various rear panel features of the PM-600. Refer to Figure 2.

1. FUSE. AC power line fuse for the PM-600. Use only one of the following fuses: *Schurter SPT 001.2533* OR *Littlefuse 3AB 326008* OR *Bussman MDA8*, 8 ampere slow-blow for 120 VAC operation. Repeated fuse blowing is a sign of internal distress. Have an authorized Carver service technician repair the amplifier.

2. RIGHT/LEFT. 5-way binding posts used to connect the loudspeakers to the amplifier outputs. The red terminal is the signal connection, the black terminal is the signal return connection.

3. ACCESSORY PANEL. A removeable panel used for installation of various Carver amplifier accessories. Contact your authorized Carver dealer

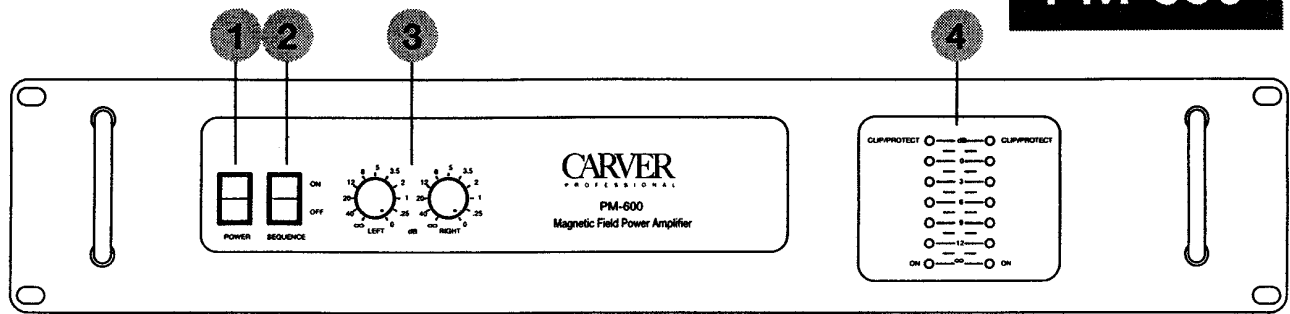

Fig. 1

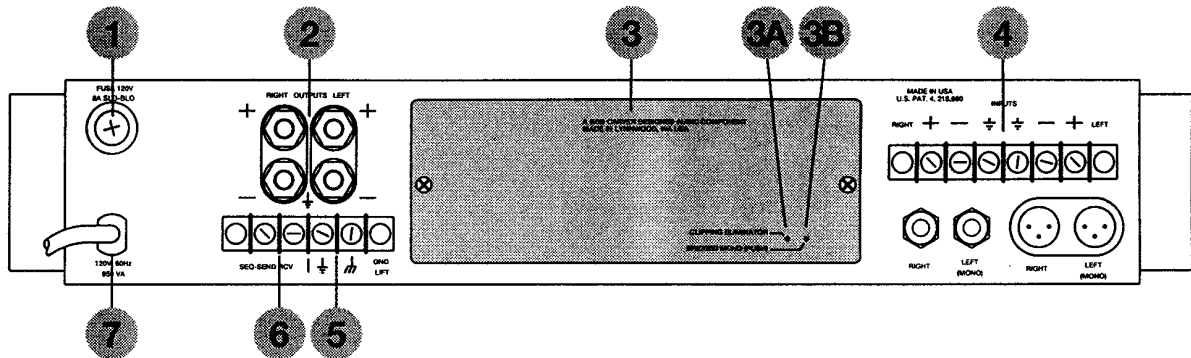

Fig. 2

for availability information. Also located behind this panel are the following push-push switches:

CLIPPING ELIMINATOR (3A) — Pressing this switch turns on the clipping eliminator circuit. In this mode, the amplifier output remains undistorted even when overdriven by up to 8 dB.

MONO MODE (3B) — Pressing this switch selects bridged mono mode for the PM-600. For mono operation, use the LEFT inputs and level control. Use this mode for 8 ohm or greater loads, and for 70 V direct operation.

4. INPUTS. Parallel connected barrier strip terminals, female XLR connectors and 1/4 inch tip-ring-sleeve phone jacks. These are the input connectors for the amplifier.

5. GND LIFT. Removing this jumper isolates the amplifier's power supply ground from the amplifier chassis. This may be necessary to eliminate ground loops in some systems.

6. SEQUENCER TERMINALS. The RECEIVE terminal accepts +5 to +15 volts DC from another amplifier or remote DC source. The SEND terminal sends +11.4 volts to the next amplifier in the sequence.

7. POWER CORD. Available with standard North American 120V or IEC international 230V plug.

4. Installation

The PM-600 may be used free-standing or installed inside a rack enclosure. Installation consists of the actual mechanical installation, and the electrical and thermal considerations needed. These considerations are detailed in the following paragraphs.

Mechanical Considerations

The PM-600 requires two rack spaces (3.5 inches). The amplifier requires 12.5 inches depth inside the rack. Be sure to secure the unit mechanically using four screws. It is a good idea to use flat-washers with the screws to prevent marring the front panel. Be sure that there is sufficient air space around the amplifier for cooling.

Rear Support for Road Applications.

If the PM-600 is rack-mounted, and the rack is to be transported, it is good practice to provide mechanical support for the rear of the amplifier. This could take the form of a shelf across the rear of the amplifier, or brackets that engage the rear of the unit. This practice is recommended for all rack-mounted electronic instruments; especially those that are large, heavy, and/or mechanically deep.

PM-600

Cooling Requirements

The PM-600 is convection cooled and requires no thermal considerations other than ensuring that there is an adequate supply of cold air for cooling. If the PM-600 is rack mounted, ensure that adequate ventilation exists at the sides of the amplifier. When several amplifiers are mounted together in a rack, you may need to provide air inlets from the outside of the rack. In high ambient temperatures, forced-air intake (via an external fan) to the interior of the rack may be needed. PM-600s can be stacked directly on top of each other without spacer panels. If the amplifier is used with other amplifiers, you should ensure that the other amplifier's heat output doesn't become part of the PM-600's cold air supply. In this case, additional cooling (fans) may be required.

AC Power Considerations

The PM-600 can operate from 120 VAC or 240 VAC, 50-60 Hz. At full output, the amplifier requires 1000 W. Ensure that the amplifier is plugged into an outlet capable of supplying enough current to allow full-power operation of all the

amplifiers plugged into it. The PM-600 has the following AC current requirements based on full output into the stated load:

8 ohms per channel 8.5A
4 ohms per channel 14A

Line Voltage Conversion

Caution

The line voltage conversion process requires soldering and the services of a competent technician. The basic procedure is described in Section 5, Page 13 of this manual.

Remote Power Sequencing

In large installations, it is advantageous to be able to switch each amplifier in the system on in sequence, a few seconds apart from each other. This minimizes the instantaneous power demand on the AC line at turn-on. The PM-600 has the capability of being turned on or off via a remotely applied DC voltage (+5 to +15 volts).

Connect the SEND terminal to the RCV terminal of another Carver amplifier. Connect that amplifier's SEND terminal to the RCV terminal of the next amplifier in line, and so on. The last amplifier in line has nothing connected to its SEND terminal. This is illustrated in Figure 3. If the GROUND LIFT strap is installed and a ground lift adaptor has not been installed on the AC line plug, then a common power supply ground connection will be made through the common chassis connection. In this case it not necessary to install the common ground wire shown in Fig. 3.

We recommend using good quality crimp type terminals at the SEND and RECEIVE connections to assure reliable operation.

Sequencing ON – Set the SEQUENCE switches of the amplifiers to ON. Set the power switches of the amplifiers to OFF. The amplifiers are now set to be sequenced on in one of three ways. The method of turning on the first amplifier initiates the power up sequence:

1. The first amplifier may be switched on remotely with a switch that supplies a DC voltage within +5v to +15v, (a common 9V battery will work fine). This is shown in Fig. 3; OR
2. The first amplifier may be switched on manually with its power switch; OR

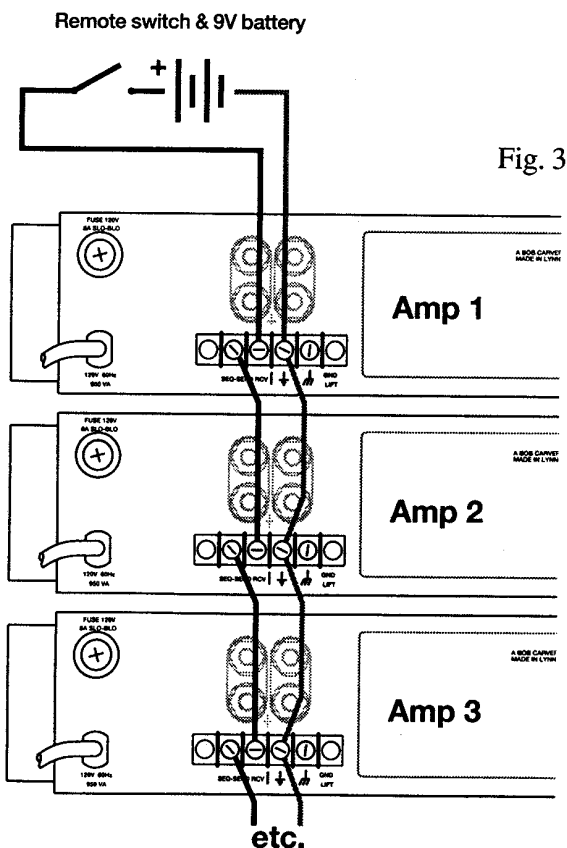

3. The first amplifier has its power switch in the on position and all the amplifiers AC power is controlled remotely with an AC mains switch.

If method 2 or 3 is chosen, the system could be sequenced down unintentionally in the unlikely event the first amplifier should fail (blow fuse). By switching on the power switches of the FIRST and SECOND amplifiers, it is possible to assure that the amplifiers will not prematurely sequence off. If method one is chosen then the amplifiers will always stay operating if the first or any other amplifier should fail. Even though the units may be sequenced on with a voltage as low as +5v, it is advisable to apply a voltage within +9 to +15 volts to assure this voltage will “carry through” the first amplifier should it fail.

Sequencing OFF – For method one, the units will sequence off if the first amplifier has its remote DC voltage switched off. For methods 2 and 3, the units will sequence off if the first amplifier's power switch is manually turned off. The units will sequence off at a slower rate than they sequence on. If the AC mains are switched off, the amplifiers will not sequence off, but will all turn off simultaneously.

Magnetic Flux Leakage Considerations

The PM-600 may be mounted without regard to any magnetic flux leakage (within reason). We recommend using a bit of common sense: it's not a good idea to mount any power amplifier near a microphone input transformer.

I/O Wiring

The PM-600 has three types of input connections (in order of reliability): barrier strip, XLR female, and 1/4 inch tip-ring-sleeve phone jack. Use the connector most appropriate to your installation. All input connectors are connected in parallel. For fixed installations, we recommend using the screw terminals with suitable crimp-on lugs attached to the wire. In addition, a ground system strap allows isolating the amplifier circuit ground from the AC line safety ground (green wire). Isolating the grounds may be necessary in some installations to break a ground loop.

XLR Connector Polarity (Pin 2 vs Pin 3)

The PM-600's XLR connectors may be wired for either pin 2 hot or pin 3 hot. An internal slide switch located behind the input connectors determines the configuration. The amplifier is supplied configured for pin 3 hot (+). See Fig. 4.

Note: The XLR connector polarity does not affect the polarity of the phone jack or the screw terminals. All input connectors are connected in parallel; you can parallel the amplifier inputs by patching an unused input connector to its counterpart on the other channel.

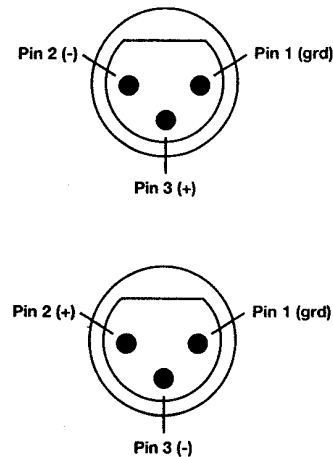

Fig. 4

Use the following procedure to change the polarity of the XLR connector.

1. Disconnect the amplifier from the source of AC power.
2. Remove the PM-600's top cover.
3. Locate the polarity-setting slide switch directly behind the input sockets.
4. Set the switch to "+2" position for Pin 2 hot, or "+3" position for Pin 3 hot.
5. Replace the top cover.

Output Connector Wiring

For stereo operation, use the red and black binding posts associated with each channel (see Figure 5). For bridged-mono operation, use both red binding posts (see Figure 6). The right-channel red post is the 'hot' side (non-inverting) and the left-channel red post is the 'low' side (inverting). In either case, ensure that the total load impedance is not lower than that listed in the specifications for the mode of operation that you have selected.

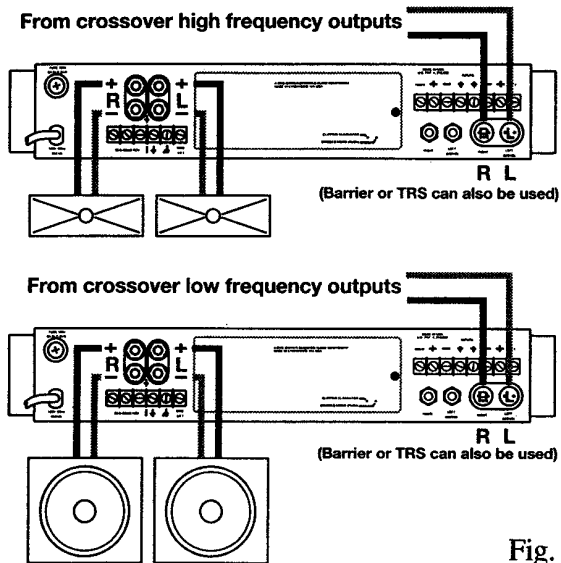

Fig. 5

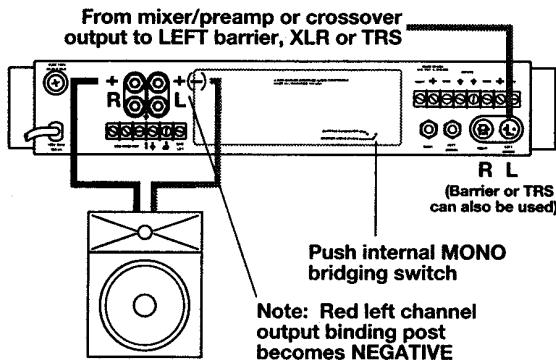

Fig.6

Ground Lift Strap

The ground lift strap is located on the rear chassis of the amplifier, near the speaker output binding posts. To break the link between the amplifier's circuit ground and the amplifier chassis, remove the metal link that connects the two terminals.

WARNING

For safety reasons, do not separate the ground systems unless absolutely necessary.

Interior Switch Settings

The PM-600 has two switches located behind the accessory panel that control mono-bridging and the clipping eliminator. Ensure that the amplifier is turned OFF before changing any switch settings.

Bridging Operation. One switch, located on the rear panel of the PM-600, enables bridging mode for the amplifier. For stereo operation, use the INPUT connectors and OUTPUT connectors associated with each channel. For bridged-mono operation, use the LEFT INPUT connector, and both red OUTPUT connections. The RIGHT output is the signal (non-inverting) connection, the LEFT output is the common (inverting) connection. Depress the switch using a small screwdriver or other such tool.

Note: In bridged-mono operation, the output connections are actually a balanced output configuration. This means that neither output terminal may be grounded (both are 'hot').

Caution

If you use phone plugs for speaker cables, beware! When connected to a bridged-mono amplifier, the shell of the plug is 'hot' and could cause a nasty surprise if it comes in contact with something that is grounded. At a minimum, insulate the shell of the plug with shrink sleeving.

WARNING

At clipping, the PM-600's peak output voltage at EACH of the output terminals approaches 56 volts (113 volts peak across both terminals in mono). While this isn't quite what comes out of a wall outlet, the voltage and current levels are similar enough to be accorded the same degree of respect (it CAN be lethal).

XLR Connector Polarity. THE TOP PANEL OF THE PM-600 MUST BE REMOVED TO ACCESS THIS SWITCH. The XLR connectors on the PM-600 may be configured for pin 2 hot or pin 3 hot. Sliding this switch changes the polarity convention used for the XLR input connectors from pin 3 hot to pin 2 hot. This switch does not affect the polarity of the barrier strip connections or the TRS phone jack. The amplifier is supplied set for pin 3 hot.

Clipping Eliminator. The CLIPPING ELIMINATOR switch turns on the anti-clipping feature of the PM-600. When the switch is pressed, input signals that are large enough to drive the amplifier output past clipping are reduced enough to keep the amplifier from clipping. The clipping eliminator circuit keeps the amplifier output below one percent THD at up to 8 dB of overdrive.

Note: If the input LEVEL control(s) are turned down far enough, a sufficiently large input signal could drive the input differential amplifier into clipping. Another possibility is that the mixer, equalizer, etc. that is driving the amplifier may not have sufficient output to overcome the loss introduced by the setting of the input LEVEL control(s). The CLIPPING ELIMINATOR switch has no effect on this cause of clipping.

Using the PM-600

Once the amplifier has been installed and wired into your system, you are ready to use it. Here are some tips to help you get the most from your PM-600.

- Check the switch settings on the rear panel. Be sure that the mono-mode switch conforms to the actual mode that you want.
- Use the clipping-eliminator feature. It helps save your loudspeakers from damage.
- Be sure that the input LEVEL controls are set sufficiently high to allow the preceding device in your system to drive the amplifier to full output. For most installations, the LEVEL controls are set fully clockwise.
- When you power the system up for the first time (out of the cartons), it's a good idea to start with all of the amplifier level controls off, then advance them slowly, one at a time, so that you can determine that each amplifier channel is operating normally.
- Once you have established settings, it is a good idea to mark them down, on paper, on pieces of tape, or sticky-dots attached to the amplifier's front panel.
- In bi-amplified (all multi-amp) systems, it is a good idea to start with the low-frequency amplifiers turned off or down, and to check each frequency range from highest to lowest to ensure that the proper loudspeaker components are reproducing it.

Using the PM-600 to drive 70V Distribution Systems

In bridged-mono mode, the PM-600 can drive a 70 volt distribution system directly. The maximum power capability is 624 watts at 70.7 volts into an 8 ohm system. (The actual power possible is higher since 700 watts across 8 ohms is 74.8 volts.)

A 70 volt transformer (XO-300) is also available.

THX® Installations

The PM-600 is approved for THX® installations. In order to avoid tampering with the level knobs once they are set, remove both level knobs with pliers and insert the supplied Level Defeat Plugs firmly, as shown in Figure 7 below.

Remove level knobs by pulling straight out with pliers. Protect knobs by wrapping cloth between knob and pliers.

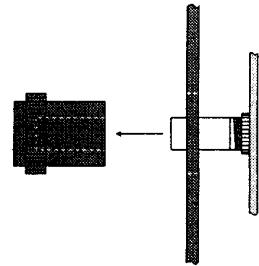

Install Level Defeat Plugs as shown, firmly seating into place.

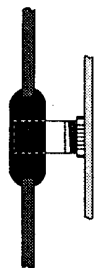
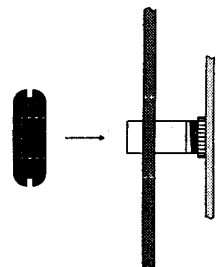

Fig. 7

5. Technical Information

Theory of Operation

This section discusses the theory of operation of the PM-600. For a better understanding of the circuitry involved, refer to the schematic diagrams presented later in this section. Op-amps used in the circuitry use the following notation: U1(7). This means op-amp U1, whose output appears on pin 7. The majority of the following discussion applies to the left amplifier channel; the right channel is substantially identical.

Low Level Circuitry

Input signals enter the circuit through the rear-panel XLR connector or tip-ring-sleeve (TRS) phone jacks. U2(1) is configured as a unity-gain, differential amplifier driving the left-channel level control. U201(7) is configured as a unity-gain inverting amplifier. In bridge-mode, U201(7) supplies an inverted input signal for the left amplifier channel while the right amplifier channel receives an identical but non-inverted input signal from the left channel input.

Power Amplifier Circuitry

The PM-600 uses the patented Carver Magnetic-Field Power Amplifier circuitry. This innovative circuit uses the combination of a smart power supply and a highly linear, three-rail power amplifier circuit. R201, R202, and U202 form an attenuator whose loss is dependent on the resistance of U202, a LED-LDR module. The drive for the LED portion of U202 comes from the clipping eliminator circuitry, which will be discussed later on. U201(1) is the input stage, providing differential inputs for input and feedback connections as well as some of the open-loop voltage gain of the circuit. R205 provides a local feedback loop around U201(1). The output of U201(1) drives Q201 and Q210, operating as common-emitter amplifiers that level-shift the drive signal and couple it to complementary common-emitter amplifiers Q202 and Q211. Q202 and Q211 provide additional voltage gain, which when combined with the voltage gain of the input op-amp is sufficient to swing the input signal between the +73 and -73 volt power supply

rails. Q203 and Q204 are connected as a NPN-PNP conjugate pair and are used as a V_{BE} multiplier for bias control. Q204 is thermally connected to the output transistors and together with Q203 provides bias stabilization over a wide temperature range. RP200 allows the bias current to be adjusted to its optimum value. Overall negative feedback from the output stage via R238 and R206 sets the closed-loop gain at 30.67 (29.73 dB). The specified 28.5 dB overall amplifier gain takes into account the small but finite losses associated with R67 and the input level controls as well as R201/R202. Up to now, the amplifier circuitry described has been fairly conventional. From this point on, there is a marked departure from convention. The positive-going portion of the output stage is comprised of three series-connected emitter-followers (Q219, Q207/Q208, Q209.). The negative-going portion of the output stage is exactly complementary to the positive-going portion; three series connected PNP, emitter followers (Q217, Q216/Q215, and Q222). The innermost pair (Q209/Q217), are driven from the opposite sides of the V_{BE} multiplier (Q203/Q204) via emitter-follower driver Q206. This looks suspiciously like a full-complementary amplifier (it is exactly that). Q214 is also connected as a V_{BE} multiplier to maintain the operating conditions of the Q217/Q209 output pair. Q205 operates as a VI limiter, sensing the voltage drop across emitter resistor R233, and reducing the drive signal going into the output stage under overload conditions. Q212 operates in similar fashion for the negative-portion of the output stage. R279 and D203 connect the positive current limit transistor's output to the display circuitry. If Q205 conducts, its collector current also turns on Q7, which turns on Q12. If the duration and amount of current limiting is severe enough, Q11 turns on, Q10 turns on, the gate of FET Q1 goes positive, and Q1 shunts the amplifier channel's input signal to ground. The middle set of output transistors, (Q207 and Q208), are driven from driver Q206. Diodes D206, D207, D208, and D209 initially force these transistors off and the innermost transistors on. This condition is true for output signals not exceeding around 22 volts peak. Once the drive signal from Q206 is sufficient to saturate Q209, Q207 and Q208 take over. D210 disconnects the +22 volt supply and the output signal can now swing to about +46 volts.

The outermost pair of output transistors, (Q219 and Q222), are driven (by means of Q218, Q220 and Q221, Q223) from the output terminal of the amplifier via diodes D220 and D223. Looking

again at the positive-half of the amplifier, Q220 level shifts the output signal towards the +73 volt supply rail. Zener D219 provides a voltage reference for Q220, preventing it from conducting until the base voltage exceeds 46V minus the 12V zener voltage. As long as the peak AC output voltage remains below this threshold, Q220 does not conduct. Once the AC output signal exceeds the threshold voltage, Q220 begins conducting, which turns on Q219. Q221, Q222, and Q223 function similarly for the negative-half of the amplifier. Diodes D218 and D221 are commutator diodes that disconnect the output stage from the 46V power supply whenever the voltage at the emitters of Q219 or Q222 exceeds 46 volts. Under high-frequency conditions, C218 and C221 provide phase lead for the outermost output transistors, ensuring that they can “stay ahead” of the audio signal. Under small-signal conditions, the innermost pair of transistors do all the work. As the signal level grows larger and larger, the middle pairs of transistors take over. Finally the outermost pair of transistors assume the remainder of the burden of providing a high voltage output signal to the load. This three-stage approach minimizes the voltage across each of the output devices and also minimizes the power dissipation required. Without this approach, the output transistors would be required to support the entire power supply voltage under small-signal conditions and the “unused” portion of the power supply voltage would be turned into heat. Returning to the LED/LDR opto isolator, U202, the LED portion of this component is driven from a bridge rectifier (D225-D228) that gets its input signal from U201(1). Under normal conditions (undistorted amplifier output) there is almost no signal at this point. If the amplifier is driven into clipping, the signal level at U201(1) rises rapidly because the feedback signal no longer represents the input signal. Once this occurs, the LED in U202 illuminates, reducing the input signal. The clipping-eliminator drive signal also drives the clip/protect indicator on the front panel via Q12.

Power Supply Circuitry

The main power supply for the PM-600 is a triple-voltage design that provides no-load voltages of +73, -73, +46, -46, +22, and -22 volts DC. The triac drives the primary of the magnetic-field power transformer by operating as a phase controlled switch; its gate signal depends on the signal supplied to opto-isolator U1, which isolates the drive

circuitry from the AC power line. Diode bridge D1 through D4 provides steering for the phototransistor in U1, allowing the triac to fire on both alternations of the power line. The phototransistor, resistors R2, R3, capacitor C4, and transistors Q1-Q4 make up a phase-shift firing circuit that fires the triac earlier or later in the AC cycle depending on the phototransistor’s conduction. R8 and R9 function during initial turn-on and cause the power supply to operate at a low level. This level is sufficient to make the amplifier’s internal regulation circuitry function which then takes over and brings the level of power supply activity to a point sufficient to sustain amplifier operation.

Note: The Magnetic Field Transformer primary voltage is set for 115 VAC operation by JP3, JP4 and to 230 VAC by JP1, JP2 on the regulator board.

A thermal switch disables the entire amplifier should the heat sink temperature exceeds 100 degrees Celsius. The front-panel power switch disables the triac’s firing circuits. This prevents the triac from conducting, which turns the amplifier off. The remote sequencing voltage supplies both base and collector current for Q5. Once Q5 conducts, opto-isolator U2 conducts and bridges the power switch terminals, turning the amplifier on. The remote sequencing voltage also operates Q6 after a delay established by R15 and C7. Once the internal power supply is operational, it supplies drive voltages to Q6 via D11 and to U2 and Q5 via D12. Q6 supplies the remote sequence voltage to the next amplifier in the chain.

Op-amp U1(1) drives the LED portion of opto-isolator U1. U1(1) operates as a differential amplifier whose inputs are each of the positive and negative power supplies, suitably scaled, plus an additional negative contribution via RP1. Because of the polarity of the input signals, U1(1) adds the absolute value of its input signals (after scaling) and inverts it. Thus, differences in the plus or minus power supplies cause U1(1)’s output to become more positive. As U1(1) goes more positive, the LED in OC1 glows more intensely, which causes the triac to be triggered earlier and earlier in the AC cycle. The net result is an increase in power supply activity that brings the voltage across the main filter capacitors back to plus and minus 73 volts. RP1 serves to adjust the quiescent voltage across the main filter capacitors to plus and minus 73 volts. U1(7) operates as a full-wave rectifier whose inputs are the low-frequency sum of the amplifier outputs (R44, R45, C7). R44 and R45 have different values to ensure circuit operation if

opposite halves of the amplifier decide to fail in opposite ways at the same time. U1(7) is normally -10 volts, unless there is either strong, sustained very-low frequency output or DC from either channel. When U1(7) goes positive, D7 and R31 sum this signal into the power supply diff-amp, which forces the supply off.

Display Circuit

The clipping indicators are driven by transistors Q9 and Q12 located on the amplifier PCB. The signal for the clipping indicators comes from the main amplifier boards from U201(1) via R8/D14. This is the same signal that operates the anti-clipping opto-isolator. The display driver circuit comprised of U1(4,3,12,10) and U2(3, 12, 10, 4) is basically a ladder comparator driving LEDs with a twist. Assume that the signal at U1 pin 2 is zero volts and ignore R23 and D4 for now.

R12 and R13 are a voltage divider that establishes a reference voltage for the comparators (four per channel).

The comparators compare their input signal against the voltages established by the tapped voltage divider made up of R21, R19, R17, and R24. The left channel LEDs are in the following sequence (lowest to highest): D11 (green), D10 (red), D9 (red), D8 (red), D7 (red), D6 (red), D5

(yellow). The display board receives audio via J1. The audio is positive half-wave rectified and smoothed via D22/C2. With the input signal at zero volts, all of the comparator outputs are at -11.4 volts except for U1(4) which is high. None of the LEDs (D6-D10, D13-D17) have any voltage across them; all are extinguished.

As the input signal rises, it crosses, in sequence, the thresholds established at each of the four comparators. First U1(3) fires; its output goes high, and D10 illuminates. Next U1(12) fires, its output goes high; D10 extinguishes (no net voltage across it) and D9 illuminates. Finally U1(10) fires; D9 extinguishes, and (this is the twist) D4/R23 supply current to the bottom of the R17, R19, and R21 voltage divider, which inverts the relationship of the comparators to each other. When U1(10) fires, the current through R23 reverses the sequence of the voltages that establish the thresholds for the three comparators. This allows the same comparators to perform double-duty. The new thresholds leave U1(10) high, U1(4) low, U1(12) and U1(3) low and D8 on. D6 and D7 are off.

As the input signal rises further, U1(12) fires, extinguishing D8 and illuminating D7. Next, U1(3) fires, extinguishing D7 and illuminating D6. Finally U1(4) fires, extinguishing D6. The last LED is the clipping indicator, D5.

605-00412-00 Part 1 of 2
Schematic AMP PM600

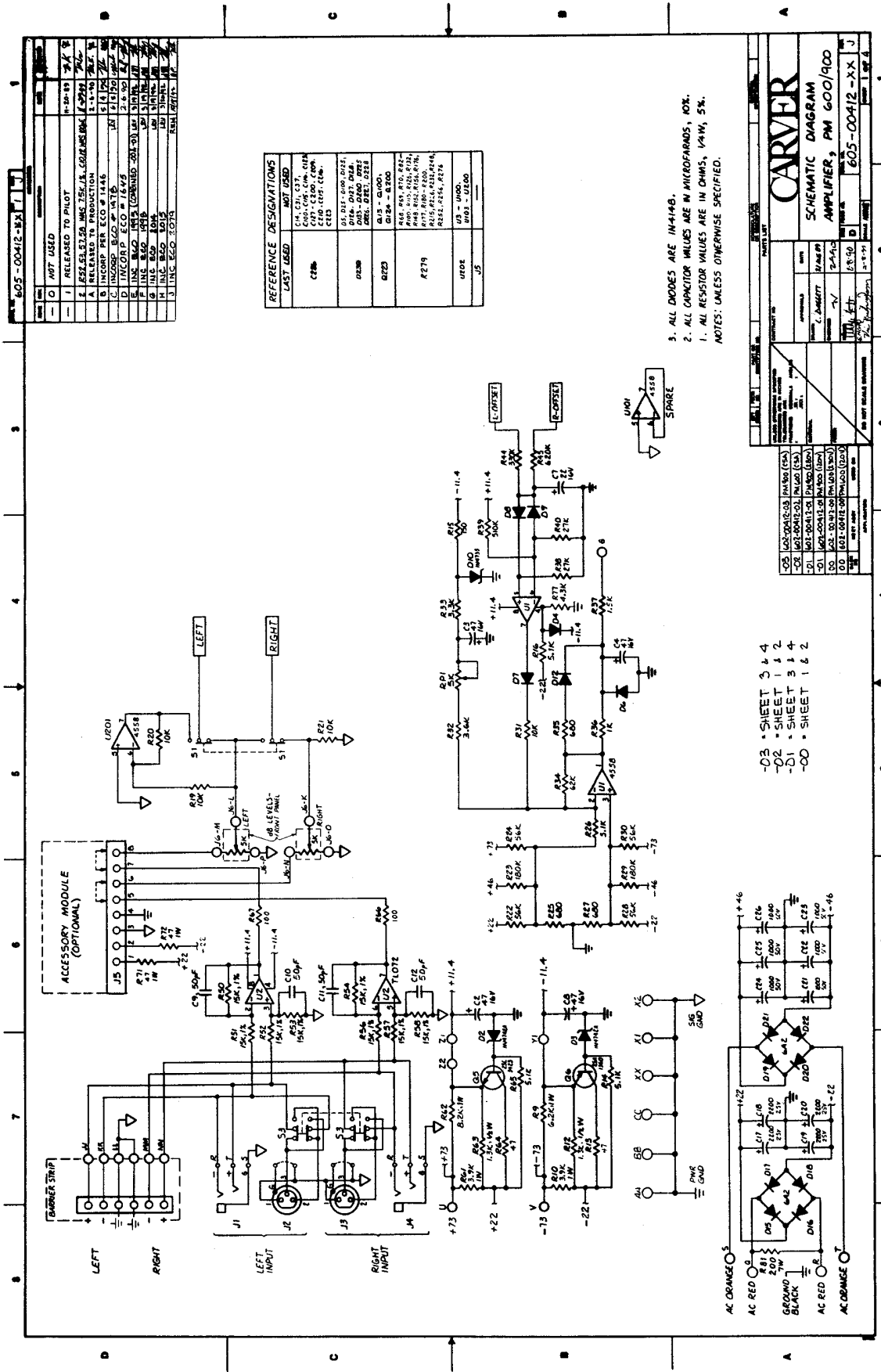

605-00412-00 Part 1 of 2

REV	DESCRIPTION	DATE	BY
0	NOT USED	11-28-65	JK B
1	RELEASED TO PILOT		
2	REVISED TO INC. 75K/1K COUPLER W/1000		
3	RELEASED TO PILOT		
4	REVISION FOR EXPLANATION		
5	REVISION FOR EXPLANATION		
6	INCORP BCO = 157K		
7	INCORP ECU = 164K		
8	INC BCO = 157K		
9	INC BCO = 157K		
10	INC BCO = 157K		
11	INC BCO = 157K		
12	INC BCO = 157K		
13	INC BCO = 157K		
14	INC BCO = 157K		
15	INC BCO = 157K		
16	INC BCO = 157K		
17	INC BCO = 157K		
18	INC BCO = 157K		
19	INC BCO = 157K		
20	INC BCO = 157K		
21	INC BCO = 157K		
22	INC BCO = 157K		
23	INC BCO = 157K		
24	INC BCO = 157K		
25	INC BCO = 157K		
26	INC BCO = 157K		
27	INC BCO = 157K		
28	INC BCO = 157K		
29	INC BCO = 157K		
30	INC BCO = 157K		
31	INC BCO = 157K		
32	INC BCO = 157K		
33	INC BCO = 157K		
34	INC BCO = 157K		
35	INC BCO = 157K		
36	INC BCO = 157K		
37	INC BCO = 157K		
38	INC BCO = 157K		
39	INC BCO = 157K		
40	INC BCO = 157K		
41	INC BCO = 157K		
42	INC BCO = 157K		
43	INC BCO = 157K		
44	INC BCO = 157K		
45	INC BCO = 157K		
46	INC BCO = 157K		
47	INC BCO = 157K		
48	INC BCO = 157K		
49	INC BCO = 157K		
50	INC BCO = 157K		
51	INC BCO = 157K		
52	INC BCO = 157K		
53	INC BCO = 157K		
54	INC BCO = 157K		
55	INC BCO = 157K		
56	INC BCO = 157K		
57	INC BCO = 157K		
58	INC BCO = 157K		
59	INC BCO = 157K		
60	INC BCO = 157K		
61	INC BCO = 157K		
62	INC BCO = 157K		
63	INC BCO = 157K		
64	INC BCO = 157K		
65	INC BCO = 157K		
66	INC BCO = 157K		
67	INC BCO = 157K		
68	INC BCO = 157K		
69	INC BCO = 157K		
70	INC BCO = 157K		
71	INC BCO = 157K		
72	INC BCO = 157K		
73	INC BCO = 157K		
74	INC BCO = 157K		
75	INC BCO = 157K		
76	INC BCO = 157K		
77	INC BCO = 157K		
78	INC BCO = 157K		
79	INC BCO = 157K		
80	INC BCO = 157K		
81	INC BCO = 157K		
82	INC BCO = 157K		
83	INC BCO = 157K		
84	INC BCO = 157K		
85	INC BCO = 157K		
86	INC BCO = 157K		
87	INC BCO = 157K		
88	INC BCO = 157K		
89	INC BCO = 157K		
90	INC BCO = 157K		
91	INC BCO = 157K		
92	INC BCO = 157K		
93	INC BCO = 157K		
94	INC BCO = 157K		
95	INC BCO = 157K		
96	INC BCO = 157K		
97	INC BCO = 157K		
98	INC BCO = 157K		
99	INC BCO = 157K		
100	INC BCO = 157K		

REFERENCE DESIGNATIONS

LAST USED	NOT USED
C14, C17, C27, C37, C40, C43, C46, C49, C52, C55, C58, C61, C64, C67, C70, C73, C76, C79, C82, C85, C88, C91, C94, C97, C100	
D1, D2, D3, D4, D5, D6, D7, D8, D9, D10, D11, D12, D13, D14, D15, D16, D17, D18, D19, D20, D21, D22, D23, D24, D25, D26, D27, D28, D29, D30, D31, D32, D33, D34, D35, D36, D37, D38, D39, D40, D41, D42, D43, D44, D45, D46, D47, D48, D49, D50, D51, D52, D53, D54, D55, D56, D57, D58, D59, D60, D61, D62, D63, D64, D65, D66, D67, D68, D69, D70, D71, D72, D73, D74, D75, D76, D77, D78, D79, D80, D81, D82, D83, D84, D85, D86, D87, D88, D89, D90, D91, D92, D93, D94, D95, D96, D97, D98, D99, D100	
R1, R2, R3, R4, R5, R6, R7, R8, R9, R10, R11, R12, R13, R14, R15, R16, R17, R18, R19, R20, R21, R22, R23, R24, R25, R26, R27, R28, R29, R30, R31, R32, R33, R34, R35, R36, R37, R38, R39, R40, R41, R42, R43, R44, R45, R46, R47, R48, R49, R50, R51, R52, R53, R54, R55, R56, R57, R58, R59, R60, R61, R62, R63, R64, R65, R66, R67, R68, R69, R70, R71, R72, R73, R74, R75, R76, R77, R78, R79, R80, R81, R82, R83, R84, R85, R86, R87, R88, R89, R90, R91, R92, R93, R94, R95, R96, R97, R98, R99, R100	
U1, U2, U3, U4, U5, U6, U7, U8, U9, U10	

3. ALL DIODES ARE IN-114B.
2. ALL CAPACITOR VALUES ARE IN MICROFARADS, NOT.
1. ALL RESISTOR VALUES ARE IN OHMS, 1/4W, 5%.
NOTES: UNLESS OTHERWISE SPECIFIED.

CARVER
SCHEMATIC DIAGRAM
AMPLIFIER, PM 600/100

REV	DESCRIPTION	DATE	BY
1	INITIAL	11-28-65	JK B
2			
3			
4			
5			
6			
7			
8			
9			
10			
11			
12			
13			
14			
15			
16			
17			
18			
19			
20			
21			
22			
23			
24			
25			
26			
27			
28			
29			
30			
31			
32			
33			
34			
35			
36			
37			
38			
39			
40			
41			
42			
43			
44			
45			
46			
47			
48			
49			
50			
51			
52			
53			
54			
55			
56			
57			
58			
59			
60			
61			
62			
63			
64			
65			
66			
67			
68			
69			
70			
71			
72			
73			
74			
75			
76			
77			
78			
79			
80			
81			
82			
83			
84			
85			
86			
87			
88			
89			
90			
91			
92			
93			
94			
95			
96			
97			
98			
99			
100			

-03 * SHEET 3 4 4
-02 * SHEET 1 4 2
-01 * SHEET 3 4 4
-00 * SHEET 1 4 2

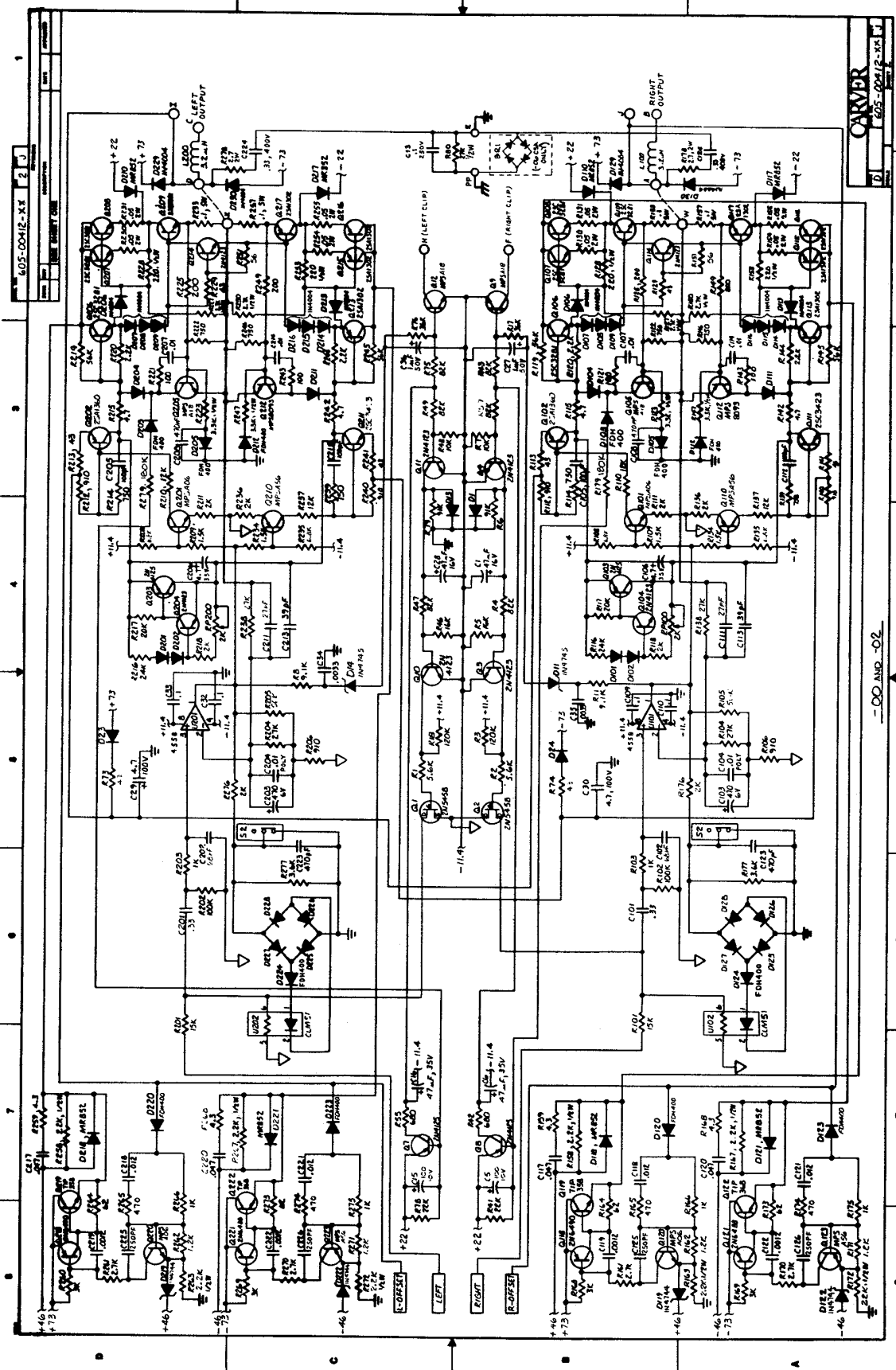

CARVER
605-00412-00

605-XX411-00 SMT 1
Schematic Reg PM600/600

REV	DATE	DESCRIPTION	BY	CHK
1	10-22-68	SCHEMATIC WAS 800/400 BOARD	7A	7A
2	10-22-68	10-22-68: 7A, 10-22-68: 7A, 10-22-68: 7A, 10-22-68: 7A	7A	7A
3	10-22-68	10-22-68: 7A, 10-22-68: 7A, 10-22-68: 7A, 10-22-68: 7A	7A	7A
4	10-22-68	10-22-68: 7A, 10-22-68: 7A, 10-22-68: 7A, 10-22-68: 7A	7A	7A
5	10-22-68	10-22-68: 7A, 10-22-68: 7A, 10-22-68: 7A, 10-22-68: 7A	7A	7A
6	10-22-68	10-22-68: 7A, 10-22-68: 7A, 10-22-68: 7A, 10-22-68: 7A	7A	7A
7	10-22-68	10-22-68: 7A, 10-22-68: 7A, 10-22-68: 7A, 10-22-68: 7A	7A	7A
8	10-22-68	10-22-68: 7A, 10-22-68: 7A, 10-22-68: 7A, 10-22-68: 7A	7A	7A
9	10-22-68	10-22-68: 7A, 10-22-68: 7A, 10-22-68: 7A, 10-22-68: 7A	7A	7A

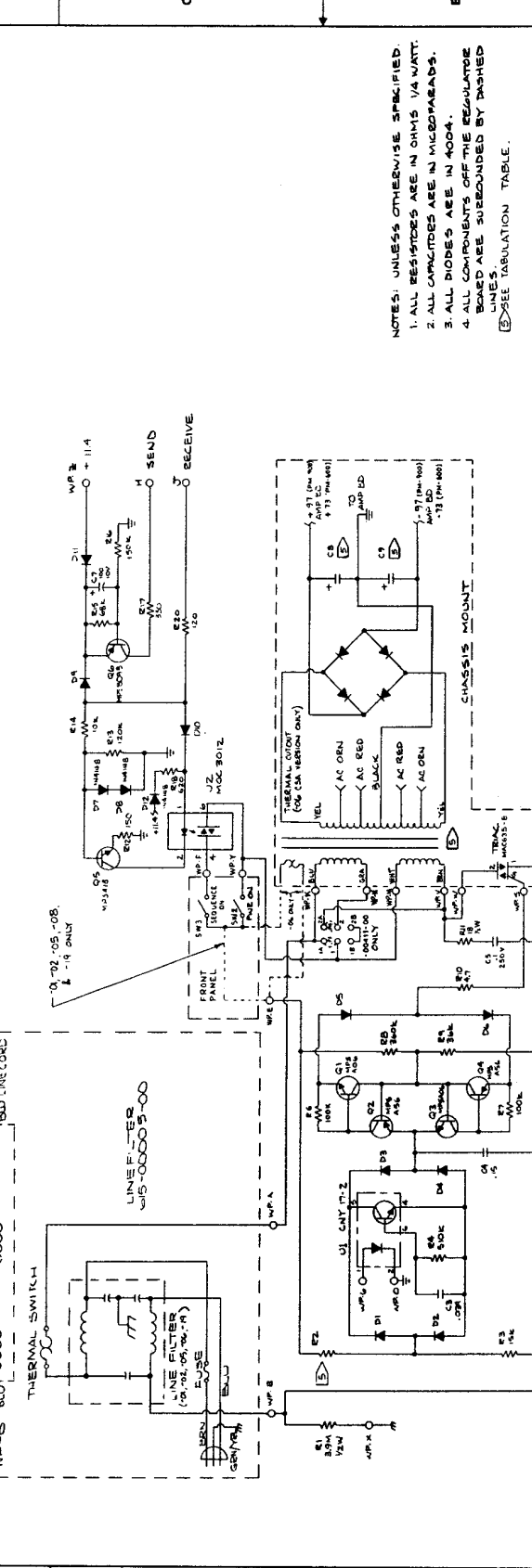

USED IN (BOARD)	MODEL	VERSION	TRANSFORMER PIN	ADDRESS	CAPACITIVE VALUE	RESISTIVE VALUE
605-XX411-00	PM600	CSA	1	7P 1/2	9800	10K, 75M
605-XX411-00	PM600	CSA	2	7P 1/2	4800	10K, 75M
605-XX411-00	PM600	CSA	3	7P 1/2	4800	10K, 75M
605-XX411-00	PM600	CSA	4	7P 1/2	4800	10K, 75M
605-XX411-00	PM600	CSA	5	7P 1/2	4800	10K, 75M
605-XX411-00	PM600	CSA	6	7P 1/2	4800	10K, 75M
605-XX411-00	PM600	CSA	7	7P 1/2	4800	10K, 75M
605-XX411-00	PM600	CSA	8	7P 1/2	4800	10K, 75M
605-XX411-00	PM600	CSA	9	7P 1/2	4800	10K, 75M
605-XX411-00	PM600	CSA	10	7P 1/2	4800	10K, 75M
605-XX411-00	PM600	CSA	11	7P 1/2	4800	10K, 75M
605-XX411-00	PM600	CSA	12	7P 1/2	4800	10K, 75M
605-XX411-00	PM600	CSA	13	7P 1/2	4800	10K, 75M
605-XX411-00	PM600	CSA	14	7P 1/2	4800	10K, 75M
605-XX411-00	PM600	CSA	15	7P 1/2	4800	10K, 75M
605-XX411-00	PM600	CSA	16	7P 1/2	4800	10K, 75M
605-XX411-00	PM600	CSA	17	7P 1/2	4800	10K, 75M
605-XX411-00	PM600	CSA	18	7P 1/2	4800	10K, 75M
605-XX411-00	PM600	CSA	19	7P 1/2	4800	10K, 75M
605-XX411-00	PM600	CSA	20	7P 1/2	4800	10K, 75M

CARVER
SCHEMATIC
REGULATOR BOARD

- NOTES: UNLESS OTHERWISE SPECIFIED:
 1. ALL RESISTORS ARE IN OHMS UNLESS OTHERWISE SPECIFIED.
 2. ALL CAPACITORS ARE IN MICROFARADS.
 3. ALL DIODES ARE IN MICROFARADS.
 4. ALL COMPONENTS OFF THE REGULATOR BOARD ARE SURROUNDED BY DASHED LINES.
 5. SEE TABULATION TABLE.

APPROVALS	DATE	BY	CHK
DESIGNED BY	7-21-68	7A	7A
CHECKED BY	7-21-68	7A	7A
TESTED BY	7-21-68	7A	7A
ASSEMBLED BY	7-21-68	7A	7A
INSPECTED BY	7-21-68	7A	7A
DO NOT SCALE DRAWING			

605-00410-00 SHT 1
Schematic Display PM600/800

ZONE	REV	DESCRIPTION	DATE	APPROVED
0		PROTOTYPED	7-19-79	JAC
1		RELEASED TO PILOT (PM 600)	9-20-79	JAC
2		RELEASED TO PILOT (PM 900)	12-4-89	JAC
A		RELEASE TO PRODUCTION	1-7-90	JAC

CONTRACT NO	DATE
TB	7-17-79
DESIGNED BY	DATE
J. EDWARDS	7-19-79
ISSUED BY	DATE
JAC	2-9-80
REVISIONS	DATE
1	12-7-93
2	3/8/90

UNLESS OTHERWISE SPECIFIED	MATERIAL
DIMENSIONS ARE IN INCHES	
FRACTIONS DECIMALS ANGLES	
PLACES ARE	
00 602-00410-00	PM 900
00 602-00410-00	PM 500
NET ASSEMBLY	USED ON

DO NOT SCALE DRAWING	SCALE
	PM 600/900
	100%

CONTRACT NO	DATE
TB	7-17-79
DESIGNED BY	DATE
J. EDWARDS	7-19-79
ISSUED BY	DATE
JAC	2-9-80
REVISIONS	DATE
1	12-7-93
2	3/8/90

UNLESS OTHERWISE SPECIFIED	MATERIAL
DIMENSIONS ARE IN INCHES	
FRACTIONS DECIMALS ANGLES	
PLACES ARE	
00 602-00410-00	PM 900
00 602-00410-00	PM 500
NET ASSEMBLY	USED ON

DO NOT SCALE DRAWING	SCALE
	PM 600/900
	100%

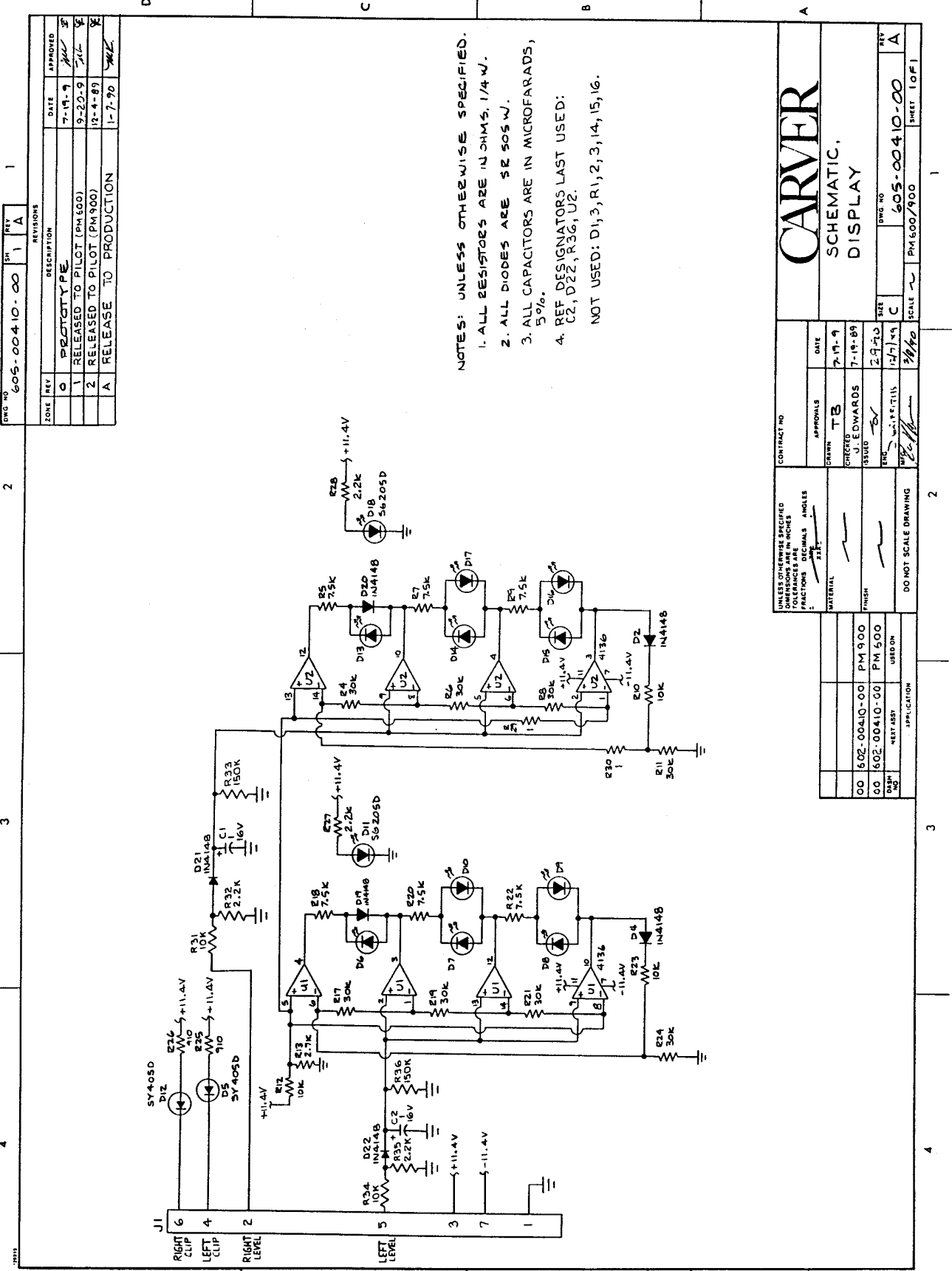

NOTES: UNLESS OTHERWISE SPECIFIED.
 1. ALL RESISTORS ARE IN OHMS, 1/4 W.
 2. ALL DIODES ARE 5R 50S W.
 3. ALL CAPACITORS ARE IN MICROFARADS, 5%.
 4. REF DESIGNATORS LAST USED:
 C2, D22, R36, U2.
 NOT USED: D1, 3, R1, 2, 3, 14, 15, 16.

CARVER

SCHEMATIC DISPLAY

606-00100-XX SMT 1pp
Wiring Diagram PM-600

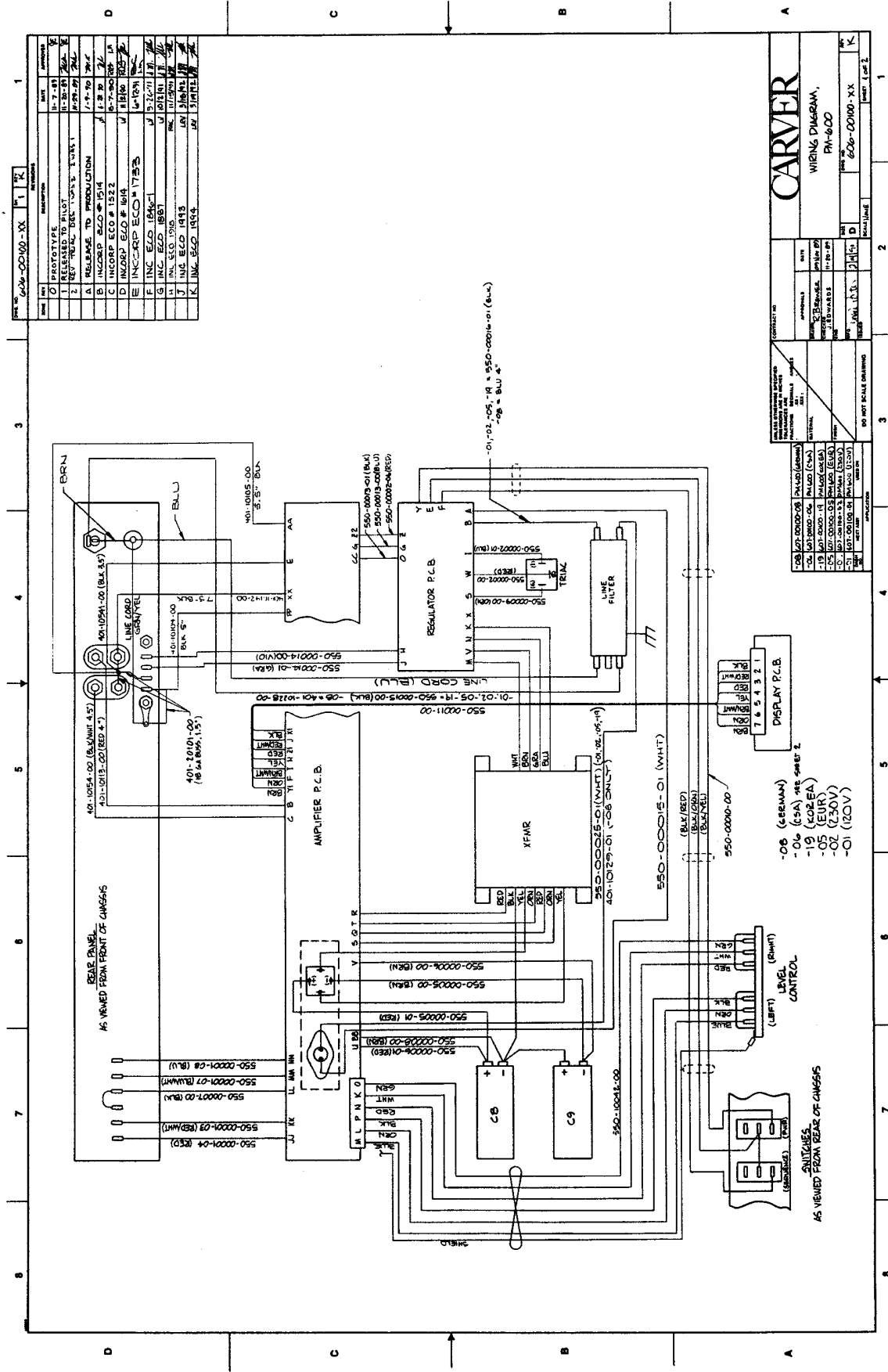

REV	DESCRIPTION	DATE	APPROVED
0	PROTOTYPE	11-7-61	
1	RELEASED TO PILOT	11-15-61	
2	REVISED DES. TO ST. 1001	11-29-61	
A	RELEASED TO PRODUCTION	1-11-70	
B	INCORP ECG # 1514	1-11-70	
C	INCORP ECG # 1522	1-11-70	
D	INCORP ECG # 1518	1-11-70	
E	INCORP ECG # 1735	1-11-70	
F	INC ECG 1567	1-11-70	
G	INC ECG 1567	1-11-70	
H	INC ECG 1567	1-11-70	
I	INC ECG 1567	1-11-70	
J	INC ECG 1567	1-11-70	
K	INC ECG 1567	1-11-70	

CARVER

WIRING DIAGRAM,
PM-600

REV: 006-00100-XX

DATE: 11-7-61

BY: [Signature]

CHKD: [Signature]

APP: [Signature]

DO NOT SCALE DRAWING

NOTES

NOTES

6. In Case of Difficulty

If the PM-600 should fail to operate, here is a list of things to check before contacting an Authorized Carver Service Center (or the factory).

No lights, no sound

No lights, no sound is usually a power supply problem (either the power line itself, or the amplifier's power supply).

- Is the amplifier plugged in?
- Is the fuse okay?
- Is the power switch set to ON?
- Has the amplifier overheated?

Low Output or No Output

Low or no output problems are usually signal-source, bad cable, or partial-output short circuit problems. If the items below are okay, then the problem is internal to the PM-600.

- Are the input LEVEL controls set to their normal settings?
- Move the input connections to another amplifier that you know is working to verify that it is not a source problem.
- Check the speaker connections. Be sure that there are no small strands of wire touching similar strands coming from the other wire in the cable. If you use banana plugs, be sure that the setscrews in the plug are securely tightened.
- Are the speakers okay?
- Check the settings of the bridging mode switch. The mono mode uses only the LEFT input connector.

Distortion

Distortion is usually caused by excessive loss in the input controls (the mixer/equalizer/crossover can't produce enough output), overdriving resulting in output clipping, or current limiting caused by excessively low load impedances.

- Check the setting of the input level controls. If set too low, the preceding piece of equipment may not have sufficient output to overcome the loss. This is especially possible if you hear distortion, but the yellow PROTECTION LED(s) are not illuminated.
- If the yellow PROTECTION LED is illuminated, check the speaker connections; verify that all setscrews are tight and that there are no stray strands of wire to cause short circuits.
- Verify that the total load impedance presented to the amplifier is within the limits described in this manual for the mode of operation selected.

Protection LED Illuminated

The protection LED responds to sustained clipping, high-frequency overload or current limiting.

- Check speaker cables for shorts.
- Are the speakers okay?
- Are you driving the amplifier into sustained clipping?
- Severe high-frequency overload at the outputs will also cause the PROTECTION LED to illuminate. Disconnect the input cables or turn the LEVEL controls off. If the LED extinguishes, look at the source equipment for the problem. If not, the problem is internal to the PM-600.

7. Warranty Information

Note: We suggest you read the LIMITED WARRANTY completely to fully understand your warranty/service coverage. Please promptly complete and return the WARRANTY REGISTRATION CARD. Also be sure to save the sales receipt in a safe place. It will be necessary for warranty service.

If your CARVER product should require service, we suggest you contact the Dealer from whom you purchased your unit. Should the Dealer be unable to take care of your needs, you may contact CARVER Technical Service Department by phoning (206) 775-6245, or by writing to us at the factory address shown at the right. We will then direct you to the nearest in our national network of Authorized Warranty Service Centers or give you detailed instructions on how to return the product to us for prompt action.

If you should have questions or comments, please write to the factory address given below. Please include the model and serial number of your Carver product, your complete address, and a daytime phone number.

Factory Address

Carver Corporation Service Department
P.O. Box 1237
Lynnwood Washington, 98046
(206) 775-6245

Carver Corporation reserves the right to improve its products at any time. Therefore, specifications are subject to change without notice.

THX® is a registered trademark of LucasArts Entertainment Co. All rights reserved.

© 1992 All rights reserved, Carver Corporation.

Pub #900414-B

Part #990-20077-00 Rev. B

Printed in the United States of America

Magnetic Field technology protected under U.S. Patent 4,218,660

CARVER

P R O F E S S I O N A L