

CASIO®

SERVICE MANUAL

& PARTS LIST (without price)

AP-200

FEB. 2008



AP-200

ELECTRONIC KEYBOARD

Ver.1 : Aug. 2008

CONTENTS

SPECIFICATIONS	1
BLOCK AND WIRING DIAGRAM	2
PCB LAYOUT	3
CIRCUIT DESCRIPTION	4
PRINTED CIRCUIT BOARDS	5
DISASSEMBLY	10
DIAGNOSTIC PROGRAM	21
EXPLODED VIEW	24
PARTS LIST	26
SCHEMATIC DIAGRAMS	30

SPECIFICATIONS

Keyboard:	88-key piano keyboard, with Touch Response
Maximum Polyphony:	128 notes
Tones:	11 <ul style="list-style-type: none">• Layer (excluding bass tones)• Split (Low-range bass tones only)
Effects :	Brilliance (-3 to 0 to 3), Reverb (4 types), Chorus (4 types), Acoustic Resonance
Metronome :	<ul style="list-style-type: none">• Beats: 0, 2, 3, 4, 6• Tempo Range: 20 to 255
Duet :	Adjustable tone range (-2 to 0 to 1 octaves)
Music Library :	<ul style="list-style-type: none">• Number of Songs: 60• Song volume: Adjustable• Part On/Off: L, R
Recorder :	<ul style="list-style-type: none">• Functions: Real-time recording, playback• Number of Song: 1• Number of Tracks: 2• Capacity: Approximately 5,000 notes total• Recorded Data Protection: Built-in flash memory
Pedals :	Damper, soft, sostenuto
Other Functions :	<ul style="list-style-type: none">• Touch Select: 3 types, Off• Transpose: ± 1 octaves (-12 to 0 to 12)• Tuning: A4 = 440.0 Hz ± 99 cents (variable)• Operation Lock
MIDI :	16-channel multi-timbre receive
Inputs/Outputs :	<ul style="list-style-type: none">• PHONES jack: Stereo standard jacks $\times 2$ Output impedance: 170Ω Output Voltage: 5.6V (RMS) MAX• Power: 12V DC• MIDI OUT/IN terminals• Pedal connector
Speakers:	Φ 12cm $\times 2$ (Output 8W + 8W)
Power Requirements :	AC Adaptor: AD-12
Power Consumption :	12V \approx 18W
Dimensions :	Digital Piano and Stand: 139.5 (W) \times 43.2 (D) \times 83.8 (H) cm (54 $\frac{15}{16}$ \times 17 \times 33 inch)
Weight :	Digital Piano and Stand: approximately 37.5 kg (82.7 lbs)

BLOCK AND WIRING DIAGRAM

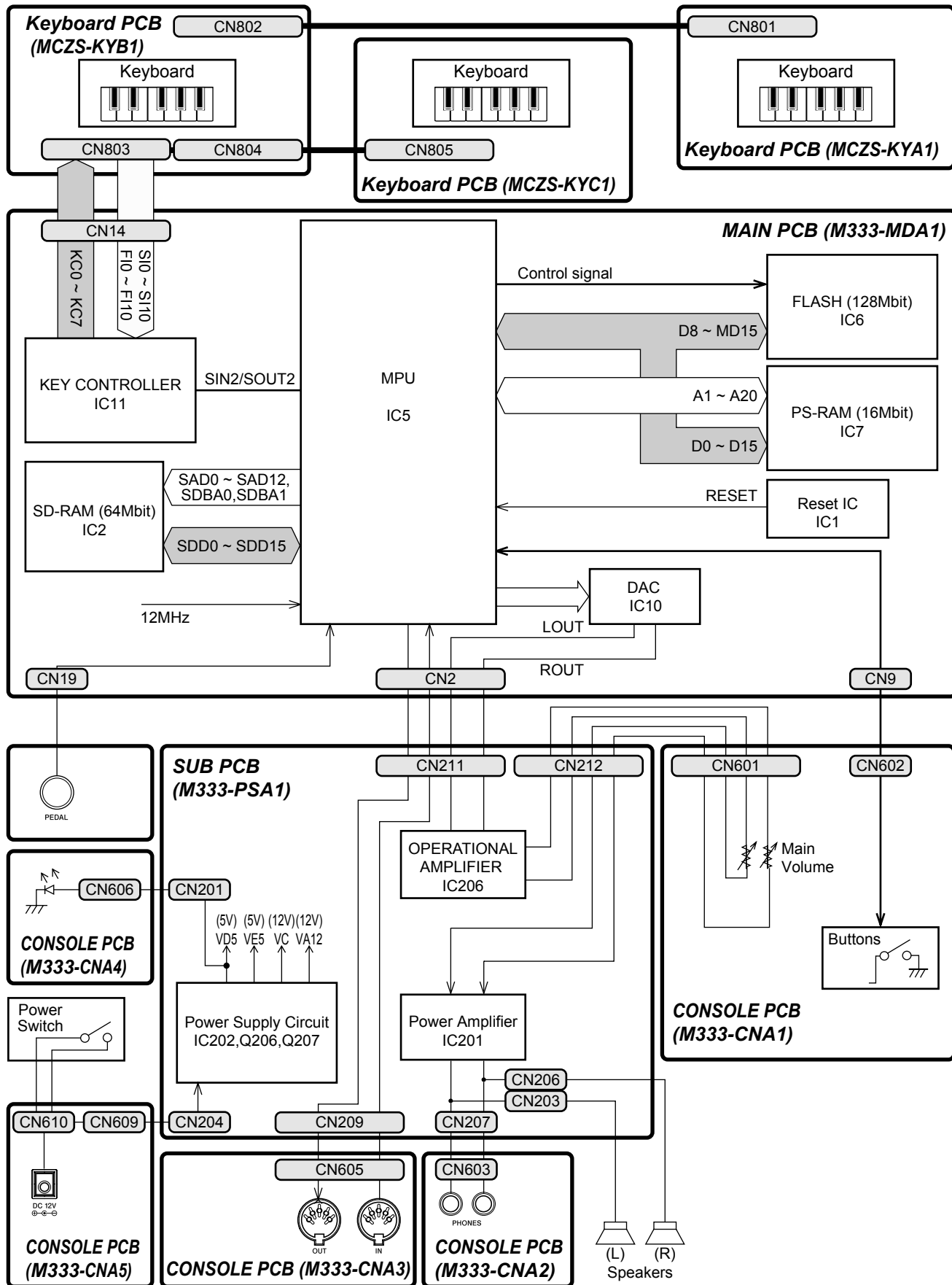

PCB LAYOUT

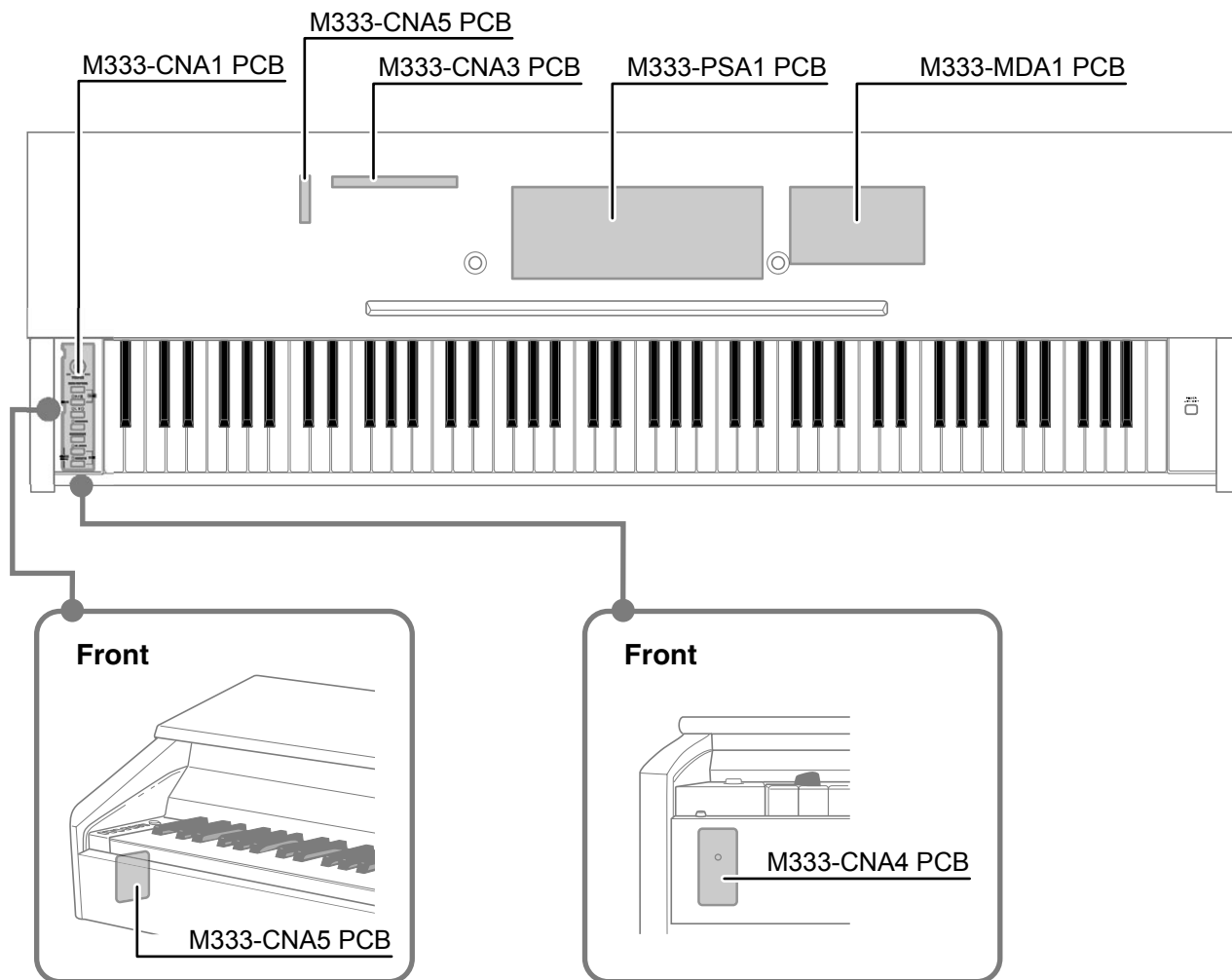

	PCB	Components
MAIN PCB	M333-MDA1	MPU, Reset IC, RAM(64Mbit), FLASH memory(128Mbit), ROM(16Mbit), DAC, Key controller
SUB PCB	M333-PSA1	Power supply circuit, Power amplifier
Console PCBs	M333-CNA1	Main volume
	M333-CNA2	Button
	M333-CNA3	DC 12V terminal, DAMPER PEDAL
	M333-CNA4	MIDI OUT/IN terminals
	M333-CNA5	Phones jack

CIRCUIT DESCRIPTION

KEY MATRIX

	KC0	KC1	KC2	KC3	KC4	KC5	KC6	KC7
FI0	A0①	A0#①	B0①	C1①	C1#①	D1①	D1#①	E1①
SI0	A0②	A0#②	B0②	C1②	C1#②	D1②	D1#②	E1②
FI1	F1①	F1#①	G1①	G1#①	A1①	A1#①	B1①	C2①
SI1	F1②	F1#②	G1②	G1#②	A1②	A1#②	B1②	C2②
FI2	C2#①	D2①	D2#①	E2①	F2①	F2#①	G2①	G2#①
SI2	C2#②	D2②	D2#②	E2②	F2②	F2#②	G2②	G2#②
FI3	A2①	A2#①	B2①	C3①	C3#①	D3①	D3#①	E3①
SI3	A2②	A2#②	B2②	C3②	C3#②	D3②	D3#②	E3②
FI4	F3①	F3#①	G3①	G3#①	A3①	A3#①	B3①	C4①
SI4	F3②	F3#②	G3②	G3#②	A3②	A3#②	B3②	C4②
FI5	C4#①	D4①	D4#①	E4①	F4①	F4#①	G4①	G4#①
SI5	C4#②	D4②	D4#②	E4②	F4②	F4#②	G4②	G4#②
FI6	A4①	A4#①	B4①	C5①	C5#①	D5①	D5#①	E5①
SI6	A4②	A4#②	B4②	C5②	C5#②	D5②	D5#②	E5②
FI7	F5①	F5#①	G5①	G5#①	A5①	A5#①	B5①	C6①
SI7	F5②	F5#②	G5②	G5#②	A5②	A5#②	B5②	C6②
FI8	C6#①	D6①	D6#①	E6①	F6①	F6#①	G6①	G6#①
SI8	C6#②	D6②	D6#②	E6②	F6②	F6#②	G6②	G6#②
FI9	A6①	A6#①	B6①	C7①	C7#①	D7①	D7#①	E7①
SI9	A6②	A6#②	B6②	C7②	C7#②	D7②	D7#②	E7②
FI10	F7①	F7#①	G7①	G7#①	A7①	A7#①	B7①	C8①
SI10	F7②	F7#②	G7②	G7#②	A7②	A7#②	B7②	C8②

NOMENCLATURE OF KEYS

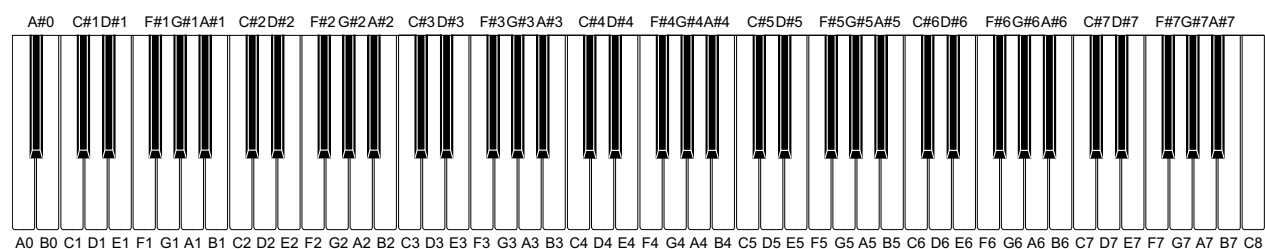

BUTTON MATRIX

	SWB	SWC	SWD	SWE
SI0	SONG ▶/■	MODERN	METRONOME	
SI1	L / R	RECORDER	CLASSIC	STONE/ SETTING

PRINTED CIRCUIT BOARDS

Main PCB M333-MDA1

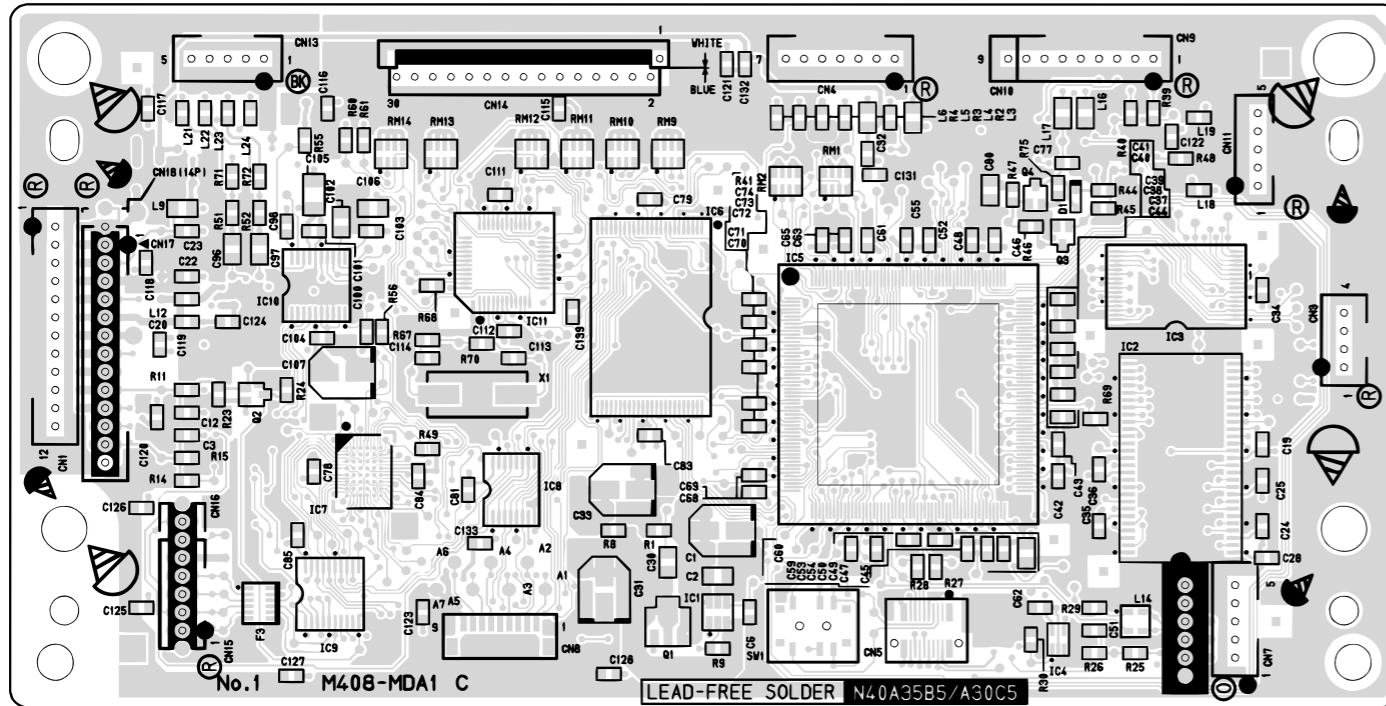

Top View

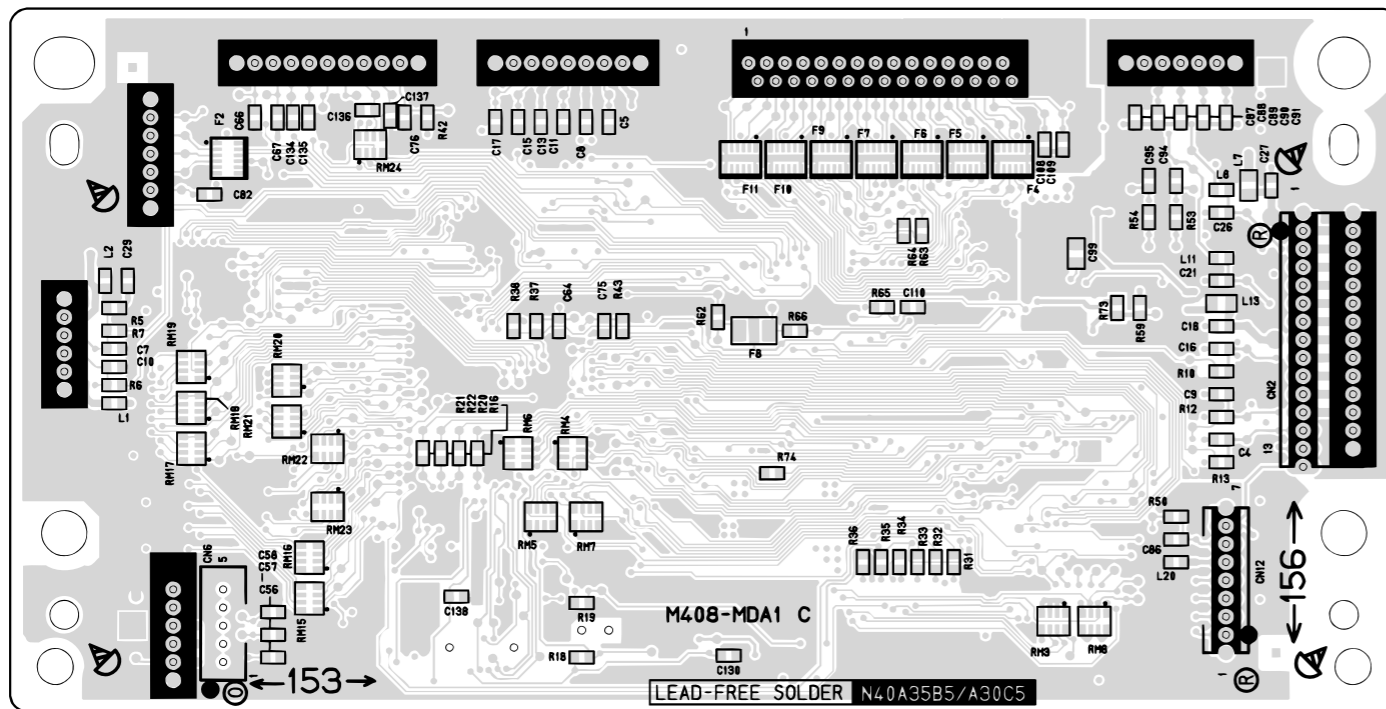

Bottom View

Sub PCB M333-PSA1

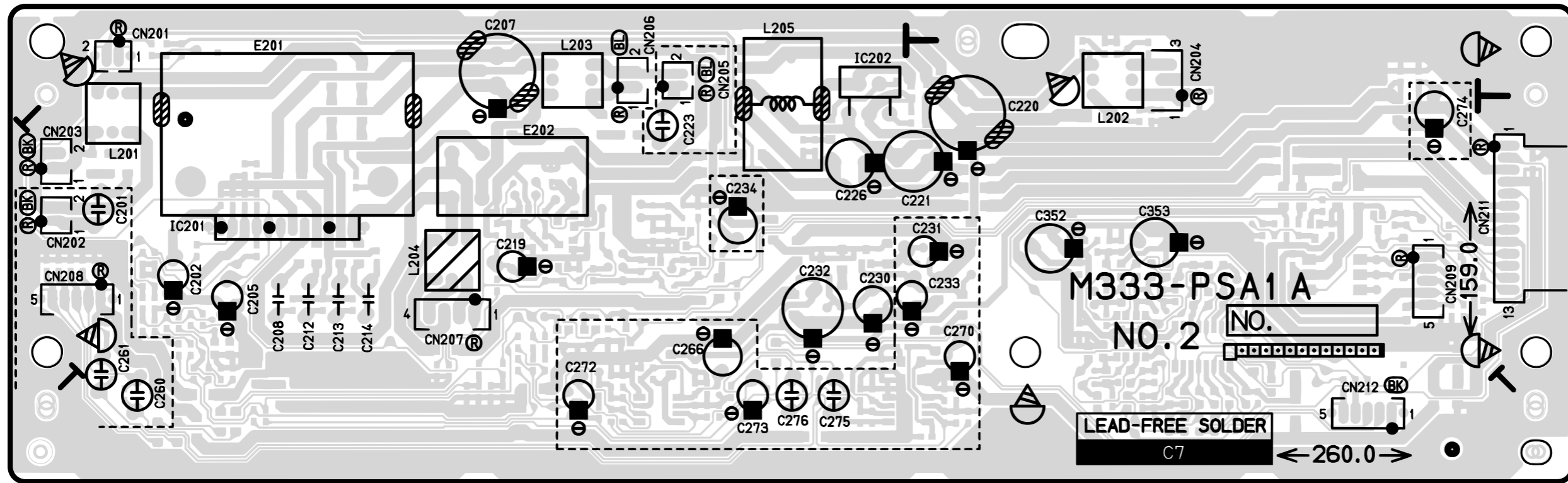

Top View

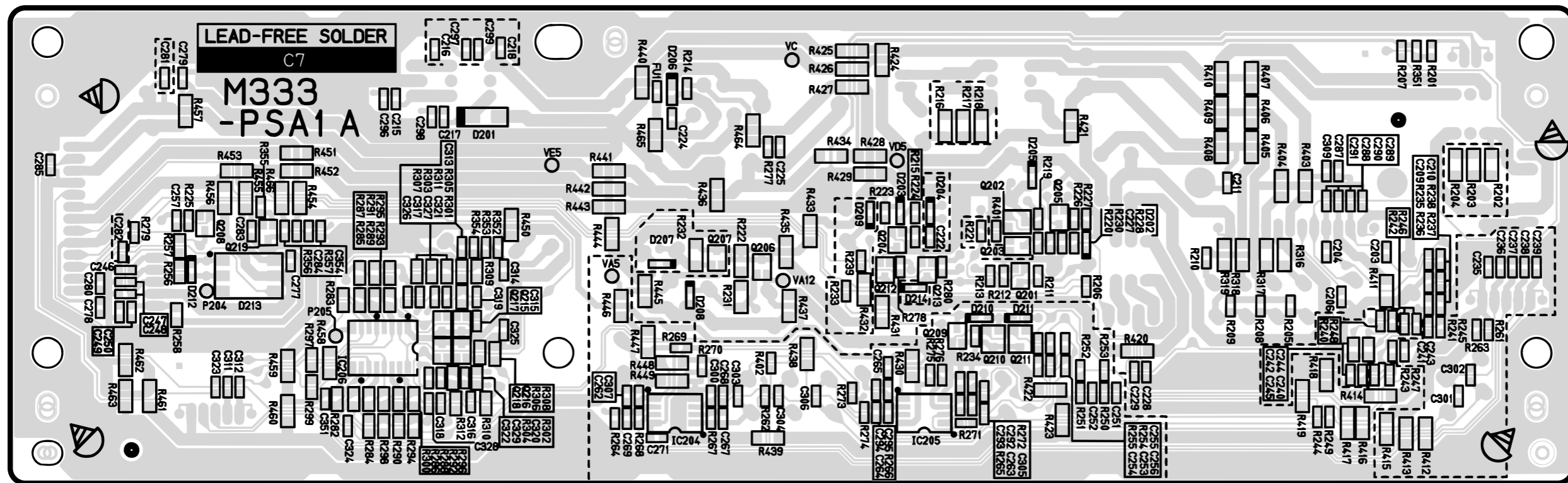

Bottom View

Console PCB M333-CNA1

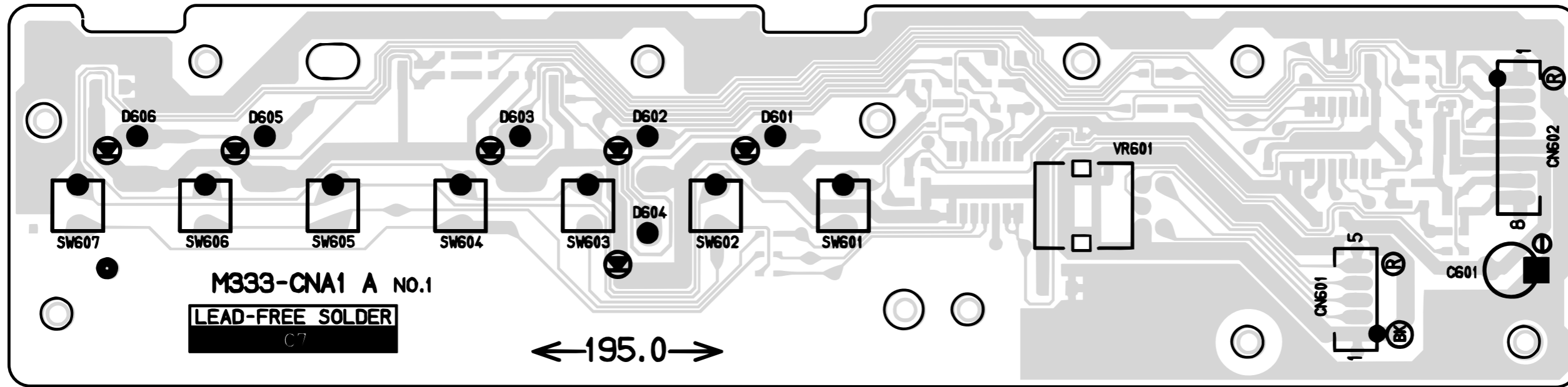

Top View

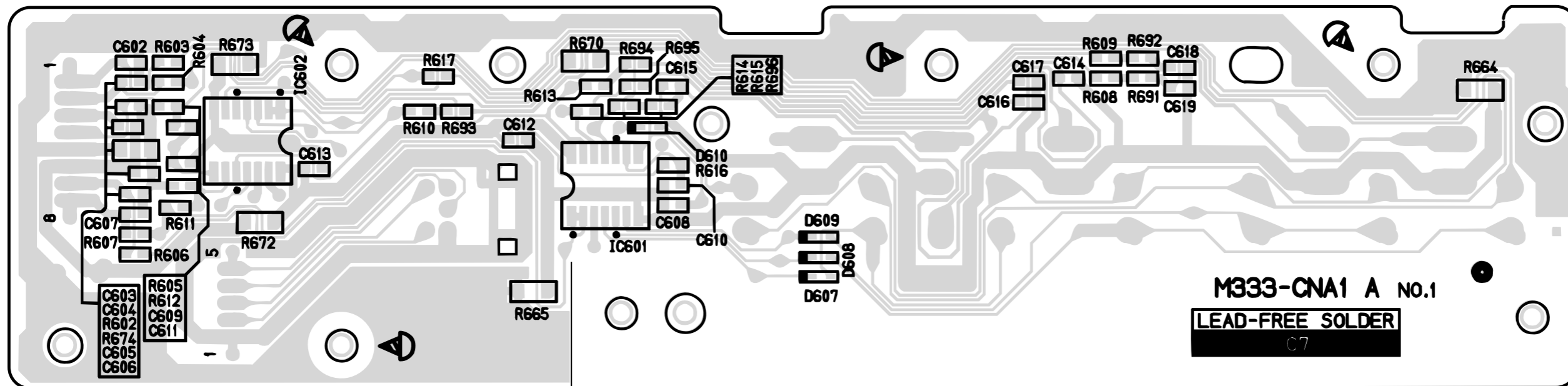

Bottom View

Console PCB M333-CNA2

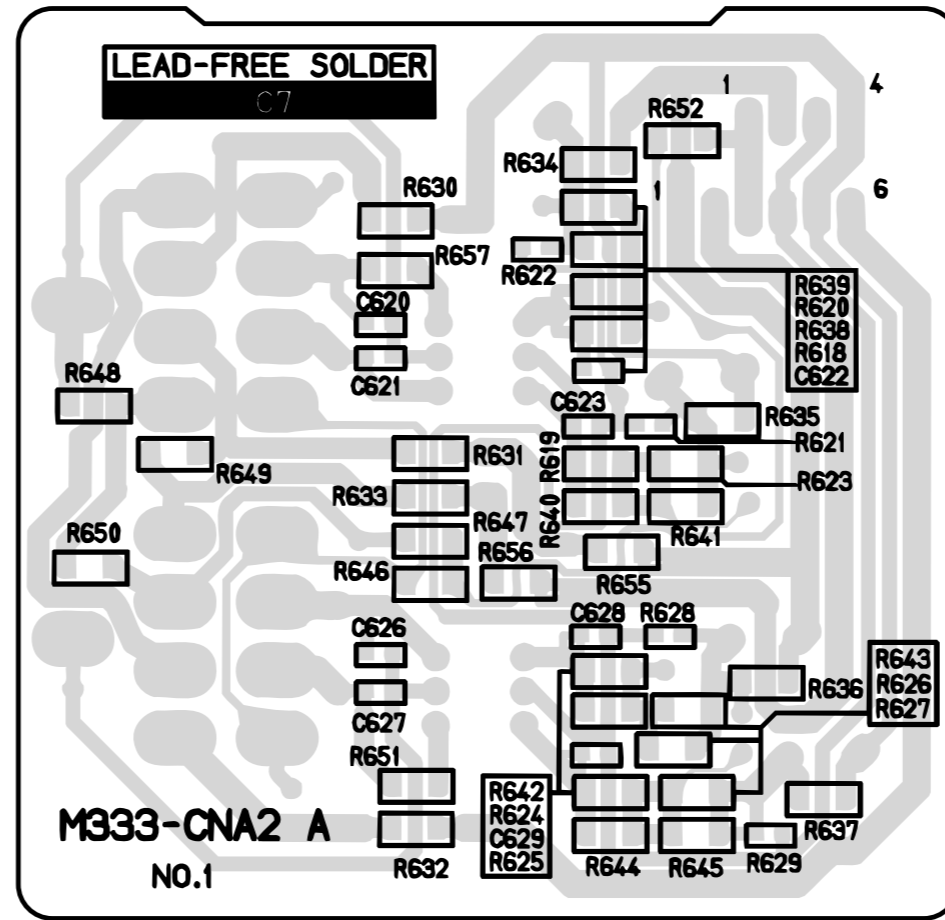
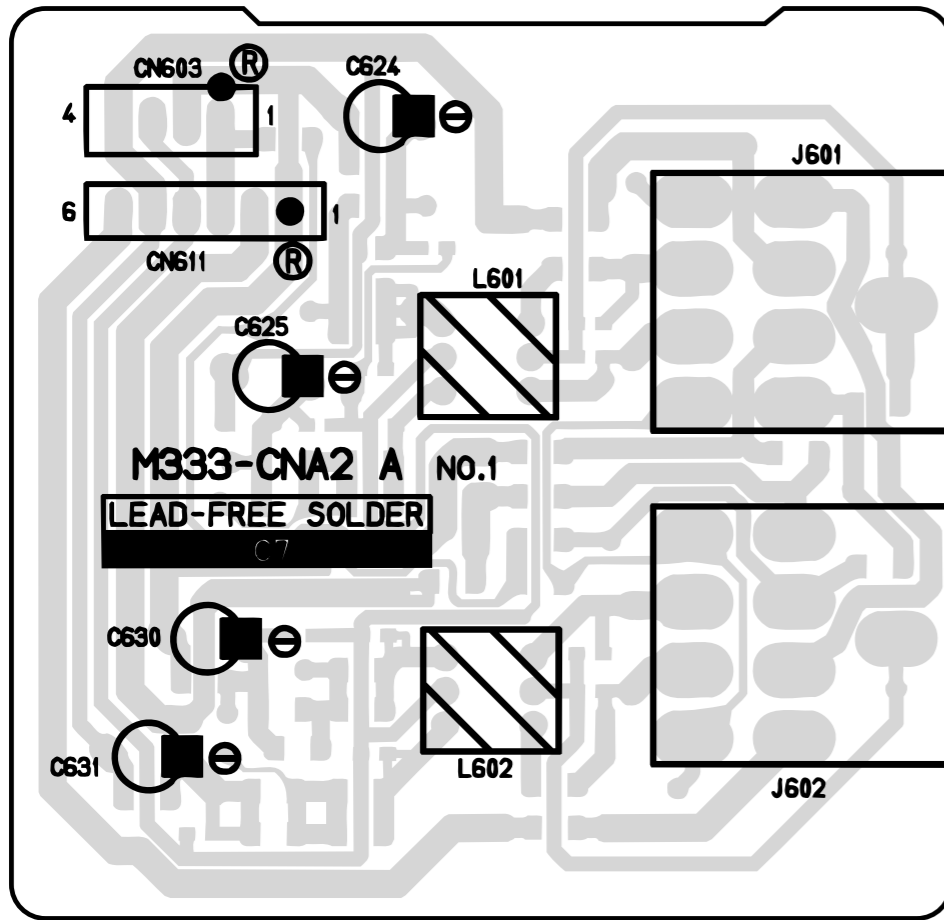

Console PCB M333-CNA4

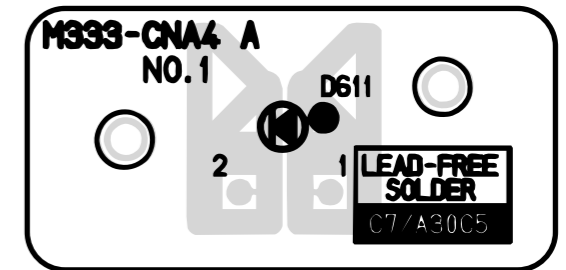
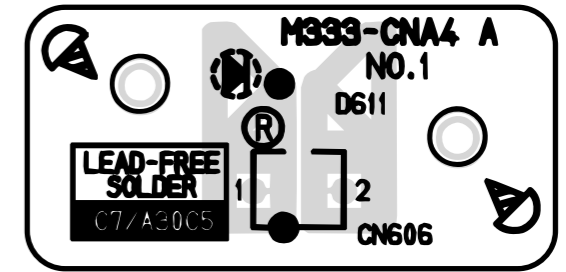

Console PCB M.333-CNA3

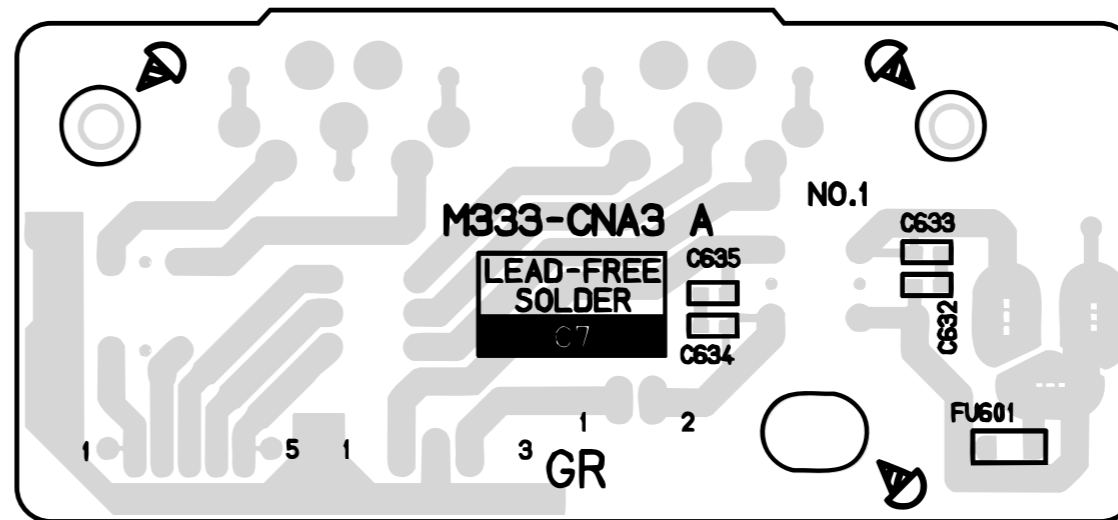
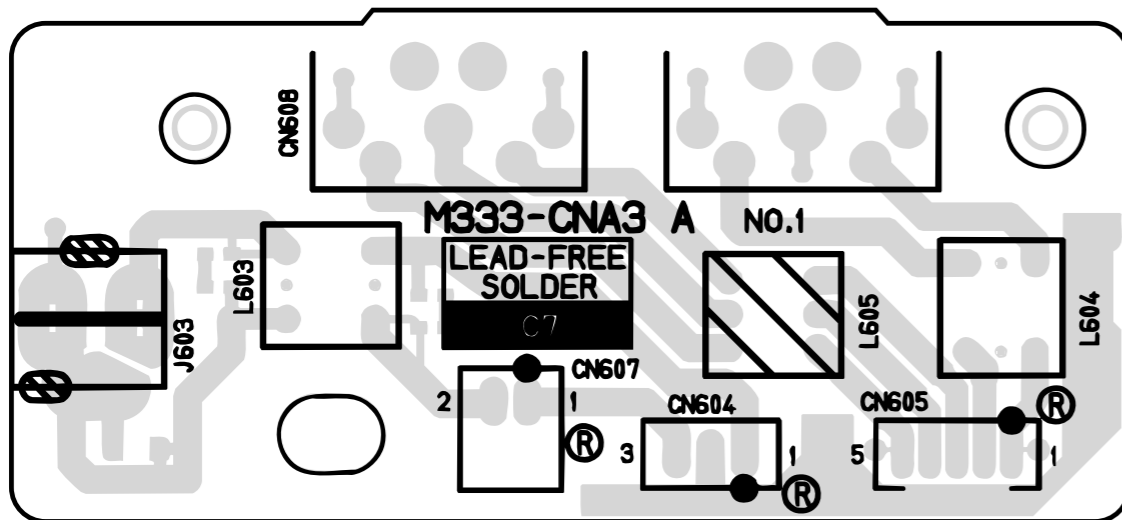

Console PCB M333-CNA5

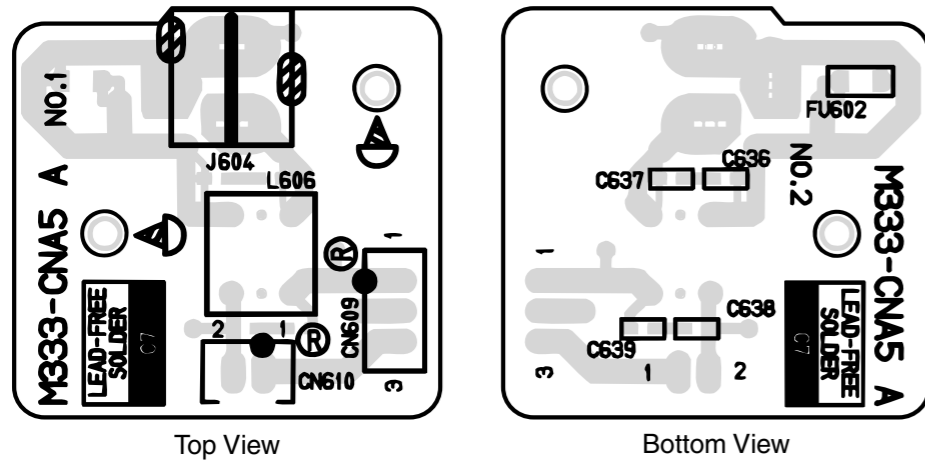

Keyboard PCB MCZS-KYA1

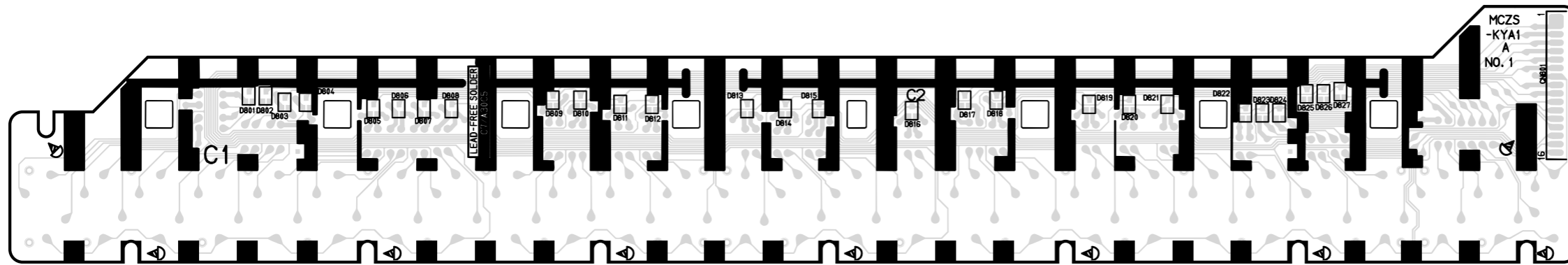

Keyboard PCB MCZS-KYB1

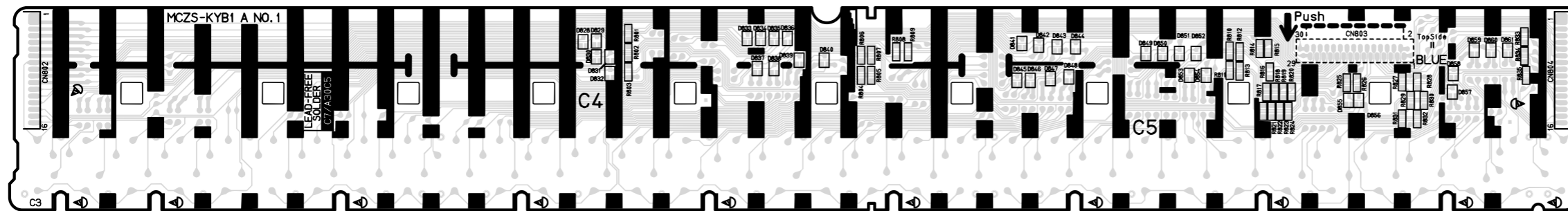

Keyboard PCB MCZS-KYC1

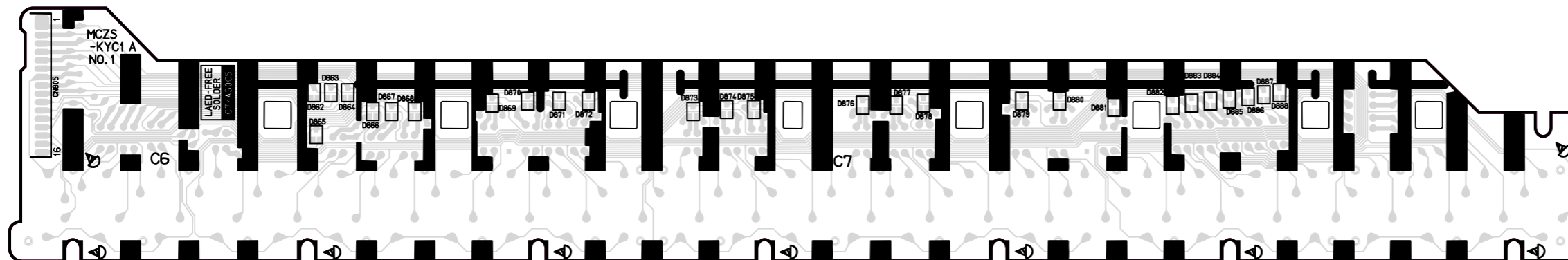

DISASSEMBLY

1. Remove the AC adaptor, Pedal cord and Music stand.
2. To damage neither the floor nor the main body, the main body is put on the mat or the blanket, etc.

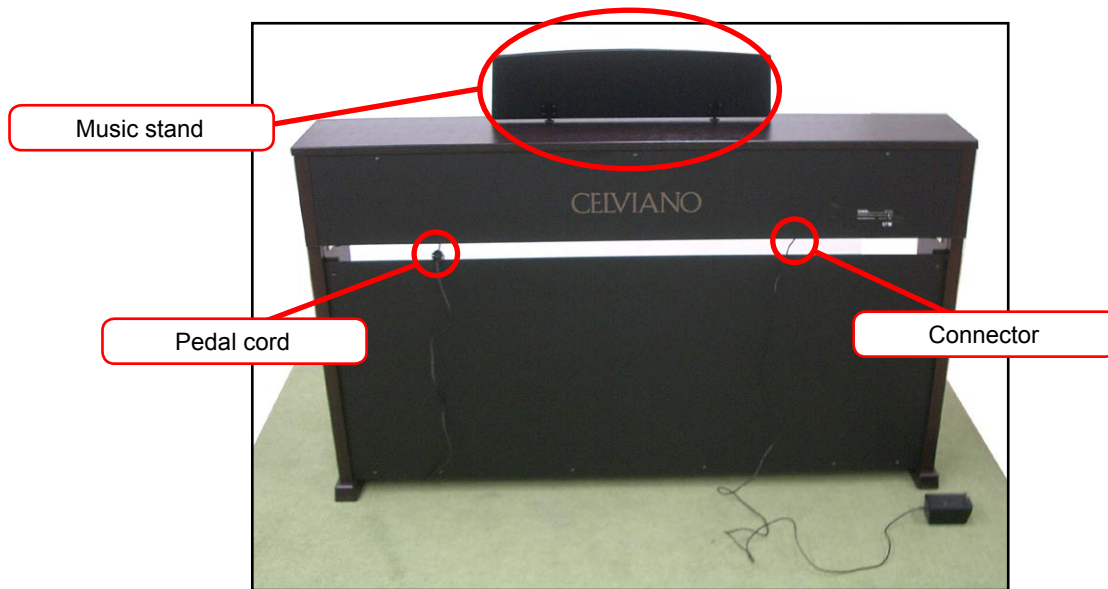

3. Remove 2 screws.
4. Remove the top board.

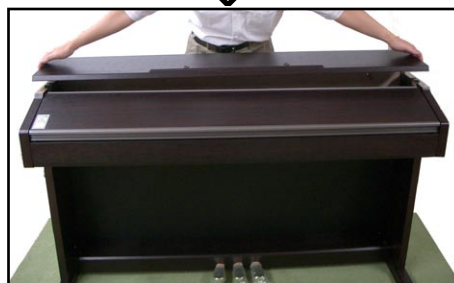
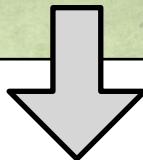
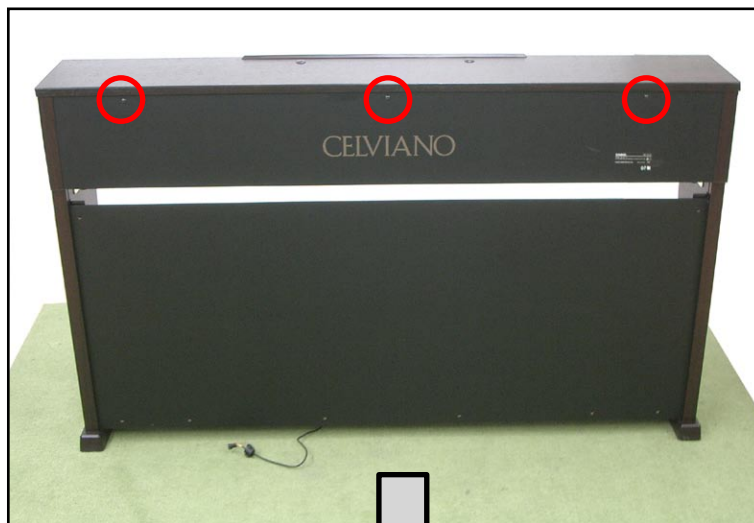

5. Remove the 2 screws and the 2 stoppers on the left and right ends.
6. Remove the key cover.

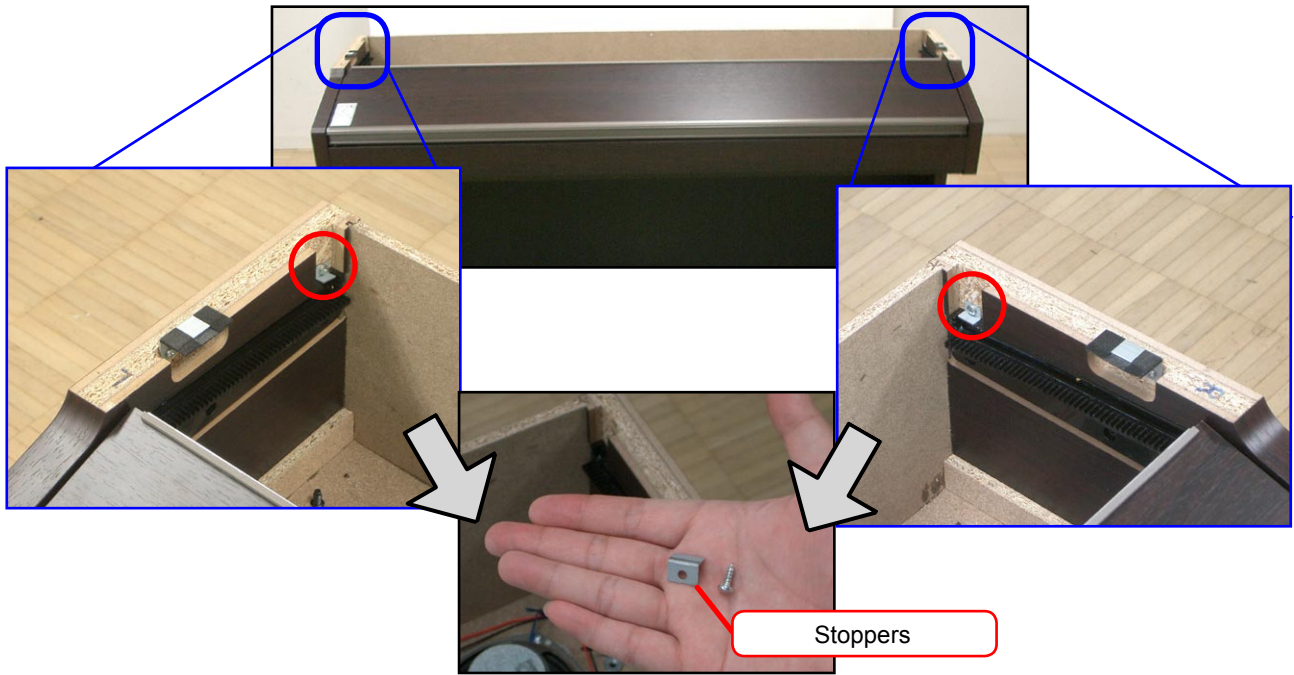

7. Remove the twist ties that hold the 16 cables in place.

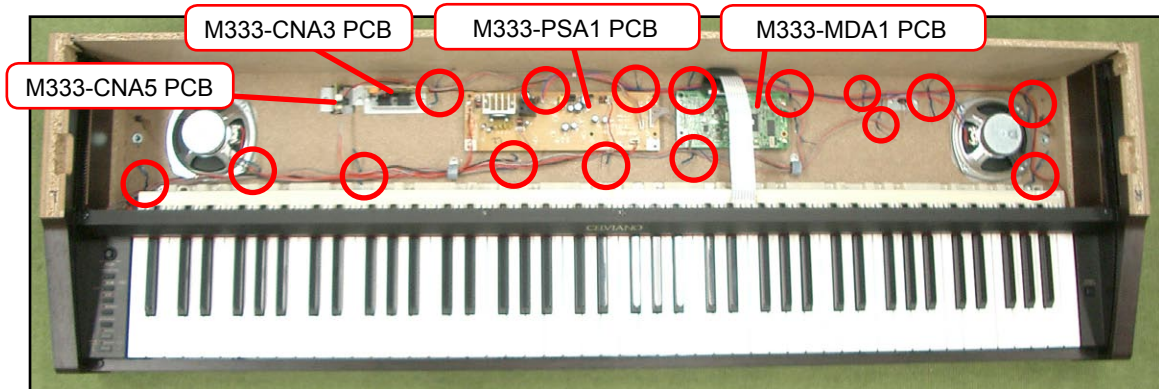

8. Removing the M333-MDA1 PCB

8-1. Remove the twist ties that hold the FPC cables in place.

8-2. Remove the 3 connectors.

8-3. Remove the connector, release the lock and then remove the FPC.

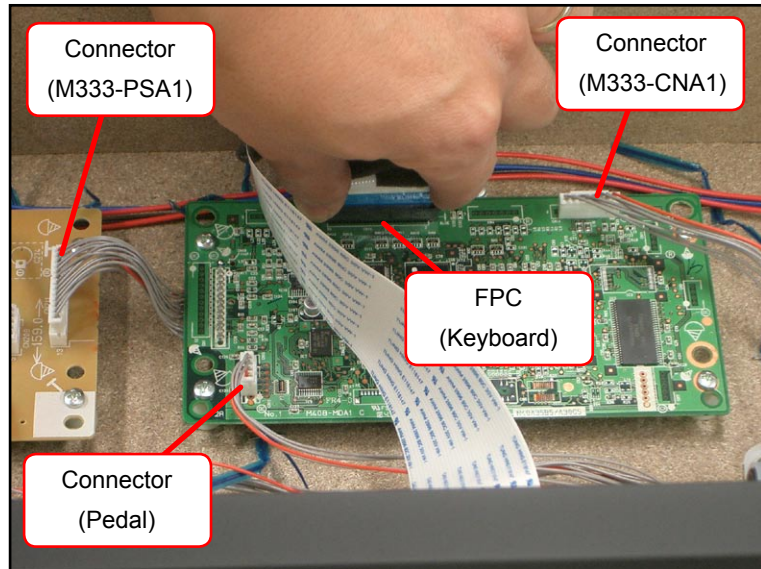
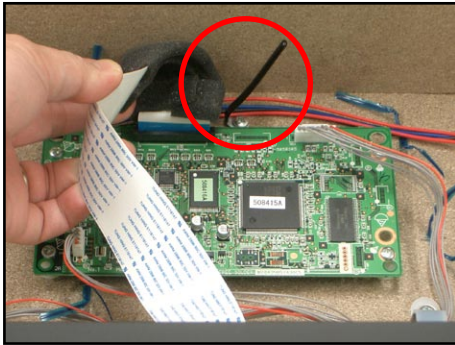

8-4. Remove 4 screws and the M333-MDA1 PCB.

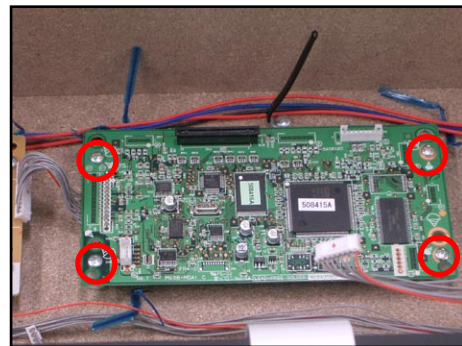

9. Removing the M333-PSA1 PCB

9-1. Remove the 7 connectors.

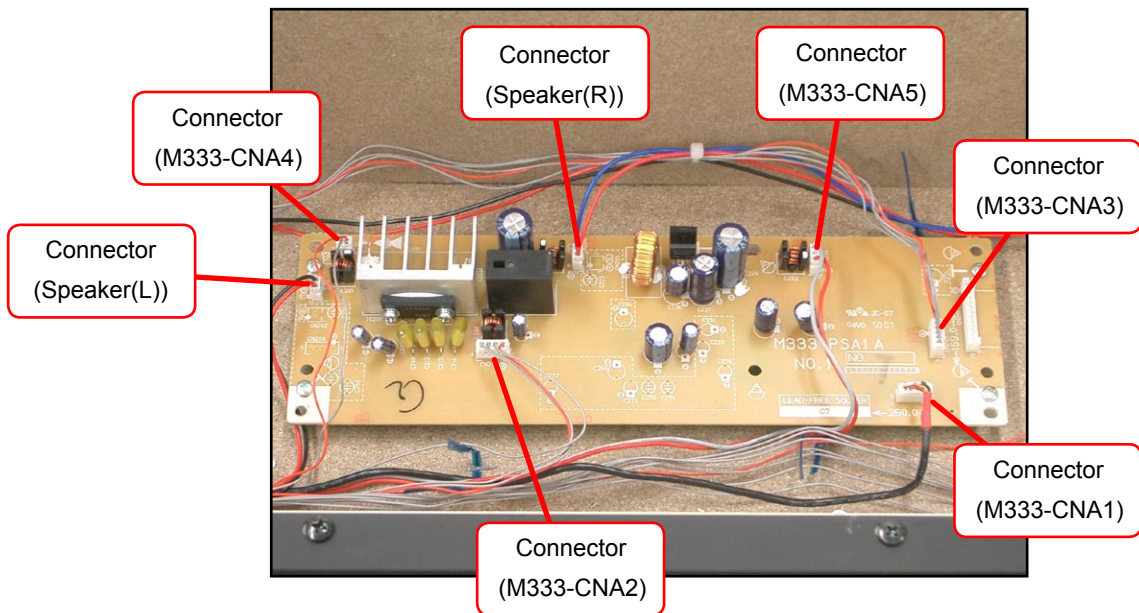

9-2. Remove 5 screws and the M333-PSA1 PCB.

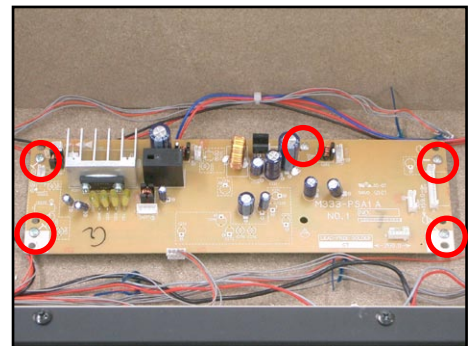

10. Removing the M333-CNA3 PCB and M333-CNA5 PCB

10-1. Remove the screw and the Ferrite core.

10-2. Remove the connector.

10-3. Remove 2 screws and the M333-CNA5 PCB and bracket.

10-4. Remove 2 screws and the M333-CNA3 PCB and bracket.

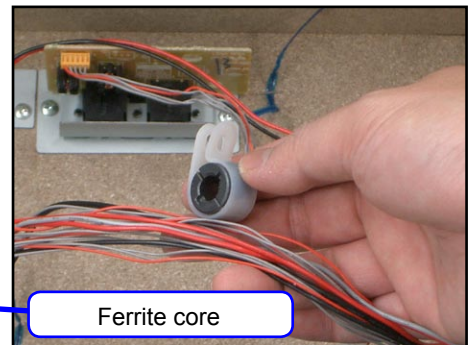
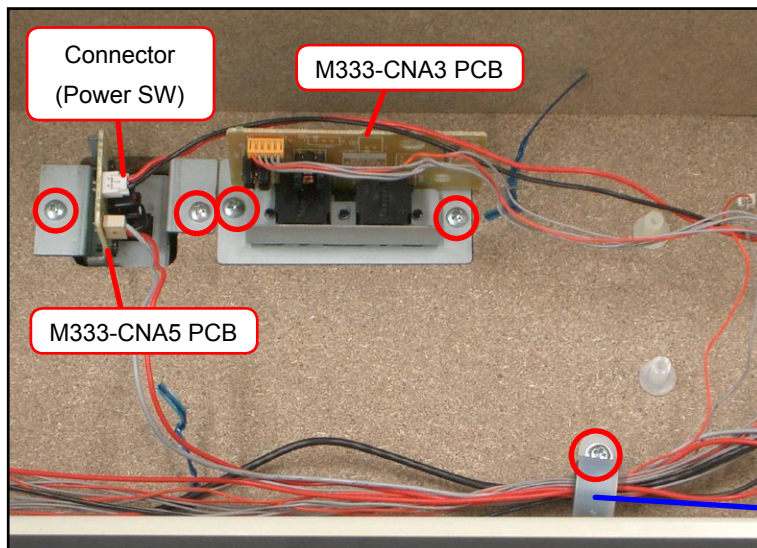

10-5. Remove 3 screws and the M333-CNA3 PCB.

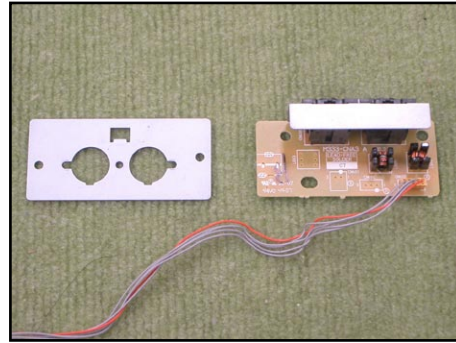
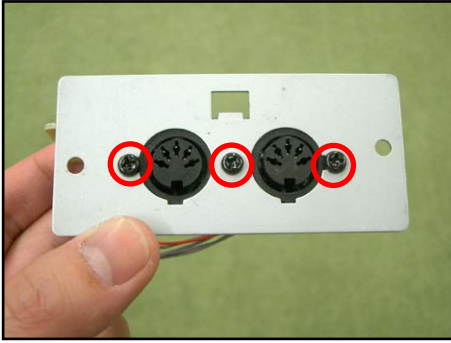

10-6. Remove 2 screws and the M333-CNA5 PCB.

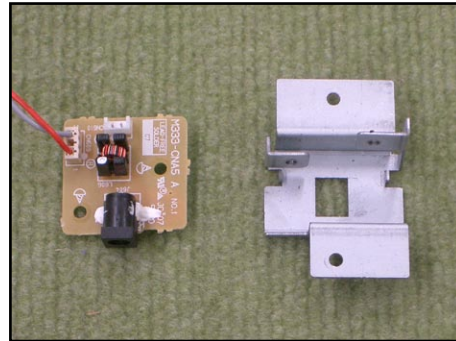
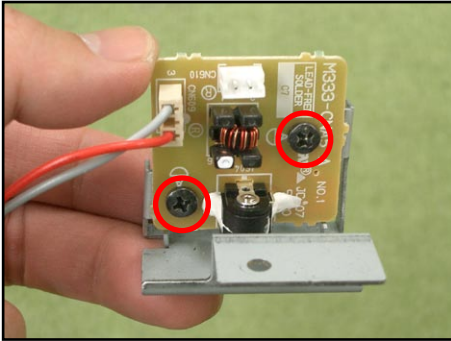

11. Removing the M333-CNA3 PCB and M333-CNA5 PCB

11-1. Remove the screw and the Ferrite core.

11-2. Remove 2 screws and the Pedal connector.

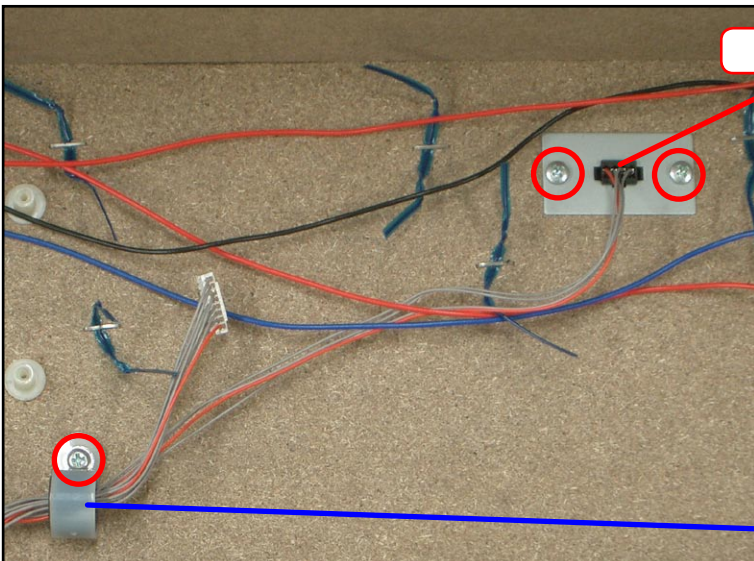

Pedal connector

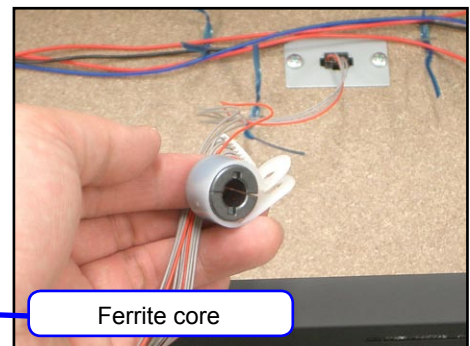

Ferrite core

12. Remove 8 screws and 2 speakers.

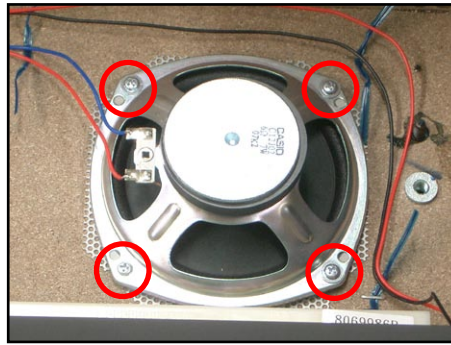
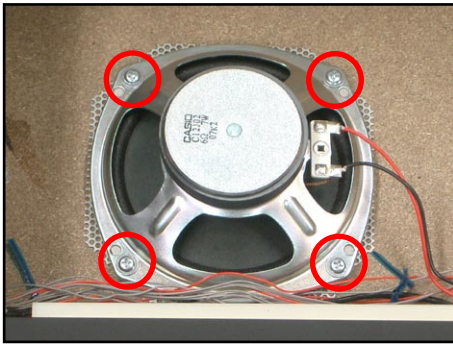

13. Remove 4 screws and the CN-PANEL.

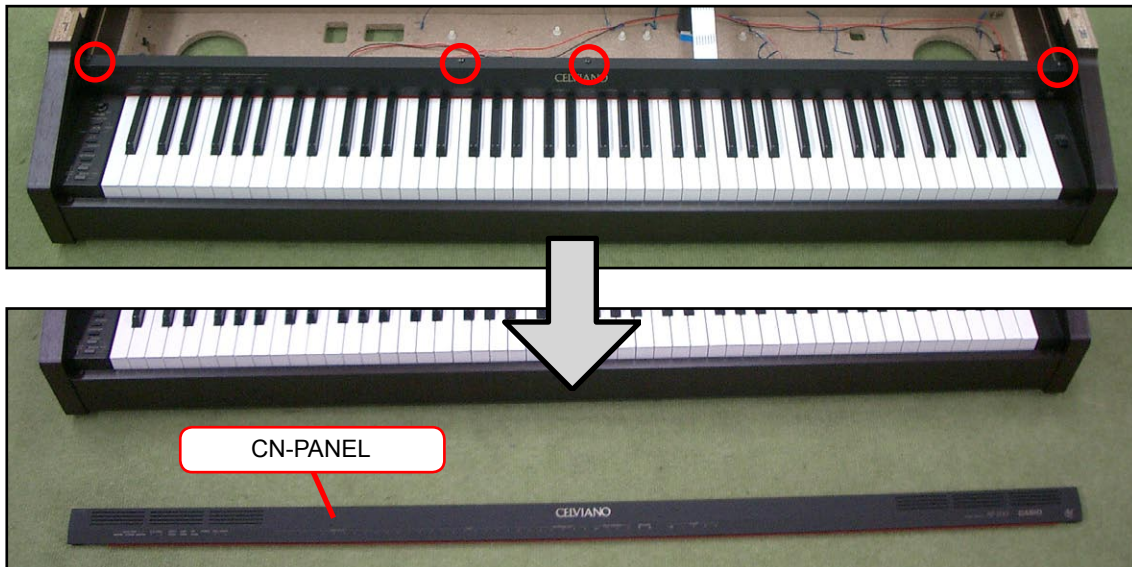

14. Remove 2 nuts.

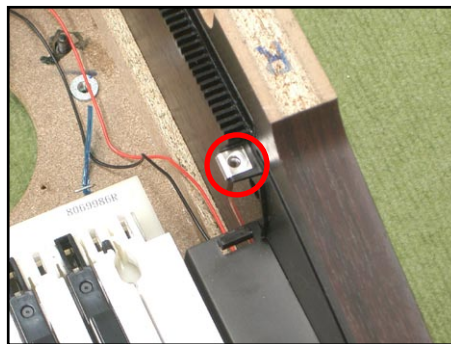
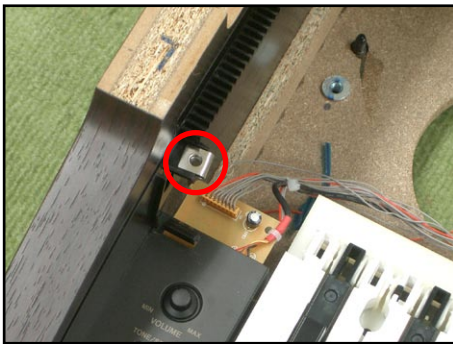

15. Removing the Side block

15-1. Remove 4 screws (left and right).

15-2. Remove the side units (left and right).

<The left side>

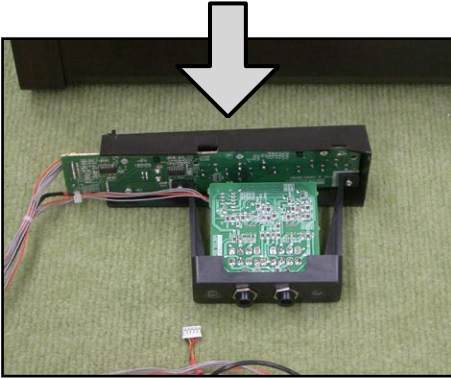
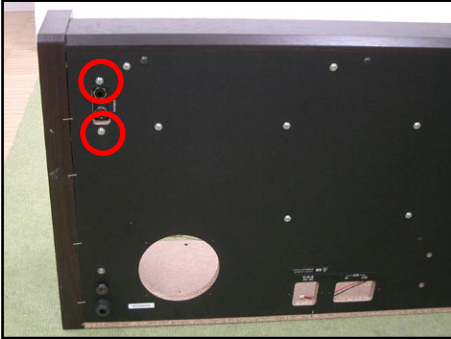

<The right side>

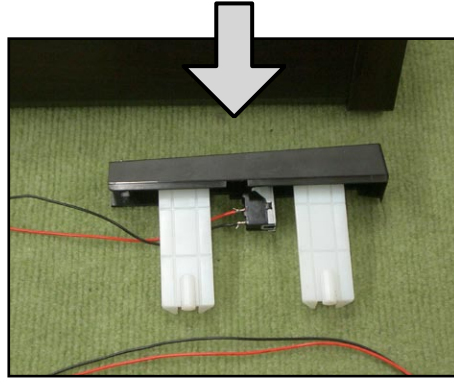
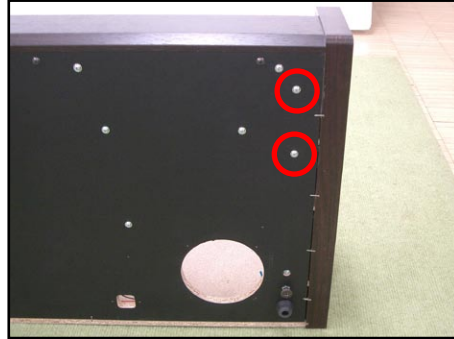

16. Disassembling the left side unit (M333-CNA1 PCB, M333-CNA2 PCB)

16-1. Remove 2 screws and the M333-CNA2 unit.

16-2. Remove 2 nuts and the M333-CNA2 PCB.

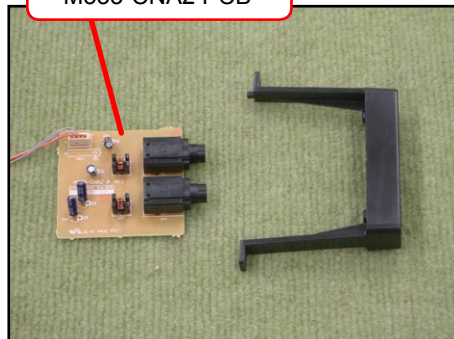
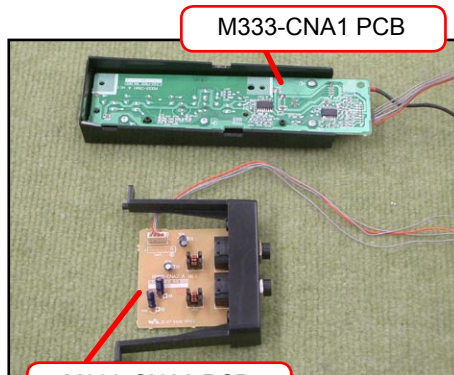
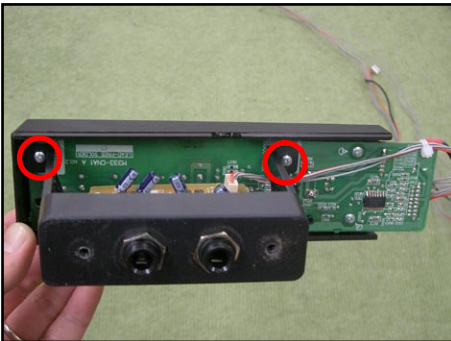

16-3. Remove 4 screws.

16-4. Remove the volume knob and the rubber key and M333-CNA1 PCB.

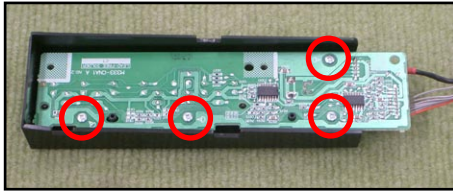

Rubber key

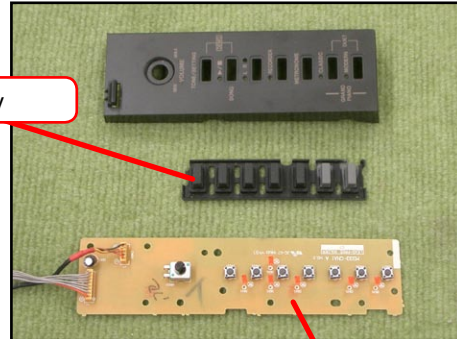

M333-CNA1 PCB

17. Disassembling the right side unit (Power switch)

17-1. Remove 2 screws and the Power switch.

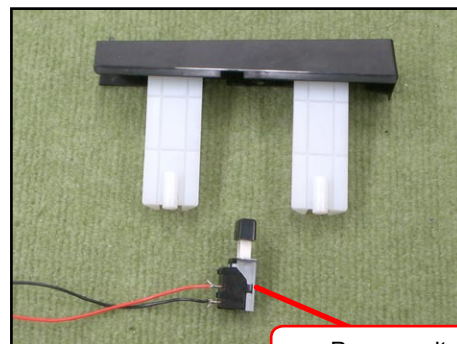
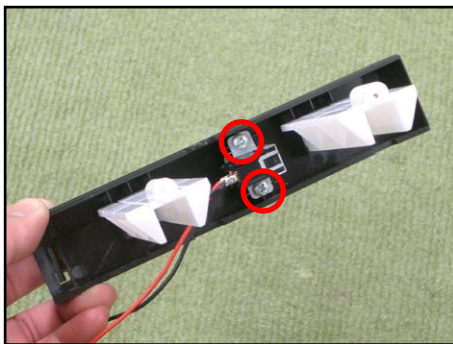

Power switch

18. Removing the M333-CNA4 PCB

18-1. Remove 6 screws and the front board assy.

18-2. Remove 2 screws and the M333-CNA4 PCB.

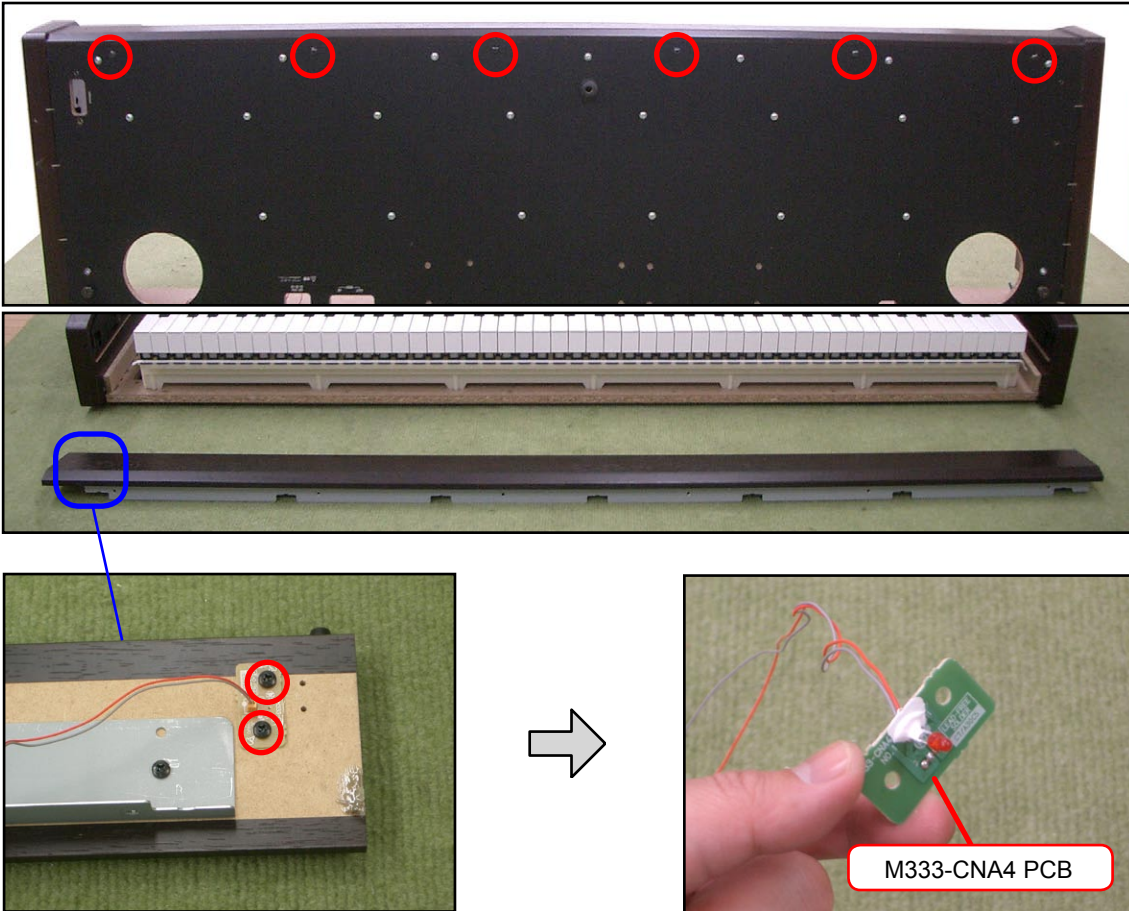

19. To remove the Keyboard

19-1. Remove 2 screws and then 2 brackets.

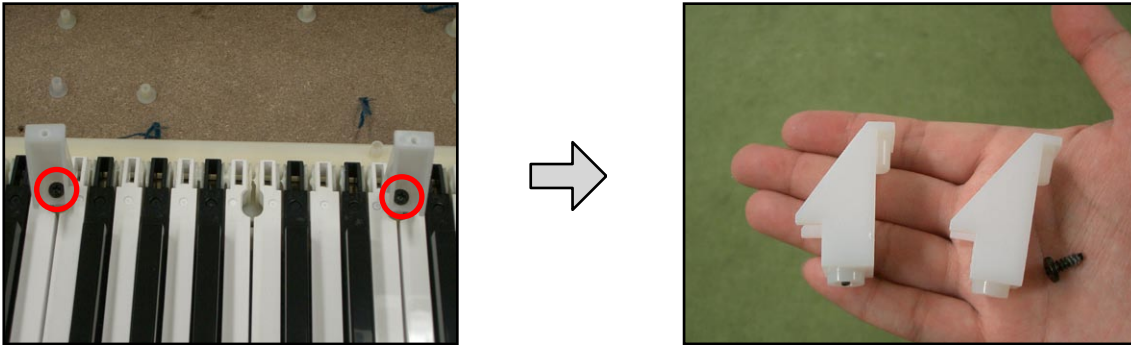

19-2. Remove 24 screws and then the KEY-BOARD ASSY.

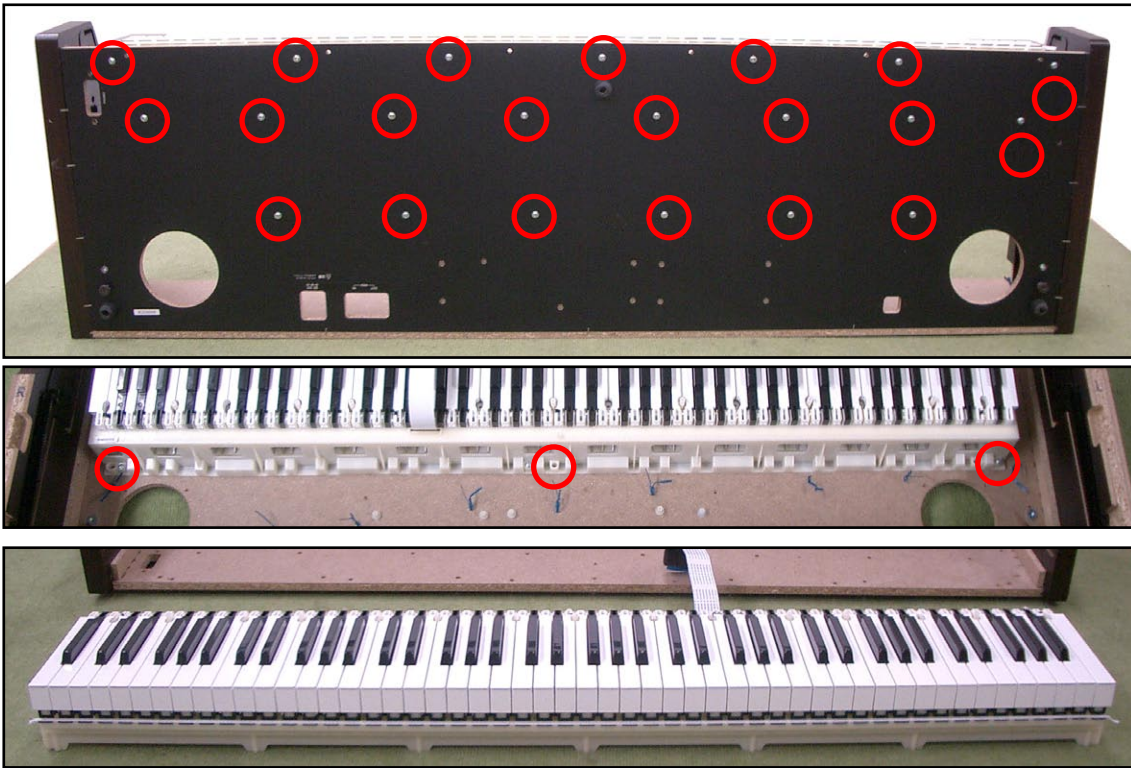

19-3. Remove the keys.

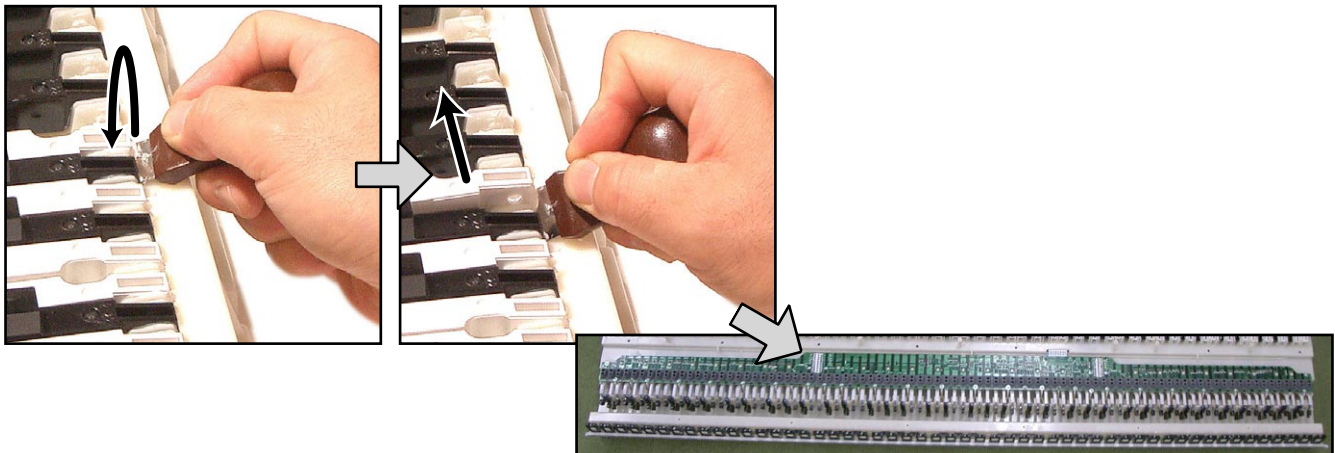

Caution while assembling the keys.

- Set the key as shown in figures below.

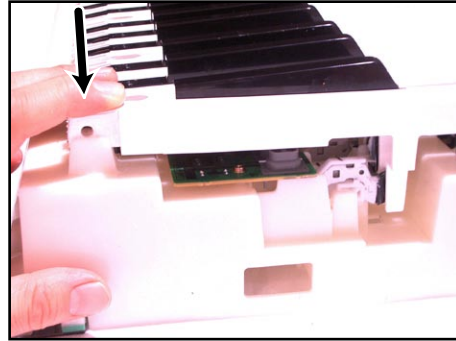
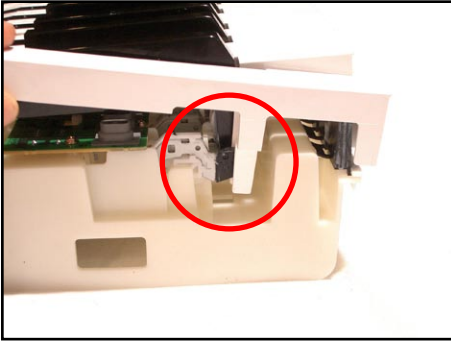

- 19-4. Remove 9 screws then the MCZS-KYC1 PCB.
- 19-5. Remove 12 screws then the MCZS-KYB1 PCB.
- 19-6. Remove 9 screws then the MCZS-KYA1 PCB.

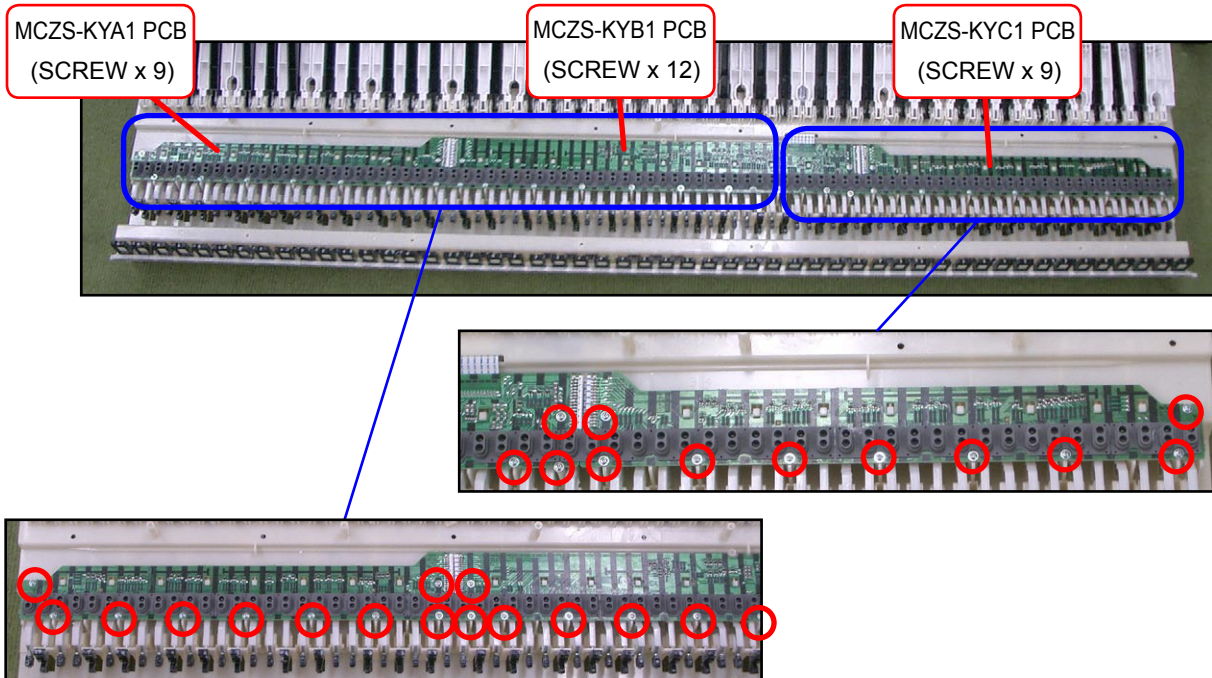

- 19-7. Remove 8 rubber keys.

* One of the keys has the different length from others.

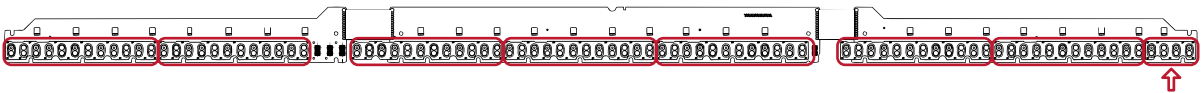

* How to install the rubber keys.

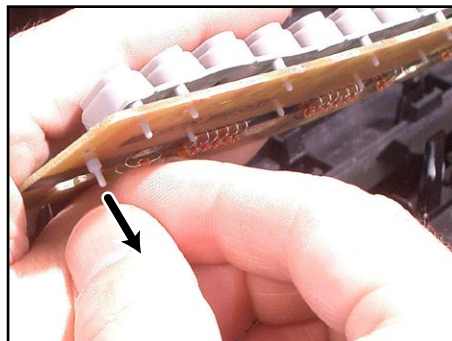

DIAGNOSTIC PROGRAM

■ Initial Setting

1. Connect the AC adaptor.
2. Connect the pedal.
NOTE: If there is no pedal, pedal check can be skipped.
3. “Main” volume: MAX

■ How to start diagnostic program

1. While pressing down “METRONOME”, “RECORDER”, and “SONG (▶/■)” buttons at the same time, turn the power ON.
Wait for confirmation chords C4, E4, G4 sound.
2. Release “METRONOME”, “RECORDER”, and “SONG (▶/■)” buttons

■ Diagnostic program

1. Automatic Test

- ① RAM check
- ② ROM check
“L / R” or “▶/■” lights when an error is found in ROM.
- ③ LED check
The LEDs light in thesequence shown below

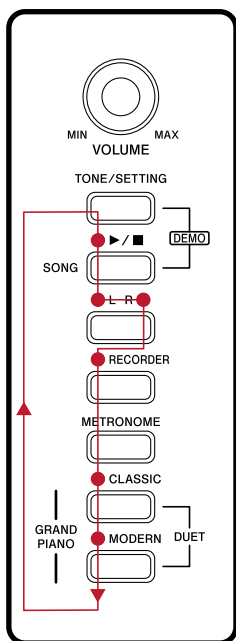

2. Sound check

- ① Press the “RECORDER” button to perform the “Sound check.”
When standing in the center, the tester hears the maximum test sound from the speakers.
- ② Press the [RECORDER] button again to stop the sound.

3. MODEL check

- ① Press “TONE/SETTING” button to perform the “MODEL check.”
The confirmation chords C4, E4, G4 sounds.
“CLASSIC” LED flashes.

4. ROM version check (Internal ROM, External ROM)

- ① Press "TONE/SETTING" button to perform the "ROM check (Internal ROM)."
The confirmation chords C4, E4, G4 sounds.
- ② Each time "SONG (▶/■)" button is pressed, the different LEDs light.
Confirm with the lit LED.
- ③ Press "TONE/SETTING" button to perform the "ROM check (External ROM)."
The confirmation chords C4, E4, G4 sounds.
- ④ Each time "SONG (▶/■)" button is pressed, the different LEDs light.
Confirm with the lit LED.

LED Status >

0 : "SONG (▶/■)" LED	1 : "MODERN" LED
2 : "CLASSIC" LED	3 : "RECORDER" LED
4 : "R" LED	5 : "L" LED
6 : "L + MODERN" LED	7 : "L + CLASSIC" LED
8 : "L + RECORDER" LED	9 : "L + R" LED

Internal ROM (0712110915): 0→7→1→2→1→1→0→9→1→5
 External ROM (0712110915): 0→7→1→2→1→1→0→9→1→5

Internal ROM LED Sequence

- 1: (0) "SONG (▶/■)" LED
- 2: (7) "L + CLASSIC" LED
- 3: (1) "MODERN" LED
- 4: (2) "CLASSIC" LED
- 5: (1) "MODERN" LED
- 6: (1) "MODERN" LED
- 7: (0) "SONG (▶/■)" LED
- 8: (9) "L + R" LED
- 9: (1) "MODERN" LED
- 10: (5) "L" LED

External ROM LED Sequence

- 1: (0) "SONG (▶/■)" LED
- 2: (7) "L + CLASSIC" LED
- 3: (1) "MODERN" LED
- 4: (2) "CLASSIC" LED
- 5: (1) "MODERN" LED
- 6: (1) "MODERN" LED
- 7: (0) "SONG (▶/■)" LED
- 8: (9) "L + R" LED
- 9: (1) "MODERN" LED
- 10: (5) "L" LED

5. BUTTON check

- ① Press "TONE/SETTING" button to perform the "BUTTON check."
The confirmation chords C4, E4, G4 sounds.
- ② Press the buttons in the order indicated in the illustration on the right.
A buzzer sounds if buttons are pressed in a wrong order.
This check cannot be aborted in mid-course.

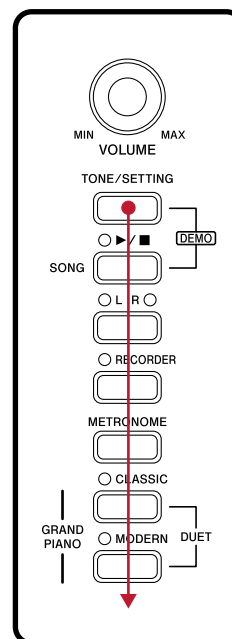

6. Pedal check (If there is no pedal, pedal check can be skipped.)

- ① Press “TONE/SETTING” button to perform the “Pedal check”.
The confirmation chords C4, E4, G4 sounds.
- ② Press the “SOFT” pedal.
The confirmation chord E4 sounds and “MODERN” LED lights.
- ③ Press the “SOSTENUTO” pedal.
The confirmation chord G4 sounds and “MODERN” LED lights.
- ④ Press the “DAMPER” pedal.
The confirmation chord C4 sounds and “CLASSIC” LED lights.

7. Headphone check

- ① Press “TONE/SETTING” button to perform the “Headphone check.”
The confirmation chords C4, E4, G4 sounds and “L” LED lights.
- ② Connect the headphone to the jack.
“R” LED lights.
- ③ Press the “A4” key.
- ④ Remove the headphone from the jack.
“L” LED lights.
- ⑤ There are 2 headphone jacks. Repeat Steps ② → ③ → ④ for each jack.
- ⑥ Press “TONE/SETTING” button to finish the “headphone check.”
The confirmation chords C4, E4, G4 sound and the light on "L" LED turns off.

8. MIDI check (If there is no MIDI cable, this check can be skipped.)

- ① Press “TONE/SETTING” button to perform the “MIDI check.”
The confirmation chords C4, E4, G4 sound and the light off LED.
- ② Connect the MIDI cable.
- ③ Press the “A4” key.
The confirmation chords C4, E4, G4 sounds.
- ④ Remove the MIDI cable.
- ⑤ Press “TONE/SETTING” button.
The confirmation chords C4, E4, G4 sounds.
- ⑥ Press “TONE/SETTING” button.
The confirmation chords C4, E4, G4 sound twice.

9. FLASH MEMORY check

- ① Hold down “RECORDER” button to perform the “FLASH Memory Check”.
“RECORDER” LED flashes
Then the light on "RECORDER" LED turns off and the confirmation chords C4, E4, G4 sound.

The diagnostic program ends.

Turn off the power to complete the checking.

EXPLODED VIEW

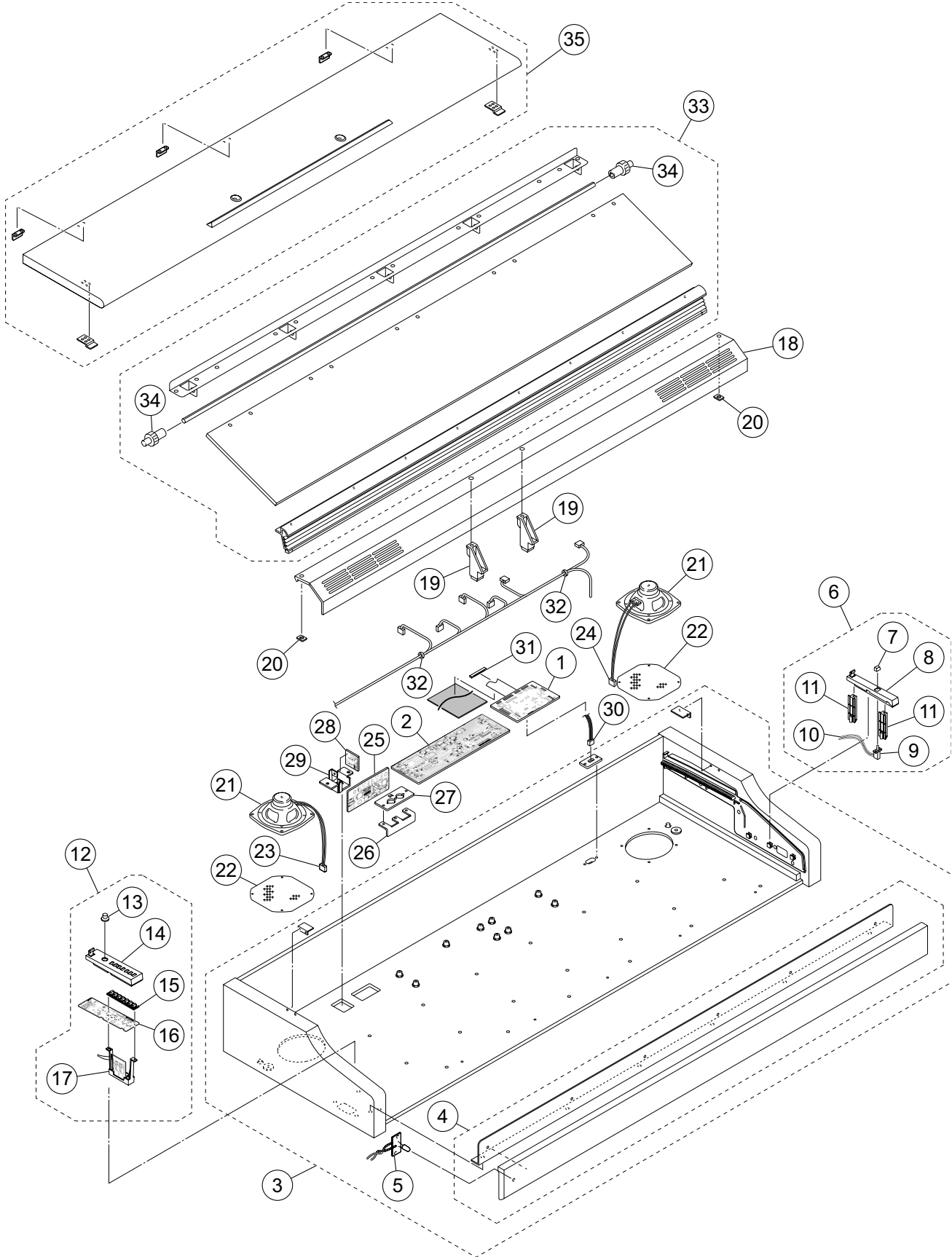

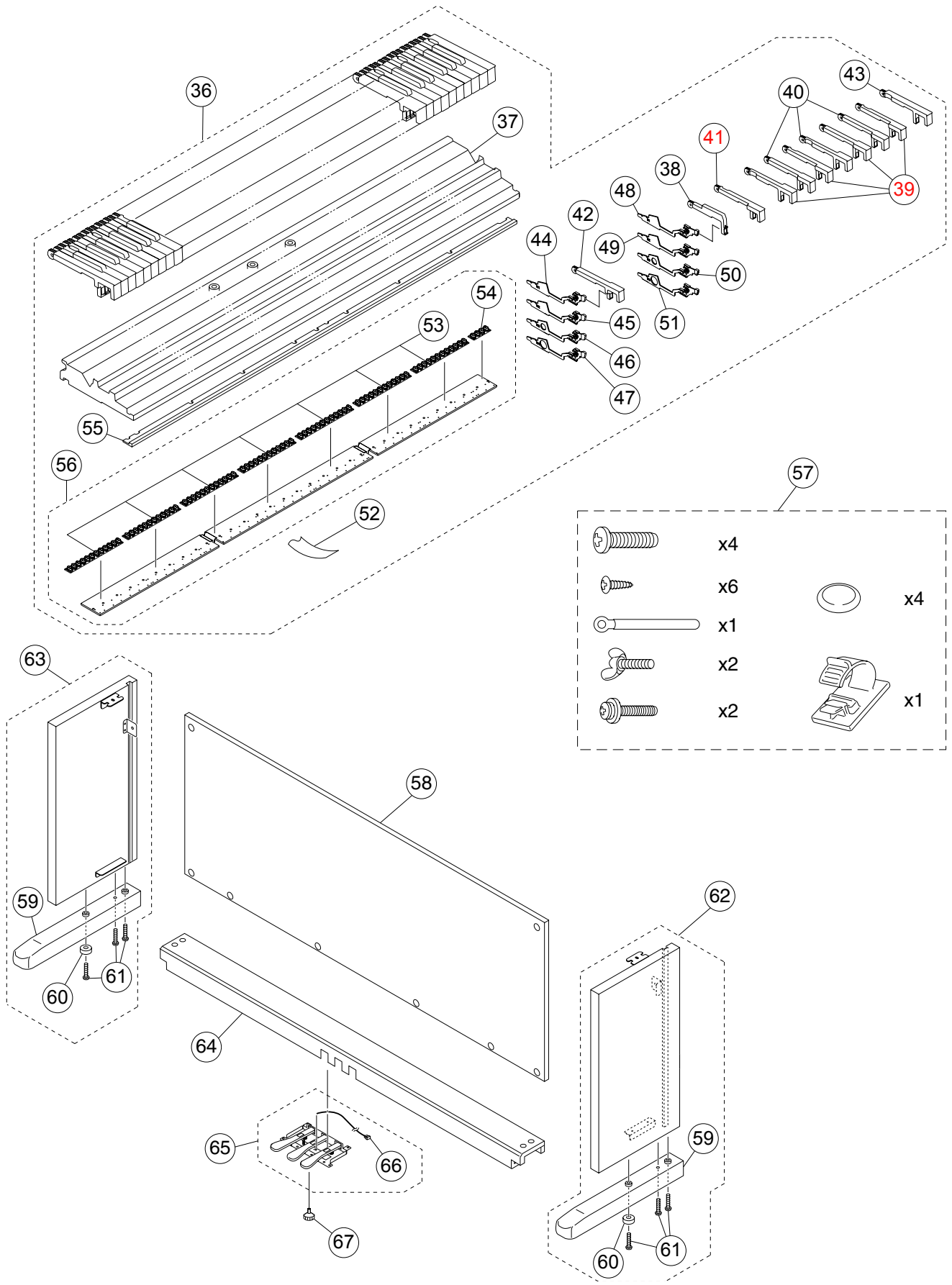

PARTS LIST

AP-200

Notes: This parts list does not include the cosmetic parts, which parts are marked with item No. "R-X" in the exploded view.

Contact our spare parts department if you need these parts for refurbish.

1. Prices and specifications are subject to change without prior notice.
2. As for spare parts order and supply, refer to the "GUIDEBOOK for Spare parts Supply", published seperately.
3. The numbers in item column correspond to the same numbers in drawing.

- 1 AP-200_DI_120V
- 2 AP-200_DI_230V
- 3 AP-200_EU
- 4 AP-200_UK
- 5 AP-200_US

N	Item	Parts No.	Parts Code	Specification	Q'TY					Price Code	R	Remarks
					1	2	3	4	5			
MAIN PCB												
N	1	10294100	PCB ASSY/MAIN	TK-RJM508412*001	1	1	1	1	1	DO	A	
	X1	10133372	CRYSTAL OSCILLATOR	SMD-49-12M	1	1	1	1	1	AI	B	
	Q2	10202670	TRANSISTOR	KTA2014-GR-RTK/P	1	1	1	1	1	AA	C	
	Q1	22592764	TRANSISTOR	2SB1188T100Q	1	1	1	1	1	AB	C	
	L13,16,17	10122963	COIL	BLM21AG102SN1D	3	3	3	3	3	AC	C	
	L8,11,12,20	10095204	CHIP BEAD CORE	BLM18AG102SN1D	4	4	4	4	4	AA	C	
N	IC6	10284634	LSI	NAND128W3A2BN6E	1	1	1	1	1	BI	C	
N	IC2	10284633	LSI	MD56V62162J75TA03A	1	1	1	1	1	BC	C	
	IC7	10262261	LSI	MB82D01181E60LPBNE	1	1	1	1	1	BC	C	
	IC11	10253886	LSI	UPD65942GA-Y299EUA	1	1	1	1	1	AX	C	
	IC5	10255468	LSI	MB91F036PFF-GE1	1	1	1	1	1	CB	C	
	IC9	10258396	IC	TC74VHC541FT(EL.K)	1	1	1	1	1	AE	C	
	IC8	10123002	IC	TC74VHC174FT(EL)	1	1	1	1	1	AD	C	
	IC1	10241413	IC	R1151N001C-TR-F	1	1	1	1	1	AE	C	
	IC10	10256338	IC	CS4351-CZZR	1	1	1	1	1	AS	C	
N	F8	10132152	EMI FILTER	NFW31SP106X1E4L	1	1	1	1	1	AI	C	
	F3,4,5,9,10,11	10122976	NETWORK/ R-C	EZASTB63ABJ	6	6	6	6	6	AA	C	
	F6,7	10122975	NETWORK/ R-C	EZASSB516BJ	2	2	2	2	2	AA	C	
PSA1 PCB												
N	2	10294096	PCB ASSY/PSA1	TK-RJM508382*001	1	1	1	1	1	CW	B	
N	E202	10292899	RELAY	G5PA-28-MCDC5V(PF)	1	1	1	1	1	BC	C	
	IC201	10203081	IC	LA4636-E	1	1	1	1	1	AV	C	
	L204	10231919	COMMON MODE COIL	RB53-856396NP	1	1	1	1	1	AA	X	
	L201,202,203	10231920	COMMON MODE COIL	RB53-856397NP	3	3	3	3	3	AA	X	
N	D208	10294392	DIODE	EDZTE6112B	1	1	1	1	1	AB	X	
N	D203	10294393	DIODE	EDZTE618.2B	1	1	1	1	1	AB	X	
N	D202,205,212	10276977	CHIP DIODE	L1SS400T1G	3	3	3	3	3	AA	X	
N	D206	10210387	DIODE	RSX101VA-30TR	1	1	1	1	1	AA	X	
N	D201	10294394	DIODE	SK34A	1	1	1	1	1	AD	X	
N	D213	10294395	PHOTO COUPLER	PC900V0NIPXF	1	1	1	1	1	AX	X	
N	IC206	10294396	IC	NJM2123M(TE1)	1	1	1	1	1	AT	X	
	IC202	10201503	I.C	PQ1CG21H2FZH	1	1	1	1	1	AO	X	
	L205	10208248	COIL	R187-860400NP	1	1	1	1	1	AC	X	
	Q205	69409403	CHIP TRANSISTOR	2SA1576AT106R	1	1	1	1	1	AA	X	
	Q201,204,206,208,212,213,215,216,217,218	69300298	CHIP TRANSISTOR	2SC4081T106R	10	10	10	10	10	AA	X	
	Q202	10213764	TRANSISTOR	2SD2351T106W	1	1	1	1	1	AA	X	
MAIN CASE UNIT												
N	3	10294101	CASE ASSY/MAIN	TK-RJM508276*001	1	1	1	1	1	EC	C	
N	4	10294102	BOARD-ASSY/FRONT	TK-RJM508281*001	1	1	1	1	1	CX	C	
N	5	10294103	PCB ASSY/CNA4	TK-RJM508393*001	1	1	1	1	1	BV	C	
N	6	10294091	SIDEUNIT/R	TK-RJM508279*001	1	1	1	1	1	BQ	C	
	7	69245260	BUTTON/POWER	M340318-001	1	1	1	1	1	AA	C	
N	8	10294362	SIDE BLOCK/R	RJM508326-001V01	1	1	1	1	1	AQ	C	
	9	10229392	POWER SWITCH	SDDL1PCHL011	1	1	1	1	1	AS	C	
N	10	10298365	HARNESS	EH-2P-131-M333	1	1	1	1	1	AK	C	To Power SW
N	11	10294363	BRACKET/R	RJM508404-001V01	2	2	2	2	2	AD	X	
N	12	10294085	SIDE BLOCK/L	TK-RJM508278*001	1	1	1	1	1	CV	C	
	13	10052232	KNOB/ROTARY	M341402-001	1	1	1	1	1	AE	C	
N	14	10294361	SIDE BLOCK/L	RJM508325-001V01	1	1	1	1	1	AR	C	
	15	10281445	RUBBER KEY	RJM505783-002V02	1	1	1	1	1	AD	C	
N	16	10294089	PCB ASSY/CNA1	TK-RJM508390*001	1	1	1	1	1	CG	C	

- 1 AP-200_DI_120V
- 2 AP-200_DI_230V
- 3 AP-200_EU
- 4 AP-200_UK
- 5 AP-200_US

N	Item	Parts No.	Parts Code	Specification	Q'TY					Price Code	R	Remarks
					1	2	3	4	5			
N	VR601	10273791	VARIABLE RESISTOR	F-09KGH-CASIO-1	1	1	1	1	1	AJ	C	
N	D607-610	10276977	CHIP DIODE	L1SS400T1G	4	4	4	4	4	AA	X	
N	D601-606	10294401	LED	LT2P71-81-M1-70495	6	6	6	6	6	AB	X	
N	IC601,602	10294403	IC	TC74VHC164F(EL.K.F	2	2	2	2	2	AN	X	
N	SW601-607	10228658	TACT SWITCH	THVV502GAA	7	7	7	7	7	AA	C	
N	17	10294090	PCB ASSY/CNA2	TK-RJM508391*001	1	1	1	1	1	CB	C	
N	J601,602	10171449	CONNECTOR	JY-6360*04-070	2	2	2	2	2	AE	C	Phone jack
N	L601,602	10231919	COMMON MODE COIL	RB53-856396NP	2	2	2	2	2	AA	X	
N	18	10294095	PANEL ASSY/CONSOLE	TK-RJM508277*001	1	1	1	1	1	CX	C	
N	19	10294353	BRACKET	RJM508338-001V01	2	2	2	2	2	AB	C	
N	20	58614294	NUT	USN-4015	2	2	2	2	2	AB	C	
N	21	10269829	SPEAKER	C12J02	2	2	2	2	2	AX	C	
N	22	10294355	NET	RJM508336-001V01	2	2	2	2	2	AL	X	
N	23	10212713	HARNESS	EH-2P-46-M404	1	1	1	1	1	AA	C	for L.SP
N	24	10298363	HARNESS	EH-2P-68-M333	1	1	1	1	1	AH	C	for R.SP
N	25	10294098	PCB ASSY/CNA3	TK-RJM508392*001	1	1	1	1	1	BX	C	
N	CN608	10207671	CONNECTOR	HDC-052SP-02	1	1	1	1	1	AK	C	
N	L605	10206672	COIL	R2318-RB53856396NP	1	1	1	1	1	AA	X	
N	L604	10206680	COIL	R2318-RB53856397NP	1	1	1	1	1	AA	X	
N	26	10169597	BRACKET	RJM504221-001V01	1	1	1	1	1	AA	X	
N	27	10294354	BRACKET	RJM508332-001V01	1	1	1	1	1	AF	X	
N	28	10294099	PCB ASSY/CNA5	TK-RJM508394*001	1	1	1	1	1	BV	C	
N	J604	10208247	CONNECTOR	DJ-0702B*019	1	1	1	1	1	AB	X	DC JACK
N	L606	10231920	COMMON MODE COIL	RB53-856397NP	1	1	1	1	1	AA	X	
N	29	10294356	BRACKET	RJM508431-001V01	1	1	1	1	1	AL	X	
N	30	10298364	HARNESS	SMP-4P-41-M333	1	1	1	1	1	AM	C	For Pedal
N	31	10212699	FERRITE CORE	K5ARP40X6.5X12	1	1	1	1	1	AS	C	For FFC
N	32	10204256	FERRITE CORE	TRCN16-13	2	2	2	2	2	AW	C	
N	33	10294070	COVER ASSY/KEY	TK-RJM508274*001	1	1	1	1	1	DO	C	
N	34	10211850	GEAR	RJM505897-001V01	2	2	2	2	2	AA	C	
N	35	10294073	BOARD ASSY/TOP	TK-RJM508275*001	1	1	1	1	1	DK	C	
Keyboard UNIT												
N	36	10298122	KEY UNIT	TK-RJM506362*003	1	1	1	1	1	EF	A	
N	37	10204304	CHASSIS/KEY	RJM505515-001V01	1	1	1	1	1	BX	C	
N	38	10135317	BLACK KEY	RJM502797-001V01	36	36	36	36	36	AC	C	
N	39	10135426	WHITE KEY/CEGB	RJM502862-001V01	7	7	7	7	7	AT	C	4pcs-1set
N	40	10135427	WHITE KEY/DFA	RJM502863-001V01	7	7	7	7	7	AQ	C	3pcs-1set
N	41	10135428	WHITE KEY/B	RJM502794-001V01	1	1	1	1	1	AG	C	
N	42	10135429	WHITE KEY/SA	RJM502795-001V01	1	1	1	1	1	AJ	C	
N	43	10135430	WHITE KEY/SC	RJM502796-001V01	1	1	1	1	1	AJ	C	
N	44	10208265	HAMMER ASSY/W1	TK-RJM506035*001	13	13	13	13	13	AF	C	
N	45	10208266	HAMMER ASSY/W2	TK-RJM506036*001	13	13	13	13	13	AF	C	
N	46	10208267	HAMMER ASSY/W3	TK-RJM506037*001	13	13	13	13	13	AF	C	
N	47	10208269	HAMMER ASSY/W4	TK-RJM506038*001	13	13	13	13	13	AF	C	
N	48	10208275	HAMMER ASSY/B1	TK-RJM506039*001	9	9	9	9	9	AE	C	
N	49	10208281	HAMMER ASSY/B2	TK-RJM506040*001	9	9	9	9	9	AE	C	
N	50	10208286	HAMMER ASSY/B3	TK-RJM506041*001	9	9	9	9	9	AE	C	
N	51	10208290	HAMMER ASSY/B4	TK-RJM506042*001	9	9	9	9	9	AE	C	
N	52	37195442	FFC	N30315B1B05-UL2896	1	1	1	1	1	AO	C	
N	53	10133656	RUBBER/CONTACT/AG	RJM502920-001V01	7	7	7	7	7	AK	C	
N	54	10133635	RUBBER/CONTACT/GC	RJM502921-001V01	1	1	1	1	1	AG	C	
N	55	10294093	CUSHION/HAMMER	TK-RJM507910*001	1	1	1	1	1	CG	C	
N	56	10294094	PCB ASSY/KEY	TK-RJM506061*003	1	1	1	1	1	CU	C	

- 1 AP-200_DI_120V
- 2 AP-200_DI_230V
- 3 AP-200_EU
- 4 AP-200_UK
- 5 AP-200_US

N	Item	Parts No.	Parts Code	Specification	Q'TY					Price Code	R	Remarks
					1	2	3	4	5			
STAND												
N	57	10294107	SCREW SET	TK-RJM508373*001	1	1	1	1	1	BU	B	
N	58	10294404	BOARD/BACK	RJM508304-001V01	1	1	1	1	1	DF	C	
	59	10164310	FOOT ASSY	TK-RJM503823*001	2	2	2	2	2	BA	C	
	60	10160973	FOOT	RJM503826-001V01	2	2	2	2	2	AA	C	
	61	10203751	SCREW/TRUMPET	M441270-001V02	6	6	6	6	6	AA	C	
N	62	10294105	BOARD ASSY/R	TK-RJM508300*001	1	1	1	1	1	DD	C	
N	63	10294104	BOARD ASSY/L	TK-RJM508299*001	1	1	1	1	1	DE	C	
N	64	10294106	BOARD ASSY/PEDAL	TK-RJM508302*001	1	1	1	1	1	DI	C	
	65	10164314	PEDAL ASSY	TK-RJM503901*002	1	1	1	1	1	CC	C	
	66	10164049	HARNESS	SMR-4P-155-M420	1	1	1	1	1	AJ	B	
	67	10260690	ADJUSTER	FL-20-CR3-KE	1	1	1	1	1	AF	X	
ACCESSORY												
	-	10045707	CORD SET	BC2NC-M001A				1		BD	C	For UK
	-	10100792	CORD SET	INQ.1258(1)		1				AP	C	For Korea
	-	10045706	CORD SET	EC2NC-M001A			1			AM	C	For EU
	-	10229891	ADAPTOR	AD-12UL-TC3(D)	1				1	BV	C	For US
	-	10229890	ADAPTOR	AD-12FL-TC4(D)		1	1	1		CD	C	For EU/UK
N	-	10302762	STAND ASSY/MUSIC	TK-M241576*003	1	1	1	1	1	CY	C	
	-	10255460	MUSIC BOOK	05PHCOSCOWL1A	1	1	1	1	1	AX	C	

SCHEMATIC DIAGRAMS

Main PCB M333-MDA1-1

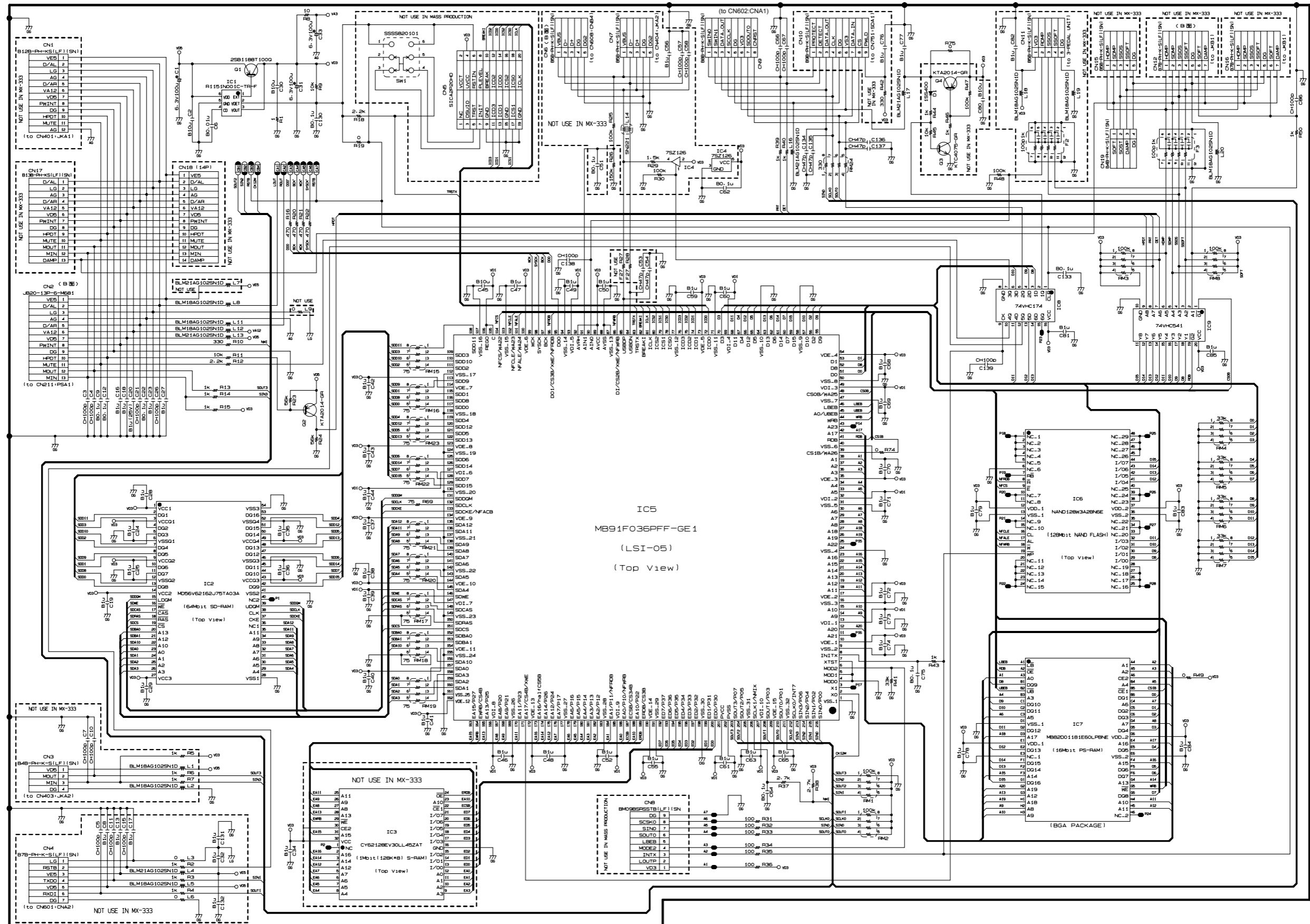

Main PCB M333-MDA1-2

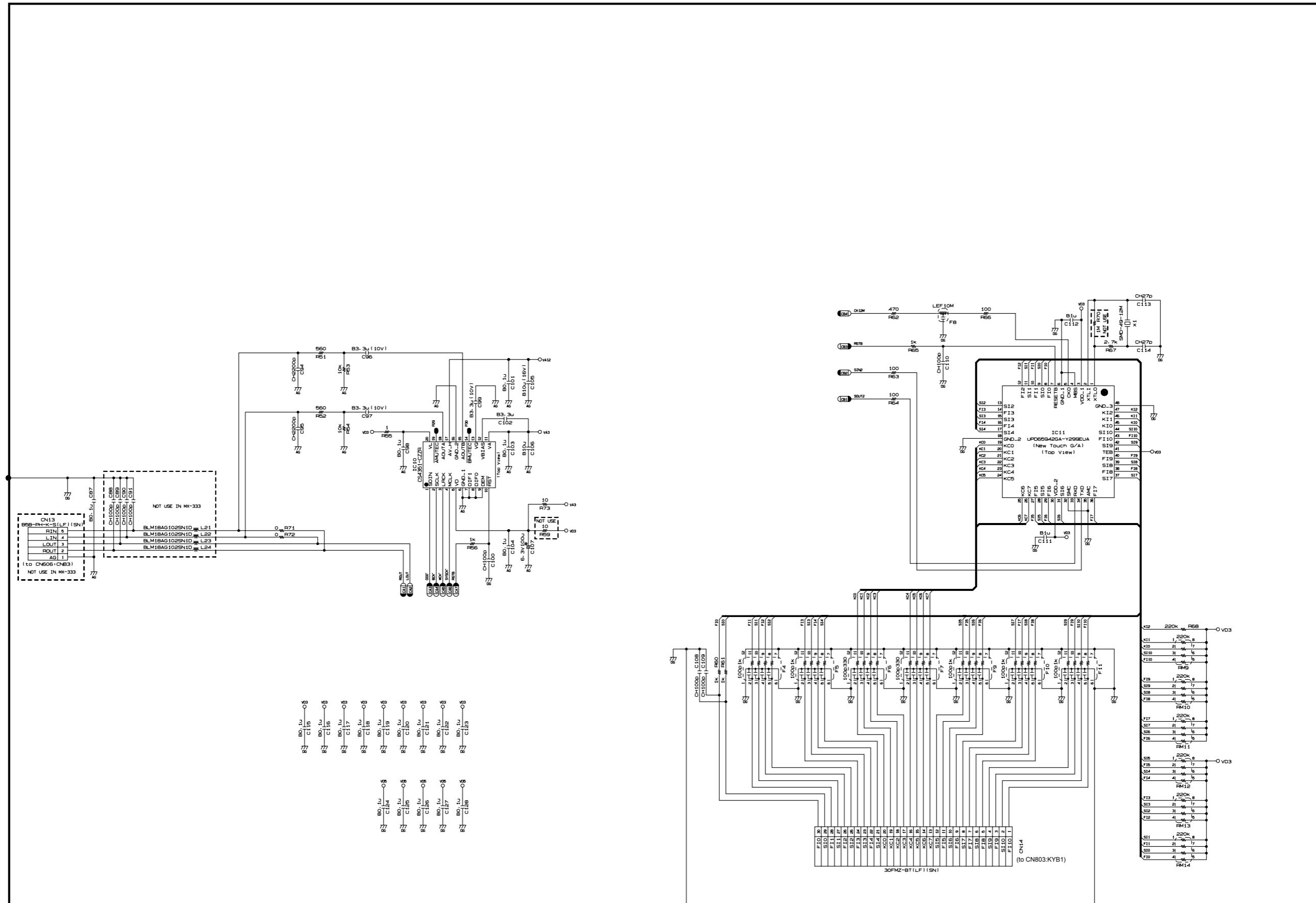

Sub PCB M333-PSA1-1

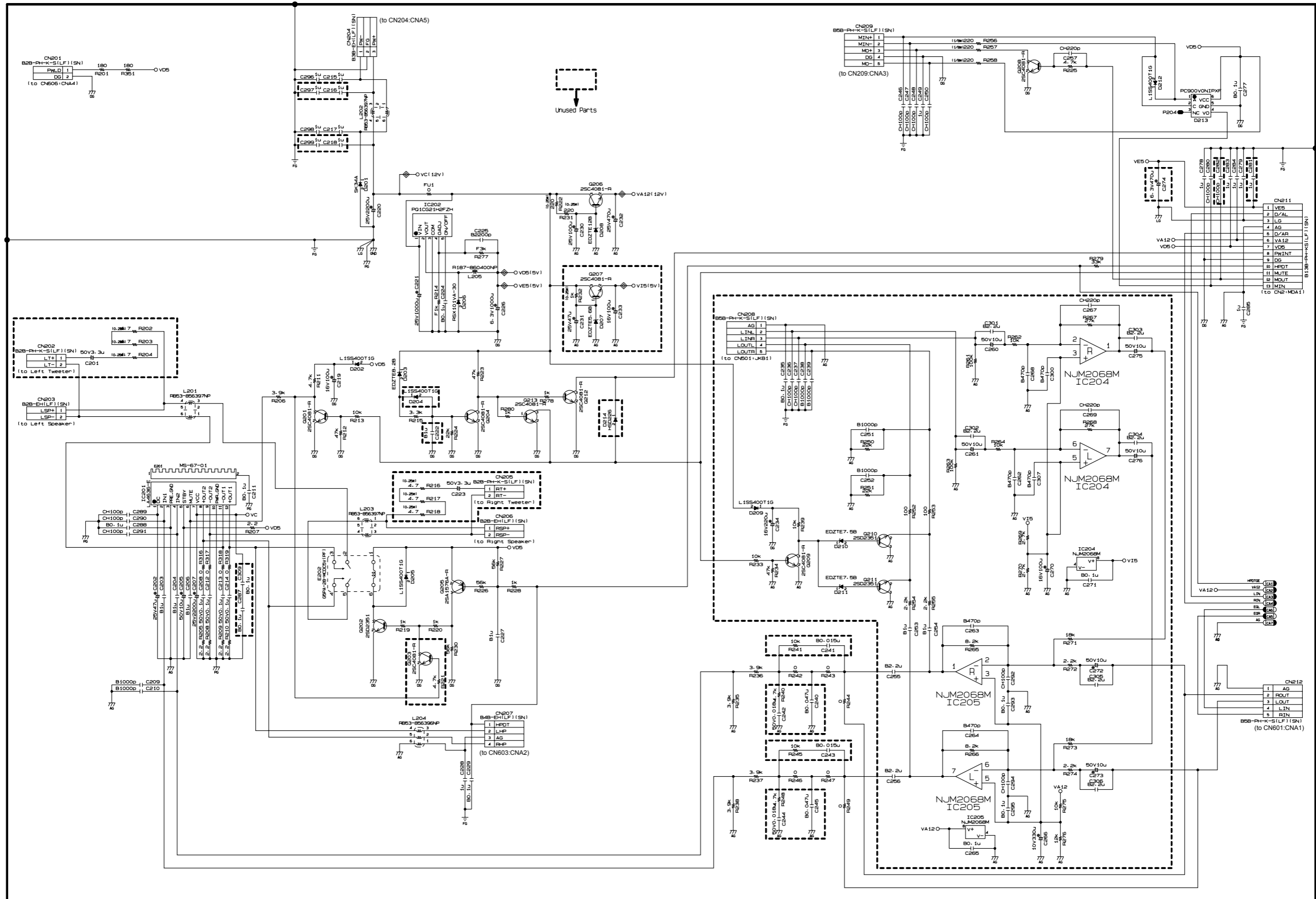

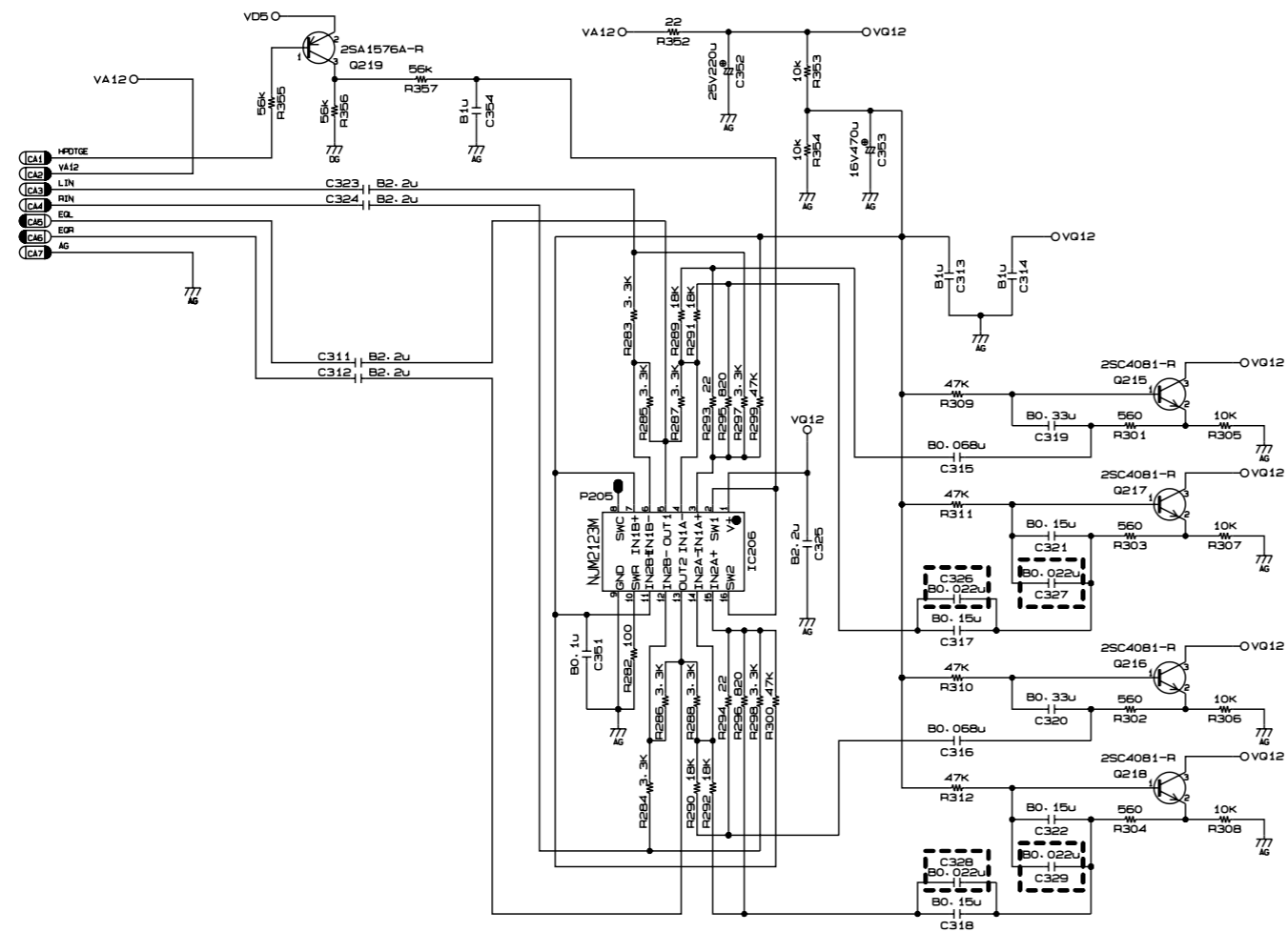

JUMPER RESISTOR						
1608 SIZE	3216 SIZE					
R401	R403	R413	R423	R433	R443	R453
R402	R404	R414	R424	R434	R444	R454
	R405	R415	R425	R435	R445	R455
	R406	R416	R426	R436	R446	R456
	R407	R417	R427	R437	R447	R457
	R408	R418	R428	R438	R448	R458
	R409	R419	R429	R439	R449	R459
	R410	R420	R430	R440	R450	R460
	R411	R421	R431	R441	R451	R461
	R412	R422	R432	R442	R452	R462

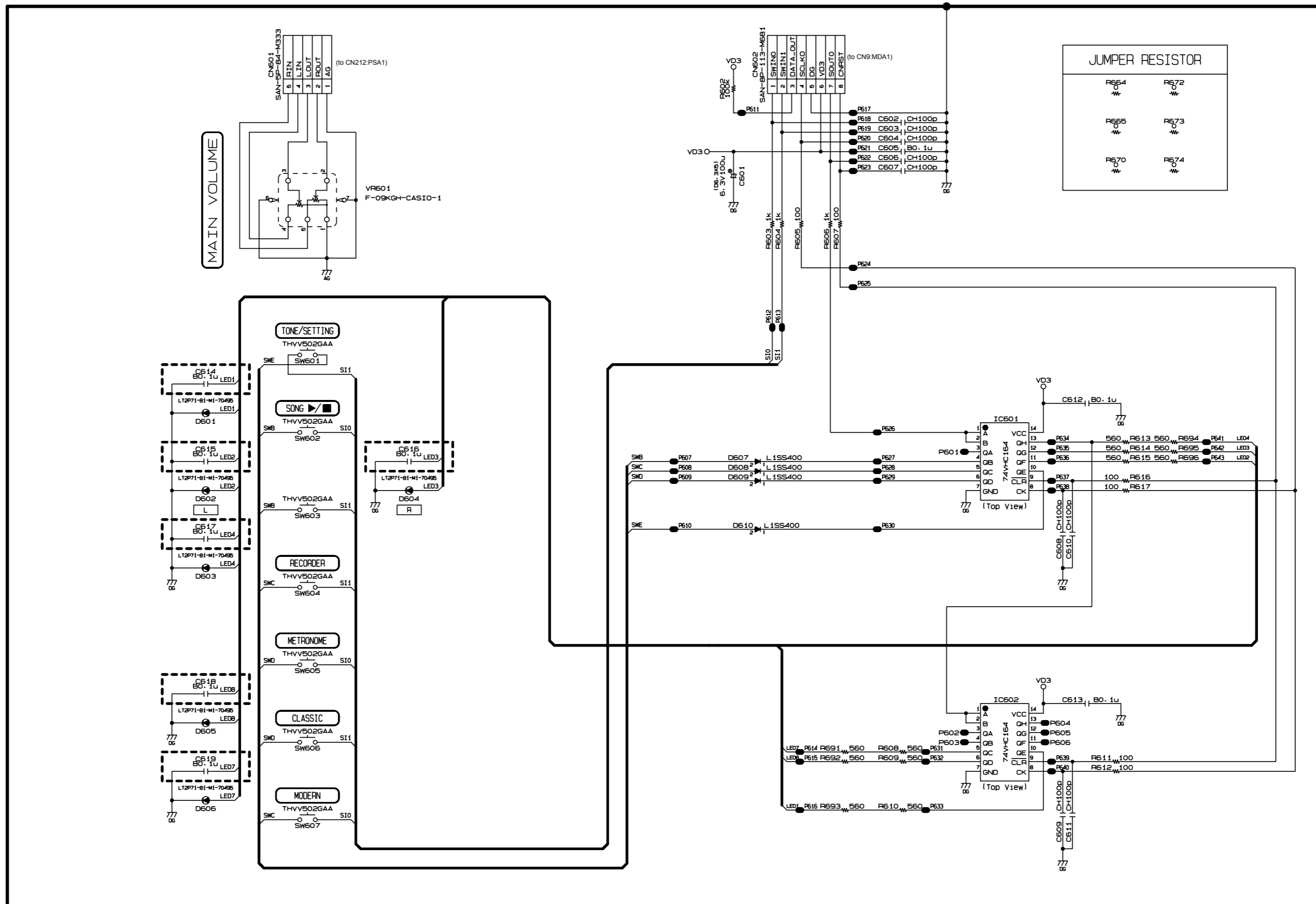

Console PCB M333-CNA2

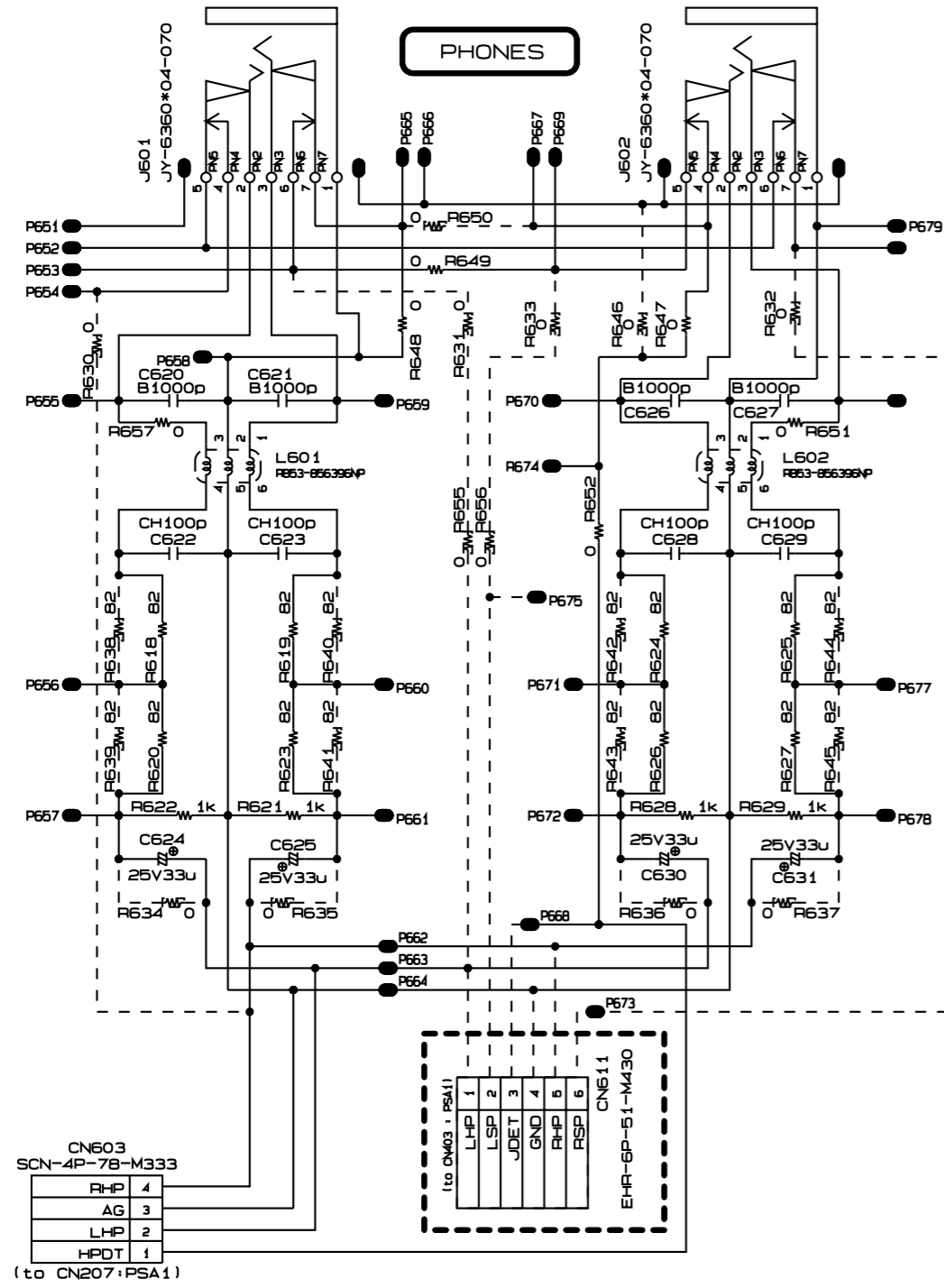

Console PCB M333-CNA3

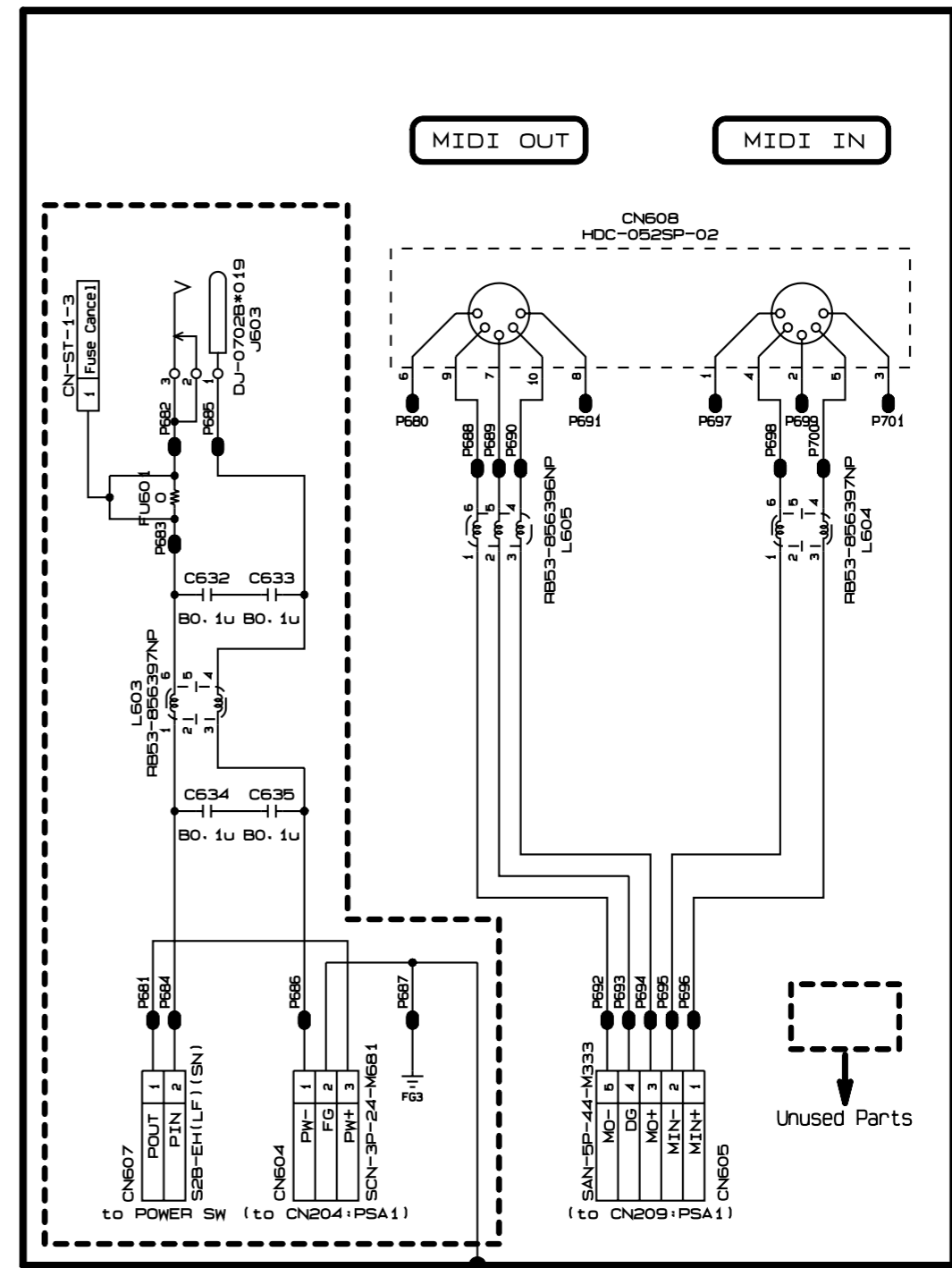

Console PCB M333-CNA4

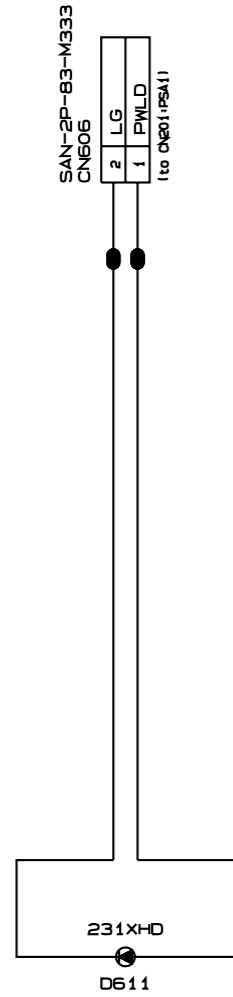

Console PCB M333-CNA5

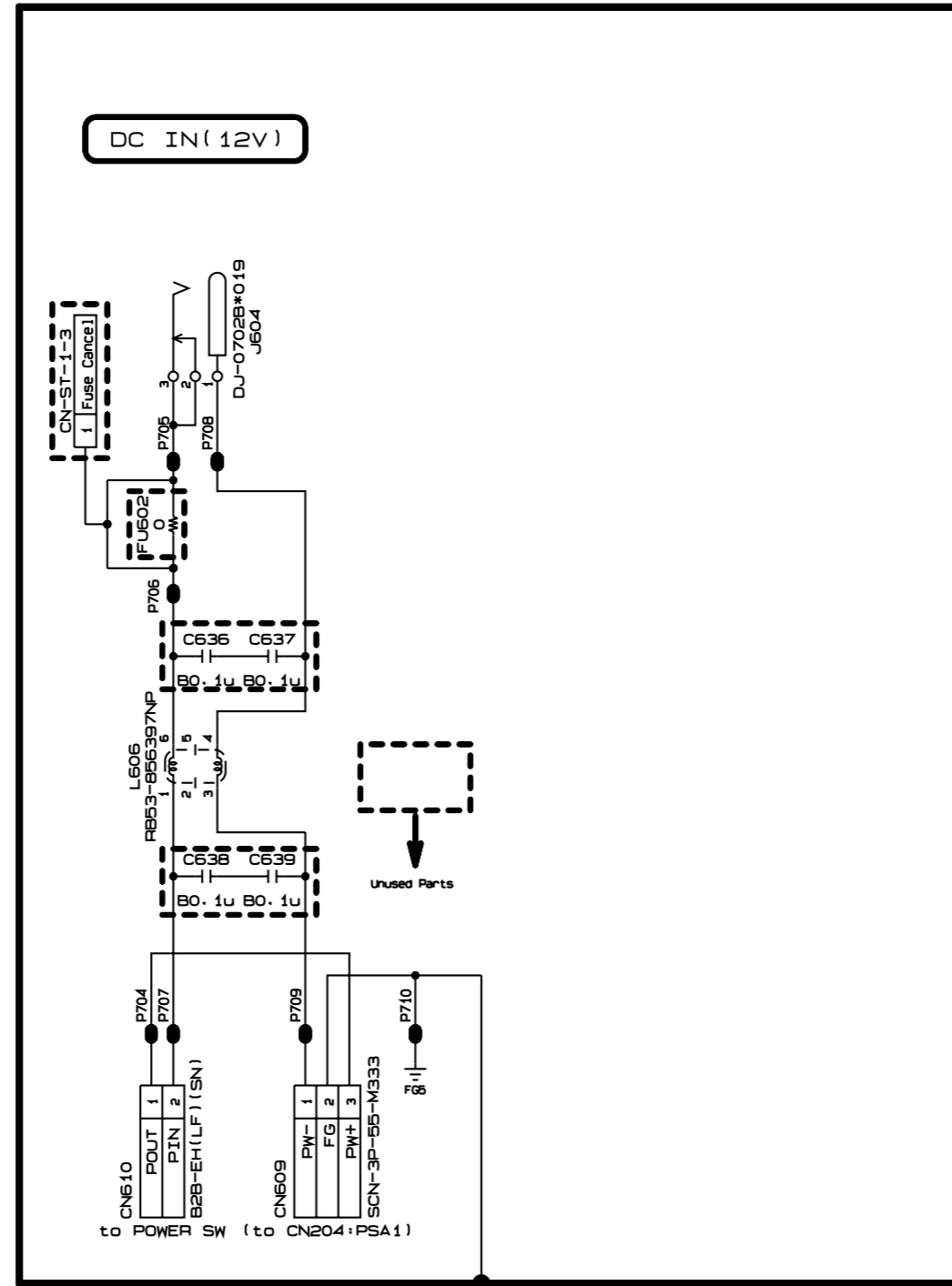

PWB-MCZS-KYA1

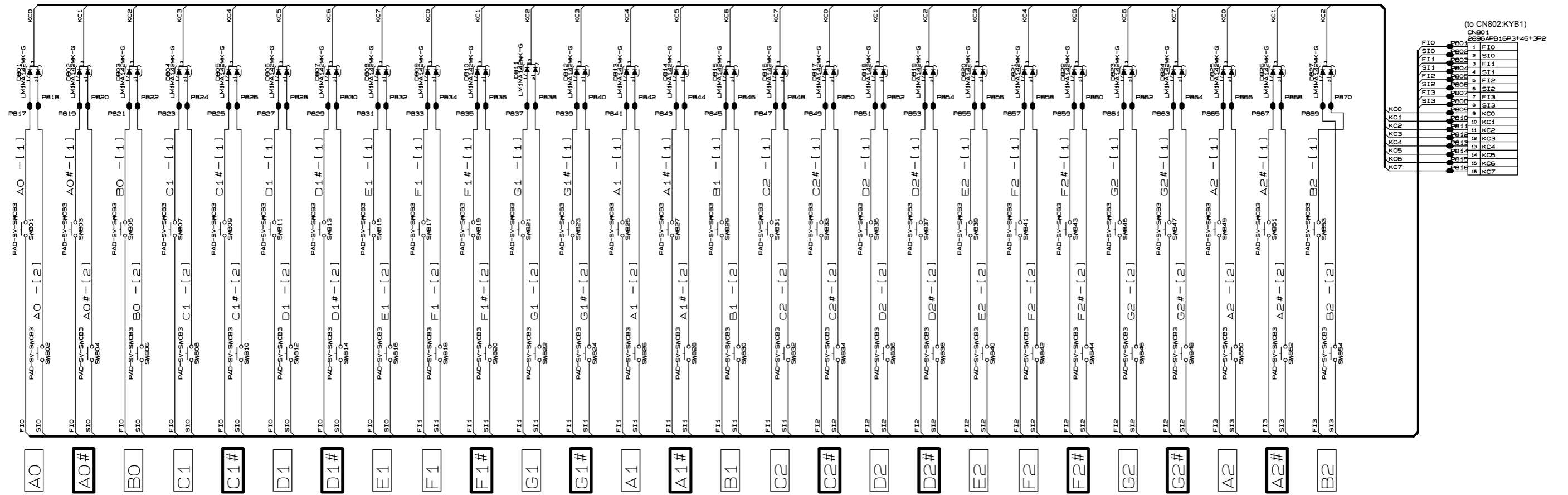

Console PCBs MCZS-KYB1

PWB-MCZS-KYB1

(to CN801:KYA1)

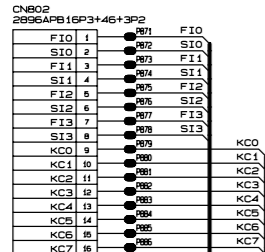

(to CN14:MDA1)

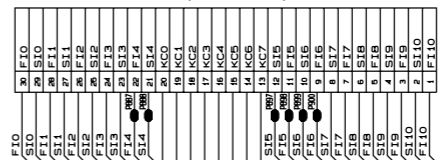

(to CN805:KYC1)

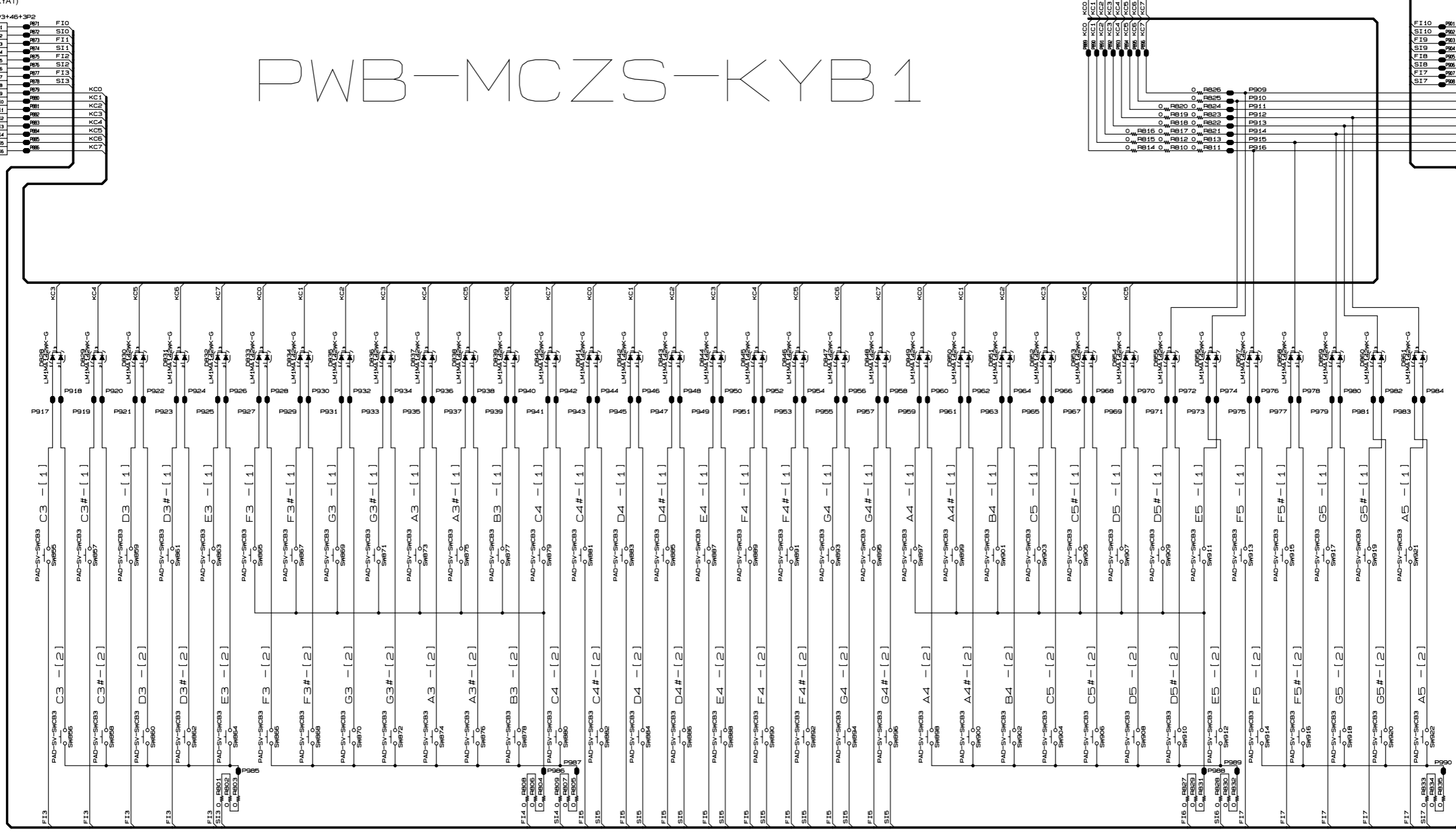
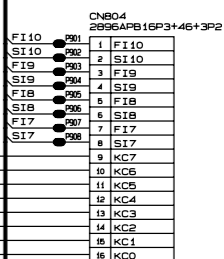

- C3
- C3#
- D3
- D3#
- E3
- F3
- F3#
- G3
- G3#
- A3
- A3#
- B3
- C4
- C4#
- D4
- D4#
- E4
- F4
- F4#
- G4
- G4#
- A4
- A4#
- B4
- C5
- C5#
- D5
- D5#
- E5
- F5
- F5#
- G5
- G5#
- A5

PWB-MCZS-KYC1

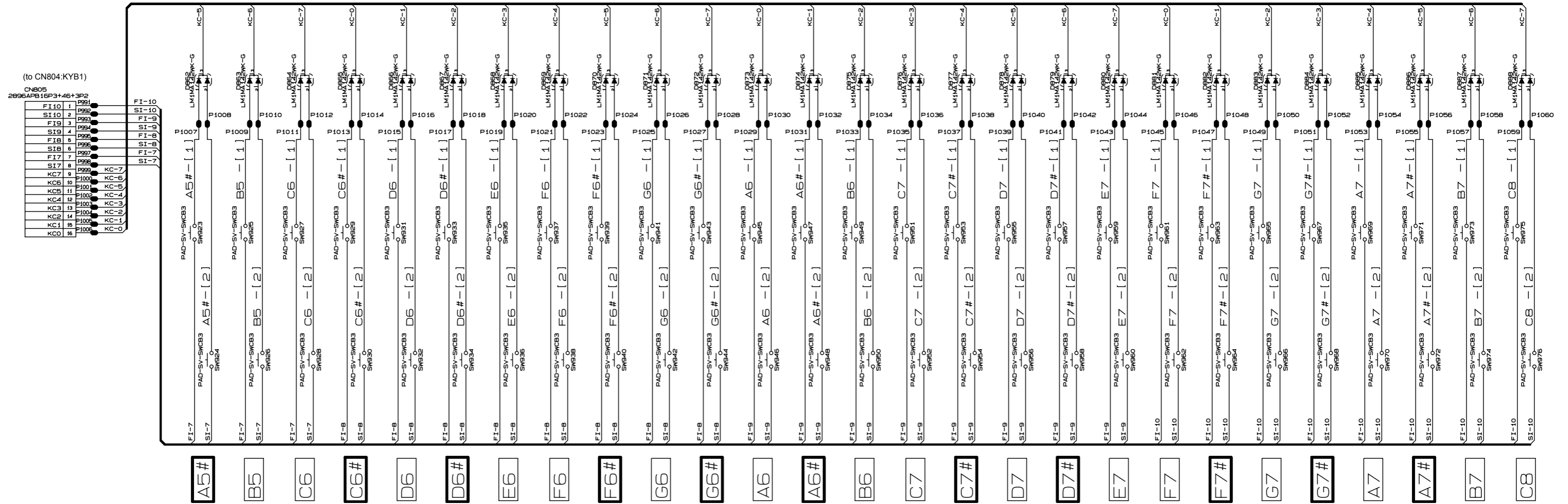

Ver.1 : Aug. 2008

- Correction of the EXPLODED VIEW (P25)

CASIO COMPUTER CO.,LTD.

Overseas Service Division

6-2, Hon-machi 1-Chome
Shibuya-ku, Tokyo 151-8543, Japan