

CASIO®

Service Manual

(without price)

AP-22S



INDEX

ELECTRONIC KEYBOARD

CONTENTS

Safety Notice	2
Specifications	4
Block Diagram	5
PCB Layout	6
Disassembly Instructions	7
Circuit Description	11
Major Waveforms	13
Printed Circuit Board	14
Troubleshooting	15
Wiring Diagram	19
Exploded View	20
Parts List	23
Schematic Diagrams	25

SAFETY NOTICE

CAUTION!

Danger of explosion if battery is incorrectly replaced. Replace only with the same or equivalent type.

DENMARK:

ADVARSE!

Lithiumbatteri. Eksplosionsfare ved fejlagtig handling.
Udskiftning må kun ske med batteri af samme fabrikat og type.
Lever det brugte batteri tilbage til leverandoren.

FINLAND:

VAROITUS

Paristo voi äjhtää, jos se on virheellisesti asennettu. Vaihda paristo ainoastaan valmistajan suosittelemaan tyyppiin. Hävitä käytetty paristo valmistajan ohjeiden mukaisesti.

SWEDEN:

VARNING

Felaktigt batteribyten kan medf fara för explosion. Använd därför endast samma typ eller likvärdig typ enligt apparattillverkarens rekommendation.

Kassera förbrukade batterier enligt tillverkarens anvisning.

SPECIFICATIONS

GENERAL

Keyboard:	88 piano keys (with touch response)
Polyphony:	32 notes, maximum
Tones:	<ul style="list-style-type: none">• 10 (including two bass tones)• Tuning Curves: 3 (preset for each tone)• Layer: Adjustable volume• Split: Split point, adjustable volume
Digital Effects:	Reverb (4 types), Chorus, Tremolo, Brilliance
Demo Tunes:	<ul style="list-style-type: none">• Number of Tunes: 8• Playback: Repeat (all tunes, one tune)
Memory:	<ul style="list-style-type: none">• Operations: Real-time recording, playback• Number of Tracks: 2 (Track A, Track B)• Capacity: Approximately 5,000 notes (total of 2 tracks)• Memory Backup: Built-in lithium battery (Battery Life: 5 years)
Song Lesson:	<ul style="list-style-type: none">• Number of Tunes: 80• Playback: All song repeat, specific song• Part Off: L, R• Phrase Repeat
Pedals:	Damper, Soft, Sostenuto
Other Functions:	<ul style="list-style-type: none">• Metronome: Beat (6 types), Tempo \downarrow = 30 to 300• Touch Select: 3types• Transpose: 1 octave (F# to C TO F)• Tuning: A4 + 440 Hz \pm13 Hz (adjustable)• Temperament: 7 types• Baroque pitch
MIDI:	16 multi-timbre receive
Input/Output:	<ul style="list-style-type: none">• Headphones: Standard stereo jacks \times 2• LINE OUT (R)(L): Standard stereo jacks \times 2 Output impedance 22 KΩ Output voltage: 2.0 V (RMS) MAX• LINE IN (R)(L): Standard stereo jacks \times 2 Input impedance: 30 KΩ Input voltage 200 mV• MIDI (OUT)(IN)
Speakers:	\varnothing 16 cm \times 2, \varnothing 5 cm \times 2 (Output: 30 W + 30 W)
Power Supply:	120 V (for U.S.A.), 120 V, 220 V, 230 V and 240 V (for other countries) AC household current via AC power cord supplied with piano.
Power Consumption:	70 W (with 120 V AC), 90 W (with 220 V, 230 V and 240 AC)
Dimensions:	<ul style="list-style-type: none">• CELVIANO Only: 139 \times 54 \times 25 cm (5.5 \times 2.1 \times 1.0 inch)• CELVIANO and Stand: 139 \times 54 \times 88 cm (5.5 \times 2.1 \times 3.5 inch)
Weight:	<ul style="list-style-type: none">• CELVIANO Only: approximately 48.5 kg (106.9 lbs)• CELVIANO and Stand: approximately 60.2 kg (132.7 lbs)
Accessories:	Stand with three pedals, score book, power cord

BLOCK DIAGRAM

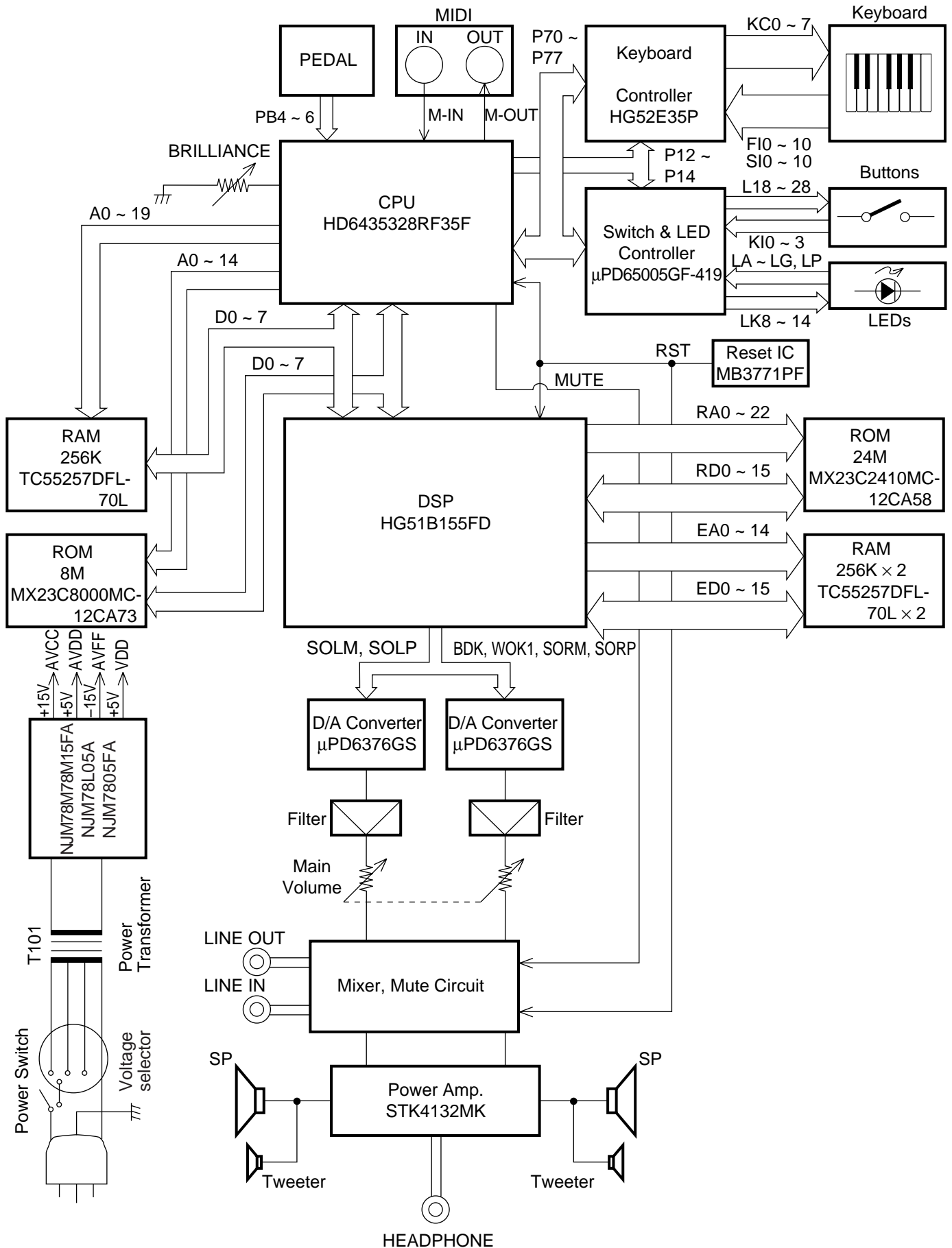

PCB LAYOUT

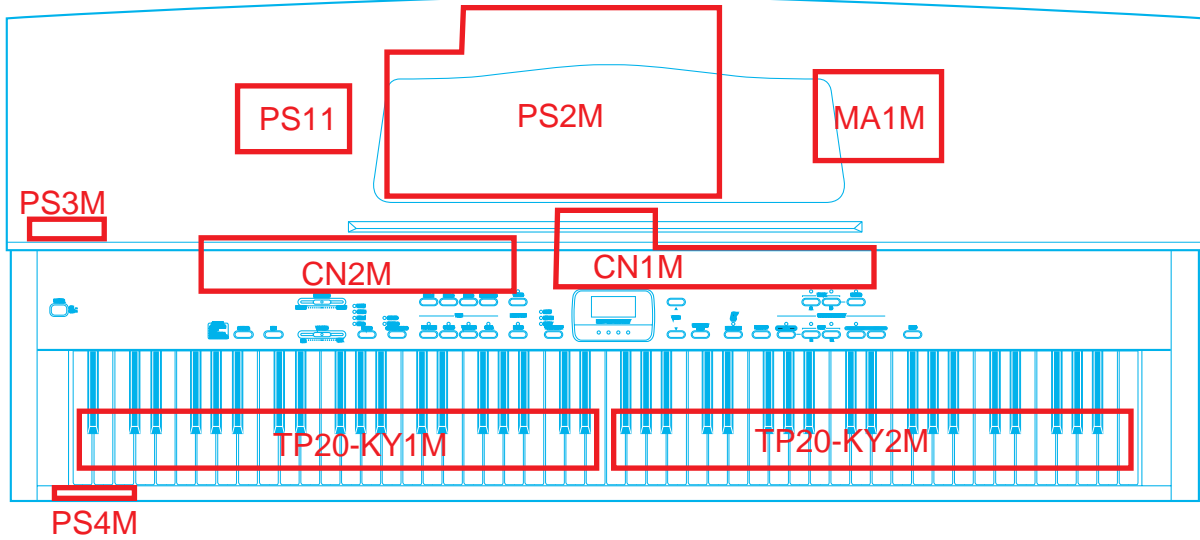

PCB	JCM434-	Components
Main PCB	MA1M	CPU, DSP, Sound Source ROM Working storage RAM, Effect RAM Reset IC, DAC, Filter, Key controller, Power amp, Power supply circuit
Jack PCBs	PS2M	LINE IN/OUT jack, MIDI jacks
	PS3M	Phone jacks
	PS4M	Power indicator
Console PCBs	CN1M	Gate array (Button controller/LED driver), LEDs, Buttons
	CN2M	Main Volume, Brilliance volume, LEDES, Buttons
Power PCB	PS11	Fuse, Noise filter

DISASSEMBLY INSTRUCTIONS

1. Disassembling top board

- 1-1. Remove 8 screws on the rear.
- 1-2. Slide the top board towards the rear.
The top board will be free from catches on the case.
- 1-3. Lift the top board.



2. Disassembling keyboard cover

- 2-1. Slide the keyboard cover to open fully.
- 2-2. Passing the gear into the opening on each rack, lift the keyboard cover.

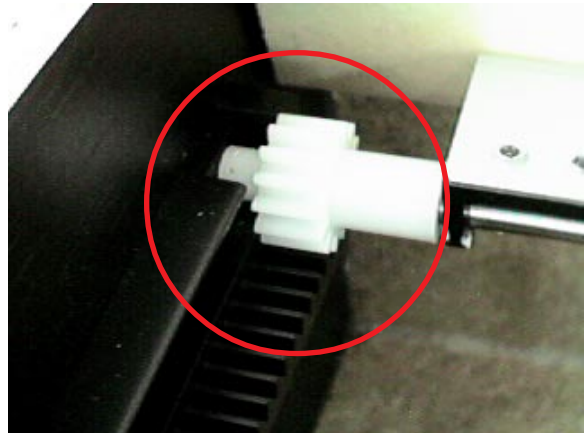

3. Disassembling console panel

Note: To avoid scratch on the side board, put paper between the console panel and the side board at both ends.

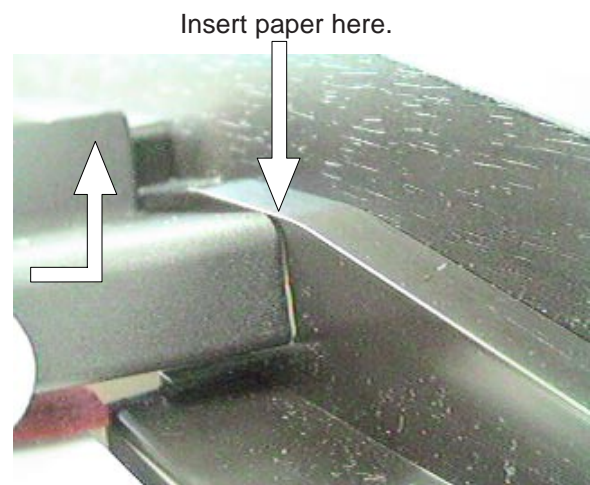

3-1. Remove three screws afixing the console panel.

3-2. Remove the screw fixing a grounding wire at the transformer.

3-3. Disconnect two connectors CF on PCB JCM434-PS2M and CD on PCB JCM434-MA1M

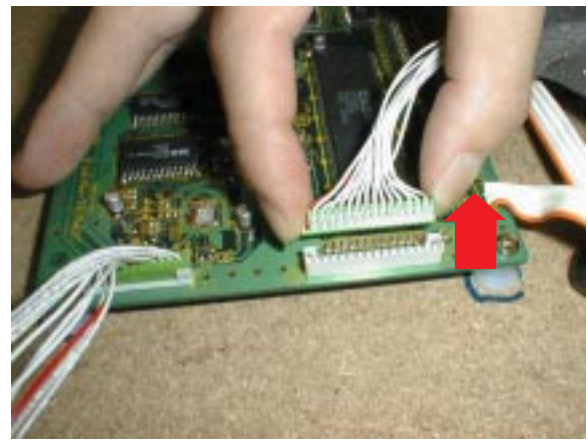
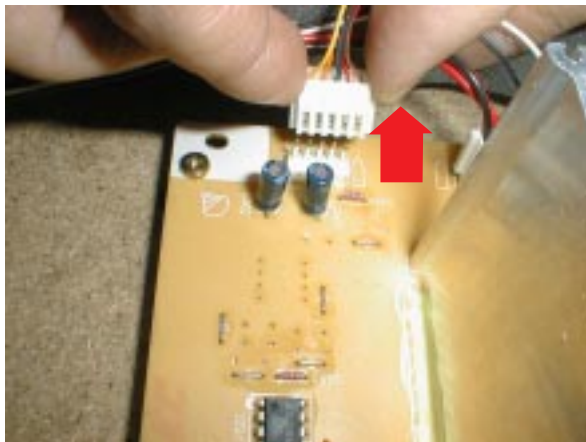

3-4. Slide the console panel towards the front to free from catches.

3-5. Turn round the console panel.

3-6. Remove the 2 screws fixing the power switch.

4. Disassembling front cover

- 4-1. Remove 9 screws at the front edge on the bottom.
- 4-2. Unscrew 2 screws and remove JCM434-PS4M

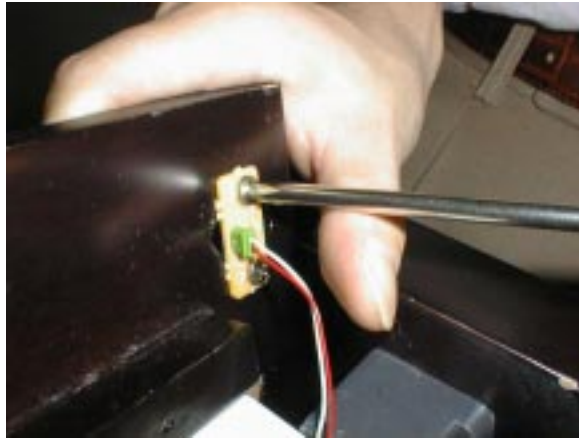

5. Disassembling keyboard unit

- 5-1. Remove 12 screws fixing front end of the keyboard unit and three screws supporting rear end of the keyboard.



- 5-2. Remove 2 connectors CA and CB on PCB JCM434-MA1M.
- 5-3. Lift up the keyboard unit.

6. Disassembling keys

6-1. Pressing the hook with long-nose pliers, lift the key.

6-2. Using pliers, remove key spring.



7. Disassembling keyboard PCBs

7-1. Turn round the keyboard unit to face the PCB up.

7-2. Disconnect the connector at the middle of keyboard.

7-3. Remove screws on the keyboard PCBs.

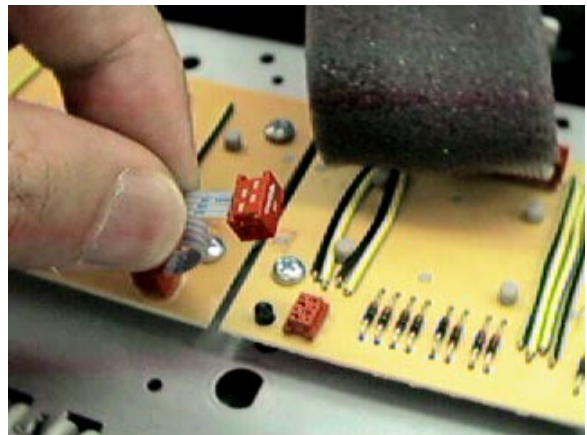

8. Replacing the main PCB

Note: The main PCB contains a lithium battery for memory back-up. Please remove the jumper before replacing the PCB. And make sure that the jumper is reset on new main PCB after replacing the PCB. Because no jumper is set on a spare part of the main PCB.

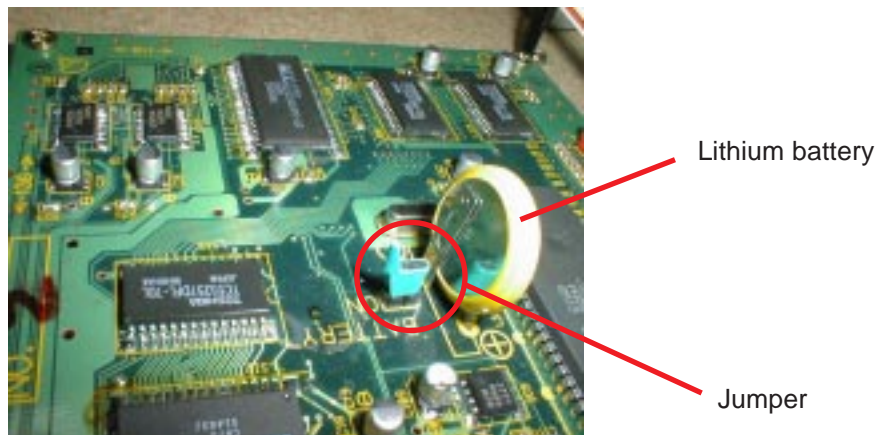

CIRCUIT DESCRIPTION

KEYMATRIX

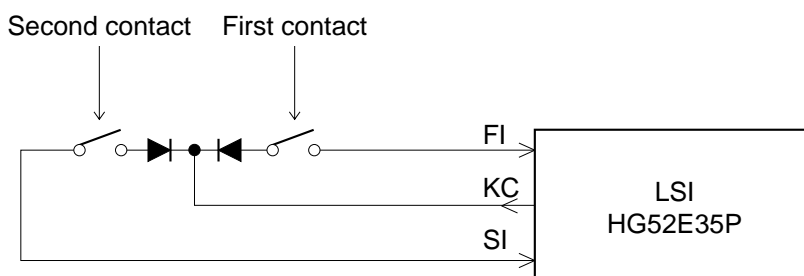

	KC0	KC1	KC2	KC3	KC4	KC5	KC6	KC7
FI0	A0 ①	A0 # ①	B0 ①	C1 ①	C1 # ①	D1 ①	D1 # ①	E1 ①
SI0	A0 ②	A0 # ②	B0 ②	C1 ②	C1 # ②	D1 ②	D1 # ②	E1 ②
EI1	F1 ①	F1 # ①	G1 ①	G1 # ①	A1 ①	A1 # ①	B1 ①	C2 ①
SI1	F1 ②	F1 # ②	G1 ②	G1 # ②	A1 ②	A1 # ②	B1 ②	C2 ②
FI2	C2 # ①	D2 ①	D2 # ①	E2 ①	F2 ①	F2 # ①	G2 ①	G2 # ①
SI2	C2 # ②	D2 ②	D2 # ②	E2 ②	F2 ②	F2 # ②	G2 ②	G2 # ②
FI3	A2 ①	A2 # ①	B2 ①	C3 ①	C3 # ①	D3 ①	D3 # ①	E3 ①
SI3	A2 ②	A2 # ②	B2 ②	C3 ②	C3 # ②	D3 ②	D3 # ②	E3 ②
FI4	F3 ①	F3 # ①	G3 ①	G3 # ①	A3 ①	A3 # ①	B3 ①	C4 ①
SI4	F3 ②	F3 # ②	G3 ②	G3 # ②	A3 ②	A3 # ②	B3 ②	C4 ②
FI5	C4 # ①	D4 ①	D4 # ①	E4 ①	F4 ①	F4 # ①	G4 ①	G4 # ①
SI5	C4 # ②	D4 ②	D4 # ②	E4 ②	F4 ②	F4 # ②	G4 ②	G4 # ②
FI6	A4 ①	A4 # ①	B4 ①	C5 ①	C5 # ①	D5 ①	D5 # ①	E5 ①
SI6	A4 ②	A4 # ②	B4 ②	C5 ②	C5 # ②	D5 ②	D5 # ②	E5 ②
FI7	F5 ①	F5 # ①	G5 ①	G5 # ①	A5 ①	A5 # ①	B5 ①	C6 ①
SI7	F5 ②	F5 # ②	G5 ②	G5 # ②	A5 ②	A5 # ②	B5 ②	C6 ②
FI8	C6 # ①	D6 ①	D6 # ①	E6 ①	F6 ①	F6 # ①	G6 ①	G6 # ①
SI8	C6 # ②	D6 ②	D6 # ②	E6 ②	F6 ②	F6 # ②	G6 ②	G6 # ②
FI9	A6 ①	A6 # ①	B6 ①	C7 ①	C7 # ①	D7 ①	D7 # ①	E7 ①
SI9	A6 ②	A6 # ②	B6 ②	C7 ②	C7 # ②	D7 ②	D7 # ②	E7 ②
FI10	F7 ①	F7 # ①	G7 ①	G7 # ①	A7 ①	A7 # ①	B7 ①	C8 ①
SI10	F7 ②	F7 # ②	G7 ②	G7 # ②	A7 ②	A7 # ②	B7 ②	C8 ②

BUTTON MATRIX

	KI0	KI1	KI2	KI3
L18	STEP BY STEP	PART L	PART R	NEXT
L19	TOUCH SELECT	TRACK A	TRACK B	PLAY/STOP
L20	TEMPO/ BEAT/FIXED	METRONOME		
L24	PIANO 2	E. PIANO	HARPSICHORD	W.BASS
L25	PIANO 1	STRINGS	CHOIR	E.BASS
L26	VIBRAPHONE	PIPEORGAN	CHORUS/ TREMLOLO	REVERB
L27	SONG SELECT		RECORD	
L28		VALUE DOWN	VALUE UP	DEMO

POWER SUPPLY CIRCUIT

The power supply circuit generates four voltages as shown in the following table.

Name	Voltage	For operation of
VDD	+5 V	CPU, Reset IC, Working storage RAM, DSP, Key touch LSI, Sound source ROM, Effect RAM, Gate array
AVDD	+5 V	DAC
AVCC	+15 V	Filter, Mixer
AVFF	-15 V	Filter, Mixer

MAJOR WAVEFORMS

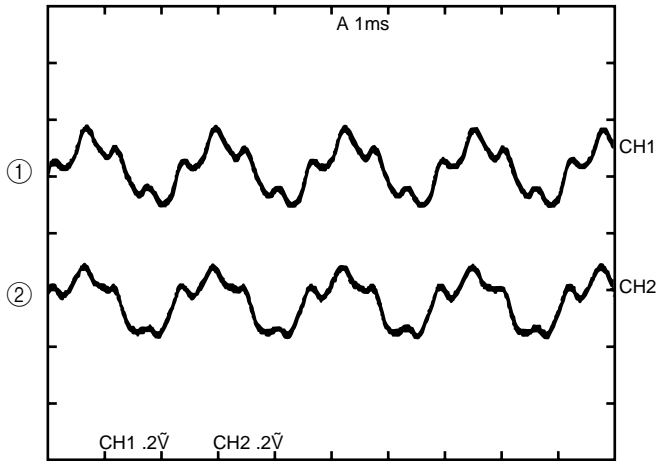

- ① Filter output L-ch CF connector pin 4
- ② Filter output R-ch CF connector pin 5

Tone : Piano 1
Key : A4

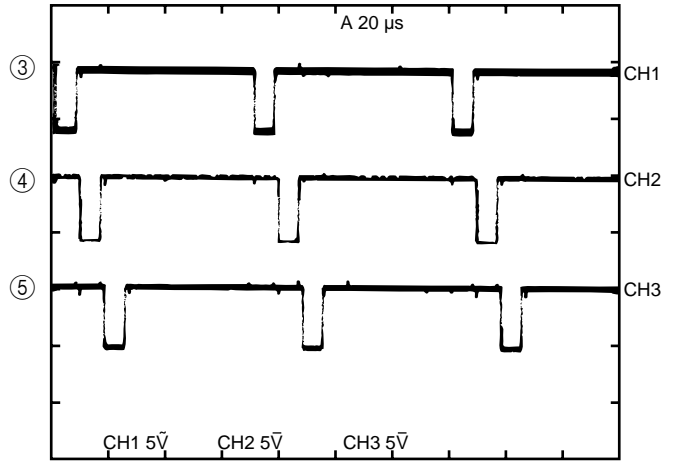

- ③ Key scan signal KC0 CB connector pin 2
- ④ Key scan signal KC1 CB connector pin 4
- ⑤ Key scan signal KC2 CB connector pin 6

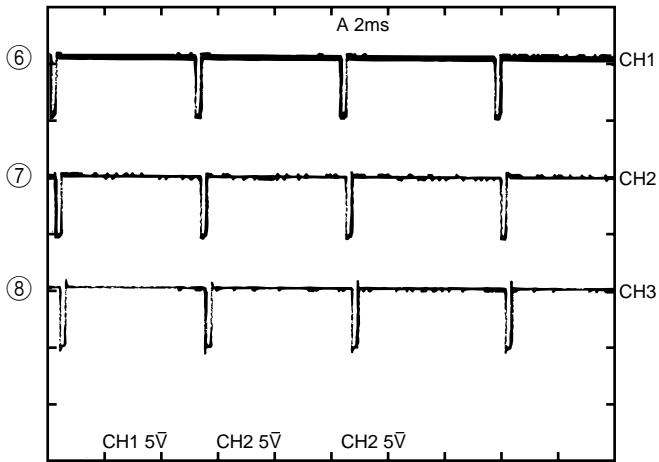

- ⑥ Button scan signal L24 UPD65005GF-419 pin 53
- ⑦ Button scan signal L25 UPD65005GF-419 pin 54
- ⑧ Button scan signal L26 UPD65005GF-419 pin 55

PRINTED CIRCUIT BOARD

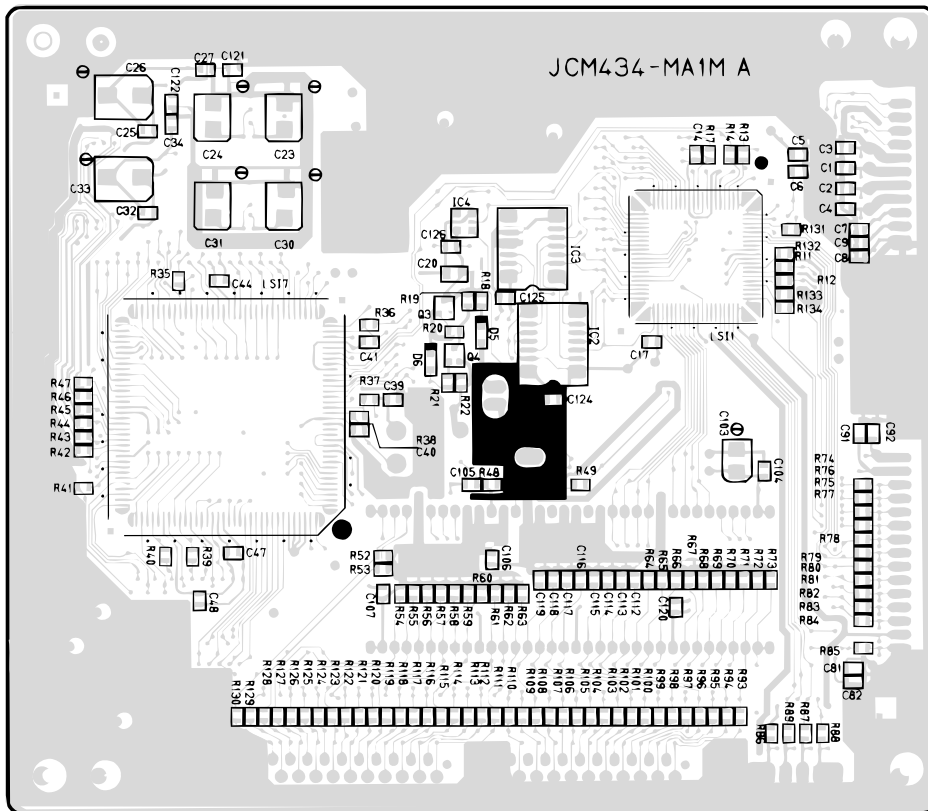

Top View

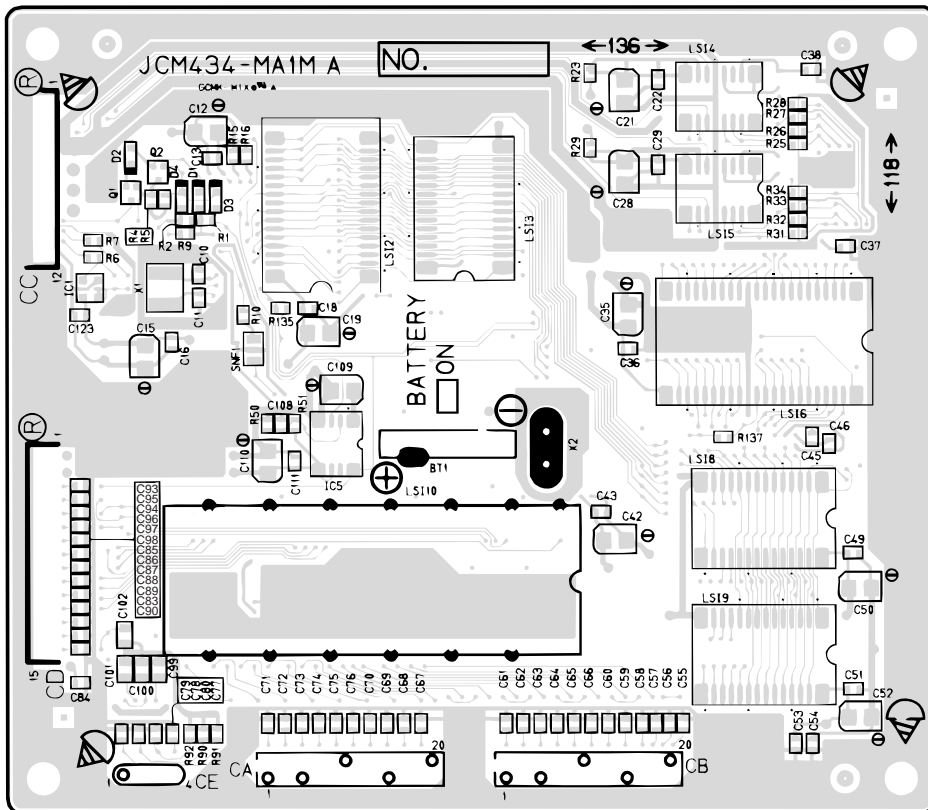

Bottom View

TROUBLESHOOTING

1. No power

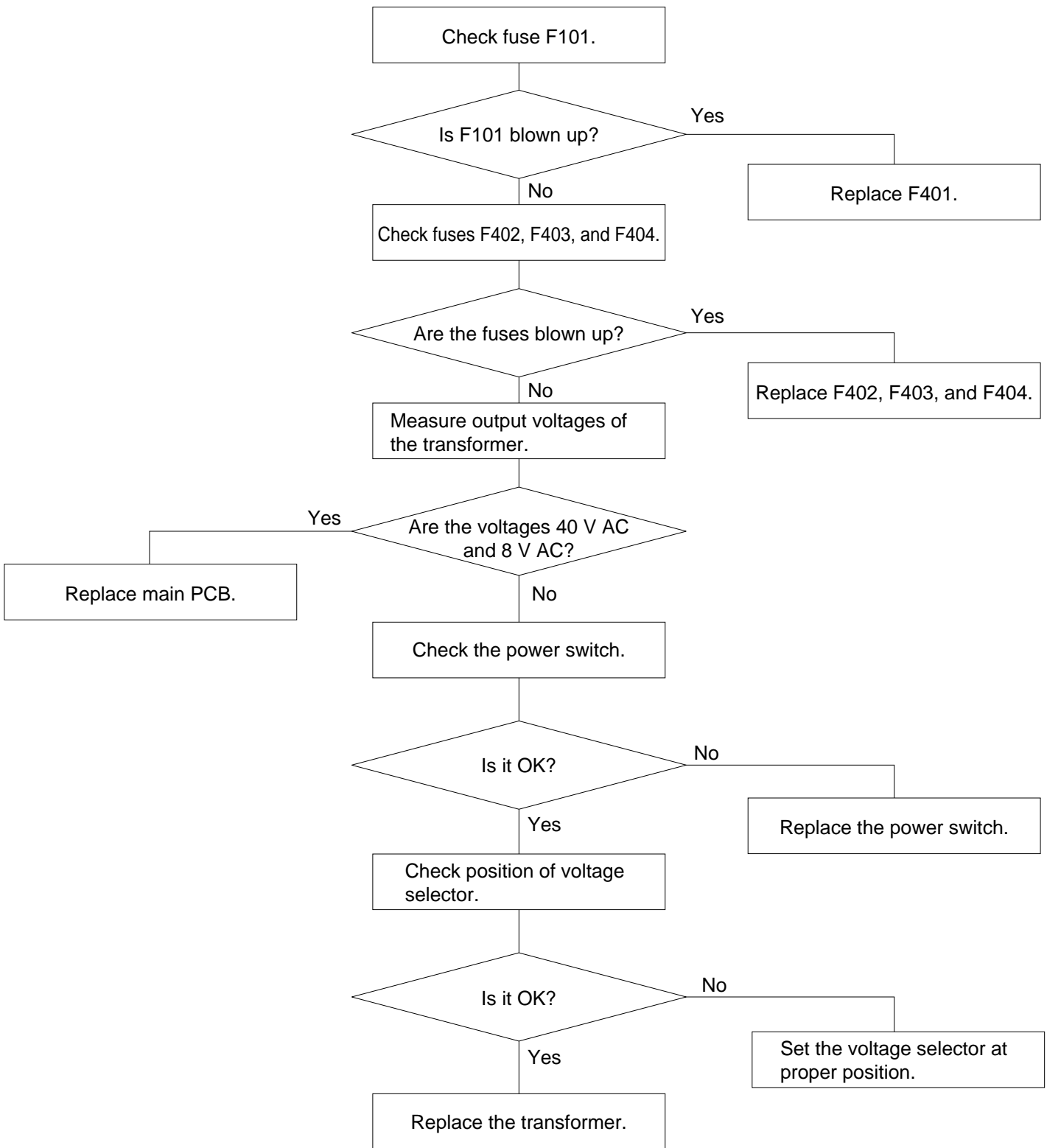

2. No sound

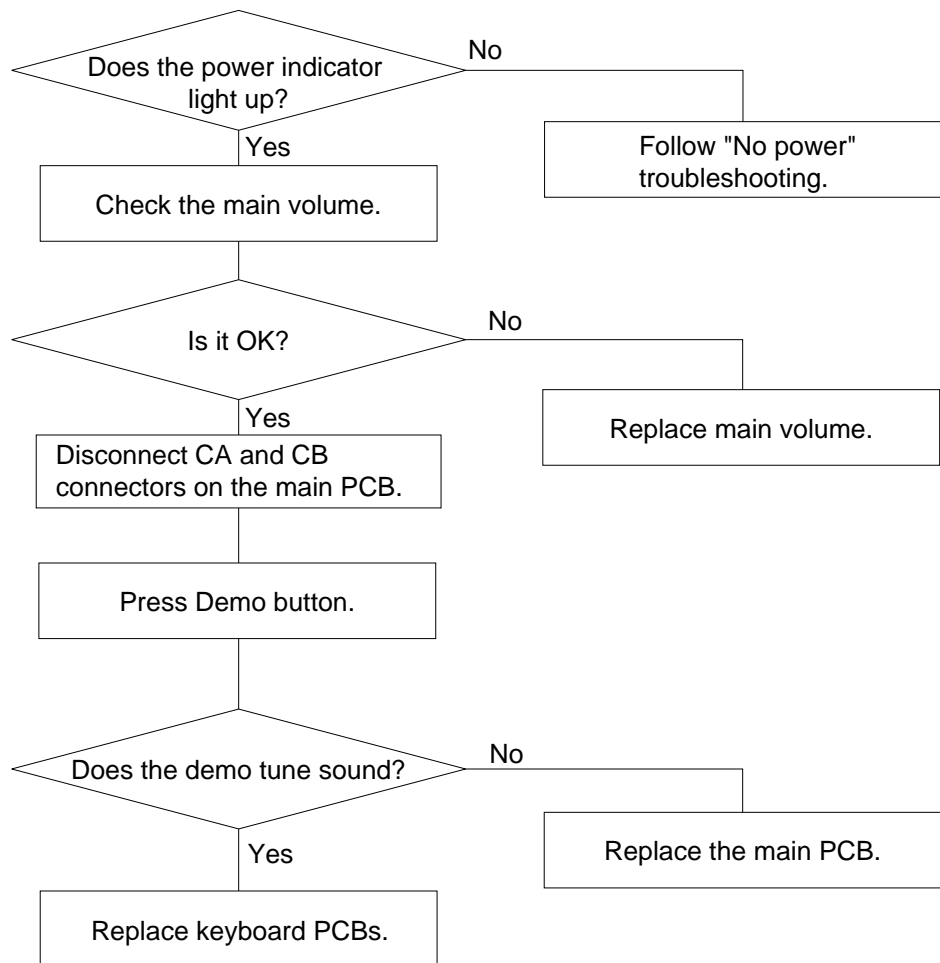

3. Distorted sound

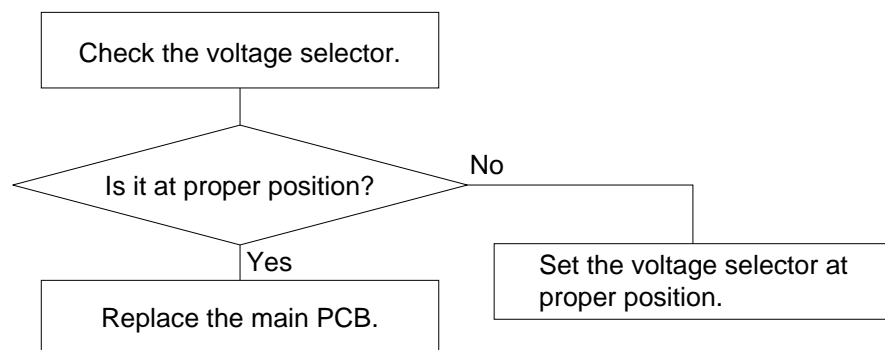

4. Certain keys do not function

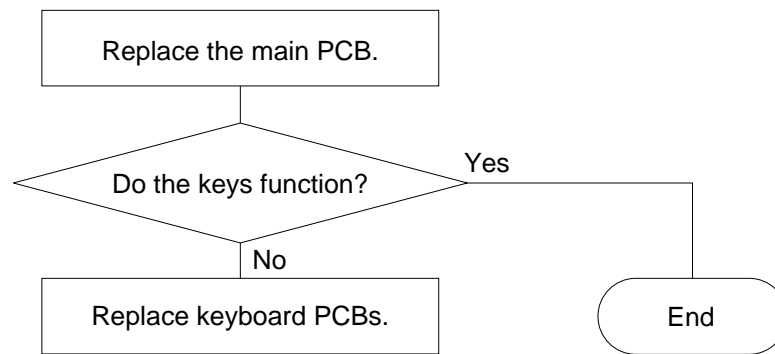

5. A certain key does not function

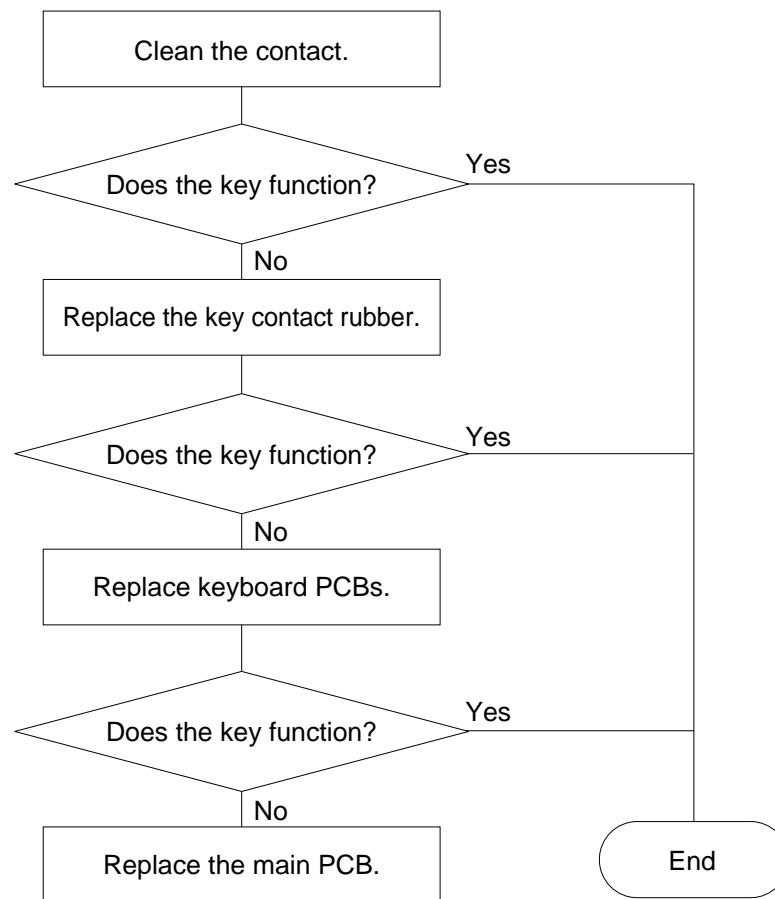

6. A certain button does not function

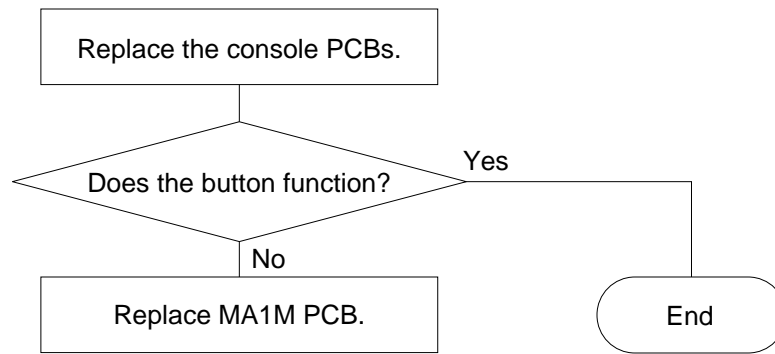

7. A certain tone is strange when record/playback

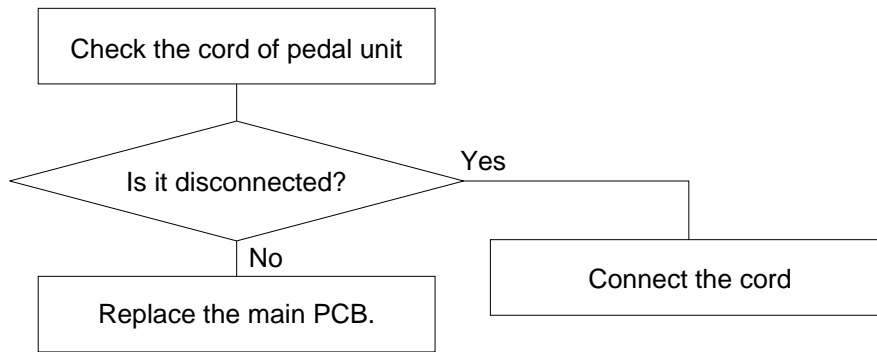

WIRING DIAGRAM

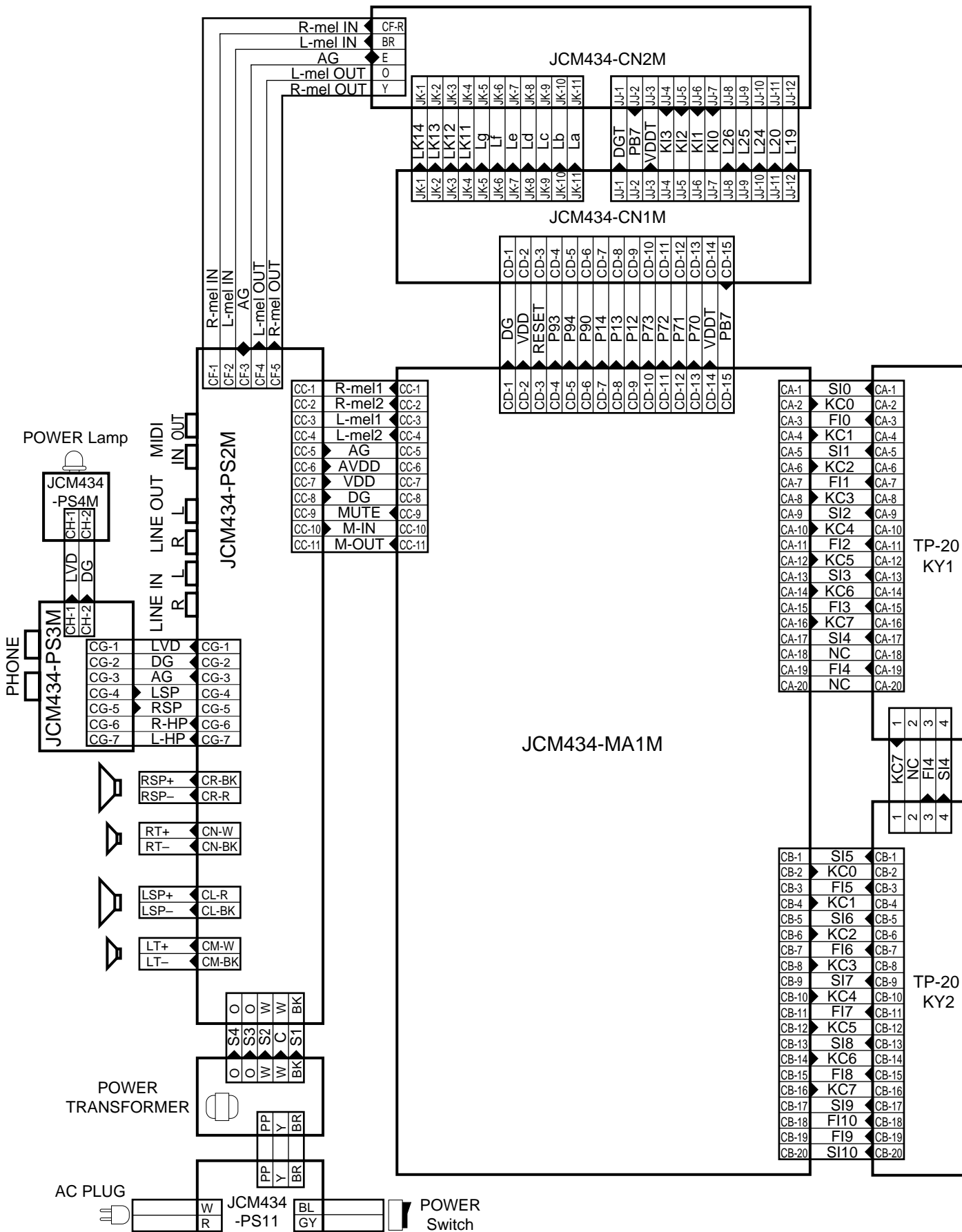

EXPLODED VIEW

CABINET

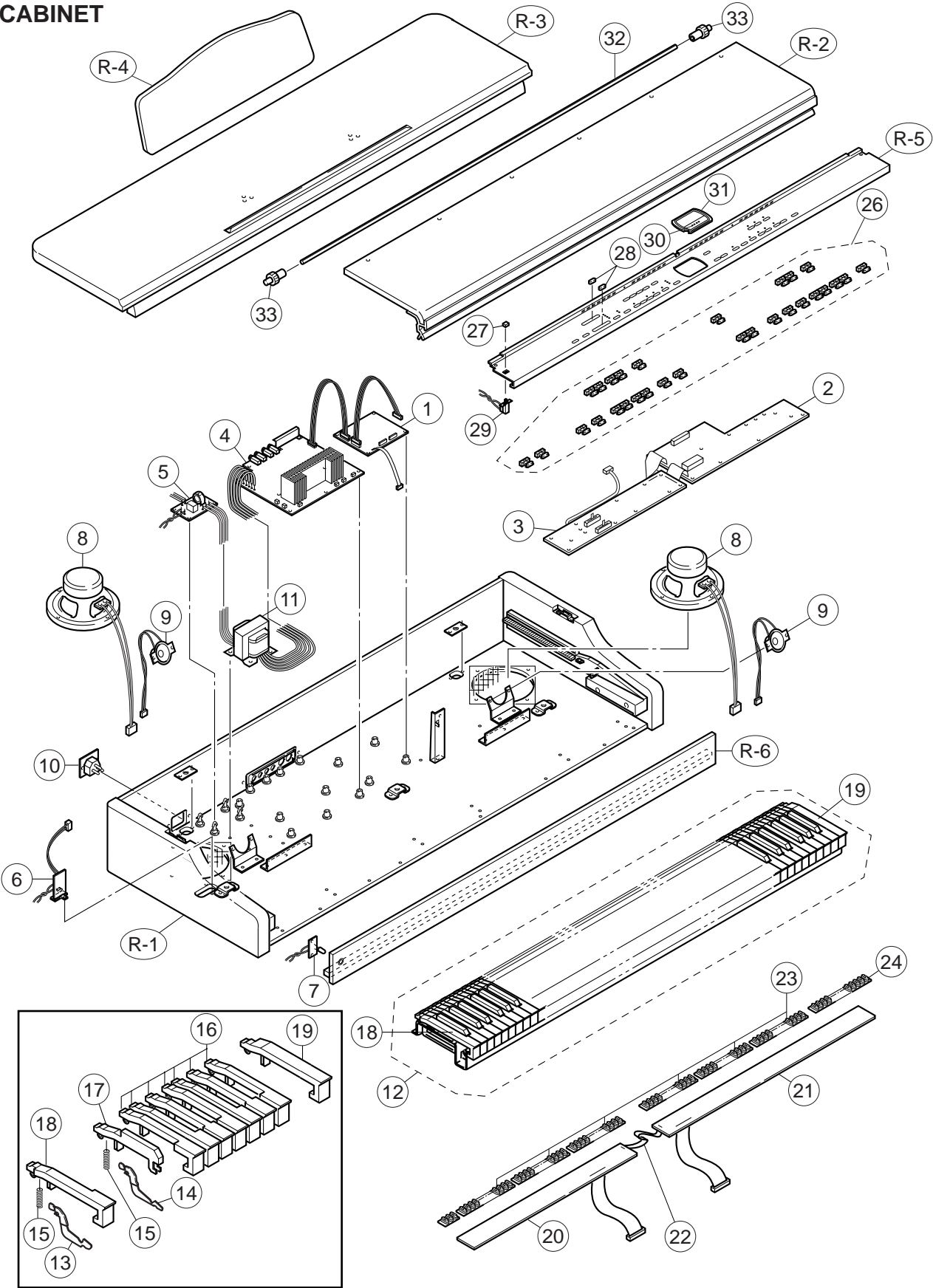

STAND

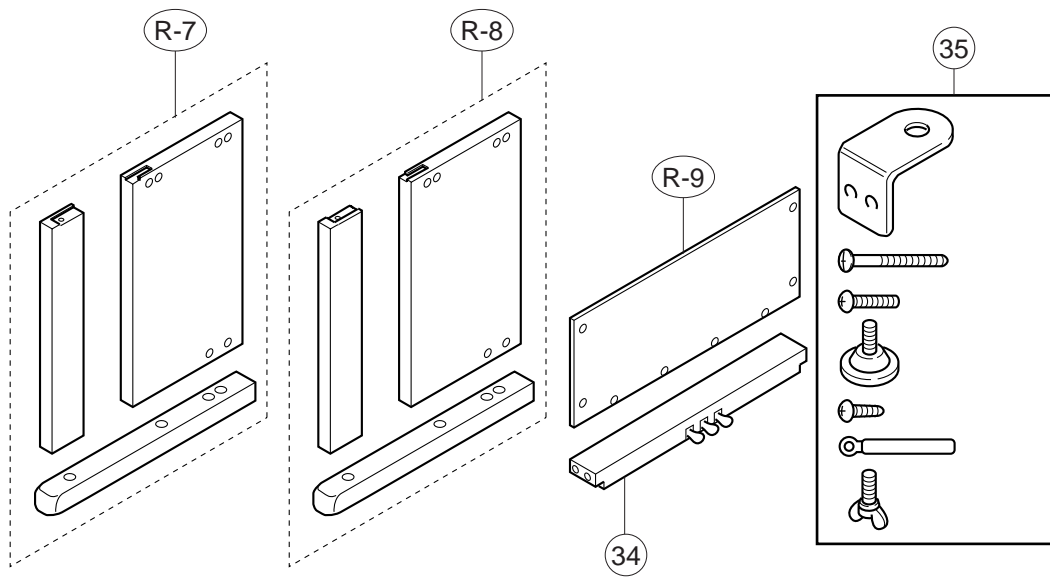

PARTS LIST

AP-22S

Notes: This parts list does not include the cosmetic parts, which parts are marked with item No. "R-X" in the exploded view.

Contact our spare parts department if you need these parts for refurbish.

1. Prices and specifications are subject to change without prior notice.
2. As for spare parts order and supply, refer to the "GUIDEBOOK for Spare parts Supply", published separately.
3. The numbers in item column correspond to the same numbers in drawing.

Item	Code No.	Parts Name	Specification	Q	R
Main PCB					
BT1	3815 0794	BATTERY/LITHIUM	CR2032/1VC1	1	B
D1 - D5	2390 2555	DIODE/SHOTTKY	RB500V-40TE-17	5	B
D6	2360 3057	DIODE/ZENER	UDZTE-173.3B	1	A
IC1	2105 1120	IC/MOS	TC7S08F-TE85R	1	B
IC2	2105 6354	IC/MOS	TC74HC27AF(TP1)	1	B
IC3	2105 6353	IC/MOS	TC74HC11AF(TP1)	1	B
IC4	2105 6355	IC/MOS	TC7S00F(TE85R)	1	B
IC5	2114 4060	IC	MB3771PF-EF	1	B
LSI1	2012 5844	LSI	HD6435328RF35F	1	A
LSI10	2011 5194	LSI/KEY CONTROLLER	HG52E35P	1	A
LSI2	2012 5843	LSI	MX23C8000MC-12CA73	1	A
LSI3/8/9	2012 5572	LSI/RAM	TC55257DFL-70L(EL)	3	A
LSI4/5	2114 4221	LSI/DAC	UPD6376GS-E1	2	A
LSI6	2012 5707	LSI	MX23C2410MC-12CA58	1	A
LSI7	2012 1316	LSI/DSP	HG51B155FD-1	1	A
Q1 - Q3	2250 1162	TRANSISTOR	2SA1576AT106R	3	A
Q4	2252 0637	TRANSISTOR	2SC4081T106R	1	A
SNF1	3025 1505	CHIP EMI FILTER	NFM51R00P106	1	B
X1	2590 2100	OSCILLATOR/CERAMIC	CSACS20.00MX040-TC	1	B
X2	2590 2709	OSCILLATOR/CERAMIC	HC-49US16384	1	B
1	6926 1980	M434-MA1M PCB ASSY	M140657*1	1	A
Console PCBs					
LED306 - LED332	2370 0630	LED	LN282RPX-(TX3)	27	B
LED302	2370 1386	LED	LN282RPX(V)-(TX2)	1	B
LED303 - LED305	2370 0679	LED	LN382GPX-(TX2)	3	B
LED301	2370 0497	LED	LB-603VP	1	B
IC301	2114 3318	IC	BA612	1	B
LSI301	2011 0812	LSI	UPD65005GF-419	1	A
Q309 - Q312	2220 1409	TRANSISTOR	2SC1740SR-TP-T	4	A
Q301 - Q308	2259 1883	TRANSISTOR	DTA114TS-TP-T	8	A
SW301 - SW329	3412 0903	SWITCH/TACT	EVQ-21405R	29	A
VR301	2765 0280	POTENTIOMETER	EWA-NAXCH1B14	1	A
VR302	2765 2187	POTENTIOMETER	EWA-NFECH1B54	1	A
2	6926 2060	M434-CN1M PCB ASSY	M140658*1	1	A
2	6926 2070	M434-CN2M PCB ASSY	M140659*1	1	A
Power supply PCBs					
D405 - D408	2390 3022	DIODE	3BZ41(LC6-15)	4	B
D416	2390 1323	DIODE	RB100A-T32-T	1	B
D422/423	2360 1729	DIODE	MTZJ5.1AT-77-T	2	B
F402	3632 0273	FUSE/TIME-LAG (US,CANADA)	UL-TSC-1.6A-N1	1	A
F402	3631 1045	FUSE/TIME-LAG (OTHERS)	(S)T-1.6A	1	A
F403/406	3632 0420	FUSE/TIME-LAG (US,CANADA)	UL-TSC-6.3A-N1	2	A
F403/406	3632 0427	FUSE/TIME-LAG (OTHERS)	(S)T-6.3A	2	A
IC401	2114 5794	IC	NJM78M15FA	1	B
IC402	2114 5795	IC	NJM79M15FA	1	B
IC403	2114 5797	IC	NJM78L05A(T3)	1	B
IC404	2114 3444	IC	NJM7805FA	1	B
IC405	2114 2149	IC	STK4152MK2	1	B
IC406/408/410/411	2114 1799	IC	M5218APR	4	B
IC409	2252 1248	IC/PHOTO COUPLER	HCPL-261A	1	B
J401/402	3612 0584	JACK	YKB21-5012	2	A
J403/404	3612 0789	JACK	YKB21-5010	2	A
J405	3501 4816	JACK/DIN	YKF51-5051	1	B
Q401 - Q404	2254 0551	FET	2SK365-BL(TPE4)	4	A

Notes: Q – Quantity per unit
R – Rank

Item	Code No.	Part Name	Specification	Q	R
4	6926 5800	M434-PS2M PCB ASSY (US,CANADA,DIRECT 110 - 127V AREA)	M140654*2	1	A
4		M434-PS2M PCB ASSY (EU,DIRECT 220 - 240V AREA)	M140654*3	1	A
PS11, PS3, PS4 PCBs					
J406	3613 1533	JACK	HLJ4336-01-3040	1	A
F401	3632 0720	FUSE/TIME-LAG (US,CANADA)	MT4-3.15A-N1	1	A
F401	3631 1045	FUSE/TIME-LAG (OTHERS)	(S)T-1.6A	1	A
L401	3013 2577	COIL/CHOKE	PLAC1522R0R01B1	1	B
LED401	2320 9748	LED	LN28RPH	1	B
SW402	3613 1740	VOLTAGE SELECTOR	HXW1219-01-110	1	B
5	6926 2160	M434-PS11 PCB ASSY (US,CANADA,DIRECT 110 - 127V AREA)	M340695*1	1	A
5		M434-PS11 PCB ASSY (EU,DIRECT 220 - 240V AREA)	M340695*2	1	A
6	6926 2030	M434-PS3M PCB ASSY	M340697*1	1	A
7	6926 2290	M434-PS4M PCB ASSY	M340698*1	1	A
Other electrical parts					
8	3831 1077	SPEAKER	SG16G51BFA	2	B
9	3831 1075	SPEAKER/TWEETER	S05JH37A	2	B
10	3613 0217	RECEPTACLE	NC-174-10-C	1	B
11	3012 1593	TRANSFORMER	TE-434-1M1	1	B
Keyboard unit					
12	6926 0370	KEYBOARD UNIT	88TP/20CASIO	1	B
13	6926 4890	HAMMER/WHITE KEY	88TP/20(42366750)	52	B
14	6926 4900	HAMMER/BLACK KEY	88TP/20(42366790)	36	B
15	6926 4940	SPRING/FOR KEY	88TP/20(23002160)	88	B
16	6926 4950	WHITE KEY/ 1-OCTAVE	88TP/20(42123920)	7	A
17	6926 4960	BLACK KEY/1-OCTAVE	88TP/20(42123910)	7	A
18	6926 5280	INITIAL KEY/A0	88TP/20(42328510)	1	A
19	6926 5290	FINAL KEY/C0	88TP/20(42328500)	1	A
20	6924 9060	PCB/KEYBOARD (DX)	88TP/20(42912070)	1	C
21	6924 9070	PCB/KEYBOARD (SX)	88TP/20(42912080)	1	C
22	6924 9080	FLAT CABLE	88TP/20(42901000)	1	C
23	6924 9190	CONTACT/RUBBER	88TP/20(2564230)	1	B
24	6924 9200	CONTACT/RUBBER	88TP/20(2564240)	1	B
Mechanical parts					
26	6926 1740	BUTTON SET 434	M240744*1	1	B
27	6924 5260	BUTTON/POWER	M340318-1	1	B
28	6919 3240	KNOB/SLIDE	M311405-1	2	A
29	6924 4710	SWITCH ASSY/POWER	M340337*1	1	B
30	6926 2440	PANEL/DISPLAY	M240668-1	1	C
31	6926 2450	PLATE/DISPLAY	M340658-1	1	C
32	6924 5120	SHAFT	M440300-1	1	C
33	6924 5140	GEAR	4247002100	2	C
Stand					
34	6926 5960	PEDAL BOX	CA025/030	1	B
35	6926 5410	SCREW SET	CA025/020	1	B
AC cord					
	3701 0196	AC CORD (120V,USA)	UC-964-J01	1	C
	3701 0595	AC CORD (230V,Europe)	EC-654-E06	1	C
	3701 1008	AC CORD (230V,UK)	SP22-17022A	1	C
	3701 0553	AC CORD (240V,AUSTRALIA)	SC-101-J02	1	C

Notes: Q – Quantity per unit
R – Rank

SCHEMATIC DIAGRAMS

Main PCB JCM434-MA1M

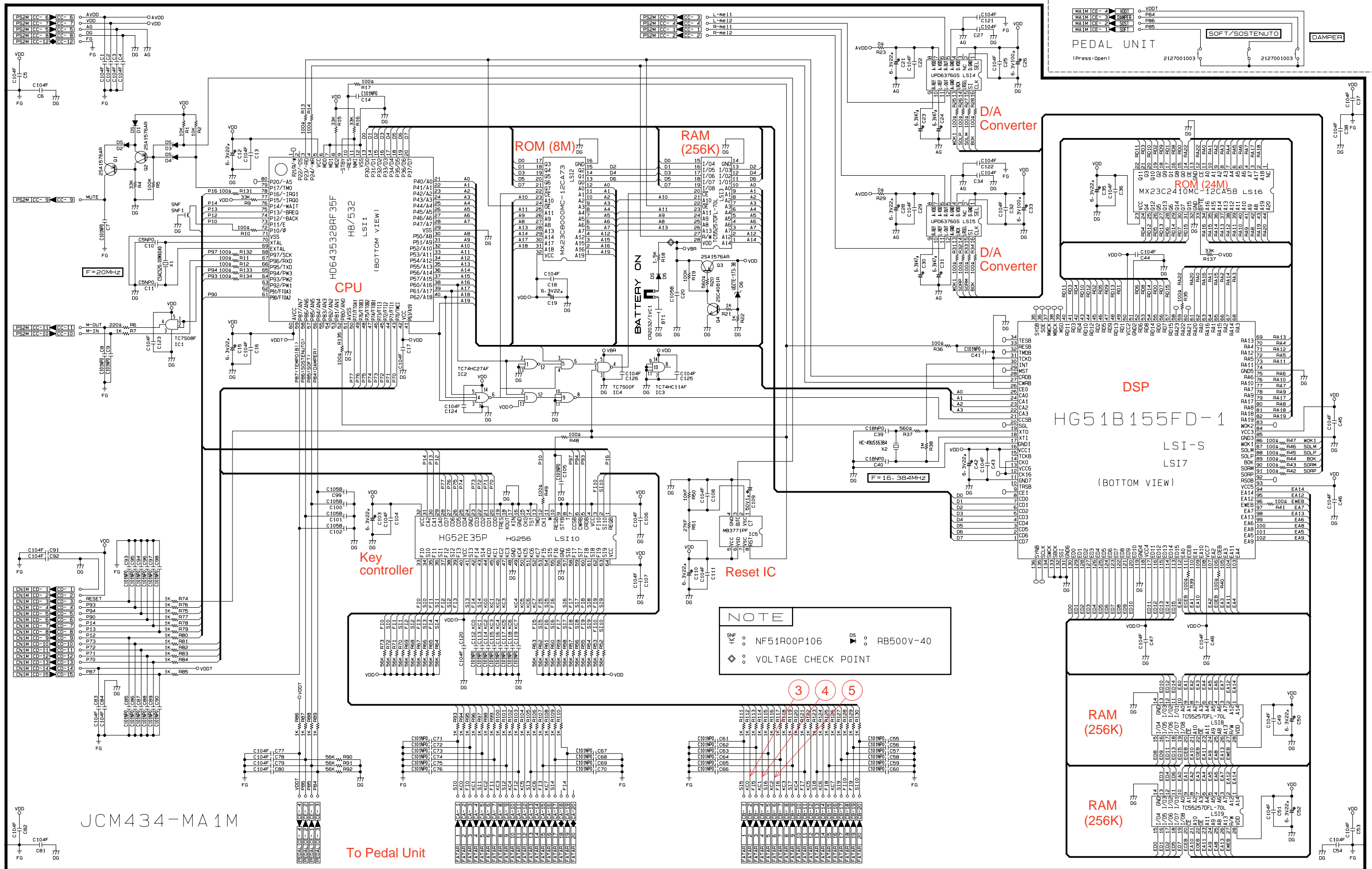

JCM434-MA1M

I/O PCBs JCM434-PS2M, Phone Jack PCBs JCM434-PS3M, LED PCBs JCM 434-PS4M, Power PCBs JCM 434-PS11

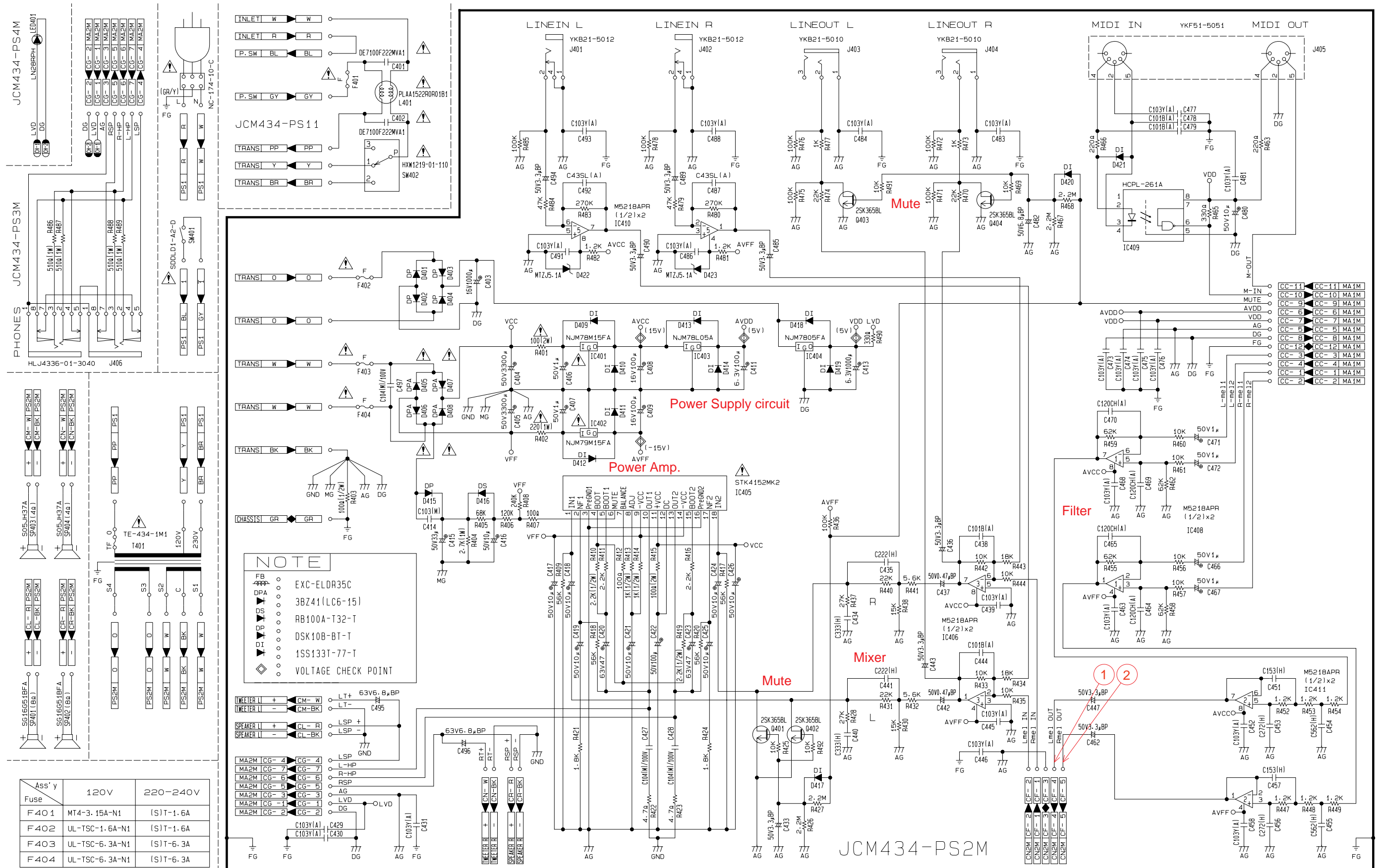

Console PCBs JCM434-CN1M

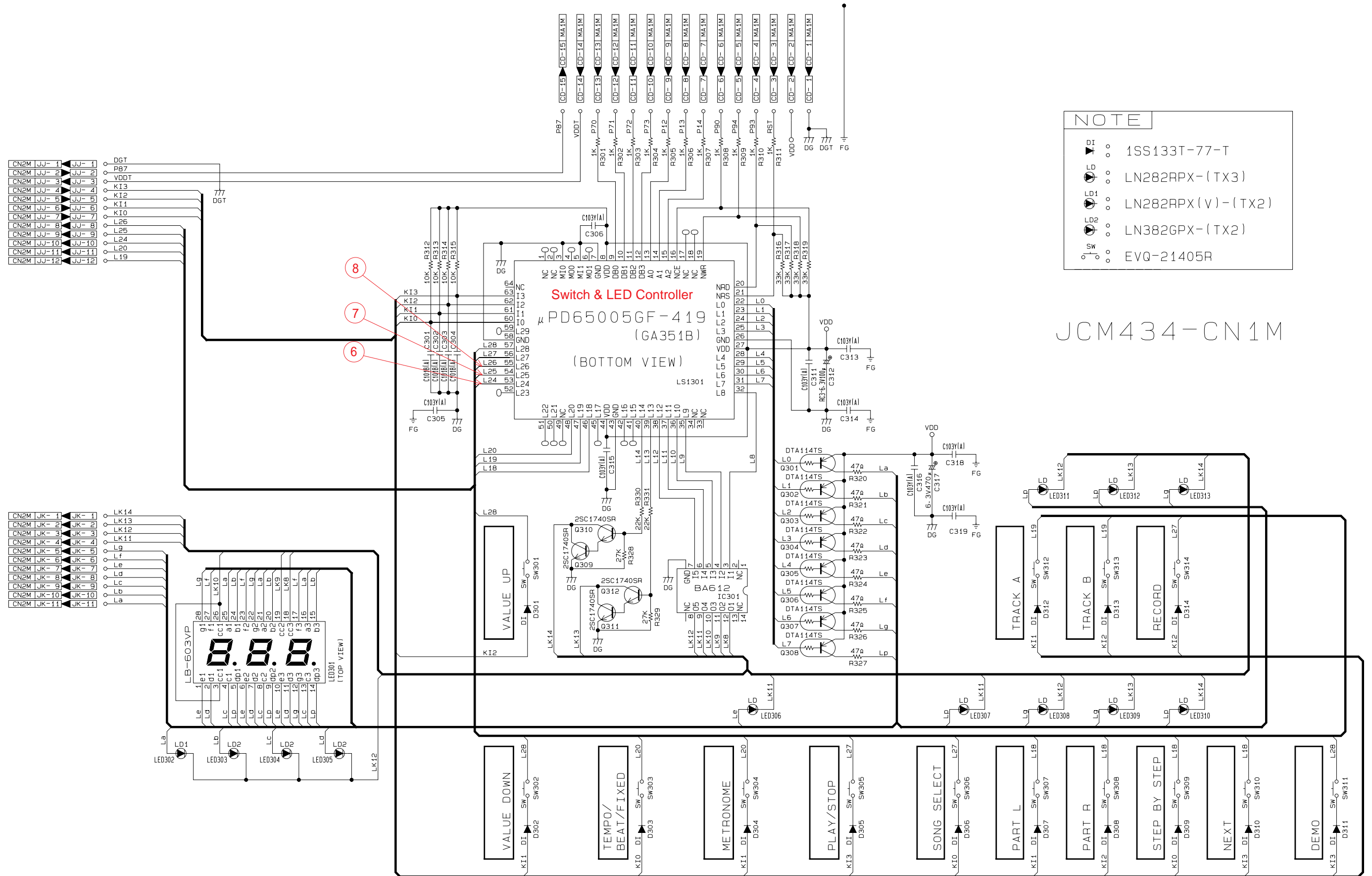

Console PCBs JCM434-CN2M

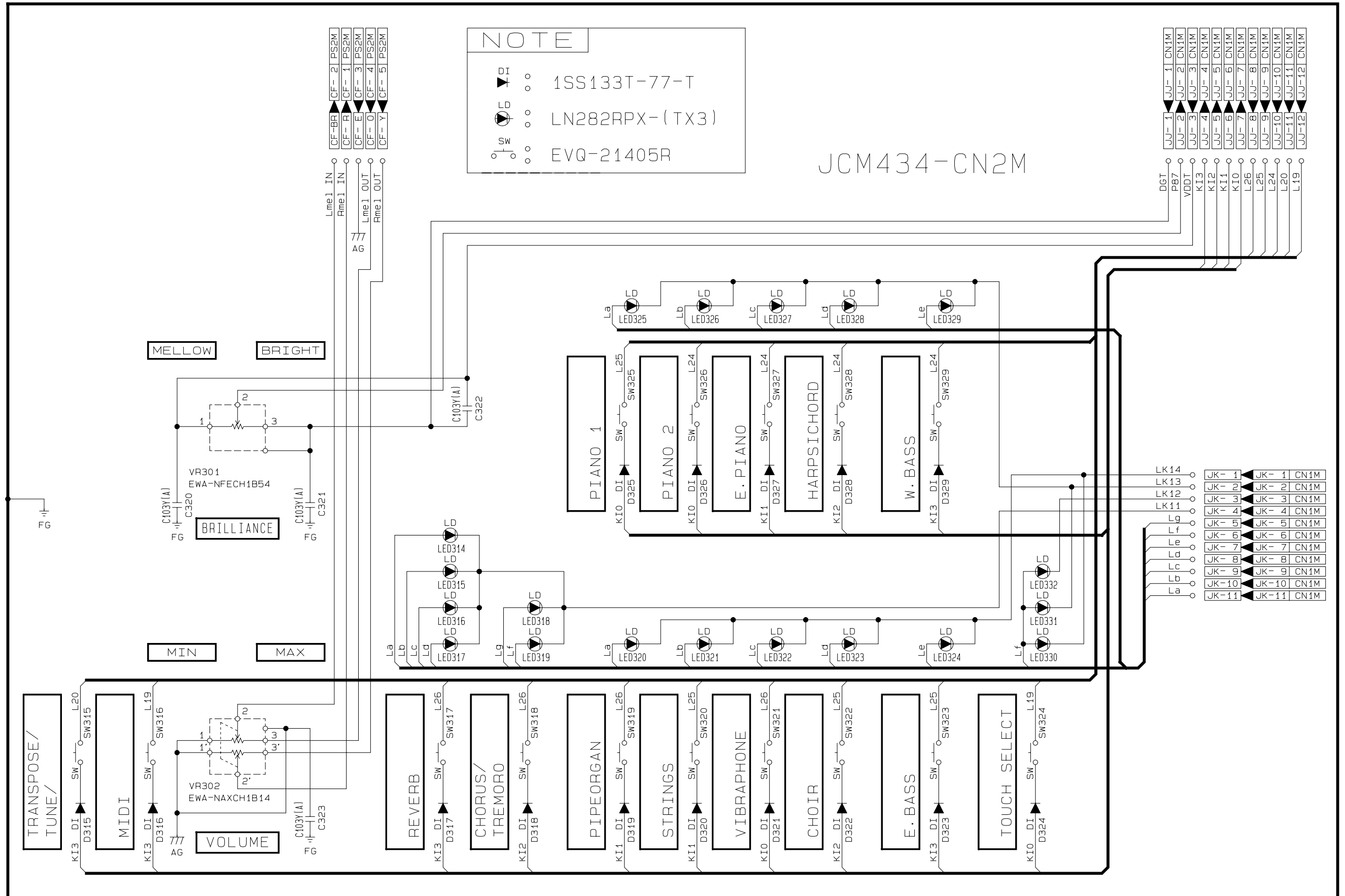

NOTE

- DI 1SS133T-77-T
- LED LN282RPX-(TX3)
- SW EVQ-21405R

JCM434-CN2M

Keyboard PCB TP20 KY-1

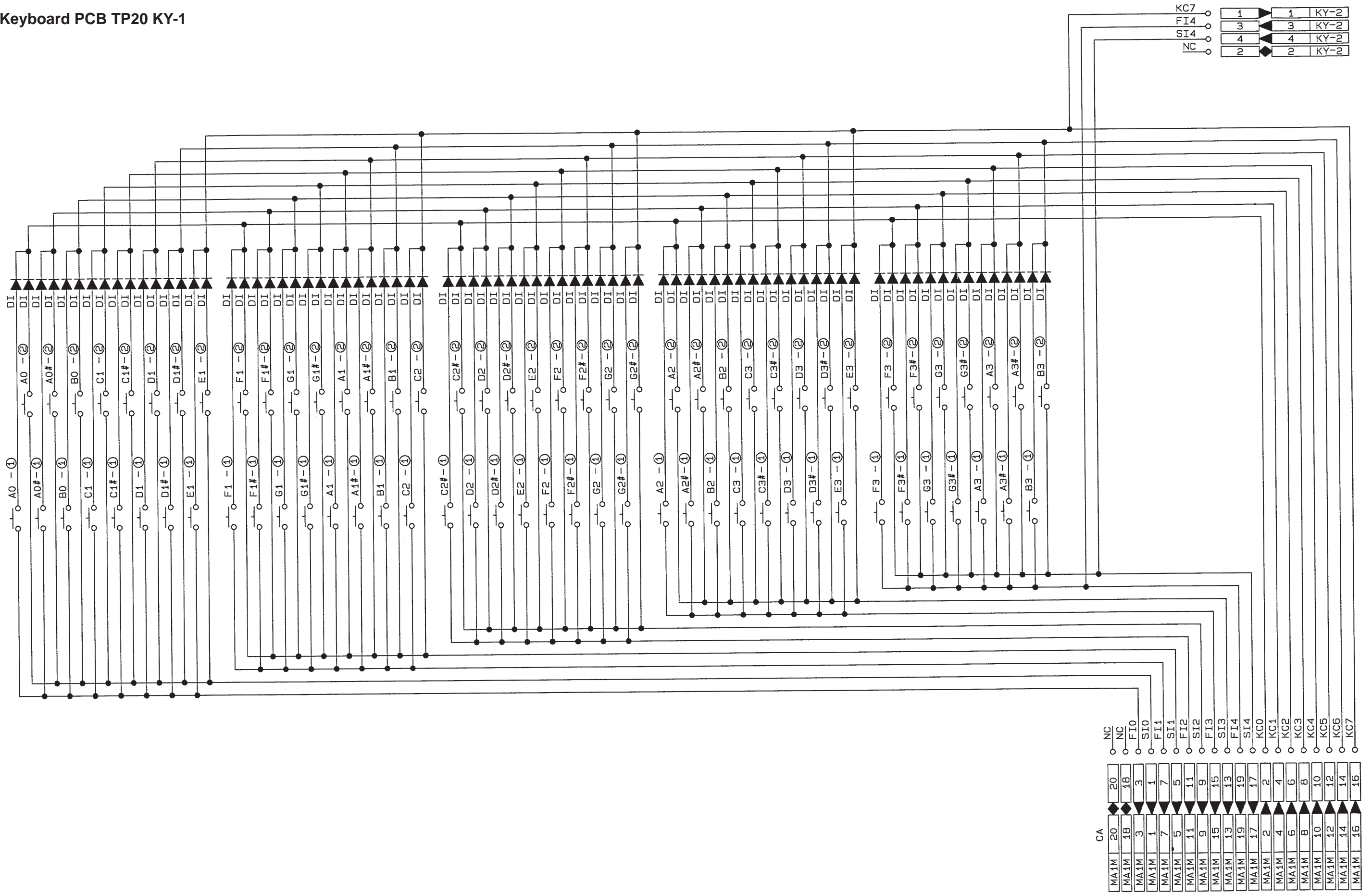

Keyboard PCB TP20 KY-2

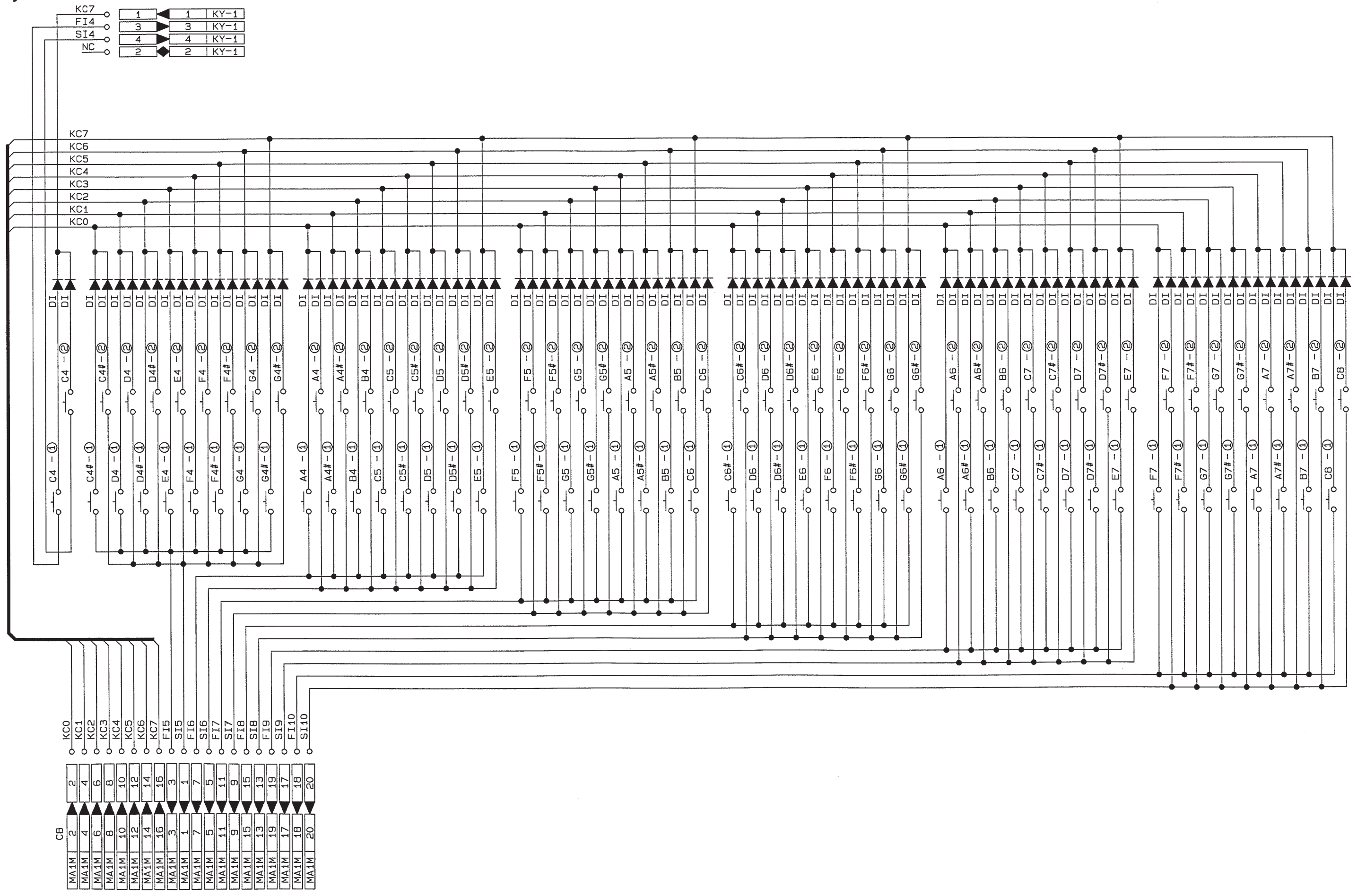

CASIO TECHNO CO.,LTD.
Overseas Service Division

8-11-10, Nishi-Shinjuku
Shinjuku-ku, Tokyo 160-0023, Japan