

CASIO®

Service Manual

(without price)

CTK-401

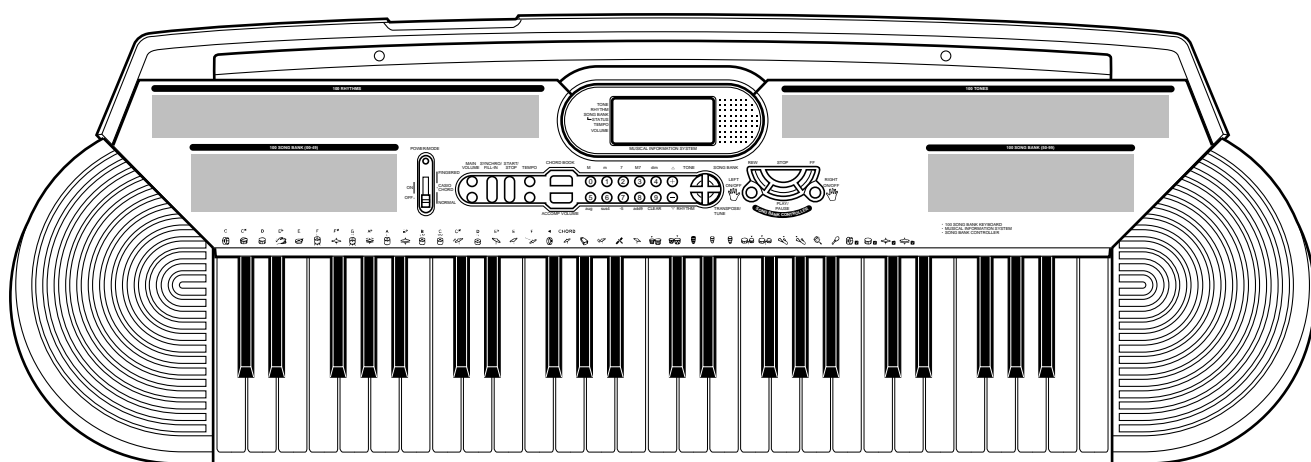

CTK-401

INDEX

ELECTRONIC KEYBOARD

CONTENTS

Specifications	1
Block Diagram	2
Circuit Description	3
Adjustment	7
Major Waveforms	8
Printed Circuit Boards	9
Schematic Diagrams	11
Exploded View	15
Parts List	17

SPECIFICATIONS

GENERAL

Keyboard:	49 standard-size keys, 4 octaves
Tones:	100
Polyphony:	12 notes maximum (6 for certain tones)
Auto accompaniment	
Rhythm patterns:	100
Tempo:	Variable (236 steps, ♩ = 20 to 255)
Chords:	2 fingering methods (CASIO CHORD, FINGERED)
Rhythm controller:	START/STOP, SYNCHRO/FILL-IN
Accomp volume:	0 to 9 (10 steps)
Song bank	
Tunes:	100
Controllers:	PLAY/PAUSE, STOP, REW, FF, LEFT ON/OFF, RIGHT ON/OFF
Musical dictionary	
Name display:	TONE, RHYTHM, SONG BANK name/number
Tempo:	Tempo value, metronome, synchro standby, beat indicator
Chord:	Chord name, Chord form
Fingering:	Fingering indicators, parts
Song bank status:	PLAY, PAUSE, REW, FF, playing
Staff:	Four octaves with sharp and flat indications
Keyboard:	Four octaves
Other functions	
Transpose:	12 steps (-6 semitones to +5 semitones)
Tuning:	Variable (A4 = approximately 440 Hz ± 50 cents)
Volume:	0 to 9 (10 steps)
Terminals	
Phones/Output terminal:	Stereo standard jack Output Impedance: 100 Ω Output Voltage: 3.0 V (RMS) MAX
Power supply terminal:	9 V DC
Power supply	Dual power supply system
Batteries:	Six AA-size batteries
Battery life:	Approximately 2 hours (SUM-3/R6P)/6 hours (AM3/LR6)
AC adaptor:	AD-5
Auto power off:	Turns power off approximately six minutes after last key operation. Enabled under battery power only, can be disabled manually.
Speaker output:	2.0 W + 2.0 W
Power consumption:	9 V ≡ 7.0 W
Dimensions (HWD):	988 × 332 × 124 mm (38-15/16 × 13-1/16 × 4-7/8 inches)
Weight:	Approximately 3.5 kg (7.7 lbs) (without batteries)

ELECTRICAL

Current drain with 9 V DC:	
No sound output	100 mA ± 20 %
Maximum volume	625 mA ± 20 %
with 12 keys C4 to B4 pressed in Synth-Lead 1	
Volume: 9 (Max.)	
Phone output level (V _{rms} with 8 Ω load each channel):	
with key A4 pressed in Synth-Lead 1	67 mV ± 20 %
Speaker output level (V _{rms} with 4 Ω load each channel):	
with key A4 pressed in Synth-Lead 1	900 mV ± 20 %
Minimum operating voltage:	5.7 V

BLOCK DIAGRAM

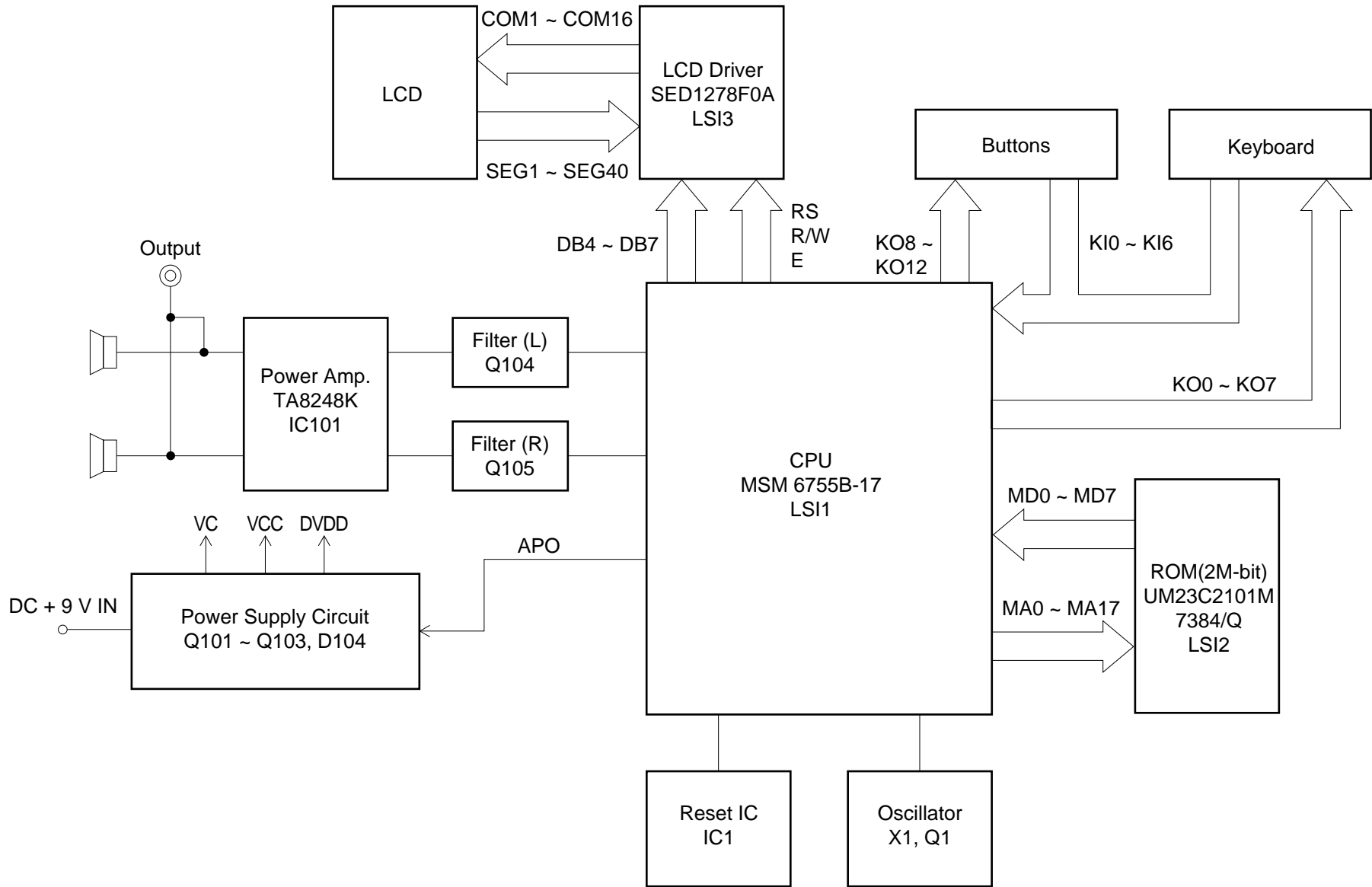

CIRCUIT DESCRIPTION

KEY MATRIX

	KI0	KI1	KI2	KI3	KI4	KI5	KI6
KO0	C2	G#2	E3	C4	G#4	E5	C6
KO1	C#2	A2	F3	C#4	A4	F5	
KO2	D2	A#2	F#3	D4	A#4	F#5	
KO3	D#2	B2	G3	D#4	B4	G5	
KO4	E2	C3	G#3	E4	C5	G#5	
KO5	F2	C#3	A3	F4	C#5	A5	
KO6	F#2	D3	A#3	F#4	D5	A#5	
KO7	G2	D#3	B3	G4	D#5	B5	
KO8	—	+	0	Tempo Down	Tempo Up	Volume Down	Volume Up
KO9	3	2	1	Start/ Stop	Synchro/ Fill-in	Chord Book	Accomp Volume
KO10	6	5	4	Transpose/ Tune	Song Bank	Rhythm	Tone
KO11	9	8	7	Fingered	CASIO Chord	Normal	Power Off
KO12	FF	Right	Play/ Pause	Stop	Left	Rewind	

NOMENCLATURE OF KEYS

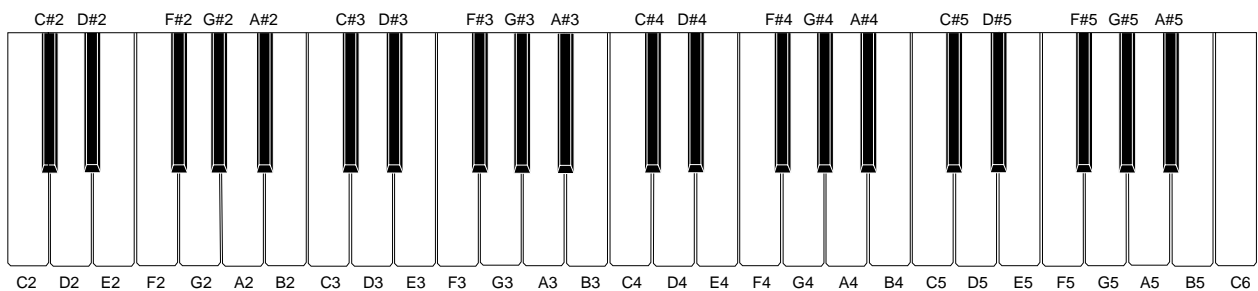

CPU (LSI1: MSM6755B-17)

The CPU reads sound data from the ROM in accordance with the pressed key and the selected tone; the CPU can read rhythm data simultaneously when a rhythm pattern is selected. Then it provides the left and the right channels' waveforms separately, by converting the data into the waveforms with two built-in DACs. The CPU also controls key and button input. The following table shows the pin functions of LSI1.

Pin No.	Terminal	In/Out	Function
1	MA14	Out	Address bus
2, 3	NCO	—	Not used
4 ~ 19	MA0 ~ MA13	Out	Address bus
13	MRDB	Out	Read enable signal
17	MCSB	—	Not used
20 ~ 27	MD0 ~ MD7	In/Out	Data bus
28, 29	NC1, NC2	—	Not used
30	DGND	In	Ground (0 V) source
31	DVCC	In	+5 V source
32, 33	XTLO, XTLI	In/Out	20 MHz clock input/output
34	NC3	—	Not used
35	RSTB	In	Reset signal input
36	P24/RXD	—	Not used. Connected to +5 V.
37	P25/TXD	—	Not used
38	NMI	In	Power ON signal input. Connected to +5 V.
39	APO	Out	APO (Auto Power Off) signal output
40	NC4	—	Not used
41	REFH	Out	Terminal for the internal DAC
42, 43	NC5, NC6	—	Not used
44	DAOR	Out	Right channel sound waveform output
45	NC7	—	Not used
46	AVdac	In	+5 V source for the internal DAC
47	DAOL	Out	Left channel sound waveform output
48	REFL	Out	Terminal for the internal DAC and ADC
49	AGdac	In	Ground source for internal DAC
50	AGadc	In	Ground source for internal ADC
51	ANI	In	APO cancellation signal
52	AVadc	In	+5 V source for the internal ADC
53	NC8	—	Not used
54	MOD0	In	Mode selection terminal. Connected to +5 V.
55, 56	MOD1, MOD2	In	Mode selection terminal. Connected to ground.
57	P40	—	Not used
58 ~ 64	KI0/P30 ~ KI7/P36	In	Terminals for key/button input signal
65	KI7/P37	—	Not used
66 ~ 73	KO0/P50 ~ KO7/P57	Out	Terminals for key scan signal

Pin No.	Terminal	In/Out	Function
74 ~ 77	DB4 ~ DB7	Out	Data bus for the LCD driver
78	NC9	—	Not used
79	LVCC	In	+5 V source
80 ~ 84	KO8 ~ KO12	Out	Terminals for button scan signal
85 ~ 87	P65 ~ P67	—	Not used
88	RS	Out	Control signal for the LCD driver
89	R/W	Out	Read/Write signal for the LCD driver
90	E	Out	Chip enable signal for the LCD driver
91 ~ 95	P73 ~ P77	—	Not used
96	LGND	In	Ground source
97, 100	MA18, MA15	Out	Address bus

LCD DRIVER (LSI3: SED1278F0A)

The LCD driver can drive a dot matrix LCD having 40 segment and 16 common lines. The LSI contains 240 graphic symbols in the built-in character generator ROM, and stores 80 characters in the built-in display data RAM. In accordance with command from the CPU, the LSI is capable of displaying up to 16 characters simultaneously. The following table shows the pin functions of LSI3.

Pin No.	Terminal	In/Out	Function
1 ~ 22, 63 ~ 80	SEG1 ~ SEG40	Out	Segment signal output
23	VSS	—	GND (0 V) source
24, 25	OSC1, OSC2	In/Out	Terminals for the built-in clock pulse generator. The external resistor connected determines the oscillation frequency.
26 ~ 30	V1 ~ V5	In	LCD drive voltage input. Those voltages are used for generating the stepped pulse of the LCD drive signals.
31, 32	LP, XCLS	—	Not used
33	VDD	In	DVDD (+5 V) source
34, 35	FR, DO	—	Not used
36	RS	In	Data/command determination terminal. High: data, Low: command
37	R/W	In	Read/Write terminal. High: read, Low: write
38	E	In	Chip enable signal. High: enable, the writing is done at fall edge. Low: disenable
39 ~ 42	DB0 ~ DB3	—	Not used. Connected to GND (0 V)
43 ~ 46	DB4 ~ DB7	In/Out	Data bus
47 ~ 62	COM1 ~ COM16	Out	Common signal/output

FILTER BLOCK

Since the sound signals from the CPU is stepped waveforms, the filter block is added to smooth the waveforms.

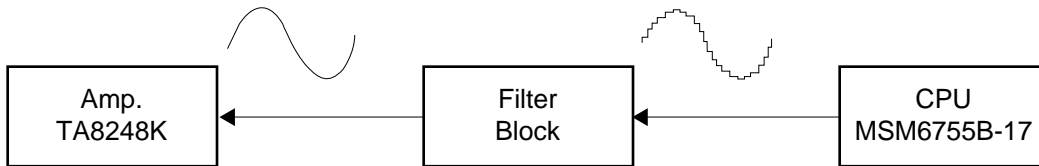

POWER AMPLIFIER (IC101: TA8248K)

The power amplifier is a two-channel amplifier with standby switch.

The following table shows the pin function of IC101.

Pin No.	Terminal	In/Out	Function
1	NC	—	Not used
2	B.S.2	—	Terminal for a bootstrap capacitor
3	OUT2	Out	Channel 2 output
4	VCC	In	+9 V source
5	OUT1	Out	Channel 1 output
6	B.S.1	—	Terminal for a bootstrap capacitor
7	Power GND	In	Ground (0 V) source
8	Stand by	In	Power control signal input. 0 V: Off, +9 V: On
9	DC	—	Terminal for a decoupling capacitor
10	NF1	In	Negative feedback input
11	IN1	In	Channel 1 input
12	IN2	In	Channel 2 input
13	NF2	In	Negative feedback input
14, 15	Pre GND	In	Ground (0 V) source

ADJUSTMENT

MAIN PCB

- 1) Items to be adjusted:

Item	Measuring Instrument
Vop voltage setting	Voltmeter

- 2) Adjustment and Test Point Locations

(TOP VIEW)

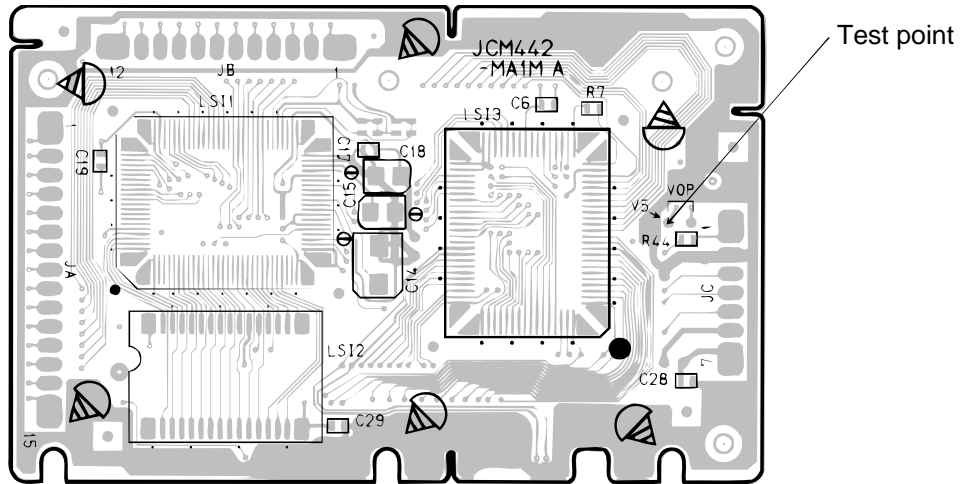

- 3) Equipment connection/Procedure

Vop voltage setting						
Input Connection	Input Point	Input Signal	Adjust	Output Connection	Output Point	Adjust for
—	—	—	VR1	Voltmeter	V5	Adjust for 4.3 ± 0.1 V reading on voltmeter. Make fine adjustment according to the next instruction.
<p>Watching the LCD at a 53.5° angle to the horizontal, adjust Vop voltage so that unenergized segments are seen dimly.</p>						

MAJOR WAVEFORMS

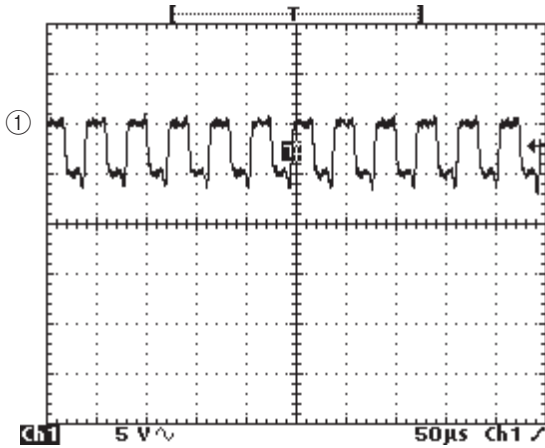

① Clock pulse
MSM6755B-17 pin 32

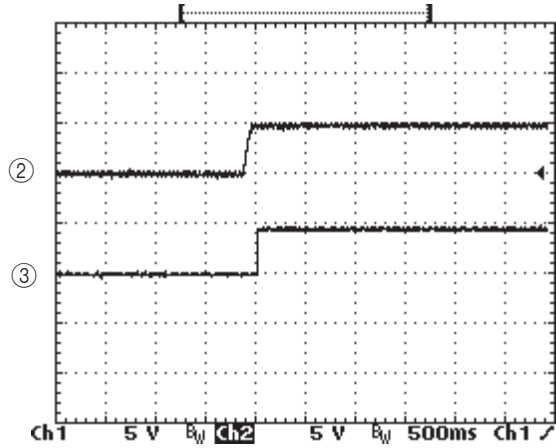

② +5 V source DVDD
JC connector pin 6
③ APO signal
JC connector pin 5

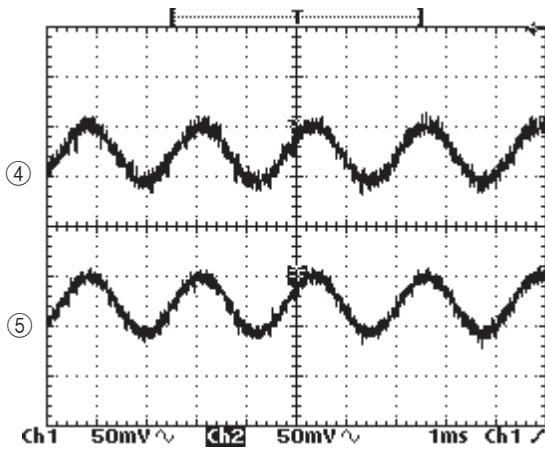

④ Sound waveform (R-ch) Tone: Whistle
JC connector pin 4 Key: A4
⑤ Sound waveform (L-ch) Volume:
JC connector pin 3

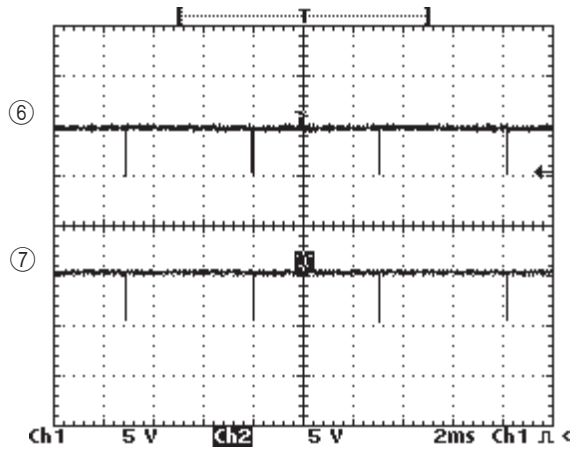

⑥ Button scan signal KO6
JA connector pin 14
⑦ Button scan signal KO7
JA connector pin 15

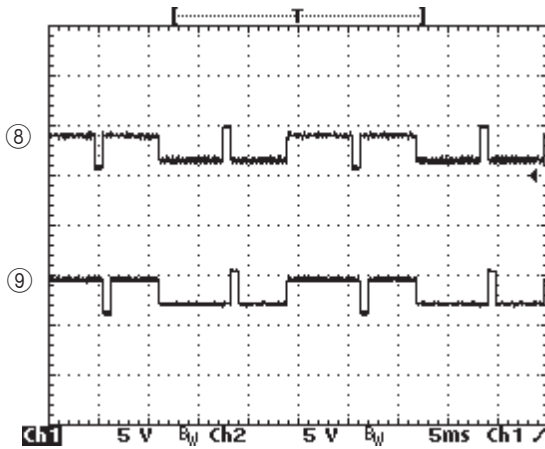

⑧ LCD common signal COM9
SED1278F0A pin 55
⑨ LCD common signal COM10
SED1278F0A pin 56

PRINTED CIRCUIT BOARDS

Main PCB JCM442-MA1M

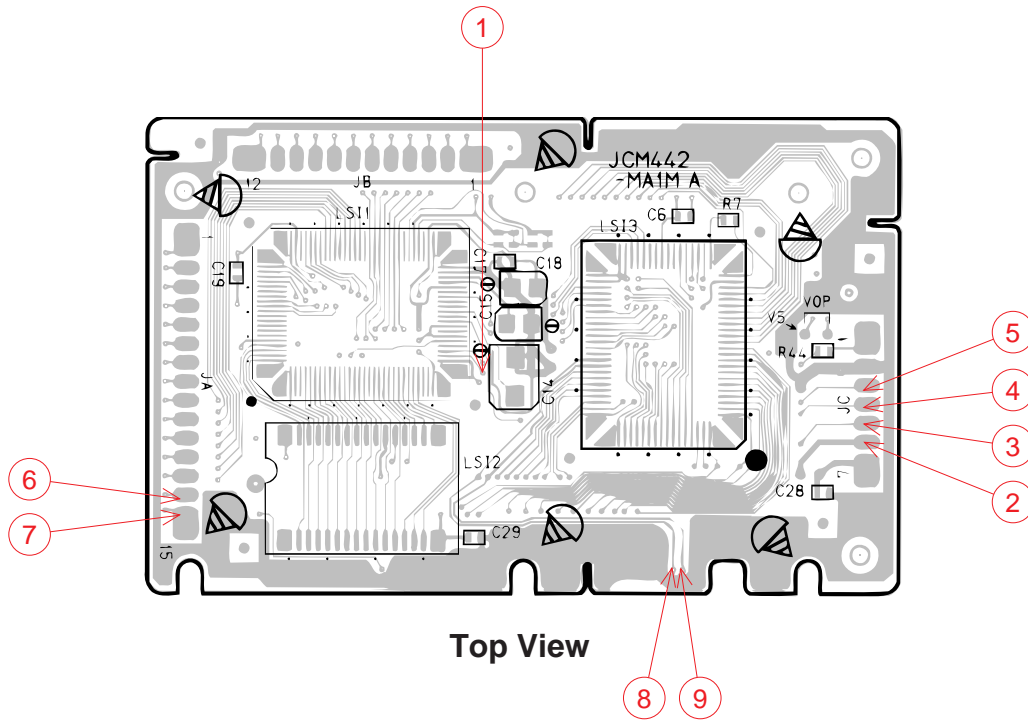

Top View

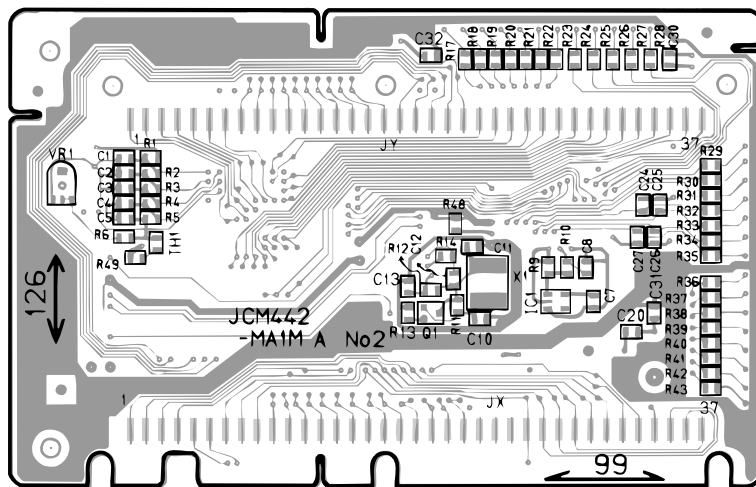

Bottom View

SCHEMATIC DIAGRAMS

Main PCB JCM442-MA1M

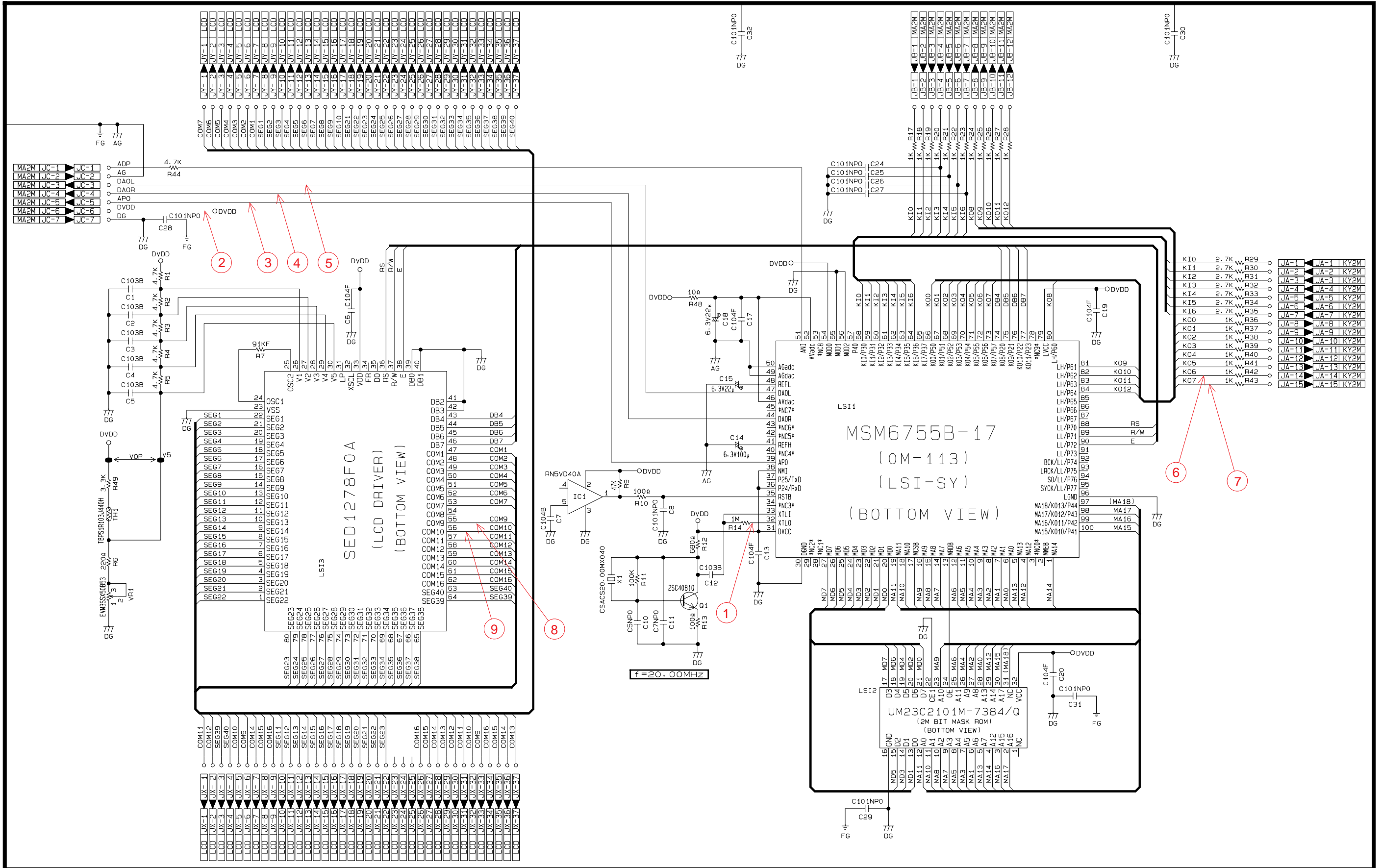

Sub PCB JCM442-MA2M

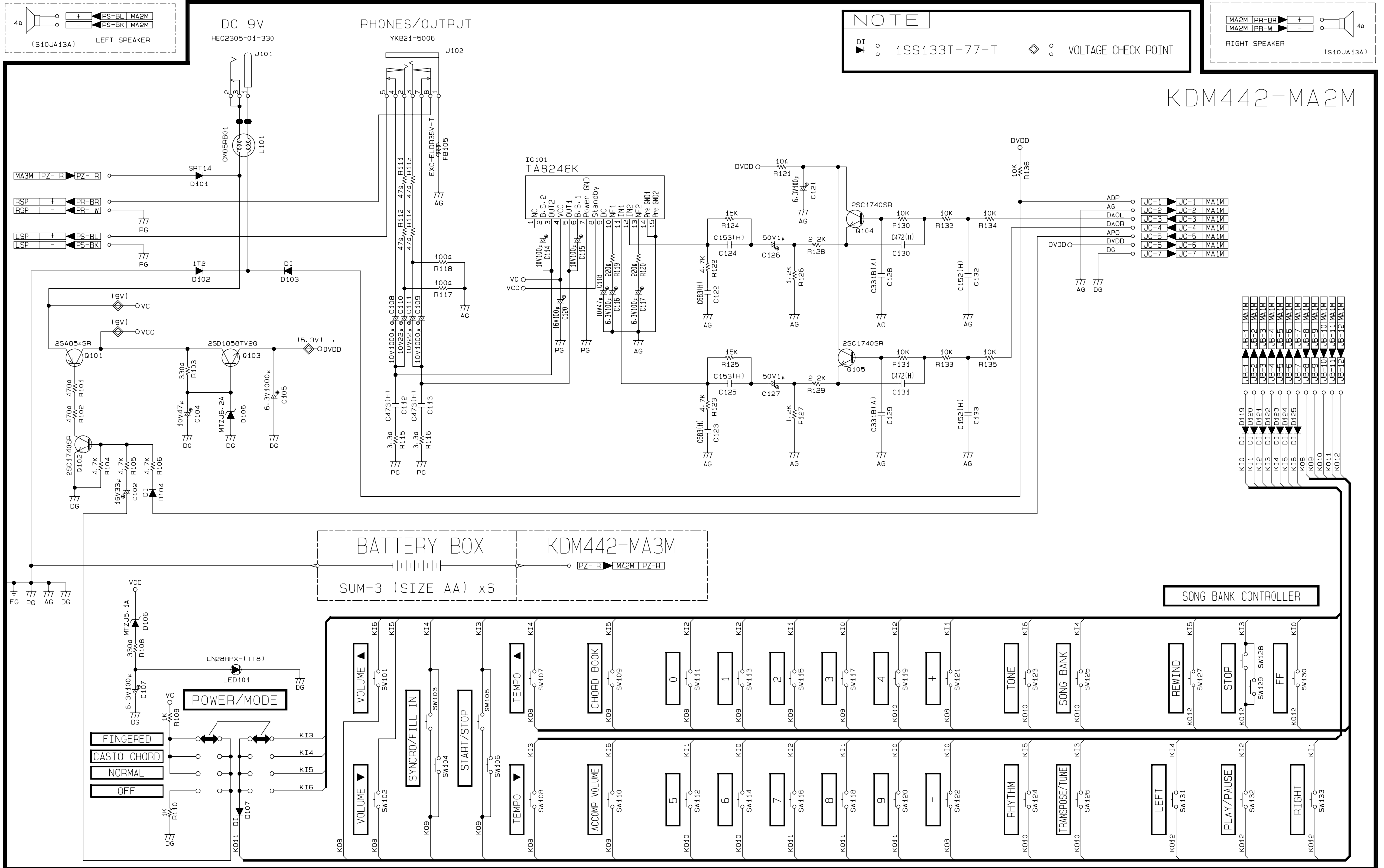

Keyboard PCBs KDM4910K-KY1M/KY2M

KDM4910K-KY1M

DI
 ▲ 1S2473T-77-T

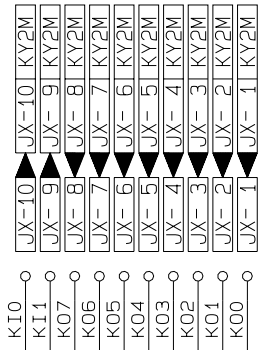
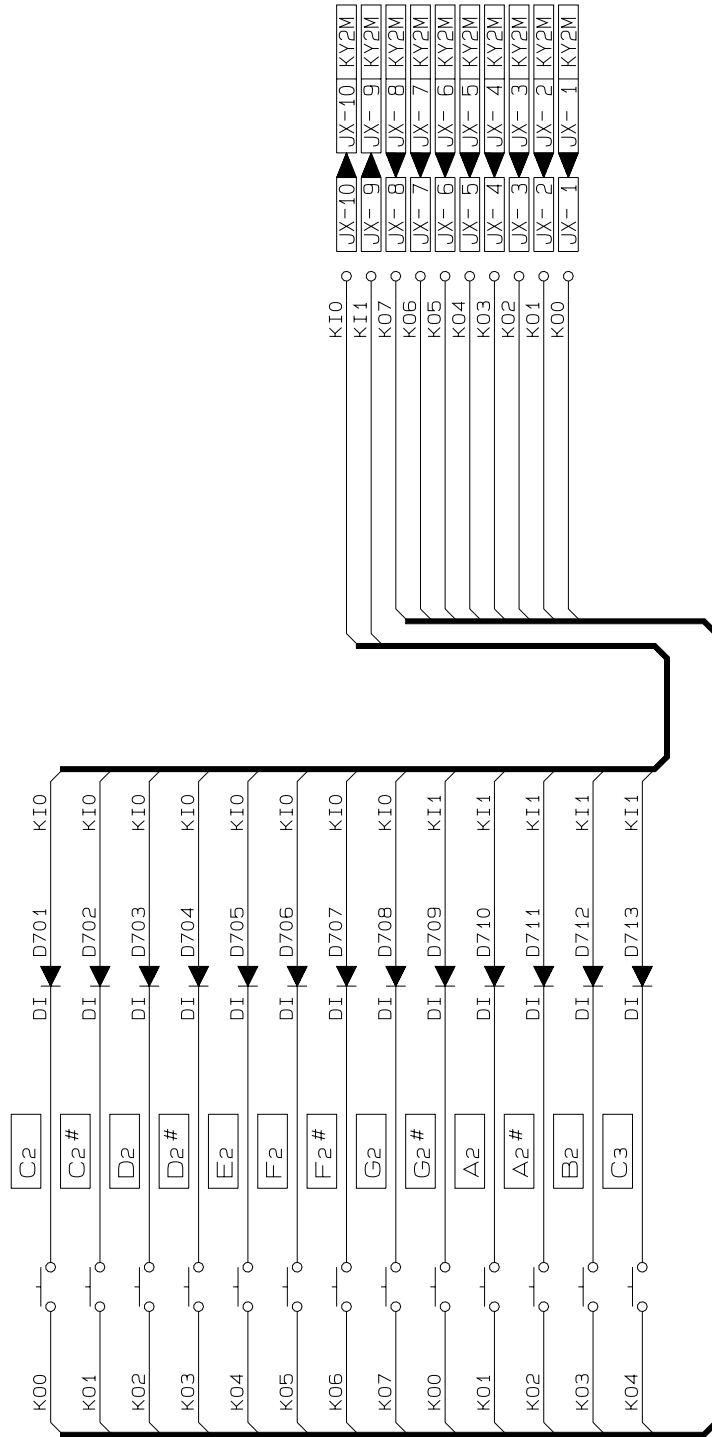

KDM4910K-KY2M

DI
 ▲ 1S2473T-77-T

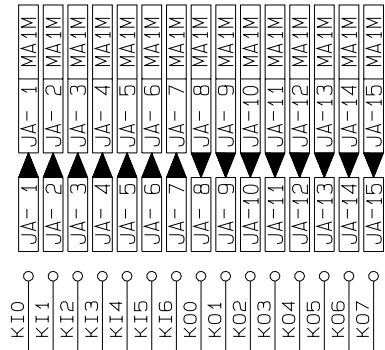
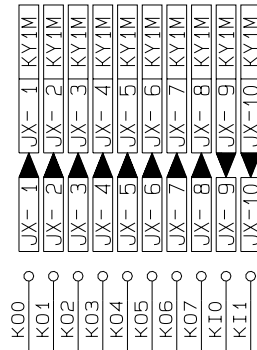
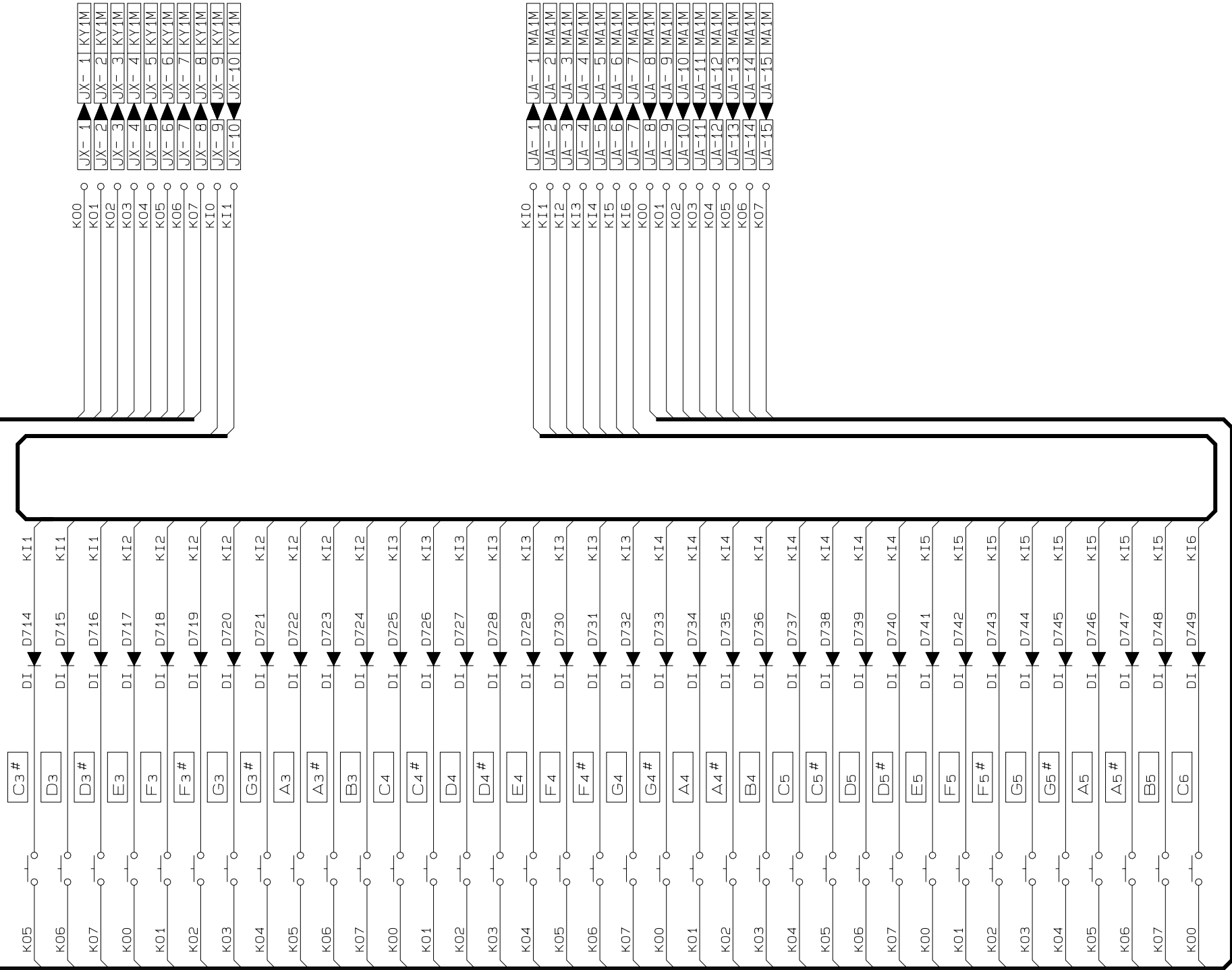

LCD

Common

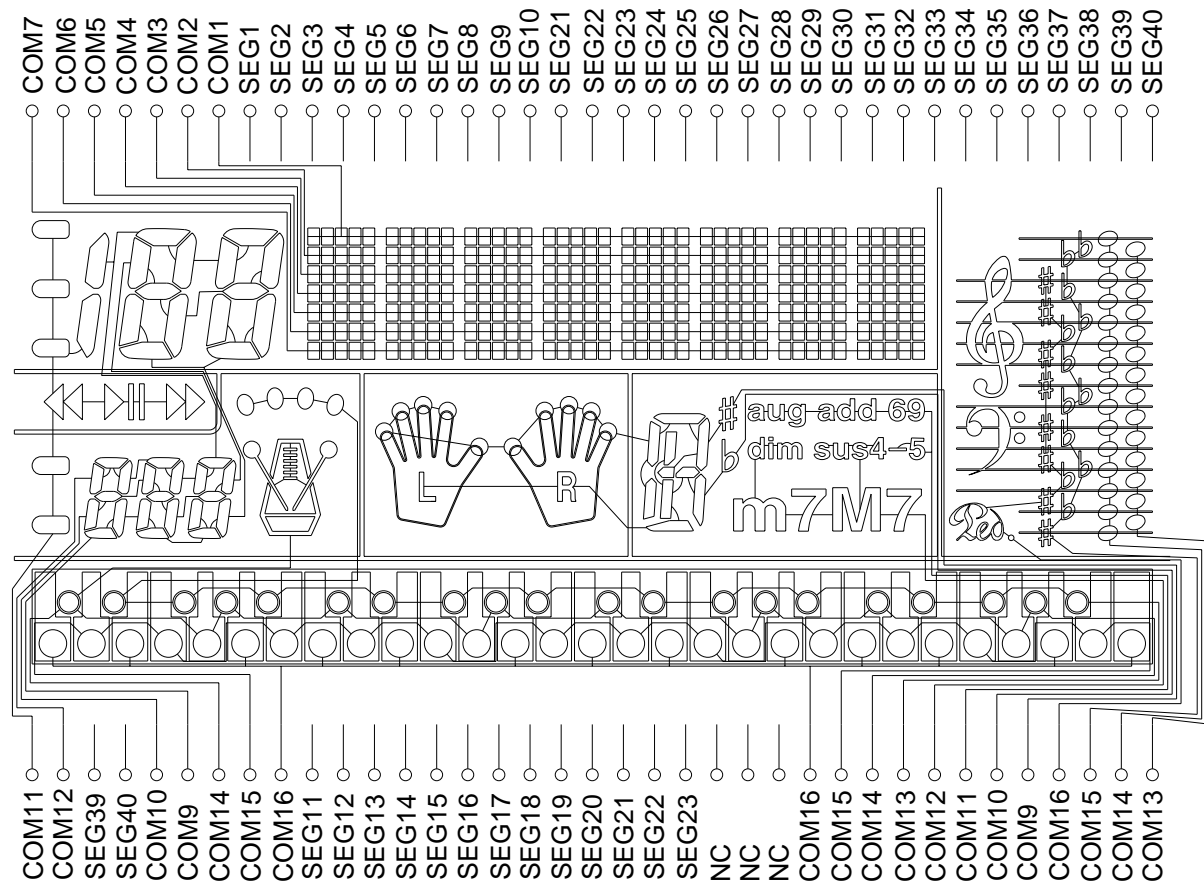

Segment

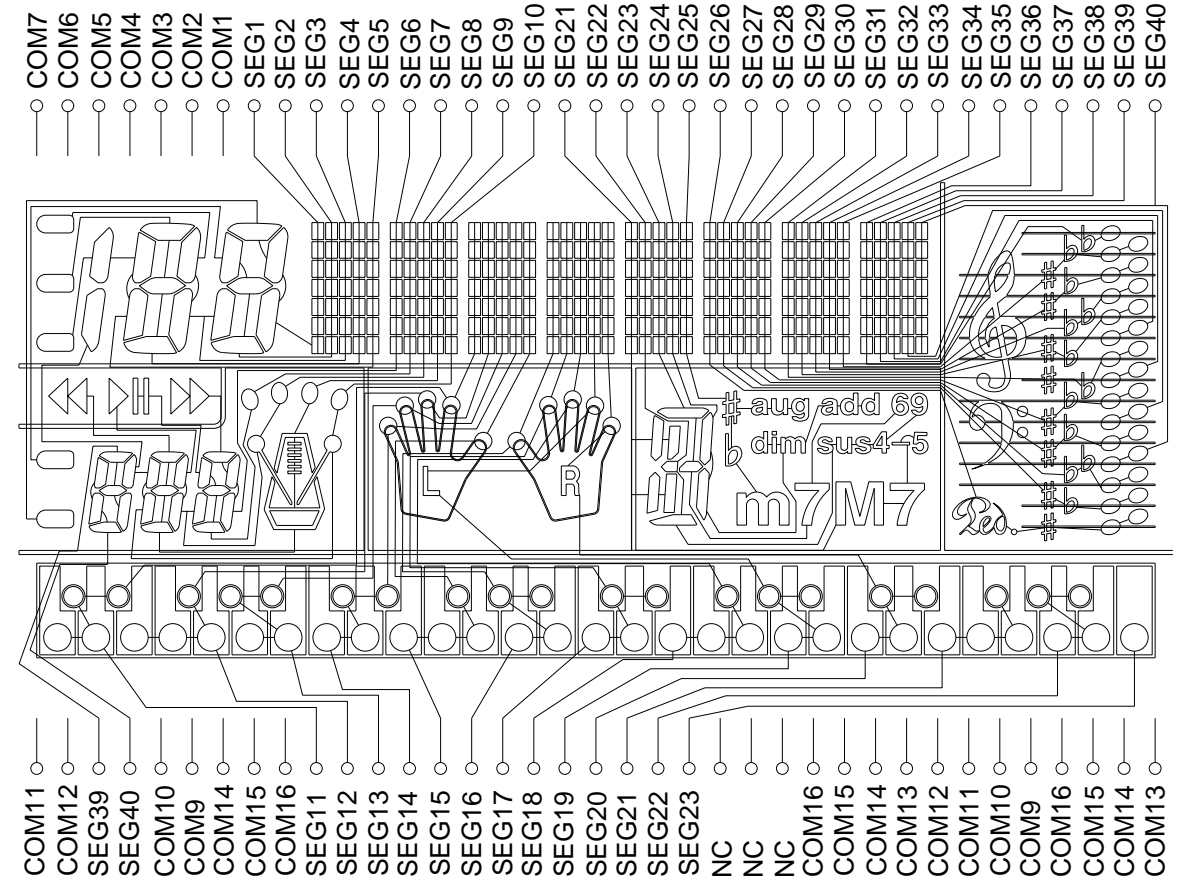

EXPLODED VIEW

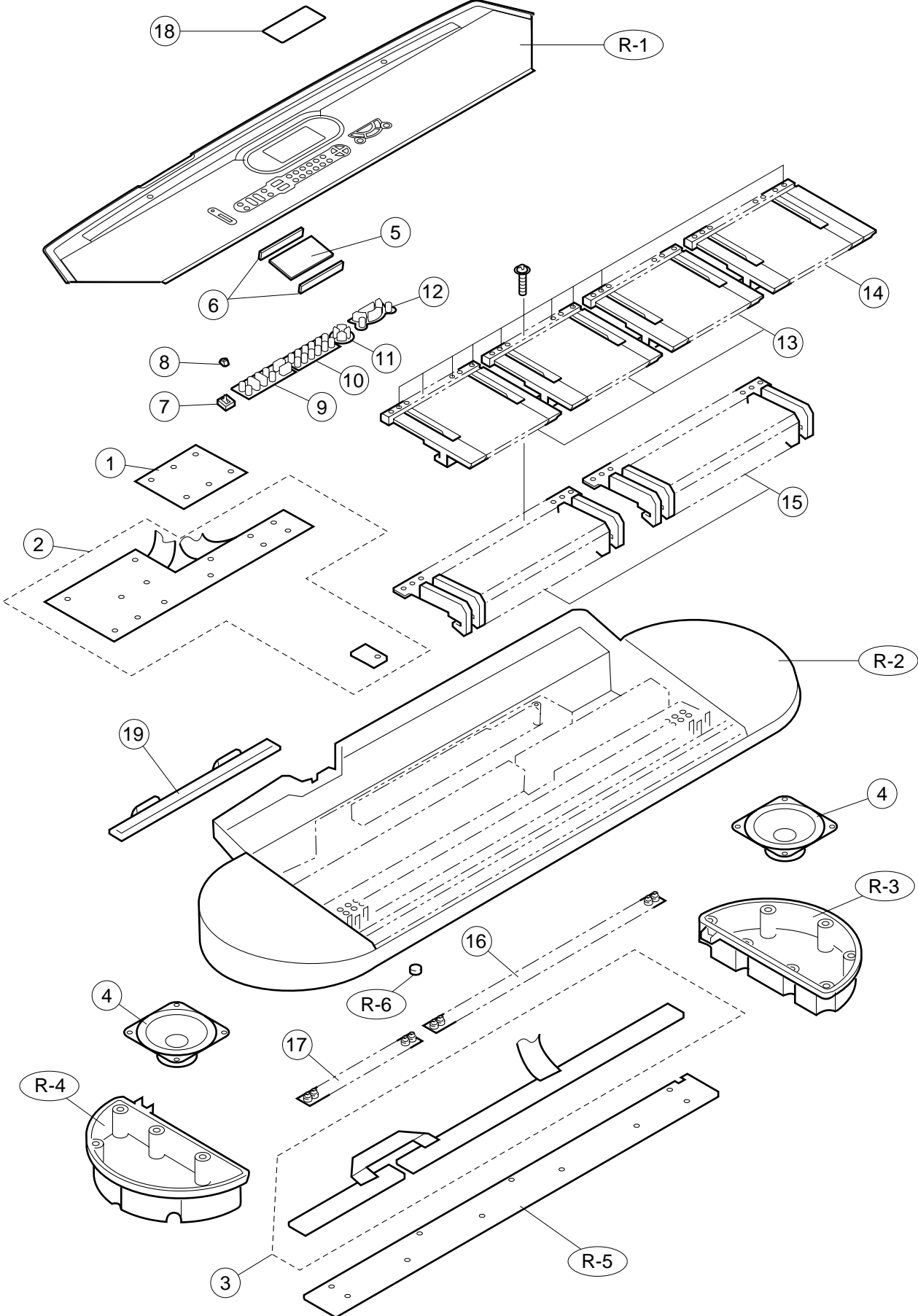

PARTS LIST

CTK-401

Notes: This parts list does not include the cosmetic parts, which parts are marked with item No. "R-X" in the exploded view.

Contact our spare parts department if you need these parts for refurbish.

1. Prices and specifications are subject to change without prior notice.
2. As for spare parts order and supply, refer to the "GUIDEBOOK for Spare parts Supply", published separately.
3. The numbers in item column correspond to the same numbers in drawing.

Item	Code No.	Parts Name	Specification	Q	R
Main PCB					
1	6926 0200	PCB/ASS'Y (MA1M)	M240592*1	1	B
LSI1	2012 5603	LSI/MC (CPU)	MSM6755B-17	1	A
LSI2	2012 5611	LSI/MASK-ROM	UM23C2101M-7384/Q	1	A
LSI3	2012 5569	LSI/LCD DRIVER	SED1278F0A	1	A
IC1	2012 1883	IC/MOS (RESET IC)	RN5VD40AA-TR	1	B
Q1	2252 1239	TRANSISTOR	2SC4081T106Q	1	B
VR1	2775 3286	POTENTIOMETER	EVM3SSX50B53	1	B
X1	2590 2100	OSCILLATOR/CERAMIC	CSACS20.00MX040-TC	1	B
Sub PCB					
2	6926 0190	PCB/ASS'Y (MA2, 3M)	M140548*1	1	B
IC101	2114 5775	IC/LINEAR (POWER AMP.)	TA8248K	1	A
Q101	2250 0168	TRANSISTOR	2SA854SR-TP-T	1	A
Q102, Q104/105	2220 1409	TRANSISTOR	2SC1740SR-TP-T	3	A
Q103	2250 1585	TRANSISTOR	2SD1858TV2Q	1	A
D101	2390 1323	DIODE/SHOTTKY	RB100A-T32-T	1	C
D102	2390 3018	DIODE	1T2	1	C
D103	2390 1344	DIODE	1SS133T-77-T	11	C
D104	2360 2044	DIODE/ZENER	MTZJ6.2A-T77-T	1	A
D105	2360 1799	DIODE/ZENER	MTZJ5.1A-T77-T	1	A
LED101	2370 0112	LED	LN28RPX-(TT8)	1	C
J101	3501 7049	JACK (POWER)	HEC2305-01-330	1	B
J102	3612 0665	JACK (PHONE)	YKB21-5006	1	B
Keyboard PCBs					
3	6926 0180	PCB/ASS'Y	M140449*3	1	C
D701 - D749	2301 0101	DIODE	1S2473T-77-T	49	B
Mechanical Parts					
4	3831 0770	SPEAKER	S10JA13A	1	B
5	3335 6556	LCD	LD-B10023A	1	B
6	6926 0270	RUBBER/INTERCONNECTOR	M440435-2	2	C
7	6909 5890	SWITCH/SLIDE KONB	CSB-12D	1	B
8	6921 5031	KNOB	M311859-1	1	B
9	6926 0280	RUBBER/BUTTON	M240587-1	1	B
10	6926 0290	RUBBER/BUTTON	M240588-1	1	B
11	6926 0300	RUBBER/BUTTON	M240589-1	1	B
12	6926 0310	RUBBER/BUTTON	M240590-1	1	B
13	6922 2720	KEY SET/LT WHITE	M312118*1	3	A
14	6922 2730	KEY SET/LT WHITE	M312118*2	1	A
15	6922 2740	KEY SET/LT BLACK 10P	M111726-1	2	A
16	6922 4000	RUBBER/CONTACT	M111765-1	1	A
17	6923 2390	RUBBER/CONTACT	M240025-1	1	A
18	6926 0320	PANEL/DISPLAY	M340608-1	1	C
19	6926 0020	COVER/BATTERY	M340528*2	1	B
Accessory					
	6906 8752	STAND/NOTE	M340629B*2	1	B

Notes: Q – Quantity per unit
R – Rank

CASIO COMPUTER CO.,LTD.
Service Division

8-11-10, Nishi-Shinjuku
Shinjuku-ku, Tokyo 160, Japan
Telephone: 03-3347-4926