

**CASIO®**

# Service Manual

(without price)

## CTK-431

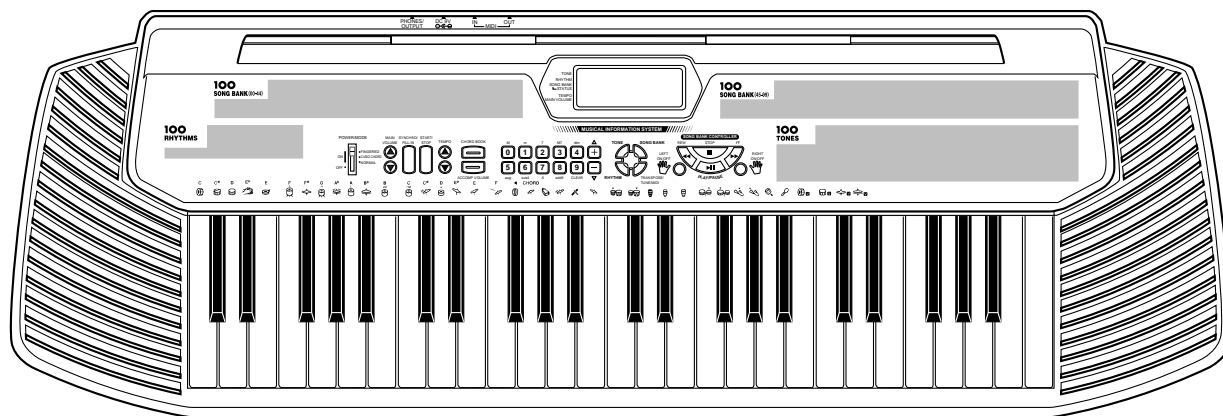

CTK-431

**ELECTRONIC KEYBOARD**

# CONTENTS

Specifications .....	1
Block Diagram .....	2
Circuit Description .....	3
Adjustment .....	7
Major Waveforms .....	8
Printed Circuit Boards .....	9
Schematic Diagrams .....	10
Exploded View .....	14
Parts List .....	15

# SPECIFICATIONS

## GENERAL

Keyboard:	49 standard-size keys, 4 octaves
Tones:	100
Polyphony:	12 notes maximum (6 for certain tones)
Auto accompaniment	
Rhythm patterns:	100
Tempo:	Variable (236 steps, $\text{♩} = 20$ to 255)
Chords:	2 fingering methods (CASIO CHORD, FINGERED)
Rhythm controller:	START/STOP, SYNCHRO/FILL-IN
Accomp volume:	0 to 9 (10 steps)
Song bank	
Tunes:	100
Controllers:	PLAY/PAUSE, STOP, REW, FF, LEFT ON/OFF, RIGHT ON/OFF
Musical dictionary	
Name display:	TONE, RHYTHM, SONG BANK name/number, keyboard settings name/value
Tempo:	Tempo value, metronome, synchro standby, beat indicator
Chord:	Chord name, Chord form
Fingering:	Fingering indicators, parts, pedal (The pedal indicator is for received MIDI data only.)
Song bank status:	PLAY, PAUSE, REW, FF
Staff:	4 octaves with sharp and flat indications
Keyboard:	4 octaves
MIDI:	5 multi-timbre receive
Other functions	
Transpose:	12 steps (−6 semitones to +5 semitones)
Tuning:	Variable (A4 = approximately 440 Hz $\pm$ 50 cents)
Volume:	0 to 9 (10 steps)
Terminals	
MIDI terminals:	IN, OUT
Phones/Output terminal:	Stereo standard jack (Output is monaural.) Output Impedance: 60 $\Omega$ Output Voltage: 5 V (RMS) MAX
Power supply terminal:	9 V DC
Power supply	Dual power supply system
Batteries:	6 AA-size batteries
Battery life:	Approximately 2 hours (SUM-3/R6P)/4 hours (AM3/LR6)
AC adaptor:	AD-5
Auto power off:	Turns power off approximately six minutes after last key operation. Can be disabled manually.
Speaker output:	3.0 W (Output is monaural.)
Power consumption:	9 V $\approx$ 7.5 W
Dimensions (HWD):	958 $\times$ 310 $\times$ 132 mm (37-3/4 $\times$ 12-3/16 $\times$ 5-3/16 inches)
Weight:	Approximately 3.5 kg (7.7 lbs) (without batteries)

## ELECTRICAL

Current drain with 9 V DC:	
No sound output	200 mA $\pm$ 20 %
Maximum volume	750 mA $\pm$ 20 %
with 12 keys C1 to B1 pressed in Synth-Lead 1	
Volume: 9 (Max.)	
Phone output level (V <sub>rms</sub> with 8 $\Omega$ load each channel):	
with key A4 pressed in Synth-Lead 1	95 mV $\pm$ 20 %
Speaker output level (V <sub>rms</sub> with 4 $\Omega$ load each channel):	
with key C4 pressed in Synth-Lead 1	1050 mV $\pm$ 20 %
Output level (V <sub>rms</sub> with 47 K $\Omega$ load each channel):	
with key C1 pressed in Synth-Lead 1	1100 mV $\pm$ 20 %
Minimum operating voltage:	5.7 V

# BLOCK DIAGRAM

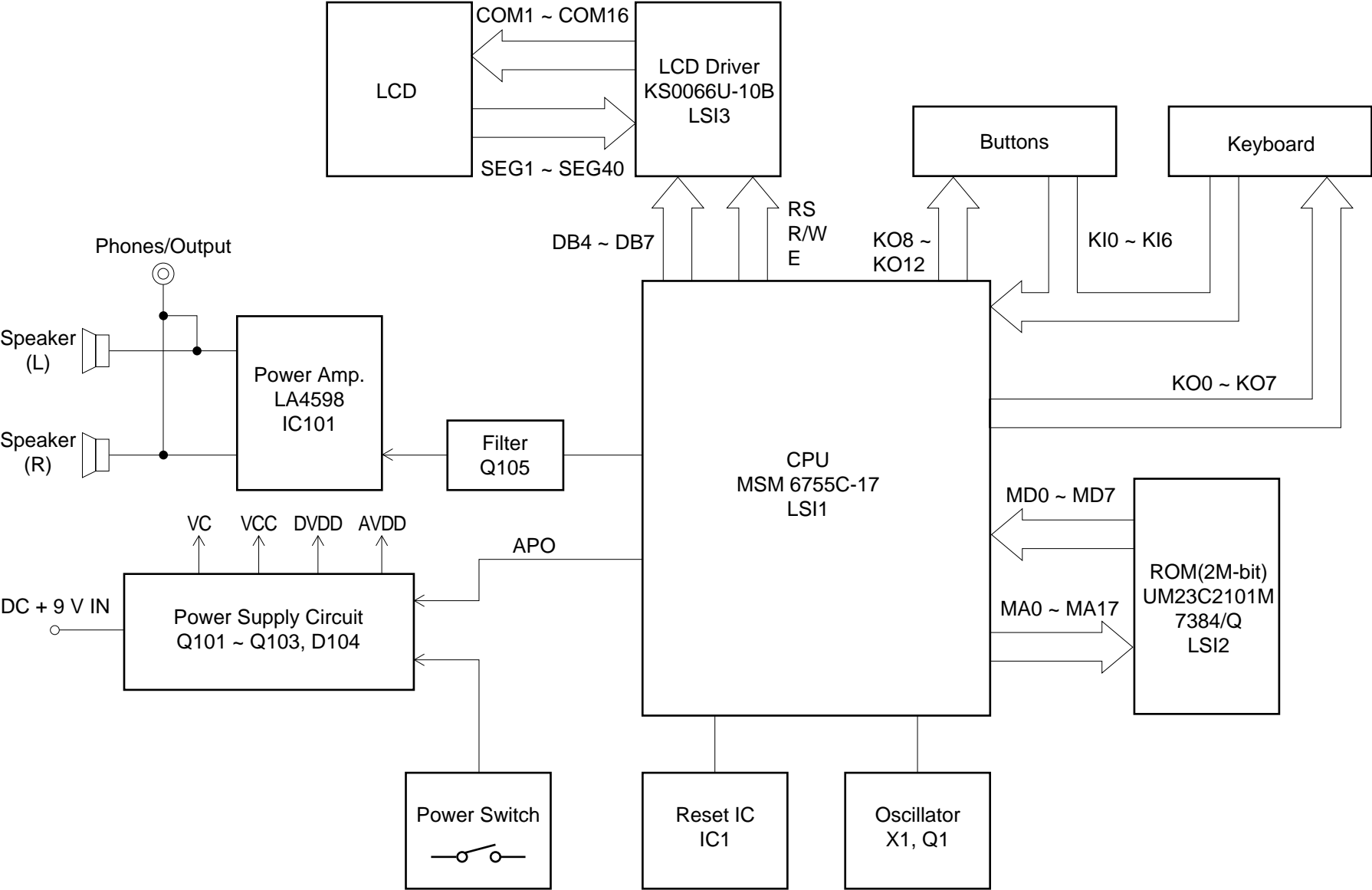

# CIRCUIT DESCRIPTION

## KEY MATRIX

	KI0	KI1	KI2	KI3	KI4	KI5	KI6
KO0	C2	G#2	E3	C4	G#4	E5	C6
KO1	C#2	A2	F3	C#4	A4	F5	
KO2	D2	A#2	F#3	D4	A#4	F#5	
KO3	D#2	B2	G3	D#4	B4	G5	
KO4	E2	C3	G#3	E4	C5	G#5	
KO5	F2	C#3	A3	F4	C#5	A5	
KO6	F#2	D3	A#3	F#4	D5	A#5	
KO7	G2	D#3	B3	G4	D#5	B5	
KO8	—	+	0	Tempo Down	Tempo Up	Volume Down	Volume Up
KO9	3	2	1	Start/ Stop	Synchro/ Fill-in	Chord Book	Accomp Volume
KO10	6	5	4	Transpose/ Tune	Song Bank	Rhythm	Tone
KO11	9	8	7 Chord	Fingered	CASIO	Normal	Power Off
KO12	FF	Right	Play/ Pause	Stop	Left	Rewind	

## NOMENCLATURE OF KEYS

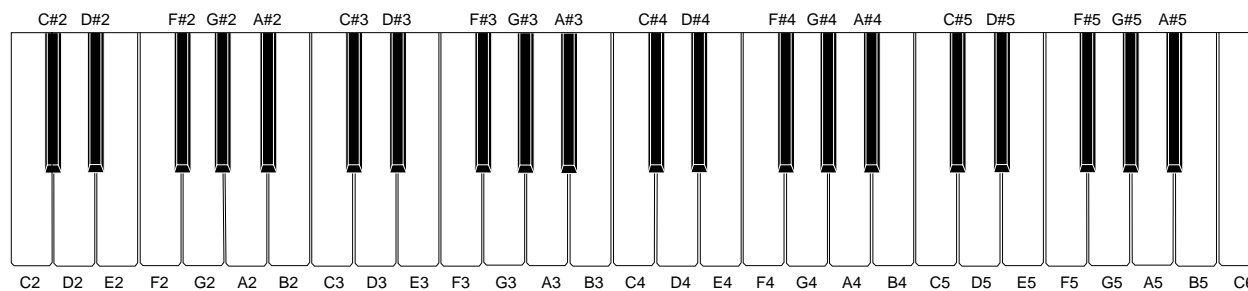

## CPU (LSI1: MSM6755C-17)

The CPU reads sound data from the ROM in accordance with the pressed key and the selected tone; the CPU can read rhythm data simultaneously when a rhythm pattern is selected. Then it provides the left and the right channels' waveforms separately, by converting the data into the waveforms with two built-in DACs. The CPU also controls key and button input. The following table shows the pin functions of LSI1.

Pin No.	Terminal	In/Out	Function
1	MA14	Out	Address bus
2, 3	NCO	—	Not used
4 ~ 19	MA0 ~ MA13	Out	Address bus
13	MRDB	Out	Read enable signal
17	MCSB	—	Not used
20 ~ 27	MD0 ~ MD7	In/Out	Data bus
28, 29	NC1, NC2	—	Not used
30	DGND	In	Ground (0 V) source
31	DVCC	In	+5 V source
32, 33	XTLO, XTLI	In/Out	20 MHz clock input/output
34	NC3	—	Not used
35	RSTB	In	Reset signal input
36	P24/RXD	—	MIDI signal input
37	P25/TXD	—	MIDI signal output
38	NMI	In	Power ON signal input. Connected to +5 V.
39	APO	Out	APO (Auto Power Off) signal output
40	NC4	—	Not used
41	REFH	Out	Terminal for the internal DAC
42, 43	NC5, NC6	—	Not used
44	DAOR	Out	Sound waveform signal output
45	NC7	—	Not used
46	AVdac	In	+5 V source for the internal DAC
47	DAOL	Out	Left channel sound waveform output
48	REFL	Out	Terminal for the internal DAC and ADC
49	AGdac	In	Ground source for internal DAC
50	AGadc	In	Ground source for internal ADC
51	ANI	In	Not used
52	AVadc	In	+5 V source for the internal ADC
53	NC8	—	Not used
54	MOD0	In	Mode selection terminal. Connected to +5 V.
55, 56	MOD1, MOD2	In	Mode selection terminal. Connected to ground.
57	P40	—	Not used
58 ~ 64	KI0/P30 ~ KI7/P36	In	Terminals for key/button input signal
65	KI7/P37	—	Not used
66 ~ 73	KO0/P50 ~ KO7/P57	Out	Terminals for key scan signal

Pin No.	Terminal	In/Out	Function
74 ~ 77	DB4 ~ DB7	Out	Data bus for the LCD driver
78	NC9	—	Not used
79	LVCC	In	+5 V source
80 ~ 84	KO8 ~ KO12	Out	Terminals for button scan signal
85 ~ 87	P65 ~ P67	—	Not used
88	RS	Out	Control signal for the LCD driver
89	R/W	Out	Read/Write signal for the LCD driver
90	E	Out	Chip enable signal for the LCD driver
91 ~ 95	P73 ~ P77	—	Not used
96	LGND	In	Ground source
97, 100	MA18, MA15	Out	Address bus

### LCD DRIVER (LSI3: KS0066U-10B)

The LCD driver can drive a dot matrix LCD having 40 segment and 16 common lines. The LSI contains 240 graphic symbols in the built-in character generator ROM, and stores 80 characters in the built-in display data RAM. In accordance with command from the CPU, the LSI is capable of displaying up to 16 characters simultaneously. The following table shows the pin functions of LSI3.

Pin No.	Terminal	In/Out	Function
1 ~ 22, 63 ~ 80	SEG1 ~ SEG40	Out	Segment signal output
23	VSS	—	GND (0 V) source
24, 25	OSC1, OSC2	In/Out	Terminals for the built-in clock pulse generator. The external resistor connected determines the oscillation frequency.
26 ~ 30	V1 ~ V5	In	LCD drive voltage input. Those voltages are used for generating the stepped pulse of the LCD drive signals.
31, 32	LP, XCLS	—	Not used
33	VDD	In	DVDD (+5 V) source
34, 35	FR, DO	—	Not used
36	RS	In	Data/command determination terminal. High: data, Low: command
37	R/W	In	Read/Write terminal. High: read, Low: write
38	E	In	Chip enable signal. High: enable, the writing is done at fall edge. Low: disenable
39 ~ 42	DB0 ~ DB3	—	Not used. Connected to GND (0 V)
43 ~ 46	DB4 ~ DB7	In/Out	Data bus
47 ~ 62	COM1 ~ COM16	Out	Common signal/output

## FILTER BLOCK

Since the sound signals from the CPU is stepped waveforms, the filter block is added to smooth the waveforms.

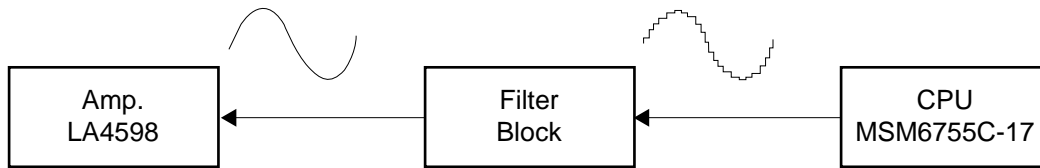

## POWER AMPLIFIER (IC101: LA4598)

The power amplifier is a two-channel amplifier with standby switch.

The following table shows the pin function of IC101.

Pin No.	Terminal	In/Out	Function
1	Power GND	In	Ground (0 V) source
2	Ch1 B.S.	—	Terminal for a bootstrap capacitor
3	Ch1 OUT	Out	Channel 1 output
4	VCC	In	+9 V source
5	Ch1 N.F.	In	Negative feedback input
6	Ch1 IN	In	Channel 1 input
7	D.C	—	Terminal for a bootstrap capacitor
8	Pre GND	In	Ground (0 V) source
9	Stand by	In	Power control signal input. 0 V:Off, +9 V: On
10	Ch2 IN	In	Not used. Connected to ground (0 V)
11	Ch2 N.F.	In	Negative feedback input
12	Ch2 OUT	Out	Channel 2 output
13	Ch2 B.S.	—	Terminal for a bootstrap capacitor
14	NC	—	Not used



# ADJUSTMENT

## MAIN PCB

- 1) Items to be adjusted:

Item	Measuring Instrument
Vop voltage setting	Voltmeter

- 2) Adjustment and Test Point Locations

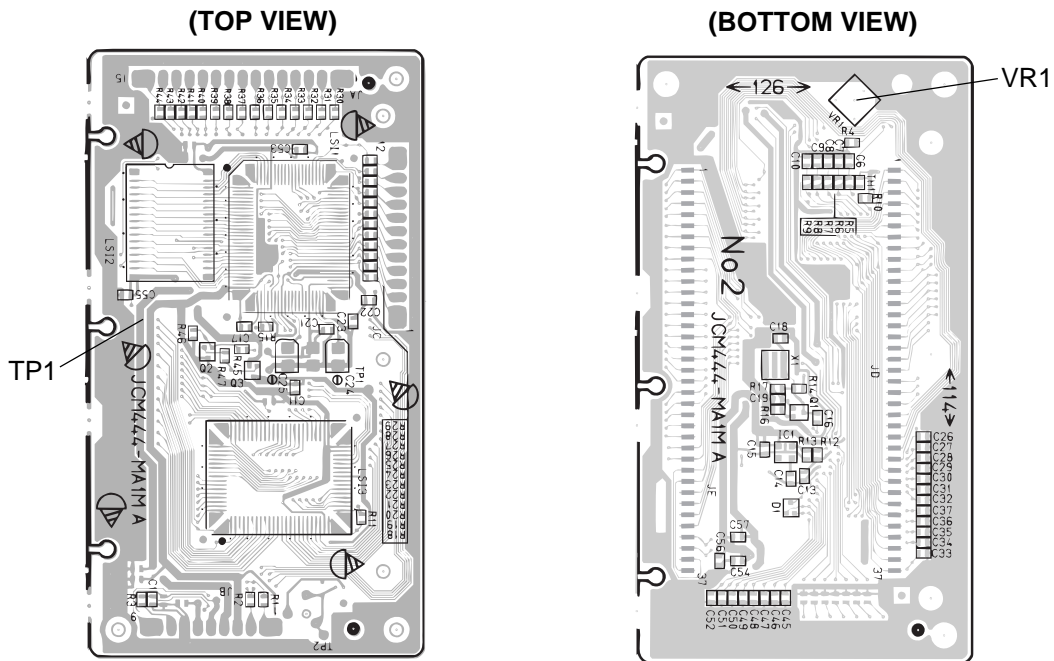

- 3) Equipment connection/Procedure

Vop voltage setting						
Input Connection	Input Point	Input Signal	Adjust	Output Connection	Output Point	Adjust for
—	—	—	VR1	Voltmeter	TP1	Adjust for 4.1 ~ 4.0 V reading on voltmeter under the temperature 20 ~ 25 °C. Make fine adjustment according to the following instruction.
<p>Watching the LCD at a 36.6° angle to the horizontal, adjust Vop voltage so that unenergized segments are seen dimly.</p>						

## MAJOR WAVEFORMS

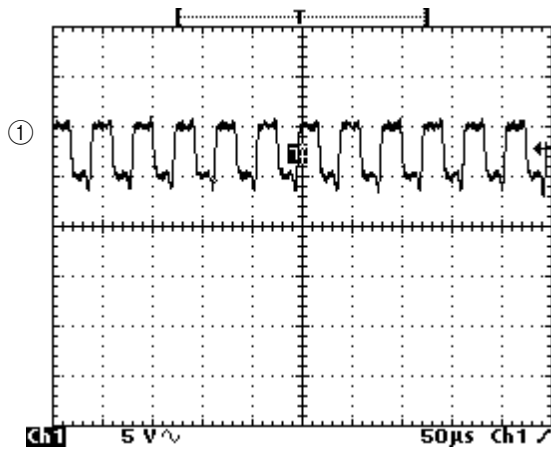

① Clock pulse  
MSM6755C-17 pin 32

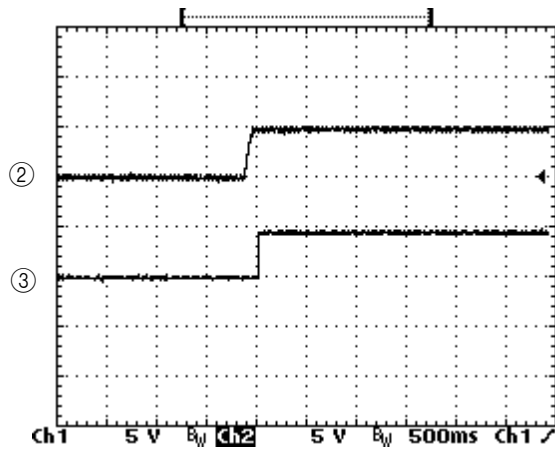

② +5 V source DVDD  
JB connector pin 4  
③ APO signal  
JB connector pin 8

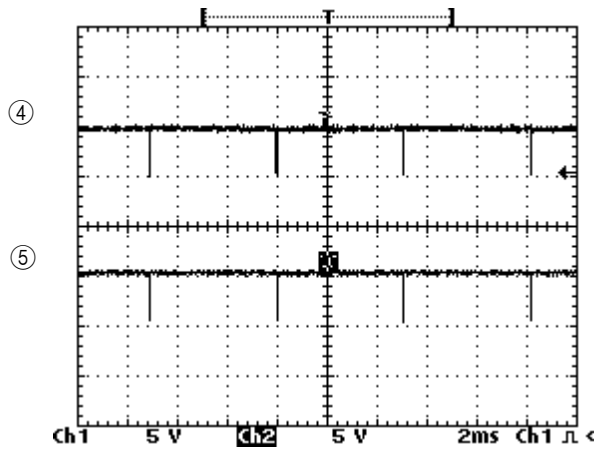

④ Button scan signal KO6  
JA connector pin 14  
⑤ Button scan signal KO7  
JA connector pin 15

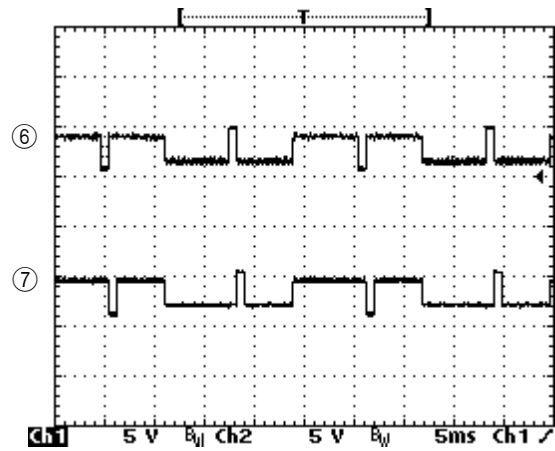

⑥ LCD common signal COM9  
KS0066U-10B pin 55  
⑦ LCD common signal COM10  
KS0066U-10B pin 56

# PRINTED CIRCUIT BOARDS

## Main PCB JCM444-MA1M

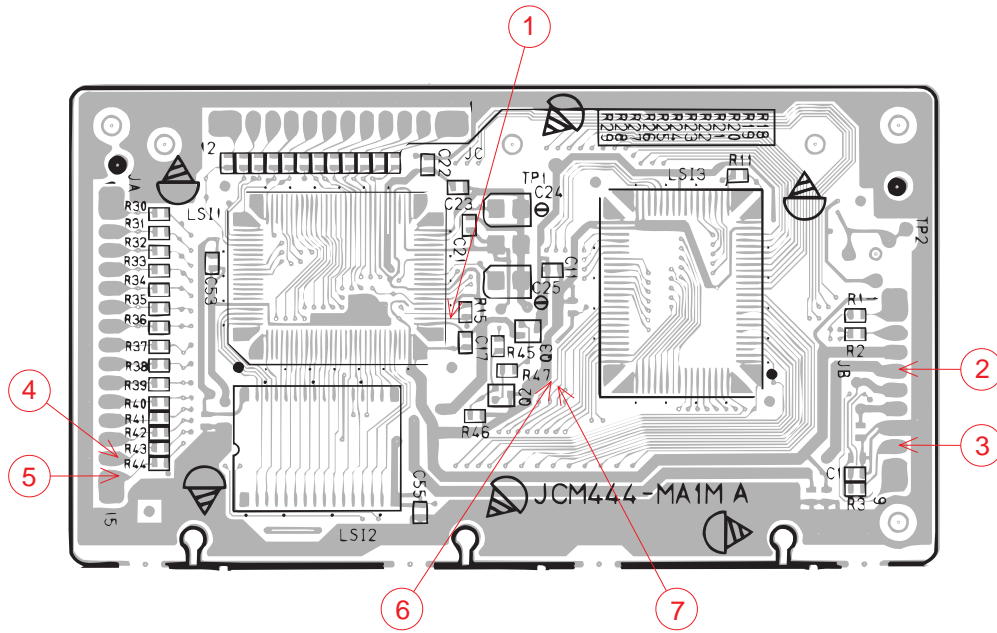

Top View

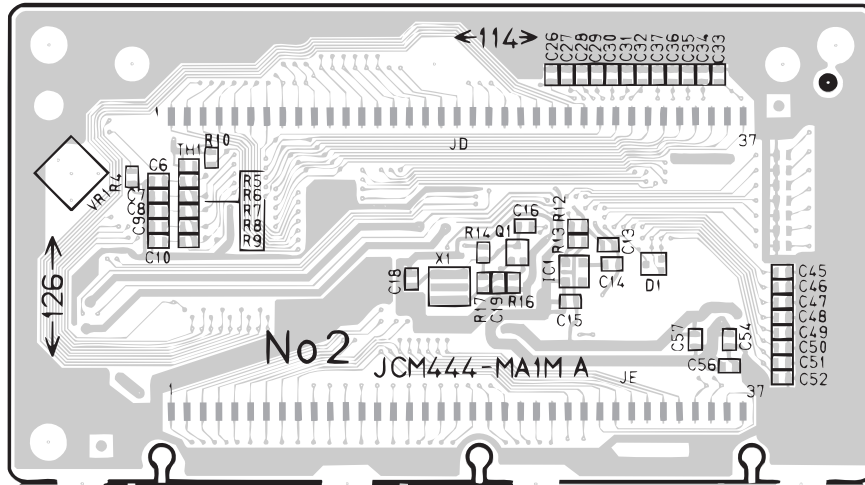

Bottom View

SCHMATIC DIAGRAMS

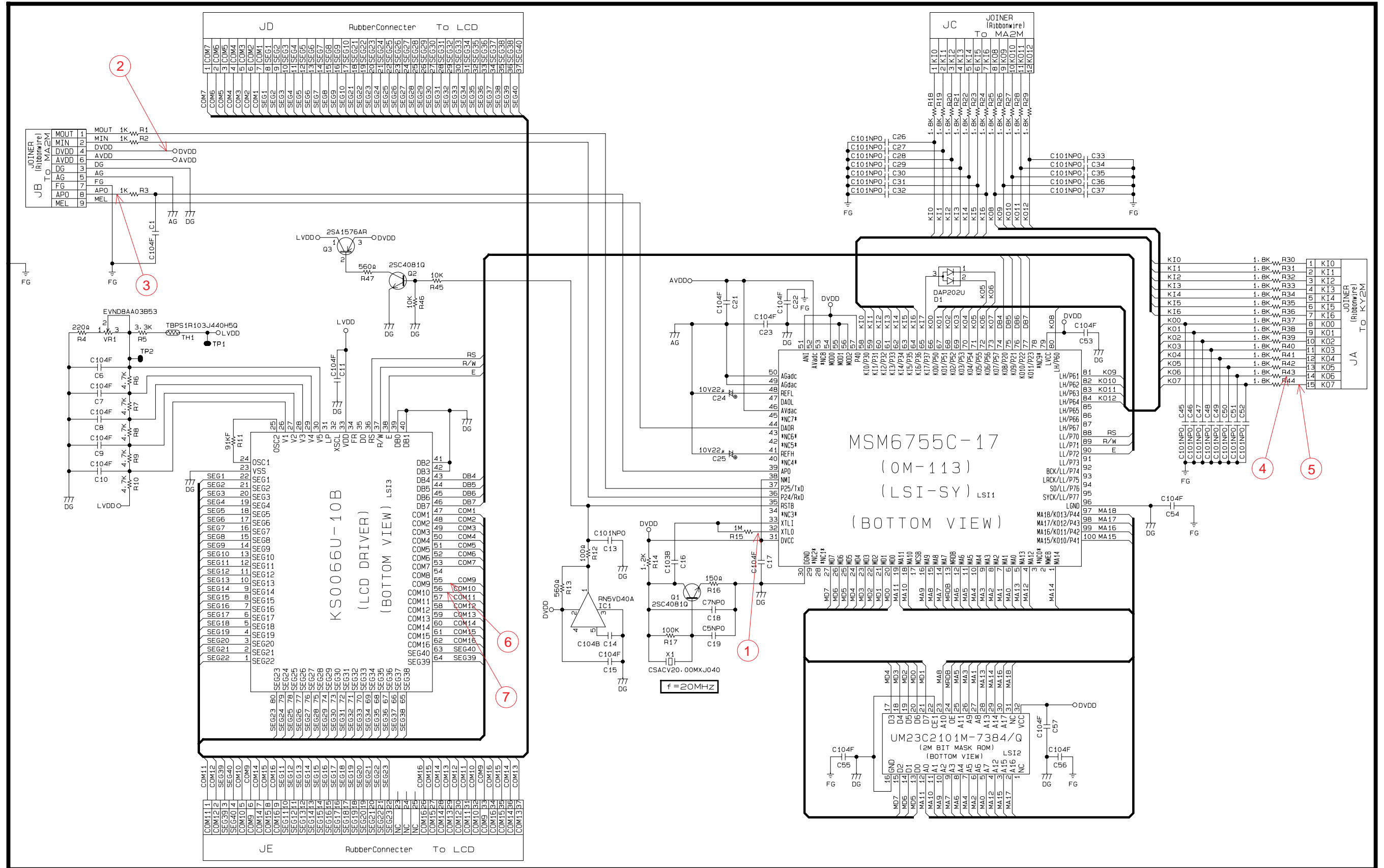



Keyboard PCBs JCM4911K-KY1M/KY2M

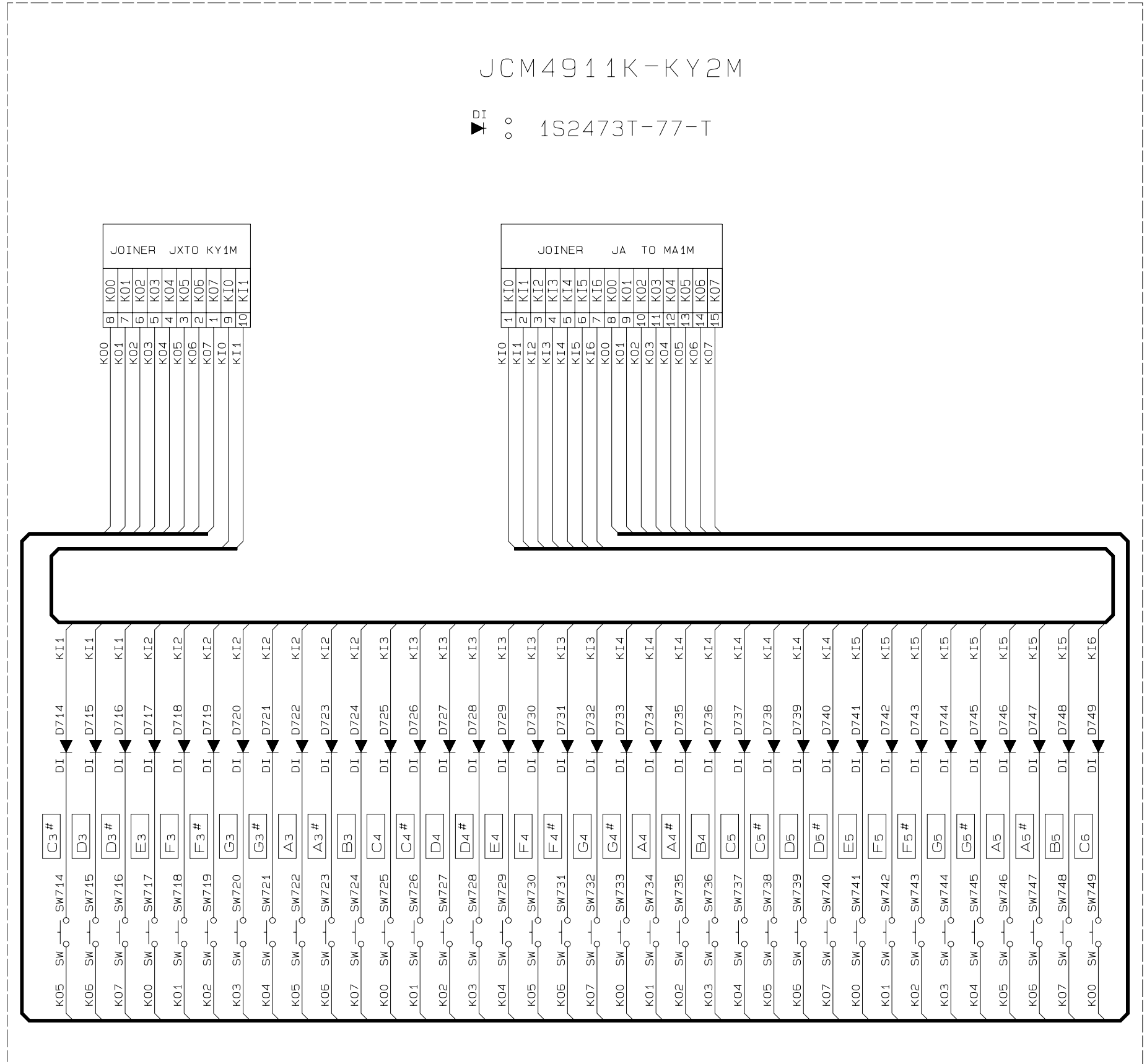
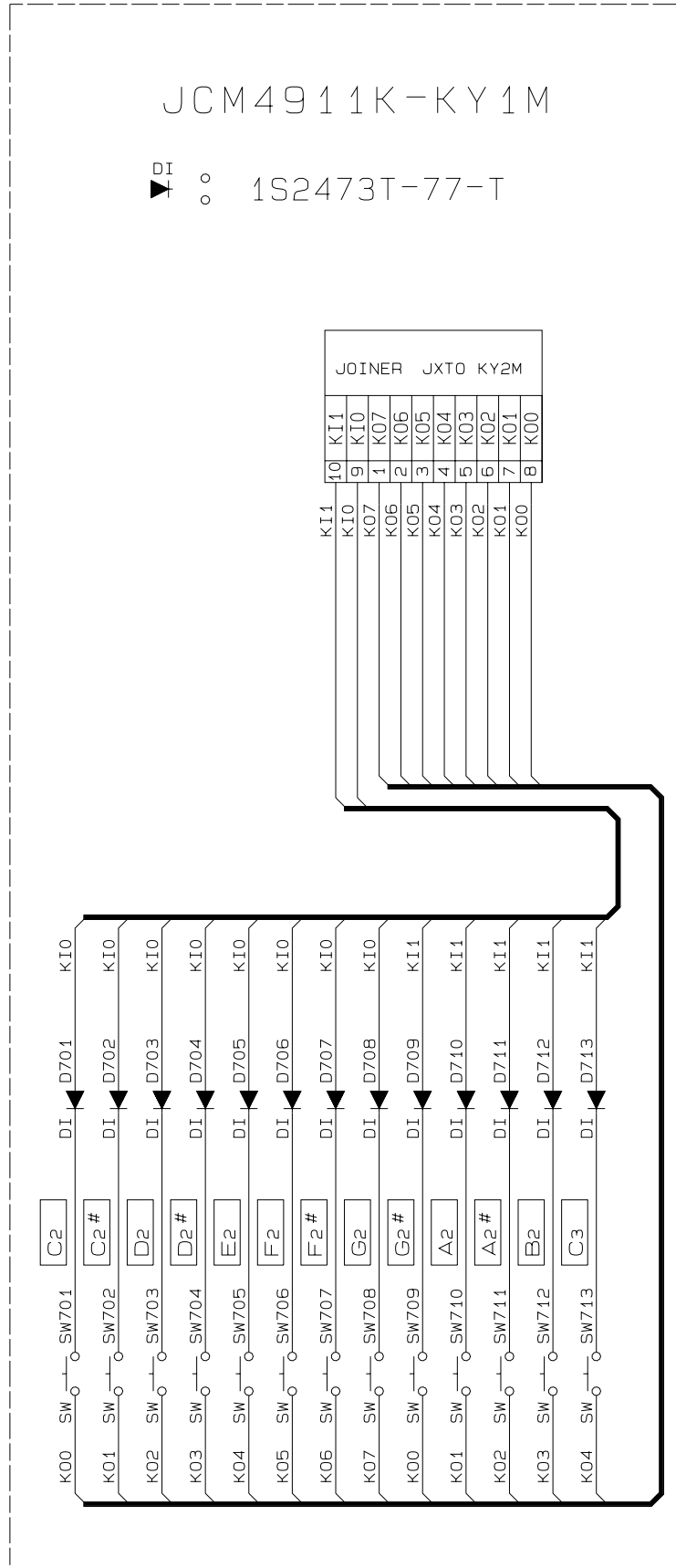

# LCD

## Common

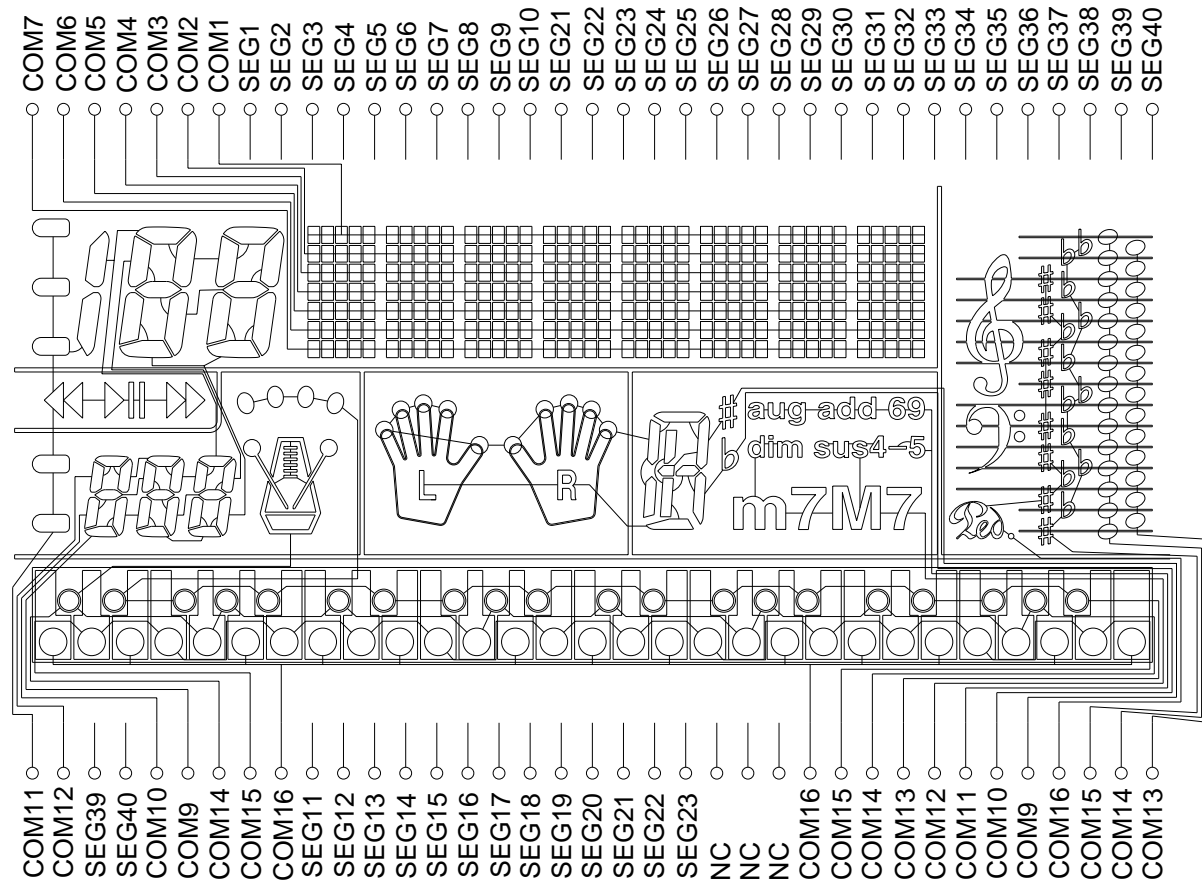

## Segment

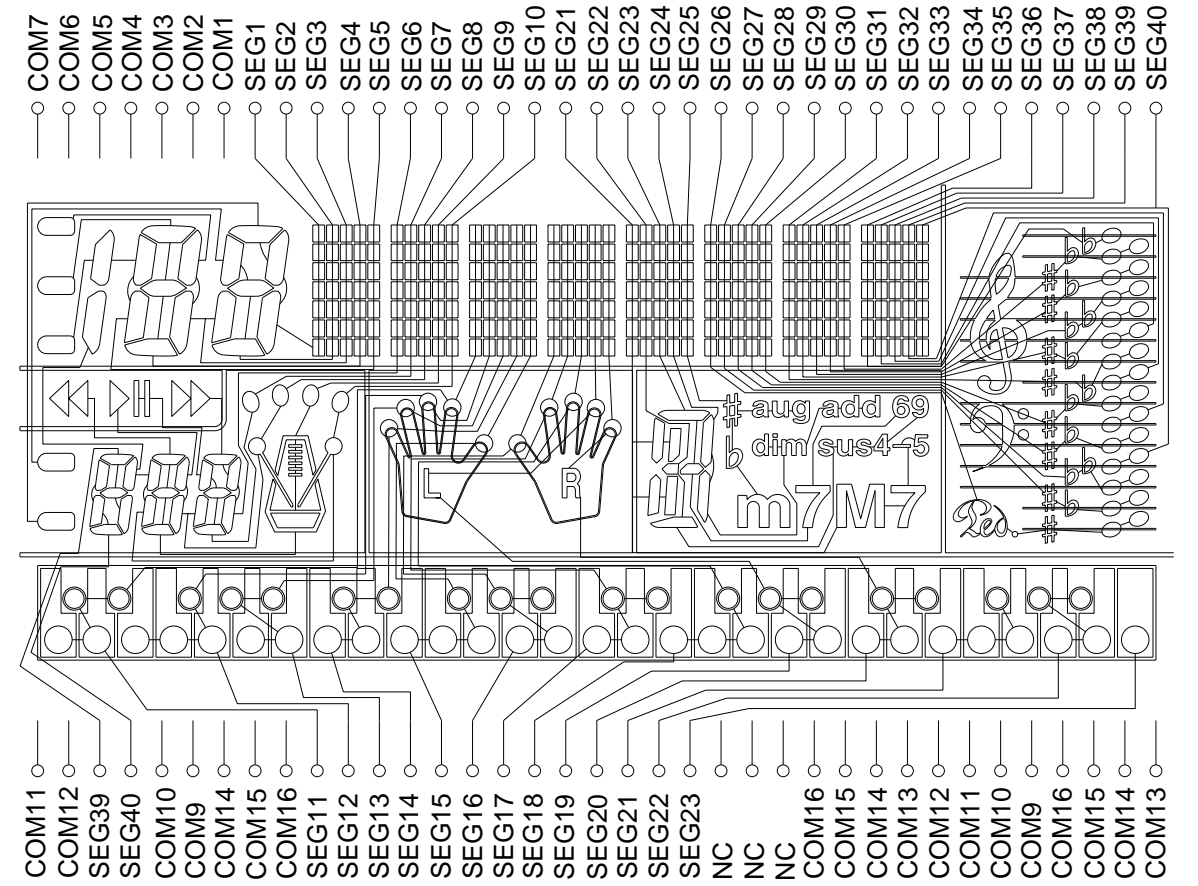

EXPLODED VIEW

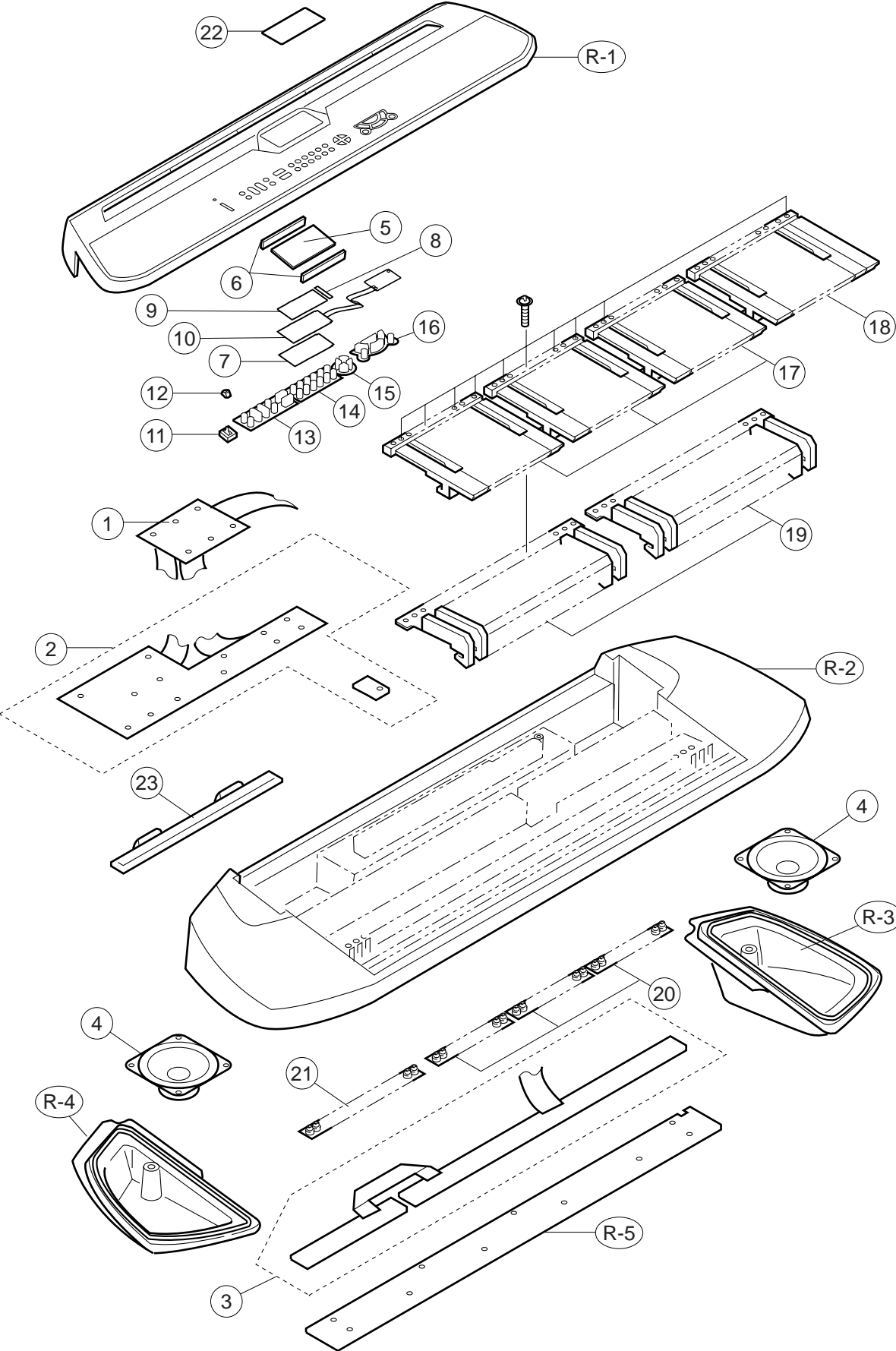



# PARTS LIST

## CTK-431

Notes: This parts list does not include the cosmetic parts, which parts are marked with item No. "R-X" in the exploded view.

Contact our spare parts department if you need these parts for refurbish.

1. Prices and specifications are subject to change without prior notice.
2. As for spare parts order and supply, refer to the "GUIDEBOOK for Spare parts Supply", published separately.
3. The numbers in item column correspond to the same numbers in drawing.

Item	Code No.	Part Name	Specification	Q	R
<b>Main PCB</b>					
1	6926 7070	PCB/ASSY (MA1M)	M240832*1	1	B
LSI1	2012 5603	LSI/MC (CPU)	MSM6755B-17	1	A
LSI2	2012 5611	LSI/MASK-ROM	UM23C2101M-7384/Q	1	A
LSI3	2012 5935	LSI/LCD DRIVER	KS0066U-10B	1	A
IC1	2012 1883	IC/MOS (RESET IC)	RN5VD40AA-TR	2	B
Q1,Q2	2252 1239	TRANSISTOR	2SC4081T106Q	1	B
Q3	2250 1162	TRANSISTOR	2SA1576AT106R	1	B
VR1	2775 0994	POTENTIOMETER	EVN-D8AA03B53	1	B
X1	2590 2100	OSCILLATOR/CERAMIC	CSACS20.00MX040-TC	1	B
<b>Sub PCB</b>					
2	6927 5070	PCB/ASSY (MA2,3M)	M241005*1	1	B
IC101	2114 2891	IC/LINEAR (POWER AMP)	LA4598	1	A
IC102	2252 1248	IC/POTOCUPPLER	HCPL-261A	1	A
Q102	2250 1591	TRANSISTOR	2SB1237TV2R	1	A
Q103~Q105	2250 1592	TRANSISTOR	2SC1740STPR	3	A
Q101	2250 1593	TRANSISTOR	2SD1858TV2R	1	A
D101	2390 3021	DIODE/SHOTTKY	SRT14	1	C
D102	2390 3018	DIODE	1T2	1	C
D104~D113	2390 1344	DIODE	1SS133T-77-T	10	C
D103	2360 2044	DIODE/ZENER	MTZJ6.2A-T77-T	1	A
J101	3612 0665	JACK (PHONE)	YKB21-5006	1	B
J102	3501 7049	JACK (POWER)	HEC2305-01-330	1	B
J103	3501 4816	JACK (MIDI)	YKF51-5051	1	B
<b>Keyboard PCBs</b>					
3	6926 7050	PCB/ASSY	M140749*1	1	C
D701 - D749	2301 0101	DIODE	1S2473T-77-T	49	B
<b>Mechanical Parts</b>					
4	3831 0665	SPEAKER	10G42AFA	1	B
5	3335 6823	LCD	LD-B10272E	1	B
6	6926 7200	RUBBER/INTERCONNECTOR	M440584-2	2	C
7	6927 6040	SPACER/455A	M440810-1	1	C
8	6927 6050	SPACER/455B	M440811-1	1	C
9	6927 6060	FILM/LEXAN	M440812-1	1	C
10	6927 5060	EL	M340996*1	1	B
11	6909 5890	SWITCH/SLIDE KONB	CSB-12D	1	B
12	6921 5031	KNOB	M311859-1	1	B
13	6927 6070	RUBBER/BUTTON	M240796-2	1	B
14	6927 6080	RUBBER/BUTTON	M240797-2	1	B
15	6927 6090	RUBBER/BUTTON	M240798-2	1	B
16	6927 6100	RUBBER/BUTTON	M240799-2	1	B
17	6922 2720	KEY SET/LT WHITE	M312118*1	3	A
18	6922 2730	KEY SET/LT WHITE	M312118*2	1	A
19	6922 2740	KEY SET/LT BLACK 10P	M111726-1	2	A
20	6926 0670	RUBBER/CONTACT	M240549-1	3	A
21	6926 0680	RUBBER/CONTACT	M240550-1	1	A
22	6906 9611	PANEL/DISPLAY	M340789-2	1	C
23	6925 4500	COVER/BATTERY	M340528*1	1	B
<b>Accessory</b>					
	6906 8752	STAND/NOTE	M340629B*2	1	B

Notes: Q - Quantity per unit  
R - Rank

**CASIO TECHNO CO.,LTD.**  
Overseas Service Division

Nishi-Shinjuku Kimuraya Bldg. 1F  
5-25, Nishi-Shinjuku 7-Chome  
Shinjuku-ku, Tokyo 160-0023, Japan