

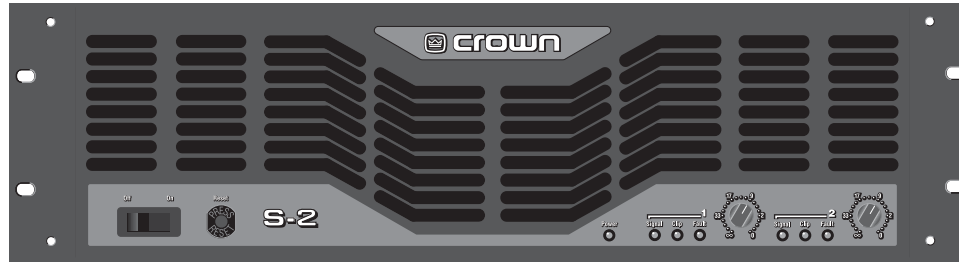

S-Series

Operation Manual



S-2

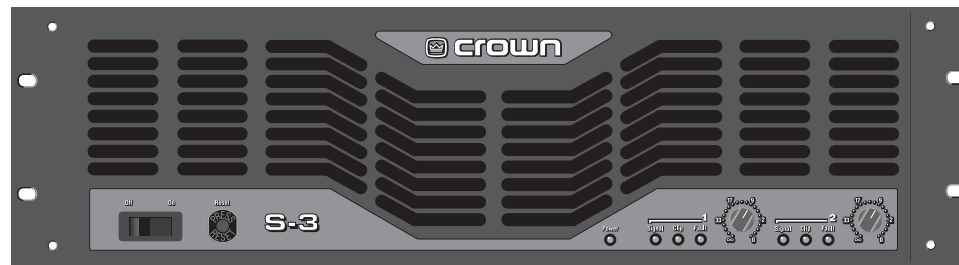

S-3

Obtaining Other Language Versions: To obtain information in another language about the use of this product, please contact your local Crown Distributor. If you need assistance locating your local distributor, please contact Crown at 574-294-8000.

This manual does not include all of the details of design, production, or variations of the equipment. Nor does it cover every possible situation which may arise during installation, operation or maintenance.

The information provided in this manual was deemed accurate as of the publication date. However, updates to this information may have occurred. To obtain the latest version of this manual, please visit the Crown website at www.crownaudio.com.

Trademark Notice: Crown, Crown Audio, and Amcron are registered trademarks of Crown International. Other trademarks are the property of their respective owners.

Some models may be exported under the name Amcron.®

Important Safety Instructions

- 1) Read these instructions.
- 2) Keep these instructions.
- 3) Heed all warnings.
- 4) Follow all instructions.
- 5) Do not use this apparatus near water.
- 6) Clean only with a dry cloth.
- 7) Do not block any ventilation openings. Install in accordance with the manufacturer's instructions.
- 8) Do not install near any heat sources such as radiators, heat registers, stoves, or other apparatus (including amplifiers) that produce heat.
- 9) Do not defeat the safety purpose of the polarized or grounding-type plug. A polarized plug has two blades with one wider than the other. A grounding-type plug has two blades and a third grounding prong. The wide blade or the third prong is provided for your safety. If the provided plug does not fit into your outlet, consult an electrician for replacement of the obsolete outlet.
- 10) Protect the power cord from being walked on or pinched, particularly at plugs, convenience receptacles, and the point where they exit from the apparatus.
- 11) Only use attachments/accessories specified by the manufacturer.
- 12) Use only with a cart, stand, tripod, bracket, or table specified by the manufacturer, or sold with the apparatus. When a cart is used, use caution when moving the cart/apparatus combination to avoid injury from tip-over.
- 13) Unplug this apparatus during lightning storms or when unused for long periods of time.
- 14) Refer all servicing to qualified service personnel. Servicing is required when the apparatus has been damaged in any way, such as power-supply cord or plug is damaged, liquid has been spilled or objects have fallen into the apparatus, the apparatus has been exposed to rain or moisture, does not operate normally, or has been dropped.



- 15) WARNING: TO REDUCE THE RISK OF FIRE OR ELECTRIC SHOCK, DO NOT EXPOSE THIS APPARATUS TO RAIN OR MOISTURE.
- 16) DO NOT EXPOSE TO DRIPPING OR SPLASHING. DO NOT PLACE OBJECTS FILLED WITH LIQUID, SUCH AS VASES, ON THIS APPARATUS.

TO PREVENT ELECTRIC SHOCK DO NOT REMOVE TOP OR BOTTOM COVERS. NO USER SERVICEABLE PARTS INSIDE. REFER SERVICING TO QUALIFIED SERVICE PERSONNEL.

À PRÉVENIR LE CHOC ÉLECTRIQUE N'ENLEVEZ PAS LES COUVERCLES. IL N'Y A PAS DES PARTIES SERVICEABLE À L'INTÉRIEUR. TOUTS REPARATIONS DOIT ÊTRE FAIRE PAR PERSONNEL QUALIFIÉ SEULMENT.

TO COMPLETELY DISCONNECT THIS EQUIPMENT FROM THE AC MAINS, DISCONNECT THE POWER SUPPLY CORD PLUG FROM THE AC RECEPTACLE. THE MAINS PLUG OF THE POWER SUPPLY CORD SHALL REMAIN READILY OPERABLE.

WATCH FOR THESE SYMBOLS:

The lightning bolt triangle is used to alert the user to the risk of electric shock.

The exclamation point triangle is used to alert the user to important operating or maintenance instructions.



CAUTION
RISK OF ELECTRIC SHOCK
DO NOT OPEN

AVIS
RISQUE DE CHOC ÉLECTRIQUE
N'OUVREZ PAS



IMPORTANT
S Series amplifiers require Class 2 output wiring.



MAGNETIC FIELD

CAUTION! Do not locate sensitive high-gain equipment such as preamplifiers or tape decks directly above or below the unit. Because this amplifier has a high power density, it has a strong magnetic field which can induce hum into unshielded devices that are located nearby. The field is strongest just above and below the unit.

If an equipment rack is used, we recommend locating the amplifier(s) in the bottom of the rack and the

FCC COMPLIANCE NOTICE

This device complies with part 15 of the FCC rules. Operation is subject to the following two conditions: (1) This device may not cause harmful interference, and (2) this device must accept any interference received, including interference that may cause undesired operation.

CAUTION: Changes or modifications not expressly approved by the party responsible for compliance could void the user's authority to operate the equipment.

NOTE: This equipment has been tested and found to comply with the limits for a Class B digital device, pursuant to part 15 of the FCC Rules. These limits are designed to provide reasonable protection against harmful interference in a residential installation. This equipment generates, uses, and can radiate radio frequency energy and, if not installed and used in accordance with the instruction manual, may cause harmful interference to radio communications. However, there is no guarantee that interference will not occur in a particular installation. If this equipment does cause harmful interference to radio or television reception, which can be determined by turning the equipment off and on, the user is encouraged to try to correct the interference by one or more of the following measures:

- Reorient or relocate the receiving antenna.
- Increase the separation between the equipment and receiver.
- Connect the equipment into an outlet on a circuit different from that to which the receiver is connected.
- Consult the dealer or an experienced radio/TV technician for help.

Crown International, Inc.

DECLARATION of CONFORMITY

Technical Construction File Route

Issued By: Crown International, Inc.
1718 W. Mishawaka Road
Elkhart, Indiana 46517 U.S.A.

FOR COMPLIANCE QUESTIONS ONLY: Sue Whitfield
574-294-8289
swhitfield@crowintl.com

Equipment Type: Commercial Audio Power Amplifiers
Family Name: S-Series
Model Names: S-2, S-3

European Representative's Name and Address:

Nick Owen
35, Bassets Field
Thornhill
Cardiff, South Glamorgan
CF14 9UG United Kingdom

EMC Standards:

EN 55103-1:1995 Electromagnetic Compatibility - Product Family Standard for Audio, Video, Audio-Visual and Entertainment Lighting Control Apparatus for Professional Use, Part 1: Emissions

EN 55103-1:1995 Magnetic Field Emissions-Annex A @ 10 cm and 1 M

EN 61000-3-2:1995+A14:2000 Limits for Harmonic Current Emissions (equipment input current $\leq 16A$ per phase)

EN 61000-3-3:1995 Limitation of Voltage Fluctuations and Flicker in Low-Voltage Supply Systems Rated Current $\leq 16A$

EN 55022:1992 + A1: 1995 & A2:1997 Limits and Methods of Measurement of Radio Disturbance Characteristics of ITE: Radiated, Class B Limits; Conducted, Class B

EN 55103-2:1996 Electromagnetic Compatibility - Product Family Standard for Audio, Video, Audio-Visual and Entertainment Lighting Control Apparatus for Professional Use, Part 2: Immunity

EN 61000-4-2:1995 Electrostatic Discharge Immunity (Environment E2-Criteria B, 4k V Contact, 8k V Air Discharge)

EN 61000-4-3:1996 Radiated, Radio-Frequency, Electromagnetic Immunity (Environment E2, criteria A)

EN 61000-4-4:1995 Electrical Fast Transient/Burst Immunity (Criteria B)

EN 61000-4-5:1995 Surge Immunity (Criteria B)

EN 61000-4-6:1996 Immunity to Conducted Disturbances Induced by Radio-Frequency Fields (Criteria A)

EN 61000-4-11:1994 Voltage Dips, Short Interruptions and Voltage Variation

Safety Standard:

EN 60065: 1998 Safety Requirements - Audio Video and Similar Electronic Apparatus

I certify that the product identified above conforms to the requirements of the EMC Council Directive 89/336/EEC as amended by 92/31/EEC, and the Low Voltage Directive 73/23/EES as amended by 93/68/EEC.

Signed

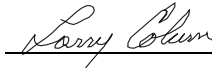

Larry Coburn

Title: Senior Vice President of Manufacturing

Date of Issue: March 28, 2000

Table of Contents

Important Safety Instructions	2	4.1.1 Bias Servo	15
Declaration of Conformity	3	4.1.2 Fault	15
1 Welcome	5	4.1.3 Ultrasonic and Radio Frequency Protection	15
1.1 Features	5	4.1.4 Drive Protection.....	15
1.2 How to Use This Manual	5	4.1.5 Compression	15
2 Setup	6	4.1.6 Power Circuit Breaker	15
2.1 Unpack Your Amplifier	6	4.1.7 Proportional-speed Fan	15
2.2 Install Your Amplifier	6	4.2 Advanced Features	15
2.3 Ensure Proper Cooling	6	4.2.1 Crown SST Modules	15
2.4 Choose Input Wire and Connectors	7	4.2.2 Fault Monitoring	17
2.5 Choose Output Wire and Connectors	8	4.3 Options	18
2.6 Wire Your System	9	4.3.1 Accessories	18
2.6.1 Stereo Mode	9	4.3.2 Alternate Output Connectors	18
2.6.2 How to Parallel the Inputs	9	4.3.3 Tamper-Resistant Hole Plugs	18
2.6.3 Bridge-Mono Mode	10	4.3.4 Optional 0.775 V Input Sensitivity Setting	18
2.7 Input Sensitivity Switch	11	5 Principles of Operation	19
2.8 Connect to AC Mains	11	6 Troubleshooting	21
2.9 Startup Procedure	11	7 Specifications	22
3 Operation	12	8 Service	23
3.1 Precautions	12	9 Warranty	24
3.2 Controls, Indicators and Connectors	13	Crown Factory Service Information Form	27
3.3 Front Panel Controls and Indicators	14		
3.4 Back Panel Controls	14		
4 Advanced Features and Options	15		
4.1 Protection Systems	15		

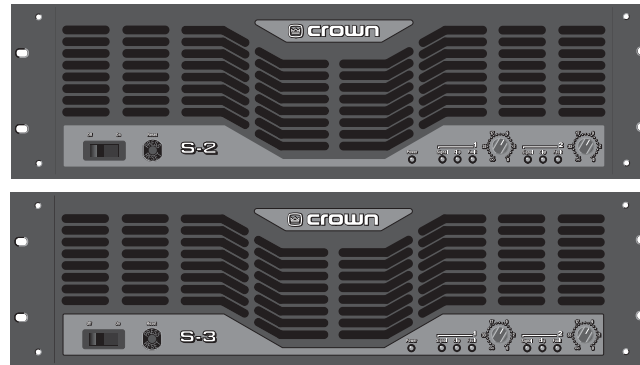

S-2	*1 kHz Power
2-ohm Stereo (per channel)	560W
4-ohm Stereo (per channel)	450W
8-ohm Stereo (per channel)	275W
4-ohm Bridge-Mono	1,100W
8-ohm Bridge-Mono	900W

*1 kHz Power: refers to maximum average power in watts at 1 kHz with 0.5% THD.

S-3	*1 kHz Power
2-ohm Stereo (per channel)	975W
4-ohm Stereo (per channel)	660W
8-ohm Stereo (per channel)	400W
4-ohm Bridge-Mono	1,950W
8-ohm Bridge-Mono	1,320W

*1 kHz Power: refers to maximum average power in watts at 1 kHz with 0.5% THD.

1 Welcome

Crown® S-Series amplifiers provide professional audio amplification for a wide range of applications, including digital cinema. The amplifiers are very affordable, and feature front-panel controls for easy setup and use. They can be removed for security.

Modern power amplifiers are sophisticated pieces of engineering capable of producing extremely high power levels. They must be treated with respect and correctly installed if they are to provide the many years of reliable service for which they were designed.

In addition, S-Series amplifiers include a number of features which require some explanation before they can be used to their maximum advantage.

Please take the time to study this manual so that you can obtain the best possible service from your amplifier.

1.1 Features

- Accurate, undistorted sound.
- Bridge-mono/stereo mode switch allows you to set up your amps/speakers in the configuration that best suits your needs.

- Versatile; handles a wide range of speaker impedances and outputs.
- Advanced protection circuitry guards against shorted outputs, open circuits, DC, mismatched loads, general overheating, high-frequency overloads and internal faults.
- Genuine Neutrik® Speakon® connectors.
- Choice of 1/4-inch, XLR or barrier strip inputs.
- Removable front-panel level control knobs.
- Selectable input sensitivity.
- Proportional-speed fan optimizes cooling efficiency.
- Can be mounted in EIA standard 19-in. (48.3-cm) rack, shallow 14-in. (35.5) rack, or stacked on top of each other.
- Three Year, No-Fault, Fully-Transferable Warranty completely protects your investment and guarantees its specifications.

1.2 How to Use This Manual

This manual provides you with the necessary information to safely and correctly setup and operate your amplifier. It does not cover every aspect of installation, setup or operation that might occur under every condition. For additional information, please consult Crown's *Amplifier Application Guide* (available online at www.crownaudio.com), Crown Technical Support, your system installer or retailer.

We strongly recommend you read all instructions, warnings and cautions contained in this manual. Also, for your protection, please send in your warranty registration card today. And save your bill of sale — it's your official proof of purchase.

2 Setup

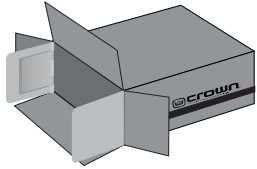

2.1 Unpack Your Amplifier

Please unpack and inspect your amplifier for any damage that may have occurred during transit. If damage is found, notify the transportation company immediately. Only you can initiate a claim for shipping damage. Crown will be happy to help as needed. Save the shipping carton as evidence of damage for the shipper's inspection.

We also recommend that you save all packing materials so you will have them if you ever need to transport the unit. **Never ship the unit without the factory pack.**

YOU WILL NEED (not supplied):

- Input wiring cables
- Output wiring cables

Rack and rack-mounting hardware for mounting amplifier (or a stable surface for stacking)



WARNING: Before you start to set up your amplifier, make sure you read and observe the Important Safety Instructions found at the beginning of this manual.



2.2 Install Your Amplifier

CAUTION: Before you begin, make sure your amplifier is disconnected from the power source, with power switch in the "off" position and all level controls turned completely down (counterclockwise).

Use a standard 19-inch (48.3 cm) equipment rack. See Figure 2.1 for amplifier dimensions.

You may also stack amps without using a cabinet.

NOTE: When transporting, amplifiers should be supported at both front and back.

2.3 Ensure Proper Cooling

When using an equipment rack, mount units directly on top of each other. Close any open spaces in rack with blank panels. DO NOT block front or rear air vents. The side walls of the rack should be a minimum of 2 inches (5.1 cm) away from the amplifier sides, and the back of the rack should be a minimum of 4 inches (10.2 cm) from the amplifier back panel.

Figure 2.2 illustrates standard amplifier airflow.

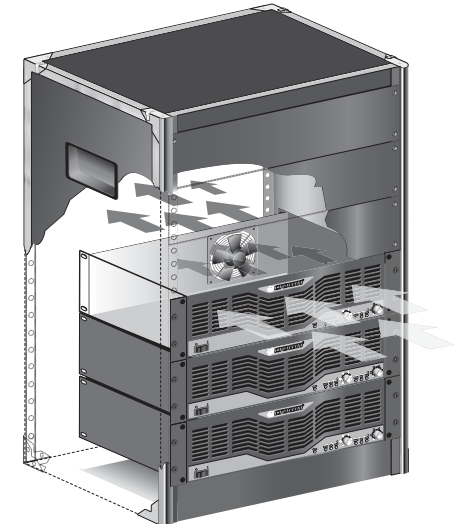

Figure 2.2 Airflow

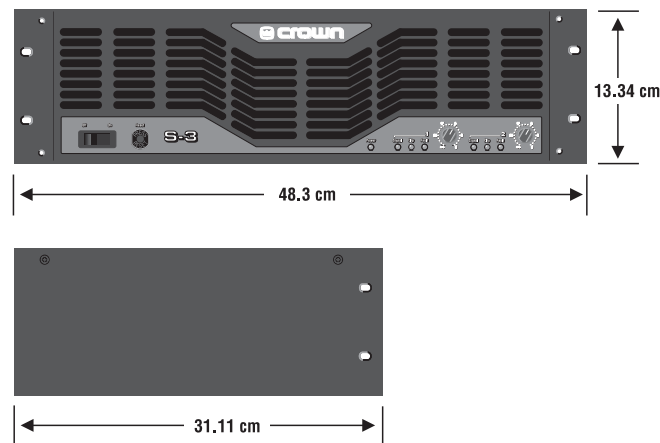

Figure 2.1 S2 and S3 Dimensions

2 Setup

2.4 Choose Input Wire and Connectors

You have three choices of input connectors: 1/4-inch (6.35-mm) phone, 3-pin XLR, or barrier strip. You can also use either balanced or unbalanced wiring.

Figure 2.3 shows balanced connector pin assignments for XLR and phone. Figure 2.4 shows unbalanced connector pin assignments for XLR and phone.

Figure 2.5 shows barrier strip input wiring for a balanced signal. Both channels should be wired using a common center terminal for ground connection.



NOTE: Custom wiring should only be performed by qualified personnel.

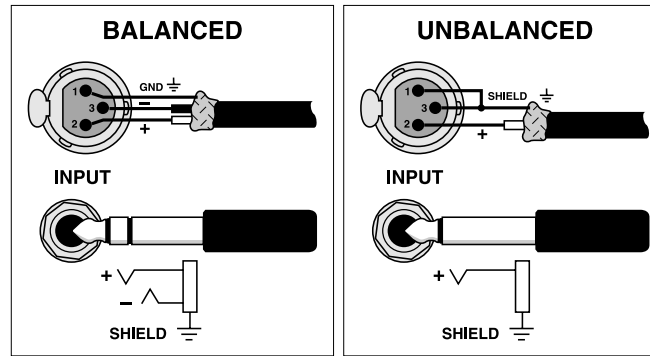

Figure 2.3 Balanced Input Connector Wiring

Figure 2.4 Unbalanced Input Connector Wiring

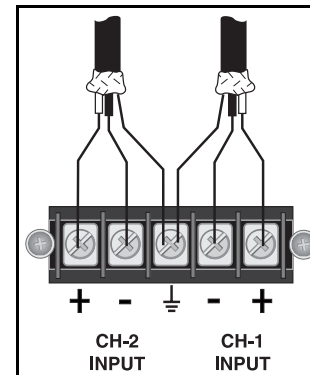

Figure 2.5 Barrier Strip Input Wiring: Balanced Signal In

2 Setup

2.5 Choose Output Wire and Connectors

Crown recommends using pre-built or professionally wired, high-quality, two- or four-conductor, heavy gauge speaker wires. They should be terminated with Neutrik Speakon NL4FC connectors (Figure 2.6) at one end and appropriate connectors to fit your speakers at the other end.

If your S-Series amplifier came equipped with the CEAS1 (barrier strip) or CEAS2 (5-way binding post) optional output connectors, you may wire your output to these connectors instead. Optional output connectors can also be ordered as a Service Option for installation on existing S-Series amplifiers.

If the CEAS1 Output Module is installed, use terminal forks or bare wire for your output connectors (see Figure 2.7).

To prevent the possibility of short-circuits, replace the cover on the barrier strip after completing the output wiring.

If the CEAS2 Output Module is installed, connect to it with bare wires, spade lugs or banana plugs on the speaker cables (Figure 2.8).

Using the guidelines below, select the appropriate size of wire based on the distance from amplifier to speaker.

Distance	Wire Size
up to 25 ft.	16 gauge
26-40 ft.	14 gauge
41-60 ft.	12 gauge
61-100 ft.	10 gauge
101-150 ft.	8 gauge
151-250 ft.	6 gauge



CAUTION: Never use shielded cable for output wiring.



Figure 2.6 Neutrik® Speakon® Connector

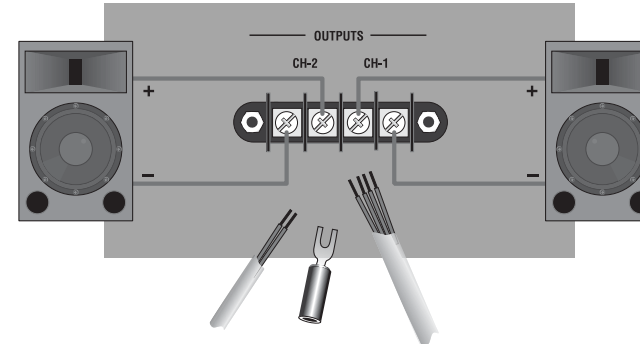

Figure 2.7 Output Connector Wiring for Stereo with Optional CEAS1 Output Module.

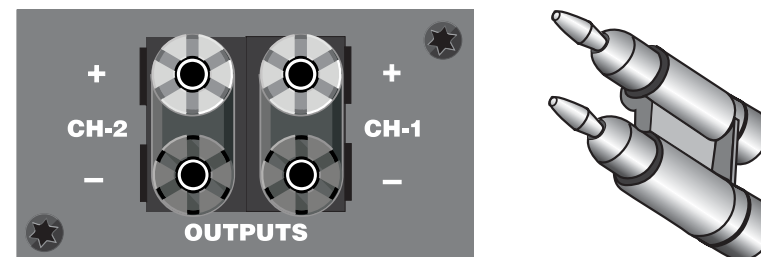

Figure 2.8 Optional CEAS2 5-way Binding Post Output Connector (Left) Each Pair of Posts Connects to a Dual Banana Plug (Right)

2 Setup

2.6 Wire Your System

2.6.1 Stereo Mode

Make sure the amplifier is turned off and the level controls are turned down before you wire the system.

Typical input and output wiring is shown in Figure 2.9.

INPUTS: Connect input wiring for each channel.

OUTPUTS: Maintain proper polarity (+/-) on output connectors.

Connect Channel-1 positive (+) speaker load to Channel-1 positive terminal of amp; repeat for negative (-). Repeat each channel wiring as for Channel 1. Refer to Section 3.5 for output connector pin assignments. Make sure the Mode switch is set to the "Stereo" position when operating in Stereo mode.

2.6.2 How to Parallel the Inputs

There are three ways to feed the same signal to each amplifier channel:

1. Buy a "Y" cable. Plug the female end into your signal cable, and plug the split male ends into both amplifier inputs.
2. Feed your signal to the Channel-1 input (either barrier-block or combo). Connect a jumper wire (Figure 2.10) between the barrier-block Channel-1 (+) screw terminal and the Channel-2 (+) screw terminal. Connect another jumper wire between the Channel-1 (-) screw terminal and the Channel-2 (-) screw terminal.
3. Feed your signal to the Channel-1 input screw terminals. Using a mic cable or phone-to-phone cable, connect Channel-1 combo jack to Channel-2 combo jack.

See the next page for Bridge-Mono wiring.

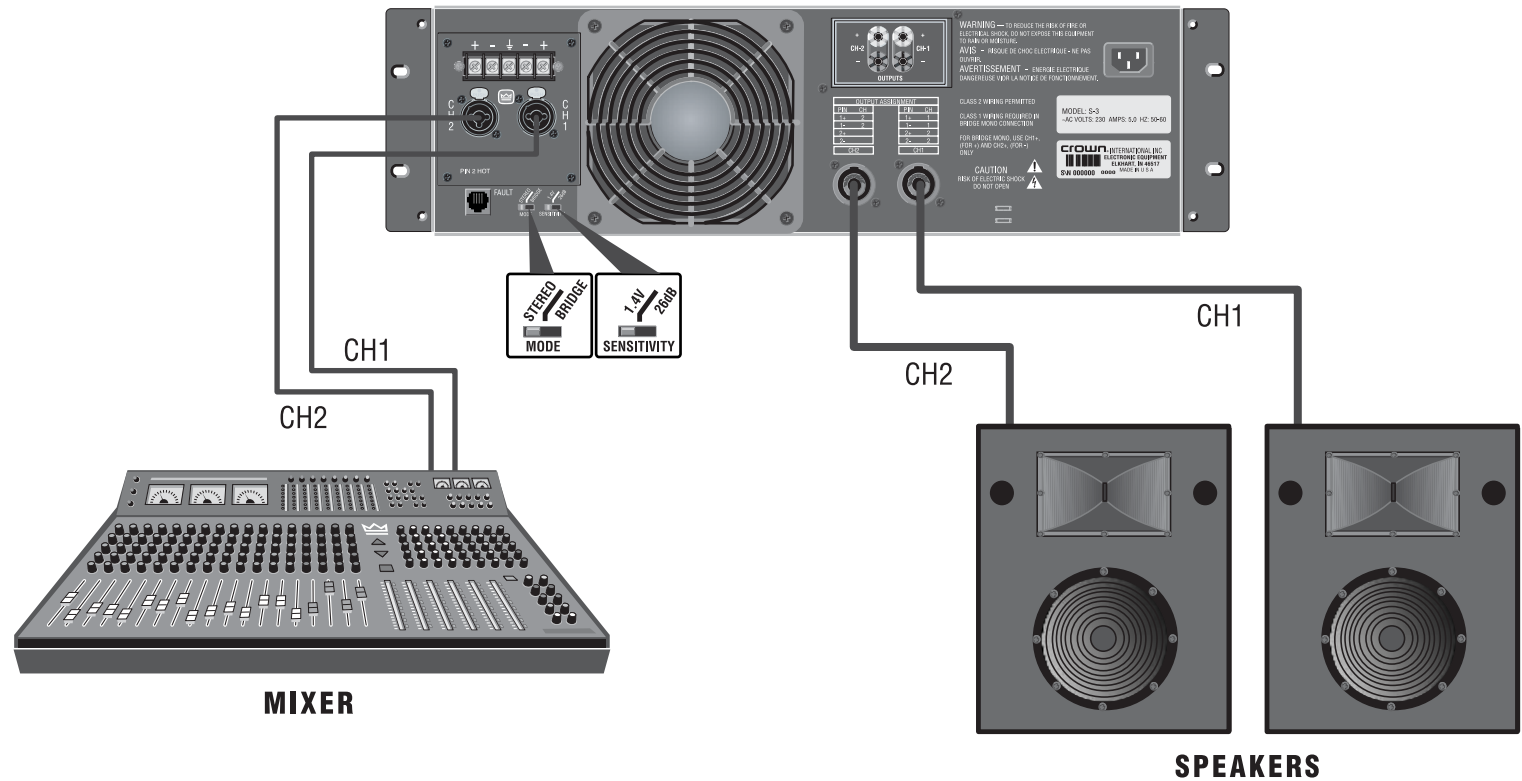

Figure 2.9 Typical System Wiring, Stereo Mode

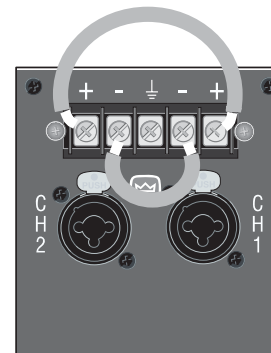

Figure 2.10 Jumper Placement to Parallel the Inputs

2 Setup

2.6.3 Bridge-Mono Mode

Make sure the amplifier is turned off and the level controls are turned down before you wire the system.

Typical input and output wiring is shown in Figure 2.11.

INPUTS: Connect input wiring to CH 1.

OUTPUTS: Connect the speaker across the positive (+) output terminals. Do not use the negative (-) terminals when the amplifier is being operated in Bridge-Mono mode. Refer to Section 2.5 for output connector pin assignments. Make sure the Mode switch is set to the "Bridge" position when operating in Bridge-Mono mode.

NOTE: Turn down (full CCW) the Channel 2 level control when operating the channel pair in Bridge-Mono mode, as the Channel 1 level control works both channels.

NOTE: Crown provides a reference of wiring pin assignments for commonly used connector types in the *Crown Amplifier Application Guide* available at www.crownaudio.com.

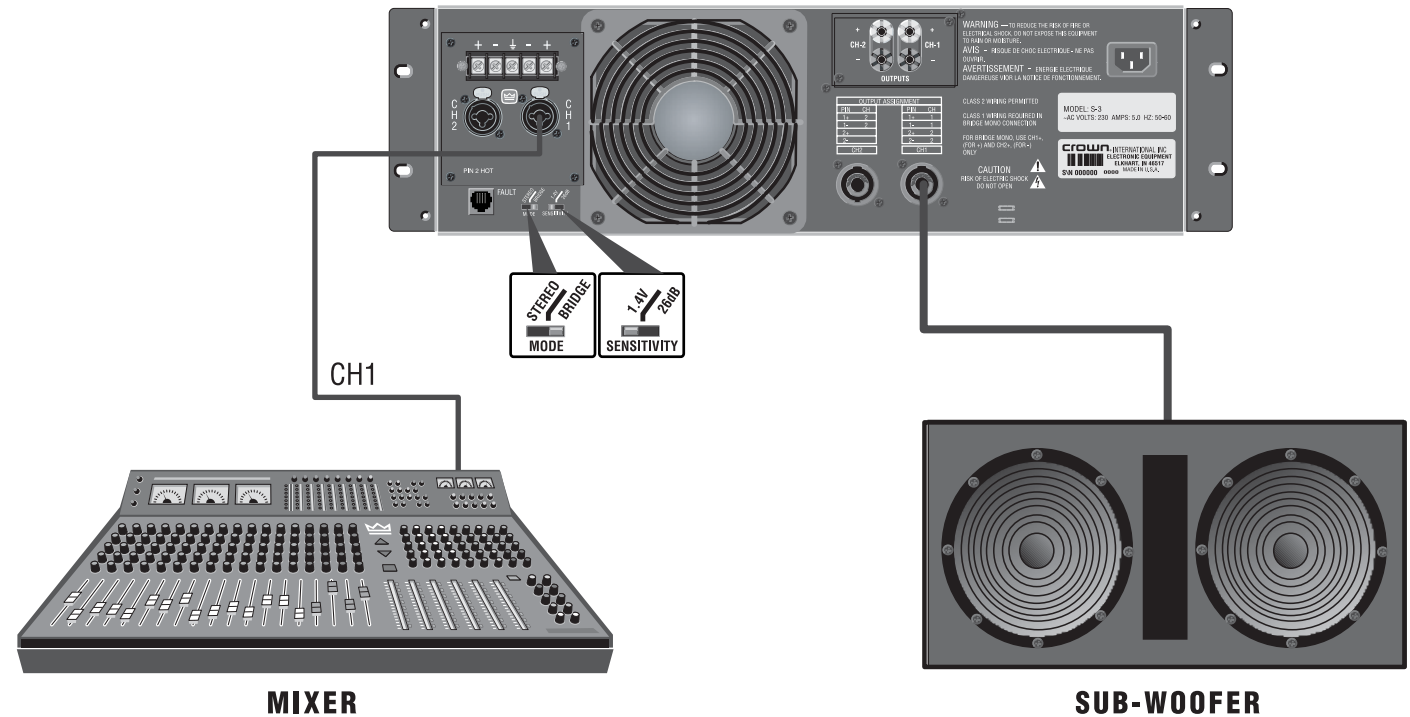

Figure 2.11 Typical System Wiring, Bridge-Mono Mode

2 Setup

2.7 Input Sensitivity Switch

A two-position Input Sensitivity switch is located on the back panel near the input connectors (Figure 2.12). Your amplifier is shipped from the factory with this switch set to the 1.4V position. At this setting, a 1.4V input signal will drive the amplifier to full power into an 8-ohm load when the level controls are turned to maximum. This setting works best when the amplifier is being driven by equipment with a +4 dBu output — an output level at which most professional equipment operates.

If required, the Input Sensitivity switch can be moved to the 26-dB position, so that the amplifier provides a fixed voltage gain of 20 (or 26 dB: 1 volt in, 20 volts out). This setting works best with output levels of +10 dBu (2.5 volts RMS) or more. Some brands of DJ mixers, in particular, have output levels in this range.

Selecting the correct sensitivity will allow your equipment to operate at its optimum level and improve the signal-to-noise of the system.



Make sure the amplifier is turned off and the level controls are turned down before you change the switch setting.

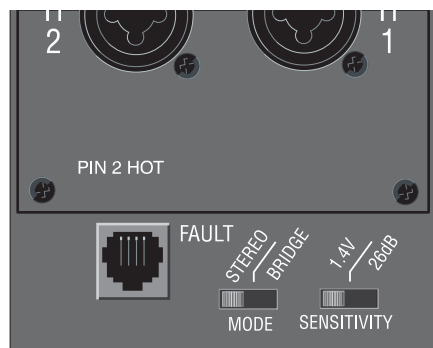

Sensitivity Switch

Figure 2.12 Location of Input Sensitivity Switch

2.8 Connect to AC Mains

Connect your amplifier to the AC mains power source (power outlet) with the supplied AC power cordset. First, connect the IEC end of the cordset to the IEC connector on the amplifier; then, plug the other end of the cordset to the AC mains.

WARNING: The third prong of this connector (ground) is an important safety feature. Do not attempt to disable this ground connection by using an adapter or other methods.



Amplifiers don't create energy. The AC mains voltage and current must be sufficient to deliver the power you expect. You must operate your amplifier from an AC mains power source with not more than 10% variation above or below the amplifier's specified line voltage and within the specified frequency requirements (indicated on the amplifier's back panel label). If you are unsure of the output voltage of your AC mains, please consult your electrician.

2.9 Startup Procedure

Use the following procedure when first turning on your amplifier:

1. Turn down the level of your audio source.
2. Turn down the level controls of the amplifier.
3. Turn on the "Power" switch. The Power indicator should glow.
4. Turn up the level of your audio source to an optimum level.
5. Turn up the Level controls on the amplifier until the desired loudness or power level is achieved.
6. Turn down the level of your audio source to its normal range.

If you ever need to make any wiring or installation changes, don't forget to disconnect the power cord.

For help with determining your system's optimum gain structure (signal levels) please refer to the *Crown Amplifier Application Guide*, available online at www.crownaudio.com.

3 Operation

3.1 Precautions

Your amplifier is protected from internal and external faults, but you should still take the following precautions for optimum performance and safety:

1. Before use, your amplifier first must be configured for proper operation, including input and output wiring hookup. Improper wiring can result in serious operating difficulties. For information on wiring and configuration, please consult the Setup section of this manual or, for advanced setup techniques, consult Crown's *Amplifier Application Guide* available online at www.crownaudio.com.
2. Use care when making connections, selecting signal sources and controlling the output level. The load you save may be your own!
3. Do not short the ground lead of an output cable to the input signal ground. This may form a ground loop and cause oscillations.

4. **WARNING: Never connect the output to a power supply, battery or power main. Electrical shock may result.**



5. Tampering with the circuitry, or making unauthorized circuit changes may be hazardous and invalidates all agency listings.
6. Do not operate the amplifier with the red Clip LEDs constantly flashing.
7. Do not overdrive the mixer, which will cause clipped signal to be sent to the amplifier. Such signals will be reproduced with extreme accuracy, and loudspeaker damage may result.
8. Do not operate the amplifier with less than the rated load impedance. Due to the amplifier's output protection, such a configuration may result in premature clipping and speaker damage.

Remember: Crown is not liable for damage that results from overdriving other system components.

3 Operation

3.2 Controls, Indicators and Connectors

Figure 3.1
Controls,
Indicators &
Connectors

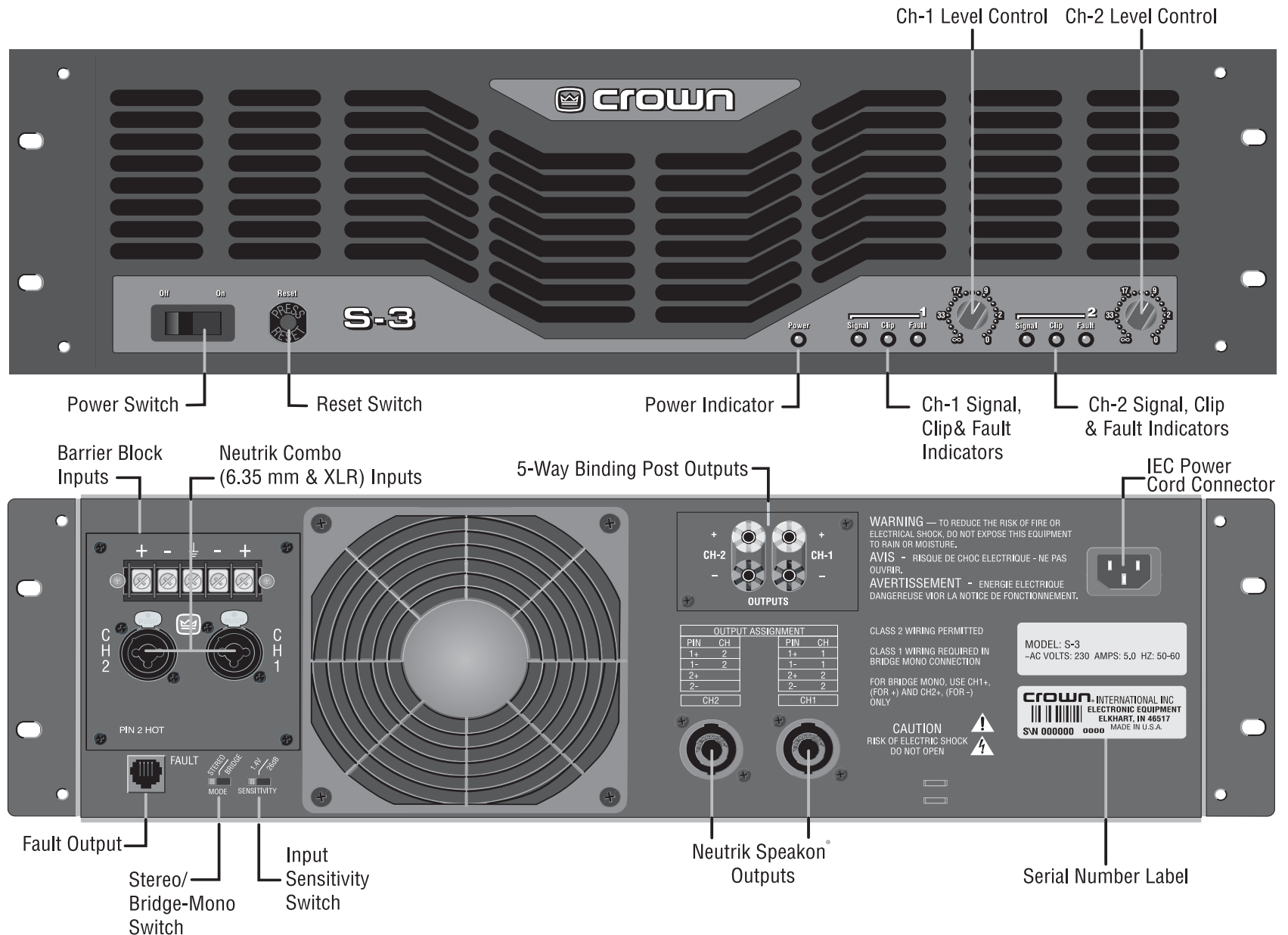

3 Operation

3.3 Front Panel Controls and Indicators

Power Switch

The power switch turns the amplifier on or off.



Note that dangerous voltages may still be present in the amplifier even when the power switch is in the off position. Before moving the amplifier or making any wiring or installation changes, it is important to also disconnect the power cord from the amplifier or power source.

Reset Switch

The push-button reset switch is used to reset the circuit breaker that protects the power supply.

Fault Indicators

Two red LEDs (one for each channel) are located on the front panel. The Fault Indicators are normally OFF, but will blink under five different conditions:

1. When the amplifier is first powered up, until the unit is ready for operation.
2. If the heatsinks reach a temperature above normal working limits.
3. If the transformer thermal protection circuit is activated.
4. If the amplifier output wires develop a short-circuit.
5. If the amplifier output stage stops operating.

The fault status of the amplifier can also be monitored remotely by attaching a signalling device to the Fault jack located on the amplifier back panel. See Section 4.2.2 in this manual for more informa-

tion on fault monitoring and suggestions for signalling device circuitry.

Some fault conditions may cause the output of the amplifier to be muted.

Clip Indicators

These are two red LEDs (one per channel). The Clip Indicator turns on when distortion is audible in the amplifier output.

Signal Indicators

These are two green LEDs (one per channel). The Signal Indicator illuminates when a signal (> -40 dBm) is present at the INPUT of the amplifier for that channel. Because these indicators receive the signal before the level controls, they can be used to troubleshoot wiring problems within a system. If the Signal indicator for a channel is not lit, no signal is reaching the amplifier on that channel.

Power Indicator

The green Power indicator lights when your S-Series amp has been turned on and has power.

Level Controls

Two rotary detented Level controls (one for each channel) are used to adjust each channel's output.

If you wish, the level control knobs may be pulled from the front panel and the holes plugged with the supplied caps to minimize tampering of control settings.

3.4 Back Panel Controls and Connectors

Input Sensitivity Switch

This two-position Input Sensitivity switch is located near the input connectors. It lets you select between 1.4 V input sensitivity or 26 dB gain. Please see Section 2.7 in this manual for details.

Mode Switch

This two-position switch selects either Stereo or Bridge-Mono mode of operation. Stereo mode provides identical power output to each of the two amplifier output channels. Bridge-Mono mode combines the two amplifier output channels into a single mono channel with twice the voltage of a single stereo channel.

Do NOT select Bridge-Mono mode without first making sure the amplifier has been wired in a Bridge-Mono configuration. For more information on wiring for Bridge-Mono mode, see Section 2.6.2.

Fault Jack

This is an RJ-11 jack (which looks like a telephone jack). By attaching a signaling device to the Fault jack, you can monitor the amplifier's Fault status from a remote location. See Section 4.2.2 for more information on fault monitoring.

Barrier Block Inputs

For each channel, this row of screw terminals provides a balanced input, which is in parallel with the channel's Combo input connector.

Neutrik Combo Input

One per channel, this combination 1/4-inch phone jack and XLR connector provides a balanced or unbalanced input.

Neutrik Speakon® Output

One per channel, this Neutrik Speakon® connector with four terminals connects to loudspeakers.

4 Advanced Features and Options

NOTE: For detailed information about these Crown amplifier features, please consult the *Crown Amplifier Application Guide*, available on the Crown website at www.crownaudio.com.

4.1 Protection Systems

S-Series amplifiers are protected against shorted, open or mismatched loads; overloaded power supplies; excessive temperature; chain destruction phenomena; input overload damage; and high-frequency blowups. They also protect loudspeakers from input/output DC, large or dangerous DC offsets and turn-on/turn-off transients.

4.1.1 Bias Servo

Bias servo translates the output heatsink temperature to controlled bias current. This prevents thermal runaway and holds the amplifier's notch distortion to a minimum.

4.1.2 Fault

The amplifier will light the Fault LED on the front panel if the amplifier output stage stops operating. If this happens, take the unit to an authorized Crown Service Center.

4.1.3 Ultrasonic and Radio Frequency Protection

An amplifier's slew rate only needs to be large enough to deliver the maximum voltage at the highest required frequency. Higher slew rates actually let the amplifier reproduce undesirable frequencies. By design, the S-Series amplifiers have a controlled slew rate to put a frequency limit on the highest frequencies that they reproduce. This limit occurs well above 20 kHz, so there is no audible effect on performance.

This approach protects the amplifier from radio frequencies and can even protect some sensitive loads (including some tweeters).

4.1.4 Drive Protection

This system temporarily removes output drive to protect the amplifier and its loads. Drive protection can be activated in two situations. First, if dangerous subsonic frequencies or direct current (DC) is detected in the amplifier's output, drive protection will activate. The amplifier resumes normal operation when it no longer detects dangerous output. Activating this protection is very unlikely, but improper source signals like infrasonic square waves or a severely clipped input signal can activate this system.

Second, the amplifier's fault protection system puts the affected channel into drive protection mode in rare situations where heavy common-mode current is detected in its output. The amplifier should never output heavy common-mode current unless its circuitry is damaged. Activating drive protection helps prevent further damage.

4.1.5 Compression

A full-time compressor is in-line with the signal, reducing the risk of damage to your speakers.

4.1.6 Power Circuit Breaker

A front panel push button is used to reset the circuit breaker that protects the power supply.

4.1.7 Proportional-speed Fan

The speed of the cooling fan is controlled by the transformer temperature and the heatsink temperature.

4.2 Advanced Features

4.2.1 Crown SST Modules

Crown optional SST (System Solution Topologies) modules were specially designed to improve the fidelity and versatility of your audio system. They feature a variety of professional signal routing and filtering capabilities, with active crossovers that allow the audio signal to be split and sent to auxiliary amplifiers. Your amplifier may have come with an SST module already factory-installed, or your choice of SST modules can be easily added to the amplifier by any authorized Crown Service Center.

For information on wiring and configuration of amplifiers equipped with an optional Crown SST crossover module, please refer to the *SST Crossover Reference Manual* included in your literature package.

Refer to the following descriptions for an overview of available Crown SST crossover modules. Crown plans to release additional accessory plug-in modules offering a range of advanced features and capabilities. Watch for new releases:

4 Advanced Features and Options

SST-SBSC-3632T

This is a custom three-channel crossover network with CD-horn equalization and summed low-frequency output specifically designed for use with JBL® model 3632T ScreenArray® cinema speaker systems installed in cinemas, studio production and post-production environments.

Features:

- High-frequency signals are internally routed to the channel-one amplifier input, and mid-frequency signals are routed to the channel-two amplifier input.
- Mono summing of low-frequency signals are routed from Output B to an external amplifier.
- Neutrik® Combo jacks for balanced input connection.
- Removable barrier block connectors for balanced output to other components.

SST-SBSC 4632T

Like the SST-SBSC 3632T but for the JBL 4632T cinema speakers.

SST-4622

See Figure 4.1. This is a custom two-channel crossover network with equalization specifically designed for use with JBL® model 4622 ScreenArray® cinema speaker systems installed in cinemas, studio production and post-production environments.

Features include:

- Low-frequency signals are internally routed to the channel-1 amplifier input, and high-frequency signals are routed to the channel-2 amplifier input.
- Barrier block connectors for balanced signal input.

SST-3632

Like the SST-4622 but for the JBL 3632 cinema speaker systems.

Additional features include:

- Time correction via an all-pass analog delay ensures coherent summation through the crossover region, while maintaining optimal vertical polar response.

SST-4632

Like the SST-3632 but for the JBL 4632 cinema speaker systems.

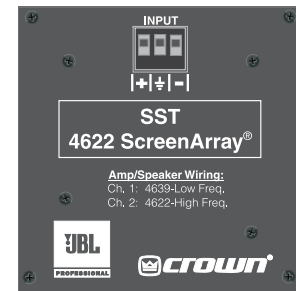

Figure 4.1
SST-4622 Crossover Network

4 Advanced Features and Options

4.2.2 Fault Monitoring

The Fault (RJ-11) jack, which looks like a telephone jack, is located on the back of your S-Series amplifier (Figure 4.2). It gives you an easy way to remotely monitor the amplifier's fault status. To set up a circuit that will cause an LED to light whenever a fault status occurs, you can simply use the suggested circuit shown in Figure 4.3.

When using this circuit, the LED will glow under any of these conditions:

- The amplifier has just been turned on and is still in the 4-second turn-on delay.
 - The heatsinks are too hot.
 - The transformer thermal protection is activated.
 - The amplifier output wires have developed a short circuit.
 - The limiter has been overdriven by > 6 dB for a long time.
 - The amplifier output stage has stopped operating.
- Refer the unit to an authorized Crown Service Center.
- The amplifier is turned off.

If you choose to design your own circuit to interface this signal to your system, note that this RJ jack is polarity sensitive. Pin 2 must be grounded, and Pin 5 must be supplied with a positive voltage pull-up (positive with respect to ground). Refer to Figure 4.4 for RJ jack pin assignments. The maximum signal that can be exposed to the Fault jack is 35VDC and 10 mA. Best results are obtained with 10 mA LEDs.

The mating connector for the S-Series TX RJ-11 jack contains 4 contact pins in a 6-slot case, as shown. For additional information please contact your local dealer or Crown Technical Support.

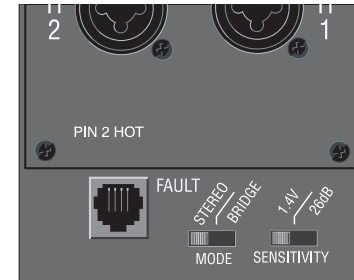

Figure 4.2 Location of Fault Jack

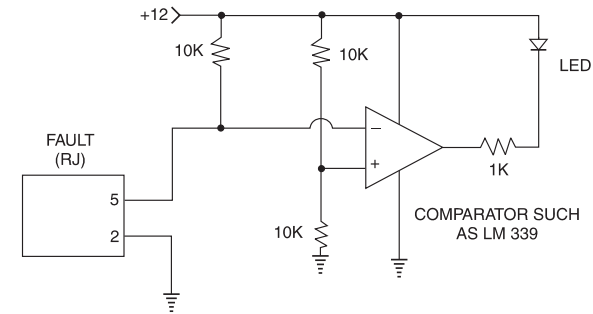

Figure 4.3 Fault Status LED Circuitry

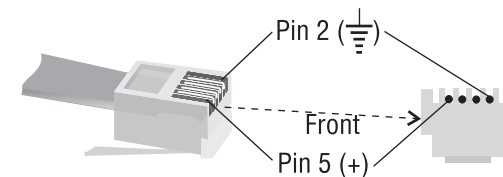

Figure 4.4 RJ-11 Jack Wiring and Pin Assignments

4 Advanced Features and Options

4.3 Options

4.3.1 Accessories

CE HANDLES

Handles complement your amplifier's appearance, aid in transportation, and facilitate rack mounting and removal. They are available from Crown's Sales Department; just ask for "CE Handles."

4.3.2 Alternate Output Connectors

For added system flexibility, Crown offers optional secondary output connectors.

You have a choice of either the CEAS1 barrier block (see Figure 4.5) or the CEAS2 5-way binding post connectors (see Figure 4.6). Alternate output connectors may come factory installed on new amplifier orders. They can also be added to existing S-Series amplifiers by an authorized Crown Service Center. For more information, please contact Crown Technical Support.

4.3.3 Tamper-Resistant Hole Plugs

Your S-Series amplifier comes with a set of tamper-resistant hole plugs, which allow you to "protect" the level controls against unauthorized adjustment.

To use, simply pull off the control knobs from the front of the amp, and slip the hole plugs into place (see Figure 4.7). The plugs should press easily into position with light force. Once in place, the plugs will help to avoid most accidental or intentional tampering (some situations may require additional security measures).

To remove the hole plugs, simply pry the plug away from the amplifier case using a small, flat-blade screwdriver. To help to ensure adequate security, the plugs have been designed to be more difficult to remove than to place into position. If necessary, additional hole plugs can be purchased separately from Crown's Parts Department (Part # 103234-1).

Store your knobs in a safe location should you need to make level adjustments in the future.

4.3.4 Optional 0.775 V Input Sensitivity Setting

The S-Series amplifier also provides an optional 0.775 V input sensitivity setting. If you determine that your application requires this sensitivity setting, please contact Crown Technical Support for more information.

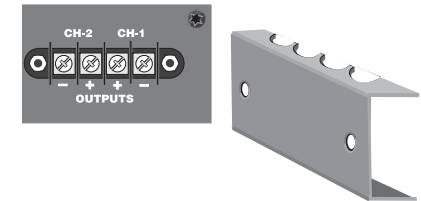

Figure 4.5 Model CEAS1 Barrier Block Output Connectors

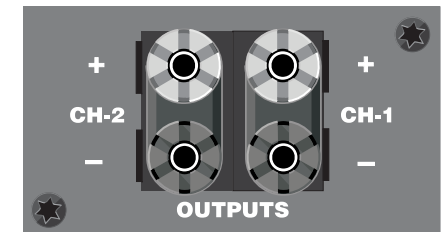

Figure 4.6 Model CEAS2 5-way Binding Post Output Connectors

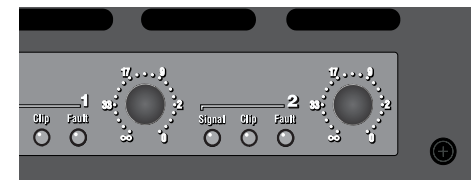

Figure 4.7 Tamper-Resistant Hole Plugs Installed in an S-Series Amplifier

5 Principles of Operation

For the sake of simplicity, only channel one of the amplifier is described.

Signal is presented to the S amplifier through one of three connectors when using the standard input module. Each channel is outfitted with a balanced XLR/phone jack and a barrier strip. These connectors are wired in parallel, which allows daisy chaining when needed. The signal is then converted from balanced to unbalanced in the Balanced Input Stage where it also receives RFI protection. Signal then flows into the Variable Gain Stage where the front panel level controls are allowed to affect the gain.

Following this stage, the signal is put under the control of a full-time compressor circuit comprised of a symmetrical window detector, a buffer amplifier, and the gating op amp which uses several small components to set the compressor's attack and decay characteristics. The actual compressing is accomplished by an opto-isolator which affects the gain in the signal path.

Next the signal enters the error amplifier circuit, where it is mixed with a small portion of the output signal in such a way as to control the amplifier's overall output performance.

Following the error amp is the LVA stage, which is where the low-voltage referenced signal gets translated to the output high-voltage rails. The last voltage amplifier, in conjunction with a bootstrap current source, drives both predrivers and the bias servo. The bias servo is mounted in such a way as to translate the output heatsink temperature into a controlled bias current to prevent thermal runaway and hold the amplifier's notch distortion to a minimum.

The predrivers provide enough signal to activate the drivers, which together operate in the class AB range. For the major output current requirements, the drivers feed the various numbers of paralleled output transistors which operate in a class B mode. This we call the Triple-Deep Darlington Output Stages.

The output transistors are protected by the Time Dependent Voltage & Current circuit. This circuit protects the devices from extending beyond their safe area of operation, but allows the devices to provide high bursts of peak power with music, allowing your amplifier to deliver more punch. This amplifier output topology offers a good combination of low quiescent amplifier heating, great distortion performance at high powers, and relative simplicity, with impressive reliability and value.

All output power is delivered through 4-circuit Speakon® connectors. These connectors have been wired in such a way as to allow you the most versatility. The Channel 1 and 2 connectors are cross wired so you can cover all options, from dual cable stereo (typical), to Bridge-Mono in one connector, to running a bi-amp speaker with one amplifier and one cable per speaker cabinet.

The output relay, in conjunction with input signal mute circuit, assures the amplifier will be well-behaved during turn on and off. In the event of an amplifier output failure, a triac will activate to turn off the offending channel and protect your speakers.

The turn on delay circuit functions to keep the output relay open until all the voltages are up and stable, both in the amplifier, and in all the components in the system ahead of the amplifier.

Heatsink temperature is monitored by a thermal probe attached to the heatsink. As the temperature rises, the probe sends a proportional current to the proportional speed fan circuit which starts the fan. Should the power transformer

reach its maximum safe temperature, an internal thermal switch opens and the fan circuit turns on full speed to quickly cool down the amplifier. It also disconnects the load via the output relay, removing any output current and further speeding a cool-down cycle. Extra care was taken during the design stage to set this point both to protect your investment and to guard against nuisance tripping.

Whenever the heatsinks or the transformer reach a maximum temperature, or during the normal turn-on delay window, the front panel Fault LEDs will blink to get your attention.

A modular jack is mounted on the back panel (same type as used on telephones). Pins 2 and 5 are connected to an opto-isolator which is always in a low-resistance state whenever the unit is on and functional. Should a fault be detected or should the amplifier lose AC power, the opto-isolator will change to a high resistance, allowing the user to remotely detect the status of the amplifier.

The Signal Presence Indicators tap the signal chain just before the level controls and prior to the power amplifier chain. They are *not* amplifier output indicators and should only be used to indicate the presence of signal to the amplifier front end.

The Clip light is driven from the output of the compressor circuitry and lights to indicate the onset of audible distortion.

The Power LED is driven from the low-voltage supply.





A positive and negative regulator form the ± 15 -volt power supplies. Add to that the main transformer, a full-wave bridge rectifier, and high energy electrolytic to form the main power supply. They are protected by the front-panel line circuit breaker and controlled by the front-panel power switch.

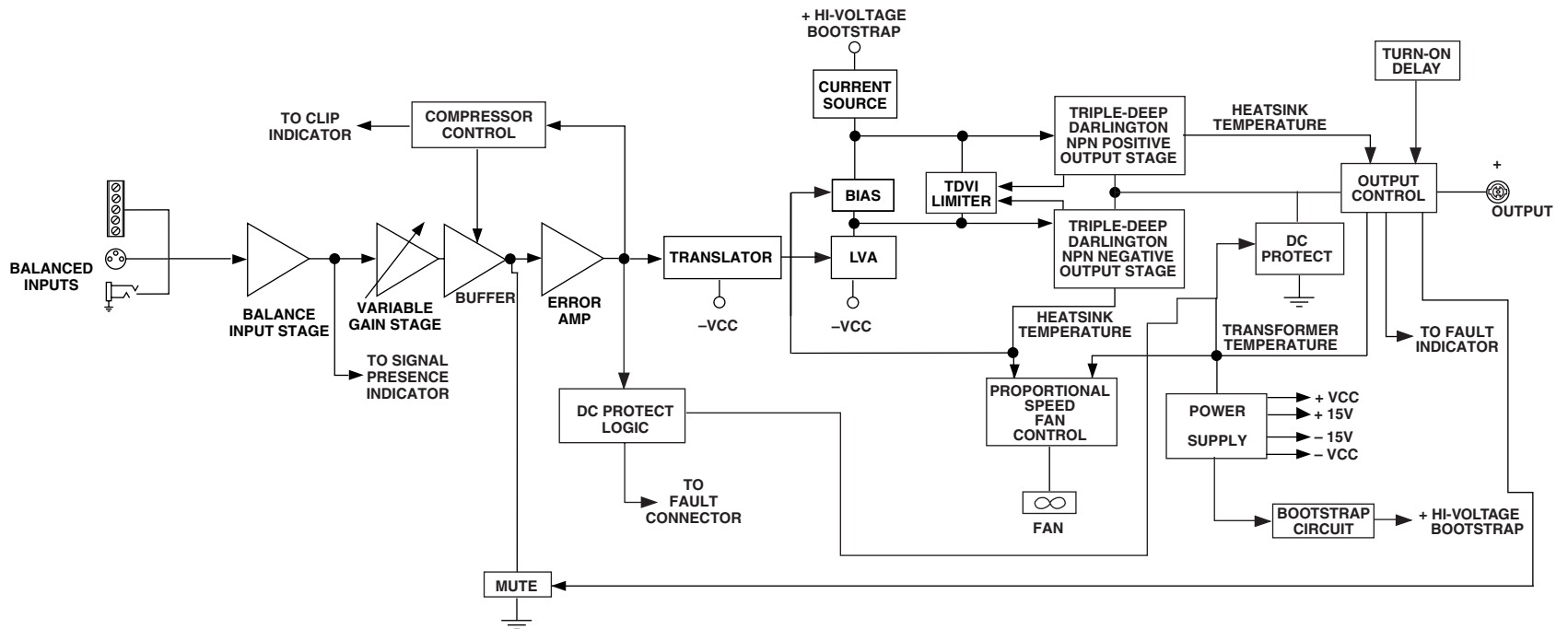



5 Principles of Operation





Figure 5.1
S-Series
Amplifier Block
Diagram
(Shown with
Standard Input
Module)











6 Troubleshooting



Power	Signal	Clip	Fault	CONDITION: Power indicator is off.
				<p>POSSIBLE REASON</p> <ul style="list-style-type: none"> The amplifier has lost AC power. The amplifier's Power switch is off. The amplifier's power cord is not plugged in at either end. The amplifier's circuit breaker has tripped. Allow the amplifier to cool, remove excessive loads, and press the reset switch on the front panel.

Power	Signal	Clip	Fault	CONDITION: Distorted sound.
				<p>POSSIBLE REASON:</p> <ul style="list-style-type: none"> Load is wired incorrectly or Stereo/Mono mode switch is set incorrectly. Check both. Input signal level is too high. Turn down your amplifier level controls, or turn down the input signal, until the clip LED goes out. <p>Note: If sound is distorted but clip LED is not flashing, check mixer levels and gain staging, mixer clip lights, and pads built into microphones.</p>

Power	Signal	Clip	Fault	CONDITION: No input signal (Signal indicator is not flashing even though audio is applied).
				<p>POSSIBLE REASON:</p> <ul style="list-style-type: none"> Input signal level is very low. Master audio from mixer turned down. Input cable broken or not plugged in. Front-panel Level controls are turned down.

Power	Signal	Clip	Fault	CONDITION: Input signal but no sound.
				<p>POSSIBLE REASON:</p> <ul style="list-style-type: none"> Speakers not connected. Make sure the Neutrik NL4 connector is fully seated and locked.

Power	Signal	Clip	Fault	CONDITION: Fault indicator is flashing.
				<p>POSSIBLE REASON:</p> <ul style="list-style-type: none"> The amplifier has just been turned on and is still in the 4-second turn-on delay. The heatsinks are too hot. The transformer thermal protection is activated. The amplifier output wires have developed a short circuit. The amplifier output stage has stopped operating. Refer the unit to an authorized Crown Service Center <p>The fault status of the amplifier can also be monitored remotely by attaching a signal device to the Fault jack located on the amplifier back panel. See Section 4.2.2 for more detail.</p>

Key		
		Lit
		Flashing
		Off

7 Specifications

Minimum Guaranteed Power	S-2	S-3
120 VAC, 60 Hz Units, Stereo mode, per channel, both channels driven		
1 kHz with < 0.5% THD		
2 ohms	560 W	975 W
4 ohms	450 W	660 W
8 ohms	275 W	400 W
120 VAC, 60 Hz Units, Bridge mono mode		
1 kHz with 0.1% THD		
4 ohms	1,100 W	1,950 W
8 ohms	900 W	1,320 W
Performance	S-2	S-3
Frequency Response (at 1 watt, 20Hz - 25 kHz)	± 0.2 dB	± 0.2 dB
Phase Response (at 1 watt, 20Hz - 20 kHz)	± 15°	± 15°
Signal to Noise Ratio below rated power (A weighted) (20 Hz to 20 kHz)	> 105 dB > 100 dB	> 105 dB > 100 dB
Total Harmonic Distortion (THD) at rated power, from 20 Hz to 20 kHz	0.5%	0.5%
Intermodulation Distortion (IMD) 60 Hz and 7 kHz at 4:1, from 163 milliwatts to full bandwidth power	< 0.1%	< 0.1%
Damping Factor: 10 Hz to 400 Hz	> 400	> 400
Crosstalk (below rated power, 20 Hz to 20 kHz)	> 55 dB	> 55 dB
Common Mode Rejection (CMR) (20 Hz to 1 kHz)	> 70 dB	> 70 dB
DC Output Offset (Shorted input)	±10 mV	±10 mV
Input Impedance nominally balanced, nominally unbalanced	20 k ohms, 10 k ohms	20 k ohms, 10 k ohms
Load Impedance (Note: safe with all types of loads)		
Stereo	2, 4 and 8 ohms	2, 4 and 8 ohms
Bridge Mono	4 and 8 ohms	4 and 8 ohms
Voltage Gain (at maximum level setting, to 1-kHz, 8-ohm rated output)		
26 dB setting	26 dB	26 dB
1.4V setting	30.5 dB	32.1 dB
Required AC Mains (configured country-specific)	50/60 Hz, 230 - 240 VAC (±10%)	50/60 Hz, 230- 240 VAC (±10%)
Power Draw at Idle	90 watts	90 watts
AC Line Connector	NEMA 5-15P (15A)	NEMA 5-15P (15A)
Cooling	Proportional speed fan	Proportional speed fan
Dimensions: Width, Height, Depth	EIA Standard 19 in. (48.3 cm) x 5.25 in. (13.34 cm) x 12.25 in. (31.11 cm)	EIA Standard 19 in. (48.3 cm) x 5.25 in. (13.34 cm) x 12.25 in. (31.11 cm)
Net Weight, Shipping Weight	14.79 kg, 17.49 kg	18.28 kg, 20.98 kg

8 Service

Crown amplifiers are quality units that rarely require servicing. Before returning your unit for service, please contact Crown Technical Support to verify the need for servicing.

This unit has very sophisticated circuitry which should only be serviced by a fully trained technician. This is one reason why each unit bears the following label:

CAUTION: To prevent electric shock, do not remove covers. No user serviceable parts inside. Refer servicing to a qualified technician.



Complete the Crown Audio Factory Service Information form, in the back of this manual, when returning a Crown product to the factory or authorized service center. The form must be included with your product inside the box or in a packing slip envelope securely attached to the outside of the shipping carton. Do not send this form separately.

8.1 International and Canada Service

Service may be obtained from an authorized service center. (Contact your local Crown/Amcron representative or our office for a list of authorized service centers.) To obtain service, simply present the bill of sale as proof of purchase along with the defective unit to an authorized service center. They will handle the necessary paperwork and repair.

Remember to transport your unit in the original factory pack.

8.2 US Service

Service may be obtained in one of two ways: from an authorized service center or from the factory. You may choose either. It is important that you have your copy of the bill of sale as your proof of purchase.

8.2.1 Service at a US Service Center

This method usually saves the most time and effort. Simply present your bill of sale along with the defective unit to an authorized service center to obtain service. They will handle the necessary paperwork and repair. Remember to transport the unit in the original factory pack. A list of authorized service centers in your area can be obtained from Crown Factory Service, or online from <http://www.crownaudio.com/support/servcent.htm>.

8.2.2 Factory Service

Crown accepts no responsibility for non-serviceable product that is sent to us for factory repair. It is the owner's responsibility to ensure that their product is serviceable prior to sending it to the factory. Serviceable product list is available at <http://crownweb.crownintl.com/crownrma/>. For more information, please contact us direct.

A Service Return Authorization (SRA) is required for product being sent to the factory for repair. An SRA can be completed online at www.crownaudio.com/support/factserv.htm. If you do not have access to the web, please call Crown's Customer Service at 574.294.8200 or 800.342.6939 extension 8205.

For warranty service, we will pay for ground shipping both ways in the United States. Contact Crown Customer Service to obtain prepaid shipping labels prior to sending the unit. Or, if you prefer, you may prepay the cost of shipping, and Crown will reimburse you. Send copies of the shipping receipts to Crown to receive reimbursement. Your repaired unit will be returned via UPS ground. Please contact us if other arrangements are required.

8.2.3 Factory Service Shipping Instructions:

1. Service Return Authorization (SRA) is required for product being sent to the factory for service. Please complete the SRA by going to www.crownaudio.com/support/factserv.htm. If you do not have access to our website, call 1.800.342.6939, extension 8205 and we'll create the SRA for you.
2. See packing instructions that follow.
3. Ship product to:
CROWN AUDIO FACTORY SERVICE
1718 W MISHAWKA RD.
ELKHART, IN 46517
4. Use a bold black marker and write the SRA number on three sides of the box.
5. Record the SRA number for future reference. The SRA number can be used to check the repair status.

8.2.4 Packing Instructions

Important: These instructions must be followed. If they are not followed, Crown Audio, Inc. assumes no responsibility for damaged goods and/or accessories that are sent with your unit.

1. Fill out and include the Crown Audio Factory Service Information sheet in the back of this manual.
2. Do not ship any accessories (manuals, cords, hardware, etc.) with your unit. These items are not needed to service your product. We will not be responsible for these items.
3. When shipping your Crown product, it is important that it has adequate protection. We recommend you use the original pack material when returning the product for repair. If you do not have the original box, please call Crown at 800.342.6939 or 574.294.8210 and order new pack material. See instructions for "foam-in-place" shipping pack. (Do not ship your unit in a wood or metal cabinet.)
4. If you provide your own shipping pack, the minimum recommended requirements for materials are as follows:

- a. 275 P.S.I. burst test, Double-Wall carton that allows for 2-inch solid Styrofoam on all six sides of unit or 3 inches of plastic bubble wrap on all six sides of unit.
- b. Securely seal the package with an adequate carton sealing tape.
- c. Do not use light boxes or "peanuts". Damage caused by poor packaging will not be covered under warranty.

Using your 'foam-in-place' shipping pack

Note: The foam-in-place packing is molded so that there is only one correct position for your product.

1. Open carton and lift center cushion leaving both end-cushions in place.
2. Carefully place your product with the product's front panel facing the same direction as arrows indicate.

3. Reset center cushion down over top of product's chassis. The foam-in-place packing was molded to accommodate different chassis depth sizes. If your product's chassis does not completely fill the foam-in-place cavity, you may use a soft but solid packing material (such as paper or bubble wrap) behind the chassis.
4. Enclose the completed Crown Audio Factory Service Information form (or securely attach it to the outside of carton) and re-seal the shipping pack with a sturdy carton sealing tape.

8.2.5 Estimate Approval

Approval of estimate must be given within 90 days after being notified by Crown Audio Inc. Units still in the possession of Crown after 90 days of the estimate will become the property of Crown Audio Inc.

8.2.6 Payment of Non-Warranty Repairs

Payment on out-of-warranty repairs must be received within 90 days of the repair date. Units unclaimed after 90 days become the property of Crown Audio Inc.

If you have any questions, please contact Crown Factory Service.

Crown Factory Service
1718 W. Mishawaka Rd.,
Elkhart, Indiana 46517 U.S.A.

Telephone:
574.294.8200
800.342.6939 (North America,
Puerto Rico, and Virgin Islands only)

Facsimile:
574.294.8301 (Technical Support)
574.294.8124 (Factory Service)

Internet:
<http://www.crownaudio.com>

9 Warranty



WORLDWIDE EXCEPT USA & CANADA

SUMMARY OF WARRANTY

Crown International, 1718 West Mishawaka Road, Elkhart, Indiana 46517-4095 U.S.A. warrants to you, the ORIGINAL PURCHASER and ANY SUBSEQUENT OWNER of each NEW Crown1 product, for a period of three (3) years from the date of purchase by the original purchaser (the "warranty period") that the new Crown product is free of defects in materials and workmanship, and we further warrant the new Crown product regardless of the reason for failure, except as excluded in this Warranty.

¹ Note: If your unit bears the name "Amcron," please substitute it for the name "Crown" in this warranty.

ITEMS EXCLUDED FROM THIS CROWN-WARRANTY

This Crown Warranty is in effect only for failure of a new Crown product which occurred within the Warranty Period. It does not cover any product which has been damaged because of any intentional misuse, accident, negligence, or loss which is covered under any of your insurance contracts. This Crown Warranty also does not extend to the new Crown product if the serial number has been defaced, altered, or removed.

WHAT THE WARRANTOR WILL DO

We will remedy any defect, regardless of the reason for failure (except as excluded), by repair, replacement, or refund. We may not elect refund

unless you agree, or unless we are unable to provide replacement, and repair is not practical or cannot be timely made. If a refund is elected, then you must make the defective or malfunctioning product available to us free and clear of all liens or other encumbrances. The refund will be equal to the actual purchase price, not including interest, insurance, closing costs, and other finance charges less a reasonable depreciation on the product from the date of original purchase. Warranty work can only be performed at our authorized service centers. We will remedy the defect and ship the product from the service center within a reasonable time after receipt of the defective product at our authorized service center.

HOW TO OBTAIN WARRANTY SERVICE

You must notify your local Crown importer of your need for warranty service within the warranty period. All components must be shipped in the original box. Corrective action will be taken within a reasonable time of the date of receipt of the defective product by our authorized service center. If the repairs made by our authorized service center are not satisfactory, notify our authorized service center immediately.

DISCLAIMER OF CONSEQUENTIAL AND INCIDENTAL DAMAGES

YOU ARE NOT ENTITLED TO RECOVER FROM US ANY INCIDENTAL DAMAGES RESULTING FROM ANY DEFECT IN THE NEW CROWN PRODUCT. THIS INCLUDES ANY DAMAGE TO ANOTHER PRODUCT OR PRODUCTS RESULTING FROM SUCH A DEFECT.

WARRANTY ALTERATIONS

No person has the authority to enlarge, amend, or modify this Crown Warranty. This Crown Warranty is not extended by the length of time which you are deprived of the use of the new Crown product. Repairs and replacement parts provided under the terms of this Crown Warranty shall carry only the unexpired portion of this Crown Warranty.

DESIGN CHANGES

We reserve the right to change the design of any product from time to time without notice and with no obligation to make corresponding changes in products previously manufactured.

LEGAL REMEDIES OF PURCHASER

No action to enforce this Crown Warranty shall be commenced after expiration of the warranty period.

THIS STATEMENT OF WARRANTY SUPERSEDES ANY OTHERS CONTAINED IN THIS MANUAL FOR CROWN PRODUCTS. 7/01

This page intentionally left blank.

This page intentionally left blank.



Crown Audio Factory Service Information

Shipping Address: Crown Audio Factory Service, 1718 W. Mishawaka Rd., Elkhart, IN 46517

PLEASE PRINT CLEARLY

SRA #: _____ (If sending product to Crown factory service.) Model: _____ Serial Number: _____ Purchase Date: _____

PRODUCT RETURN INFORMATION

Individual or Business Name: _____

Phone #: _____ Fax #: _____ E-Mail: _____

Street Address (please, no P.O. Boxes): _____

City: _____ State/Prov: _____ Postal Code: _____ Country: _____

Nature of problem: _____

Other equipment in your system: _____

If warranty is expired, please provide method of payment. Proof of purchase may be required to validate warranty.

PAYMENT OPTIONS

I have open account payment terms. Purchase order required. PO#: _____ COD

Credit Card (Information below is required; however if you do not want to provide this information at this time, we will contact you when your unit is repaired for the information.)

Credit card information:

Type of credit card: MasterCard Visa American Express Discover

Type of credit card account: Personal/Consumer Business/Corporate

Card # _____ Exp. date: _____ * Card ID #: _____

* Card ID # is located on the back of the card following the credit card #, in the signature area. On American Express, it may be located on the front of the card. This number is required to process the charge to your account. If you do not want to provide it at this time, we will call you to obtain this number when the repair of your unit is complete.

Name on credit card: _____

Billing address of credit card: _____



H A Harman International Company