

MACRO REFERENCE

Owner's Manual

Contents

Welcome	1
Features	2
Controls & Indicators	5
Controls & Connectors	6
Installation	7
Cooling	7
Wiring	8
Stereo	8
Bridged-Mono	9
Parallel-Mono	10
Input Connection	11
Solving Input Problems	11
Output Connection	13
How to Determine Appropriate Wire Gauge	14
Solving Output Problems	15
Load Protection	16
AC Mains Power Requirements	16
Operation	17
Precautions	17
Indicators	18
How <i>ODEP</i> Works	18
Controls	20
Filter Cleaning	22
Service	23
Service at a Crown Service Center	23
Crown Factory Service	23
Technical Excellence	25
Circuit Theory	26
Stereo Operation	26
Bridged-Mono Operation	28
Parallel-Mono Operation	29
Specifications	30
Accessory <i>P.I.P.</i> Modules	32
Index	34

Illustrations

Front Controls & Indicators	5
Rear Controls & Connectors	6
Rack Cabinet Air Flow	7
Auxiliary Cooling	7
Mounting Dimensions	7
Stereo Mode Wiring	8
Bridged-Mono Mode Wiring	9
Parallel-Mono Mode Wiring	10
Subsonic Filter Capacitors	11
Unbalanced RF Filters	12
Balanced RF Filters	12
AWG Resistance Table	14
Loudspeaker Fuse Nomograph	16
Indicators	18
Dynamic Range / Level Meter Switch	21
Sensitivity & Ground Lift Switch	21
Circuit Block Diagram	24
<i>P.I.P.</i> Installation	32

MACRO REFERENCE

Welcome

The stunning realism of the Macro Reference attests to its technical excellence. With a dynamic range so large it surpasses the limitations of 20-bit digital audio, this amp cruises while the rest of your audio components catch their breath.

At the heart of the Macro Reference is an ultimately damped, high-excursion circuit design so advanced it can adapt to match the instantaneous demands of the audio signal. It has the highest dynamic transfer function available, allowing your ears and your loudspeakers to relax. It is the closest thing to a “straight wire with gain” ever created.

Superior motion control of your loudspeakers is achieved with ultimately damped outputs so you hear deeper, tighter bass than you’ve ever heard before. Low-frequency transient response must be heard to be fully appreciated.

Great care has been taken with the routing of each wire, the layout of each circuit board, and the selection of each component. As a result, its sonic integrity is without peer.

This manual is dedicated to helping you enjoy your Macro Reference to the fullest. The next three pages will peek under the hood at some of its distinguishing and unconventional technology. Pages 5-6 provide an overview of the controls, indicators and connectors. The installation instructions begin on page 7.

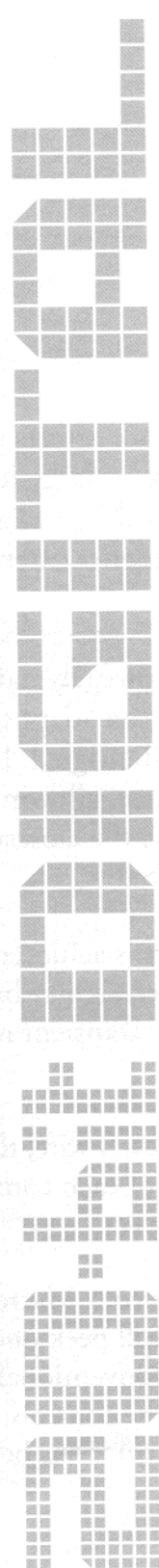

Features

20-bit Dynamic Range

In the early days of digital recording when 16-bit audio was the norm, a power amplifier only had to reproduce a signal with a dynamic range of 96 dB. Today, with the coming of 20-bit digital technology, that dynamic range has increased to 120 dB!

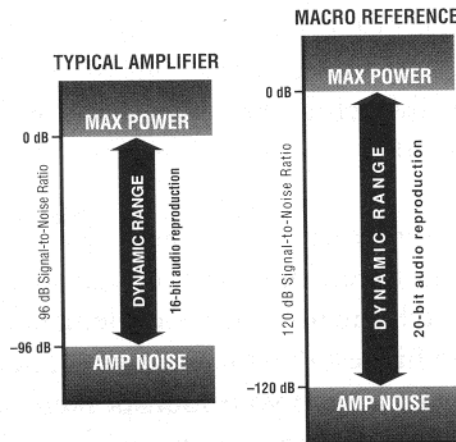

By pushing the noise floor lower and the maximum power ceiling higher, the Macro Reference exceeds this need with over 120 dB of dynamic range.

Ultimate Damping

Damping is the ability to quiet unwanted loudspeaker cone movement. It is similar to the damping your shock absorbers provide when you drive your car over a rough road. Damping is essential to good transient response—especially at low frequencies. Ideally, a properly damped loudspeaker cone will stop moving the instant the

signal stops. The sound waves it creates should exactly match the waveform of the original signal.

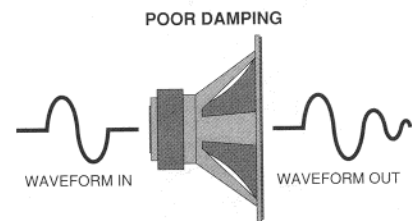
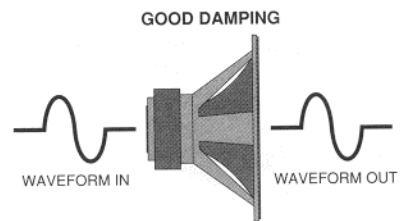

An underdamped loudspeaker cone continues to move after the signal has stopped, muddying transient response.

An amplifier's damping factor tells how well it can damp a loudspeaker. It is calculated by dividing the loudspeaker impedance by the amplifier's output impedance. With an 8 ohm loudspeaker, the Macro Reference has a phenomenal low-frequency damping factor of over 20,000! The result: razor-sharp bass unlike anything you have ever experienced.

Magnetic Field Efficiency

The backbone of a solid power amplifier is a solid power supply. The Macro Reference uses a custom designed, tape-wound, low-noise toroidal supply with

an extremely high power density. Toroids, known for their tight regulation and low external electromagnetic fields, also provide superior efficiency and are mechanically quieter.

Built-In Distortion Meter

It's one thing to claim low distortion on a test bench and another thing to claim it in the real world. That's one reason why your Macro Reference includes a sophisticated built-in distortion meter—to prove its claim. We call it an *IOC*[®] circuit because it is an Input/Output Comparator. It tirelessly compares the waveform of the input signal to the waveform of the output signal and if it finds a variation of 0.05% or more, it flashes the *IOC* indicator of the offending channel.

IOC



The *IOC* indicators also help you find the source of distortion by showing you where it is *not*—not in your Macro Reference.

High Energy Reserves

With its high voltage and high current headroom, the Macro Reference has phenomenal energy reserves. And because it can sustain high current as well

as high voltage output, it can easily drive even low-impedance loads to full power.

High Excursion Control

Many modern woofers can take far more peak power than most amplifiers can produce. Without adequate power, these loudspeakers cannot achieve full excursion and low-frequency output suffers.

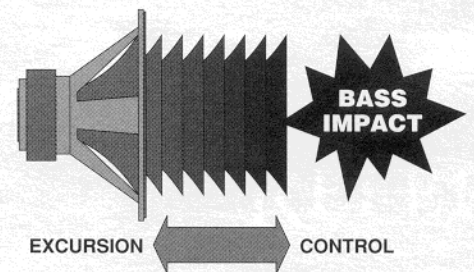

The Macro Reference has a massive power rating of 760 watts/channel into 8 Ω —enough muscle for very serious loudspeaker excursion control. The result: outstanding bass impact!

Unparalleled Protection

If an amplifier has any protection circuitry, it usually uses a current limiting scheme or V-I limiting like we patented in the 1960s with our famous DC-300. Such schemes are not suitable for an amplifier with the performance of the Macro Reference.

It uses the most advanced version of our Output Device Emulator Protection (*ODEP*[™])

circuitry. With it, the real-time operating environment of the power transistors is simulated and compared to their known safe operating area. Even their stress history is analyzed. If *ODEP* predicts they are about to exceed their limits, their drive level is proportionally reduced. You get maximum power with maximum protection!

ODEP



ODEP indicators, normally on, show normal operation. They dim in the rare event protection limiting is required.

Very Flexible

Rarely are two amplifiers used alike. Some require crossover networks; others use custom equalization; still others use state-of-the-art error-driven compressors.

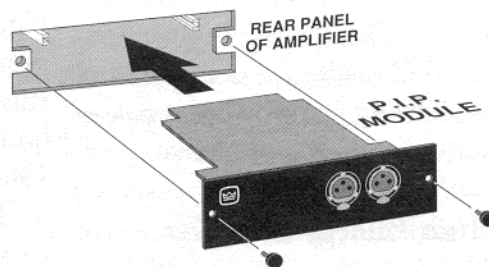

That's why your Macro Reference features a unique Programmable Input Processor (*P.I.P.*[®]) expansion system. It lets you add

P.I.P. modules to accomplish this and more. Like remote computer control, error-driven limiting, or, as standards are established, digital-to-analog conversion (see also pages 32-33).

Infinitely Variable Cooling

Heat is one of an amplifier's worst enemies. That's why the Macro Reference contains the most advanced cooling system available in a power amp.

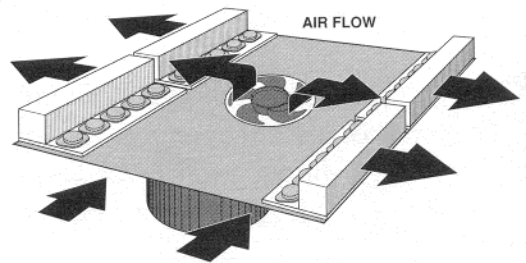

A patented design enables all output transistors to be mounted directly on electrically live thermal diffusers for maximum heat transfer. When necessary, this conduction/convection cooling is assisted by an infinitely-variable-speed fan. It draws air across the power transformer and main circuit board and pushes it across the power transistors and out the super-efficient diffuser exhaust vents. Careful engineering allows it to operation very quietly in critical-listening environments. It turns on only when needed and only to the degree necessary.

Controls & Indicators

1 LEVEL Control

The level of each channel is controlled by the convenient level controls mounted on the front panel. Each one has 31 detents for precise adjustment.

2 ODEP Indicator

The ODEP indicators glow brightly to confirm the normal operation of the Output Device Emulator Protection circuitry and the presence of reserve thermal-dynamic energy. In the rare event there is no reserve,

they dim in proportion to ODEP limiting. Under such conditions the output stages are protected by proportionally limiting their drive level so the amplifier can continue to operate safely even when the operating conditions are severe.

3 IOC Indicator

The total distortion level of each channel is monitored by the Intermediate Output Comparator. If distortion of any kind exceeds 0.05%, the indicator of the

affected channel(s) will flash.

Note: It is normal for the IOC indicator of Channel 2 to remain on when the amplifier is placed in Parallel-Mono mode. (See page 10 for further details.)

4 SIGNAL Presence Indicator

The presence of an audio signal is confirmed by the Signal indicators. Each one flashes in sync with the input signal. *Note: The Signal indicators may not flash if the input level is low.*

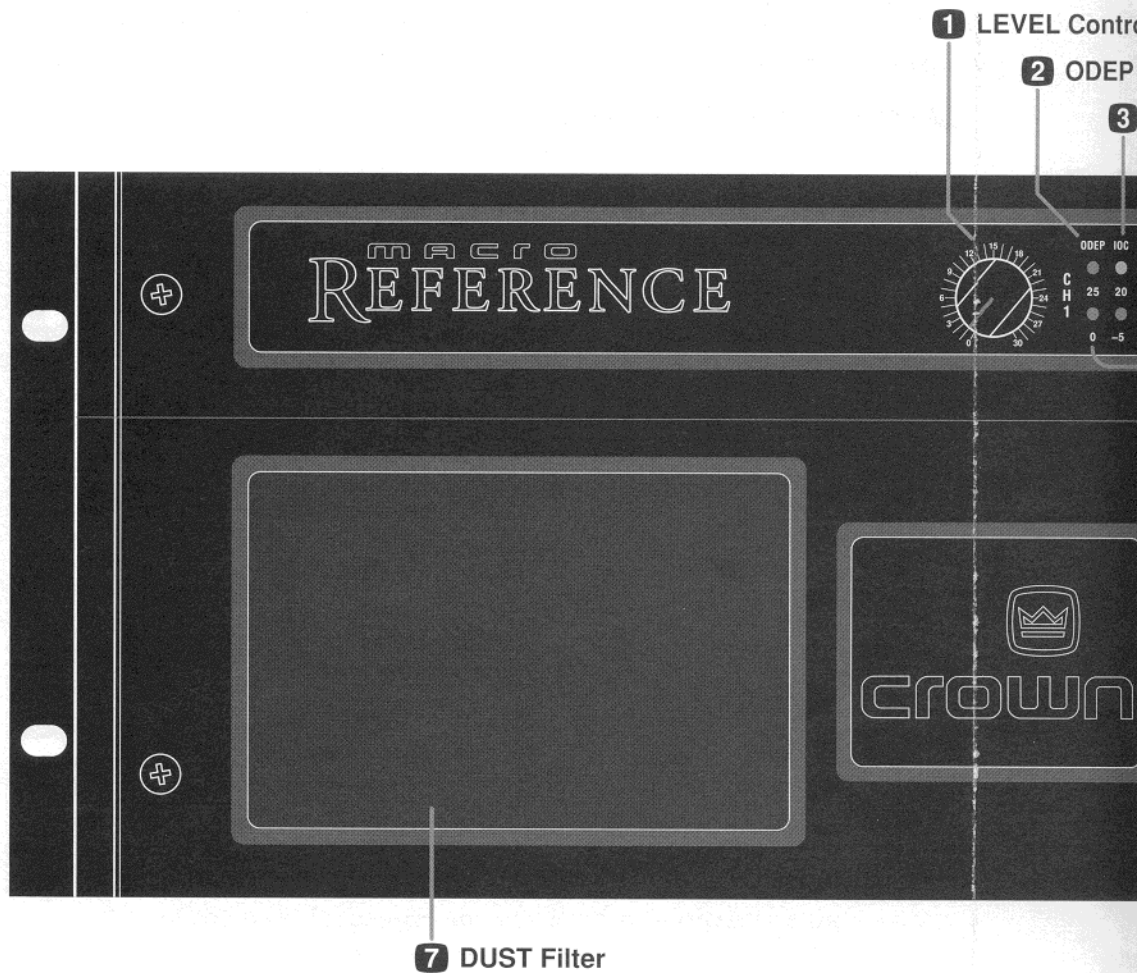

5

Afte
or tu
rema

6

The
turn
butt
Cau
the u
unpl
befor
chan

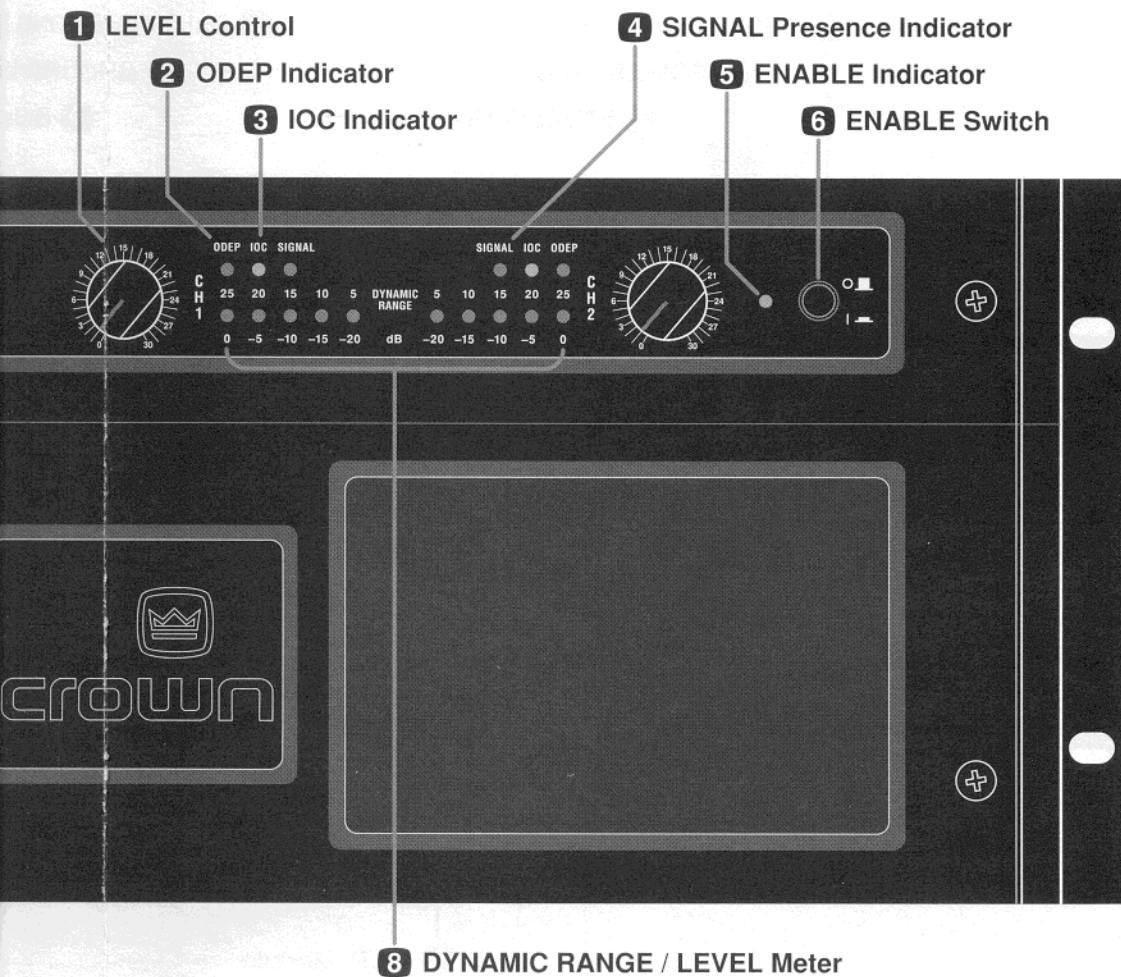

1 LEVEL Control

2 ODEP Indicator

3 IOC Indicator

4 SIGNAL Presence Indicator

5 ENABLE Indicator

6 ENABLE Switch

8 DYNAMIC RANGE / LEVEL Meter

5 ENABLE Indicator

After the amplifier is “enabled” or turned on, this indicator will remain on.

6 ENABLE Switch

The amplifier is “enabled” or turned on by pressing this push-button switch.

Caution: In addition to turning the unit off, you should always unplug the it from the AC mains before making any installation changes.

7 DUST Filter

The air drawn inside the amplifier is filtered by the dust filters mounted behind the front panel. They can be easily cleaned or replacement filter module can be ordered from the Crown Parts Department (telephone: 1-800-342-6939, part no: K 7429-0).

8 DYNAMIC RANGE / LEVEL Meter

A five-segment output meter is provided for each channel. It is

set as a dynamic range meter at the factory and shows the dynamic range in dB. (It computes dynamic range as the ratio of the peak to average power level.) The meter can also be switched to an output level meter. As a level meter it displays the output power relative to full power. For example, at 0 dB the output power would be 760 watts per channel while driving 8 ohm loads. See pages 19-21 for further details.

Controls & Connectors

1 RESET Switch

A 30-amp circuit breaker, conveniently located on the rear panel, acts as a reset switch to protect the power supplies.

2 POWER Cord

A power cord with a grounded three-blade plug is used to connect the AC mains.

3 STEREO-MONO Switch

The three operating modes of the Macro Reference are controlled by this switch. Stereo

mode is available for normal two-channel operation. Bridged-Mono mode is available to drive a single load with an impedance equal to or greater than 4 ohms. Parallel-Mono mode is available to drive a single load with an impedance less than 4 ohms. *Important: Do NOT change this switch unless the amplifier is first turned off. (See pages 8-10.)*

4 Balanced PHONE INPUT Jack

A balanced 1/4-inch phone jack is provided at the input of each

channel. They may be used with either balanced (tip, ring, sleeve) or unbalanced (tip, sleeve) input wiring.

Caution: The Channel 2 input should NOT be used in either mono mode.

5 GROUND LIFT Switch

The input signal ground may be isolated from the AC ground with this switch to help prevent the hum created by unwanted ground loops. It affects only the phone input jacks. It has no

affect u
connect
Activati
impeda
each ph
circuit g

6 Bal
Co
A balan
connect
input o
P.I.P.-F
standar
Referen
the XL

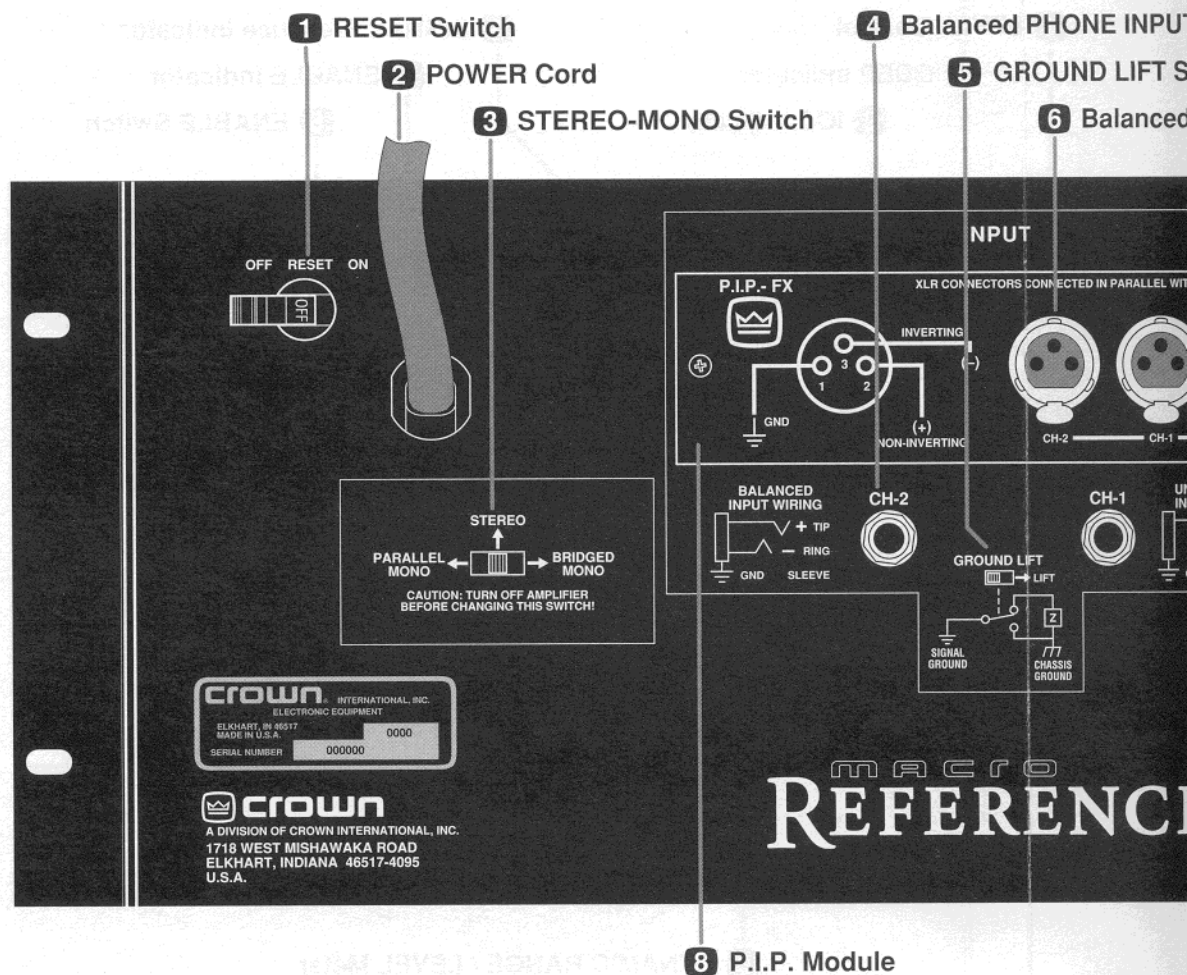

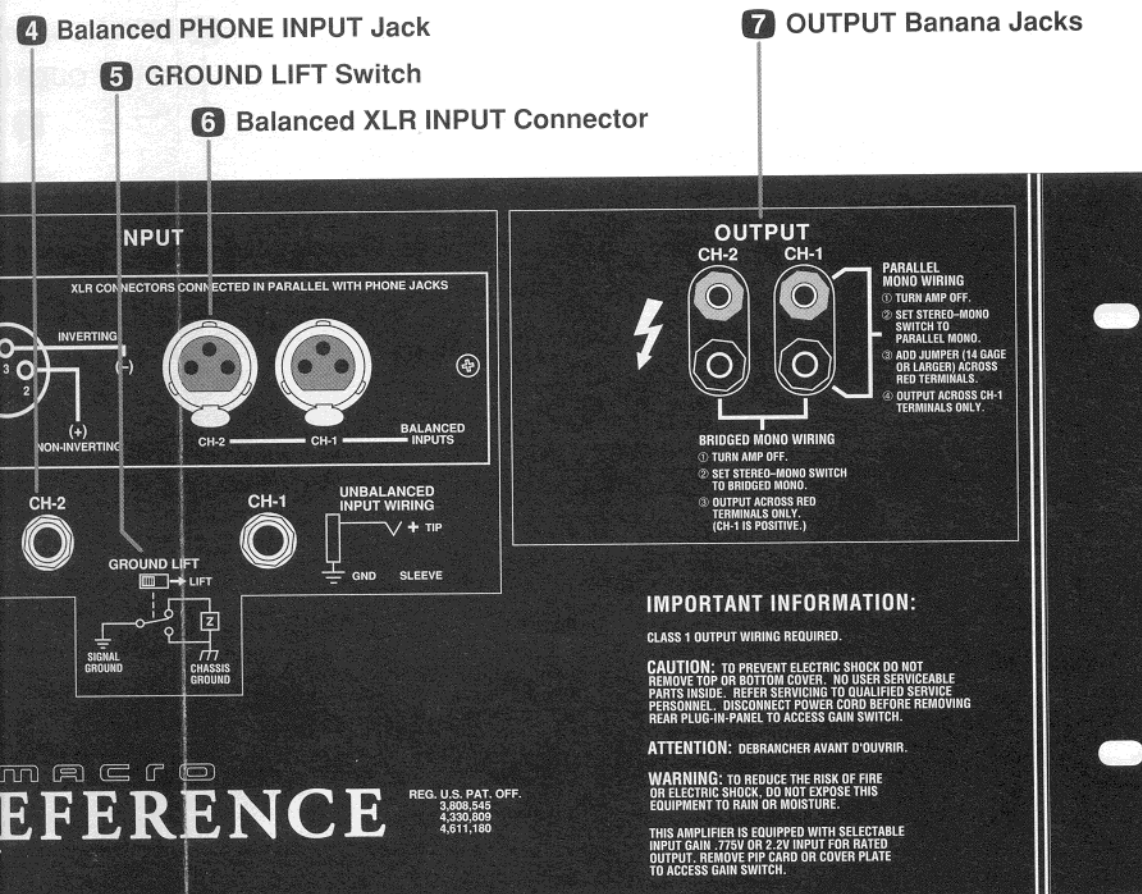

odule

d with
(sleeve)
input

put
er

may be
nd
event
nted
ly the
no

affect upon the XLR input connectors on the *P.I.P.* module. Activating the switch inserts an impedance between the sleeve of each phone input jack and the circuit ground.

6 **Balanced XLR INPUT Connector**

A balanced 3-pin female XLR connector is provided at the input of each channel on the *P.I.P.-FX* which comes as a standard feature of the Macro Reference. The *P.I.P.-FX* places the XLR inputs in parallel with

the phone input jacks.
Caution: The Channel 2 input should NOT be used in either mono mode.

7 **OUTPUT Banana Jacks**

Versatile gold banana jacks are provided for output. They will accept banana plugs (the preferred connection method), bare wire or spade lugs.

8 ***P.I.P.* Module**

The Macro Reference includes our powerful *Programmable*

Input Processor expansion feature to enable you to plug in custom input/control modules. Modules plugged into the *P.I.P.* connector are placed in series with the inputs to the amplifier and parallel to the phone input jacks. A *P.I.P.-FX* is included as a standard feature to provide balanced XLR inputs. It has no internal circuitry and can be used along with the phone input jacks to facilitate “daisy chaining” multiple amplifiers. See pages 32-33 for a list of the available *P.I.P.* modules.

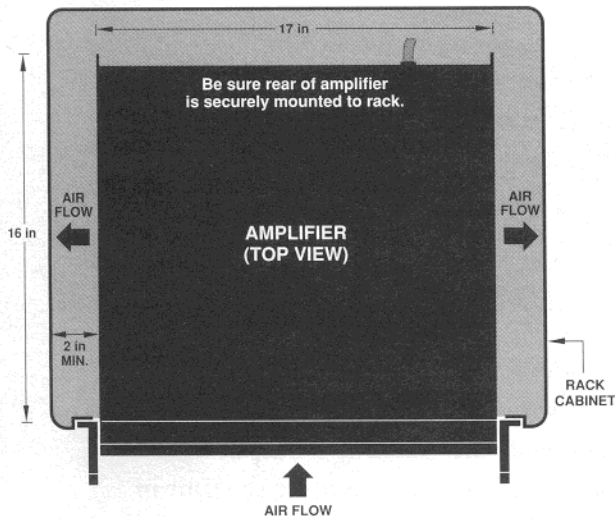

Installation

Your amplifier can be easily mounted into a standard 19-inch equipment rack. When doing so, securely fasten the rear of the amplifier because it is heavy.

Cooling

Never block the air vents. Allow for a minimum air flow of 45 cubic feet per minute. To accomplish this, keep the amplifier's side air vents at least 2 inches away from the sides of the rack cabinet.

If the operating environment is hot and/or the equipment rack is sealed, you may need to add additional cooling to the rack. A rack-mountable "squirrel cage" blower can be easily added.

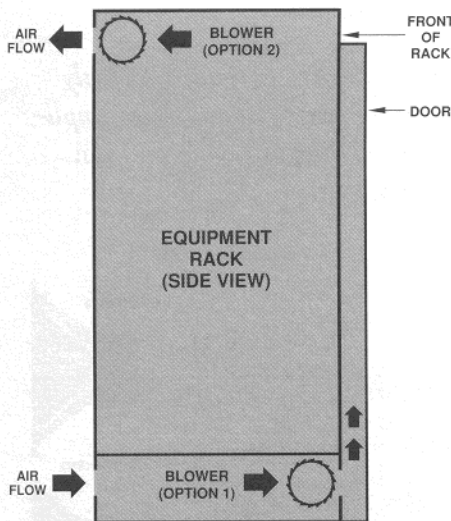

Two options for doing this are shown at left. Option 1 should be used when a solid door is installed over the front of the rack. It requires an auxiliary fan to pressurize the space behind the door with air drawn from outside the rack. Option 2 uses an auxiliary fan to evacuate air from racks having no solid door.

Always be sure that an auxiliary cooling fan draws fresh cool air into the rack and not recycled hot air.

A commercial furnace filter should also be added to prefilter the air if the air supply is unusually dusty.

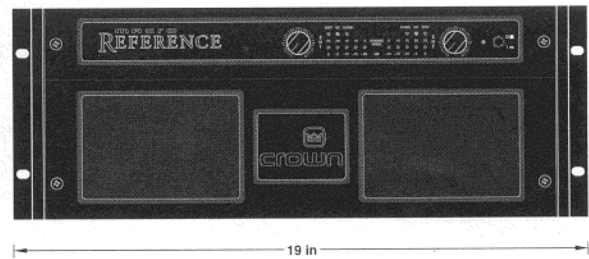
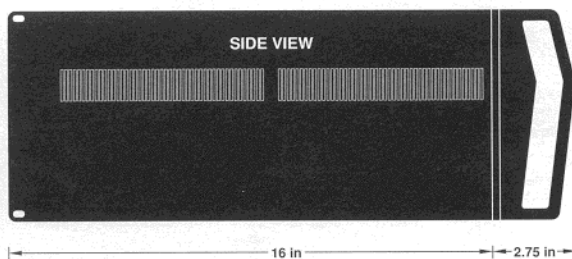

Wiring

Caution: Always remove power from the unit and turn the level controls off before making or changing connections. This will eliminate any chance of loud blasts or damage to the loudspeakers. Use care when making connections, selecting signal sources and adjusting the output level. The load and ears you save may be your own!

There are three major ways to wire your amplifier. Each has VERY IMPORTANT differences which are discussed next.

STEREO

Wiring the amplifier for stereo or two-channel operation is very intuitive. The Channel 1 input feeds the Channel 1 output and the Channel 2 input feeds the Channel 2 output. To place the unit in STEREO mode, first turn it off, then slide the Stereo-Mono switch on the back panel to the center position. Finally, connect the output and input wiring as shown in the illustration below.

Caution: In STEREO mode never parallel the two outputs by directly tying them together or parallel them with the output of any other amplifier. Such connection does not increase the output power and can prematurely activate the protection circuitry.

Stereo

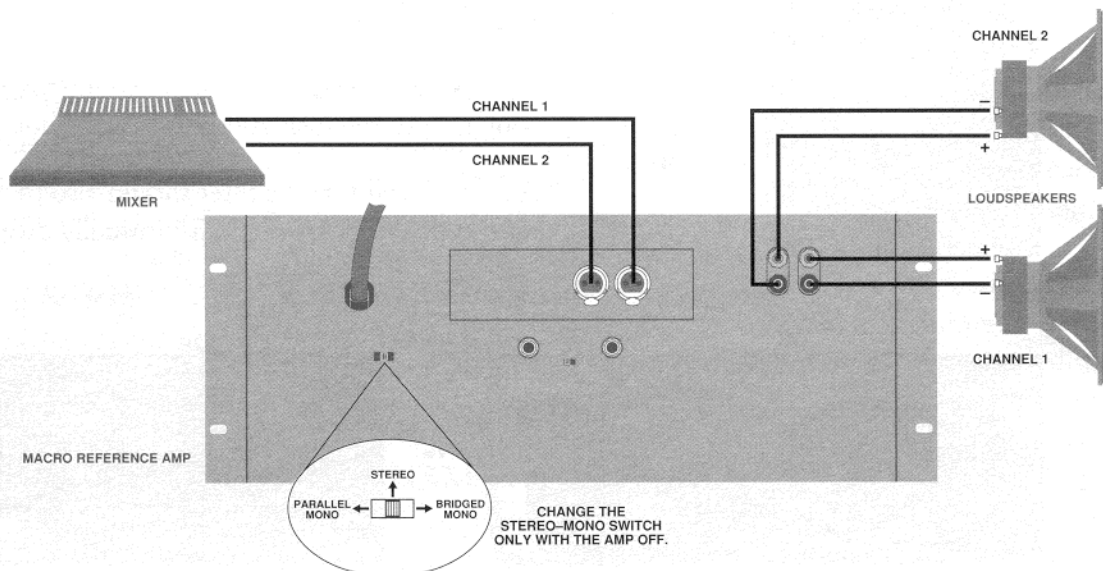

BRIDGED - MONO

This is one of two mono or single-channel modes of operation for your amplifier. BRIDGED-MONO mode is intended for loads with a total impedance equal to or greater than 4 ohms. Use the PARALLEL-MONO mode if the load is less than 4 ohms.

To place the amplifier in BRIDGED-MONO mode, first turn it off, then slide the Stereo-Mono switch on the back panel to the right. Next, connect the output wiring as shown in the illustration below. Note that the load is connected across the two red banana posts—the black posts are not used and should not be shorted. The positive lead of the load should connect to the red post of Channel 1 and the negative lead should connect to the red post of Channel 2. *Important: The load must be balanced (neither side shorted to ground).* Finally, connect the input signal to the input of Channel 1 only. The Channel 2 input should not be used and its level control should be turned off (full counterclockwise).

Caution: Be certain that all equipment (meters, switches, etc.) connected to the mono output lines is balanced. To prevent oscillations, both sides of the line must be totally isolated from the input grounds.

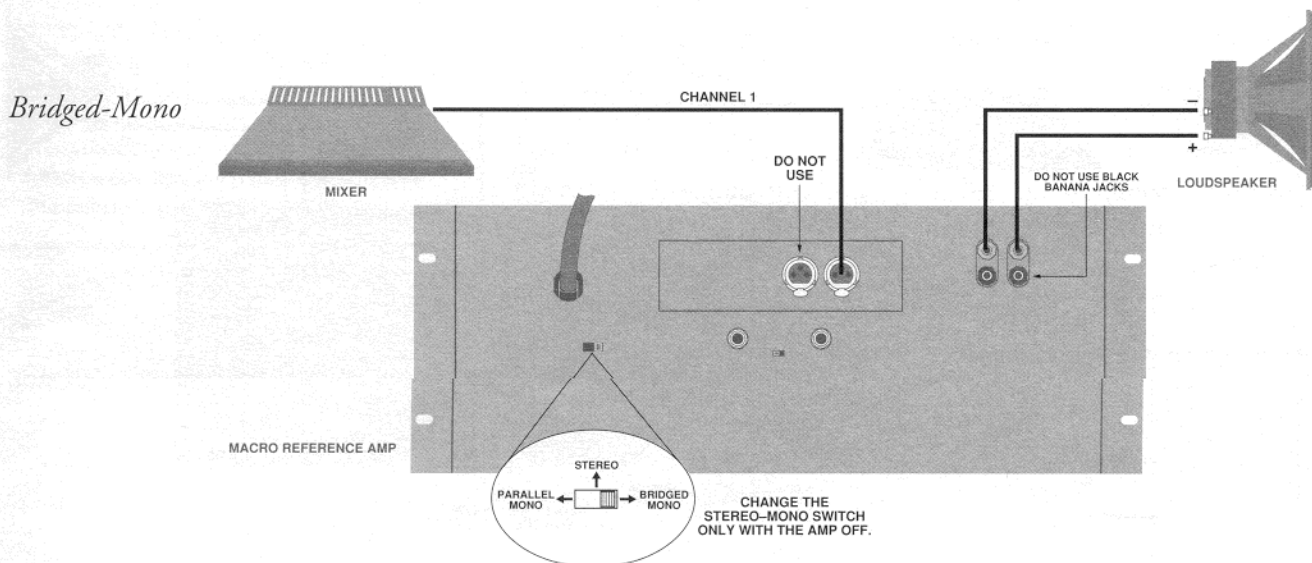

PARALLEL-MONO

This is another of the two mono or single-channel modes of operation for your amplifier. PARALLEL-MONO mode is intended for loads with a total impedance less than 4 ohms. Use the BRIDGED-MONO mode if the load is equal to or greater than 4 ohms.

To place the amplifier in PARALLEL-MONO mode, first turn it off, then slide the Stereo-Mono switch on the back panel to the left. Next, install a jumper between the two red banana posts and connect the output wiring as shown in the illustration below. The jumper should be at least 14 gauge wire. The positive lead of the load should connect to either of the red posts and the negative lead should connect to either of the black posts. Finally, connect the input signal to the input of Channel 1 only. The Channel 2 input should not be used and its level control should be turned off (full counterclockwise).

Caution: When wired for PARALLEL-MONO mode, do not attempt to operate in STEREO or BRIDGED-MONO mode until the jumper is removed and the output appropriately changed.

Please note: In PARALLEL-MONO mode, the Channel 1 IOC indicator serves both paralleled channels. The Channel 2 IOC indicator will stay on to serve as a PARALLEL-MONO indicator.

Parallel-Mono

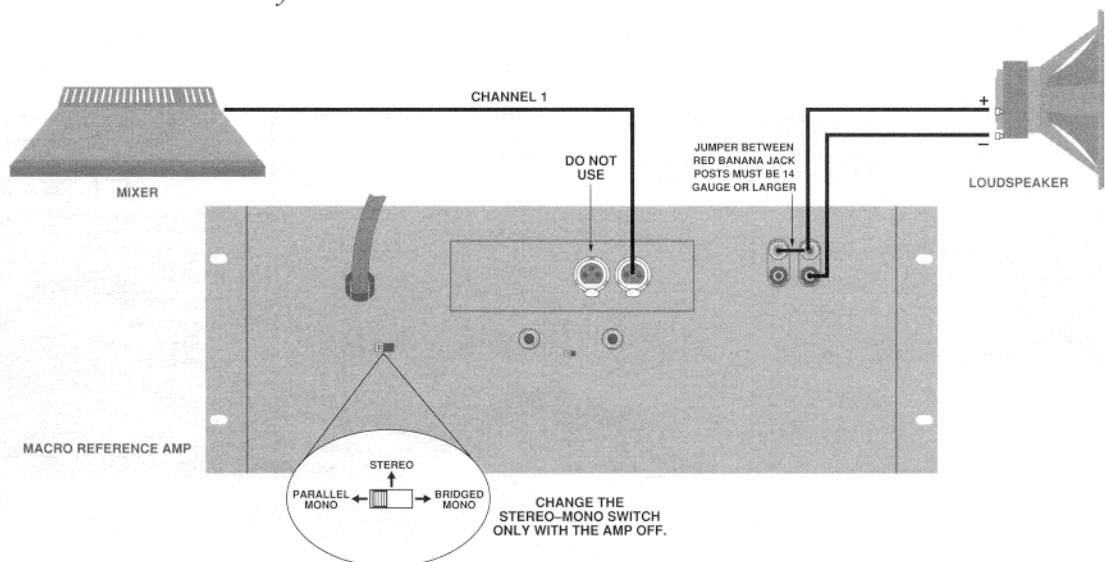

Input Wiring Tips

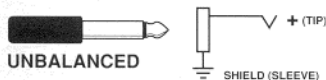
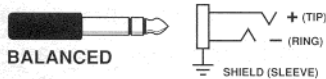

1. Use only shielded cable. The higher the density of the shield (the outer conductor), the better the cable. Spiral wrapped shield is not recommended.
2. When using unbalanced lines, keep the cables as short as possible. Avoid cable lengths greater than 10 feet.
3. Do not run signal cables together with high-level wiring such as loudspeaker wires or AC cords. (This greatly lessens the chance of hum or noise being induced into the input cables.)
4. Turn the entire system off before changing any connections and turn the level controls all the way down before powering the system back up. Crown is not liable for damage when any transducer or component is overdriven.

Subsonic Filter Capacitors

Input Connection

Both the XLR and phone jack inputs are balanced and have a nominal impedance of 10 K ohms (5 K ohms if unbalanced wiring is used) and will easily accept the line-level outputs of most devices. The XLR inputs are provided on a P.I.P.-FX input module which is included as a standard feature. Many other *P.I.P.* modules are optionally available to customize your amplifier. See the Accessories section at the end of this manual for a brief description of them.

Normally you should not use the phone jack inputs if a *P.I.P.* module other than a P.I.P.-FX or P.I.P.-FMX is installed. The phone jacks are in parallel with the output of the *P.I.P.* module. If the phone jack inputs are used, the signal could backfeed into the output of the *P.I.P.* and generate a distorted input signal.

The P.I.P.-FX and P.I.P.-FMX are exceptions because they contain only XLR connectors and have no circuitry. Therefore, they allow the phone jack inputs to be used to “daisy chain” to other amplifiers.

Please follow the instructions in the preceding section regarding BRIDGED-MONO and PARALLEL-MONO mode wiring. In both cases the Channel 2 input should not be used.

SOLVING INPUT PROBLEMS

Sometimes large **subsonic** (subaudible) **frequencies** are present in the input signal. These can damage loudspeakers by overloading or overheating them. To attenuate such frequencies, place a capacitor in series with the input signal line. The graph below shows some possible capacitor values and how they affect the frequency response. Use only low-leakage paper, mylar or tantalum capacitors.

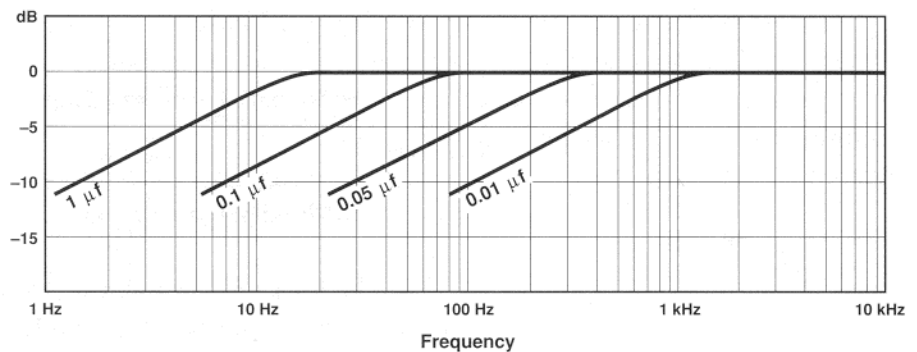

Unbalanced RF Filters

Another problem to avoid is the presence of large levels of RF or **radio frequencies** in the input signal. Although high RF levels may not pose a threat to the amplifier they can burn out tweeters or other loads which are sensitive to high frequencies. Extremely high RF levels can also cause your amplifier to prematurely activate its protection circuitry, resulting in inefficient operation. RF can be introduced into the signal by local radio stations and from the bias signal of many tape recorders. To prevent this from happening, place an appropriate low-pass filter on the input(s). Some examples are shown below for unbalanced wiring:

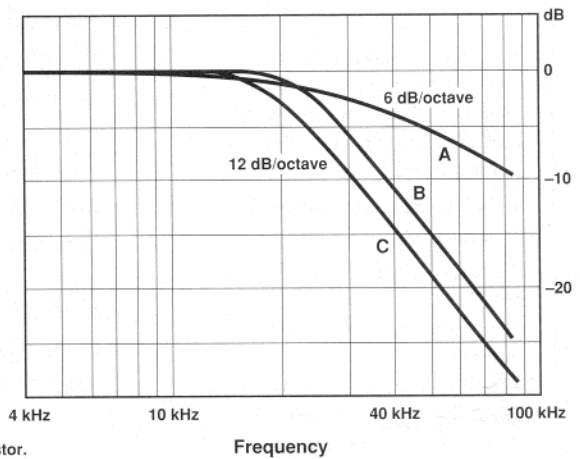
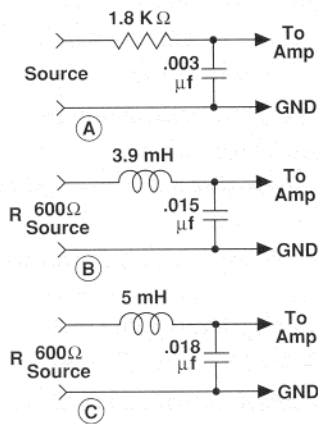

Note: A low source impedance (R) can be increased to 600 Ω by an appropriate resistor.

For balanced input wiring use one of the examples below. Filters A, B and C correspond to the unbalanced filters above. Filter D also incorporates the subsonic filter described on the previous page.

Balanced RF Filters

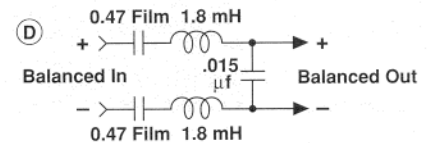
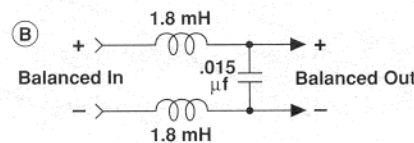
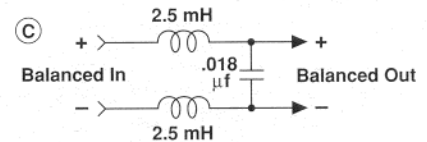
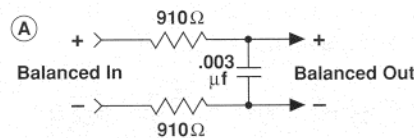

Tip: The P.I.P.-FX, which came with your amplifier, has plenty of room on its empty circuit board for the input filters.

A third problem to avoid is the problem of **ground loops**. These are the undesired currents which flow in a grounded system and which usually cause hum in the output. A common source of ground loops is the placement of input cables parallel to power cables or near power transformers. The ground loop occurs when the magnetic field generated by the 60 Hz alternating current in the power cable or transformer is induced into the input cables. To prevent this you can lace the input cables along their length. (Lacing the cables helps cancel magnetically induced current.) It is also very important to locate the input cables away from power cables and power transformers.

Ground loops will also occur when the input and output grounds are tied together. **DO NOT CONNECT THE INPUT AND OUTPUT GROUNDS TOGETHER.** Tying the input and output grounds together can also cause **feedback oscillation** from the load current flowing in the loop. To avoid this problem use proper grounding, isolate the inputs, and isolate other common AC devices. If necessary the input signal ground can be isolated from the mains AC ground with the ground lift switch located on the back panel of your amp (see also pages 6 and 21).

Use Good Connectors

1. Male connectors on loudspeaker cables should not be exposed to prevent possible shorts.
2. Connectors which might accidentally cause the two channels to be tied together during making and breaking connections should not be used. (A common example is the standard 3-wire stereo phone plug.)
3. Connectors which can be plugged into AC power receptacles should never be used.
4. Connectors having low current-carrying capacity should not be used.
5. Connectors having any tendency to short or having shorted leads should never be used.

Output Connection

Consider the power-handling capacity of your load before connecting it to the amplifier. Crown is not liable for damage incurred at any time due to its being overpowered. The use of loudspeaker protection fuses is highly recommended (see page 16). Please pay close attention to the Operating Precautions (page 17).

Use loudspeaker cables of sufficient gauge (thickness) for the length used. The resistance introduced by inadequate speaker cables will reduce both the output power and the motion control of the loudspeakers. The latter problem occurs because the damping factor decreases as the speaker cable resistance increases. This is very important because you can easily negate the superior damping factor of the Macro Reference by using mediocre speaker cables.

Use the following procedure to find the recommended wire gauge (AWG or American Wire Gauge) for your system.

HOW TO DETERMINE APPROPRIATE WIRE GAUGE

Ohms per 1000 ft	AWG No.
0.059	0000
0.064	000
0.081	00
0.102	0
0.126	1
0.159	2
0.200	3
0.254	4
0.319	5
0.403	6
0.508	7
0.605	8
0.808	9
1.018	10
1.284	11
1.619	12
2.042	13
2.575	14
3.247	15
4.094	16
5.163	17
6.510	18
8.210	19
10.35	20
13.05	21
16.46	22
20.76	23
26.17	24
33.00	25
41.62	26
52.48	27
66.17	28

1. Decide what damping factor you want the system to have. Your amplifier is capable of providing a phenomenal damping factor of 20,000 from 10 to 200 Hz into an 8 ohm load. Typical damping factors are 50 or lower. Higher damping factors yield greater motion control of loudspeakers.
2. Calculate the required source impedance. This is done by dividing the impedance of the loudspeaker by the desired damping factor as shown below:

$$\text{Source Impedance} = \frac{\text{Loudspeaker Impedance}}{\text{Damping Factor}}$$

3. Measure how long the loudspeaker cable must be. *Important: keep the length as short as possible.*
4. Calculate the maximum allowable wire resistance per 1000 feet for the cable by dividing the source impedance times 1000 by twice the cable distance as shown below:

$$\text{Ohms per 1000 ft} = \frac{\text{Source Impedance} \times 1000}{\text{Cable Length (ft)} \times 2}$$

The reason why the cable length is multiplied by 2 is because both of the two conductors feeding the loudspeaker must be included in the calculation.

5. Use the table at left to find the wire gauge (AWG) with a resistance equal to or less than the maximum allowable wire resistance calculated above. *Note: The smaller the AWG, the bigger the wire.*

Example: We want to drive an 8 ohm loudspeaker with a damping factor of 1,000 so we calculate the required source impedance as 8 ohms ÷ 1,000 = 0.008 ohms. Our loudspeaker cable must be 10 feet long so we calculate the maximum allowable wire resistance as (0.008 ohms x 1000) / (10 ft x 2) = 0.4 ohms per 1000 ft. Next we look on the table to find the corresponding wire gauge and we see that 6-gauge wire is very close with a resistance of 0.403 ohms per 1000 feet. Answer: Use 6-gauge wire or larger.

Hint: If this gauge is too large you can use more than one cable. A rule of thumb is that every time you double the number of conductors of equal gauge, you subtract 3 from the apparent gauge. In our previous example you could double the number of cables feeding the loudspeaker. This would allow you to drop the wire gauge to 9. Or you could use four 12-gauge cables.

SOLVING OUTPUT PROBLEMS

Sometimes **high-frequency oscillations** occur which can cause your amplifier to prematurely activate its protection circuitry and result in inefficient operation. The effects of this problem are similar to the effects of the RF problem described on page 12. To prevent high-frequency oscillations from occurring:

- Lace the loudspeaker cables together. This minimizes the chance of them acting like an antenna to transmit or receive the high frequencies which can cause oscillation.
- Keep loudspeaker cables well separated from input cables.
- Never connect the input and output grounds together.
- Install a low-pass filter on each input line (similar to the RF filters described in the Input Connection section).
- Install the input wiring according to the instructions in the Input Connection section.

Another problem to avoid is the presence of large **subsonic low-frequency currents** when primarily inductive loads are used. An example of such an inductive load is an electrostatic loudspeaker.

Inductive loads can appear as a “short” at low frequencies, causing the amplifier to produce large low-frequency currents and unnecessarily activate its protection circuitry. Always take the precaution of installing a high-pass filter at the inputs to the amplifier when a predominantly inductive load is used. A 3-pole (18 dB per octave) filter with a -3 dB frequency of 50 Hz is recommended. (Depending upon your application, it may be more desirable to use a filter with an even higher -3 dB frequency.) Such a filter should eliminate the subsonic frequency problems mentioned in the Input Connection section.

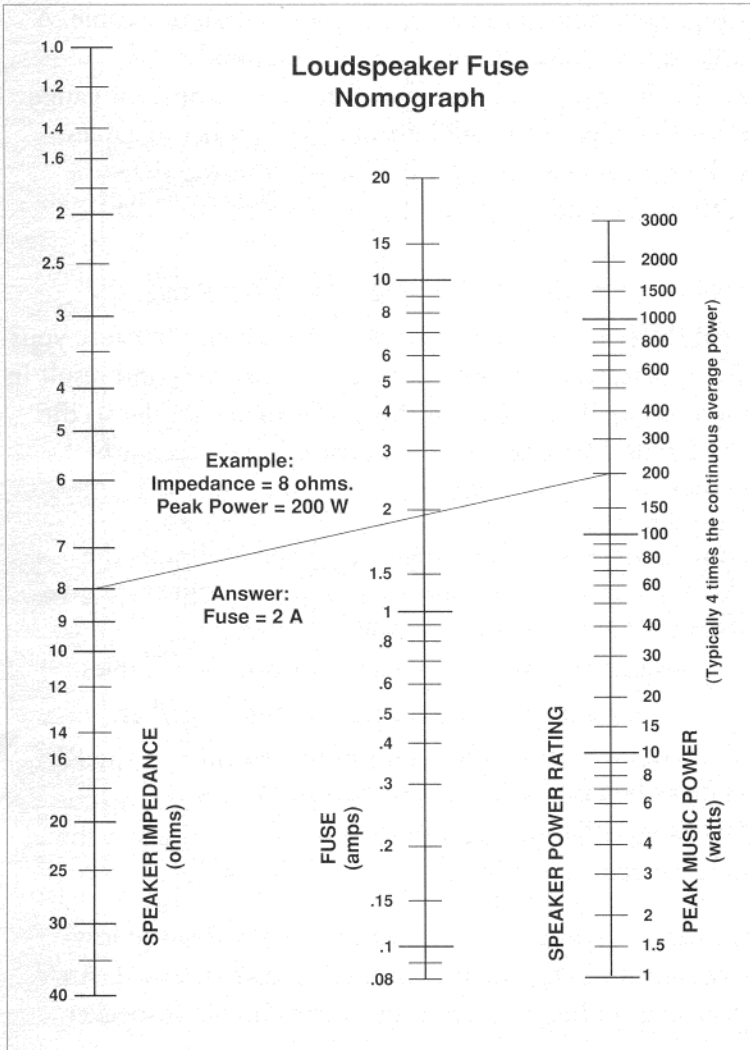

LOAD PROTECTION

Since your amplifier can generate enormous power, you may desire to protect your loudspeakers or other sensitive loads from damage resulting from excessive power. A common way to do this is to place a fuse in series with the load.

Typical fuses help prevent damage due to prolonged overload, but provide little if any protection against sudden large transients. To minimize this latter problem, use high-speed instrument fuses such as the Littlefuse 361000 series. If, on the other hand, the loudspeaker is only susceptible to damage caused by prolonged overload (such as overheating), use a fuse or circuit breaker having the same slow thermal response as the loudspeaker (such as a slow-blow fuse).

The nomograph at left shows fuse size versus loudspeaker peak power rating. It can be used to determine what size fuse to use.

AC Mains Power Requirements

Each Macro Reference amplifier is furnished with a three-wire AC plug. Use an isolated wall outlet whenever possible with adequate current (see page 30 for further details). Line voltages greater than 132 VAC will actuate an internal control circuit which protects the amplifier.

When testing the amplifier, the peak mains voltage must be equivalent to the peak voltage of a 120 VRMS sine wave when at full load. Line voltage problems can reduce the available output power.

Operation

Your amplifier is well protected from any external hazards; however, it is wise to adhere to the following precautions for safe operation:

Precautions

1. There are important differences in each of the three operating modes (STEREO, BRIDGED-MONO and PARALLEL-MONO). Refer to the Wiring section beginning on page 8 for further details.
2. **WARNING:** Do not change the position of the Stereo-Mono switch unless the amplifier is first turned off.
3. **CAUTION:** In PARALLEL-MONO mode, a jumper is used between the red banana posts (outputs). Be sure to remove it for BRIDGED-MONO or STEREO operation; otherwise inefficient operation, high distortion and excessive heating will **definitely occur**. Check the Stereo-Mono switch on the back panel for proper position.
4. Turn the amp off and unplug it from the AC mains before removing a *P.I.P.* card or before removing and cleaning the dust filter.
5. Use care when making connections, selecting signal sources and controlling the output level. The load and ears you save may be your own!
6. Do not short the ground lead of an output cable to the input signal ground. This may form a ground loop and cause oscillations.
7. Operate the amplifier from AC mains no greater than 132 or less than 108 VAC and only at 60 Hz.
8. Never connect the output of the amplifier to a power supply output, battery or power main.
9. Do not tamper with the circuitry or allow an unqualified person to service your amplifier or the warranty will be made invalid.

Remember: Crown is not liable for any damage resulting from overdriving other components in your system.

Indicators

The front panel contains several helpful indicators. These are shown below and on page 5.

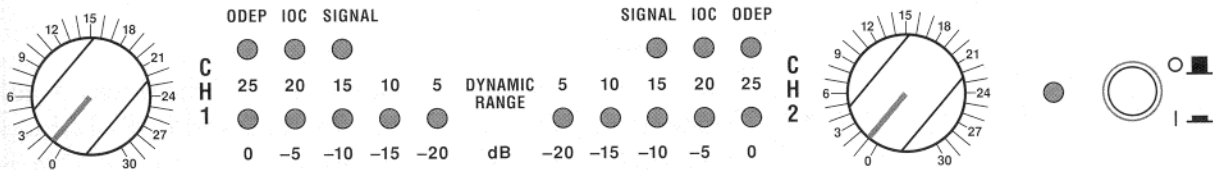

The **Enable indicator** signals that the amplifier has been turned on or enabled. It is driven by the low-voltage power supply only and does not indicate the high-voltage power supply status. Because of this, it will remain on if the high-voltage supplies are disrupted. For example, the Enable indicator will remain on in the improbable event that one or both channels overheat causing an internal shut down of the high-voltage supplies. *Note: The AC mains transformer is always powered. This is why the amplifier must be unplugged from the AC mains before any wiring changes are made.*

The **ODEP indicators** glow brightly to confirm normal operation of Crown's patented Output Device Emulator Protection circuitry. They also indicate the presence of ample thermal-dynamic energy reserve for the current operating conditions. In the rare event there are not adequate energy reserves, the indicators will dim in proportion to *ODEP* limiting.

HOW ODEP WORKS

Crown invented *ODEP* to solve two long-standing problems in amplifier design: To prevent amplifier shutdown during demanding operation and to increase the efficiency of output circuitry. To do this, Crown established a rigorous program to measure each output transistor before installing it in an amplifier. In this way the *safe operating area* (SOA) of each device is known. Next, Crown designed intelligent circuitry to simulate the instantaneous operating conditions of those output transistors. Its name describes what it does: Output Device Emulator Protection or *ODEP*. It not only simulates the operation of the output transistors but it also compares their operation to their known SOA. If it sees that more power is about to

be asked of them than they are capable of delivering under current conditions, it immediately limits their drive level until it falls within their SOA. The limiting is proportional and is kept to an absolute minimum—only what is required to prevent output transistor damage. This level of protection enables Crown to increase output efficiency to never-before-achieved levels while at the same time greatly increasing amplifier reliability. Finally, this on-board intelligence is monitored two different ways. First, there are *ODEP* indicators provided on the front panel to show that everything is functioning perfectly and to alert if limiting begins. Second, *ODEP* data is fed to the *P.I.P.* connector at the back of the amplifier so advanced *P.I.P.* modules like the IQ-P.I.P. can use it to make decisions and control the amplifier. With *ODEP* the show won't stop because you get the maximum power with the maximum protection.

The ***IOC*** indicators function as sensitive distortion meters (Input/Output Comparators) to provide *proof of performance*. They flash in the unlikely event that the waveform of the output signal differs from that of the input by 0.05% or more. It is normal for them to turn on momentarily when the amplifier is first turned on. Also, the Channel 2 *IOC* indicator will stay on in PARALLEL-MONO mode.

The **Signal presence indicators** are provided to give visual indication that an audio signal is present at the input of the amplifier. The indicators flash synchronously with the input signal level. If the input signal is weak or at a very low level, it might not cause the indicators to flash at all.

The **Dynamic Range / Level meters** are five-segment output meters which can be set to monitor either the dynamic range of the output signal or the relative level of the output signal. They are initially set as dynamic range meters at the factory. A switch, located behind the front panel, is used to set them (see page 20 for full instructions on changing the switch). As dynamic range meters they show the ratio of the peak to average power of each channel in dB. The dynamic range may be high for some audio sources, like live audio or a quality digital or analog recording, or it may be low for other sources, like typical AM or FM radio. As output level meters they show how high the output levels are in dB relative to full power. At 0 dB the unit is at full power or 760 W into 8 ohm loads (stereo).

Controls

The **Enable switch** is located on the front panel so you can easily turn the amplifier on or off. *Remember to also disconnect the power cord before making any wiring or installation changes.* Please follow these steps to set the maximum level when turning on your amplifier for the first time:

1. Turn down the level of your audio source. Example: Turn down the master volume of your mixer.
2. Turn down the level controls of the amplifier (if they are not already down).
3. Turn on the Enable switch. The Enable indicator beside the switch should glow. During the four second mute delay which immediately follows, the *IOC* and Signal presence indicators will flash unpredictably and the *ODEP* indicators will stay off. After the mute delay, the *ODEP* indicators should come on with full intensity and the *IOC* and Signal presence indicators should function normally. *Remember: The Channel 2 IOC indicator will remain on in PARALLEL-MONO mode.*
4. After the mute delay, turn up the level of your audio source to the maximum desired level.
5. Turn up the Level controls of the amplifier until the maximum desired sound level is achieved.
6. Turn down the level of your audio source to its normal range.

The **Level controls** are also located on the front panel for ease of use. Each control has 31 detents to help you repeat an exact setting. *Important: In either BRIDGED-MONO or PARALLEL-MONO mode turn down the Channel 2 Level control and use only the Channel 1 control.*

The **Dynamic Range / Level meter switch** is located behind the front panel. To change it follow these steps:

1. Turn the amplifier off and disconnect its power cord from the AC mains power receptacle.
2. Remove the front panel (four Phillips-head screws).

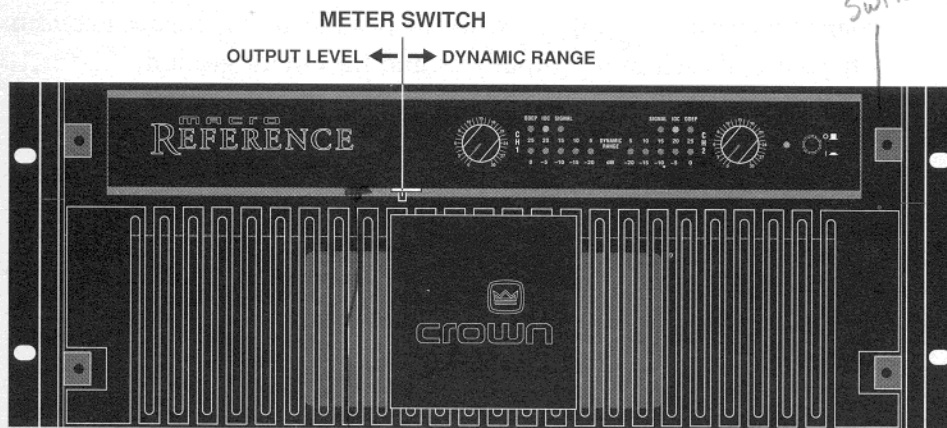

EMR

Switch on/off EL display

3. Locate the Dynamic Range / Level meter switch as shown at left and set it to the desired position. The right position selects the Dynamic Range meter. The left position selects the Level meter.

4. Replace the front panel and reconnect the power cord.

OFF ON
METER
EMR

The **Input Sensitivity switch** is located inside the rear of the amplifier and is factory-set to 0.775 V for rated output into 8 ohms. If desired, it can be switched to a fixed voltage gain of 26 dB. When set to the fixed-gain position, the input sensitivity is 3.9 V for full output. Here is the procedure:

SENSITIVITY SWITCH INSIDE ACCESS HOLE

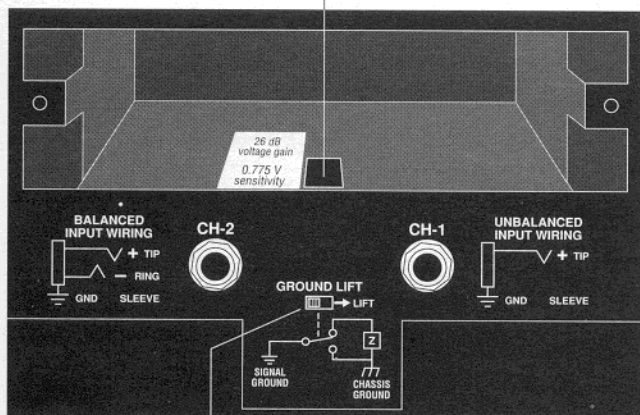

GROUND LIFT SWITCH

1. Turn the amplifier off and disconnect its power cord from the AC mains power receptacle.
2. Remove the *P.I.P.* module (two screws).
3. Locate the sensitivity switch access hole inside the chassis opening shown at left. It is located just above the phone input jacks.
4. Set the switch to the desired position noted on the access-hole label. (Move the switch toward the front panel to set the sensitivity for a voltage gain of 26 dB or move the switch toward the rear panel for a sensitivity of 0.775 V for rated power.)
5. Replace the *P.I.P.* module and reconnect the power cord.

The **Ground Isolation switch** is located on the rear panel and can provide isolation between the input signal ground and the AC ground. It affects only the phone input jacks and has no effect on the input connectors on the *P.I.P.* module. Sliding the switch to the

right isolates or “lifts” the grounds by placing an impedance between the sleeve of each phone input jack and the circuit ground.

Note: When a P.I.P. module is plugged into the amplifier, only the noninverted and inverted signal lines are connected in parallel with the corresponding lines of the input phone jacks. The signal grounds are not paralleled. For example, XLR pins 2 and 3 are connected in parallel with the tip and ring of the corresponding phone jack. However, pin 1 of the XLR is not connected in parallel with the sleeve of the phone jack.

The **Reset switch** is located on the rear panel to protect the power supplies against overload. Switching it to the left disconnects the power cord from the power supplies. Switching it to the right reconnects the power cord to the power supplies. If the reset switch trips, the Enable indicator will turn off. If this should ever happen, turn off the Enable switch and push the Reset switch back to the on position. Then turn the Enable switch back on. If the Reset switch trips again or the amplifier fails to operate properly, contact an authorized service center or the Crown factory for service.

Filter Cleaning

A dust filter is provided on each air intake to the cooling system. They are located on the front panel of the amplifier. If the filters become clogged, the amplifier will not cool as efficiently as it should and may produce lower-than-normal output levels due to high heat-diffuser temperature.

To clean, remove the front panel of the amplifier to gain access to the filters. There are only four Phillips-head screws to remove. The filters are designed to be cleaned while still attached to the front panel. Use a mild dishwashing detergent and warm water to clean them. Make sure both the filters and the front panel are dry before reinstalling them. Replacement filters can be ordered from the factory.

Dust filters are not 100% efficient—long term use will require that the internal heat diffusers be cleaned by a qualified technician. Internal cleaning information is available from our Technical Services Department.

Service

Your amplifier has very sophisticated circuitry which should only be serviced by a fully trained technician. This is one reason why each unit bears the following label:

CAUTION: TO PREVENT ELECTRIC SHOCK DO NOT OPEN. NO USER SERVICEABLE PARTS INSIDE. REFER SERVICING TO A QUALIFIED TECHNICIAN.

Crown customers may obtain service two ways: from an authorized Crown Service Center or from the factory. You may choose either method. It is important that you have your copy of the bill of sale as your proof of purchase.

Service at a Crown Service Center

This method usually saves you the most time and effort. Simply present your bill of sale along with the defective unit to an authorized Crown Service Center to obtain service. They will handle the necessary paperwork and repair. Remember to transport your unit in the original factory pack.

Crown Factory Service

To obtain factory service, fill out the Service Information card which came in an envelope with your unit and send it along with proof of purchase and the unit in need of service to the Crown factory. Enclose a letter explaining the nature of the problem and what service you would like. Include your return shipping address and telephone number.

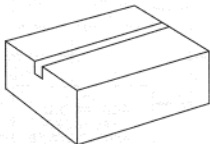

Crown

Technical Services Department
1718 West Mishawaka Road
Elkhart, Indiana 46517-4095

Phone: 1-800/342-6939
or: 1-219/294-8200
Fax: 1-219/294-8365

The unit must be shipped in the original factory pack. If you no longer have the original shipping container, contact us and we will promptly send you a replacement.

Crown will pay surface shipping costs both ways in the United States **for warranty service** upon receiving copies of all shipping receipts. Shipments should be sent by truck. (The unit is too heavy to ship via UPS.) The factory will return your serviced unit via truck. Please contact our Shipping Department at 219/294-8246 if other arrangements are necessary.

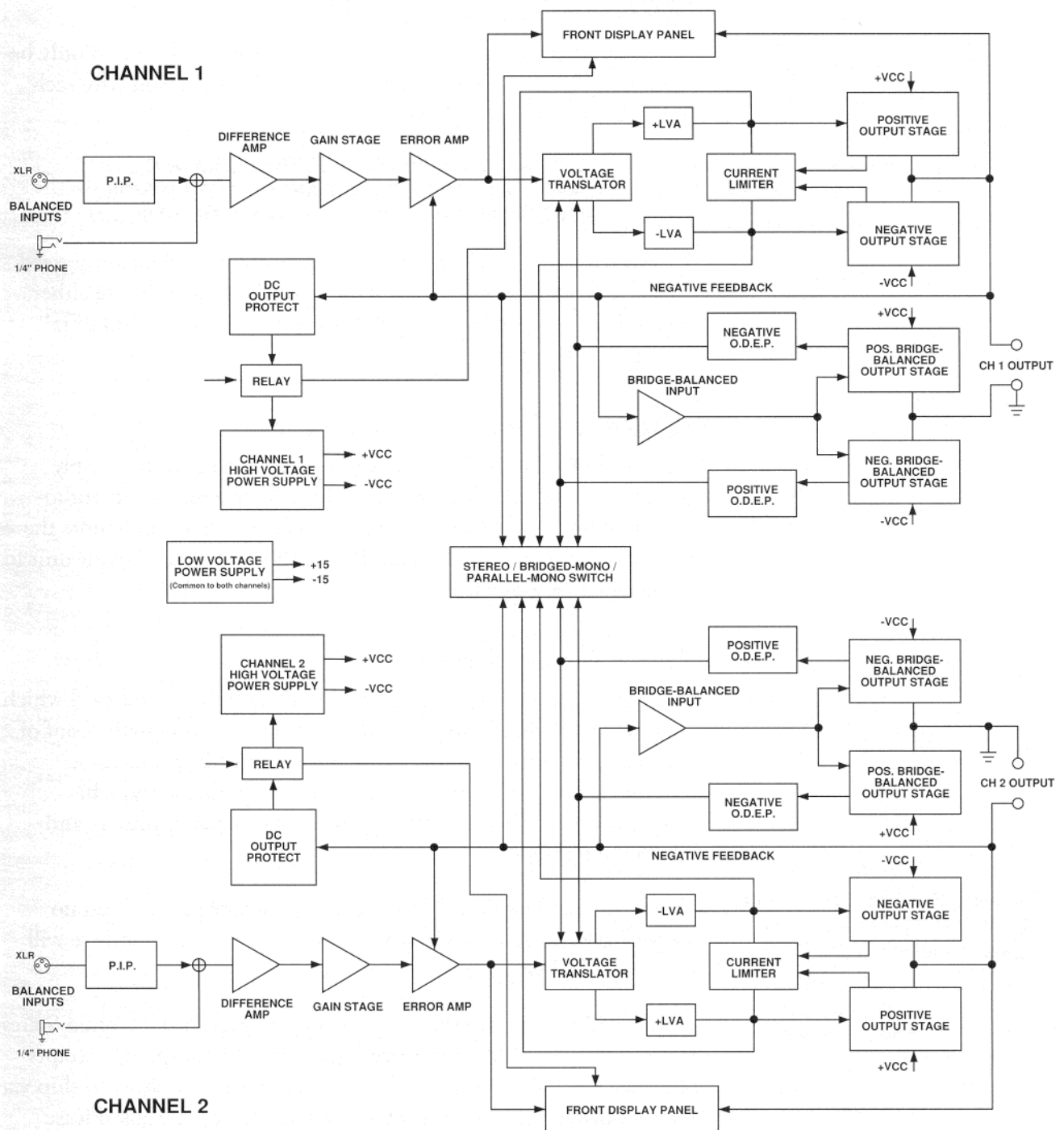

Technical Excellence

The Macro Reference incorporates several new technological advancements including real-time computer simulation, low-stress output stages, and an advanced thermal diffuser embodiment.

Extra circuitry is incorporated to limit temperature and current to safe levels—making it highly reliable and tolerant of faults. Unlike many lesser amplifiers, it can operate at its voltage and current limits without self-destructing.

The Macro Reference is protected against all common hazards that plague high-power amplifiers, including shorted, open or mismatched loads; overloaded power supplies; excessive temperature, chain-destruction phenomena, input-overload damage, and high-frequency blowups. The unit protects loudspeakers from DC in the input signal and from turn-on/turn-off transients. It also detects and prevents unwanted DC on the outputs.

Real-time computer simulation is used to create an analog of the junction temperature of the output transistors (herein referred to as the output devices). Current is limited only when the device temperature becomes excessive—and just by the minimum amount necessary. This patented approach maximizes the available output power and eliminates overheating—the major cause of device failure.

The four-quadrant topology used in the Macro Reference grounded output stages is called the *grounded bridge*[™], and makes full use of the power supply at all times. This patented topology also provides peak-to-peak voltages available to the load that are twice the voltage the output devices are exposed to.

The *grounded bridge* topology is ground-referenced. Composite devices are constructed to function as gigantic NPN and PNP devices, since the available currents exceed the limits of available devices. Each output stage has two of these composite NPN devices and two composite PNP devices.

The devices connected to the load are referred to as “high-side NPN and PNP” and the devices connected to ground are referred to as “low-side NPN and PNP.” Positive current is delivered to the load

by increasing conductance simultaneously in the high-side NPN and low-side PNP stage, while decreasing conductance of the high-side PNP and low-side NPN in synchrony.

The two channels may be used together to double the voltage (bridged-mono) or the current (parallel-mono) presented to the load. This feature gives the user flexibility in maximizing the power available to the load.

A wide-bandwidth multiloop design is used for state-of-the-art compensation. This produces ideal behavior and results in ultra-low distortion values.

Aluminum extrusions have been widely used for heatsinks in power amplifiers due to their low cost and reasonable performance. However, measured on a watts per pound or watts per volume basis, the extrusion technology doesn't perform nearly as well as the thermal diffuser technology developed for the Macro Reference.

Our thermal diffusers are fabricated from custom convoluted fin stock that provides an extremely high ratio of area to volume, or area to weight. Since all the output devices are mounted directly to the diffusers they are electrically "live." Making them electrically live allows improved thermal performance by eliminating the insulating interface underneath the output devices. The chassis itself is used as part of the thermal circuit, maximizing available cooling resources.

Circuit Theory

Power is provided by low-field toroidal power transformer T1. The secondaries of T1 are full-wave rectified by D17, D18, D1-4 and filtered by large computer-grade capacitors. A thermal switch embedded in the transformer protects it from overheating.

Monolithic regulators provide a regulated ± 15 volts.

STEREO OPERATION

For simplicity, the discussion of stereo operation will refer to one channel only. Mono operations will be discussed later.

Please refer to the block diagram on page 24 and the schematics provided with your amplifier.

The input signal at the phone jack passes directly into the balanced gain stage (U104-A). Use of a *P.I.P.* module for input signal causes the input signal to pass through the *P.I.P.* and then to the balanced gain stage.

The balanced gain stage (U104-A) causes balanced-to-single-ended conversion to take place using a difference amplifier. From there, gain is controlled with the front-panel level controls and the internal input sensitivity switch. (The input sensitivity switch is located through the *P.I.P.* opening in the rear panel. See page 21.) The error amp (U104-C) amplifies the difference between the output signal and the input signal from the gain stage, and drives the voltage-translator stage.

The voltage-translator stage channels the signal to the Last Voltage Amplifiers (LVA), depending on the signal polarity, from the error amp U104-C. The +LVA (Q104,Q105) and the -LVA (Q110,Q111), with their push-pull effect through the bias servo Q318, drive the fully complementary output stage.

The bias servo Q318 is thermally coupled to the thermal diffuser, and sets the quiescent bias current in the output stage to lower the distortion in the crossover region of the output signal.

With the voltage swing provided by the LVAs, the signal then gains current amplification through the triple Darlington emitter-follower output stage.

The bridge-balanced circuit (U104-D) receives a signal from the output of the amplifier, and differences it with the signal at the VCC supply. The bridge-balanced circuit then develops a voltage to drive the bridge-balanced output stage. This results in the VCC supply having exactly one-half of the output voltage added to their quiescent voltage. D309, D310, D311 and a trimmer resistor set the quiescent current point for the bridge-balanced output stage.

The protection mechanisms that affect the signal path are implemented to protect the amplifier under real-world conditions. These conditions are high instantaneous current, excessive temperature, and operation of the output devices outside safe conditions.

Q107 and Q108 act as a conventional current limiter, sensing current in the output stage. When current at any one instant exceeds the design criteria, the limiters attenuate the drive from the LVAs, thus limiting current in the output stage to a safe level.

To further protect the output stages, a specially developed *ODEP* circuit is used (Output Device Emulator Protection). It produces an analog output proportional to the always-changing *safe operating area* margin of the output transistor. This output controls the translator stage previously mentioned, removing any further drive that may exceed the *safe operating area* of the output stage.

Thermal sensor S100 gives the *ODEP* circuits vital information on the operating temperature of the thermal diffusers on which the output devices are mounted.

Should the amplifier fail in such a way that would cause DC across the output lead, the DC protection circuit senses this and shuts down the power supply until the DC is removed.

BRIDGED-MONO OPERATION

By setting the rear panel Stereo-Mono switch to BRIDGED-MONO, the user can convert the amplifier into a bridged-mono amplifier. With a signal applied to the Channel 1 input jack, and the load between the red banana posts on the back panel, a double-voltage output occurs.

The Channel 1 output feeds the Channel 2 error amp U204-C. Since there is a net inversion, Channel 2 output is out of polarity with Channel 1. This produces twice as much voltage across the load. Each of the channel's protection mechanisms work independently if a fault occurs.

PARALLEL-MONO OPERATION

With the Stereo-Mono switch set to PARALLEL-MONO, the output of Channel 2 is paralleled with that of Channel 1. A suitable high-current-handling jumper must be connected across the red banana posts to gain the benefits of this mode of operation.

The signal path for Channel 1 is the same as previously discussed, except that Channel 1 also drives the output stage of Channel 2. The balanced input, error amp, translators, and LVAs of Channel 2 are disconnected and no longer control the Channel 2 output stage. The Channel 2 output stage and protection mechanisms are also coupled through S1 and function as one.

In PARALLEL-MONO mode, twice the current of one channel alone can be obtained. Since the *ODEP* circuit of Channel 2 is coupled through S1, this gives added protection if a fault occurs in the Channel 2 output stage. The *ODEP* circuit of Channel 2 will limit the output of both output stages by removing the drive from the Channel 1 translator stages.

Specifications

Performance

Note: 8 ohm loads were used unless specified otherwise.

Frequency Response: ± 0.1 dB
20 Hz to 20 kHz at 1 watt.

Signal to Noise Ratio: Greater than 120 dB (A-weighted) below rated output at 26 dB gain.

Bandwidth: 3 Hz to 100 kHz.

IM Distortion: Less than 0.005% from 760 watts through -10 dB, increasing smoothly to a maximum of 0.025% at -40 dB, measured at 26 dB gain.

Damping Factor: Greater than 20,000 from 10 Hz to 200 Hz, 1,800 at 1 kHz.

Power

Power Bandwidth:
10 Hz to 25 kHz -1.0 dB.
7 Hz to 27 kHz -1.5 dB.
5 Hz to 28 kHz -2.0 dB.
4 Hz to 30 kHz -3.0 dB.

Output Power:

Note: Watts per channel in STEREO mode with 0.02% or less THD while both channels driven.

760 watts into 8 ohms.
1,160 watts into 4 ohms.
1,500 watts into 2 ohms.

Load Impedance: Rated for 16, 8, 4, and 2 ohm usage only. Safe with all types of loads, even reactive ones.

Required AC Mains: 60 Hz, 120 VAC ($\pm 10\%$). Draws 70 watts or less at idle. Draws as high as 26 amps with a continuous 1 kHz sinewave output of 760 watts into 8 ohms in STEREO mode.

It is extremely important to have adequate AC power available to the amplifier. Power amplifiers cannot create energy—they must have the required voltage and current to deliver the undistorted rated wattages you expect.

Controls

Enable: A pushbutton located on the front panel to turn the amplifier on and off.

Level: A signal level control with 31 detents for each channel, located on the front panel.

Stereo-Mono: A three-position switch located on the back panel which selects between STEREO, BRIDGED-MONO, and PARALLEL-MONO modes of operation.

Input: A two-position switch located inside the amplifier selects between two input

sensitivities. (A voltage gain of 26 dB or a sensitivity of 0.775 V for full rated output.)

Dynamic Range / Level Meter:

A two-position switch located behind the front panel sets the display meter on the front panel as either a dB Dynamic Range meter or a dB Level meter.

Ground Lift: A two-position switch located on the back panel which can be used to isolate the audio signal ground from the chassis (AC) ground.

Reset: A 30-amp circuit breaker located on the back panel which protects the power supplies.

Indicators

Enable: This indicator is on while the amplifier is on to show that the low-voltage power supply is operating.

ODEP: Two multifunction indicators which show the thermal-dynamic reserve energy status of each channel. Normally they are brightly illuminated to show that reserve energy is available. In the rare event there is no reserve, they will dim in proportion to ODEP limiting. They remain off if a tripped breaker, blown fuse or thermal shutdown occurs. (In the case of a thermal shutdown, the ampli-

fier will automatically return to normal operation after cooling.)

IOC: Two indicators which are normally off. In the unlikely event the output waveform differs from that of the input by 0.05% or more, they will flash. In this way, they act as sensitive distortion indicators to provide proof of performance. *Note: It is normal for the Channel 2 IOC indicator to remain on in PARALLEL-MONO mode.*

Signal: Two Signal presence indicators flash in sync with the input signal to show its presence.

Dynamic Range / Level Meter: Two five-segment meters (one per channel) display either the output dynamic range in dB or the output level in dB. (Your unit comes factory-set to display dynamic range.) As dynamic range meters they show the ratio of the peak to average power of each channel. As output level meters they show how high the output levels are relative to full power.

Input/Output

Input Connector: Balanced phone jacks on chassis and internal P.I.P. connector. (Balanced 3-pin XLR connectors are provided on P.I.P.-FX which is a standard feature.)

Input Impedance: Nominally 10 K ohms, balanced. Nominally 5 K ohms, unbalanced.

Input Sensitivity: Switchable between 0.775 V (unbalanced) for rated output or a fixed voltage gain of 26 dB. (See page 21 for more information.)

Output Connector: Color-coded dual binding posts (banana jacks).

DC Output Offset: (Shorted input) ± 2 millivolts.

Output Signal

Stereo: Unbalanced, two-channel.

Bridged-Mono: Balanced, single-channel. Channel 1 controls are active; Channel 2 controls are inactive but not removed from operation.

Parallel-Mono: Unbalanced, single-channel. Channel 1 controls are active; Channel 2 controls are inactive but not removed from operation.

Protection

If unreasonable operating conditions occur the protection circuitry limits the drive level to protect the output transistor stages, particularly in the case of

elevated temperature. Transformer overheating will result in a temporary shutdown of that particular channel. Controlled slew-rate voltage amplifiers protect the unit against RF burnouts. Input overload protection is furnished at the amplifier input to limit current.

Turn On: No dangerous transients. Four second turn-on delay. *Note: This may be changed by resistor substitution. Contact Crown Technical Services Department for details.*

Construction

Black splattered-coat steel chassis and engraved back-lit front panel. Chassis utilizes specially designed "flow-through" ventilation from front to side panels.

Cooling: Convection cooling with computerized, proportional fan assist. Includes custom heat diffusers and patented circuitry to promote uniform dissipation.

Dimensions: 19-inch standard rack mount (EIA Std. RS-310-B), 7-inch height, 16-inch depth behind mounting surface, 2.75 inch in front of mounting surface.

Weight: 56.5 lbs. Center of gravity is approximately 6 inches behind front mounting surface.

Accessory *P.I.P.* Modules

One of the advantages of the Macro Reference is its ability to be quickly customized via *P.I.P.* (Programmable Input Processor) modules. It comes equipped with a *P.I.P.* card edge connector inside the rear panel. The modules install easily as shown below.

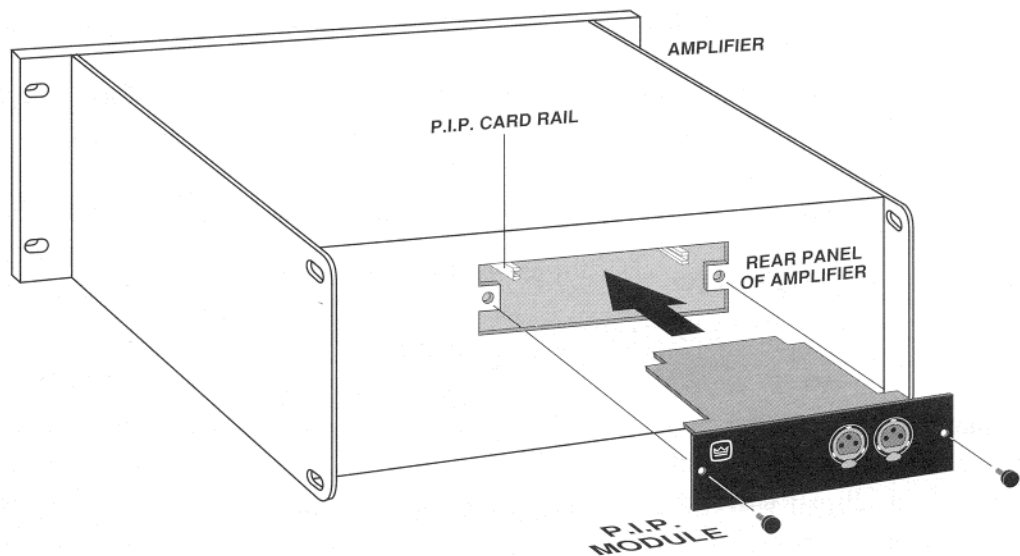

Here are some of the *P.I.P.* modules available:

P.I.P.-AMC is the newest of our *P.I.P.* modules, and combines all the capabilities you need most in one high-performance package. DIP programmable, the AMC features a 4th-order Linkwitz-Riley crossover network, “constant directivity” horn equalization, B_6 vented box equalization and a sign-driven/error-driven variable-threshold compressor. In addition, the AMC can be used for bi-amping, tri-amping, and “daisy chaining” of amplifiers.

P.I.P.-FTE has balanced 1:1 isolation transformers, a 12 dB/octave RF filter, a variable 18 dB/octave subsonic (high-pass filter), and a 6 dB/octave 3 kHz shelving network for “constant-directivity” horn equalization. Special quick-connect barrier blocks (Buchanan connectors) are provided for input.

IQ-P.I.P. integrates the Macro Reference into Crown's patented and expanding *IQ System*[®]. Our *IQ* (Intelligence Quotient) *System* offers centralized remote computer control of 1 to 2,000 amplifiers. (Each channel of each amplifier can be monitored and individually controlled from an inexpensive personal computer. A total of 15 functions can be either monitored or controlled.) Microphone and/or line level signals can also be controlled and routed with optional *MPX-6*[™] multiplexers. And an optional IQ-COM-Q tape controller enables pre-recorded commands to be played back from a simple audio tape deck to control the system, thus eliminating the need to have a computer in the field with each *IQ System*.

P.I.P.-CLP is designed to detect and prevent overload. The same error-detecting circuit that is used to signal the *IOC* indicator is used to activate this error-driven compressor. It is not a typical signal-driven compressor but a circuit to prevent any overload. It can yield up to 13 dB of additional signal safety margin without noticeable program change.

P.I.P.-ISO is designed especially for 25 to 140 V distribution systems where full isolation is required. Using it, along with minor amplifier modifications, the amplifier outputs are safely isolated from both the input terminals and the chassis.

P.I.P.-ATN adds a 32-step precision attenuator to each channel to the features of the P.I.P.-FTE. These include balanced 1:1 isolation transformers, 12 dB/octave RF filter, variable 18 dB/octave subsonic (high-pass) filter, and a 6 dB/octave 3 kHz shelving network.

P.I.P.-XOV is a versatile, economical mono 12 or 18 dB/octave crossover/filter which offers bi-amping and tri-amping capability.

P.I.P.-FMX facilitates "daisy-chaining" several amplifier balanced inputs together. It comes with female-to-male 3-pin XLR connectors which passively bridge the input of the amplifier.

P.I.P.-FXT uses balanced 1:1 transformers to isolate the source from the inputs. It comes with balanced female 3-pin XLR connectors.

Contact your dealer or the Crown Technical Services Dept. for additional information on these and other *P.I.P.s* under development.

Index

- AC Mains 16, 17, 30
- Air Flow 7
- American Wire Gauge (AWG) 13, 14
- Auxiliary Cooling Fan 7

- Balanced Input 11, 12
- Banana Connector 6
- Bandwidth 30
- Bridged-Mono 9, 28, 31

- Center of Gravity 31
- Circuitry 17, 24, 25-29
- Cleaning 22
- Construction 31
- Controls 5, 6, 20-22, 30
- Cooling 4, 7, 31
- Current Headroom 3

- Daisy Chaining 11, 32
- Damping 2
- Damping Factor 2, 14, 30
- DC Output Offset 31
- Dimensions 31
- Distortion Meter 3
- Dust Filter 5, 22
- Dynamic Range 2
- Dynamic Range Meter 5, 19, 20, 30, 31

- Enable 5, 18, 30
- Energy Reserves 3
- Equipment Rack 7
- Excursion Control 3
- Expansion 4

- Factory Service 23
- Feedback Oscillation 13
- Filter 5, 22
- Four-Quadrant Topology 25
- Frequency Response 30
- Front Panel Removal 20
- Fuse 16

- Ground Lift 6, 21, 30
- Ground Loops 13

- Grounded Bridge 25-29

- High-Frequency Oscillations 15
- High-Pass Filter 15

- Indicators 5, 18, 30-31
- Input 6, 11, 21, 30, 31
- Input Impedance 31
- Input Sensitivity 21, 30, 31
- Input/Output Comparator (*IOC*) 3, 5, 19, 31
- Intermodulation (IM) Distortion 30
- Isolation 32

- Level Control 5, 20, 30
- Level Meter 5, 19, 20, 30, 31
- Load Impedance 30
- Load Protection 16
- Loudspeaker Cables 13-15
- Loudspeaker Fuse 16
- Loudspeaker Impedance 14
- Loudspeaker Wire Gauge 14
- Low-Frequency Output 3
- Low-Impedance Loads 3

- Magnetic Field Efficiency 2

- ODEP* Limiting 3-4, 18-19
- Operation 17
- Output 13, 31
- Output Connector 6
- Output Device Emulator Protection (*ODEP*) 3, 4, 5, 18-19, 25-29, 30
- Output Power 30

- P.I.P.-FX 6, 11
- Parallel-Mono 10, 29, 31
- Performance 30
- Phone Jack Input 6
- Programmable Input Processor (*P.I.P.*) 4, 6, 11, 32-33
- Power 3, 30
- Power Bandwidth 30
- Power Cord 6
- Power Handling Capacity 13

- Precautions 17
- Prefilter 7
- Proof of Performance 19
- Protection 3-4, 16, 25-29, 31

- Rack Cabinet 7
- Radio Frequencies (RF) 12
- Remote Control 4, 33
- Reset Switch 6, 22
- RF Filters 12

- Safe Operating Area (SOA) 18-19, 28
- Sensitivity 21, 30, 31
- Service 22, 23
- Shipping 23
- Signal Presence Indicator 5, 19, 31
- Signal to Noise Ratio 30
- Source Impedance 14
- Specifications 30-31
- Stereo 8, 26-28, 31
- Stereo-Mono Switch 6, 8-10, 17, 30
- Subsonic Frequencies 11
- Subsonic Low-Frequency Currents 15

- Technical Information 25
- Technical Service 23
- Thermal Diffuser 4, 25-28
- Thermal-Dynamic Energy Reserve 3, 5, 18
- Toroid 2, 3
- Transients 25, 31
- Transformer 2, 3
- Turn On 31

- Unbalanced Input 11, 12

- V-I Limiting 3
- Voltage Headroom 3

- Warranty Service 23
- Weight 31
- Wiring 8-16, 17

- XLR Input 6, 11