

**SCHEMATIC
DIAGRAM**

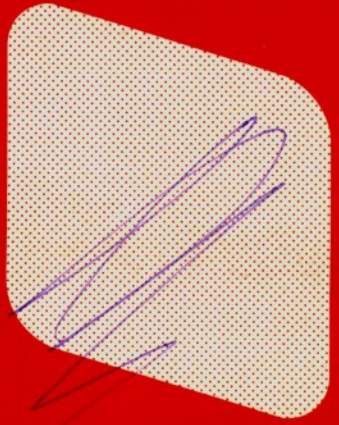

C R U M A R[®]
Musical Instruments

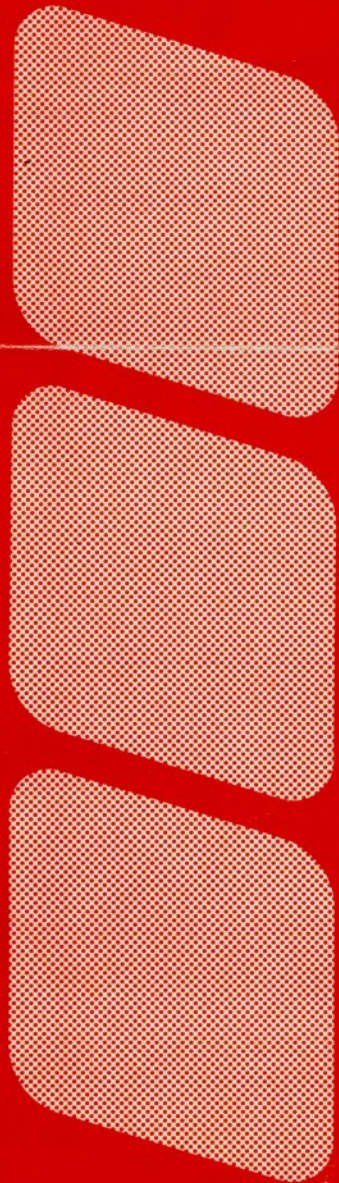
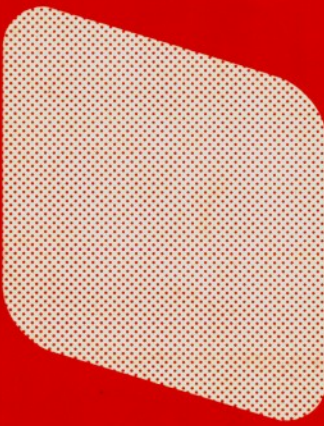

**mod.
trilogy**



FEMALE CONNECTOR SYMBOL (es. J 2/1)



PLUG IN CONNECTOR SYMBOL



WIRE SOLDERING POINT



TEST POINT (T P...)



CONNECTING POINT (ON p.c.b.)



METALLIC FILM RESISTOR 1%

ALL resistors 1/4w unless otherwise indicated

ALL tabswitches shown in OFF position

ALL keyswitches shown in OFF position

See part list for component part numbers

**CRUMAR RESERVES THE RIGHT TO CHANGE
SPECIFICATIONS AND DESIGNS, WITHOUT
NOTICE AND LIABILITY.**

INDEX

- DWG 1 (P-857/2) = OSCILLATOR ONE - OSCILLATOR TWO
- DWG 1 (P-895) = PRESETS AND PITCH CONTROLS BOARD
- DWG 2 (P-840) = TDA 1008 MODULE BOARD
- DWG 2 (P-849) (A) = SOUND MOTHER BOARD
- DWG 2 (P-558) = KEYSWITCHES BOARD
- DWG 3 (P-849) (B) (C) = SOUND MOTHER BOARD
- DWG 4 (P-850/2) = SWITCHES BOARD
- DWG 5 (P-853/2) = ORGAN BOARD
- DWG 5 (P-874/2) = LFO BOARD
- DWG 5 (P-928) = GLIDE BOARD
- DWG 6 (P-897) = DELAY LINES BOARD
- DWG 6 (P-898) = STRINGS FILTER AND OSCILLATORS
- DWG 7 (P-878) = PRESETS BOARD
- DWG 7 (P-895) = PRESETS AND PITCH CONTROLS BOARD
- DWG 7 (P-896) = A.D.S.R. CONTROLS
- DWG 7 (P-893) = A.D.S.R. PRESETS
- DWG 7 (P-894) = E.C.R. PRESETS
- DWG 8 (P-855/2) = FILTER BOARD (VCF - VCA - ADSR)
- DWG 8 (P-876/2) = FILTER MOTHER BOARD
- DWG 9 (P-852) = POWER SUPPLY

See part list for component part numbers

CRIBBIA RESERVES THE RIGHT TO CHANGE SPECIFICATIONS AND DESIGN WITHOUT NOTICE AND LIABILITY.

BLOCK AND WIRING DIAGRAM

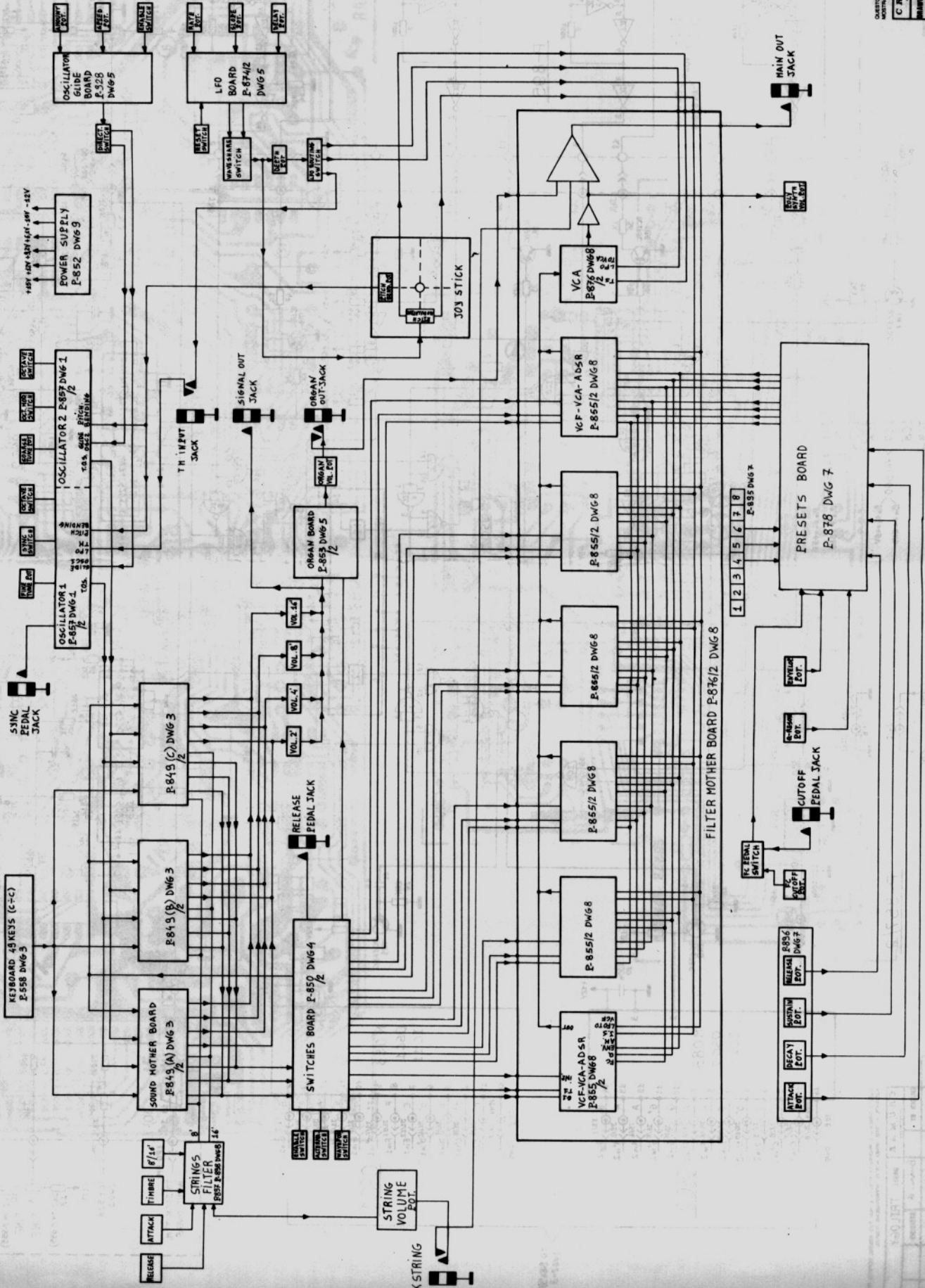

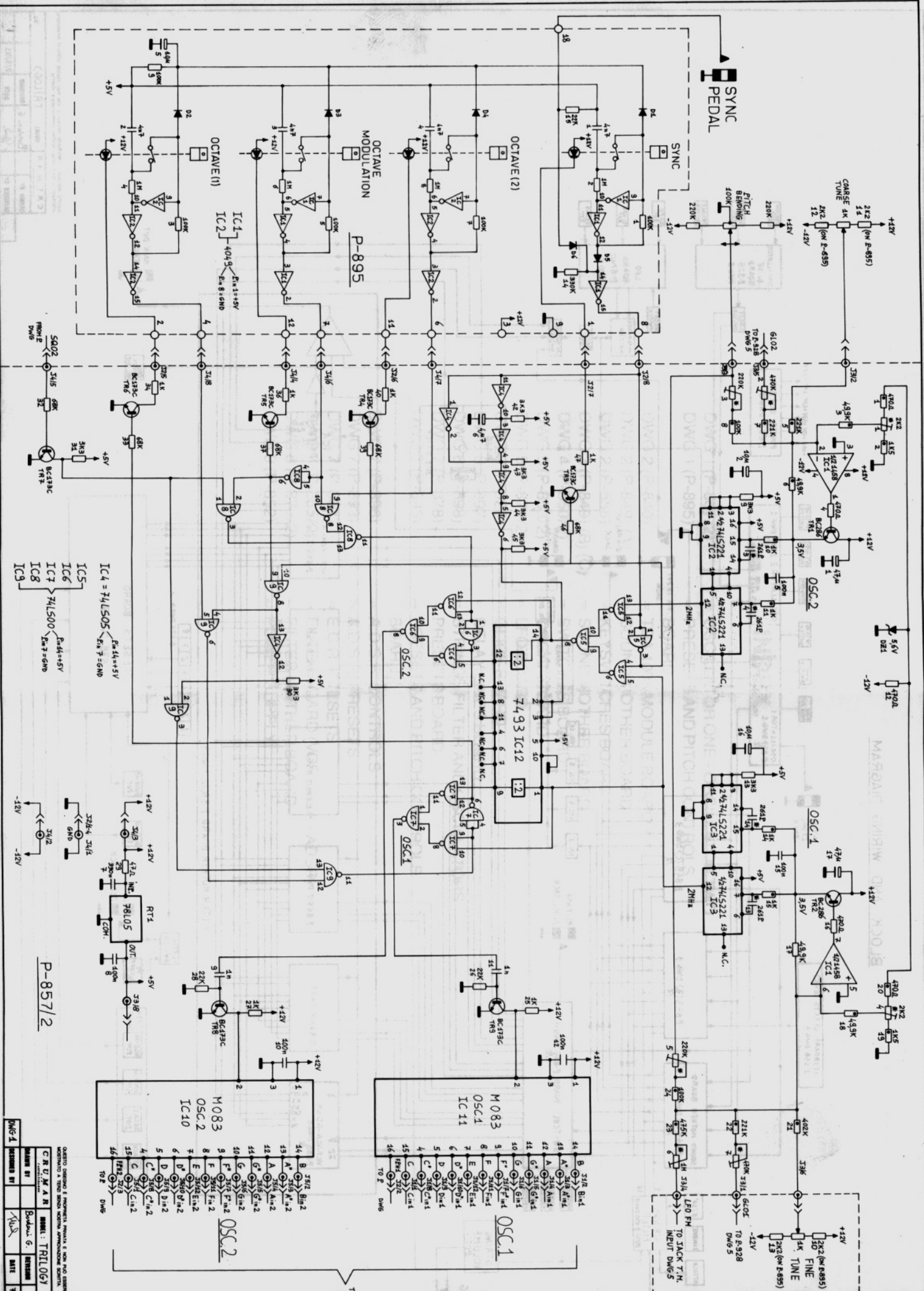

P-857/2

DESIGNER	CRU/MAR
REVISION	REV. 1
DATE	11/51
APPROVED	TRIL067
REVISION	REV. 1
DATE	11/51

IC1	4049	Pin 11 = +5V
IC2	4049	Pin 8 = +5V
IC3	74LS00	Pin 14 = +5V
IC4	74LS05	Pin 14 = +5V
IC5	74LS00	Pin 14 = +5V
IC6	74LS00	Pin 14 = +5V
IC7	74LS00	Pin 14 = +5V
IC8	74LS00	Pin 14 = +5V
IC9	74LS00	Pin 14 = +5V
IC10	74LS05	Pin 14 = +5V

OSC 1	74LS12	Pin 1 = +5V
OSC 2	74LS12	Pin 1 = +5V

M083	74LS12	Pin 1 = +5V
M083	74LS12	Pin 1 = +5V

OSC 1	74LS12	Pin 1 = +5V
OSC 2	74LS12	Pin 1 = +5V

OSC 1	74LS12	Pin 1 = +5V
OSC 2	74LS12	Pin 1 = +5V

OSC 1	74LS12	Pin 1 = +5V
OSC 2	74LS12	Pin 1 = +5V

OSC 1	74LS12	Pin 1 = +5V
OSC 2	74LS12	Pin 1 = +5V

OSC 1	74LS12	Pin 1 = +5V
OSC 2	74LS12	Pin 1 = +5V

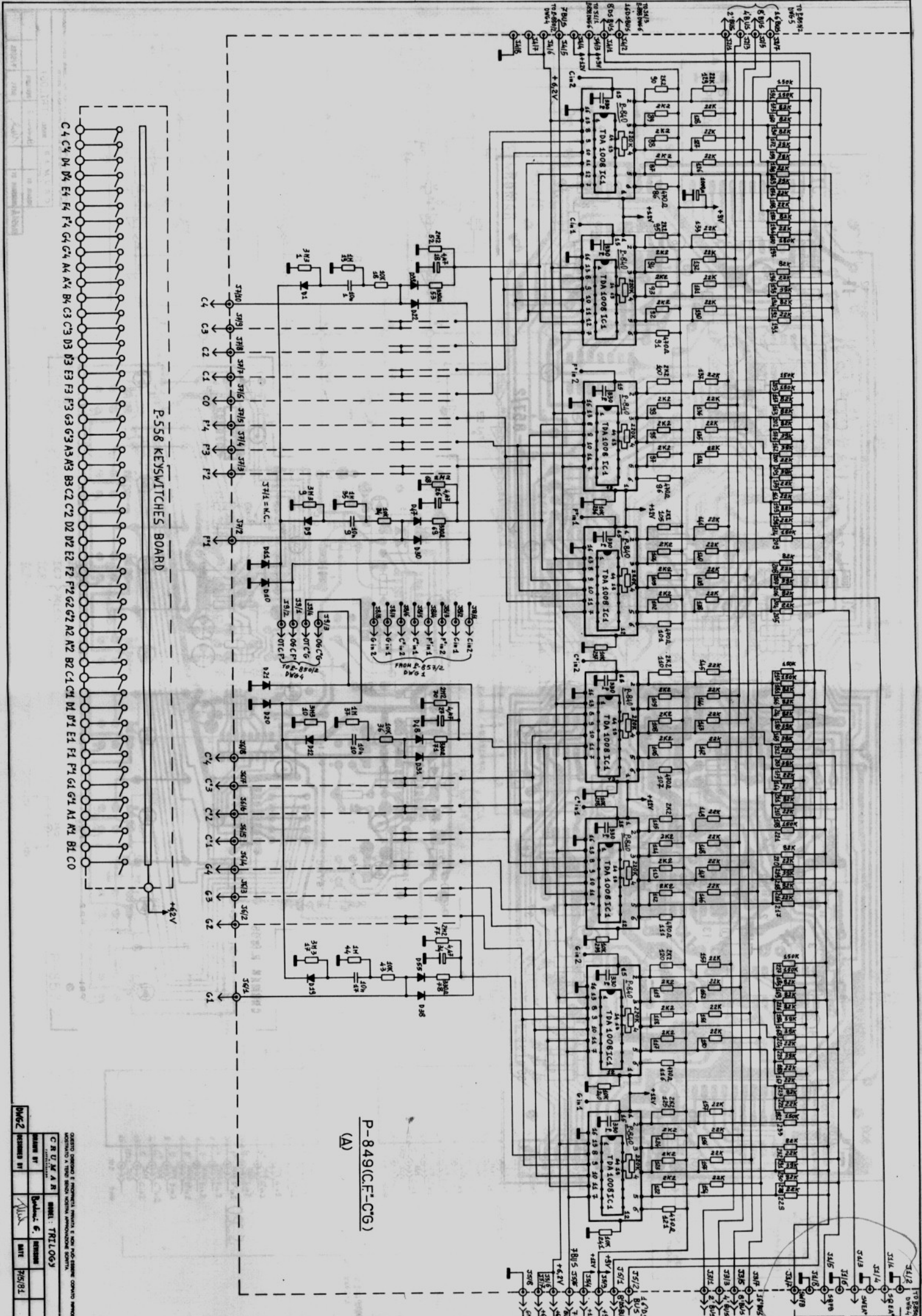

P-849(C.F.-C'6)
(A)

DATE	7/5/81
DESIGNED BY	TRILOGY
DESIGNED BY	TRILOGY
DESIGNED BY	TRILOGY
DESIGNED BY	TRILOGY
DESIGNED BY	TRILOGY

PROGETTO	REVISIONI	DATA

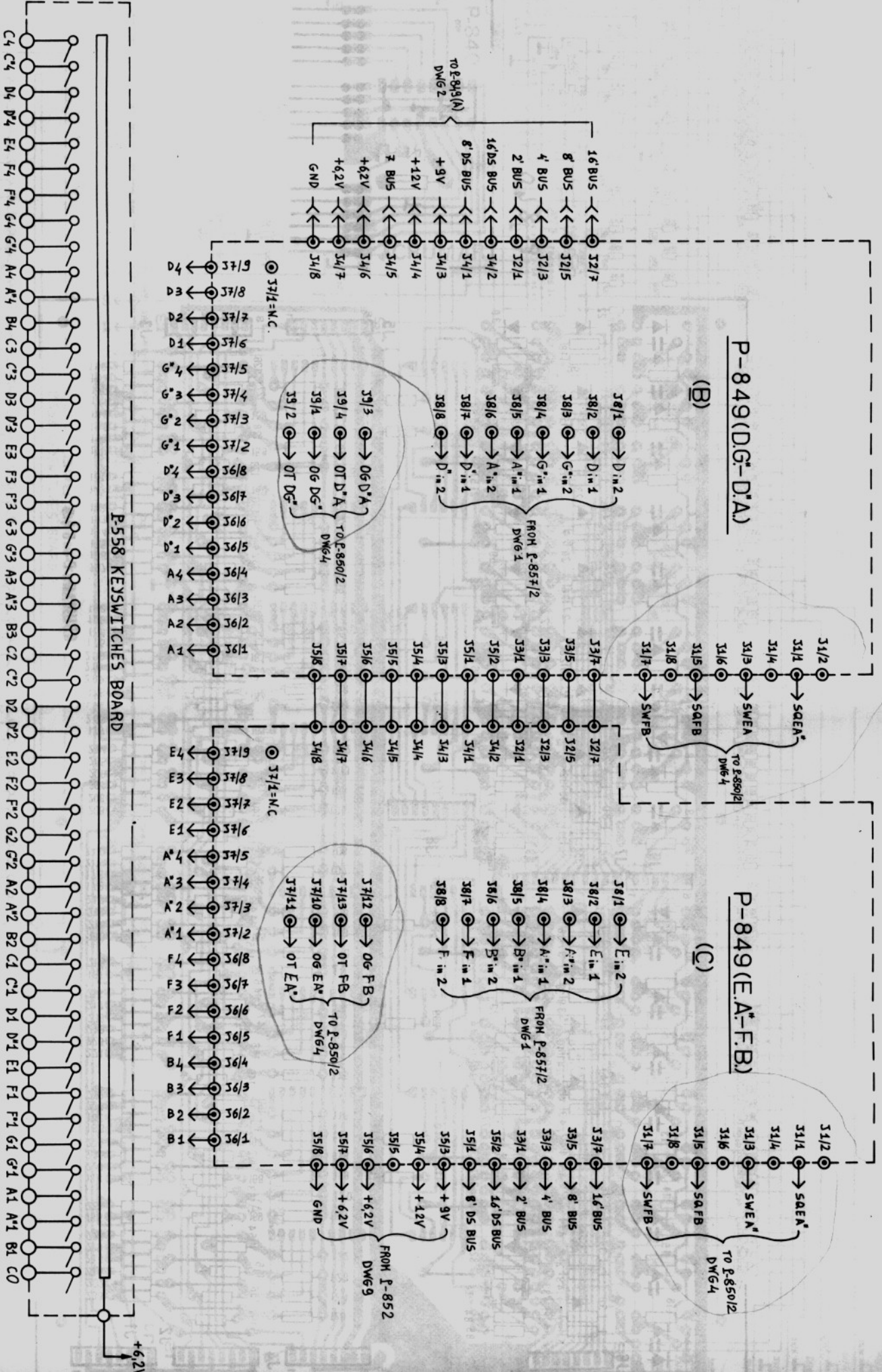

P-849(DG-D'A)
(B)
P558 KEYSWITCHES BOARD

P-849(E.A-F.B)
(C)

CRUMAR	MODEL: TRILOGY
DRAWN BY	REVISION
DESIGNED BY	DATE

QUESTO DISEGNO È PROPRIETÀ PRIVATA E NON PUÒ ESSERE COPiato
MOSTRANDO A TERZI SENZA NOSTRA APPROVAZIONE SCRITTA

FROM P-845(A)-(B)-(C) DWG 2-3

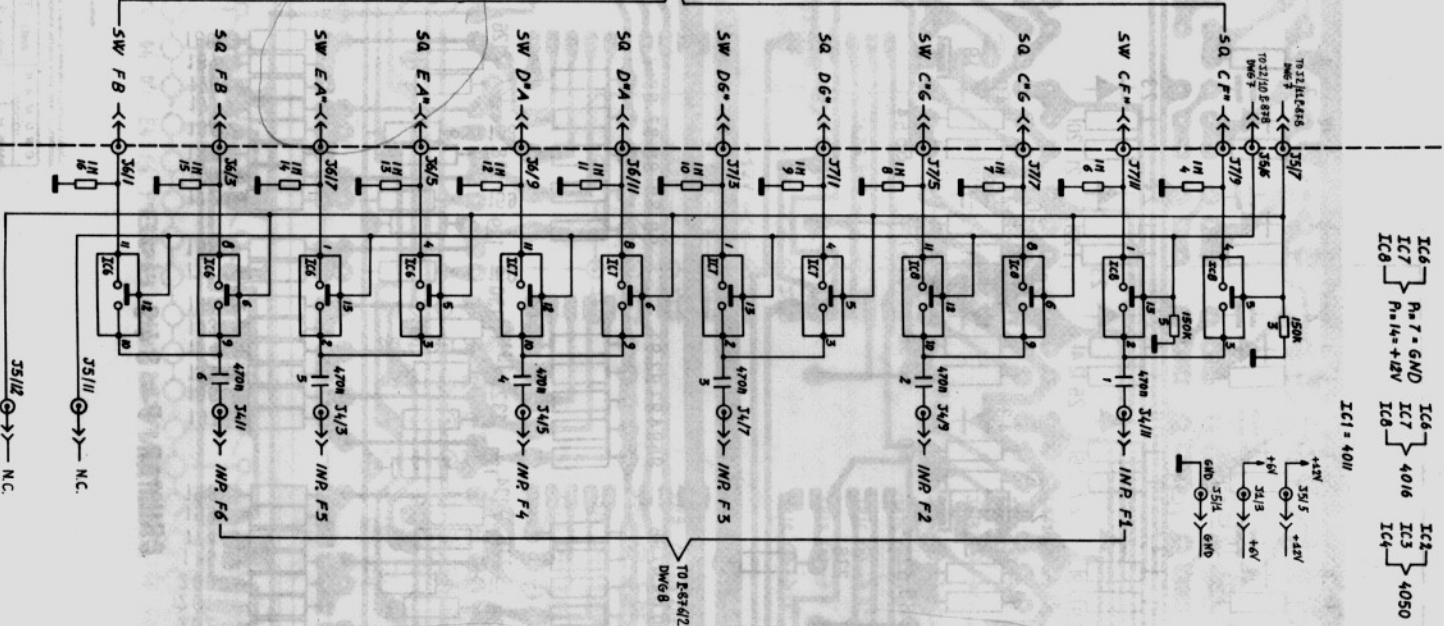

FROM P-845(A)-(B)-(C) DWG 2-3

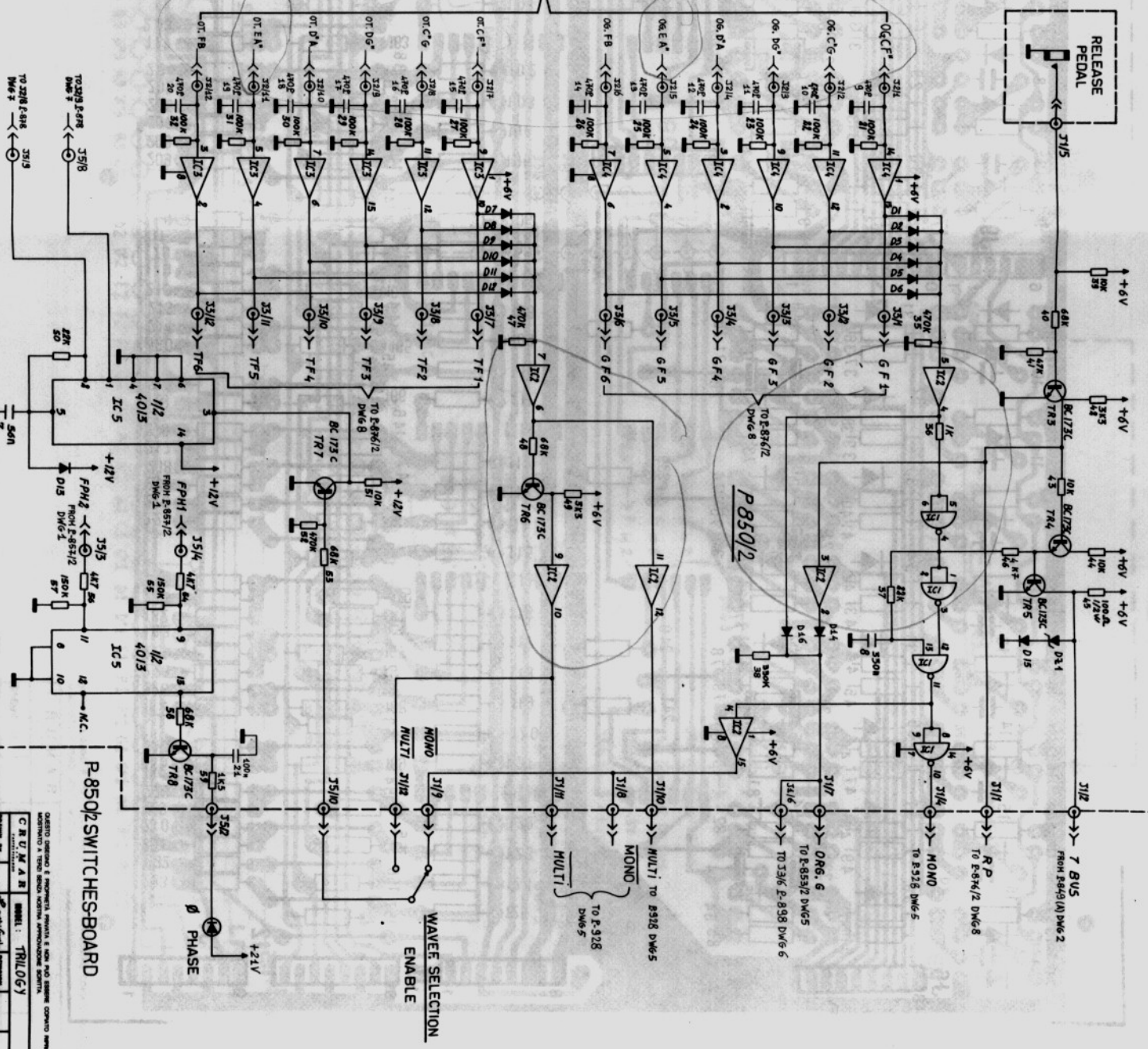

P-8502 SWITCHES-BOARD

WAVE SELECTION
ENABLE

DESIGNO DIBIENO E INGENIERIA FINALE E NON HO SENZA CONTA INNOVATO
AUTORE E TITO ENZO NERINI AMMINISTRATORE SCIENTIFICO

MODEL :	TRILOGY
REVISIONE :	
DATA :	
PROGETTA :	
VERIFICA :	
APPROVA :	
DATA :	

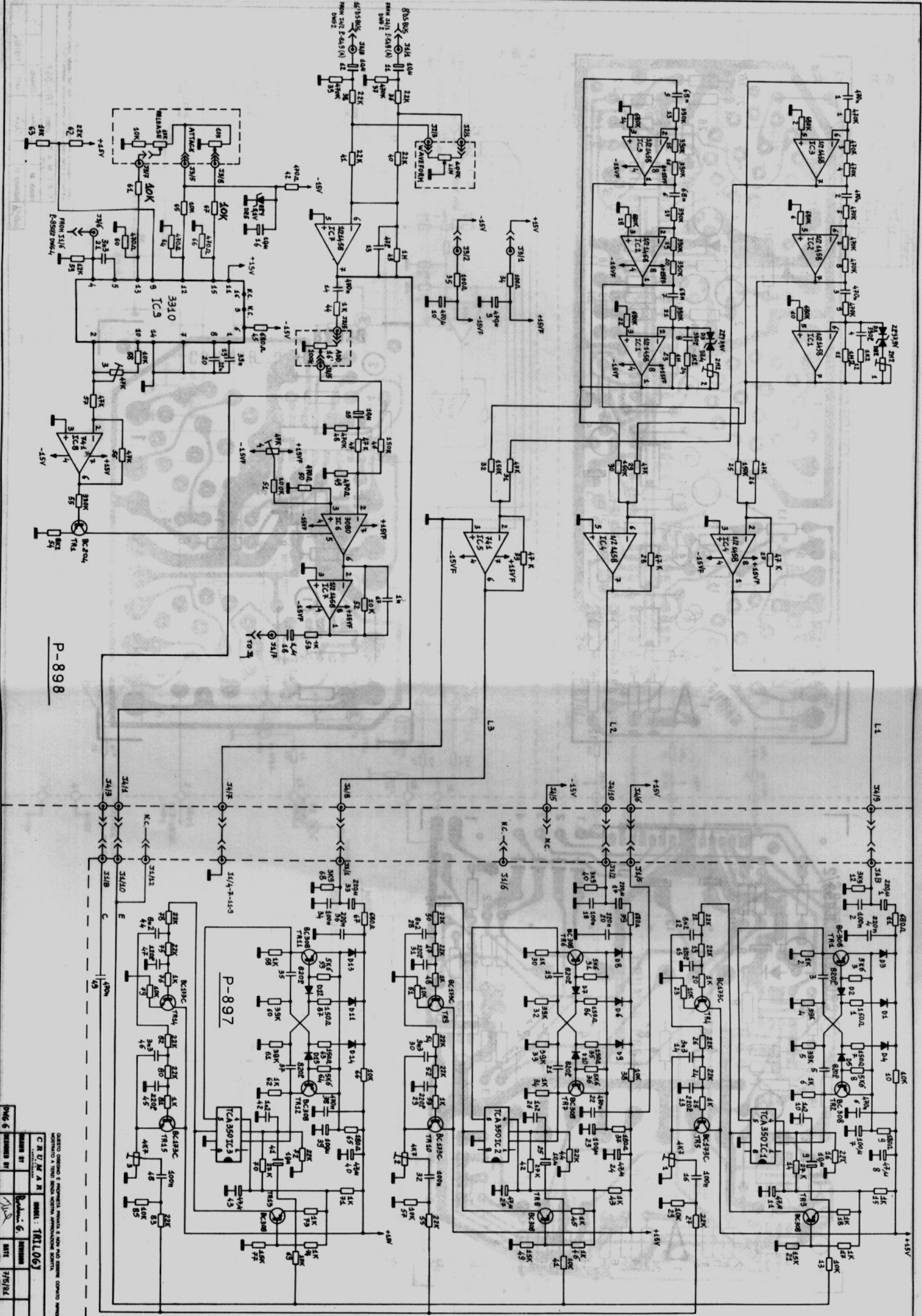

P-898

P-897

DESIGNED BY	REVIEWED BY	DATE
DRG 6	DRG 6	7/5/84

CONTROL SYSTEMS & ELECTRONICS DIVISION
 GENERAL ELECTRIC COMPANY
 1000 CENTRAL EXPRESSWAY
 PITTSBURGH, PA 15201
 TEL: 412-251-1000
 FAX: 412-251-1001

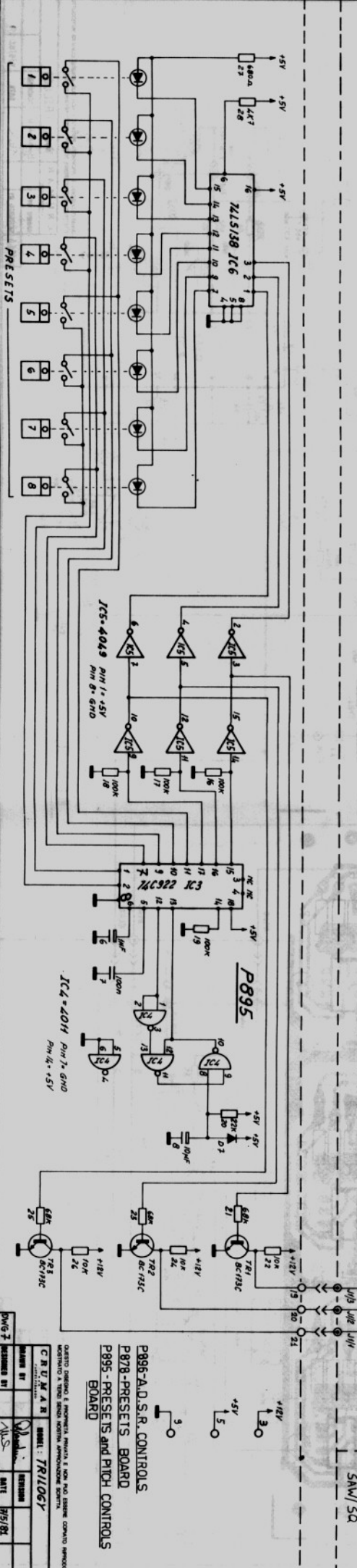
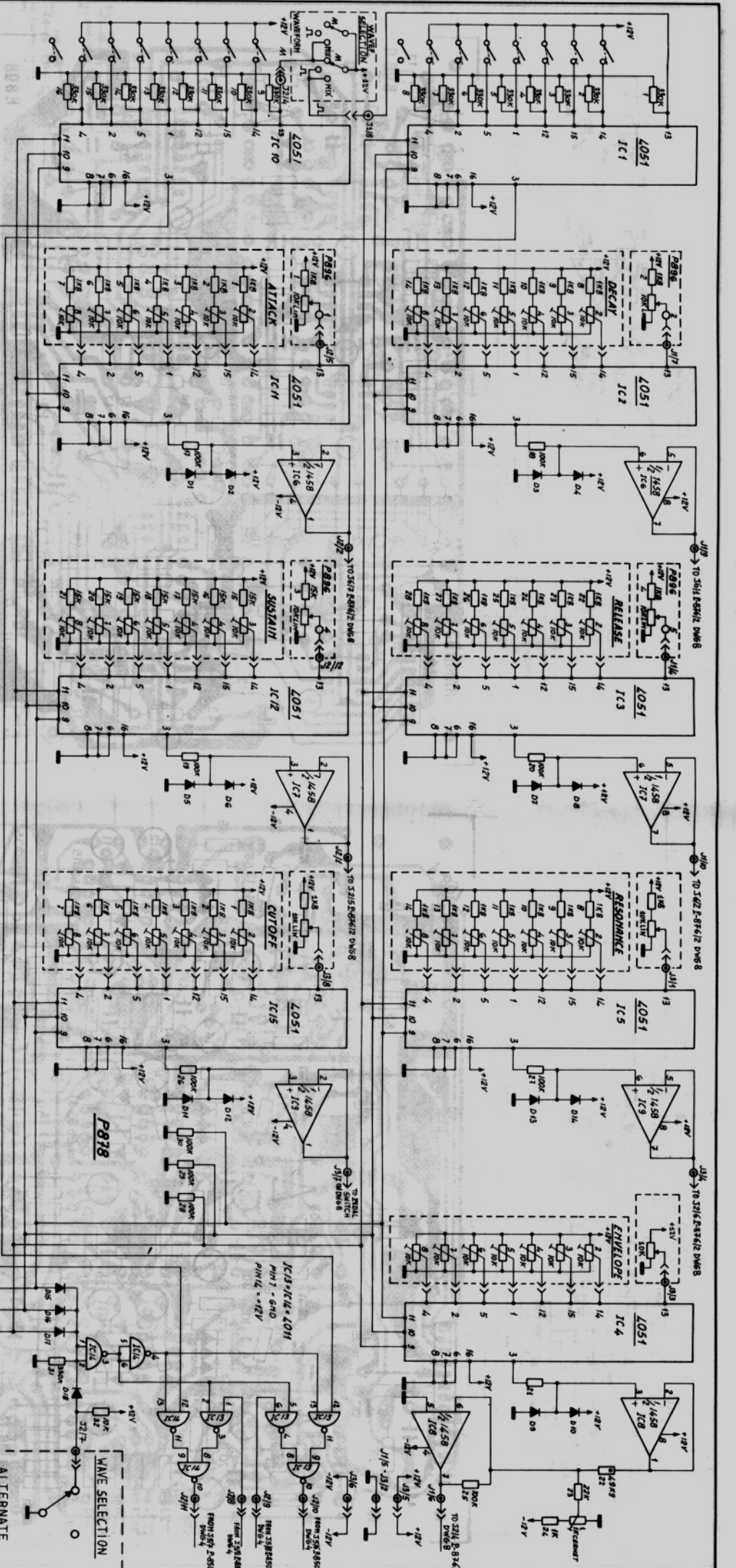

P895-AD-S.R. CONTROLS
P878-PRESETS BOARD
P895-PRESETS and PITCH CONTROLS BOARD

DESTRO DIBIENO E INVERTITA PIU'VELA E NON HO SENNA CONTRO INVERTITTO
 CONTRO INVERTITTO SENNA INVERTITTO CONTRO INVERTITTO

REVISIONI	REVISIONI
DATA	DATA
REVISIONI	REVISIONI
DATA	DATA

MODEL: **TRIOLOV**
 DATA: **19/5/81**

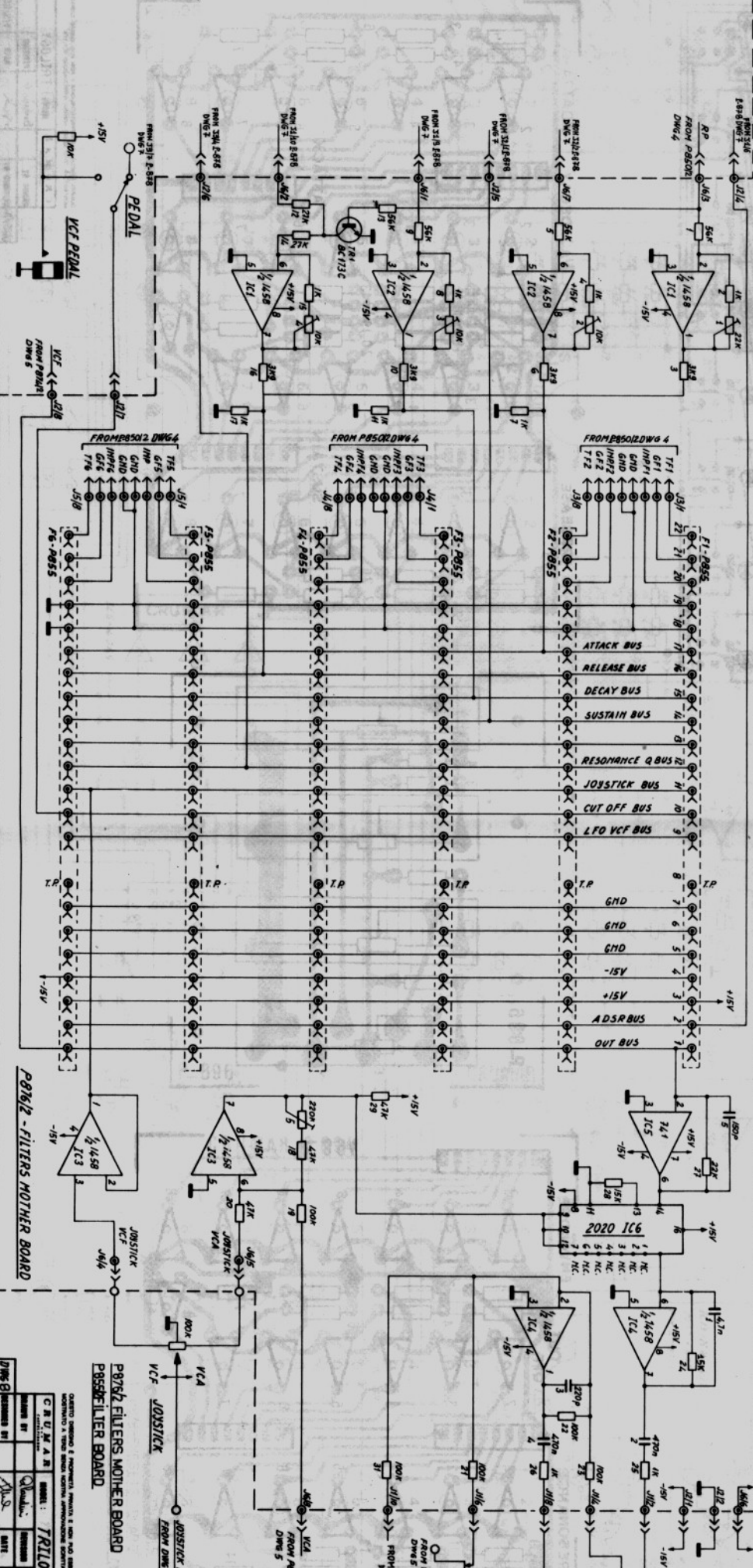
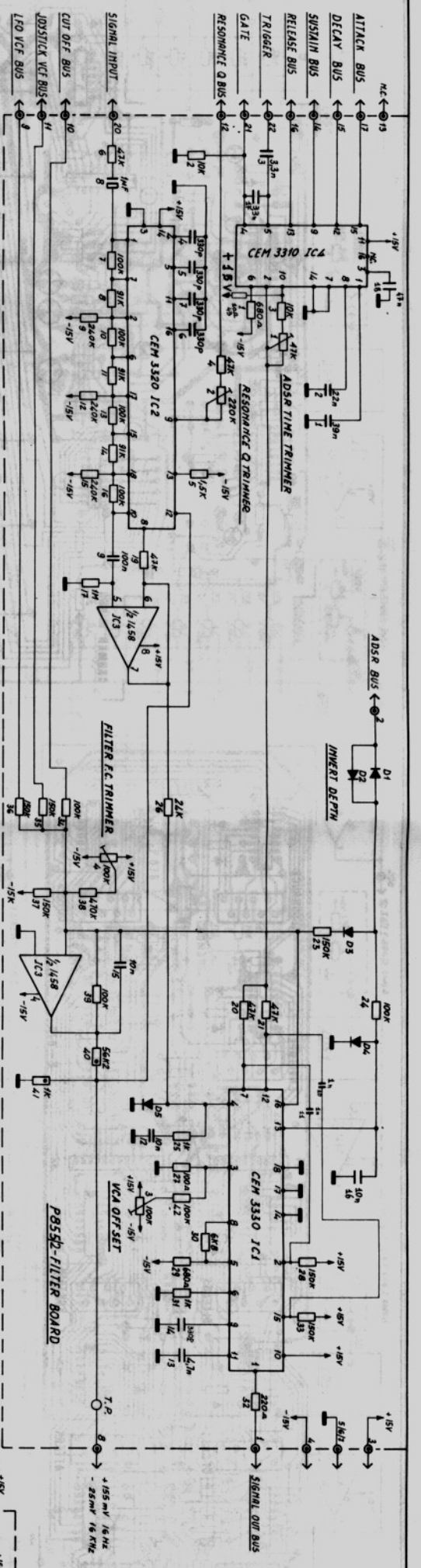

P8762 - FILTERS MOTHER BOARD

P8550 - FILTER BOARD

P8762 FILTERS MOTHER BOARD

P8550 FILTER BOARD

ORDERED FROM: TRILOGY

DATE	REV	BY	CHKD
10/15/85	1	TRILOGY	TRILOGY
10/15/85	1	TRILOGY	TRILOGY
10/15/85	1	TRILOGY	TRILOGY
10/15/85	1	TRILOGY	TRILOGY

ORDERED FROM: TRILOGY
 ORDERED FROM: TRILOGY
 ORDERED FROM: TRILOGY
 ORDERED FROM: TRILOGY
 ORDERED FROM: TRILOGY

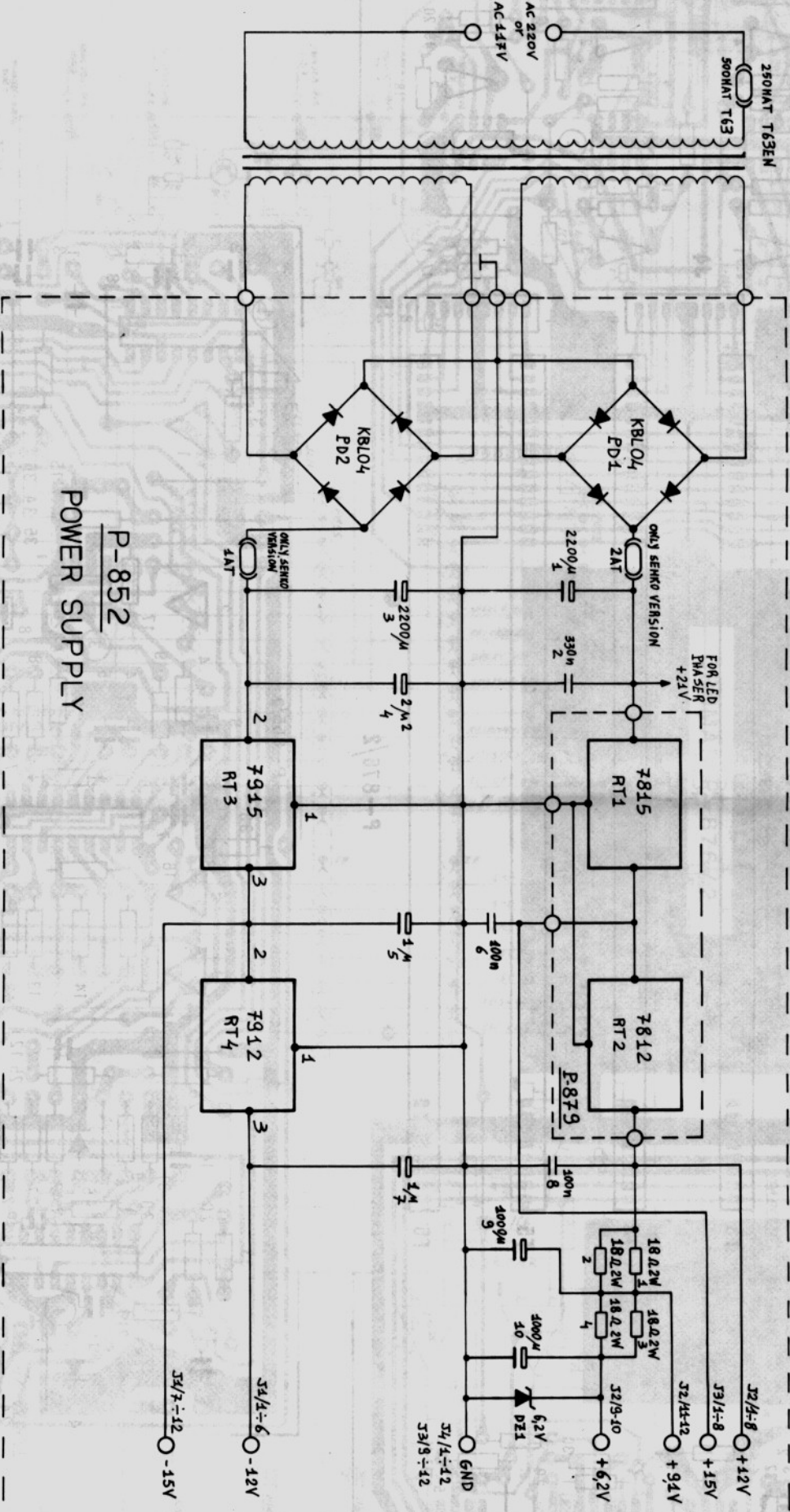

P-852
POWER SUPPLY

QUESTO DISEGNO È PROPRIETÀ PRIVATA E NON PUÒ ESSERE COPiato RIPRODOTTO MOSTRATO A TERZI SENZA NOSTRA APPROVAZIONE SCRITTA.

CRUMAR		MODEL: TRILOGY	
DRAWN BY	Bondani G.	REVISION	
DESIGNED BY	Mua	DATE	7/5/84

MODEL TRILOGY

ELECTRONIC COMPONENT LIST

MODEL TRILOGY

ELECTRONIC COMPONENT LIST

Schem. Ref.	Circuit	Type	Part Code
-------------	---------	------	-----------

Schem. Ref.	Circuit	Type	Part Code
-------------	---------	------	-----------

OSCILLATOR ONE - OSCILLATOR TWO (DWG 1)

P-857/2	Complete with Components		978002579
IC1	Dual Operational Amplifier	1458	68000053
IC2 - IC3	Master Oscillator	74LS221	68000058
IC4	Hex inverter open Collector LS-TTL	74LS05	68000116
IC5 ÷ IC9	Quad 2 - Input NAND Gates LS-TTL	74LS00	68000117
IC10 - IC11	T.O.S.	M083	68070129
IC12	4-Bit Binary counter LS-TTL	74LS93	68020127
TR1 - TR2	Power transistor NPN	BC286	62110002
TR3 ÷ TR9	Transistor NPN	BC173C	62120003
DZ1	Diode Zener	ZPY 5.6 V	67000017
RT1	Voltage Regulator	7805	62110023

PRESETS AND PITCH CONTROLS BOARD (DWG 1)

P-895	Complete with Components		978002520
IC1 - IC2 - IC5	Buffer	4049	68010131
IC3	Encoder	74C922	68000110
IC4	NAND Gate	4011	68000034
IC6	Decoder	74LS138	68020153
TR1 - TR3	NPN Transistor	BC173C	62120003
D1 ÷ D7	Diodes	BA130	65000001

TDA 1008 MODULE BOARD (DWG2)

P-840	Complete with Components		978002433
IC1	Frequency divider	TDA1008	68000104

SOUND MOTHER BOARD (DWG2)

P-849 (A)	Complete with Components		978002531
D1 ÷ D55	Diodes	BA130	65000001

KEYSWITCHES BOARD (DWG2)

P-558	Complete with Components		978002484
-------	--------------------------	--	-----------

SOUND MOTHER BOARD (WDG3)

P-849 (B) (C)	Complete with Components		978002448
D1 ÷ D52	Diodes	BA130	65000001

SWITCHES BOARD (DWG4)

P-850/2	Complete with Components		978002530
IC1	Quad 2-Input Nand Gates CMOS	4011	68000034
IC2 ÷ IC4	Hex Non-inverting buffer CMOS	4050	68000085
IC5	Dual D Flip-flop CMOS	4013	68010136
IC6 ÷ IC8	Quad bilateral switch	4016	68000072
TR3 ÷ TR8	Transistor NPN	BC173C	62120003
D1 ÷ D14	Diodes	BA130	65000001
DZ1	Diode Zener	ZPY2,1V	67000022

ORGAN BOARD (DWG5)

P-853/2	Complete with Components		978002516
IC1	Operational transconductance amplifier	3080	68000066
IC2	Operational amplifier	741	68000059
IC3	Dual operational amplifier	1458	68000054
IC4	Operational amplifier	741	68000059
TR1	Transistor NPN	BC173C	62120003
TR2	Transistor PNP	BC308	62210001
D1	Diode	BA130	65000001

LFO BOARD (DWG5)

P-874/2	Complete with Components		978002535
IC1 - IC2	Dual operational amplifier	1458	68000053
IC3	Timer	555	68030137
IC4	Operational amplifier	741	68000059
IC5	Operational transconductance amplifier	3080	68000066
TR1	Transistor PNP	BC204	62210001
TR2	Fet	BF245B	62120002
TR3 ÷ TR5	Transistor NPN	BC173C	62120003
D1 - D2	Diodes	BA130	65000001

GLIDE BOARD (DWG5)

P-928	Complete with Components		978002570
IC1	Complete with Components	741	68000059
IC2	Operational amplifier	3310	68030142

DELAY LINES BOARD (DWG6)

P-897	Complete with Components		978002522
IC1 ÷ IC3	Analog Delay Line	TCA350	68000007

MODEL TRILOGY

ELECTRONIC COMPONENT LIST

Schem. Ref.	Circuit	Type	Part Code
TR1 ÷ TR3	Analog Delay Line	BC308	62210001
TR4 - TR5	Analog Delay Line	BC173C	62120003
TR6 ÷ TR8	PNP Transistor	BC308	62210001
TR9 - TR10	NPN Transistor	BC173C	62120003
TR11 ÷ TR13	PNP Transistor	BC308	62210001
TR14 - TR15	NPN Transistor	BC173C	62120001
D1 ÷ D15	Diodes	BA130	65000001
STRINGS FILTER AND OSCILLATORS (DWG6)			
P-898	Complete with Components		978002523
IC1 ÷ IC4	Dual Operational Amplifier	1458	68000054
IC5 - IC8	Operational Amplifier	741	68000059
IC6	O.T.A.	3080	68000066
IC7	Dual Operational Amplifier	1458	68000054
IC9	Envelope Generator	3310	68030142
TR1	PNP Transistor	BC308	62210001
DZ2 - DZ4	Diode Zener	ZPY3.9V	67000025
DZ5	Diode Zener	ZPY5.1V	67000012
D1 - D3	Diodes	BA130	65000001
PRESETS BOARD (DWG7)			
P-878	Complete with Components		978002482
IC1 ÷ IC5	Analog Demultiplexer	4051	68010154
IC6 ÷ IC9	Dual Operational Amplifier	1458	68000054
IC10 ÷ IC12	Analog Demultiplexer	4051	68010154
IC13 - IC14	NAN Gate	4011	68000034
IC15	Analog Demultiplexer	4051	68010154
D1 ÷ D18	Diodes	BA130	65000001
P-896	A.D.S.R. CONTROLS (DWG7) Complete with Components		978002521
P-893	A.D.S.R. PRESETS (DWG7) Complete with Components		978002518

MODEL TRILOGY

ELECTRONIC COMPONENT LIST

Schem. Ref.	Circuit	Type	Part Code
P-894	E.C.R. PRESETS (DWG7) Complete with Components		978002519
P-855/2	FILTER BOARD (VCF-VCA-ADSR) (DWG8) Complete with Components		978002543
IC1	Dual voltage controlled amplifier	3330	68030144
IC2	Voltage controlled filter	3320	68030143
IC3	Dual operational amplifier	1458	68000054
IC4	Voltage controlled envelope generator	3310	68030142
D1 ÷ D5	Diodes	BA130	65000001
P-876/2	FILTER MOTHER BOARD (DWG8) Complete with Components		978002536
IC1 ÷ IC4	Dual operational amplifier	1458	68000053
IC5	Operational amplifier	741	68000059
IC6	Voltage controlled amplifier	SSM2020	68030139
TR1	Transistor NPN	BC173C	62120003
P-852	POWER SUPPLY (DWG9) Complete with Components		978002533
RT1	Voltage Regulator	7815	62110020
RT2	Voltage Regulator	7812	62110027
RT3	Voltage Regulator	7915	62110022
RT4	Voltage Regulator	7912	62110037
PD1	Rectifier Bridge	KBL04	66000006
PD2	Rectifier Bridge	KBL04	66000006
DZ1	Diode Zener	ZPY6.2V	67000023
DZ2	Diode Zener	ZPY9.1V	67000013
T63	Transformer CSA Version		18010100
T63EN	Transformer SEMKO Version		18010099

DWG1A

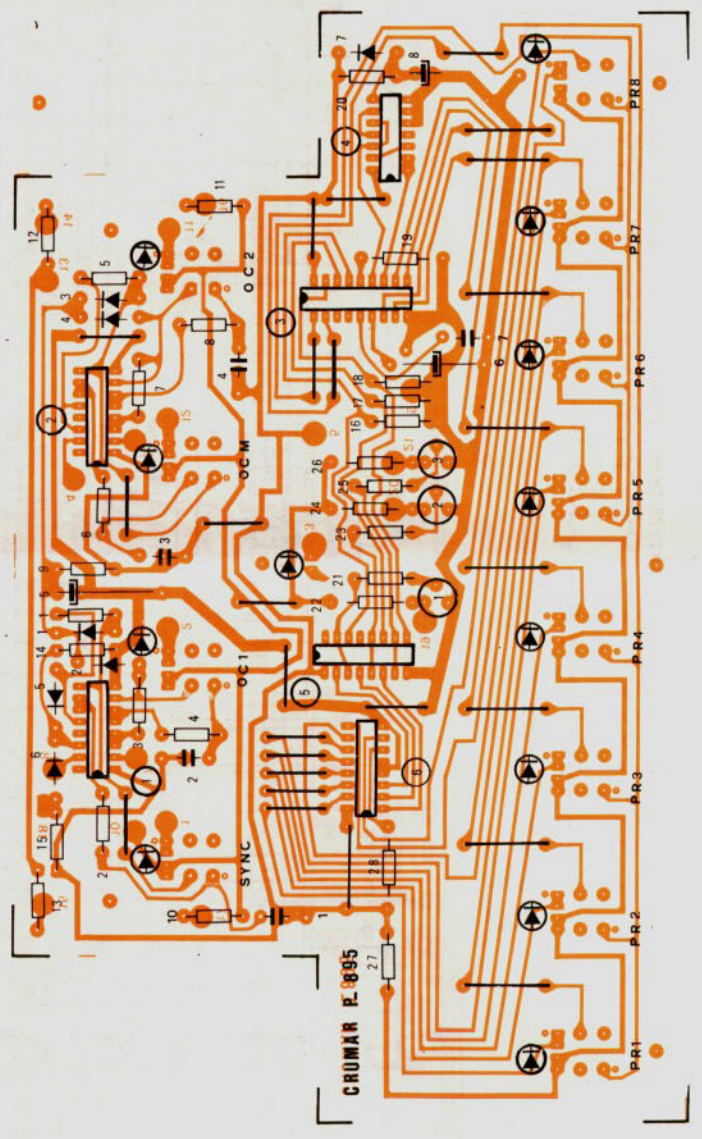
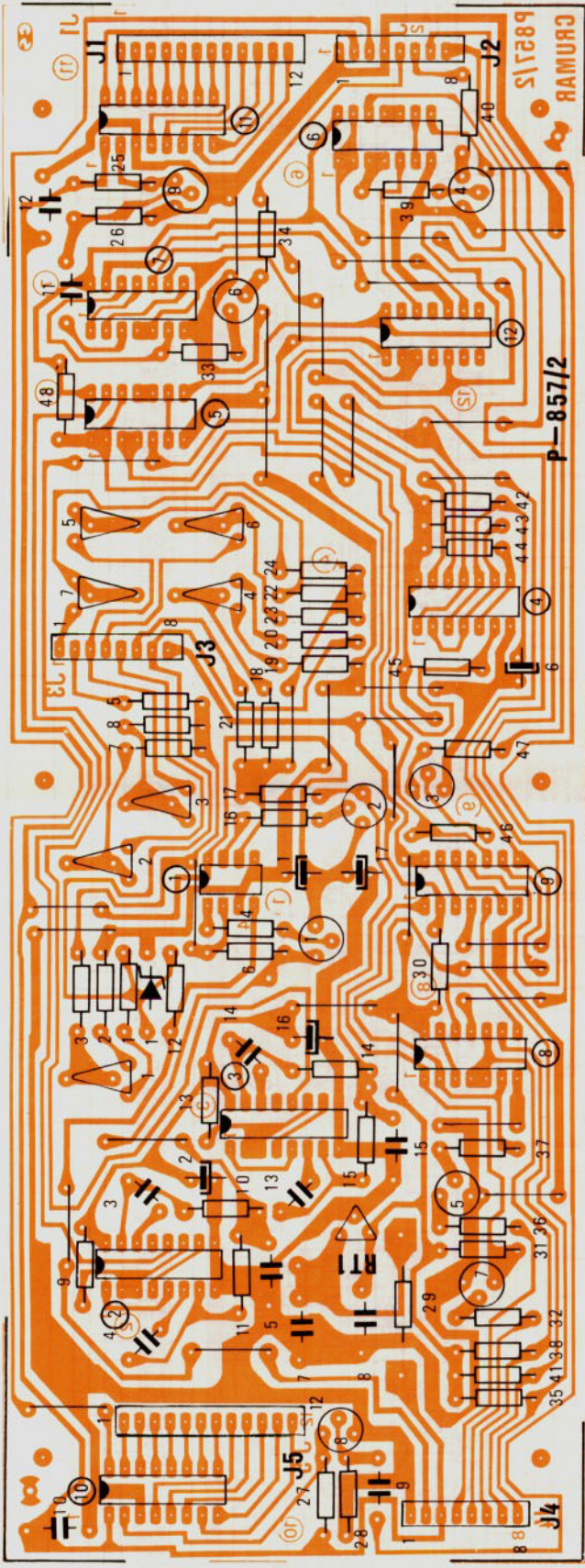

QUESTO DISEGNO È PROPRIETÀ PRIVATA E NON PUÒ ESSERE COPIATO, RIPRODOTTO, DISTRIBUITO O USATO IN ALCUNA MANTENIMENTO SENZA IL CONSENSO SCRITTO.

CRUMAR	MODEL: TRILGY
DESIGNER: G. FERRARI	DATE: 7/5/83
REVISOR: M. S.	

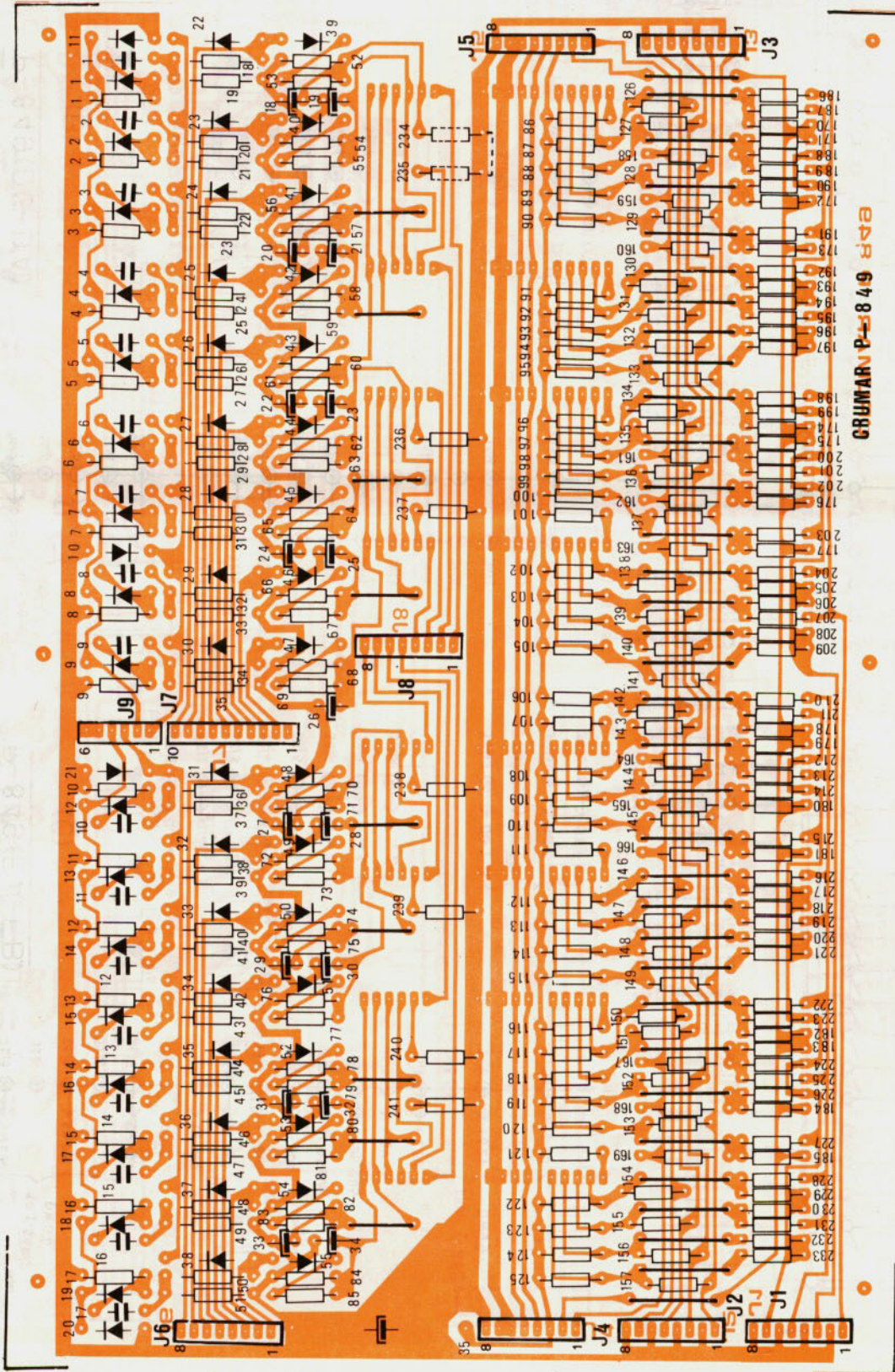

P-840

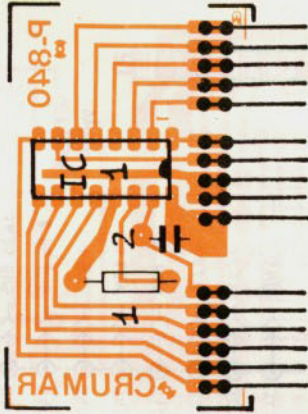

DWG2A

CRUMAR P-849

DESIGN: CRUMAR P-849, REV. 1, 1978. P.O. BOX 1000, CHICAGO, ILLINOIS 60601. PRINTED IN U.S.A. BY CRUMAR ELECTRONICS, CHICAGO, ILLINOIS 60601.

CRUMAR P-849	MODEL: TRILOGY
DESIGNED BY: <i>Alva</i>	DATE: 7/5/81
DRAWN BY: <i>Alva</i>	REVISION: 6

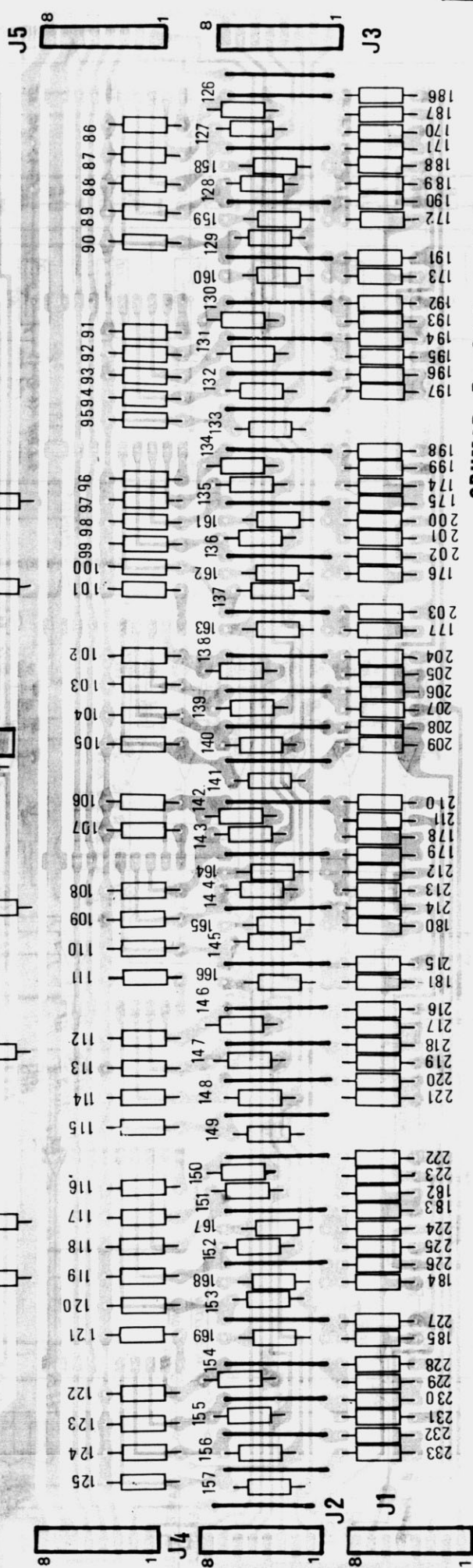
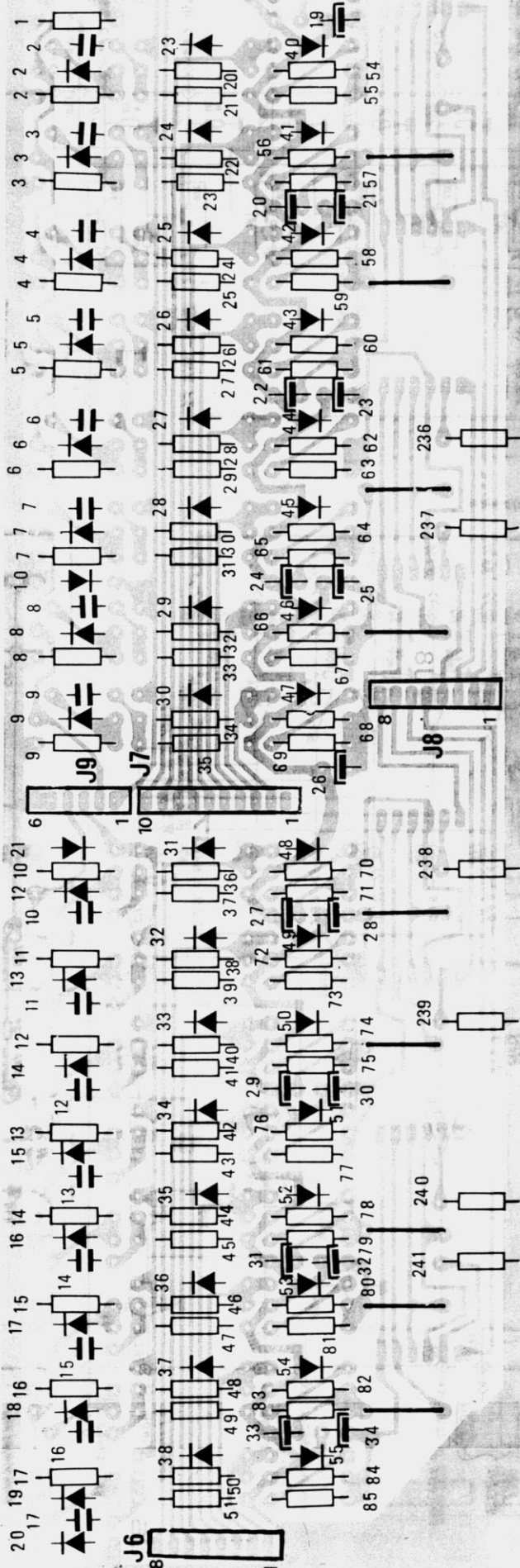

CRUMAR P-849

DWG3A

QUESTO DISEGNO È PROPRIETÀ PRIVATA E NON PUÒ ESSERE COPIATO, RIPRODOTTO, TRASMESO, VENDUTO, O ALTRIMENTI DIFFUSO SENZA L'AUTORIZZAZIONE SCRITTA.

MODEL: TRILOGY	REVISION	DATE
DESIGNER: G.	DATE	15/08/82
DWG3A	REVISION BY	

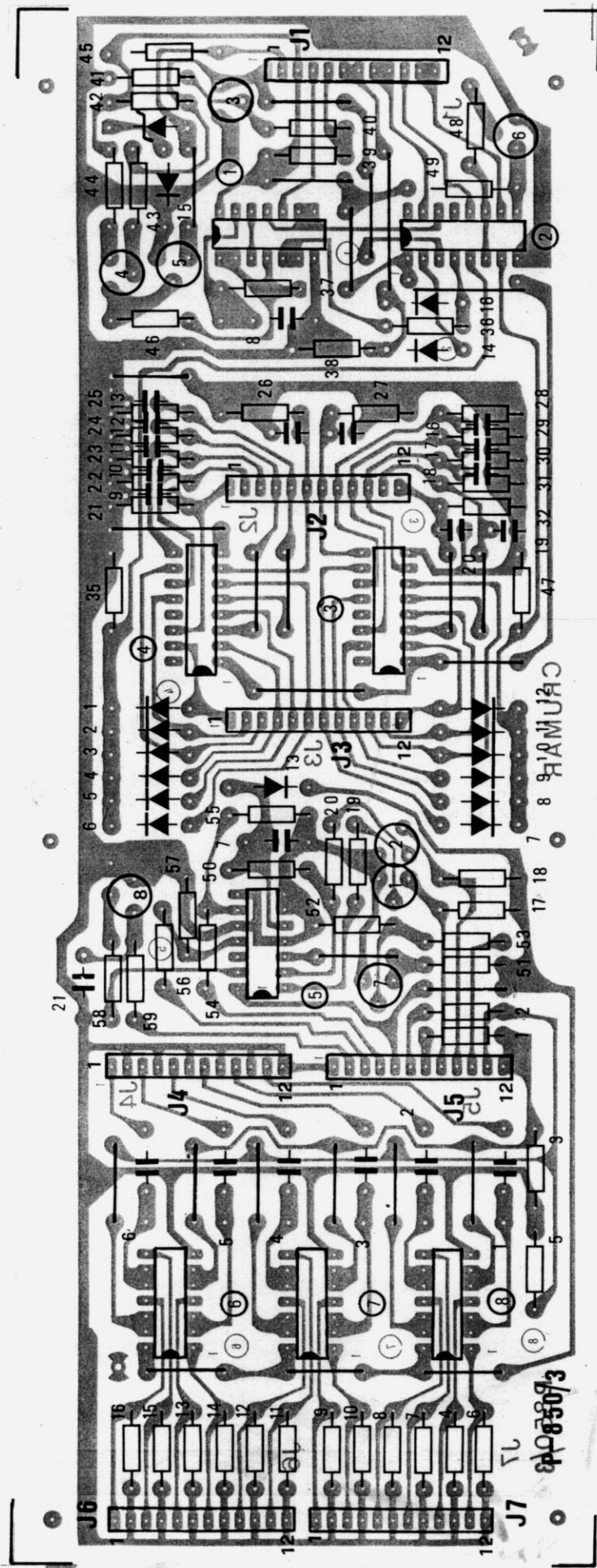

DWG4A

QUESTO SCHEMA È PROPRIO DI UNO DEI NOSTRI INGEGNERI COMPARTO EMOZIONATI A TENDERE NOSTRA ATTIVITÀ IN UNO DEI NOSTRI

C. R. U. A. R.	MODEL: TRILOGY
DESIGNED BY	REVISION: 6
DWG4A	DATE
DESIGNED BY	DATE

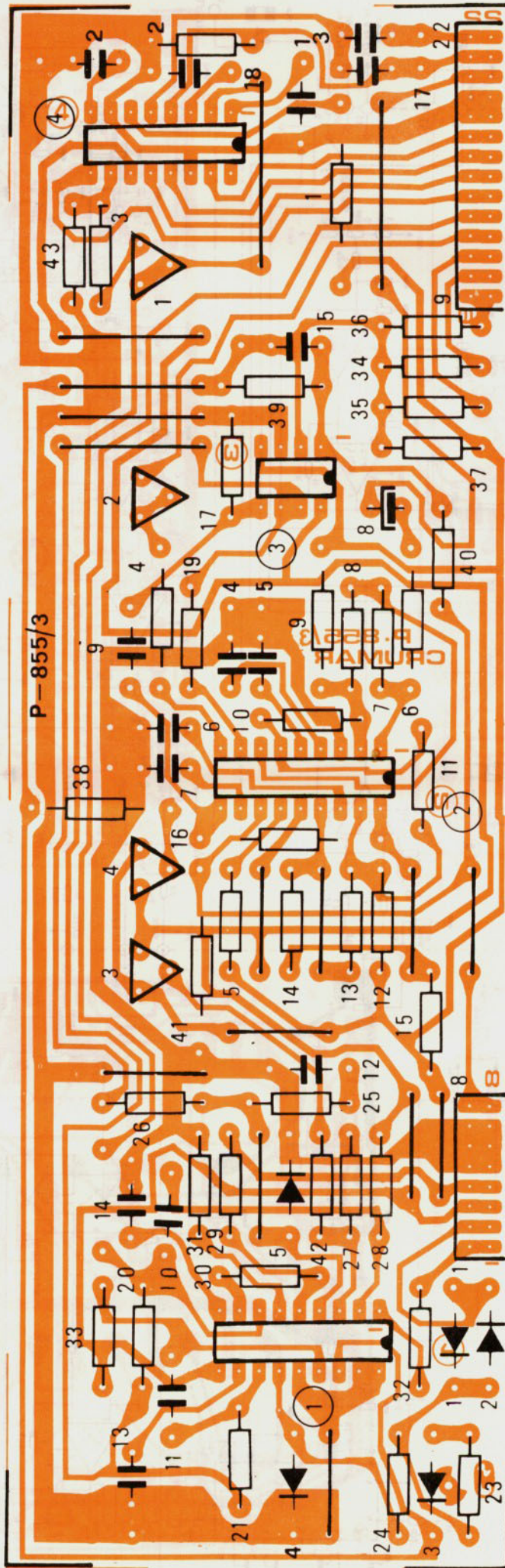

DWG4A2

DESIGN: DESIGNED BY: APPROVED BY: CHECKED BY: DATE: 7/15/81

DESTROYED BY: REWORKED BY: DATE: 7/15/81

C. R. U. M. A. R. MODEL: TRILOGY

DESIGNED BY: B. J. G. DATE: 7/15/81

DWG4A

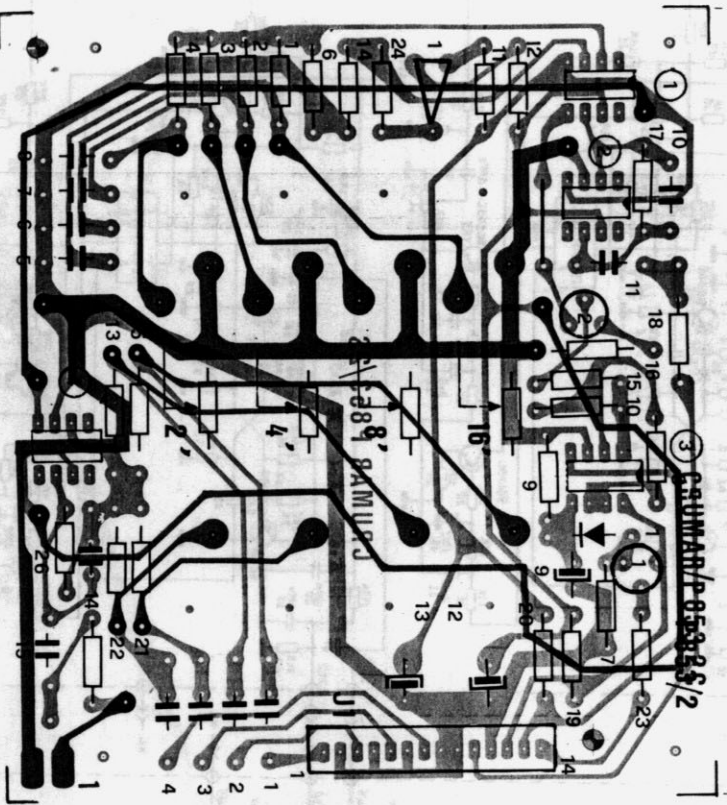

DWG5A

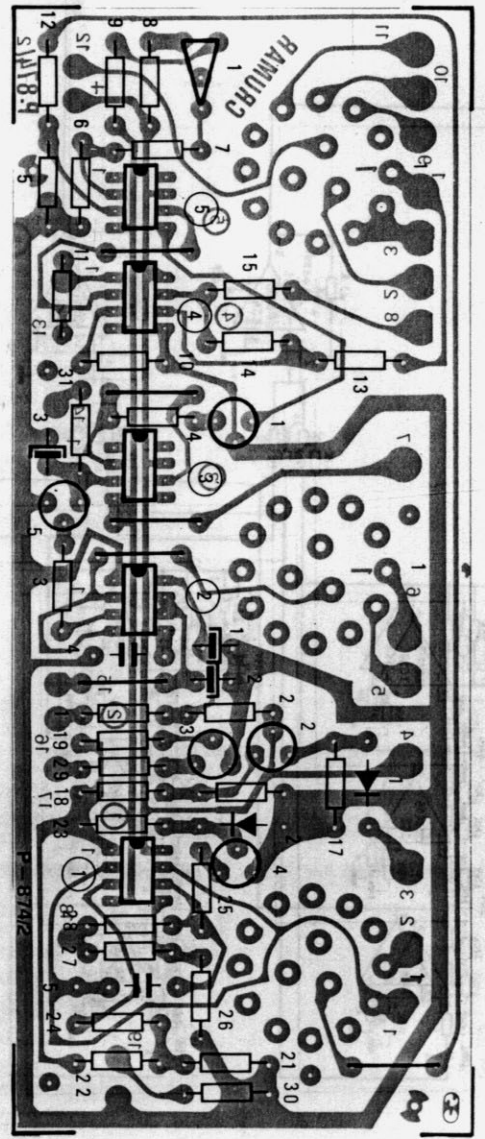
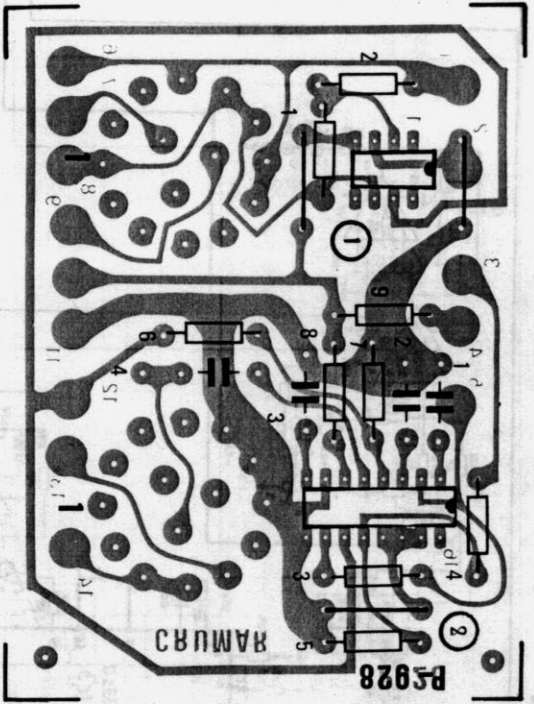

DWG5A		DATE	
REVISION BY		DATE	
DRAWN BY		DATE	
CHECKED BY		DATE	
APPROVED BY		DATE	
PROJECT: TRIOLOGY		DATE	
SHEET: 6		DATE	
TOTAL SHEETS: 6		DATE	

TRIOLOGY SYSTEMS & SERVICES, INC. 1000 P.O. BOX 10000, TAMPA, FL 33601
 PRINTED IN THE U.S.A.

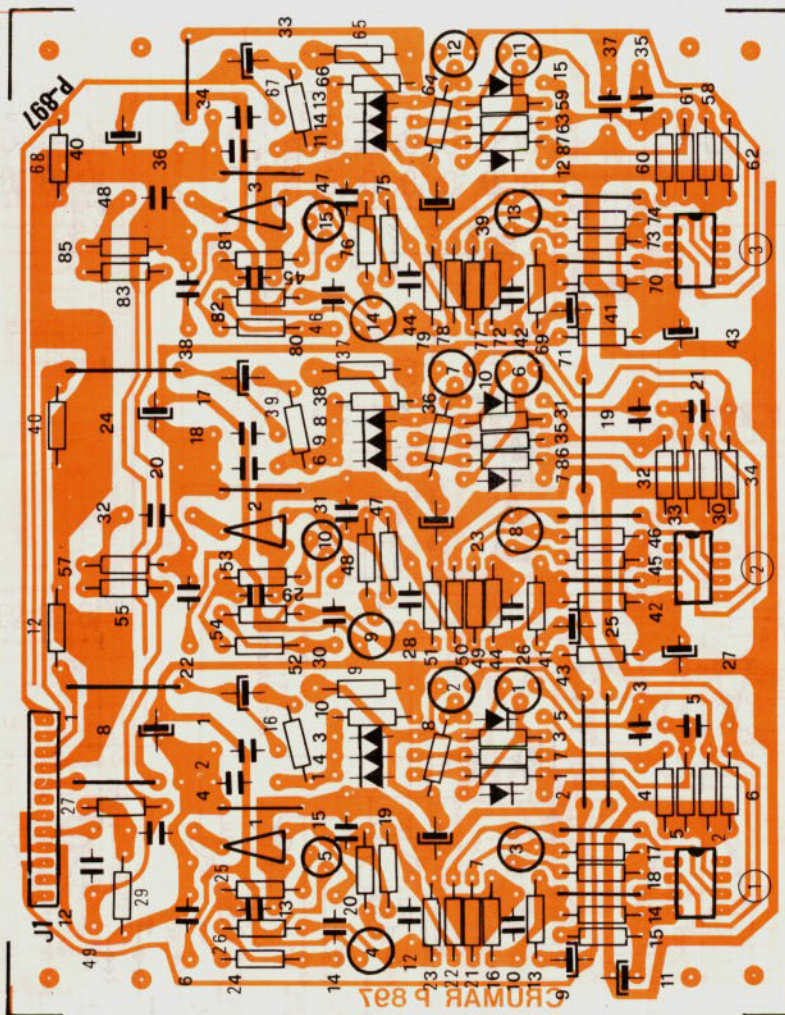
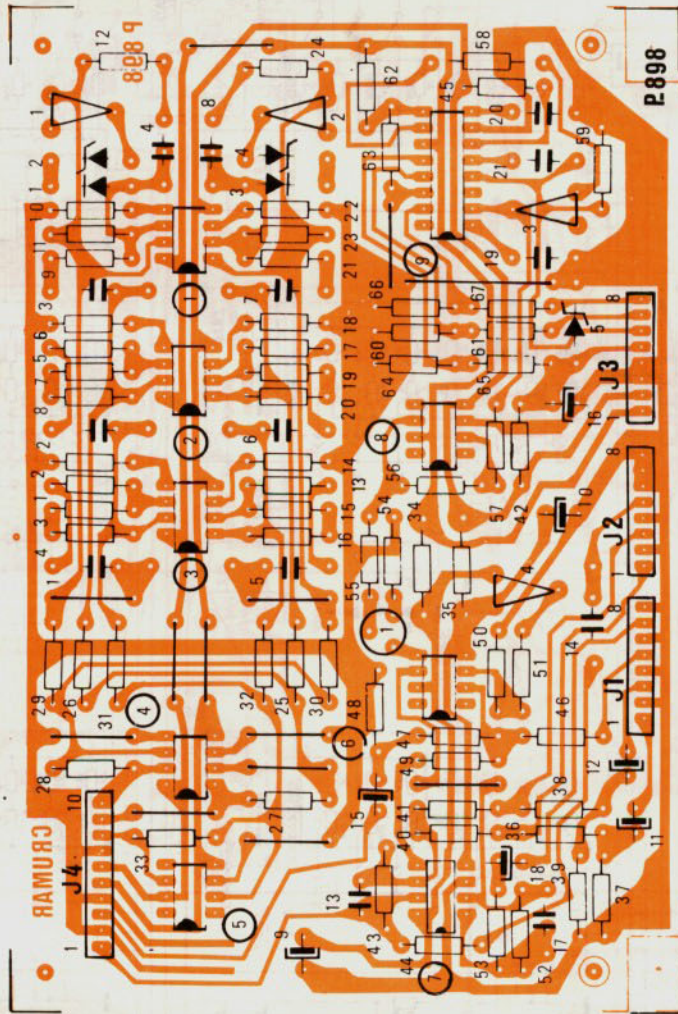

DWG6A

QUESTO DISEGNO È PROPRIETÀ PRIVATA E NON PUÒ ESSERE COPiato, RIPRODOTTO, MODIFICATO O TRADOTTO SENZA APPROVAZIONE SCRITTA.

C.R.U.M.A.R.		MODEL: TRILOGY	
DESIGN BY	REVISED BY	DATE	PHYSICAL
DWG6A	REVISED BY	DATE	PHYSICAL

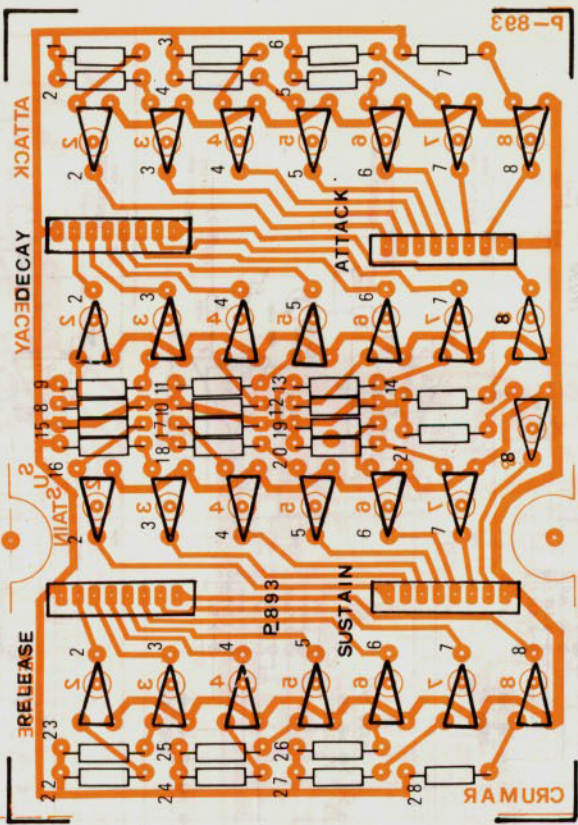
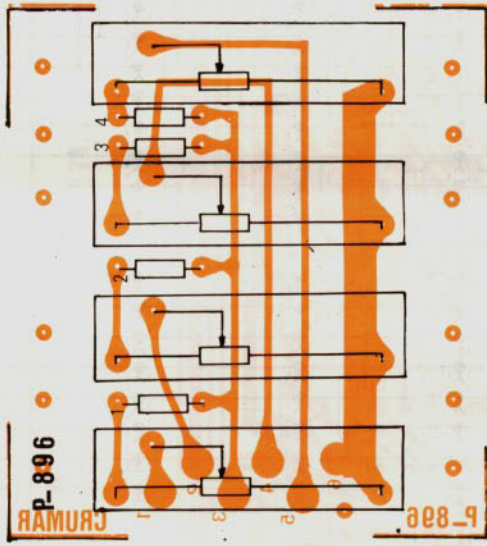
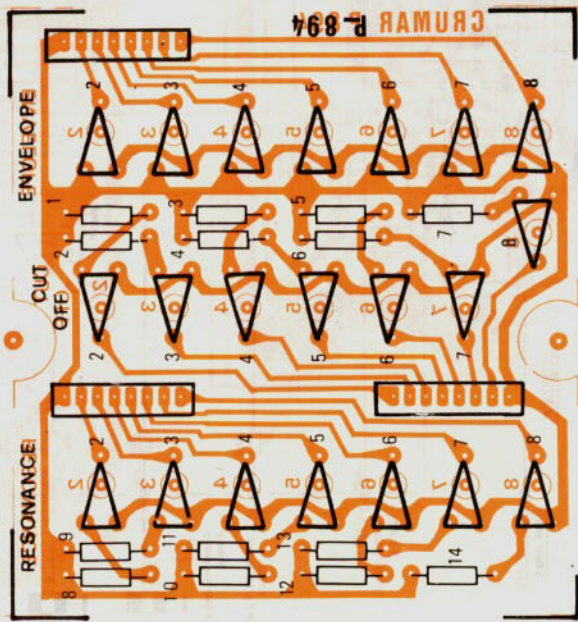
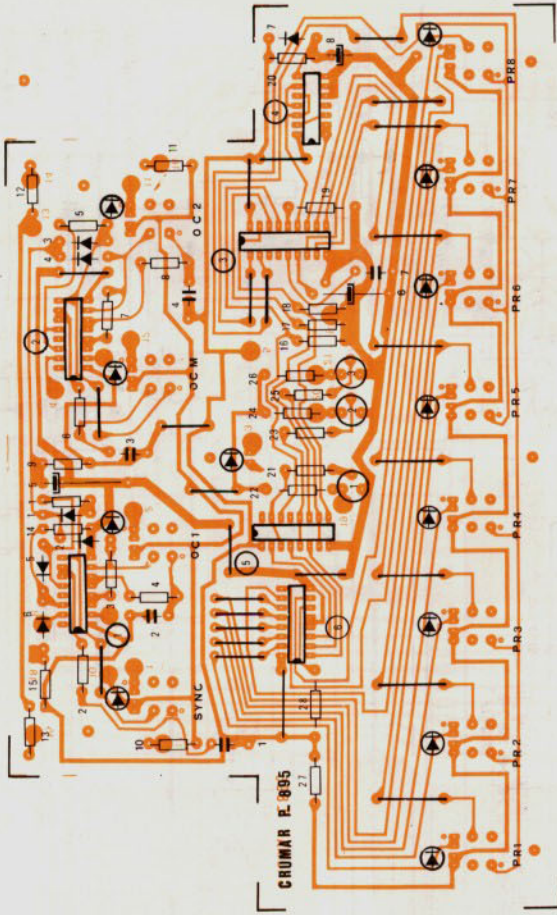
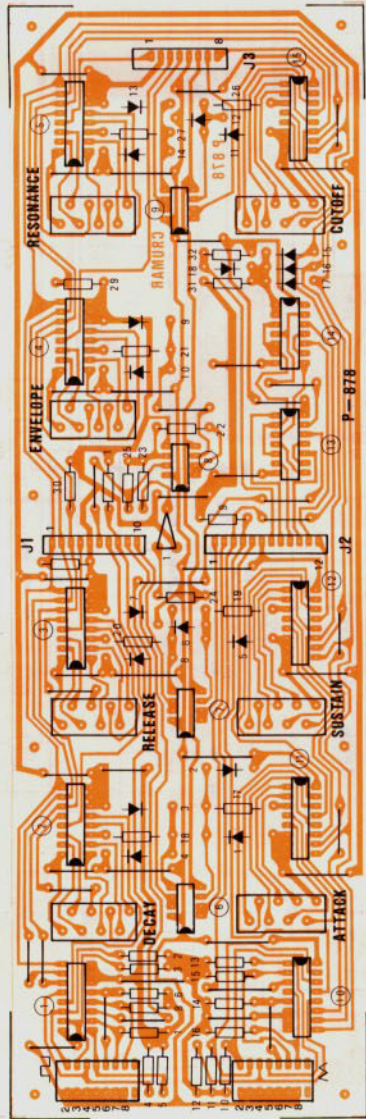

DWG7A

QUESTO DISEGNO E PROPRIETA' PRIVATA E NON PUO' ESSERE COPIATO, RIPRODOTTO O USATO SENZA AUTORIZZAZIONE SCRITTA.

C.R.U.M.A.R.		MODEL: TRILLOGY	
DESIGNER:	BRAND:	DATE:	7/5/81
DWG7A	REVISED BY:		

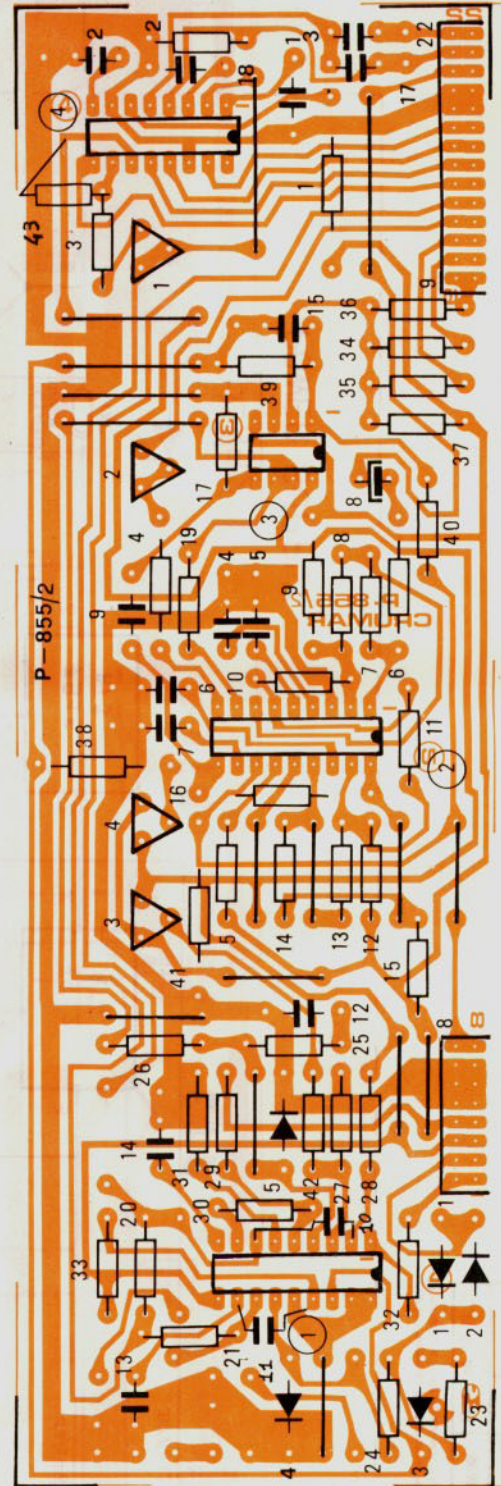
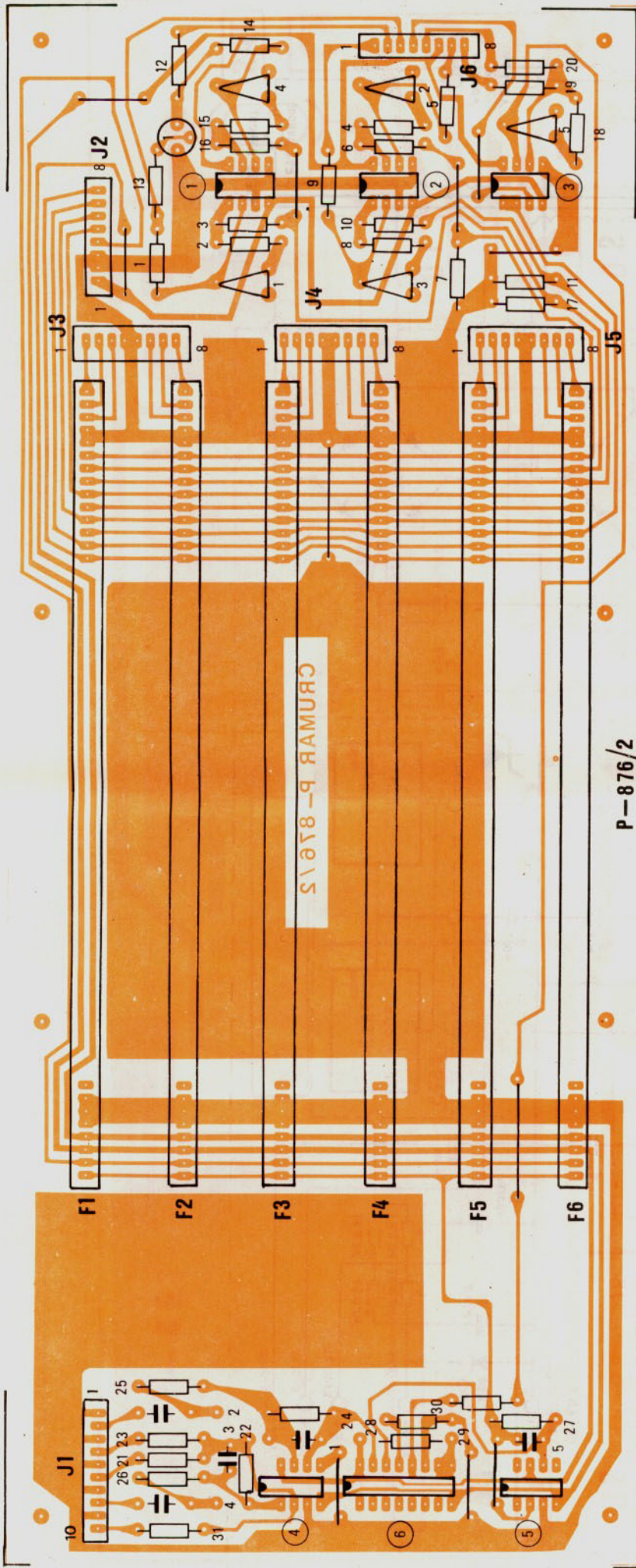

DWG8A

QUESTO DISEGNO È PROPRIETÀ PRIVATA E NON PUÒ ESSERE COPIATO, RIPRODOTTO, MOSTRATO A TERZI SENZA ADEQUATA AUTORIZZAZIONE SCRITTA.

C.R.U.M.A.R.		MODEL: TRILOGY	
DESIGN BY	Bozzoli G.	REVISION	
DWG8A	DESIGNED BY	DATE	1/15/84

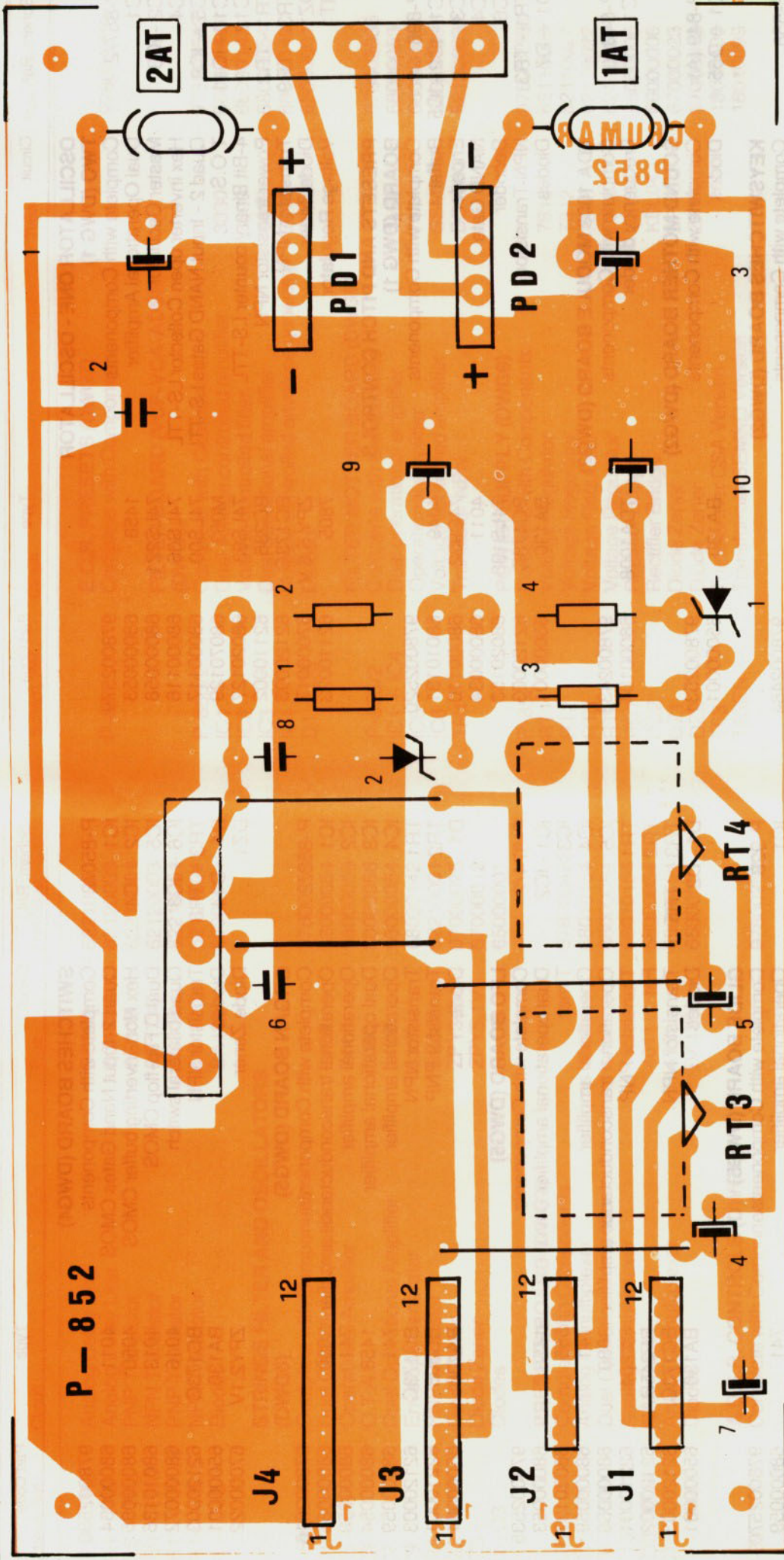

DWG9A

QUESTO ORDINE E' INCOMPLETO INQUANTO NON E' STATO INVIATO IL COMPARTO PRODOTTORE
 MOSTRATO A TITOLI SENZA ADESIONE APPROVAZIONE SCITTA.

C.R.U.M.A.R.		MODEL: TRILOGY	
REVISIONE BY	REVISIONI	REVISIONI	DATE
DWG9A	6		7/15/81