

FRONT

NR or ENCODE/DECODE IN

Pushing the button In engages the circuit for all channels. Out is a hardwire bypass.

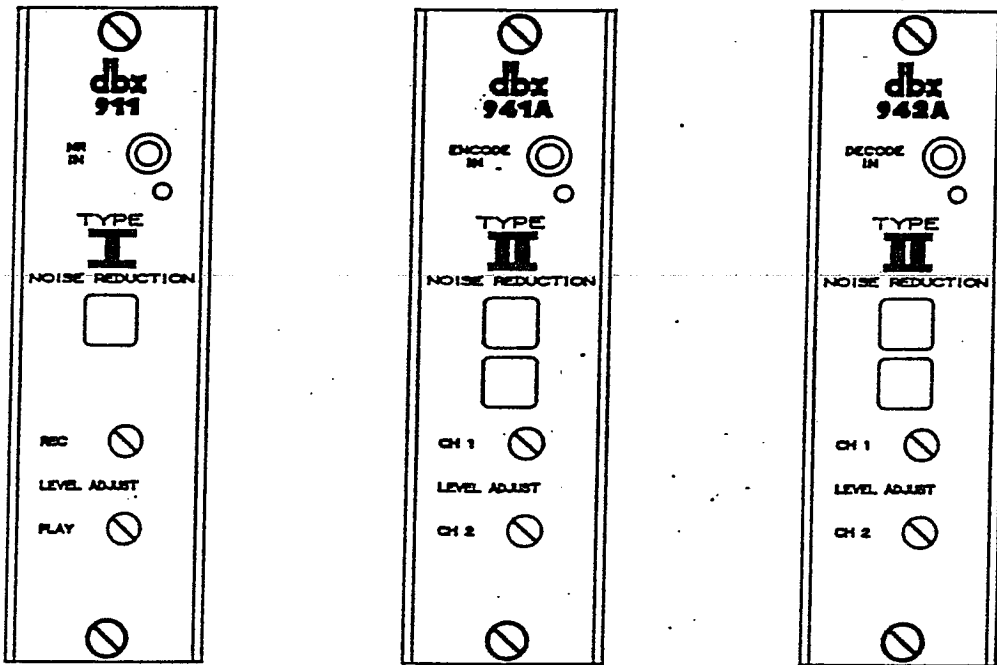

LEVEL ADJUST

These screwdriver trims control the overall, full-bandwidth gain of the circuit, permitting unity (0-dB) gain throughout the record/play (encode/decode) process. The settings aren't critical, and need to be done usually only once in a given installation. See the discussion on p. 4.

H. Gardiner

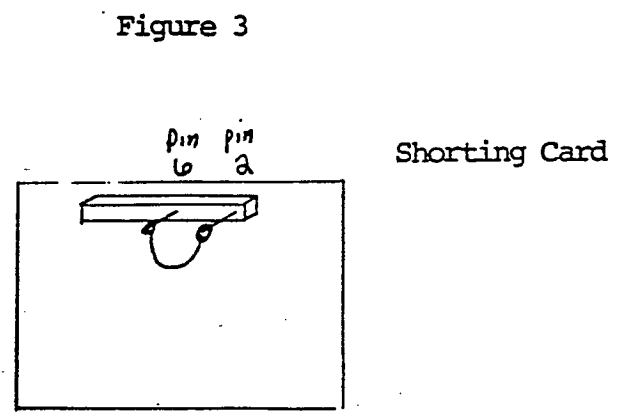
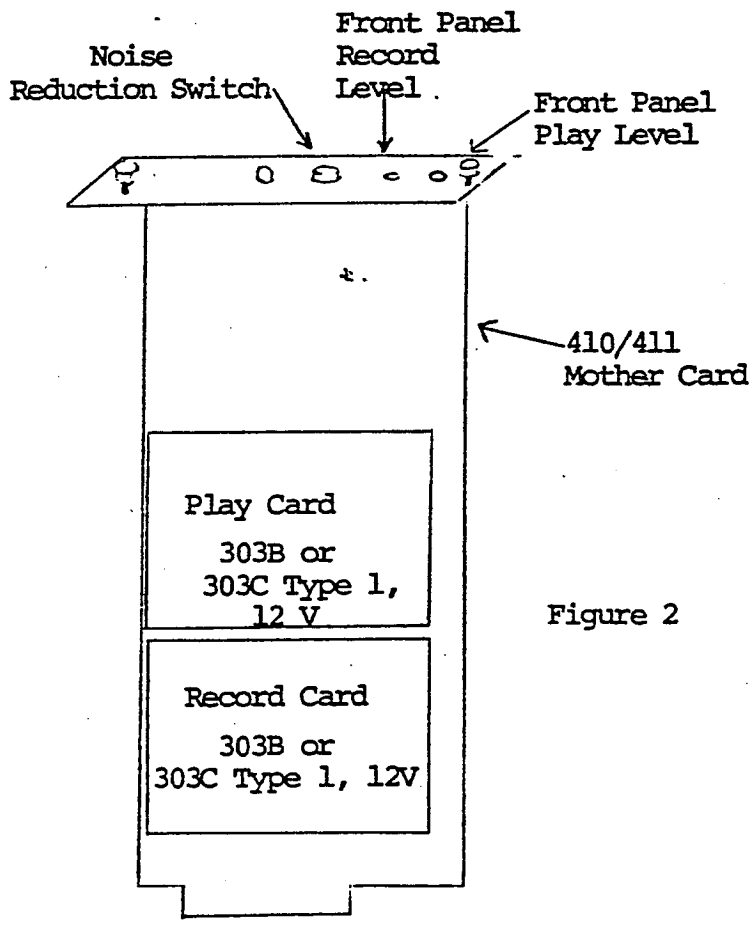
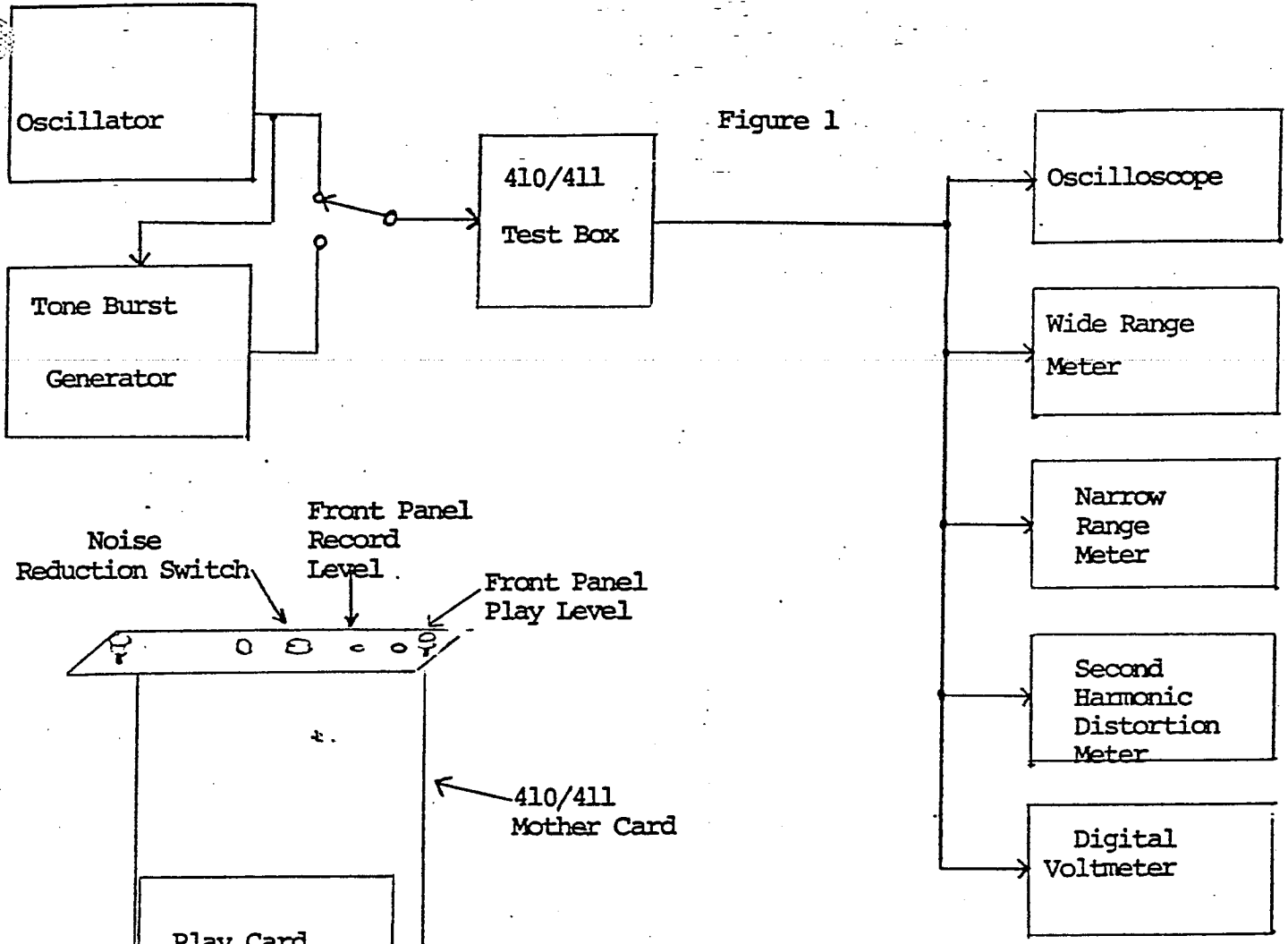

Blank Printed Circuit Except for Plug and Wire Connecting Pins 2 and 6

Test Equipment Required:

1	Signal Oscillator	Krohn-Hite 4200A, 4300A preferred.
1	Digital Voltmeter	Simpson 464A, Dana 3300*, B&K 282, Digitek 2110.
1	Oscilloscope	Dual channel covering DC to 20 kHz.
1	Wide Range Meter ²	dBx-SKC-1026, HP 427*; +20 to -100 dBv.
1	Second Harmonic Meter ¹	dBx-SKB-1070, HP 330*, GR 1500*, GR 1900*.
1	Narrow Range Meter ²	dBx SKC-1071.
1	Tone Burst Generator ³	
1	410/411 Test Jig	
2	Shorting Cards	See Figure 3.

* Items are suggested equivalents that appear to have the necessary specifications. These substitutions have not actually been used at dBx to verify satisfactory compliance with requirements for speed and accuracy.

1. Meter should respond to just the 200 Hz distortion component of a 100 Hz signal. Less desirable but allowable are meters which measure total harmonic distortion and automatically maintain a constant internal reference. Distortion adjustments in the 410/411 also affect the output level.

2. Analog meters are easier to use than digital meters in this application. If a digital wide range meter is used, a narrow range meter (listed later) is not required.

3. Tone Burst Generator should produce 8 cycles of 1 kHz signal at levels up to +10 dBv followed by an off period equal in length to 128 cycles of 1 kHz signal. It must switch at zero crossings of the signal.

Introduction:

The Model 410/411 card is a "mother board" that holds two 303B or 303C Type 1, 12 V cards. The 411 and the 410 are the same design except that in the 411 a jumper exists where R53 is found in the 410. This resistor affects the output impedance of the card.

Experience has shown that the test procedure runs faster if the available lot of 410/411 cards is first tested with "shorting cards" installed. These cards are blank 303 cards with connectors wired with pins 2 and 6 shorted together. See Figure 3.

Mother Board Test:0) Preparation of Test Apparatus:

- a) Use Figure 1 as a guide to connecting the test equipment.
- b) Set oscillator to 1.23 Vrms and 1 kHz.
- c) Attach oscillator to meters.
- d) Use digital multimeter to calibrate the two dB meters to 0 +/- .1 dBm. The dBx meters exhibit a moderate temperature sensitivity.

1) Bypass:

- a) Install in the test box the 411 mother card with shorting cards loaded.
- b) Input 2 kHz at 0 dBm (1.23 Vrms.)
- c) Set test jig input switch to Normal.
- d) Set test jig load switch to Off.
- e) Set DUT NR switch to Out.
- f) Set test jig mode switch to Record-Play (R-P).
- g) Measure 0 +/- .5 dBm output.

2) Level and Frequency Response:

- a) Set NR switch to In.
- b) Set test jig mode switch to Record. Output must be +1 +/- .3 dBm.
- c) Set oscillator to 20 kHz. Output must not change by more than .3 dB from that obtained in last step.
- d) Set test jig mode switch to Play.
- e) Set oscillator to 2 kHz. Output must be +1 +/- .3 dBm.
- f) Set oscillator to 20 kHz. Output must not change by more than .3 dBm from that obtained in last step.

3) Common Mode Rejection:

- a) Set oscillator to 2 kHz.
- b) Set test jig mode switch to Record CMR. Output must be less than -40 dBm.
- c) Set test jig mode switch to Play CMR. Output must be less than -40 dBm.

Loaded Mother Board Test:0) Preparation of Test Apparatus:

- a) Use Figure 1 as a guide to connecting the test equipment.
- b) Feed oscillator directly to dB meters.
- c) Use digital voltmeter to calibrate narrow range and wide range dB meters to 1.23 Vrms (0 dBm). These meters exhibit a moderate temperature sensitivity.
- d) Set oscillator to 1 kHz and -50 dBm.
- e) If meter does not read exactly -50 dBm, note actual reading and call it -50 dBm for later test purposes.

1) 410/411 Preparation:

- a) Install 303 cards carefully.
- b) Install 410/411 mother card into test box, again carefully.
- c) Set both front panel level controls to mid-position.
- d) Set MR switch to In.

2) Distortion:

- a) Set oscillator to 100 Hz and 0 dBm (1.23 Vrms).
- b) Set test box mode switch to Record.
- c) Set test box 600 ohm Load switch to Off.
- d) Set Input Short switch to open.
- e) Adjust R9 on Record Card (see Figure 2) for 0 +/- .5 dBm output.
- f) Adjust Record Card R23 and R35 for minimum second harmonic distortion less than .018 %.
- g) Set test box mode switch to Play.
- h) Adjust R8 on Play Card (See Diagram 2) for 0 +/- .5 dBm.
- i) Adjust Play Card R23 and R35 for minimum second harmonic distortion less than .018 %.

3) Level Set - 1 kHz:

- a) Set oscillator to 1 kHz and 0 dBm.
- b) Set test box mode switch to Record.
- c) Adjust R9 on Record Card for 0 +/- .1 dBm out.
- d) Set test box mode switch to Record - Play.
- e) Adjust R8 on Play Card for 0 +/- .1 dBm out.

4) Frequency Response:

- a) Sweep oscillator from 10 kHz to 20 kHz. Output must not vary by more than 1 dB from that obtained in last step (3e).
- b) Set oscillator to 30 Hz, then 100 Hz. Output again must not vary by more than 1 dB from that in step 3e at each of these frequencies.

5) Tracking:

- a) Set oscillator to 1 kHz and -50 dBm. Output must be -50 +/- 1 dBm.

6) Tone Burst Response:

- a) Select tone burst as input. (at 1 kHz and 0
- b) Vertical width of burst must not change by more than 10% over the duration of the burst.

7) Noise:

- a) Set Input Short switch on test box to Short.
- b) Set test box mode switch to Record. Noise must be less than -40 dBm.
- c) Set test box mode switch to Record-Play. Noise must be less than -80 dBm.
- d) Set Input Short switch to Normal.

Continued

8) Output Impedance:

- a) Set oscillator to 1 kHz and +10 dBm.
- b) Set test box mode switch to Play.
- c) Set 600 ohm Load switch on test box to On.
- d) Use 410/411 front panel Play control to increase output level to maximum level obtainable before clipping sets in. Using DVM, measure for at least 11.3 Vrms for a 410 and 13 Vrms for a 411.
- e) Set oscillator to 0 dBm.
- f) Switch 600 ohm Load switch on test box to Off.
- g) Adjust 410/411 front panel play level control for 0 dBm output.

9) Distortion:

- a) Set test box Mode switch to Record-Play.
- b) Set oscillator to 100 Hz and 0 dBm. Distortion must be less than .032%; if not,
 - 1) Switch to Record and adjust R23 and R35 for distortion less than .018%.
 - 2) Switch to Play and adjust R23 and R35 for distortion less than .018%.
 - 3) Set test box Mode switch to Record-Play.
 - 4) Distortion must be less than .032%.

10) Final Preparation:

- a) Remove 410/411 and install next unit in test jig.
- b) Melt wax over pots.
- c) Secure circuit boards with Phillip's head 4-40 x 1/4" screws without lockwashers. Make them reasonably snug.
- d) Secure properly oriented cover on 411 with 6-32 x 1/4" Phillips head screws and lockwashers. Make them reasonably tight.
- e) Record serial number on worksheet.
- f) Burn-in is three days.
- g) Post burn-in procedure is /will be part of the 158/208 test procedure.

410/411 Test Procedure - Factory- Before
 Burn-In Rev _____ H. Gardiner
 Underlined entries represent changes from
 previous step.

	Osc Freq Hz	Osc Level dBm	Test Box Input Switch *	Test Box Mode Switch **	Test Box Load Switch	NR Switch	
Preparation	-	-	-	-	-	-	Calibrate meters for 0 dBm at 1.23 Vrms.
410/411 Prep	-	-	-	-	-	-	Install shorting cards and 410/411.
Bypass	2k	0	N	R-P	Out	Out	Output 0 +/- .5 dBm.
Response	2k	0	N	R	Out	In	Output +1 +/- .3 dBm.
	20k	0	N	R	Out	In	Output changes less than .3 dBm.
	2k	0	N	P	Out	In	Output +1 +/- .3 dBm.
	20k	0	N	P	Out	In	Output changes less than .3 dBm.
CMR	2k	0	N	RCMR	Out	In	Output less than -40 dBm.
	2k	0	N	PCMR	Out	In	" "

Notes: * N = Normal, S = Short
 ** P = Play, R = Record, R-P = Record-Play, RCMR =
 Record Common Mode Rejection, PCMR = Play Common Mode
 Rejection

410/411 Test Procedure - Factory - Loaded Board

Rev _____ H. Gardiner

Underlined entries represent changes from last step.

	Osc Freq	Osc Level	Test Box Input	Test Box Mode	Test Box Load	NR Switch	
Preparation	-	-	-	-	-	-	Calibrate meters for 0 dBm at 1.23 Vrms. Then set oscillator to -50 dBm and note any errors.
410/411 Prep	-	-	-	-	-	-	Install 303 cards; install 410/411; center front panel controls.
Distortion	100	0	N	R	Off	In	Adj R9 on Record Card for 0 +/- .5 dBm.
	100	0	N	R	Off	In	Adj R23 and R35 on Record Card for minimum distortion less than .018%.
	100	0	N	P	Off	In	Adj R8 on Play Card for 0 +/- .5 dBm.
	100	0	N	P	Off	In	Adj R23 and R35 on Play Card for min dist less than .018%.
Level Set	1k	0	N	R	Off	In	Adj R9 Record Card for 0 +/- .1 dBm out.
	1k	0	N	R-P	Off	In	Adj R8 Play Card for 0 +/- .1 dBm out. This is the reference level.
Response	10k- 20k	0	N	R-P	Off	In	Varies by less than 1 dB from reference level.
	30	0	N	R-P	Off	In	" " "
	100	0	N	R-P	Off	In	" " "
Tracking	1k	-50	N	R-P	Off	In	Output -50 +/- 1 dBm. Meter OK?
Tone Burst	TBlk	0	N	R-P	Off	In	Vertical width changes less than 10%.
Noise	TBlk	0	S	R	Off	In	Output less than -40 dBm.
	TBlk	0	S	R-P	Off	In	Output less than -80 dBm.
Impedance	1k	+10	N	P	On	In	Using front panel play control, find clipping level. More than 11.3 Vrms for 410; more than 13 Vrms for 411.
Distortion	1k	0	N	P	Off	In	Adj front panel play control for 0 +/- .1 dBm out.
	100	0	N	R-P	Off	In	If distortion is less than .032%, do final step.
	100	0	N	P	Off	In	Adj R23 + R35 Play Card for min distortion.
	100	0	N	R	Off	In	Adj R23 + R35 Record Card for min distortion.
Final prep	-	-	-	-	-	-	Apply wax; install screws and record serial #.

HOOKUP INFORMATION
(See the F900/900A manual as well)

**PC CARD
EDGE CONNECTIONS**

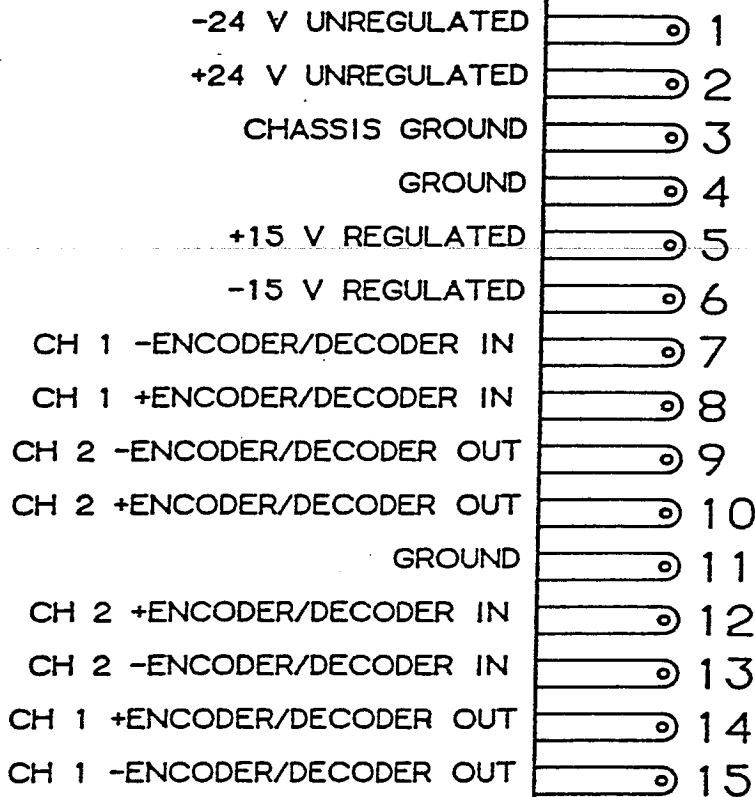

941A

F900/900A
FRAME CONNECTIONS

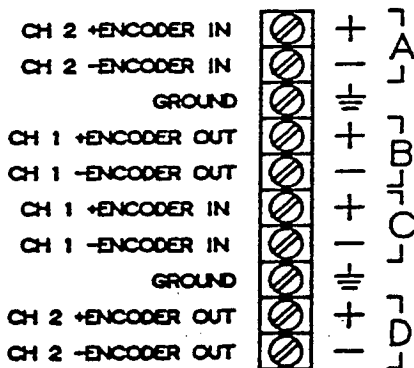

942A

F900/900A
FRAME CONNECTIONS

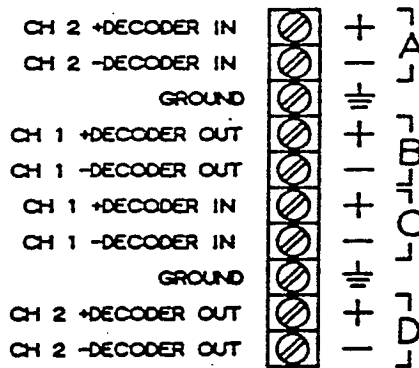

411

F900/900A
FRAME CONNECTIONS

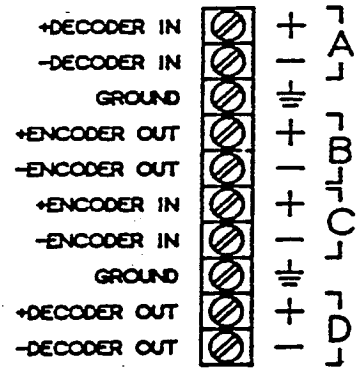

INPUT LP FILTER
& EMITTER FOLLOWER

HI-PASS
FILTER &
PEAKING
CKT

LOG AMPL.
G = 2X LOG FOR (+) OUTPUT
G = 1X LOG FOR (-) OUTPUT

INVERTING
AMPL.
G = -2

FULL
WAVE
RECTIFIER
DIODES

SIGNAL
RELAXE
RC TIME
CONSTANT

OUTPUT
EMITTER
FOLLOWER

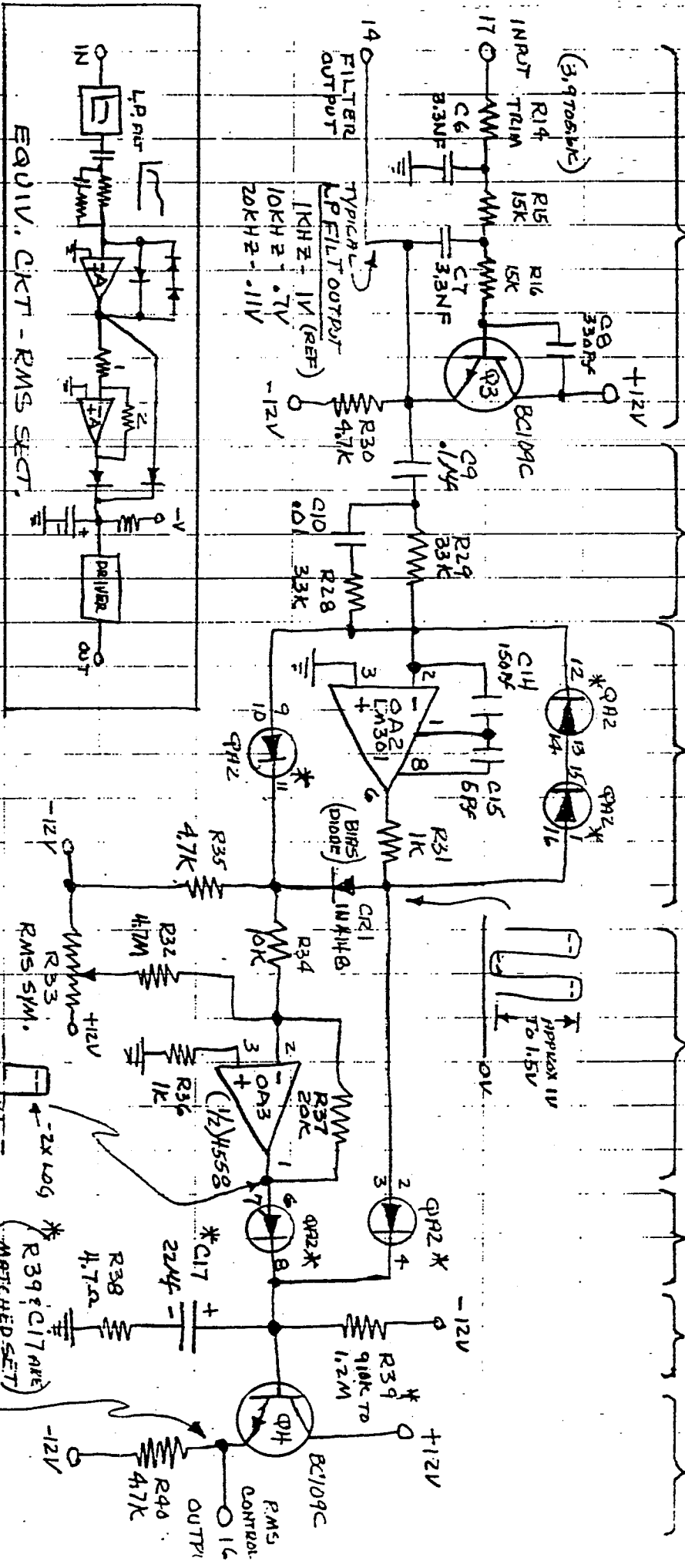

EQUIV. CKT - RMS SECT.

* = TRANSISTOR ARRAY
WITH TRANSISTORS
CONNECTED AS DIODES

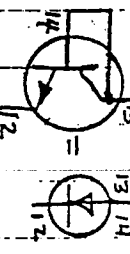

OUTPUT DC. VS
INPUT FEED
TYPICAL 1V INPUT

20HZ - 80MV
1KHZ 0MV (REF)
10KHZ + 62MV
20KHZ - 27MV

303A SIMPLIFIED SCHEMATA
RMS SECTION

USE SET OF HOLES

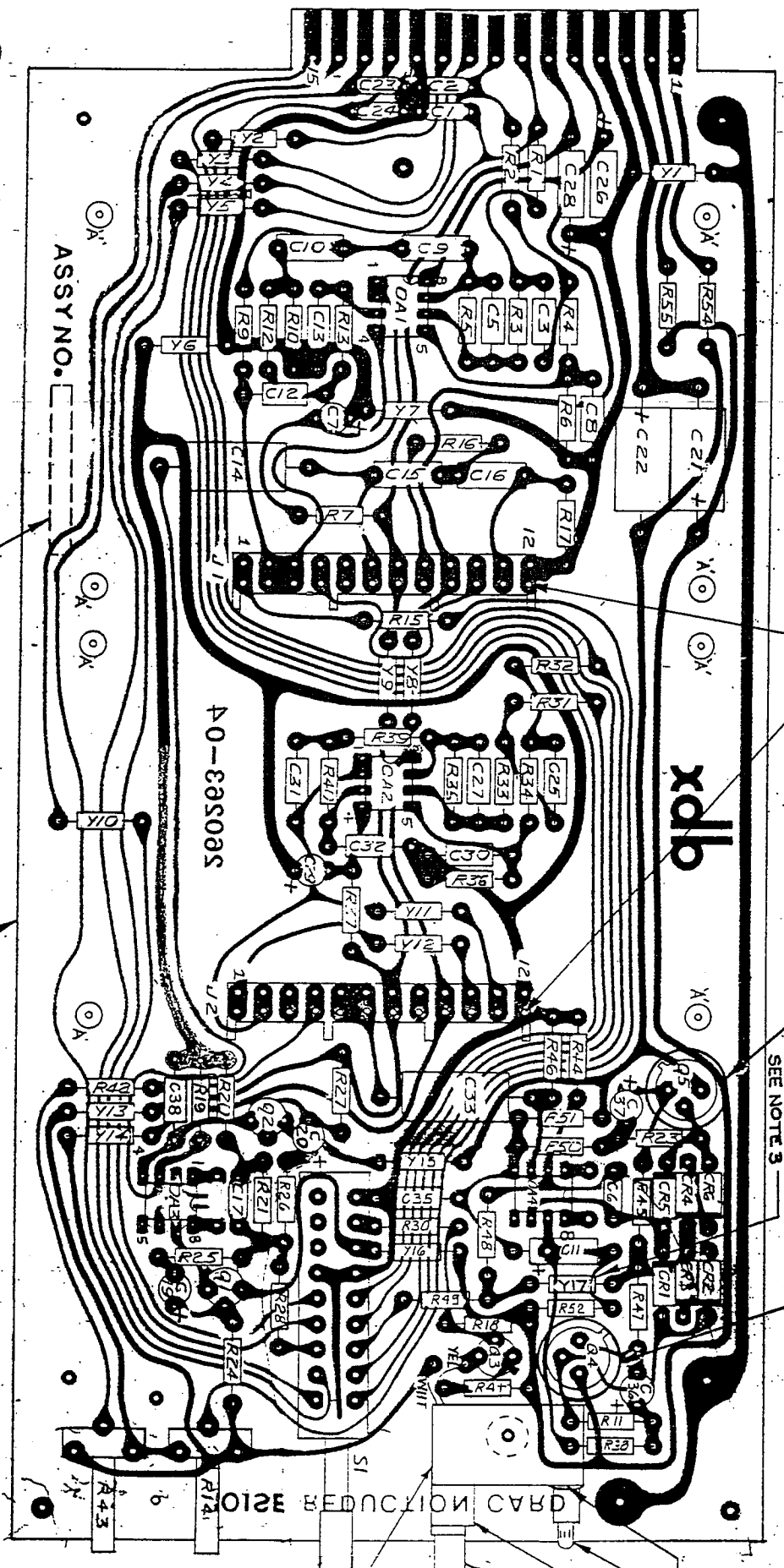

46 TYP (6 PLACES) MARKED 'X'

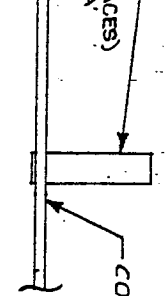

COMPONENT SIDE

ASSY NO.

STAMP: 260348-00

40-38508S

xdb

- NOTES:
1. REFER TO PARTS LIST 260348.
 2. PREBEND TRANSISTOR LEADS WHEN TRANSISTOR PADS ARE NOT USED.
 3. REF. Y17 REPLACES RS3.

43 SEE NOTE 3

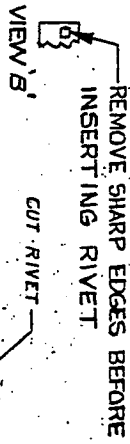

SCALE 2/1 APPROVED BY R.H. BROWN
DATE 4/11/68 RELEASED BY 208758
NOISE REDUCTION CARD ASSY DWG.
MODEL 411

DRAWING NUMBER
260348 00

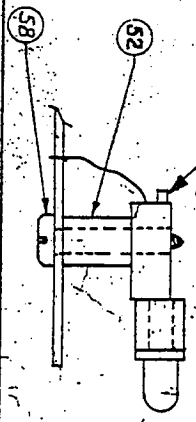

NOISE REDUCTION CARD

SEE VIEW B

19

56

55

57

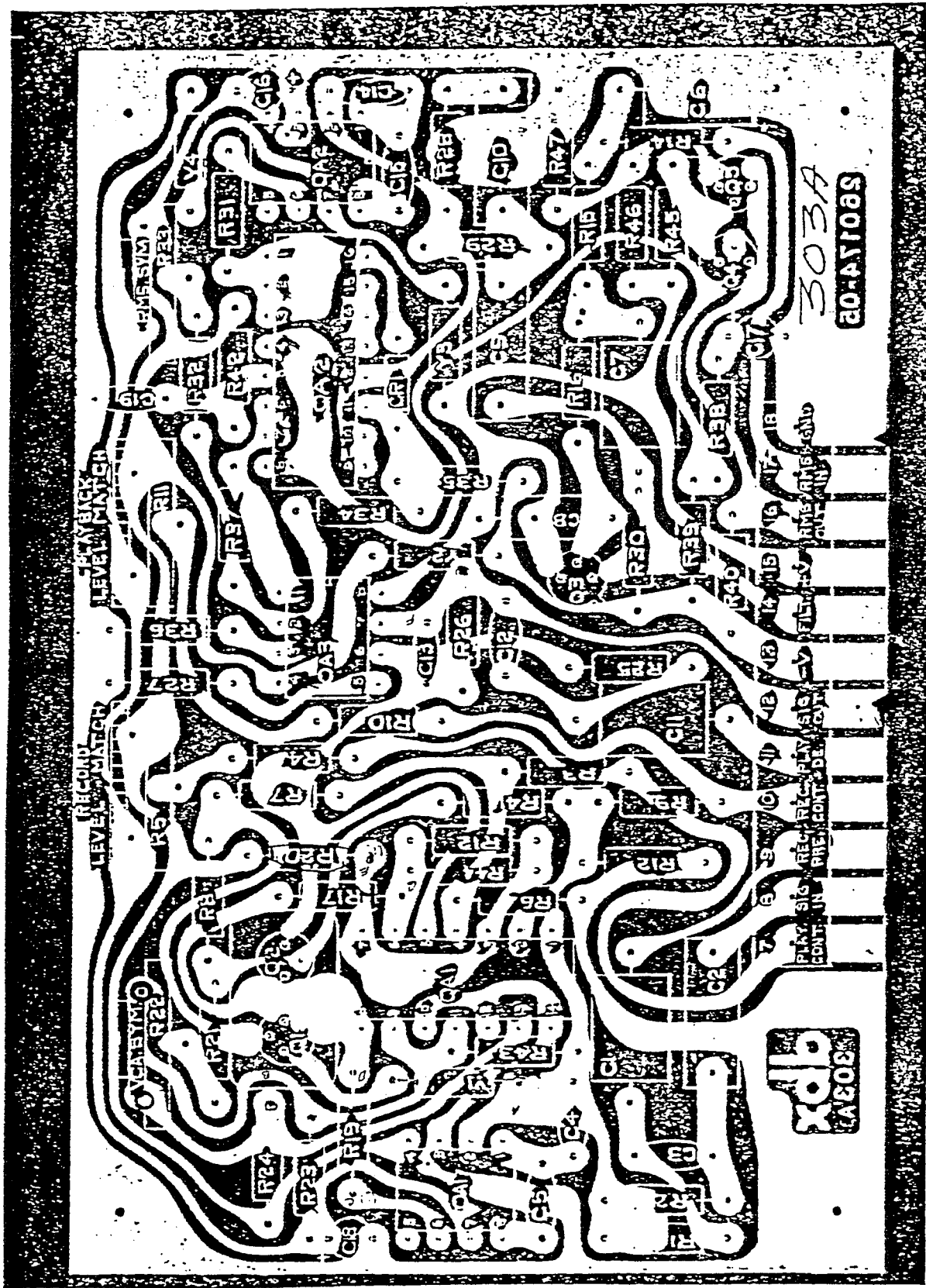

xdb
LAGOS

303A
30-AT108S

PLAY BACK
LEVEL MATCH

RECORD
LEVEL MATCH

PLAY SIG REC. CONT. IN PRE. CONT. DE. OUT

PLAY SIG REC. CONT. IN PRE. CONT. DE. OUT

clock

offset