

MODEL 166

Two - Channel Gated Compressor / Limiter

dbx[®]
SERVICE MANUAL
(Preliminary)

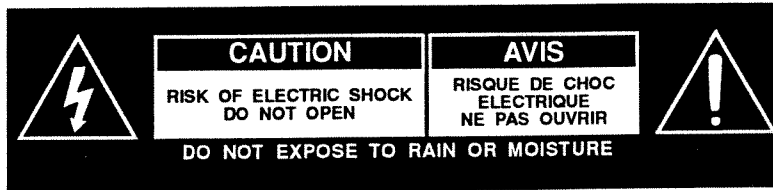

CAUTION: TO REDUCE THE RISK OF ELECTRICAL SHOCK, DO NOT REMOVE COVER (OR BACK). NO USER SERVICEABLE PARTS INSIDE. REFER SERVICING TO QUALIFIED SERVICE PERSONNEL.

WARNING: TO REDUCE THE RISK OF FIRE OR ELECTRICAL SHOCK, DO NOT EXPOSE THIS APPLIANCE TO RAIN OR MOISTURE.



This symbol, wherever it appears, alerts you to the presence of uninsulated dangerous voltage inside the enclosure — voltage that may be sufficient to constitute a risk of shock.



This symbol, wherever it appears, alerts you to important operating and maintenance instructions in the accompanying literature. Read the manual.

Manufactured under one or more of the following U.S. patents: 3,377,792; 3,681,618; 3,714,462; 3,789,143; 4,097,767; 4,329,598; 4,403,199; 4,409,500; 4,425,551; 4,473,795. Other patents pending.

This dbx-branded product has been manufactured by AKG Acoustics, Inc.

AKG is a registered trademark of Akustische u. Kino-Geräte Ges m.b.H., Austria. All trademarks are property of their respective companies.

This manual is part number 96014-000-02

© Copyright 1993 by AKG Acoustics, Inc.

150 - FB - 1/93

The logo for dbx Professional Products, consisting of the lowercase letters "dbx" in a bold, sans-serif font.

dbx Professional Products

a division of AKG Acoustics, Inc.

1525 Alvarado Street, San Leandro, CA 94577 USA

Telephone (1) 510/351-3500 Fax: (1) 510/351-0500

SPECIFICATIONS

Frequency response

20 Hz-20 kHz +0.5 dB

THD (total harmonic distortion)

0.2% at maximum
compression, 1 kHz, 0 dBv

Equivalent input noise

-85 dBv unweighted

Maximum input

+24 dBv

Maximum output

+21 dBv

Input impedance

25 k-ohms differential,
18.5 k-ohms unbalanced
Detector: 6.8 k-ohms, unbalanced

Output impedance

Low, single-ended, for driving 600 ohms or greater

Output gain

-20 to + 20 dB

Threshold range

Compressor: -40 to +20 dBv
Gate: +10 to -60 dBv
PeakStop: 0 to +21 dBv

Attack times

Compressor (program-dependent):
15 ms for 10 dB,
5 ms for 20 dB,
3 ms for 30 dB

Gate:

2 ms for 28 dB (70% of return to unity gain)

Release times

Compressor:
8 ms for 1 dB,
80 ms for 10 dB,
400 ms for 50 dB (125 dB/s rate)
Gate, slow: 100 ms for 1 dB
fast: 100 ms for 100 dB

Maximum compression

Greater than 60 dB

Power requirements

90-135 V (110-V model),
200-260 V (220-V model),
50-60 Hz; 15 W

Dimensions

1-3/4" h x 19" w x 8" d

Notes

- 1) Specifications are subject to change.
- 2) All voltages are rms (root-mean-square).
- 3) 0 dBv is defined as 0.775 V regardless of load impedance. Subtract 2.2 from the dBv figure to convert to dBV (i.e., referred to 1 V). When the load impedance is 600 ohms, this particular dBv is also known as "dBm."
- 4) Noise figures are for 20 Hz-20 kHz.
- 5) Measured in the infinite-compression region of the dbx OverEasy curve, attack time is the time required to reduce the signal by 63% of the level increase above threshold, while release time is the time required to restore gain to 90% of the level decrease below threshold.

REAR, Channel 2 (1 is identical)

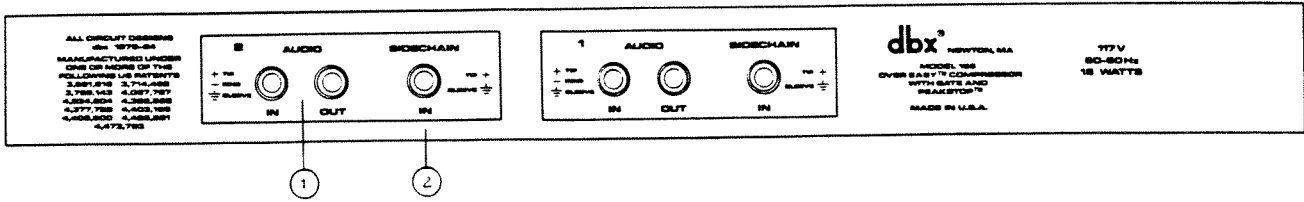

- 1 **AUDIO:IN, OUT.** These two 3-circuit phone jacks are the Input and Output. As marked, these jacks are the standard tip/plus, ring/minus, and sleeve/ground.
- 2 **SIDECHAIN:IN.** This jack provides a direct input (optional) to the rms-detector circuitry. It is used for connecting a signal processor for altering the dynamic response of the 166. An example would be an equalizer to make the compression or the gating frequency-sensitive (see Sidechain Monitor, below). This input uses a 2-circuit phone jack: tip is plus, sleeve ground.

FRONT, Channel 1 (2 is identical)

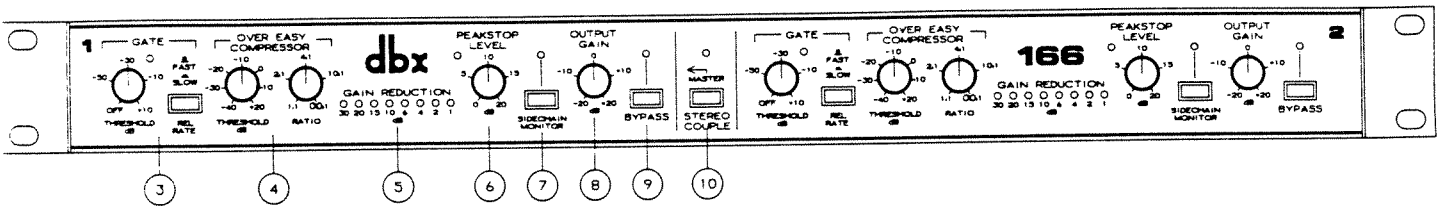

- 3 **GATE:THRESHOLD and RELEASE RATE:FAST, SLOW.** The 166 gate is a below-threshold attenuator with two release rates. The Threshold knob sets the level below which the 166 gates — attenuates — the signal. The LED lights whenever this takes place. As marked, the threshold ranges from +10 to below -60 dB; Off, of course, inactivates the gate. The amount of attenuation is set at 40 dB.

The RELEASE RATE switch controls how fast the signal gets attenuated. In the Slow position (in), the rate is useful for general-purpose gating of noise behind vocals and acoustic instruments — about 10 dB/s. In the Fast position, the rate is very fast (1000 dB/s), useful for tightening up the sound of percussion (e.g., kick or snare drum) and drying up leakage from other instruments into percussion tracks.

The attack rate of the gate (which controls how fast the signal is restored after being attenuated) is internally set to be very fast — fast enough to allow all of the transient at the beginning of a note to come through.

- 4 **OVEREASY COMPRESSOR:THRESHOLD and RATIO.** The Threshold knob sets the point at which dbx's well-known Over-Easy circuit begins to compress the dynamic range of the signal. The calibration numbers refer to the middle of the Over-Easy curve (see right); at an Infinity:1 ratio, they denote the point where there's approximately 6 dB of compression. The OverEasy sound is musical and unobtrusive, without the "held-back" feeling of other compressors.

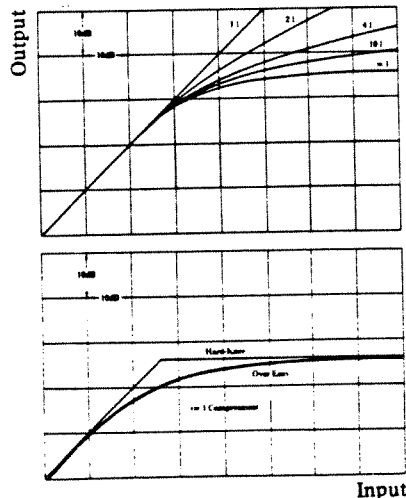

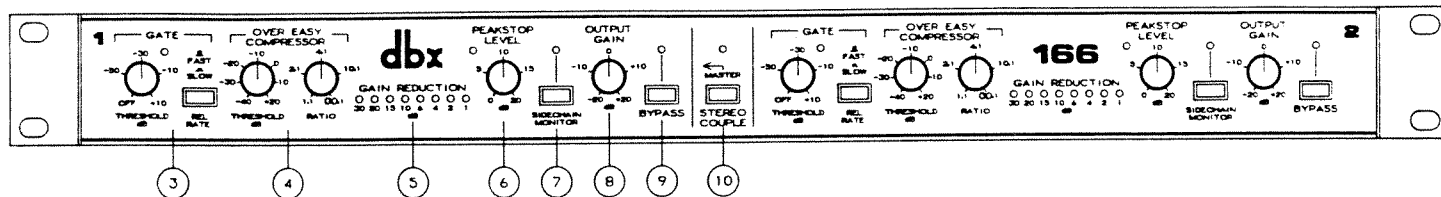

The Ratio knob controls how much the signal will be compressed once it's well above the threshold, in the straight-line section of the OverEasy curve. The ratio is the change in input level divided by the change in output level, e.g., a 4:1 setting means that for a 4-dB increase in input level the output will increase by only 1 dB. At Infinity:1, the output will remain at a constant level irrespective of input dynamics (as long as the input is above threshold) — in other words, full limiting.

- 5 GAIN REDUCTION LEDs. These show how much the signal is being attenuated by the Gate, the Compressor, or both.
- 6 PEAKSTOP LEVEL knob. This sets the maximum peak-output level. The control is calibrated to the rms value of a sine wave just being clipped. The LED lights whenever this clipping — soft at the start, becoming hard as necessary for absolute protection — occurs. See the note on page 9.

This is the last circuit the signal goes through, so it always controls the maximum output regardless of any other control — including Output Gain.

- 7 SIDECHAIN MONITOR switch and LED. Pushing this in connects the Sidechain input directly to the Audio Out, for monitoring the sidechain signal during setup. Be careful not to push this button inadvertently — it affects what you (and everybody else) will hear, or what's going to a console/mixer or tape recorder. Note that PeakStop is in the sidechain signal path when Sidechain Monitor is selected.
- 8 OUTPUT GAIN. This knob controls the overall gain of the 166, from -20 to +20 dB. It is independent of all other controls although, as mentioned, it does come before the PeakStop circuit.
- 9 BYPASS switch and LED. Pushing this in provides a hardwire bypass for the 166, connecting input to output (fully balanced if so wired) even in the absence of ac power.
- 10 STEREO COUPLE switch and LED. Pushing this in turns the 166 from a dual-mono unit with two identical, independent sets of controls into a stereo unit. Except for Sidechain Monitor and Bypass, Channel 1's controls are overridden by Channel 1's in the Stereo Couple mode. Note that the detection circuitry senses the true rms levels of the combined signal, so it is unaffected by phase shifts (or other discrepancies) between the channels. Among other benefits, this enables stereo compression without loss of imaging stability.

TYPICAL HOOKUPS

All 166 connections are made through the rear phone jacks; our figures in this section show the wiring of plugs and cables to make these connections. Again, tip is plus (or high, or hot), ring is minus (or low), and sleeve is ground or shield (or earth).

Audio inputs and balanced and unbalanced sources

Your unit's two signal inputs are balanced electronically with differential amplifiers. They won't unbalance a balanced source, and they may be used with unbalanced sources as well. Here's a general-purpose diagram:

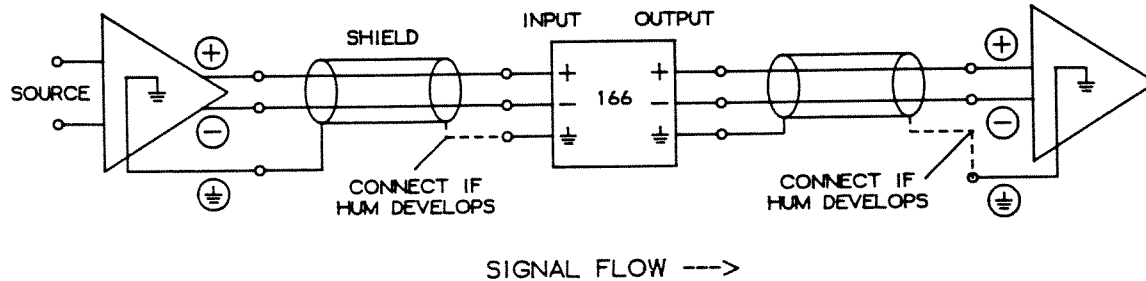

For maximum hum rejection, avoid common grounding at the 166's input and output. The best starting point is to ground the shield of the input cable and the source device (leaving it unconnected to the 166) and to ground the shield of the output cable to the ground of the 166 (leaving it unconnected at the receiving device).

A balanced line is defined as two-conductor shielded cable with each of the two center conductors carrying the signal but of opposite polarity and equal but opposite potential difference from ground. An unbalanced line is a single-conductor shielded cable with the center conductor carrying the signal and the shield at ground potential.

Figure 1 shows the connection of balanced signal sources to either audio input jack. Note that for this connection a 3-circuit phone plug is necessary, as is dual-conductor shielded cable. Sometimes the plug is called a "stereo" phone plug because it's often used for such stereo circuits as headphones.

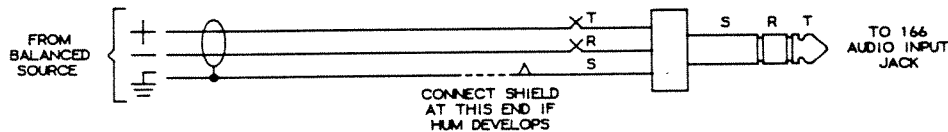

Figure 1: Balanced sources

Figures 2a and 2b show an unbalanced source connected to these inputs. In 2a, a 3-circuit phone plug is used (and the ring is connected to the shield), while in 2b a 2-circuit ("mono") phone plug is used. Since this plug has a continuous sleeve (where the 3-circuit plug has both sleeve and ring), the plug automatically shorts the sleeve to the ring at the 166 input.

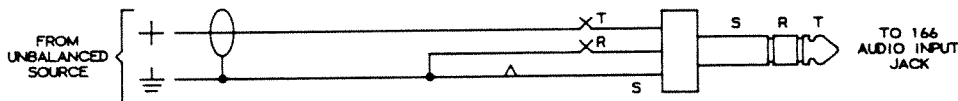

Figure 2a: Unbalanced sources, dual-conductor shielded cable

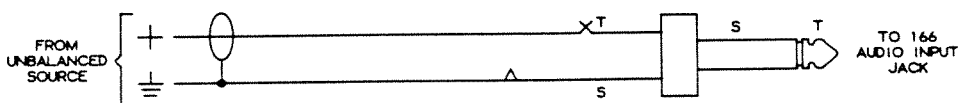

Figure 2b: Same, single-conductor cable

In situations with high radio-frequency interference (RFI) but unbalanced sources, wiring as shown in 3a and 3b may be of use. These call for 2-conductor shielded cable with 3-circuit or 2-circuit plugs and use the shield as only a shield, the ground connection actually being made with one of the center conductors.

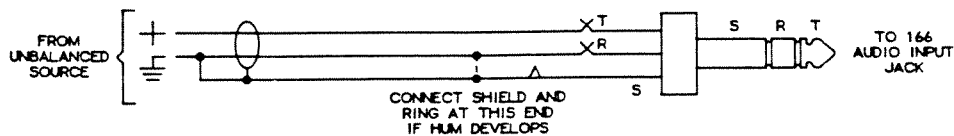

Figure 3a: Unbalanced sources, dual-conductor shielded cable, stereo plug

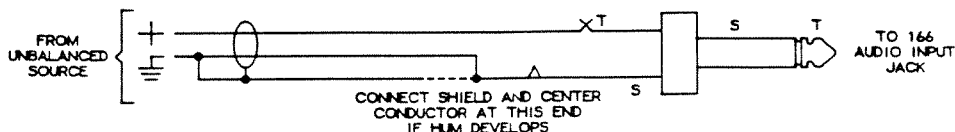

Figure 3b: Same, mono plug

Audio outputs and balanced and unbalanced loads

The two audio outputs are driven by unbalanced single-ended line amplifiers whenever the Bypass switches are not depressed. Able to drive 600-ohm or greater loads to +21 dBv, these stages are suitable for connection to most studio equipment, balanced or not.

Figure 4 shows the balanced connection of the set of output terminals to balanced inputs. Note again that each output has signal tip/ring/sleeve ([+], [-], and ground), like the balanced inputs. The outputs are connected directly to the inputs in Bypass mode, so a balanced input remains balanced at the output when the unit is bypassed. The minus and the ground terminals of each output are internally connected whenever the unit is not bypassed.

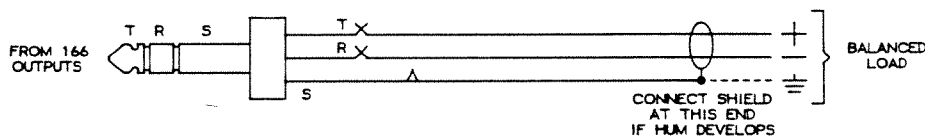

Figure 4: Balanced ins and outs, dual-conductor shielded cable, stereo plug

Figures 5a and b show the output connections for unbalanced loads with 3- and 2-circuit plugs. As with the inputs, a 2-circuit plug (5b) will contact the ring (-) contact in the jack, which is perfectly okay for unbalanced loads; note that in Bypass, this will unbalance balanced sources, because the jack shorts the ring (-) contact to ground.

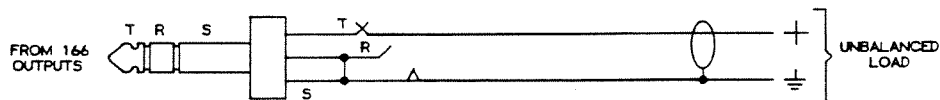

Figure 5a: Unbalanced loads, single-conductor shielded stereo plug

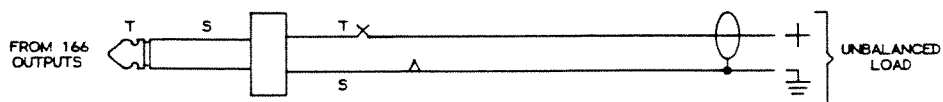

Figure 5b: Same, mono plug

Figures 6a and b show the use of 2-conductor shielded cable and either 3- or 2-circuit plugs with unbalanced loads; like 3a and b, this often is useful for combatting RFI with unbalanced loads.

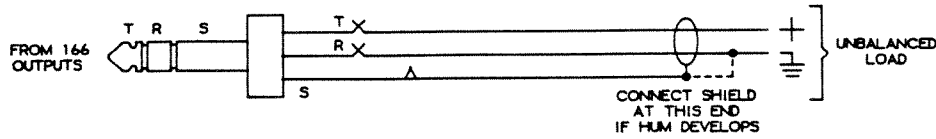

Figure 6a: Unbalanced loads, dual-conductor shielded cable, stereo plug

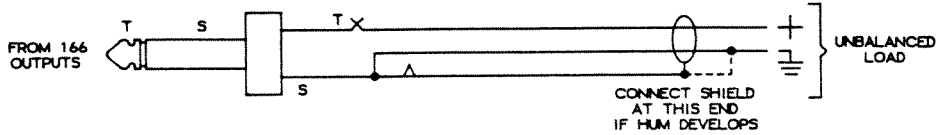

Figure 6b: Same, mono plug

Sidechain hookups

The sidechain inputs are unbalanced. They'll work with balanced and unbalanced sources, but will unbalance a balanced output.

Figure 7a shows the connection of an unbalanced signal source to either sidechain input jack; a 2-circuit plug is used since there are only two connections to make. If a 3-circuit plug is used, either leave the ring unconnected or connect it to the shield.

Figure 7b shows the connection of a balanced source to either sidechain input. Most balanced sources will work without the dotted connection between the (-) output and ground (this is true for "active-balanced" outputs and "ground-referenced" outputs). However, some sources require the dotted connections shown — "transformer-isolated" balanced outputs. We recommend making this connection only if necessary for your installation, because some active balanced and ground-referenced outputs may be damaged by doing so. Note that a 2-circuit plug is used here; follow the instructions above if a 3-circuit plug must be employed.

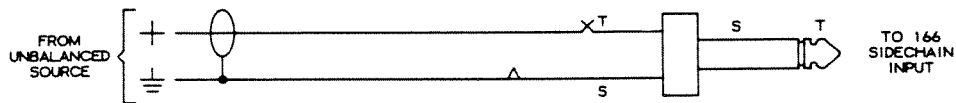

Figure 7a: Unbalanced source

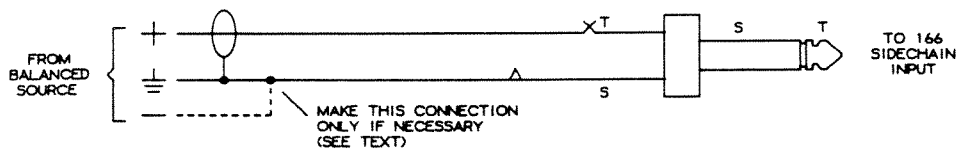

Figure 7b: Balanced source

Patch bay hookups

Please see page 12.

ABOUT GATING

Noise reduction

The basic purpose of a noise gate is to remove unwanted background sounds in the spaces between desired foreground sounds. Note that there has to be some real distance in level between the unwanted and wanted material — at least a few dB — in order for the 166's gate to "get its foot in the door." If levels are too close (e.g., because of earlier compression, or because the mikes were closer to the unwanted than to the wanted sound), the gating efforts of the 166 will be for naught.

One of the more common uses for a gate is to tighten or "dry up" drum sounds. As with most dynamics processing, it's ideal if there is a separate mike on each drum and cymbal (or group of cymbals) and each is individually gated. Each mike is auditioned separately and the gate threshold adjusted to eliminate the sound of all but the desired drum. (Hint: start with the threshold very low, so all the sounds come through, then increase it until only the desired drum is left.) It's likely that you'll find the Fast release setting best for most drums, while slow usually is better for cymbals and some toms. When things are adjusted correctly, each drum will sound tight, punchy, and dry -- detailed and defined.

When you don't have enough mikes (or 166es!) to cover each drum, then group them: snare and center toms, side toms, bass, cymbals. The idea is to get as close as possible to only one mike on at a time so only one sound is picked up, instead of several.

Another common use for a gate is in vocal recording. Especially after compression, the noises picked up by a mike an inch away from a singer's mouth can be very obtrusive. Try the 166 in its slow release mode to gate out these noises. Other applications include keeping live drum tracks from "contaminating" an acoustic-piano track, and general solving of other sorts of leakage problems.

Changing sound quality

There's more to gating than just keeping out unwanted background noises: you can use the 166 gates to change sonic character. This is because gates can be used to reduce or otherwise alter the quality of instrumental ambience and reverb. As the sound decays after an instrument stops, its reverberation level will fall through the 166's Threshold setting, below which it can be made to die out more or less quickly — in any case faster than the natural sound. Experiment with changing the "tail" of the sound; the fast setting will nearly eliminate reverb.

In other situations, a 166 can be used to prevent or reduce leakage among mikes in sound reinforcement or during panel discussions. Simply set the Threshold control below the level of the music or speech. Similarly, in broadcasting, a 166 can be used to clean up noisy feeds (land lines, ENG audio) if it's placed at the output. Wind or air-conditioning noise during a remote interview can be controlled as well: proper 166 gate attenuation can keep noise during pauses from being either loud (obtrusive-sounding) or too soft (peculiar-sounding) — or modulated.

The attack time of the 166 gate is short, so the complete transient at the beginning of a sound comes through. We've already touched on the differences between the Fast and Slow release rates, but never hesitate to experiment to get the best results for a particular situation.

ABOUT COMPRESSION

General

The purpose of a compressor is to reduce the dynamic range of a program and give you control over its dynamics. The 166's Ratio and Threshold controls can produce a wide variety of dynamic-range-reduction effects, from gentle taming of overall dynamics to limiting of peaks to squashing all dynamics.

For example, at low compression ratios, a very low Threshold setting can be used to reduce gently the overall dynamic range of a program. Higher ratios with low thresholds will provide leveling for instruments and vocals. High thresholds generally are used for limiting program levels overall. Ratios of 6:1 and higher effectively prevent outputs levels from much exceeding the threshold (assuming the Output Gain is set to 0).

Note that compression of the entire program (produced by low thresholds) tends to sound less natural at high ratios. Ratios of perhaps 4:1 and lower affect dynamics to a lesser degree, and are often used to tighten up a bass guitar, snare, and vocals. Moderate settings typically are used during mixdowns and for leveling the program in a broadcast.

The 166's OverEasy circuit prevents compression at high ratios from sounding too unnatural. This is because as the signal rises above threshold, the ratio changes gradually, from 1:1 (no compression) to that set by the front-panel knob. You can put this feature to especially good use in those situations when you need protection from excessive peak levels but desire gentle compression on most of the program. By setting the threshold at a moderate level and using a moderately high compression ratio (6:1, 10:1, etc.), you will provide limiting for signals well above threshold and gentle compression (much less than that set) for signals at or below threshold. See the OverEasy curve, p. 2, to understand how this works.

It's always useful to watch the gain-reduction LEDs to see the amount of processing taking place. With practice, a glance will confirm what your ears tell you — that things are going okay, or that there's a little too much or too little. Your 166 can achieve desirable effects with proper settings derived from experience; when it's used too liberally, the unusual results may be suited to special effects only.

Here are some specific situations.

Variations in mike levels

As the distance between vocalist and microphone changes, signal levels change. Start at 2:1 with a low threshold setting to begin to smooth these out. With OverEasy, ratios up to 10:1 can be used here to good effect.

Variations in instrument levels

To achieve smooth electric-bass sound, start at about 4:1. Strings and horns likewise benefit, and strings will have their "sustain" increased. Note that large amounts of compression are usually more audible in a mixed stereo program; if the separate tracks were compressed before mixing to create the program, compression is much less noticeable.

Raising the signal out of a mix

Since reducing dynamic range can increase the average signal level and meter readings, a single track can be brought up out of a mix by boosting its level slightly and applying compression. It's also possible to separate certain vocals and instruments from an already mixed program by using the sidechain; see p. 10.

Preventing tape saturation

A high threshold (but below tape saturation) and high compression ratio will cause the compressor to reduce gain in a controlled manner before the tape overloads and distorts.

Speaker protection and acoustical distribution

Compression will keep excessive levels from damaging drivers in sound-reinforcement systems. Limiting also enhances intelligibility by letting low-level material be reproduced throughout the house at higher volumes; in a performance, this increases intimacy, as whispers become clear at virtually every seat. Our OverEasy characteristic permits high amounts of compression (e.g., 10:1) to be used without vocalists or musicians feeling choked back — and with high average levels maintained without speaker damage due to heat buildup in the drivers. As a rule, to give the best protection, your 166 should be as close as possible in the signal path to the power amp. For maximum SPLs, large sound-reinforcement systems frequently have a separate compressor on each output of the electronic crossover(s).

Where the 166 will be expected to allow virtually no level change unless an emergency (wildly excessive levels) arises, set the ratio to Infinity:1 and the Threshold to the highest level. OverEasy will never act in the fast, unpleasant manner of a typical "hard-knee" compressor, but it will give a measure of real protection. See the next section, too.

ABOUT LIMITING and SOFT CLIPPING

PeakStop allows you to control the maximum peak levels at the output of the 166 irrespective of any other control. As mentioned, it comes after the compression and other circuitry, including the output gain, so it lets an absolute limit be put on the peak-to-peak excursions of the output. PeakStop works instantaneously; you'll be able to apply moderate amounts of compression and still be independently protected from large transients, other short-term overloads, and broadcast overmodulation.

PeakStop consists of a sophisticated voltage-controlled clipper that produces a minimum of audible distortion. It rounds the corners of a peak rather than cutting it off sharply, as the term "clipping" implies. By making a signal's leading and trailing edges curves instead of sharp corners, it reduces the amount of higher-order, offensive-sounding harmonics that conventional clipping causes. The level at which PeakStop is activated is adjustable from 0 to +20 dBv. Note that small signal excursions above the set value of PeakStop are possible, to allow the rounding to take place. Therefore, for any applications where you must not exceed a given ceiling, set the PeakStop control 1-2 dB below it to be sure.

The PeakStop LED flashes whenever peaks attempt to exceed the PeakStop level and get reduced in amplitude. To disable the function altogether, simply set the control to +20 (which is the maximum output level of the 166 anyway).

In use, the PeakStop function can prevent an amplifier from being driven into hard clipping, where it may lose control over the speaker system. PeakStop is a smooth, well-controlled clipper whose behavior is sonically similar to the gentleness of OverEasy compression; its clipping is much preferable to a power amp's. As noted, control of speaker overexcursion, of broadcast overmodulation, and of harsh electronics clipping are all applications; with PeakStop and OverEasy, you have the best of both worlds: virtually inaudible rms compression and peak protection downstream, at the end.

Normally, the control is set to just under the peak clipping level of the equipment downstream. This way, clipping will be softer and controlled within the 166. The LED should light occasionally, on peaks only; if the LED lights often, of course, reduce the compression threshold and/or increase the ratio, to allow less peak signal level at the output.

SIDCHAIN APPLICATIONS

In all the following situations, it's the Sidechain Monitor function that will save you time and trouble, letting you adjust the preceding processor(s) and instantly confirm that things are (or aren't) going the way you want them to.

General hints

It's possible to separate certain vocals and instruments from a mix by making the compression frequency-sensitive. With an equalizer inserted into the Sidechain input (but not in the audio path), the EQ settings do not shift the timbre or equalize the audio signal; they merely alter the threshold of the compressor as a function of frequency.

In such an arrangement, frequencies that are boosted on the equalizer will be suppressed in the audio signal. The converse may also be used, of course: dipping the equalizer on a particular band prevents any sound with dominant energy in the affected register from compressing so much, because the 166 will detect less need for compression.

For example, if you want to suppress an overly loud bass drum, boost the equalizer's response below about 150 Hz. This will make the compressor reduce gain whenever energy in this region is detected. Furthermore, raising the threshold will cause this to happen only on very loud kicks. To put it generally, a relatively high threshold setting can prevent most sounds from being affected while solo and very loud sounds within that frequency range are held back. (Of course, when compression does occur, the entire program level is affected.) Depending again on the threshold setting, frequencies outside that range will not cause compression.

During the recording of cymbals and toms, a compressor with an EQ in the sidechain path can help prevent tape saturation. The equalizer can be adjusted for a boost peaking at about 5 kHz, causing the cymbal to be compressed on a very loud crash and stopping saturation of the tape at higher frequencies, where there's less headroom. However, gentle tapping with a stick or cymbal brushing will not be held back. And the tom-tom likewise, being a lower-frequency instrument and better-tolerated by the tape, has less need for compression. EQ in the sidechain circuit can make the compressor not as readily triggered by a loud tom-tom beat as by an equally loud cymbal crash.

De-essing

In the absence of a de-esser, small amounts of high-frequency (6-10 kHz) boost in the sidechain path frequently will help in the processing of vocals that may have been brightly equalized beforehand or that suffer from prominent sibilance ("ess" sounds).

Speaker protection

If a single compressor is to be used with a multi-way speaker system (after EQ, before the crossover), you are faced with the problem of keeping the entire system level down below the point of destruction of the most sensitive component. If midranges are frequently blown, for example, the whole system must be run at a lower SPL or additional mids must be added. By the insertion of an equalizer in the sidechain of the 166, it can be made sensitive to the frequencies the midranges handle, permitting the entire PA system to be run at higher average levels and dropped back only when damaging signals are present.

Broadcasting

A preemphasis filter network placed in the sidechain of a 166 processing preemphasized audio permits higher average signal levels to be run within the headroom limits of the broadcast chain.

Filtering

Narrow-band ("notch") filtering for rumble, feedback, equipment noise (e.g., cameras) may be put in the sidechain to make the compressor less sensitive to such problems.

Anticipatory compression

If you feed the program directly into the sidechain and send the audio signal through a delay before the 166 audio input, the 166 can "anticipate" the need for gain change. With experimentation, the effect can become that of "zero" attack time at a given frequency. Additional delay beyond this "zero" time will then cause the compressor to finish reducing the gain before the leading edge of the loud passage even enters the 166, which will cause the program material preceding the loud passage to be suppressed. The 166 will then begin to recover from compression (it will release, in other words) before the loud passage has dropped back down toward the set threshold. This will cause the output level to surge as the note(s) should be decaying. Such a special effect sounds similar to the dynamic-envelope inversion you may be familiar with from reverse tape playback. See diagram.

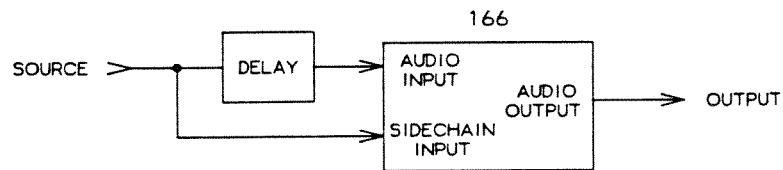

Keyed gating

Controlling the gating of one signal by another permits perfectly in-synch playing and overdubbing among individual instruments or precise sonic augmentation — "fattening" — of a weak solo. An example of the former would be synchronizing bass guitar and drum; an example of the latter would be using the drum signal to key an oscillator which is set at an appropriate frequency to "tune" and "punch up" the drum sound. See diagram. As noted, the Release Rate switch is helpful for determining the sound of the final product.

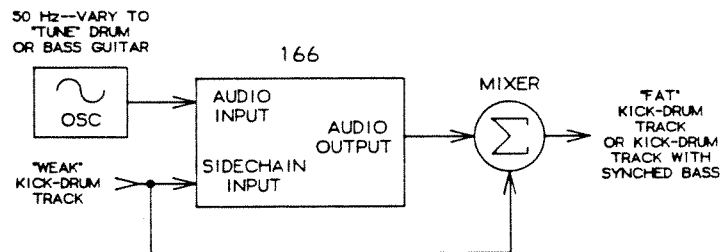

Selective gating

You can also do frequency-sensitive gating, letting you tune the response of the gating action. If you're gating a kick drum, for example, in a track with lots of leakage, you can tune in to the frequency of the kick with an EQ and the gate will respond only to the drum. Again, see diagram below.

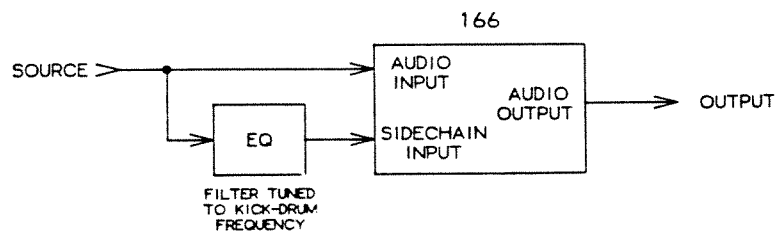

STEREO DYNAMICS PROCESSING

Stereo coupling is useful for all applications where two channels must be compressed and the left/right perspective must remain the same. Examples include the L and R overhead mikes on a drum kit or piano, a stereo submix of a vocal ensemble, the feed from an X-Y or other pair of mikes in a classical recording, a complete stereo mix, etc. All of our earlier comments about compression and gating apply here; the difference is that when the Stereo Couple switch is pushed, the gain changes in the two channels will be identical.

In this mode, the signals at each rms detector are combined (so the true rms sum can be sensed) and controlled. As mentioned, all functions of Channel 1 control both channels except for Sidechain and Bypass.

Use this mode whenever imaging must remain stable.

PATCH BAY HOOKUPS

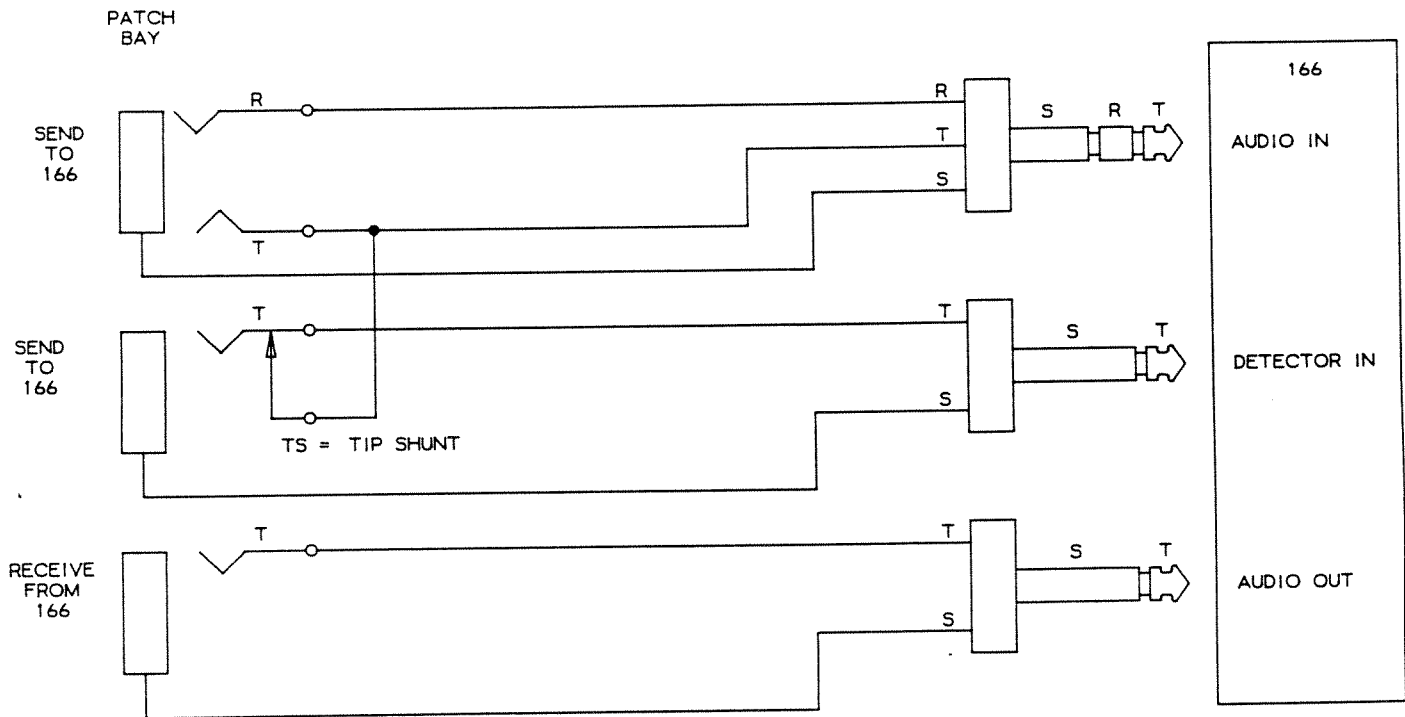

Circuit description

Schematic conventions: The 166 is two independent processors that can be linked for stereo operation. As such, the circuitry for each channel (referred to as ch.1 and ch.2) is identical. The following descriptions will refer to ch. 1 and indicate the corresponding ch.2 reference in parentheses (). The power supply and stereo coupling circuitry is common to both.

Audio signal Path

Input Buffer

The incoming audio signal is first buffered by OA1 (OA6). This is an active balanced circuit with a gain of less than unity (0.68 or -3.33 dB). This attenuation is done in order to maintain +24dBv maximum level with +/- 15 volt power supplies. The signal from the tip of the input jack goes to the non-inverting input and the signal from the ring goes to the inverting input. Resistors R1 and R4 (R101 and R104) and capacitors C11 and C12 (C41 and C42) provide RF protection by shunting very high frequency signals to ground. The cutoff frequency is approximately 1.5 MHz depending on the source impedance.

VCA

The signal is then ac coupled through C14 (C44) to the VCA (voltage-controlled amplifier) circuit of IC1 and OA1 (IC8 and OA6). IC1 is the gain control device in which the ratio of input current to output current (in dB) is proportional to the voltage at pins 2 and 4. This is where the control voltage (CV) is applied. The gain is 0dB (unity) when the voltage here is 0 volts with the gain changing by 1 dB for every 6mV of CV. Negative CVs produce positive gains and positive CVs produce negative gains. For example, with this scaling of -6mV/dB, a CV of +36mV will cause the output to be attenuated by 6dB. (See dbx application note AN106 for a detailed description of VCA design and operation.) The output current of IC1 is converted to a voltage by OA1 and then fed through the PeakStop circuit to the Output Buffer. Symmetry adjustment is provided by R8 (R108) and is used to minimize VCA distortion and offset.

PeakStop Circuit

This circuit provides "soft clipping" of the signal peaks when absolute control of maximum instantaneous output level is required. Diodes CR5 and CR6 (CR9 and CR10) will limit the positive and negative signal excursions at pin 3 of OA2 (OA7) to about 0.5V above the bias voltage on these diodes. The bias voltage is set by the front panel PeakStop control, which is buffered by OA3. Calibration of the control is accomplished by adding or subtracting an offset voltage via R23 (R123). The bias voltage is also sent to comparator IC4 (IC11), which compares this voltage with the audio signal voltage. When the audio signal exceeds the bias voltage (indicating that either diode is on the verge of conduction), the output of IC4 will go low causing the output of IC5 to go high (actually an open circuit) and lighting the PeakStop LED. C23 (C53) slows the signal at pin 6 of IC5 when it goes positive. This ensures that the LED will remain lit long enough to see even when the peak is very short.

Output Buffer

600 ohm output drive to +21 dBv is provided by OA2 (OA7). The circuit is non-inverting and has a gain of +3.3 dB, which adds back the gain that was taken away by the input buffer. The two 22-ohm resistors R17 and R18 (R117 and R118) serve as protection in the event that the output is connected incorrectly. Note that R17 is inside the feedback loop of OA2 and does not contribute to the actual output impedance. R18 is connected outside the feedback loop in series with the connection to the rear panel jack, causing the output impedance of the 166 to be 22 ohms.

Control Voltage Path

Rms Detectors (general)

The heart of the level sensing circuitry in the 166 is the dbx patented rms integrated circuit. This IC takes an ac signal at its input and produces a dc voltage at its output that is proportional to the true rms level directly in dB. The input (pin 1) is a current, requiring a resistor in series from a voltage source, and acts basically like a summing junction (virtual ground). This input resistor sets the nominal level at which the output (pin 7) is 0 volts. This output is a low impedance voltage source and can drive external circuits directly. The scaling of the output is always +6mV/dB. Along with this dc voltage is a small amount of ripple which is at twice the input frequency. The "RMS SYM" trim pot adjusts this ripple for perfect symmetry. Time constants are adjustable with external resistors and capacitors connected to pin 6. For a more detailed explanation of this IC see dbx application note AN110.

The 166 utilizes two of these rms detectors per channel. One operates relatively slowly and is optimized for natural-sounding time constants and is used as the level sensor in the compressor part of the 166. The other rms detector runs much more quickly (about 200 times faster) and is used in the Gate circuit to catch instantaneous signal level-changes. Both of these detectors are fed from the output of the input buffer, through the tip shunt of the Sidechain Input jack. Insertion of a plug in this jack interrupts this normal internal connection and allows external signals to control the compression and gating of the 166.

Slow Rms

As described above, this circuit is used for the compressor part of the 166. It is also used as part of the Gate circuit to be described later. The output of IC2 (IC9) at pin 7 is 0.000 volts when the input level is -30dBv and is set exactly by trimpot R34 (R134). RMS symmetry is set by R32 (R132). C28 and C29 (C58 and C59) set the release rate at 125dB per second. This is the maximum rate at which the compressor will return to unity gain after the input signal falls below the Threshold setting.

Fast Rms

The operation of this circuit is the same as described above except that the release rate is now 25,000 dB per second. The output of IC3 (IC10) is fed only to the Gate circuit. The output at pin 7 is 0.000V with an input level of -20dBv. Level calibration is via R69 (R169) and symmetry is adjusted by R67 (R167). The ripple is also much greater due to the smaller value of the capacitor C35 (C65).

OverEasy Threshold Circuit

The output of the slow rms detector and the front panel Compression Threshold control R46 (R146) are scaled and summed here. The output of OA4 (OA9) will be negative whenever the level of the audio signal is greater than the Threshold setting on the front panel. This causes the 166 to begin to compress (reduce the gain) of the signal at the VCA. The actual amount of compression is determined by how far the signal is above threshold as well as by the setting of the front panel Ratio control, R50 (R150). The diode CR8 (CR12) performs two important functions. First, it prevents positive voltages from getting through which would cause gain at the VCA; second, due to the turn-on characteristic of diodes, it provides the gentle OverEasy transition into compression. Diode CR7 (CR11) compensates for variations in the OverEasy diode characteristics due to temperature changes. Calibration of the front panel Threshold control is done with R43 (R143).

Gate Circuit

The signals from the slow rms and fast rms are compared with the front panel Gate Threshold setting by IC4 (IC11), a quad voltage comparator. When both rms levels fall below the Threshold set by R75 (R175), the comparator outputs charge up from -15V to ground through C36 (C66) and either R78 (R178) or R81 (R181), depending on the setting of the Release Rate switch S2 (S5). When either rms level goes above this threshold, C36 quickly discharges through R79 (R179). This sets the attack time. The amount of attenuation from the Gate circuit is controlled by R63 (R163) at OA5 (OA10).

Control-Voltage Summer Circuit

The outputs of the OverEasy Threshold circuit and the Gate circuit are summed at OA5. When there is no compression or gating, the output should be 0.00 volts. This sets the unity gain level at the VCA and any offsets are adjusted out by the trim R53 (R153) and monitored at TP3 (TP7). The output is fed to the LED Display at a scaling of 24mV/dB and summed at OA4 (OA9) with the front panel Output Gain control. This signal is the final control voltage and goes to the VCA with at a scaling of -6mV/dB (for example, +18mV here translates to 3dB of attenuation at the VCA).

LED Display

Q1 (Q2) provides a constant current of approximately 10mA for the string of 8 LEDs. The comparators IC6 and IC7 (IC12 and IC13) shunt this current to ground when the control voltage (+24mV/dB) is smaller than the reference voltage at each comparator section. When the control voltage exceeds the reference voltage, the comparator section becomes an open circuit and allows the current to flow through LED, turning it on. All LEDs above this point will be on and all LEDs below it will be off.

Power Supply

The secondary of the power transformer reduces the ac input voltage to approximately 48V ac rms, which is full-wave-rectified by the diode bridge CR1, CR2, CR3, and CR4 and smoothed by capacitors C3, C4, C5, C7, C8, and C9 to produce +/- 24V dc. The voltage regulators VR1 and VR2 reduce this voltage to a constant + and - 15V dc used for most of the circuitry in the 166. The unregulated +/- 24V is used to supply current to the various LEDs. PC board jumpers Y1 and Y2 can be cut during power supply troubleshooting to isolate the supply from the rest of the 166's circuitry. The + and - 15V supply can be checked at TP10 and TP9.

Troubleshooting and alignment

Before attempting any troubleshooting or alignment, study the 166 owner's manual to familiarize yourself with the unit. The manual covers the operation of all controls, specifications for inputs and outputs, correct hookup etc. The following procedure assumes a basic understanding of the operational details of the 166.

1. Instruments Required:

- A. Audio-frequency sine-wave oscillator with 50-ohm output impedance (Krohn Hite 4200A or equivalent).
- B. Oscilloscope with 10-MHz bandwidth and 2mV/division sensitivity. (Philips PM 3233 or equivalent)
- C. Dc voltmeter capable of measuring 1mV (Fluke 8060A or equivalent).
- D. Ac voltmeter with rms response (Fluke 8086A or equivalent).
- E. Distortion meter, with low-distortion oscillator if necessary, capable of measuring THD to less than 0.02%. (Sound Technology Model 1700B or equivalent)

2. Inspection and warmup:

Inspect the unit for any signs of external damage such as a cut line cord or broken pots. Check the voltage rating on the rear panel and connect to appropriate ac mains. Let the unit warm up for at least 10 minutes before making any adjustments.

3. Disassembly:

Remove the four screws from the right end panel (viewing the unit from the front) and slightly loosen but do not remove the four screws from the left end panel. Remove the right end panel and slide off the top and bottom covers. Check that the nine LED connection cables are properly installed.

4. Power Supply:

Before attempting any calibration or troubleshooting, check that the power supply is working correctly. Verify the following:

Probe location	Test Condition	Tolerance
TP10	+15.00V	+/- 600mV
TP9	-15.00V	+/- 600mV
VR1, pin 1	+24 V dc	+/- 3 V dc, 750mV ripple
VR2, pin 2	-24 V dc	+/- 3 V dc, 750mV ripple

If any of the above conditions are not met, disconnect the ac mains and cut the jumper wires Y1 and Y2. Power up and check again. If the problem persists, then troubleshoot the power supply. If not, reconnect the jumpers (ensure a good solder connection) and look elsewhere in the 166, checking for burnt resistors or excessively hot devices (be careful not to burn your fingers).

Alignment Procedure:

Under normal conditions, the 166 should not require recalibration for the life of the unit. Alignment is necessary only if the unit has been disturbed mechanically or if replacement of critical components has been necessary. Since channel 1 and channel 2 are basically identical, the procedure does not specify channel numbers for any hookups. We suggest that you follow the complete procedure for Channel 1 first, then repeat for Channel 2. Any reference to components or test points are for channel 1 with channel 2 in parentheses ().

A. Slow Rms Symmetry and Level:

1. Connect oscillator to sidechain Input jack.
2. Set oscillator for 50 Hz at -32.5dBv. * (See note 1:)
3. Monitor TP1 (TP5) and adjust R32 (R132) for for a symmetrical 100Hz waveform on scope. See figure A.
4. Set scope for dc coupling and adjust R34 (R134) such that the top of the waveform is at the 0.00 volts line on the scope. See fig B.
5. Readjust R32 (R132) if necessary for correct symmetry.
6. Check operation of Sidechain Monitor switch and LED.

B. Fast Rms symmetry and level:

1. Connect oscillator to Ch.1 (Ch.2) Audio Input jack and set it for -20dBv at 1kHz.
2. Monitor TP2 (TP6) with scope and adjust R67 (R167) for best symmetry. See fig C.
3. Adjust R69 (R169) such that the tops of the waveform are 0.00v on scope.

C. Gate Attenuation:

1. Set Ratio control counterclockwise (ccw)
2. Set PeakStop control clockwise (cw).
3. Set Gate Threshold control ccw.
4. Adjust the Output Gain control for a reading of -20dBv at the Audio Output jack.
4. Rotate the Gate control CW until the Gate LED turns on.
5. Verify that the indicator on the control is midway between the -30 and -10 markings on the front panel.
6. Adjust R63 (R163) for a reading of -60dBv at the Audio Output jack.

D. Gain Adjust:

1. Set Ratio and Gate Threshold controls ccw.
2. Monitor TP3 (TP7) with the dc voltmeter and adjust R53 (R153) for a reading of 0.000 volts (+/- 6mV).
3. Set Output Gain control to exact mid-position and verify unity gain from the Audio Input to the Audio Output.

E. Compressor Threshold:

1. With oscillator still connected to Audio Input, set its level to 0.0dBv at 1kHz.
2. Set Ratio control cw. (∞ :1)
3. Set Compressor Threshold control to 0 on the front panel marking.
4. Adjust R43 (R143) until the first 4 Gain Reduction LEDs are lit (6dB marking).
5. Reduce oscillator level to -40dBv and set Threshold control to the -40 panel marking. Verify that the first 4 Gain Reduction LEDs are lit.
6. Increase oscillator level to +20dBv and set Threshold control to the +20dBv panel marking. Verify that the first four LEDs are still lit.

F. VCA Symmetry (Offset method)

1. Disconnect the audio input.
2. Set Gate Threshold and Output Gain controls cw.
3. Measure the voltage at the Audio Output jack with the dc voltmeter and note the reading (should be less than 25mV).
4. Set the Gate Threshold CCW and adjust R8 (R108) for the same reading as in step 3.

G. PeakStop Threshold:

1. Set Peakstop control CCW.
2. Connect oscillator to Audio Input jack and set to 1kHz at 0dBv.
3. Adjust R23 (R123) until the Peakstop LED just turns on.
4. Increase oscillator level to +20dBv and monitor the Audio Output with scope.
5. Verify that the output waveform is a rounded square-wave with an amplitude of approximately 4v p-p. See figure D.

H. Noise Check:

1. Remove the connections from the Audio Input.
2. Set Output Gain control to mid-position (unity gain).
3. Set Gate Threshold control ccw (off).
4. Connect the rms responding ac voltmeter to the Audio Output and verify that the reading is less than -83 dBv.
5. If an A-weighting filter is available, connect it between the 166 and the voltmeter. The meter should now read less than -87 dBv.

I. Distortion Check:

1. Set the 166's controls as follows:
 - Gate Threshold ccw (off)
 - Compressor Threshold cw (+20)
 - Ratio 1:1
 - PeakStop cw (20)
 - Output Gain to mid-position (unity gain)
2. Connect a low distortion oscillator to the Audio Input and set it for 1kHz at 0dBv.
3. With a suitable distortion analyzer, spectrum analyzer, or THD meter connected to the Audio Output, verify that THD is less than 0.1%.

* Note 1

0 dBv is defined as 0.775 V regardless of load impedance. Subtract 2.2 from the dBv figure to convert to dBV (i.e., referred to 1V). When the load impedance is 600 ohms, this particular dBv is also known as "dBm."

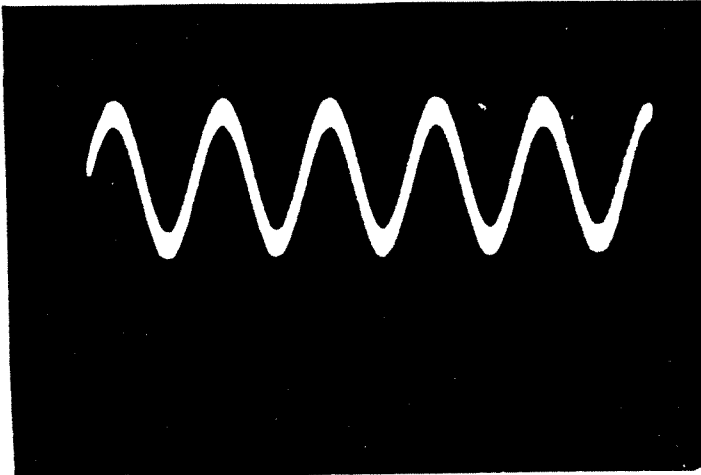

Figure A.
 TP1(TP5) After Adjusting
 R52(R152) for symmetry.
 (1mv/div vert. sensitivity)

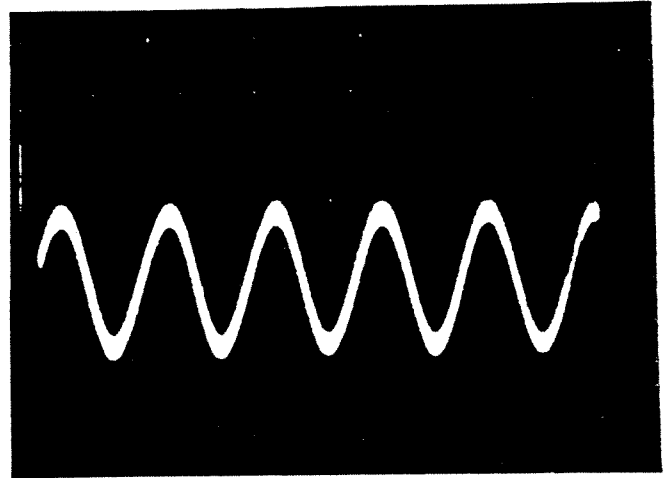

Figure B.
 TP1(TP5) After Adjusting
 R34(R134) for peaks at 0 vdc.
 (1mv/div, DC coupled)

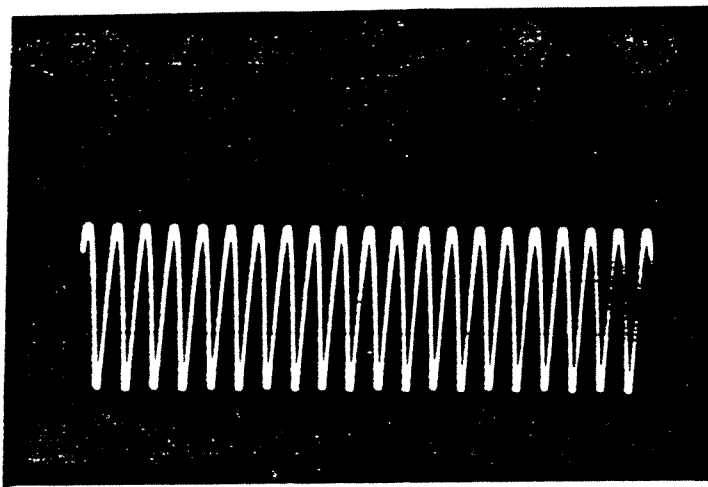

Figure C.
 TP2(TP6) After Adjustment of
 R67 (R167) for even peaks.
 (best symmetry)

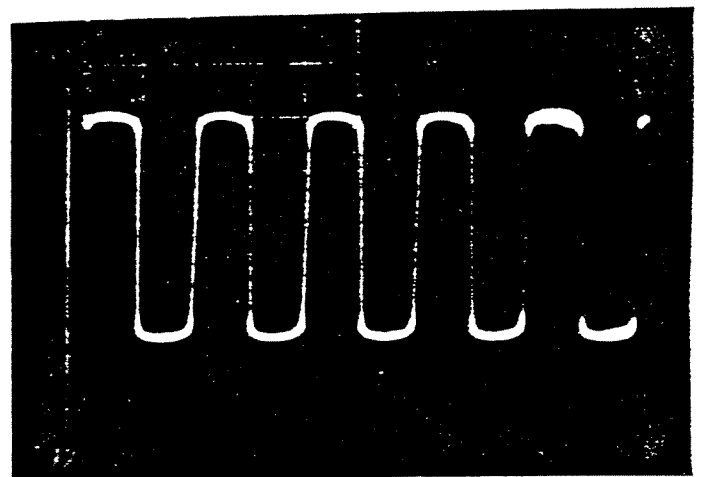

Figure D.
 Peakstop circuit limiting
 +20 dBv signal to approx
 4v P-P.

166 PRODUCTION TEST SPECIFICATION

1. OUT PRESETTING

- A). Set front panel controls as follows (both channels)
- | | |
|-----------------|---------|
| Gate Control | - off |
| Comp. Threshold | - +20 |
| Comp. Ratio | - 1 : 1 |
| Peakstop | - +20 |
| Output Gain | - 0 |
- B). Set all switches to their OUT positions.

2. SIDECHAIN JACK AND SWITCHING CHECK

- A). Feed both audio inputs with 1KHz 0dBm.
- B). Install phone plugs into both sidechain input jacks. (Phone plugs with no cables or signals attached).
- C). Monitor the channel 1 output.
- D). Press the channel 1 sidechain monitor switch. Check that the output drops to < -75 dBm. Check that the sidechain monitor LED is on.
- E). Monitor the channel 2 output.
- F). Press the channel 2 sidechain monitor switch. Check that the output drops to < -75 dBm. Check that the sidechain monitor LED is on.
- G). Remove phone plugs from sidechain jacks. Release both sidechain monitor switches.

3. FRONT PANEL GAIN POT CHECK & POINTER ALIGNMENT

- A). Monitor the channel 1 output.
- B). Set the channel 1 output gain pot for a 0 dBm reading on the short range dB meter.
- C). Loosen the 166 gain knob, line the pointer up with the front panel 0 mark, tighten the output gain knob and verify that the output still reads 0 dBm within the width of the knob pointer.
- D). Perform steps 3A to 3C for channel 2.

4. FREQUENCY RESPONSE

- A). Monitor the channel 1 output.
- B). Set the oscillator to the following frequencies and check that the output reads 0 dBv \pm 0.5 dB :

20Hz 200Hz 2000Hz 20KHz 100Hz 1KHz 10KHz

- C). Perform steps A, B for channel 2.

5. DISTORTION

- A). Monitor the channel 1 output.
- B). Set the oscillator to 1 KHz 0 dBm.
- C). Check that the second harmonic distortion is $<$ 0.036%. Check that the third harmonic distortion is $<$ 0.036%.
- D). Perform step 5A to 5C for channel 2.

6. NOISE

- A). Monitor the channel 1 output
- B). Short the input to the 166.
- C). Check that the noise reads $<$ -52 dBm (-87 on ATE).
- D). Repeat step 6 for channel 2.

7. GATE RELEASE RATE CHECK

- A). Set the Signal Generator to 1KHz 0dBm and press the channel 1 and channel 2 REL Rate switches in.
- B). Rotate the Gate Threshold pot clockwise until the Gate activates. Observe that it takes approximately 1 second for the LEDs from 10 to 30 to go on.
- C). Verify that all the LEDs in the Δ gain display are on.
- D). Perform steps 7A to 7C for channel 2. Set both Gate REL Rate switches out.

8. PEAKSTOP LED CHECK

- A). Feed the 166 inputs with 1KHZ +10dBm. Set both compressor thresholds to 20.
- B). Set both Compressor Ratios to 1 : 1. Adjust the channel 1 and channel 2 peakstops LEDs just go on. (both channels.)
- C). Check that the channel 1 and channel 2 point to the same place +- 2 pointer lines width. Both peakstop pots should be within 4 pointer lines width of the 10 mark on the 166 front panel.
- D). Set channel 1 and channel 2 peakstop pots fully clockwise.

9. GATE THRESHOLD CHECK

- A). Set the oscillator to 1KHz -30dBm.
- B). Adjust the Gate Threshold pot on the 166 until Gating is observed.
- C). The Gate Threshold pot should be within 1 pointer line width of the -30 mark on the 166 front panel.
- D). Perform step 9A to 9C for channel 2.
- E). Set both Gate Threshold pots fully counter-clockwise.

10. COMPRESSOR RATIO CHECK

- A). Set channel 1 and Channel 2 Comp. Threshold pots fully counter-clockwise.
- B). Set channel 1 and channel 2 Comp. Ratio pots to 4 : 1.
- C). Set Signal Generator to 1kHz 0dBm.
- D). Monitor and note the output of channel 1. Step the Signal Generator up 10 dB.
- E). Verify that the output changes 1.5 to 3.5 dB. (from noted reading).
- F). Perform step 10A to 10E for the channel 2.

Note : Use the 166 output gain pot to boost the 166 output onto your +- 15 dB meter before you step up to 10 dB. (This allows more accurate determination of the reading.)

11. STEREO COUPLE CHECK

- A). Press Stereo Couple switch in.
- B). Set Signal Generator to 1KHz 0dBm.
- C). Adjust channel 1 compressor controls and verify that channel 2 LED display responds to channel 1 controls.
- D). Set channel 1 Comp. Threshold fully clockwise. Set channel 1 Comp. Ratio fully counter-clockwise.
- E). Adjust channel 1 peakstop pot, observe that channel 1 and channel 2 peakstop LEDs light simultaneously.
- F). Adjust channel 1 Gate control until the channel 1 Gate goes on. Observe that the channel 2 Gate activates at the same time.

PREPARED BY : Patrick Li

APPROVED BY : ~~Patrick Li~~

REVIEWED BY : C. Raymond