

GENETX™ GUITAR PROCESSOR

GNX2

USER'S GUIDE





These symbols are internationally accepted symbols that warn of potential hazards with electrical products. The lightning flash means that there are dangerous voltages present within the unit. The exclamation point indicates that it is necessary for the user to refer to the owners manual.

These symbols warn that there are no user serviceable parts inside the unit. Do not open the unit. Do not attempt to service the unit yourself. Refer all servicing to qualified personnel. Opening the chassis for any reason will void the manufacturer's warranty. Do not get the unit wet. If liquid is spilled on the unit, shut it off immediately and take it to a dealer for service.

Disconnect the unit during storms to prevent damage.

U.K. Mains Plug Warning

A molded mains plug that has been cut off from the cord is unsafe. Discard the mains plug at a suitable facility. **Never under any circumstances should you insert a damaged or cut mains plug into a 13 amp power socket.** Do not use the mains plug without the fuse cover in place. Replacement fuse covers can be obtained from your local retailer. Replacement fuses are 13 amps and **MUST** be ASTA approved to BS1362.

Safety Instructions

Notice for customers if your unit is equipped with a power cord.

Warning: This appliance must be earthed.

The cores in the mains lead are colored in accordance with the following code:

Green and Yellow - Earth Blue - Neutral Brown - Live

As colors of the cores in the mains lead of this appliance may not correspond with the colored markings identifying the terminals in your plug, proceed as follows:

- The core which is colored green and yellow must be connected to the terminal in the plug marked with the letter E, or with the earth symbol, or colored green, or green and yellow.
- The core which is colored blue must be connected to the terminal marked N, or colored black.
- The core which is colored brown must be connected to the terminal marked L, or colored red.

This equipment may require the use of a different line cord, attachment plug, or both, depending on the available power source at installation. If the attachment plug needs to be changed, refer servicing to qualified service personnel who should refer to the table below. The green/yellow wire shall be connected directly to the unit's chassis.

CONDUCTOR		WIRE COLOR	
		Normal	Alt
L	LIVE	BROWN	BLACK
N	NEUTRAL	BLUE	WHITE
E	EARTH GND	GREEN/YEL	GREEN

Warning: If the ground plug is defeated, certain fault conditions in the unit or in the system to which it is connected can result in full line voltage between chassis and earth ground. Severe injury or death can then result if the chassis and earth ground are touched simultaneously.

Warning

For your protection, please read the following:

Water and Moisture: Appliances should not be used near water (e.g. near a bathtub, washbowl, kitchen sink, laundry tub, in a wet basement, or near a swimming pool, etc.) Care should be taken so that objects do not fall and liquids are not spilled into the enclosure through openings.

Power Sources: The appliance should be connected to a power supply only of the type described in the operating instructions or as marked on the appliance.

Grounding or Polarization: Precautions should be taken so that the grounding or polarization means of an appliance is not defeated.

Power Cord Protection: Power supply cords should be routed so that they are not likely to be walked on or pinched by items placed upon or against them, paying particular attention to cords at plugs, convenience receptacles, and the point where they exit from the appliance.

Servicing: To reduce the risk of fire or electrical shock, the user should not attempt to service the appliance beyond that described in the operating instructions. All other servicing should be referred to qualified service personnel.

For units equipped with externally accessible fuse receptacle: Replace fuse with same type and rating only.

Electromagnetic Compatibility

Operation is subject to the following conditions:

- This device may not cause harmful interference.
- This device must accept any interference received, including interference that may cause undesired operation.
- Use only shielded interconnecting cables.
- Operation of this unit within significant electromagnetic fields should be avoided.

DECLARATION OF CONFORMITY

Manufacturer's Name: DigiTech
Manufacturer's Address: 8760 S. Sandy Parkway
Sandy, Utah 84070, USA

declares that the product:

Product name: GNX2
Note: Product name may be suffixed by the letters EX, EU, JA, and UK.

Product option: all (requires Class II power adapter that conforms to the requirements of EN60065, EN60742, or equivalent.)

conforms to the following Product Specifications:

Safety:	IEC60065 (1998) EN 60065 (1993)
EMC:	EN 55013 (1990) EN 55020 (1991)

Supplementary Information:

The product herewith complies with the requirements of the Low Voltage Directive 72/23/EEC and the EMC Directive 89/336/EEC as amended by Directive 93/68/EEC.

DigiTech / Johnson
8760 S. Sandy Parkway
Sandy, Utah 84070, USA
Date: May 25, 2001

European Contact: Your local DigiTech / Johnson Sales and Service Office or

Harman Music Group
8760 South Sandy Parkway
Sandy, Utah
84070 USA
Ph: (801) 566-8800
Fax: (801) 568-7573

Warranty

We at **DigiTech** are very proud of our products and back-up each one we sell with the following *warranty*:

- 1. The warranty registration card must be mailed within ten days after purchase date to validate this warranty.*
- 2. DigiTech warrants this product, when used solely within the U.S., to be free from defects in materials and workmanship under normal use and service.*
- 3. DigiTech liability under this warranty is limited to repairing or replacing defective materials that show evidence of defect, provided the product is returned to DigiTech WITH RETURN AUTHORIZATION, where all parts and labor will be covered up to a period of one year. A Return Authorization number may be obtained from DigiTech by telephone. The company shall not be liable for any consequential damage as a result of the product's use in any circuit or assembly.*
- 4. Proof-of-purchase is considered to be the burden of the consumer.*
- 5. DigiTech reserves the right to make changes in design, or make additions to, or improvements upon this product without incurring any obligation to install the same on products previously manufactured.*
- 6. The consumer forfeits the benefits of this warranty if the product's main assembly is opened and tampered with by anyone other than a certified DigiTech technician or, if the product is used with AC voltages outside of the range suggested by the manufacturer.*
- 7. The foregoing is in lieu of all other warranties, expressed or implied, and DigiTech neither assumes nor authorizes any person to assume any obligation or liability in connection with the sale of this product. In no event shall DigiTech or its dealers be liable for special or consequential damages or from any delay in the performance of this warranty due to causes beyond their control.*

NOTE: The information contained in this manual is subject to change at any time without notification. Some information contained in this manual may also be inaccurate due to undocumented changes in the product or operating system since this version of the manual was completed. The information contained in this version of the owner's manual supersedes all previous versions.

Table of Contents

Introduction	1	Rotary Speaker	25
Quick Start	2	AutoYa™	25
Making Connections	2	YaYa™	26
Apply Power	2	SynthTalk™	26
Select an Output Mode	2	Envelope Filter	26
Select The Target System Setup	2	Detune	27
Select a Preset	2	Pitch Shift	27
A Guided Tour of the GNX2	3	Delay	27
The Front Panel	3	Reverb	28
The Rear Panel	6		
Getting Started	7	Tutorial	29
Making Connections	7	Select a Preset	29
Mono Operation	7	Create a HyperModel™	29
Stereo Operation	7	Select the Green Channel Amp and Cabinet	29
Direct to a Mixing Console	8	Select the Red Channel Amp and Cabinet	29
S/PDIF Digital Output	8	Adjust the Green Channel Parameters	30
Applying Power	8	Adjust the Red Channel Parameters	30
About the GNX2	9	Tune the Cabinets (optional)	31
The Presets	9	Warp the Green and Red Channels Together	31
Performance Mode	9	Save the HyperModel™	31
Preset Mode	9	Select Models for the Preset's Channels	32
FX Mode	9	Edit the Preset	32
The Footswitches	10	Select the Pickup Type	32
The Expression Pedal	10	Turn the Compressor Off	33
Bypass Mode	10	Turn the Whammy™/IPS Off	33
Tuner Mode	10	Turn the Stompbox Modeling Off	33
Jam-A-Long	10	Adjust the Noise Gate	34
Learn-A-Lick Mode	11	Turn the Talker™ Off	34
Rhythm Trainer	11	Select and Adjust the Chorus	34
		Turn the Delay Off	35
		Select and Adjust the Reverb	35
		Store the Preset	35
Editing Functions	13	Other Functions	37
Editing/Creating a Preset	13	Expression Pedal	37
Amp/Cabinet Modeling	13	LFOs	37
Amp Models	13	Amp Footswitch	38
Cabinet Types	13	Expression Parameter Assignment List	38
Editing Amp Models and Cabinet Types	13	Utilities	39
Selecting Amp/Cabinet Models	14	Mono/Stereo Output	40
Adjusting Amp Parameters	14	Target System Setup	40
Cabinet Tuning	14	Volume Pedal Update	40
Creating HyperModels™	15	V-Switch Threshold	40
Saving HyperModels™ (Amp Save)	15	Expression Pedal Calibration	41
Editing the Effects	15	Bank Names	41
Storing/Copying a Preset	16	MIDI Channel	42
		Bulk Dump	42
		MIDI Preset Dump	42
		User Amp Dump	43
		MIDI Mapping	43
		MIDI Merge	43
		Digital Level	44
		Factory Reset	44
		GenEdit™ Editor/Librarian	45
		PC	45
		Mac	45
Effects and Parameters	18	Appendix	46
Effect Definitions	18	Preset List	46
Wah-Pickup	18	MIDI CC List	47
Compressor	18	MIDI Implementation	48
Whammy/IPS	19	Specifications	48
Intelligent Pitch Shifting (IPS)	19		
Detuning	20		
Pitch Shifter	20		
Stomp Box Modeling	20		
EQ	21		
Noise Gate	21		
Talker™	22		
Chorus/Mod Effects	22		
Chorus	22		
Flange	23		
Phaser	23		
Triggered Flanger	24		
Triggered Phaser	24		
Tremolo	24		
Panner	25		
Vibrato	25		

Introduction

The DigiTech GNX2, is the most advanced guitar processor of its kind. Thanks to the highly advanced technology provided by GeNetX™, and the extreme horsepower contained in the Audio DNA™ DSP engine, you now have the tools to literally create your own guitar amplifier and speaker cabinet models. All of this power lets you create a sound that is your own. In addition to designing models, the GNX2 has a library full of studio quality effects.

The intuitive user interface makes programming as simple as turning a knob. However, your time would be well spent by reading through this User's Guide with your GNX2 in front of you.

Included Items

Before you tear open the packaging and toss the manual over your shoulder, please check to make sure the following items have been included:

- **GNX2**
- **PSS3 Power Supply**
- **Warranty Card**
- **User's Guide**
- **GenEdit™ Editor/Librarian CD**

The utmost care was taken in the manufacturing and packaging your GNX2. Everything should be included and in perfect working condition. However, if you find anything missing, please contact the factory at once. Please take a moment to fill out the warranty card. It is your safeguard in the unlikely event that the GNX2 develops a problem.

Introduction

Quick Start

The Quick Start section is included for those of you who would rather play now and read later.

Making Connections

Connect your instrument to the **INPUT** jack on the rear panel. Connect the **LEFT/RIGHT OUTPUTS** to the input(s) of your amplifier(s), power amp, or mixer.

Apply Power

Turn the **OUTPUT** knob on the rear panel of the GNX2 all the way down (fully counter clockwise). Connect the plug of the PSS3 power supply to the **POWER** jack on the GNX2. Connect the other end of the PSS3 power supply to an AC outlet and turn the GNX2 **POWER** switch on. Turn your amplifier(s) on, and adjust the volume(s) to a normal playing level. Gradually increase the GNX2's **OUTPUT** volume.

Select an Output Mode

Press the **UTILITY** button and use the **DATA WHEEL** to select either the Stereo or Mono output mode.

Select The Target System Setup

The GNX2 needs to know the type of amplification system it will be used with. After selecting an Output, press the **RHYTHM** button. The Target System Setup menu is displayed. Use the **DATA WHEEL** to select an amplification system, and press **EXIT** to return to Performance mode.

Select a Preset

The GNX2 comes with 64 pre-programmed Factory Presets, and 64 User Presets. From the factory, the User Presets are exact duplicates of the Factory Presets. This lets you experiment without losing any of the original presets.

Use the **BANK** footswitches to select a Bank, and **Footswitches 1-4** to select a preset. The **DATA WHEEL** can also be used to select a preset. After you find a preset you like, you can edit it. See Editing and Creating a Preset page 13.

A Guided Tour of the GNX2 The Front Panel

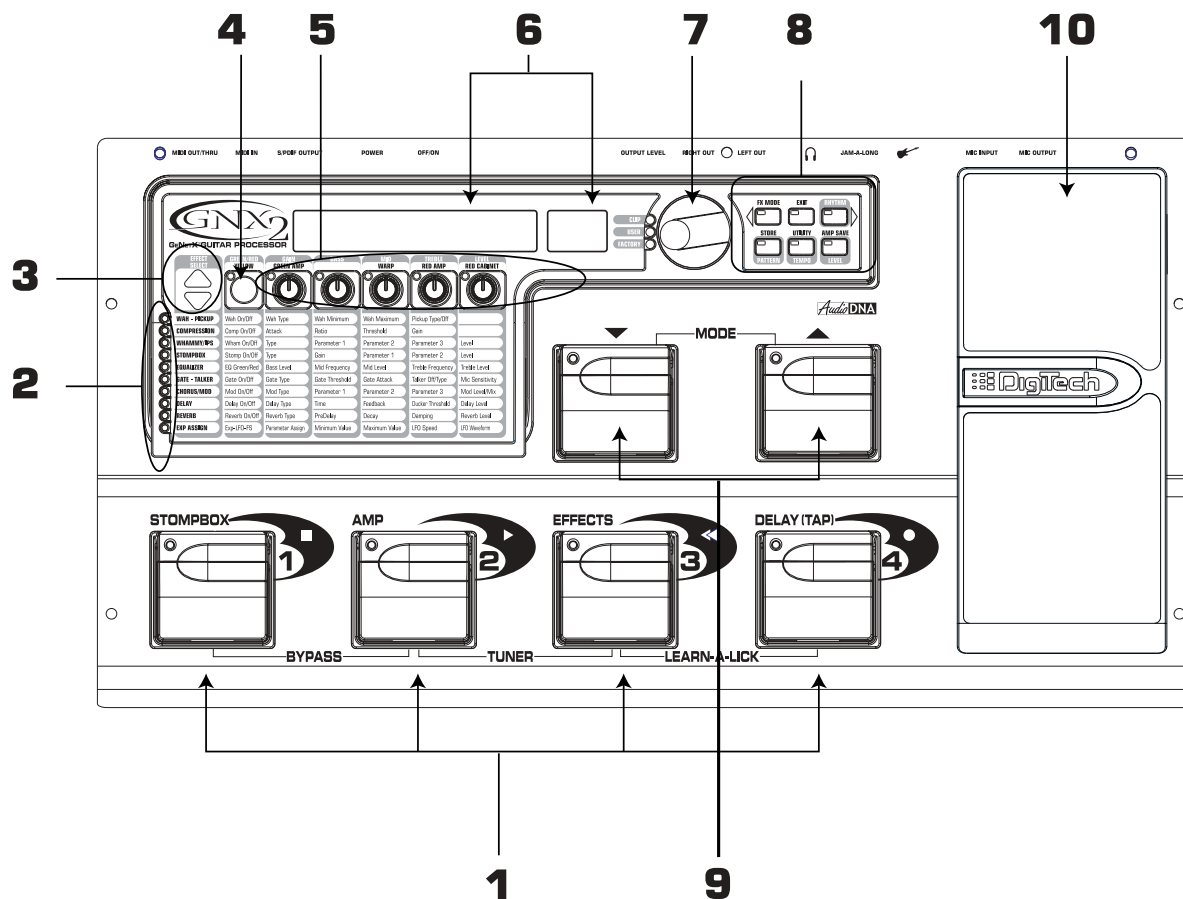

1. Footswitches 1- 4

Depending on the selected mode, these 4 footswitches select presets, change amp channels, and turn individual effects on and off. Bypass, accesses the Tuner, or controls Learn-A-Lick functions.

2. Matrix

The Matrix LEDs light identifying the active effects for the selected preset in performance mode, or the selected row of effects in edit mode.

3. Effect Select Buttons

The Effect Select buttons are used together with the Matrix LEDs to choose the effects you want to edit.

4. Status Button

In performance mode, the Status button selects the Green or Red Amp Channel. It also activates the amp and cabinet Warping feature (indicated by a yellow LED next to the Status button). In Edit mode it turns the selected effect on and off, or selects a controller type for the expression assignment.

5. Parameter Knobs

In performance mode, these 5 knobs select Amp Models, Speaker Cabinets, and Warp Models. In Green or Red mode, they adjust the Amp Gain, EQ and Level of the selected amp channel. In Edit mode, they adjust the parameters listed in the column directly below each knob for the selected group of effects.

Introduction

6. Display

The display consists of eight green alpha-numeric characters, and two red numeric digits. The display provides information for several different functions depending on the selected mode. In Performance mode, the display shows the selected preset name and number. The display also shows bank names when changing banks, and momentarily flashes the active amp channel when the amp channel is changed. In Edit mode, the alpha-numeric display shows the selected effect's parameter and value or status. In Tuner mode, the numeric display shows the note played and the alpha-numeric display indicates whether the note was sharp or flat. In Learn-A-Lick mode, the alpha-numeric display shows the selected function and the numeric display provides an elapsed time for record and playback.

7. Data Wheel

The Data Wheel increases and decreases the selected preset in performance mode. It increases and decreases the value or status of the selected Utility or Rhythm function, and scrolls characters in the naming procedure.

8. Mode Buttons

These 6 buttons select GNX2 modes of operation. The Exit button is only used to exit a function, while the other 5 buttons perform dual functions dependent on the selected mode of operation. The buttons are labeled as follows:

FX MODE - The FX Mode button assigns footswitches 1-4 to presets within a selected Bank, or toggles individual effects in a selected preset on and off. The FX Mode button is lit when footswitches 1-4 toggle effects on and off. This button also selects the previous character when naming a preset, and the previous menu in Utility mode. The Mode Down/Up footswitches functionality changes depending on the status of the FX Mode button. (see Mode Footswitches section below).

EXIT - Exits all functions and returns to Performance mode.

RHYTHM - The Rhythm button accesses the Rhythm Trainer feature in the GNX2. When the Rhythm Trainer is selected, the LED lights and the drum loop begins playing. The bottom row of Mode buttons can also be used in conjunction with the Data Wheel to select and edit the Pattern, Tempo, and Level. This button also selects the next character when naming a preset, and the next menu in Utility mode.

STORE - The Store button is used to save your custom edits to the User presets. The function of this button changes to select Pattern in Rhythm mode.

UTILITY - The Utility button accesses global functions including Output Mode, Target System Setup, and MIDI setup.

AMP SAVE - This button stores Amp and Cabinet changes (tone, gain, level, amp type, cabinet type, warp, or cabinet tuning) as HyperModels™. This button also selects the level in Rhythm mode.

9. Mode Footswitches

These footswitches select User Preset Banks, presets, and playback speed (Learn-A-Lick), depending on the current mode. Press the Up and Down footswitches at the same time to toggle in and out of FX Mode. In FX Mode, these footswitches scroll through the presets. When FX Mode is disabled,

these footswitches move through the User Preset Banks. In Learn-A-Lick™ Mode, these footswitches select the playback speed of the sampled phrase.

10. Expression Pedal

The Expression Pedal controls effect parameters in real time. Most GNX2 parameters can be assigned to the Expression Pedal. Applying extra pressure to the toe of the Expression Pedal switches between controlling the assigned parameter(s) and controlling the Wah.

Introduction

The Rear Panel

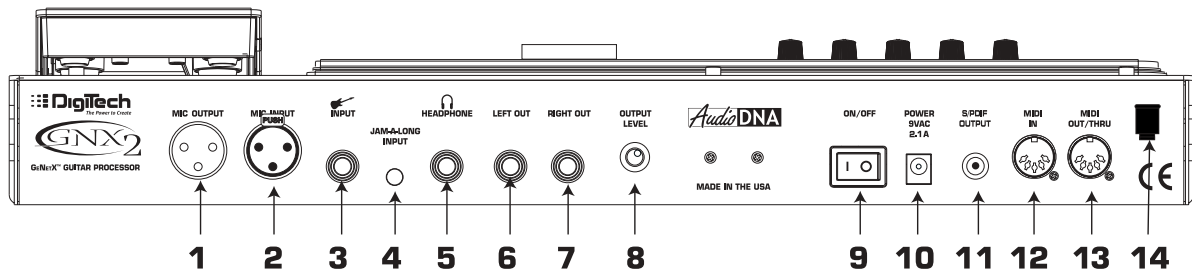

1. Mic Output

This XLR jack passes your mic signal to the house mixing console.

2. Mic Input

This XLR jack connects a low impedance mic to the GNX2 that can be used with the Talker and Vocoder effects. A mic with a cardioid pattern is recommended.

3. Input Jack

Connect your instrument to this jack.

4. Jam-A-Long Jack

Use a 1/8" stereo plug to connect this jack to the output of a tape or CD player. This lets you play along with the music, or record a musical passage.

5. Headphone Output

Connect stereo headphones to this jack. Be sure to set the Target System Setup mode to Direct when listening through Headphones (see page 40 for more information on selecting the Target System Setup). Do not connect a mono plug to this jack, because you may damage the output driver.

6. Left Output

Connect to the input of an amplifier, input of a power amp, or line input of a mixing console.

7. Right Output

Use this jack in conjunction with the Left Output for stereo applications. Connect to the input of a second amplifier, or the right input of a stereo power amp.

8. Output Level

Controls the overall volume level of the GNX2.

9. Power Switch

Turns the power on and off.

10. Power Input

Connect only the provided DigiTech PSS3 power supply to this jack.

11. S/PDIF Output

This is the GNX2's digital output . The signal at this output is in a stereo digital format, and is to be connected to a digital S/PDIF input such as those found on digital recording devices.

NOTE: Do not connect the S/PDIF output to analog auxiliary, CD, phono, or tape inputs on consumer electronic devices. It is not compatible with these inputs.

12. MIDI In

This jack receives all incoming MIDI data. Connect this jack to the MIDI out of a computer, sequencer, MIDI controller, or MIDI storage device.

13. MIDI Out/Thru

This jack sends MIDI data from the GNX2. Connect this jack to the MIDI in of a computer, or external MIDI recording device. When enabled, MIDI Thru sends the same information the GNX2 received at the MIDI In.

14. Strain Relief

This secures the power cord and to help prevent it from disconnecting during a performance.

Getting Started

Making Connections

The GNX2 has several different connection options. You can run mono into an amp or power amp, stereo into two amps or a stereo power amp, direct into a mixing console, or any combination of these. Before connecting the GNX2, make sure both the GNX2 and the amplifier are OFF. The following diagrams show some examples.

NOTE: The type of amplification system the GNX2 will be used with should be selected at the Target System Setup of the Utility menu. See page 40 for more information about selecting the Target System Setup.

Mono Operation

1. Connect your guitar to the input of the GNX2.
2. Connect the GNX2's left output to the instrument input on your amplifier, or to the line input of a power amp.
3. Select Mono as the Output mode from the Utility menu. See page 40 for more on selecting the Output mode.

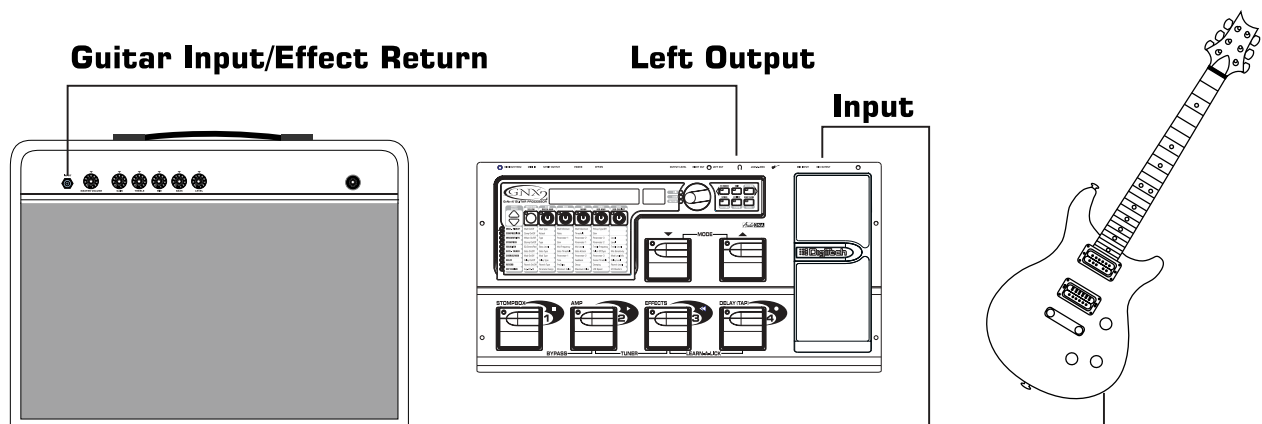

Stereo Operation

1. Connect the guitar to the input of the GNX2.
2. Connect the GNX2's Left output to the input of one amplifier or channel of a power amp.
3. Connect the GNX2's right output to a second amplifier, or to a second channel of a power amp.
4. Select Stereo as the Output mode from the Utility menu. See page 40 for more on selecting the Output mode.

Introduction

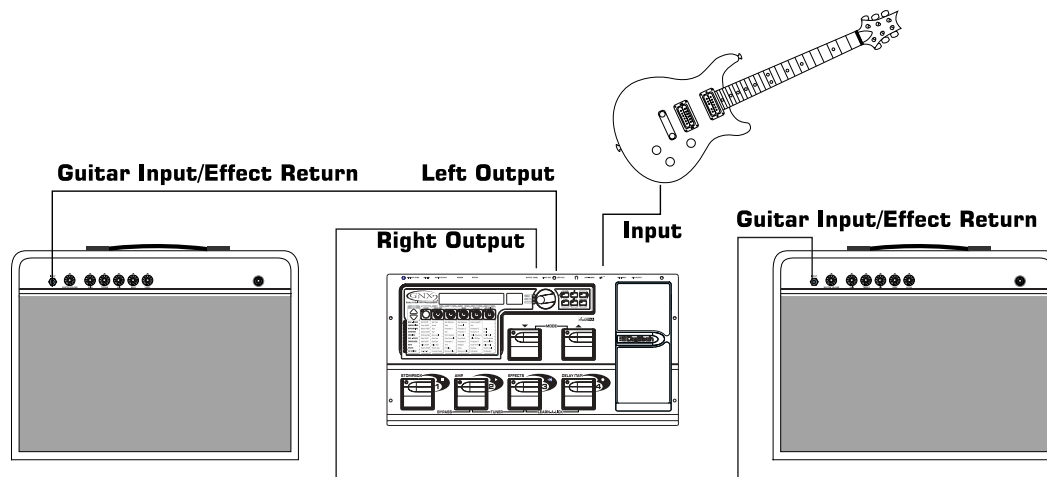

Direct to a Mixing Console

The GNX2 can be connected directly to the inputs of a house PA system, or a recording console.

1. Connect the guitar to the GNX2's input.
2. Connect the GNX2's outputs to the channel inputs of the mixing console.
3. If the GNX2 is to be used in Stereo mode, set the pan controls of the mixer hard left and right, and select Stereo as the output mode from the Utility menu. See page 40 for more information on the Output mode.

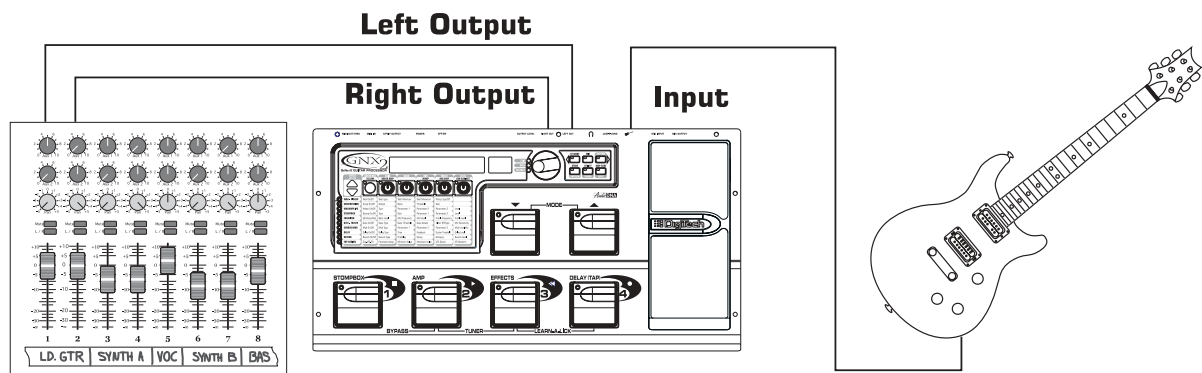

S/PDIF Digital Output

The GNX2 includes a digital S/PDIF output that connects directly to the latest digital recording devices and sound cards. Connect the GNX2's S/PDIF output to the S/PDIF input on your digital mixer or recorder. You must have S/PDIF inputs on the receiving device in order to use this output. Be sure to use a 75 ohm or RCA video cable to connect from the Digital Output to a recording device. You can use the analog and digital outputs of the GNX2 simultaneously.

NOTE: Do not connect the S/PDIF output to analog auxiliary, CD, phono, or tape inputs on consumer electronic devices. It is not compatible with these inputs.

Applying Power

Once the audio connections are made, turn the GNX2's Output Level on the rear panel all the way down (counterclockwise). Connect the PSS3 to the power jack on the back of the GNX2 and the other end to an AC outlet. Turn the power switch On. Turn the power to your amplifier(s) on. Set the amp(s) to a clean tone and set the tone controls to a flat EQ response (on most amps, this would be 0 or 5 on the tone controls). Turn the Output Level of the GNX2 up to increase the volume.

About the GNX2

The Presets

A preset is a named and numbered location of a programmed sound that resides in the GNX2. Presets can be recalled with the **FOOTSWITCHES** or the **DATA WHEEL**. The GNX2 comes with 64 Factory and 64 User presets. The Factory Presets do not let you store changes to them. The User presets let you store changes. From the factory, the 64 User presets are exact duplicates of the 64 Factory presets. This lets you make your own presets without worrying about losing any of the original presets. When you select a preset, the name of the preset appears in the green alpha-numeric display and the number of the preset appears in the red numeric display. The User LED to the right of the numeric display lights indicating the User preset is active. The Factory LED lights indicating a Factory preset is active.

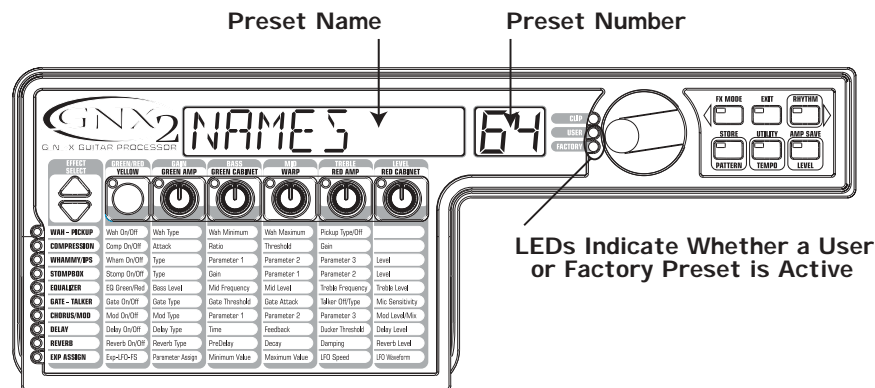

Performance Mode

When you first apply power to the GNX2, it powers up in Performance mode. This is the mode used while you are performing. While in Performance mode, the display shows the selected preset's name and number. The vertical LEDs on the Matrix indicate which effects are active for the selected preset. From Performance mode, you have access to all of the GNX2's presets.

Preset Mode

Preset Mode is the factory default operation mode when the GNX2 is first powered up. In Preset mode, Footswitches 1-4 select presets in the current bank. The Mode footswitches are used to select the 16 User Banks. Successive presses of the **MODE** footswitches advances through all User/Factory Banks. Pressing and holding a **MODE** footswitches scrolls through the User Banks. Once a Bank has been selected, a preset within that bank needs to be selected. If a preset is not selected within 5 seconds, the GNX2 returns to the previous bank and preset.

FX Mode

FX Mode is another mode of operation that can be used during a performance. The **FX MODE** button (located to the right of the Data Wheel) is used to switch between Preset and FX Modes. When FX Mode is active, the **FX MODE** button lights. In **FX MODE**, the 1-4 Footswitches turn on and off the effects. Footswitch 1 switches between the Green, Red, and Yellow amp channels. Footswitch 2 turns the Chorus/Mod Effects module on and off. Footswitch 3 turns the Delay on and off. Footswitch 4 turns the Reverb on and off. The Mode footswitches are used to navigate through all of the GNX2's presets.

As an added feature, the Delay footswitch can be used as a tap-tempo switch for setting the delay time during live performance. While the delay is on, press and hold the Delay footswitch while in FX Mode to turn it into a tap-tempo delay switch. Press and hold it again to change it back to a Delay on and off

Introduction

The Footswitches

The GNX2 1-4 footswitches are primarily used to select presets or turn on and off effects, depending on which mode is selected. However, these footswitches are also used to access other GNX2 functions. For example, pressing Footswitches 1 and 2 simultaneously, or pressing the lit Footswitch (in Preset mode) bypasses the the current preset. Pressing Footswitches 2 and 3 simultaneously accesses the Tuner mode. Pressing Footswitches 3 and 4 simultaneously activates the Learn-A-Lick mode. In Learn-A-Lick mode, Footswitches 1-4 control various Learn-A-Lick functions.

The Expression Pedal

As you go through the different presets in the GNX2, you will find that the expression pedal has different functions. The Expression Pedal can control three different parameters in each Preset. Rock the Expression Pedal back and forth to change the values of the assigned parameters. The pedal can control assigned minimum and maximum values (stop points) for each parameter. The Expression Pedal also includes a feature called V-Switch that allows you to override the Parameters assigned to the Expression Pedal and replace them with the Wah effect. See page 37 for more information on assigning the Expression Pedal.

Bypass Mode

The GNX2 presets can be bypassed for a clean, unprocessed guitar tone. Bypass mode turns off all effects and modeling. To bypass the GNX2 in Preset mode, press the active preset's Footswitch (the 1-4 footswitch that is lit), or press Footswitches 1 and 2 simultaneously. To bypass the GNX2 while in FX Mode, press Footswitches 1 and 2 simultaneously. When the GNX2 is bypassed, the display reads *BYPASS* and all LEDs in the matrix are off. Press any Footswitch to exit Bypass and return to the last preset. The Matrix and Programming buttons are not available in Bypass mode.

Tuner Mode

The Tuner in the GNX2 lets you quickly tune or check the tuning on your guitar. Press Footswitches 2 and 3 simultaneously to enter Tuner mode. The display briefly flashes *TUNER*. To begin tuning, play a note on your guitar (a harmonic at the 12th fret usually works best). The red numeric display shows the note being played, and the green alpha-numeric display indicates whether the note is sharp or flat. Arrows to the left (< < <) indicate the note is sharp and should be tuned down. Arrows to the right (> > >) indicate the note is flat and should be tuned up. When your note is in tune, *-> <-* is displayed.

In Tuner mode, you can set your tuning reference with the Data Wheel. The default factory setting is A=440 Hz. The tuning references range from 427 Hz to 453 Hz (± 50 cents (1/2 semitone) from either direction of 440 Hz). Below 427 Hz, are alternate dropped tunings. The alternate tunings are *REF Ab* (A=Ab), *REF G* (A=G), and *REF Gb* (A=Gb). The display window briefly flashes the selected tuning preference.

Exit tuner mode by pressing any of the Footswitches.

Jam-A-Long

The Jam-A-Long feature lets you connect a Tape, CD, or MP3 player to the GNX2. The tape, CD, or MP3 player's signal is output through the GNX2's left, right, and headphone outputs. To use the Jam-A-Long feature, connect the headphone output of your player to the **JAM-A-LONG INPUT** on the rear panel of the GNX2. Use a 1/8" stereo cable, and press play on your Tape, CD, or MP3 player.

Learn-A-Lick Mode

The Learn-A-Lick function allows you to record a 9 second passage of music and play it back as slowly as 1/4 the original speed with no change in pitch. This is very useful for picking out the notes of a fast guitar solo.

There are 6 Learn-A-Lick functions. They are:

- **Stop** (Controlled by Footswitch 1)
- **Play** (Controlled by Footswitch 2)
- **Rewind** (Controlled by Footswitch 3)
- **Record** (Controlled by Footswitch 4)
- **Tempo Down** (Controlled by rotating the Data Wheel counter-clockwise)
- **Tempo Up** (Controlled by rotating the Data Wheel clockwise)

Using Learn-A-Lick

1. Connect the player's headphone output to the Jam-A-Long input jack on the rear panel using a 1/8" stereo plug. Set the volume level of the player.
2. Find the passage you want to record and pause the Tape, CD, or MP3 player.
3. Press and hold the number 2 and 3 Footswitches to enter Learn-A-Lick mode. The display reads:
LRN LICK
4. Release the pause button on your playback device and press the number 4 Footswitch. The display reads: *RECORD*. The red numeric display provides a time elapsed reference while recording is in process. When recording is complete, the recorded passage is set in an auto-loop playback mode indicated by *PLAY* appearing in the display.
5. Press Stop or Pause on the playback device.
6. Rotate the **DATA WHEEL** counterclockwise to slow the playback down, or clockwise to increase the playback speed at 1/8 speed intervals. Your interval choices include: *FULL*, *7/8*, *3/4*, *5/8*, *1/2*, *3/8*, *AND* *1/4* speeds.
7. Press Footswitch 3 to step back through the loop at 1 second intervals.
8. The **EXPRESSION PEDAL** controls the output level of the recorded phrase.
9. To stop the playback, press Footswitch 1.
10. To resume playback, press Footswitch 2.
11. To record a new passage, press Footswitch 4.
12. To exit the Learn-A-Lick mode, press and hold Footswitches 3 and 4, or press **EXIT**.

Rhythm Trainer

The Rhythm Trainer in the GNX2 is a tool that can be used to develop a great sense of timing, rehearse different musical styles, or just to jam with. The Rhythm Trainer plays sampled drum patterns in an infinite loop. You can select from a variety of patterns, change the tempo, and adjust the playback level while using the Rhythm Trainer. When the Rhythm Trainer is enabled, the drum patterns are mixed with your guitar signal at the GNX2's left, right, and headphone outputs.

To activate the Rhythm Trainer, follow these steps:

1. Press the **RHYTHM** button. The Rhythm button's LED lights and the current drum pattern will begin playing. If Rhythm mode is enabled from Performance mode, the Store, Utility, and Amp Save LEDs light.
2. Press the Store, Utility, or Amp Save buttons to adjust the Pattern, Tempo, or Level using the **DATA WHEEL**.

Introduction

Pattern

Press the **STORE** (Pattern) button to adjust the drum pattern. The selected drum pattern is shown in the display. Use the **DATA WHEEL** to select a new pattern. There are 30 different Patterns and a metronome available including:

ROCK 1	POP 2	DANCE 2	SWING 1
ROCK 2	POP 3	DANCE 3	SWING 2
ROCK 3	FUNK 1	DANCE 4	REGGAE
ROCK 4	FUNK 2	URBAN 1	CHACHA
HRDROCK1	FUNK 3	URBAN 2	BOSSA 1
HRDROCK2	BLUES	COUNTRY1	BOSSA 2
HRDROCK3	JAZZ	COUNTRY2	METRONOM
POP 1	DANCE 1	COUNTRY3	

Tempo

Press the **UTILITY** (Tempo) button to adjust the tempo. The display shows the current tempo in beats per minute (BPM). Use the **DATA WHEEL** to select a new tempo. Tempo ranges from 40 beats per minute (40BPM) to 240 beats per minute (240BPM).

Level

Press the **AMP SAVE** (Level) button to adjust the level. The display reads **DRUM LVL** (drum level). Use the **DATA WHEEL** to select the playback volume of the drum loop. Level ranges from 1 to 99.

3. Press the **RHYTHM** button again to turn the Rhythm Trainer off.

Editing Functions

Editing/Creating a Preset

The GNX2 was designed to make the process of sound creation easy and intuitive. Because the GNX2 provides both Amp Modeling and Effects Processing, the editing functions have been divided into two sections: the Amp/Cabinet Modeling section and the Effects section. The GeNetX™ technology contained in the GNX2 allows you to go much further than mere Amp Modeling. GeNetX™ lets you create your own Amp/Cabinet HyperModel™ and store this custom creation to a User Amp/Cabinet location. When editing either the Amp/Cabinet Modeling, or the Effects section, you must start with one of the User or Factory Presets. It is not possible to start with a completely empty preset. The preset you begin with does not need to be in the location that you intend to save it. To begin creating a HyperModel™ or just edit the effects, you must select a preset as your starting point.

Amp/Cabinet Modeling

Once you have selected a preset, you can select the Amp Models or Cabinet Types for your preset. Amp/Cabinet Modeling is a technology that applies the tone of one of several vintage or modern Amp Models and Cabinet Types to your guitar signal. The GNX2 includes accurate emulations of 15 popular Amp Models, 1 Acoustic Guitar Simulation, and 12 Speaker Cabinet Types. Your choices include:

Amp Models

<i>DIRECT</i> 1	- Turns the amp modeling off	<i>CRUNCH</i> 10	- A nice crunchy tube amp combo
<i>BLACKFACE</i> 2	- Based on a '65 Fender Twin Reverb	<i>HI GAIN</i> 11	- A high gain tube amp
<i>BOUTIQUE</i> 3	- Based on a Matchless DC30	<i>BLUES</i> 12	- A sweet blues tone
<i>RECTIFIED</i> 4	- Based on a Mesa Dual Rectifier	<i>MORNGAIN</i> 13	- Based on a Marshall JCM900
<i>HOTROD</i> 5	- Based on a Mesa Boogie Mark II C	<i>FUZZ</i> 14	- A vintage fuzz distortion
<i>TWEED</i> 6	- Based on a '57 Fender Tweed Deluxe	<i>BASS MAN</i> 15	- Based on a Fender Bassman
<i>BRITCOMBO</i> 7	- Based on a Vox AC30 top boost	<i>HIWATTAG</i> 16	- Based on a HiWatt 50 watt stack
<i>CLEANTUB</i> 8	- A clean tube combo setting	<i>ACOUSTIC</i> 17	- A flat top acoustic guitar
<i>BRITSTCK</i> 9	- Based on a '78 Marshall Master Volume	<i>EMPTY</i> U1 to U9	- User HyperModel™ Locations

Marshall® is a registered trademark of Marshall Amplification Plc. Vox® is a registered trademark of Korg UK. Fender, Matchless, HiWatt, and Mesa Boogie, are trademarks of their respective companies and are in no way associated with DigiTech.

Cabinet Types

<i>DIRECT</i> 1	- Turns the cabinet modeling off	<i>FANE4X12</i> 8	- Fane 4x12
<i>AMER2X12</i> 2	- American 2x12	<i>GRNB4X12</i> 9	- Greenback 4x12
<i>BRIT4X12</i> 3	- British 4x12	<i>BOTQ4X12</i> 10	- Boutique 4x12
<i>VNTG4X12</i> 4	- Vintage 30 4x12	<i>AMER4X10</i> 11	- Bassman 4x10
<i>BRIT2X12</i> 5	- British 2x12	<i>65 1X12</i> 12	- '65 Tweed 1x12
<i>AMER1X12</i> 6	- American 1x12	<i>JAZZ1X15</i> 13	- Pro 1x15
<i>BLND2X12</i> 7	- Blonde 2x12	<i>EMPTY</i> U1 to U9	- User Locations

Editing Amp Models and Cabinet Types

Each GNX2 preset has a Green, Red, and Yellow (Warped) Amp Channel. The Green and Red Amp Channels include individually selectable Amp Models, Cabinet Types, Gain, EQ, and Level settings. The Speaker Cabinet can also be tuned meaning that you can select the Cabinet's resonant frequency. Once the Models have been selected for the Green and Red channels, the channels can be toggled instantly using the **Amp Channel Footswitch** (only when FX Mode is active). Then the characteristics of the two Models selected for the Green and Red channels can be Warped together resulting in a completely new HyperModel™.

Editing Functions

Selecting Amp/Cabinet Models

The first step to editing an Amp Model, Cabinet Type, or creating your own HyperModel™ is to select the Amp and Cabinet types for the Green and Red Amp channels in your preset. To do this, the GNX2 must be in the Performance mode, indicated by the Status button's LED lighting yellow. **EXIT** returns you to Performance mode regardless of the selected mode. The procedure for selecting an Amp Model or Cabinet Type for the Green or Red Amp Channels is as follows:

1. Use the Parameter 1 knob (far left) to select the Green Amp Model. The Amp Model name appears in the alpha-numeric display. See the Amp/Cabinet Modeling section on page 13 for a complete list of Amp Models.
2. Use the Parameter 2 knob (second from the left) to select the Green Cabinet Type. See the Amp/Cabinet Modeling section on page 13 for a complete list of Cabinet Types.
3. Use the Parameter 4 knob (second from the right) to select the Red Amp Model.
4. Use the Parameter 5 knob (far right) to select the Red Cabinet type.

Adjusting Amp Parameters

The Gain, EQ, and Level Parameters can be adjusted individually for the Green and Red Amp Channels. The Gain ranges from 0 (0) to 99 (99). The Bass, Mid, and Treble EQ range from -12 (-12 dB) to 12 (+12 dB). The Level ranges from 0 (0) to 99 (99). The procedure for adjusting the Amp Parameters is as follows:

1. Press the **STATUS** button until all horizontal LEDs across the columns light green. This indicates that you have accessed the Amp Parameters for the Green Channel.
2. Use the Parameter 1 knob to adjust the Gain (distortion drive) for the Green Amp Channel.
3. Use the Parameter 2 knob to adjust the Bass (low frequency) enhancement for the Green Amp Channel.
4. Use the Parameter 3 knob to adjust the Mid range frequency enhancement for the Green Amp Channel.
5. Rotate the Parameter 4 knob to adjust the Treble (high frequency) enhancement for the Green Amp Channel.
6. Rotate the Parameter 5 knob to adjust the Level (volume) for the Green Amp Channel.
7. Press the **STATUS** button again until all horizontal LEDs across the columns turn red indicating the Amp Parameters for the Red Channel have been accessed. Then repeat steps 2 through 6 for adjusting the Red Amp Channel.

Cabinet Tuning

The resonant frequency of the selected speaker cabinets can be tuned individually. Cabinet Tuning ranges from -120 (one octave below) to 120 (one octave above). The procedure for tuning the cabinets is as follows:

1. Press and hold the **STATUS** button. Release the Status button after about 2 seconds when the display reads Cabinet Tuning (CAB TUNE) and only the LEDs next to the Parameter 2 and 5 knobs are lit.
2. Rotate the Parameter 2 knob to adjust the tuning of the Green Cabinet type (GT).
3. Rotate the Parameter 5 knob to adjust the tuning of the Red Cabinet type (RT).
4. Once the tuning has been selected for both Green and Red Cabinets, press **EXIT**.

Creating HyperModels™

Creating new, unique HyperModels™ is what GeNetX™ is all about. Once the Green and Red Amp Models and Cabinet types are selected, and the Amp Parameters and Cabinet Tuning have been adjusted, GeNetX™ technology lets you do something amazing. The characteristics of each Amp and Cabinet assigned to the Green and Red Channels can actually be combined or “Warped” to create a completely new Amp HyperModel™. The procedure for Warping the Green and Red Amps together is as follows:

1. Press the Status button until its LED lights yellow.
2. Rotate the Parameter 3 knob to Warp the Green and Red Amps and Cabinets together. Rotating counterclockwise adds more of the Green Channel characteristics, and clockwise adds more of the Red Channel characteristics.

Saving HyperModels™ (Amp Save)

When you have finished editing the Green and Red Channels, you must save the HyperModel™ for future use. This HyperModel™ can be saved in one of 9 User HyperModel™ locations. After it has been saved, it can be used in either the Green or Red Amp Channel. The Amp Save procedure is as follows:

1. Press the **AMP SAVE** button. The Amp Save button begins flashing and the display reads *NEWAMP*. The *N* of *NEWAMP* is flashing indicating that you can name your HyperModel™.
2. Use the **DATA WHEEL** to select the alpha-numeric character.
3. Use the **RHYTHM** button to move to the next character (to the right), or the **FX MODE** button to select the previous character (to the left).
4. Repeat steps 2 and 3 until the HyperModel™ name appears in the display.
5. Press the **AMP SAVE** button again to select one of the 9 User HyperModel™ locations. If the GNX2 has any unused HyperModel™ locations available, the display reads *EMPTY U1*. The *U1* flashes indicating that this is the first available location for HyperModel to be stored. If all 9 HyperModel™ locations are full, the GNX2 defaults to the first HyperModel™ location and displays the name of HyperModel™ stored in the number 1 location.
6. Use the **DATA WHEEL** to select a User location to save the HyperModel. If all locations have been used, the display shows the name of the HyperModel™ about to be overwritten.
7. Press the **AMP SAVE** button again to complete the Amp Save procedure.

Press Exit at any time during the Amp Save procedure to abort the process.

Note: The Amp Save procedure only saves Amp/Cabinet combinations to the User HyperModel™ locations. It does not store changes or the new HyperModel™ to the selected preset. See page 16 for information on storing changes to a Preset

Editing the Effects

The GNX2 contains a comprehensive library of fully programmable, studio quality Effects. The Effects section is accessed with the Effect Select Up/Down buttons. The Matrix LEDs light one at a time to identify the selected row of effects. When you have selected the effect row, you have up to 5 Parameters that can be edited. Each effect row is divided into 6 columns of Parameters. The first column is the on/off control. Pressing the Status button at the top of the first column turns the effect group on and off. The knobs at the top of the other 5 columns control the Parameters listed directly beneath the corresponding knob. Each effect's parameter is labeled in the Matrix. When a knob is turned, the corresponding parameter name appears in the green alpha-numeric display and the parameter value displays in the red numeric display.

Editing Functions

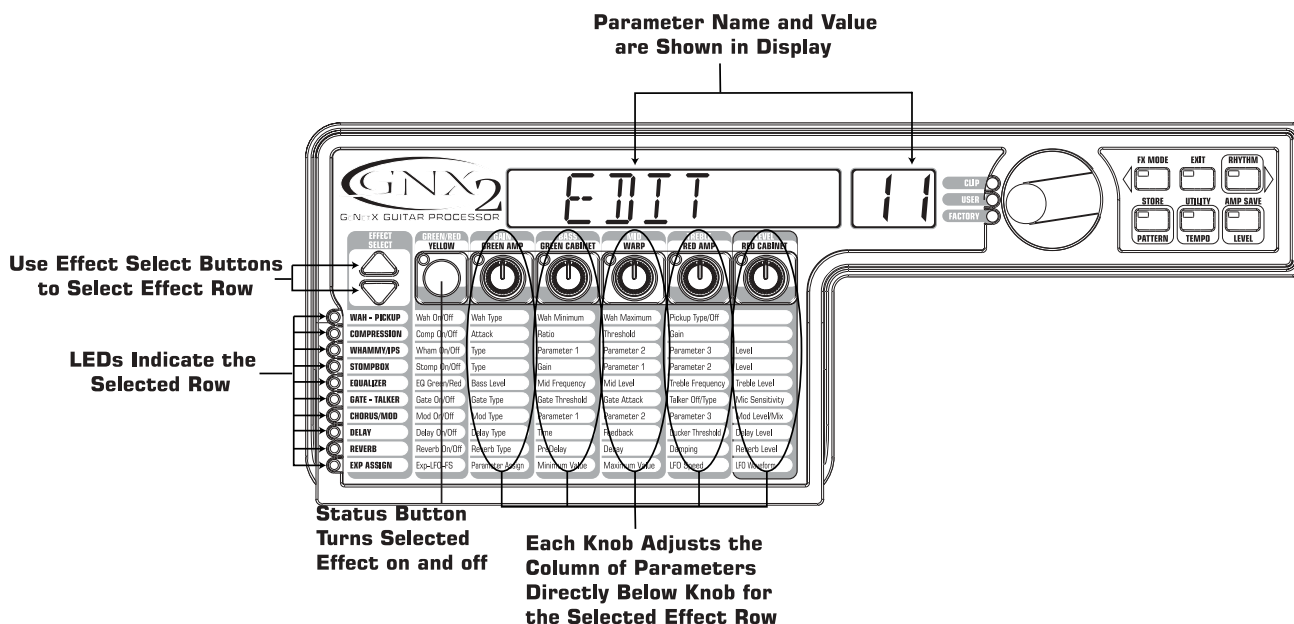

Rotating the parameter knobs increases or decreases the value of the parameter and you hear the change in real time. When parameter values have changed, the Store LED lights indicating the preset has been modified and needs to be stored (see page 16 for more on the store procedure). Changing presets, or turning the power off before storing any changes will erase your changes and revert to the stored values. When the preset has been edited, you may store your settings to any of the 64 User Preset locations.

Storing/Copying a Preset

When editing a preset, the Store LED lights indicating you have changed a parameter and need to store the changes. Once you have modified the Amp Models, Cabinet types, and Effect Parameters, store it to a User Preset location. The following steps outline the procedure for storing a preset:

1. Press the **STORE** button. The first letter of the preset name begins flashing.
2. Use the **DATA WHEEL** to select the alpha-numeric character
3. Press the **RHYTHM** button to select the next character to the right, and the **FX EDIT** button to select the previous character to the left.

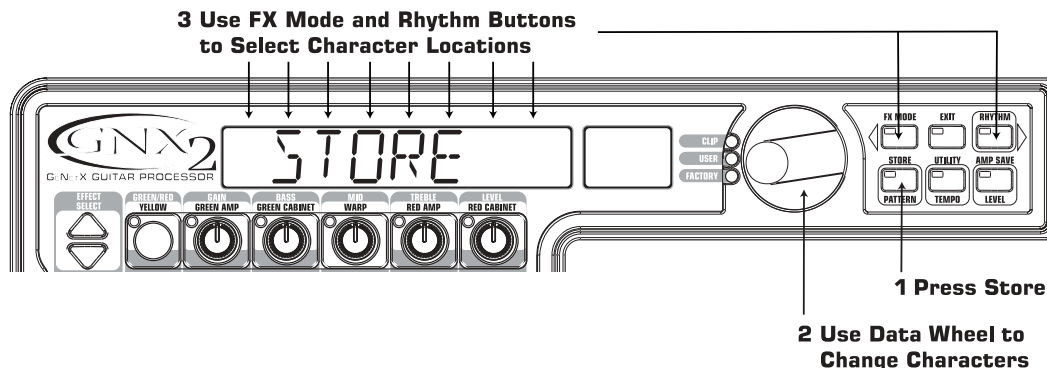

4. Repeat steps 2 and 3 until the preset name shows in the display.
5. Once you have entered the name for the preset, press the **STORE** button again. The current preset location flashes in the numeric display.
6. Select the User Preset location using the **DATA WHEEL**.

Editing Functions

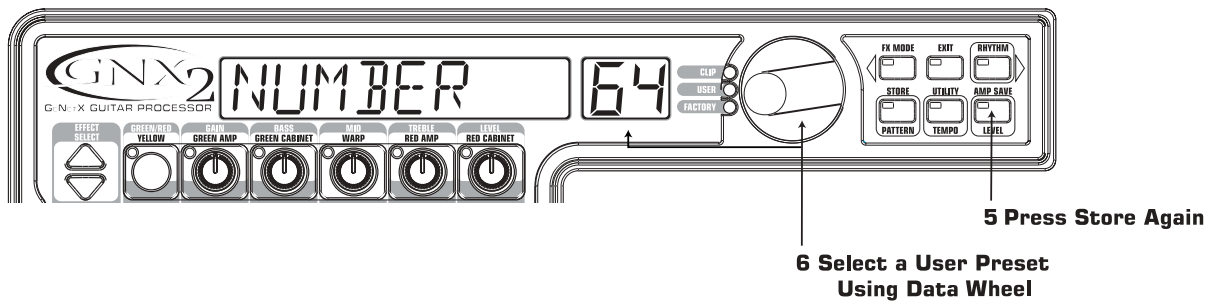

7. Press the **STORE** button again to finish.

To copy one preset to another preset location, begin by selecting the preset you want to copy, then follow the steps listed above.

Press **EXIT** at any time during the procedure to aborts the process.

Effects and Parameters

Effects and Parameters

The GNX2 can be thought of as several different “virtual” amplifiers, and individual, hi-tech stomp boxes. With stomp boxes, the order in which they are connected can make a big difference in how good the overall sound is. Whether the stomp boxes are placed before the amp, or in the amp’s effects loop will also make a difference. The GNX2 has the effects connected in the most logical, and best sounding order. The following diagram shows the signal path through the processing contained in the GNX2.

Effect Definitions

Each Effect within the GNX2 is fully programmable to suit your personal tastes and application. Understanding how these effects alter the sound, and how each parameter alters the effect will help you achieve the sound you are looking for. The following overview outlines how each effect and parameter in the GNX2 will alter the sound.

Wah-Pickup

A Wah is an effect controlled by the Expression Pedal. A Wah applies a boost in gain to a narrow band of frequencies. As the Expression Pedal is rocked back and forth, the center frequency receiving the boost is swept up and down making the guitar sound as if it is saying “Wah.” The Wah is engaged and disengaged by applying pressure to the V-Switch located under the toe of the Expression Pedal. See page 40 for more information regarding the V-Switch.

The Pickup Simulator applies the warmth and thickness of a double coil humbucker pickup to a single coil guitar, or the unique, crisp sound of a single coil pickup to a guitar with a humbucker. This allows you to have the best of both worlds without ever changing guitars.

Wah On/Off - The Status button (or the V-Switch) turns the Wah (*WAH*) on and off.

Wah Type - The Number 1 knob selects the type of Wah. Values include: Cry Wah (*CRY*) is a traditional sounding Wah, Boutique Wah (*BOUTIQUE*) is a wide sweeping Wah with a more modern sound and Full Range Wah (*FULLRANG*) sweeps the entire spectrum of audible frequencies.

Wah Minimum - The Number 2 knob is used to select the minimum point the Wah (*WAH MIN*) will reach in the toe up position of the Expression Pedal. Ranges from 0 to 99.

Wah Maximum - The Number 3 knob is used to select the maximum point the Wah (*WAH MAX*) will reach in the toe down position of the Expression Pedal. Ranges from 0 to 99.

Pickup Type/Off - The Number 4 knob selects the type of Pick Up to be simulated. Values include: Pickup Simulator Off (*PICKOFF*), Single Coil>Humbucker (*SC>HUMB*) gives a single coil pick up the warm tone of a humbucker, and Humbucker>Single Coil (*HUMB>SC*) gives a humbucker the unique sound of a single coil.

The Number 5 knob doesn’t function when the Wah-Pickup module is selected.

Compressor

A compressor is used to increase sustain, and tighten up guitars. A compressor sets boundaries for a signal’s strength. When a signal exceeds the set boundary, it is forced back into the set boundary. As the signal fades to a point where it no longer exceeds the boundary, the compressor expands the signal strength and increases sustain. The compression parameters are as follows:

Comp On/Off - The Status button turns the Compressor (*COMPRESS*) on and off.

Attack - The Number 1 knob adjusts the length of time it takes for the Compressor to respond to a signal exceeding the Threshold. Values include: *FAST*, *MEDIUM*, and *SLOW*.

Ratio - The Number 2 knob adjusts the input to output ratio once the Threshold has been exceeded.

Effects and Parameters

For instance, a Ratio of 4 to 1 means that a signal exceeding the Threshold by 4 dB will only be allowed 1 dB of increased output. Higher settings yield a tighter, sound and increase sustain.

Lower settings allow better dynamics. Ranges include: 1.2:1 (1.2:1), 1.5:1 (1.5:1), 1.8:1 (1.8:1), 2:1 (2:1), 2.5:1 (2.5:1), 3:1 (3:1), 4:1 (4:1), 5:1 (5:1), 8:1 (8:1), 10:1 (10:1), 20:1 (20:1), and INF:1 (infinity:1).

Threshold - The Number 3 knob selects the Threshold (*THRESHOLD*). The Threshold is the level a signal is allowed to reach before the compressor begins to work. Low Threshold settings activate the compressor with weaker signals. Higher settings require a stronger signal to activate compression. Ranges from 0 to 99.

Gain - The Number 4 knob adjusts the Output Gain (*GAIN*) from the Compressor. This parameter is used to balance the level of the Compressor to reach unity gain. Other effects can clip if the Compressor Gain too high. Ranges from 0 to 20 (dB).

The Number 5 knob doesn't function when the Compressor is selected.

Whammy/IPS

This module includes 4 types of pitch altering effects: Whammy™, IPS, Detune, and Pitch Shift. The Status button turns the Whammy/IPS (*WHAM/IPS*) module on and off. The Number 1 knob (*TYPE*) selects whether the module is a Whammy™ (*WHAMMY*), Intelligent Pitch Shifter (*IPS*), Detuner (*DETUNE*), or Pitch Shifter (*PITCH*). Parameters 1, 2, and 3 in the Matrix have different functions depending upon which effect is selected in this module.

Whammy™ is an effect that uses an Expression Pedal to bend the pitch of the incoming signal, or add a bendable harmony with the original signal. As the Pedal is moved, the note bends either up or down. When Whammy™ is selected, it is automatically placed before the Amp Modeling as shown in the block diagram (see page 49). The Whammy™ effect must be linked to the Expression Pedal in order to function. See page 37 for more information on linking the Expression Pedal.

Parameter 1 (Whammy™) - The Number 2 knob selects the interval and direction of the pitch bend. Choices are as follows:

Whammy (no Dry Signal)

1 OCT UP (1 octave up)
2 OCT UP (2 octaves up)
2ND DOWN (a second down)
REV 2ND DN (a second down reversed pedal action)
4TH DOWN (a fourth down)
1 OCT DN (an octave down)
2 OCT DN (2 octaves down)
DIVE BOMB (Dive Bomb)

Harmony Bends (Dry Signal Added)

M3>MAJ3 (a minor third to a Major third)
2ND>MAJ3 (a second above to a Major third up)
3RD>4TH (a third above to a fourth up)
4TH>5TH (a fourth above to a fifth up)
5TH>OCT (a fifth above to an octave up)
1 OCT UP (one octave up)
1 OCT DN (one octave down)
OCT UP>DN (one octave up to one octave down)

Parameter 2 (Whammy™) - The Number 3 knob provides a manual control of the Whammy™ pedal position. Ranges from 0 to 99.

The Number 4 knob has no function when the Whammy™ is selected.

Intelligent Pitch Shifting (IPS)

Intelligent Pitch Shifting makes a copy of the incoming signal, and then changes the pitch of the copied note to a diatonically correct interval specified by the Amount parameter. An Intelligent Pitch Shifter sharpens or flattens the shifted pitch in order to keep the specified interval within the selected key and scale creating a true harmony.

Parameter 1 (IPS) - The Number 2 knob selects the Amount or harmony interval for the Intelligent

Effects and Parameters

Pitch Shifter. Interval choices include:

<i>OCT DOWN</i> (octave down)	<i>2ND UP</i> (a second above)
<i>7TH DOWN</i> (a seventh below)	<i>3RD UP</i> (a third above)
<i>6TH DOWN</i> (a sixth below)	<i>4TH UP</i> (a fourth above)
<i>5TH DOWN</i> (a fifth below)	<i>5TH UP</i> (a fifth above)
<i>4TH DOWN</i> (a fourth below)	<i>6TH UP</i> (a sixth above)
<i>3RD DOWN</i> (a third below)	<i>7TH UP</i> (a seventh above)
<i>2ND DOWN</i> (a second below)	<i>OCT UP</i> (an octave above)

Parameter 2 (IPS) - The Number 3 knob selects the scale the IPS will use. Scale choices include: Major (*MAJOR*), Minor (*MINOR*), Dorian (*DORIAN*), Mixolydian (*MIXOLYDIAN*), Lydian (*LYDIAN*), Harmonic Minor (*HARMINOR*).

Parameter 3 (IPS) - The Number 4 knob selects the musical key the IPS will use. Key choices range from Key E (*KEY E*) through Key Eb (*KEY EB*).

Detuning

Detuning is similar to a standard pitch shifter with the exception that it shifts the copied signal by less than a semitone resulting in an effect as if two guitars were slightly out of tune and playing in unison.

Parameter 1 (Detune) - The Number 2 knob selects the Amount (*AMOUNT*) of detuning applied to the copied pitch in cents (100 cents equals 1 semitone). Ranges from 24 cents below (*-24*) to 24 cents above (*+24*).

The Number 3 and 4 knobs don't function when Detune is selected.

Pitch Shifter

A Pitch Shifter makes a copy of the incoming signal and shifts the pitch of the copied signal and keeps the shifted pitch at a parallel distance from the input note.

Parameter 1 (Pitch) - The Number 2 knob selects the Shift (*SHIFT*) of the pitch in semitone intervals. Ranges from two octaves below (*-24*) to two octaves above (*+24*).

The Number 3 and 4 knobs have no function when Pitch is selected.

Level - The Number 5 knob adjusts the Level or Mix (*IPS LVL/IPS MIX*) of all pitch altering effects in this module. Ranges from 0 to 99.

Stomp Box Modeling

The GNX2 Stomp Box Modeling emulates the tones of the most popular distortion boxes ever used including the DOD OD250, Boss DS-1, Arbiter Fuzz Face, Electro Harmonix Big Muff, ProCo RAT, DOD Grunge, Boss Metal Zone, Ibanez TS-9, Voodoo Labs Sparkle Drive, and the Guyatone OD-2*.

*Arbiter, Boss, Electro-Harmonix, ProCo, Ibanez, Voodoo Labs, Guyatone, DS-1, Fuzz Face, Big Muff, RAT, Metal Zone, TS-9, Sparkle Drive, and OD-2 are trademarks of their respective companies and are in no way associated with DigiTech

Stomp Box On/Off - The Status button turns the Stomp Box (*STOMPBOX*) Modeling on and off.

Stomp Box Type - The Number 1 knob selects the type of stomp box to be used. Choices include:

Effects and Parameters

SCREAMER - Based on an Ibanez TS-9
FUZZY - Based on an Arbiter Fuzz Face
DOD 250 - Based on a DOD Overdrive 250
GRUNGE - Based on a DOD Grunge™.
DS DIST - Based on a Boss DS-1.

BIG MP - Based on the Electro Harmonix Big Muff Pi.
GUY OD - Based on a GuyaTone OD-2
RODENT - Based on a Rat distortion
SPARK DRIV - Based on a Voodoo Labs SparkleDrive.
ZONE - Based on a Boss Metal Zone.

Type	Gain	Param1	Param2	Param3*	Param4*	Level
<i>SCREAMER</i>	<i>DRIVE</i>	<i>STONE</i>				<i>LEVEL</i>
<i>RODENT</i>	<i>DIST</i>	<i>FILTER</i>				<i>VOLUME</i>
<i>DS DIST</i>	<i>DIST</i>	<i>STONE</i>				<i>LEVEL</i>
<i>DOD 250</i>	<i>GAIN</i>					<i>LEVEL</i>
<i>BIG MP</i>	<i>SUSTAIN</i>	<i>STONE</i>				<i>VOLUME</i>
<i>GUY OD</i>	<i>DRIVE</i>					<i>LEVEL</i>
<i>SPARK DRV</i>	<i>GAIN</i>	<i>STONE</i>	<i>CLEAN</i>			<i>VOLUME</i>
<i>GRUNGE</i>	<i>GRNGGAIN</i>	<i>BUTT</i>	<i>FACE</i>			<i>LOUD</i>
<i>FUZZY</i>	<i>FUZZ</i>					<i>VOLUME</i>
<i>ZONE</i>	<i>DIST</i>	<i>MID FREQ</i>	<i>MID LVL</i>	<i>LOW</i>	<i>HIGH</i>	<i>LEVEL</i>

Gain - Controls the amount of distortion or gain in the Stompbox model. Range is 0-99

Param1 - A tone control for the Stompbox model. Range is 0-99

Param2 - A second Tone control for the Stompbox model (not available in all models). Range is 0-99

Param3* - Controls the Mid Frequency in the Zone stompbox model. Range is 0-99

Param4* - Controls the Mid Level in the Zone stompbox model. Range is 0-99

Level - Controls the output level of the Stompbox model. Range is 0-99

EQ

Equalization helps shape the tonal response of your guitar signal. The EQ in the GNX2 is similar to the tone knobs on an amplifier with the exception that the GNX2 lets you choose the center frequency for the Mid Range and Treble adjustments.

EQ Green/Red - The Status button adjusts the EQ when a Warped combination (green and red) of amps is selected. This button does not function if only the green or red channel is selected.

Bass Level - The Number 1 knob adjusts the amount of low end enhancement. Ranges from *GRN/RED* *BASS* -12 to 12 (dB).

Mid Frequency - The Number 2 knob selects the frequency to which the boost will be applied by the Mid Level knob. Ranges from 300Hz to 5000Hz.

Mid Level - The Number 3 knob adjusts the amount of mid range enhancement. Ranges from *GRN/RED* *MID* -12 to 12 (dB).

Treble Frequency - The Number 4 knob selects the frequency to which the boost will be applied by the Treble Level knob. Ranges from 500Hz to 8000Hz.

Treble Level - The Number 5 knob adjusts the amount of high end enhancement. Ranges from *GRN/RED* *TRBL* -12 to 12 (dB).

Noise Gate

A Noise Gate is designed to eliminate hiss and ambient noise while you are not playing. A Noise Gate can also be used to create an automatic swell in volume. The GNX2 includes two different types of Noise Gates: Silencer™, and Pluck. The Silencer™ operates as a standard Noise Gate. The Pluck Noise Gate is designed to close after every note (depending on the Pluck Sensitivity). This allows automatic volume swells to occur on a note by note basis.

Effects and Parameters

Gate On/Off - The Status button turns the Noise Gate (*GATE*) on and off.

Gate Type - The Number 1 knob selects between the Silencer™ (*SILENCER*) or Pluck (*PLUCK*) type of Noise Gates.

Gate Threshold - The Number 2 knob sets the signal strength required to open or close the Noise Gate. The Gate Threshold (*THRESHOLD*) parameter ranges from 0 (opens easily) to 40 (requires strong signals to open).

Gate Attack - The Number 3 knob adjusts the length of time it takes the gate to open (*ATTACK*) and the signal to become audible once the Threshold has been exceeded. Ranges from 0 (immediate signal), to 9 (This setting will gradually ramp up the volume).

***Pluck Sensitivity** - Selects the threshold (*PLUCK*) where the Gate retriggers when using the Pluck type Noise Gate. This parameter is only available when Pluck is the selected type of Noise Gate. Ranges from 0 (requires strong signals to retrigger) to 99 (retriggers with weak signals).

The Number 5 knob does not function when the Noise Gate is selected.

Talker™

The Talker™ is an effect designed exclusively by DigiTech, that lets your instrument speak. The Talker™ requires a microphone be connected to the Mic Input on the rear panel of the GNX2. As you speak into the microphone, your instrument mimics what you say. The Talker™ effect is output only at the 1/4" left and right outputs. When the Talker™ is bypassed, the mic signal is passed from the XLR mic in to the XLR mic out unaffected. There are five types of Talker™ selections to choose from.

*** These Parameters are only available using the GENEDIT™ computer editor software.**

Type - The Number 4 knob is used to select the 5 Talker™ types and turns the Talker off (*TALKOFF*). Talker types range from *TALKER 1* (deep tonal characteristics), to *TALKER 5* (bright tonal characteristics).

Sensitivity - The Number 5 knob is used to adjust the microphone sensitivity for the Talker™ effect. The Talker™ must have an appropriate input level from your microphone in order to work properly. If the microphone input is too weak, the Talker™ will have trouble tracking. If the input is too strong, the Talker™ will clip making the words unintelligible. The Mic Sensitivity ranges from 1 being the least sensitive to 99 being the most sensitive.

Chorus/Mod Effects

The Modulation Effects group is a multi-function module allowing you to select effects such as; Chorus, Flanger, Phaser, Triggered Flanger, Triggered Phaser, Tremolo, Panner, Vibrato, Rotary Speaker, AutoYa™, YaYa™, SynthTalk™, Envelope Filter (auto wah), Detune, and Pitch Shift. Only one of the effects in this row can be used at a time. When the Chorus/Mod group is selected, the Status button is used to turn the Effect (*EFFECT*) module on and off. The Number 1 knob is used to select the type of effect. After selecting the type of effect in this module, the Number 2-5 knobs can then be used to adjust the individual parameters associated with the selected effect. The following pages describe each effect and their parameters in more detail.

CHORUS (*CHORUS*)

A Chorus adds a short delay to your signal. The delayed signal is modulated in and out of tune and then mixed back with the original signal to create a thicker sound.

Parameter 1 - The Number 2 knob adjusts the rate (*SPEED*) of the modulation. Ranges from 1 to 99.

*** These Parameters are only available using the GenEdit™ computer editor software.**

Effects and Parameters

Parameter 2 - The Number 3 knob adjusts the intensity (*DEPTH*) of the modulation. Ranges from 1 to 99.

Parameter 3 - The Number 4 knob adjusts the PreDelay (*PREDELAY*) or length of time before the Chorus effect is applied to the input signal. Ranges from 1 to 20.

* **Parameter 4** - Selects the waveform used by the Chorus. Waveforms include: Triangle , Sine, and Square.

* **Parameter 5** - Adjusts the left to right balance of the wet signal. Ranges from L 99 to R 99.

Mod Level - The Number 5 knob controls the level (*MOD LEVEL*) of the Chorus. Ranges from 0 to 99.

FLANGER (*FLANGER*)

A Flanger uses the same principle as a Chorus but uses a shorter delay time and adds regeneration (or repeats) to the modulating delay. This results in an exaggerated up and down sweeping motion to the effect.

Parameter 1 - The Number 2 knob adjusts the rate (*SPEED*) of the modulation. Ranges from 1 to 99.

Parameter 2 - The Number 3 knob adjusts the intensity (*DEPTH*) of the Modulation. Ranges from 1 to 99.

Parameter 3 - The Number 4 knob adjusts the amount of feedback (*REGEN*) added to the Flanger delay. Ranges from 0 to 99.

* **Parameter 4** - Selects the waveform used by the Flanger. Waveforms include: Triangle , Sine, and Square.

* **Parameter 5** - Adjusts the left to right balance of the wet signal. Ranges from L 99 to R 99.

Mod Mix - The Number 5 knob controls the mix (*MOD MIX*) of wet and dry signal. Ranges from 0 (all dry) to 99 (all wet).

PHASER (*PHASER*)

A Phaser splits the incoming signal, and then changes the phasing of the signal. The signal is then taken in and out of phase and mixed back in with the original signal. As the phasing changes, different frequencies are canceled resulting in a warm sort of twisting sound.

Parameter 1 - The Number 2 knob adjusts the rate (*SPEED*) of the modulating phase. Ranges from 1 to 99.

Parameter 2 - The Number 3 knob adjusts the intensity (*DEPTH*) of the modulation. Ranges from 1 to 99.

Parameter 3 - The Number 4 knob adjusts the amount of effected signal returned to the input of the Phaser (*REGEN*). Ranges from 0 to 99.

* **Parameter 4** - Selects the waveform used by the Phaser. Waveforms include: Triangle , Sine, and Square.

* **Parameter 5** - Adjusts the left to right balance of the wet signal. Ranges from L 99 to R 99.

Mod Mix - The Number 5 knob controls the mix (*MOD MIX*) of wet and dry signal. Ranges from 0 (all dry) to 99 (all wet).

* These Parameters are only available using the GENEDIT™ computer editor software.

Effects and Parameters

TRIGGERED FLANGER (*TRIGFLNG*)

A Triggered Flanger is the same sound as a regular Flanger but it lets you choose the starting point of the Flanger sweep. With a regular Flanger, the low frequency oscillator (LFO) is continually sweeping up and down. Meaning, when you begin to play, the flanger may be at the top, bottom, or any random point of the sweep. With a Triggered Flanger, every time the signal exceeds the Sensitivity level setting, the Flanger begins at the point of the sweep that you set with the value of the LFO Start Parameter.

Parameter 1 - The Number 2 knob adjusts the rate (*SPEED*) of the modulation. Ranges from 1 to 99.

Parameter 2 - The Number 3 knob adjusts the strength the signal must be (*SENSITIVITY*) in order to trigger the Flanger. Ranges from 1 (requiring strong signals to trigger) to 99 (triggers with weak signals).

Parameter 3 - The Number 4 knob selects the Flanger sweep starting point (*LFO START*). Ranges from 0 to 99.

Mod Mix - The Number 5 knob controls the mix (*MOB MIX*) of wet and dry signal. Ranges from 0 (all dry) to 99 (all wet).

TRIGGERED PHASER (*TRIGPHAS*)

A Triggered Phaser is the same sound as a regular Phaser but it lets you choose the starting point of the Phaser sweep. In a regular Phaser, the low frequency oscillator (LFO) is continually changing the phase of the signal. Meaning, when you begin to play, the phaser may be at any random point of the phase. With a Triggered Phaser, every time the signal exceeds the Sensitivity level setting, the Phaser begins at the point of phasing that you set with the value of the LFO Start Parameter.

Parameter 1 - The Number 2 knob adjusts the rate (*SPEED*) of the modulating phase. Ranges from 1 to 99.

Parameter 2 - The Number 3 knob adjusts the strength the signal must be (*SENSITIVITY*) in order to trigger the Phaser. Ranges from 1 (requiring strong signals to trigger) to 99 (triggers with weak signals).

Parameter 3 - The Number 4 knob selects the Phaser sweep starting point (*LFO START*). Ranges from 0 to 99.

Mod Mix - The Number 5 knob controls the mix (*MOB MIX*) of wet and dry signal. Ranges from 0 (all dry) to 99 (all wet).

TREMOLO (*TREMOLO*)

A Tremolo effect modulates the volume of the signal at an even rate.

Parameter 1 - The Number 2 knob adjusts the rate (*SPEED*) at which the volume modulates. Ranges from 1 to 99.

Parameter 2 - The Number 3 knob adjusts the intensity (*DEPTH*) of the modulating volume. Ranges from 0 to 99.

Parameter 3 - The Number 4 knob selects the type of wave form the modulation will use. Choices include: Triangle, Sine, and Square.

The Number 5 knob does not function when the Tremolo is selected.

* These Parameters are only available using the GenEdit™ computer editor software.

Effects and Parameters

PANNER (*PANNER*)

An Auto Panner modulates the sound from left to right at an even rate.

Parameter 1 - The Number 2 knob adjusts the rate (*SPEED*) at which the signal pans from side to side. Ranges from 1 to 99.

Parameter 2 - The Number 3 knob adjusts the intensity (*DEPTH*) of the changing pan. Ranges from 0 to 99.

Parameter 3 - The Number 4 knob selects the type of wave form the modulation will use. Choices include: Triangle , Sine, and Square.

The Number 5 knob does not function when the Panner is selected.

VIBRATO (*VIBRATO*)

A Vibrato effect modulates the pitch of the incoming signal at an even rate.

Parameter 1 - The Number 2 knob adjusts the rate (*SPEED*) at which the pitch modulates. Ranges from 1 to 99.

Parameter 2 - The Number 3 knob adjusts the intensity (*DEPTH*) of the modulating pitch. Ranges from 1 to 99.

Parameter 3 - The Number 4 knob selects the type of wave form the modulation will use. Choices include: Triangle , Sine, and Square.

ROTARY SPEAKER (*ROTARY*)

Rotary Speaker is an emulation of a device that included a spinning horn and rotor (woofer). The rotation of these two speakers produced an interesting combination of sound panning from side to side, as well as a slight pitch change due to the speed of the sound coming towards, and then going away from the listener.

Parameter 1 - The Number 2 knob adjusts the rate (*SPEED*) of the spinning speakers. Ranges from 0 to 99.

Parameter 2 - The Number 3 knob controls the intensity (*DEPTH*) of the Effect. Ranges from 0 to 99.

Parameter 3 - The Number 4 knob controls the Pitch Shift (*DOPPLER*) effect which is the ratio between the horn and the rotor positions. Ranges from 0 to 99.

* **Parameter 4** - Selects the crossover frequency between the horn and rotor. Ranges from 200Hz to 1500Hz.

Mod Mix - The Number 5 knob controls the mix (*MOD MIX*) of wet and dry signal. Ranges from 0 (all dry) to 99 (all wet).

AUTOYA™ (*AUTOYA*)

An AutoYa™ combines the characteristics of a Wah and a Flanger together creating an almost human vowel sound as if the guitar were saying "Yah." The AutoYa™ automatically provides this animation by modulating the sound at an even rate.

Parameter 1 - The Number 2 knob adjusts the rate (*SPEED*) of the AutoYa. Ranges from 1 to 99.

* These Parameters are only available using the GenEdit™ computer editor software.

Effects and Parameters

Parameter 2 - The Number 3 knob adjusts the intensity (*DEPTH*) of the AutoYa™ effect. Ranges from 1 to 99.

Parameter 3 - The Number 4 knob adjusts the throaty quality (*RANGE*) of the AutoYa™ effect. Ranges from 1 to 50.

* **Parameter 4** - Adjusts the left to right balance of the wet signal. Ranges from L 99 to R 99.

Mod Mix - The Number 5 knob controls the mix (*MOD MIX*) of wet and dry signal. Ranges from 0 (all dry) to 99 (all wet).

YAYA™ (YAYA)

The YaYa™ is an effect exclusive to DigiTech products. The YaYa™ is controlled by the Expression Pedal and combines the characteristics of a wah and a flanger together providing a unique talk box type of effect. As the Expression Pedal is rocked back and forth, the guitar appears to say "Yah." The YaYa™ effect must be linked to the Expression Pedal in order to function. See page 37 for more information on linking the Expression Pedal.

Parameter 1 - The Number 2 knob adjusts the Ya Pedal position (*YA PEDAL*). Ranges from 0 to 99.

Parameter 2 - The Number 3 knob adjusts the intensity (*DEPTH*) of the YaYa™ effect. Ranges from 1 to 99.

Parameter 3 - The Number 4 knob adjusts the throaty quality (*RANGE*) of the YaYa™ effect. Ranges from 1 to 50.

* **Parameter 4** - Adjusts the left to right balance of the wet signal. Ranges from L 99 to R 99.

Mod Mix - The Number 5 knob controls the mix (*MOD MIX*) of wet and dry signal. Ranges from 0 (all dry) to 99 (all wet).

SYNHTALK™ (SYNHTALK)

SynthTalk™ is another effect exclusive to DigiTech. It makes your guitar seem to speak based upon the dynamics of your playing style.

Parameter 1 - The Number 2 knob adjusts the Attack (*ATTACK*) of the synthesized voice. Ranges from 0 to 99.

Parameter 2 - The Number 3 knob adjusts the Release (*RELEASE*) of the synthesized voice. Ranges from 1 to 99, and oo (infinity).

Parameter 3 - The Number 4 knob changes the characteristics of the various synth voices (*VOX*). Ranges from 0 to 99.

* **Parameter 4** - Adjusts the left to right balance of the wet signal. Ranges from L 99 to R 99.

Mod Level - The Number 5 knob adjusts the sensitivity (*SENSITIVITY*) of the input signal required to trigger the SynthTalk™ effect. Ranges from 1 to 99.

ENVELOPE FILTER (ENVELOPE)

The Envelope Filter is an automatic Wah effect that alters your sound based upon how hard the strings are struck.

Parameter 1 - The Number 2 knob adjusts the sensitivity (*SENSITIVITY*) of the input signal required to trigger the Wah effect. Ranges from 1 to 99.

Parameter 2 - The Number 3 knob adjusts the frequency range (*RANGE*) of the Wah effect. Ranges from 1 to 99.

* These Parameters are only available using the GenEdit™ computer editor software.

Effects and Parameters

Parameter 3 - The Number 4 knob adjusts the left/right balance (*BAL*) of the Wah signal. Ranges from left -99 (*L-99*) to right 99 (*R+99*).

Mod Mix - The Number 5 knob controls the mix (*MOD MIX*) of wet and dry signal. Ranges from 0 (all dry) to 99 (all wet).

DETUNE (*DETUNE*)

A Detuner makes a copy of your incoming signal, takes the copied signal slightly out of tune from the original, and mixes the two signals together. The result is a doubling type of effect as if two guitars were playing the same part together.

Parameter 1 - The Number 2 knob adjusts the amount of pitch difference (*AMOUNT*) applied to the copied signal. Ranges from -24 cents to +24 cents.

Parameter 2 - The Number 3 knob adjusts the left/right balance (*BAL*) of the detuned signal. Ranges from left 99 (*L-99*) to right 99 (*R+99*).

Mod Level - The Number 5 knob controls the level (*MOD LEVEL*) of the detuned note. Ranges from 0 to 99.

The Number 4 knob does not function when the Detune effect is selected.

PITCH SHIFT (*PITCH*)

A Pitch Shifter copies the incoming signal, then shifts the pitch of the copied note to a different note. The shifted note is then mixed back with the original signal sounding as if two guitars were playing parallel notes.

Parameter 1 - The Number 2 knob adjusts the Amount of Pitch Shift (*SHIFT*) in intervals of one semi-tone. Ranges from 24 semitones below to 24 semitones above.

Parameter 2 - The Number 3 knob adjusts the left/right balance (*BAL*) of the shifted pitch. Ranges from left 99 (*L-99*) to right 99 (*R+99*).

Mod Level - The Number 5 knob controls the level (*MOD LEVEL*) of the shifted pitch. Ranges from 0 to 99.

The Number 4 knob does not function when the Pitch Shifter is selected.

DELAY

Delay records a portion of the incoming signal, and plays it back a short time later. The recorded segment can repeat just once, several times, or infinitely (that turns off the input to the Delay and lets you play over the top of a passage in the Delay loop). The Delay in the GNX2 also includes a Ducker Threshold that lets you set the signal strength required before the Delay records. This feature lets you control the Delay with your playing.

Delay On/Off - The Status button turns the Delay (*DELAY*) on and off.

Delay Type - The Number 1 knob selects one of the 5 different types of Delay. The Delay choices include:

MONO (clear concise repeats)

PINGPONG (bounces from side to side)

ANALOG (deteriorates with each repeat)

ANLGPPONG (side to side with deterioration)

SPREAD (clear concise repeats with stereo imaging)

Effects and Parameters

Time - The Number 2 knob adjusts the length of time between repeats. Ranges from 10 MS through 2000MS (10 through 2000 milliseconds) in 10 ms increments. Using the Data Wheel while the Delay Time is showing in the Display will adjust the Delay Time in 1 ms increments.

Feedback - The Number 3 knob adjusts the number of times the delayed signal will repeat (*FEEDBACK*). Ranges from 1 to 99 and *RPT HOLD* (infinite repeat).

Ducker Threshold - The Number 4 knob adjusts the level (*THRESHOLD*) the input signal must reach before the Delay signal is attenuated. Ranges from 0 to 99 and off (*OFF*).

* **Ducker Attenuation** - The Ducker Level selects the amount of attenuation applied to the Delay signal when the Ducker Threshold has been exceeded. Ranges from 0 to 99.

* **Delay Balance** - The Delay Balance adjusts the left/right balance of the Delay signal. Ranges from L 99 to R 99.

* **Spread** - This parameter increases or decreases the stereo imaging for the Spread Delay. Range is 1-50.

Delay Level - The Number 5 knob adjusts the volume (*DELAY LEVEL*) of the Delay signal. Ranges from 0 to 99.

REVERB

Reverb gives the listener a sense that the music is being performed in various acoustical environments. It can provide the tight acoustics of a small room, or the ambience of huge arena.

Reverb On/Off - The Status button turns the Reverb (*REVERB*) on and off.

Reverb Type - The Number 1 knob selects the type of Reverb or acoustic environment. The GNX2 provides ten different environments to choose from including:

STUDIO = Studio
ROOM = Wood Room
CLUB = Club
PLATE = Plate
HALL = Hall

THEATER = Amphitheater
CHURCH = Church
GARAGE = Parking Garage
ARENA = Arena
SPRING = Spring

PreDelay - The Number 2 knob adjusts the amount of time (*PREDELAY*) it takes for the initial sound to reach the first reflective surface in the simulated environment. Ranges from 0 to 15.

Decay - The Number 3 knob adjusts the length of time the Reverb is audible (*DECAY*). Ranges from 1 to 99.

Damping - The Number 4 knob controls the amount of sound which is absorbed (*DAMPING*) in the simulated environment. Ranges from 0 to 99.

* **Reverb Balance** - The Reverb Balance adjusts the left/right balance of the Reverb signal. Ranges from L 99 to R 99.

Reverb Level - The Number 5 knob adjusts the level (*REVB LEVEL*) of the Reverb. Ranges from 0 to 99.

* These Parameters are only available using the GenEdit™ computer editor software.

Tutorial

Suppose you wanted to create your own HyperModel™ that incorporated the sweet tones of a vintage Tweed using an American 2x12 cabinet, and the ripping distortion of a Rectified Amp with a British 4x12 cabinet. Let's also suppose that we want to be able to toggle between an acoustic guitar simulation and this new HyperModel™ with a preset that gives your single coil pickup a humbucker sound, uses no Compression, has a Noise Gate that opens quickly, a subtle Chorus effect, no Delay, and a little bit of a Hall reverb. The following steps guide you through the process for creating just such a preset in the GNX2.

Select a Preset

The first step to create a preset is to select your starting point. You can start with any preset, but for this example let's start with Preset 40. Use the Footswitches or the Data Wheel to select Preset 40.

Create a HyperModel™

For this example, we are going to use a vintage Tweed amp with an American 2x12 Cabinet, and warp it with a Rectified Amp using a British 4x12 cabinet. Select Preset 40, and the GNX2 is ready to select the Amp Models (indicated by the Status button's yellow LED).

Select the Green Channel Amp and Cabinet

The LEDs next to the Number 1 and Number 2 knobs are green indicating they will select the Amp and Cabinet types for the Green Channel. To assign the vintage Tweed amp to the Green Channel, rotate the Number 1 knob until the display reads *TWEED* (Tweed). Then rotate the Number 2 knob until the display reads *AMER2x12* (American 2x12).

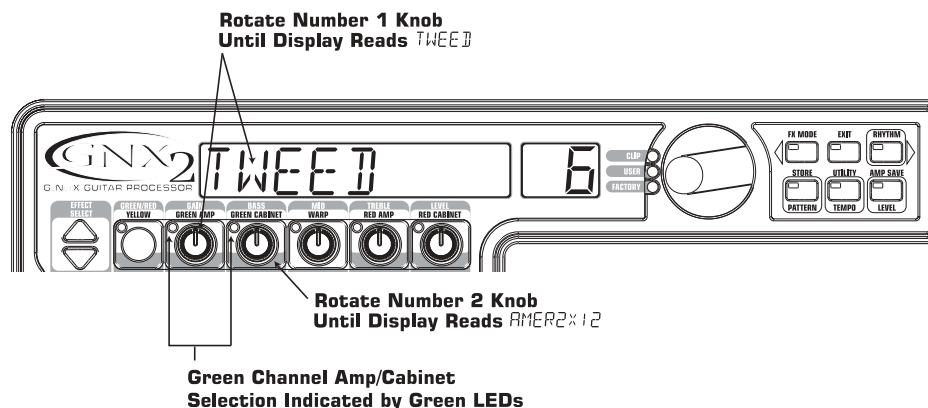

Select the Red Channel Amp and Cabinet

The LEDs next to the Number 4 and Number 5 knobs are red indicating they will select the Amp and Cabinet types for the Red Channel. To assign the Rectified amp to the Red Channel, rotate the Number 4 knob until the display reads *RECTIFIED* (Rectified). Then rotate the Number 5 knob until the display reads *BRIT4x12* (British 4x12).

Tutorial

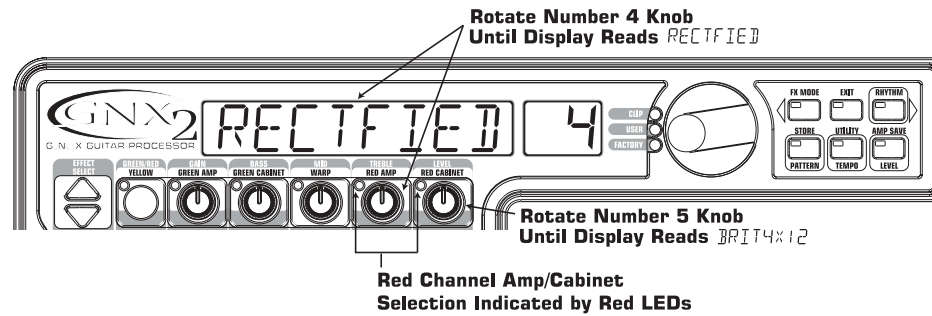

Adjust the Green Channel Parameters

The Tweed amp that we selected for our Green Channel assignment uses the factory default settings for the Gain, EQ, and Level Parameters. Therefore, you may want to change the settings. To access the Green Channel Parameters, press the **STATUS** button. All horizontal LEDs light green indicating that all 5 knobs will adjust the Green Channel Parameters. Rotate the Number 1 knob to adjust the Tweed Gain. Rotate the Number 2 knob to adjust the Tweed Bass. Rotate the Number 3 knob to adjust the Tweed Mids. Rotate the Number 4 knob to adjust the Tweed Treble. Rotate the Number 5 knob to adjust the Tweed Level.

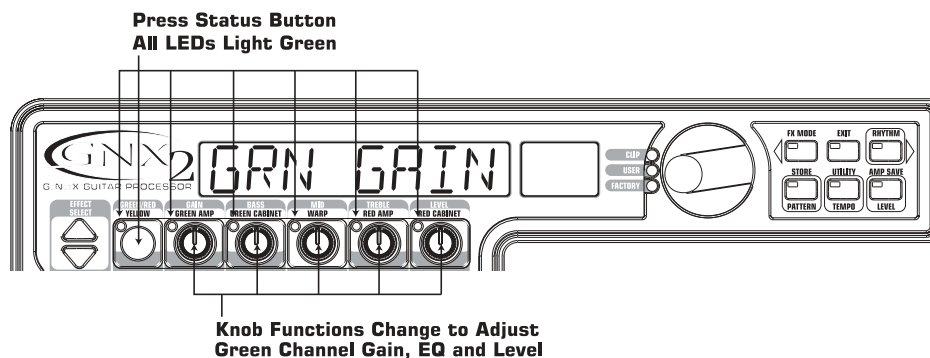

Adjust the Red Channel Parameters

Like the Tweed amp in the Green Channel, the Rectified amp in the Red Channel may need to be adjusted to suit your personal taste. To access the Red Channel Parameters, press the **STATUS** button. All horizontal LEDs light red indicating that all 5 knobs will adjust the Red Channel Parameters. Rotate the Number 1 knob to adjust the Rectified Gain. Rotate the Number 2 knob to adjust the Rectified Bass. Rotate the Number 3 knob to adjust the Rectified Mids. Rotate the Number 4 knob to adjust the Rectified Treble. Rotate the Number 5 knob to adjust the Rectified Level.

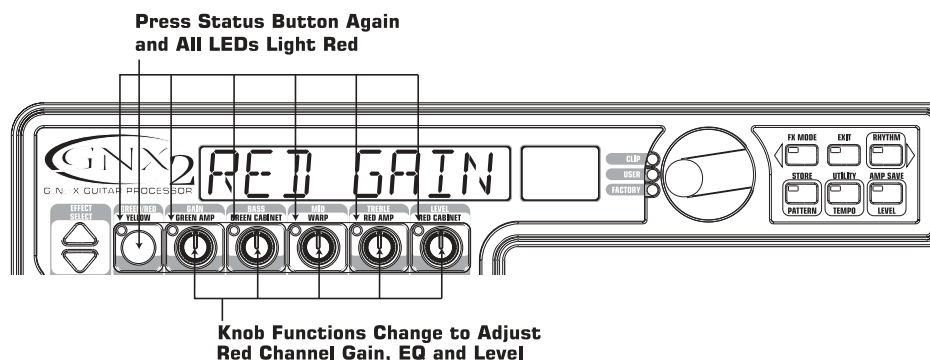

Tune the Cabinets (optional)

You may also want to adjust the resonance for the American 2x12 and the British 4x12 Cabinets. To access the Cabinet tuning for both Red and Green Channels, press and hold the **STATUS** button until the display reads *CAB TUNE* (Cabinet Tuning). Release the Status button and rotate the Number 2 knob to adjust the tuning for the Green Cabinet (*GTUNE 00*) and the Number 5 knob to adjust the tuning for the Red Cabinet (*RTUNE 00*). Once the tuning of both Cabinets has been adjusted, press the **STATUS** button to return to Performance mode.

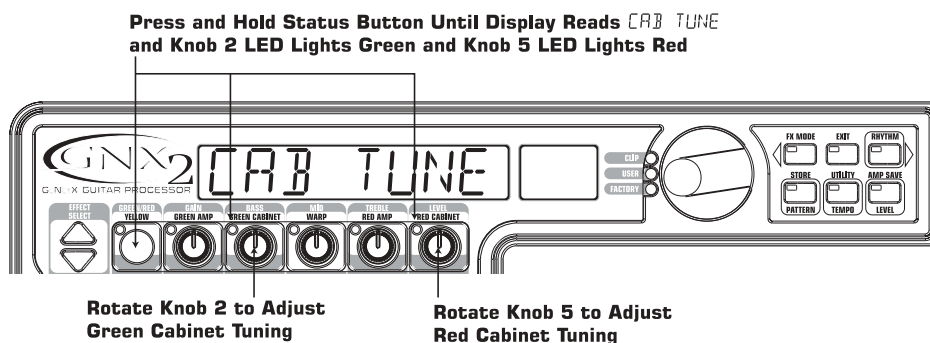

Warp the Green and Red Channels Together

When the Amps and Cabinets in our Green and Red Channels are dialed in to suit our taste, we can Warp their characteristics together to create a new HyperModel™. Make sure your GNX2 is in yellow mode (indicated by the yellow lit Status LED). If it is not in yellow mode, press the Status button until the Status LED turns yellow. Then rotate the Number 3 (Warp) knob to blend the Amps and Cabinets in our Green and Red Channels.

Save the HyperModel™

Now that we have designed our own Amp/Cabinet HyperModel™, we need to save it to one of the 9 User HyperModel™ locations. This allows us to use it in presets. Press the **AMP SAVE** button until the display reads *NEW AMP* and the first letter (*N*) is flashing. For this example, let's name the HyperModel™ "Rectweed" (Rectified Tweed). Rotate the **DATA WHEEL** to select R as the first letter. Then press the **RHYTHM** button to select the next character in the display. Continue using the Data Wheel and Rhythm button until the display reads *RECTWEED*.

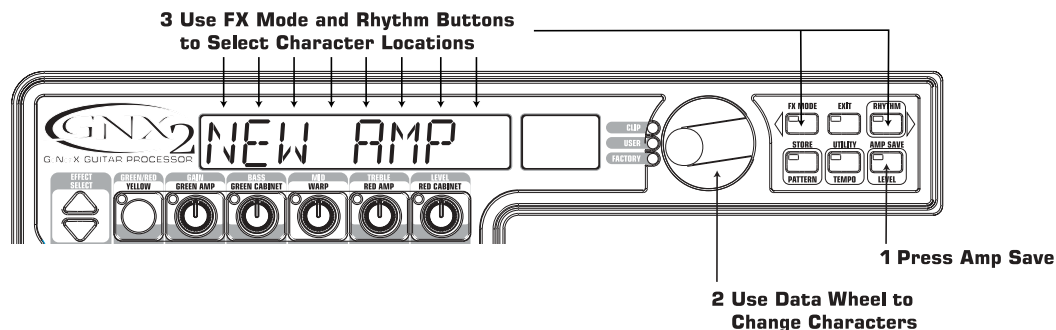

When the display reads *RECTWEED*, press the **AMP SAVE** button again. Now we need to choose one of the 9 User HyperModel™ locations. The alpha-numeric display should read *EMPTY* (Empty) and the red numeric display should read *01* if this is the first HyperModel™ stored to your GNX2. Press the **AMP SAVE** button again to save to this Amp location. The display briefly reads *AMP SAV* (Amp Saved) and then returns to the name of the selected preset.

Tutorial

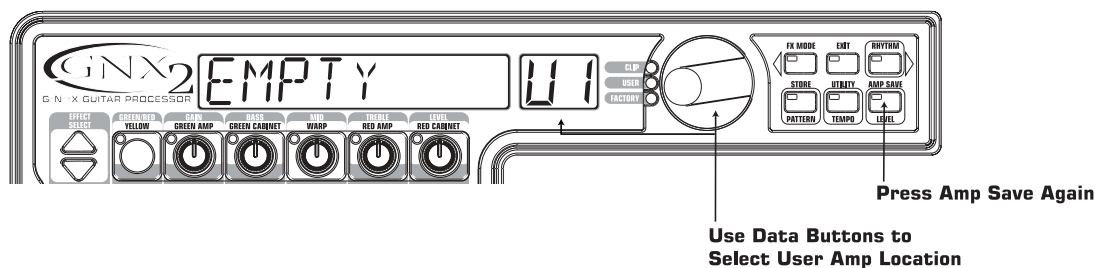

Select Models for the Preset's Channels

In the previous steps, we selected a Tweed for the Green Channel and a Rectified Model for the Red Channel. Then we Warped the two together to create our HyperModel™. This HyperModel™ is saved as an amp type that we named Rectweed, but it is not currently part of our preset. In this example preset, we need to be able to toggle between an acoustic guitar simulation and our new HyperModel™. To do this we need to select the Acoustic model for the Green Channel and Rectweed for the Red Channel of our preset. The LED next to the Status button should be yellow. If it is not, press **EXIT**. Now rotate the Number 1 knob until the display reads *ACOUSTIC*. This is the Green Channel Model for the preset. Rotate the Number 4 knob until the display reads *RECTWEED* (our new HyperModel™). This is the Red Channel Model for the preset. This lets us toggle between these two sounds using the Amp Footswitch (when FX Mode is active).

Edit the Preset

The next step to creating our example preset requires entering the Effect Edit mode. To do this, press the **EFFECT SELECT DOWN** button. The Matrix LED in the Wah-Pickup row lights. The display briefly reads *EDIT* and then cycles between the status of the Wah and Pickup Simulator effects. If the red display reads on *WAH ON*, press the **STATUS** button once to turn it off (since our example is not using a Wah).

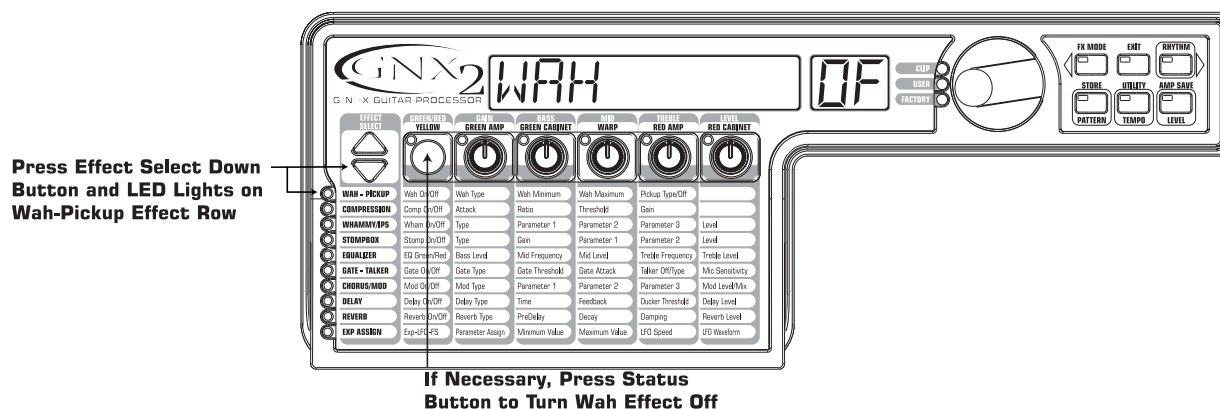

Select the Pickup Type

In our example preset we are using a single coil pickup, but want it to sound like a double coil humbucker. With the Wah-Pickup LED lit, rotate the Number 4 knob until the display reads *SC HUMB*. This makes a single coil sound like a Humbucker.

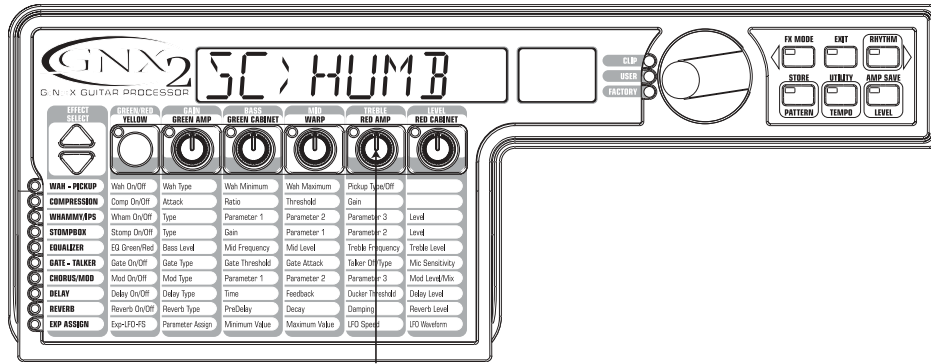

Rotate Number 4 Knob Until
Display Reads SC: HUMB

Turn the Compressor Off

We don't want to use compression in our preset so, we need to turn the compressor off. Press the **EFFECT SELECT DOWN** button. The Compressor LED lights and the display shows the current status of the Compressor. If the Compressor is on, press the **STATUS** button until the red display reads off (⏏).

Turn the Whammy™/IPS Off

We don't want any Whammy™ or IPS effects in this preset. Press the **EFFECT SELECT DOWN** button, and the Whammy/IPS LED is lit. If the display indicates that either one of these effects is active, press the **STATUS** button until the Display reads off (⏏).

Turn the Stompbox Modeling Off

We don't want any Stompbox Modeling in this preset. Press the **EFFECT SELECT DOWN** button, and the Stompbox LED is lit. If the display indicates that it is active, press the **STATUS** button until the Display reads off (⏏).

Adjust the EQ

The EQ for both the Acoustic Model (Green Channel) and the Rectweed HyperModel™ (Red Channel) can be adjusted individually. To adjust the EQ, press the **EFFECT SELECT DOWN** button, and the Equalizer LED lights. The GNX2 defaults to the Green Channel EQ adjustments. Therefore, the display briefly reads EQ GREEN. Rotate the Number 1 knob to adjust the Red Channels Bass enhancement. Rotate the Number 2 knob to select the center frequency for the Mid-range. Rotate the Number 3 knob to adjust the Mid-range enhancement. Rotate the Number 4 knob to select the center frequency for the Treble. Rotate the Number 5 knob to adjust the Treble enhancement. Press the **AMP** Footswitch to select the Red Channel's EQ adjustments. The display briefly reads EQ RED and the same knobs adjust the same EQ Parameters for the Green Channel.

Tutorial

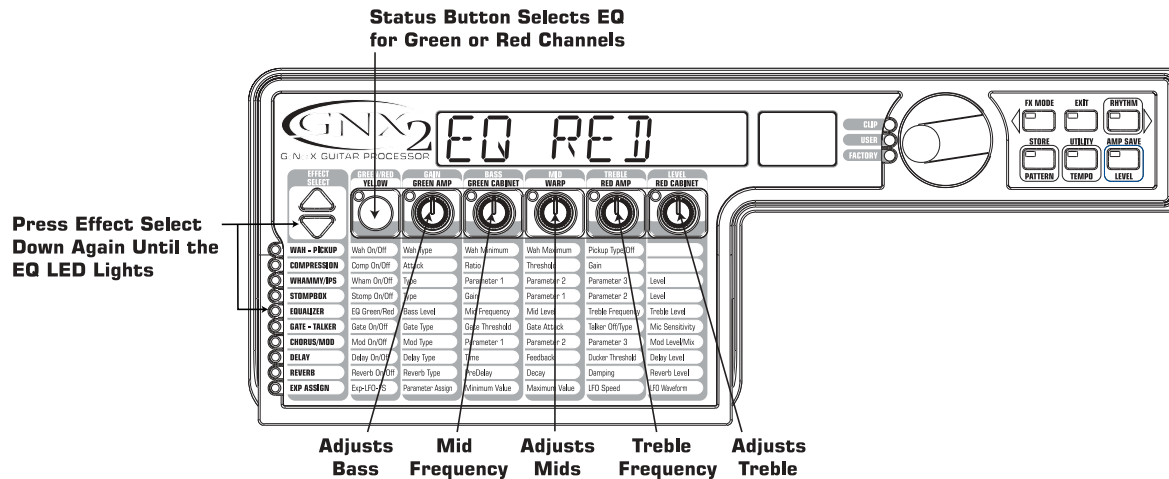

Adjust the Noise Gate

For our example, we want our Noise Gate to open quickly with a relatively weak signal. This type of gate uses the Silencer™ with a low Threshold and short Attack Time. Press the **AMP FOOTSWITCH** to select the Red Amp Channel. Press the **EFFECT SELECT DOWN** button and the Noise Gate's LED lights. If the display reads off (OFF), press the **STATUS** button until the display reads on (ON). Rotate the Number 1 knob until the display reads **SILENCER** for the type of gate. Rotate the Number 2 knob to set the Threshold to 20 (this may need to be adjustment depending upon your guitar). Rotate the Number 3 knob to set the Attack Time to 0 (fast attack).

Turn the Talker™ Off

In our example preset we don't want the Talker™ effect to be used. With the Gate - Talker LED lit, rotate the Number 4 knob until the display reads **TALK OFF**. This will turn off the Talker™.

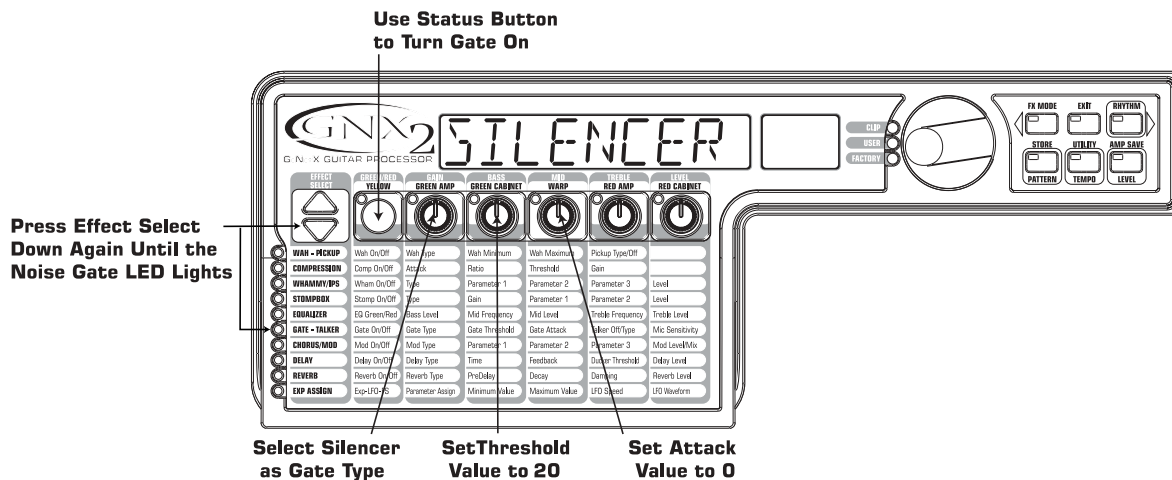

Select and Adjust the Chorus

Next we wanted to thicken up the sound in our preset by adding a subtle Chorus effect. Press the **EFFECT SELECT DOWN** button again and the LED in the Chorus/Mod row lights. If the display reads off (OFF), press the **STATUS** button until the Display reads on (ON). Then rotate the Number 1 knob until the display reads **CHORUS** for the effect type. Rotate the Number 2 knob to set the Chorus Speed to 5. Rotate the Number 3 knob to set the Chorus Depth to 30. Rotate the Number 5 knob to set the Chorus Level to 50.

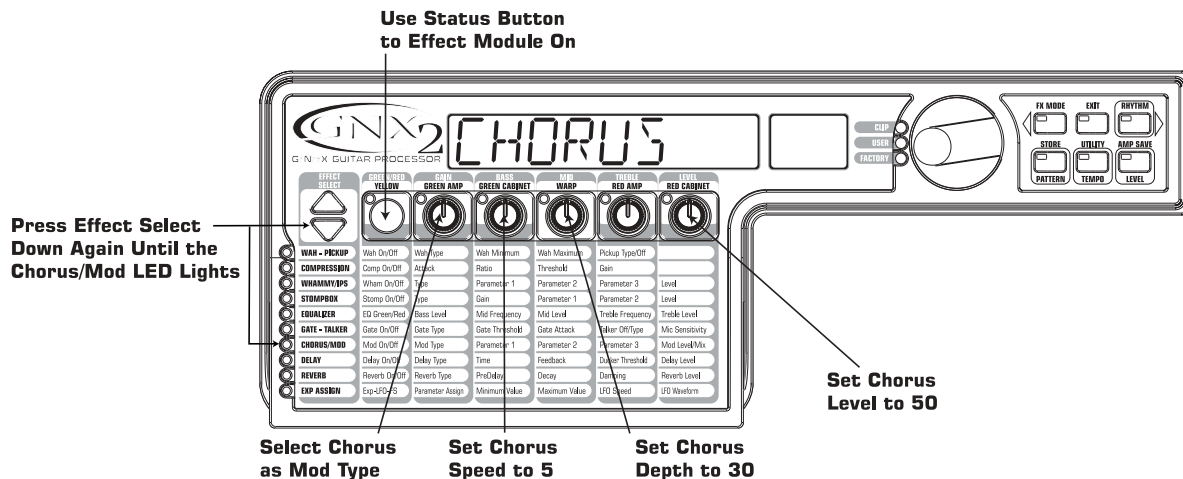

Turn the Delay Off

In our example preset we want to bypass the Delay. Press the **EFFECT SELECT DOWN** button again and the LED in the Delay row will light. If the display reads on (ON), press the **STATUS** button until the display reads off (OFF).

Select and Adjust the Reverb

In our example preset we wanted a little bit of Hall Reverb to provide some ambience. Press the **EFFECT SELECT DOWN** button again and the LED in the Reverb row lights. If the display reads off (OFF), press the **STATUS** button until the display reads on (ON). Rotate the Number 1 knob to select Hall (HALL) for the Reverb Type. Rotate the Number 2 knob to set the Reverb PreDelay to 2. Rotate the Number 3 knob to set the Reverb Decay to 15. Rotate the Number 4 knob to set the Reverb Damping to 40. Rotate the Number 5 knob to set the Reverb Level to 30.

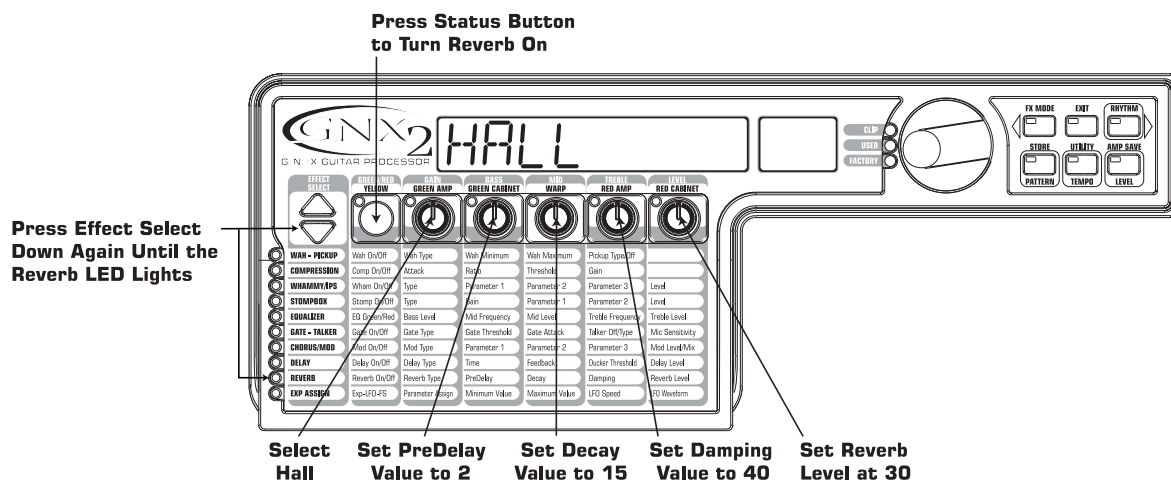

Store the Preset

The last step, is to store our changes to a User Preset. If we changed presets or turned the GNX2 off without storing these settings, it would forget what we had done and revert back to the original preset. To store the preset, press **STORE**. The first letter in the Display begins to flash. Since this is an example preset, let's name the preset **EXAMPLE**. Rotate the **DATA WHEEL** until the flashing character in the display is an E. Press the **RHYTHM** button once and the second character begins to flash. Use the Data Wheel again until the flashing character is an X. Continue using the Rhythm button to select the character location and the Data Wheel to change the characters.

Tutorial

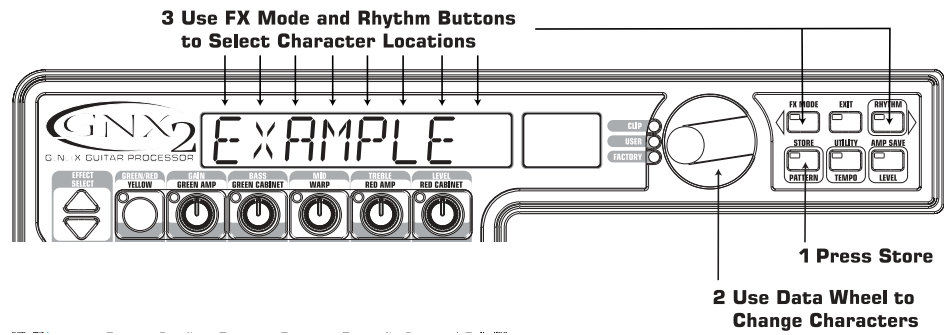

Once the Display reads **EXAMPLE**, press **STORE** again. The numbers in the red numeric display are flashing. Using the Data Wheel, select 64 as the destination. Press **STORE** once more to save the preset.

Congratulations! You have successfully created a Preset.

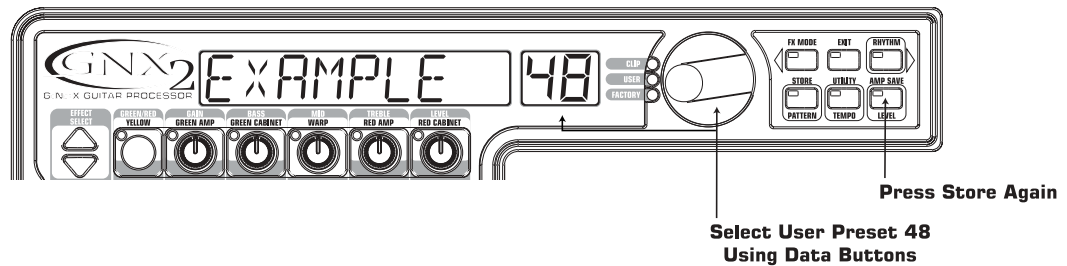

Other Functions

Expression Pedal

The Expression Pedal on the GNX2 can control up to 3 parameters in real time including the Volume, Whammy™, and Ya Ya™. When a parameter has been assigned to the Expression Pedal, the parameter's minimum and maximum values can also be programmed. The GNX2's Expression Pedal includes DigiTech's exclusive V-Switch. The V-Switch allows you to switch the Expression Pedal assignment on the fly. Applying extra pressure to the toe of the Expression Pedal engages the V-Switch and the Expression Pedal switches between the assigned parameter and Wah. The sensitivity or amount of pressure required to engage the V-Switch can be adjusted to suit your personal taste (or weight of your foot). See page 40 for the V-Switch Sensitivity adjustment procedure.

The procedure for assigning a parameter to the Expression Pedal is as follows:

1. Press the **EFFECT SELECT** button until the Exp Assign row has been selected.
2. Press the **STATUS** button until the display reads *EXP PDL1* (Expression Pedal Link 1), *EXP PDL2* (Expression Pedal Link 2), or *EXP PDL3* (Expression Pedal Link 3), depending upon which assignment you want to use or the number of parameters you intend to assign. The display will alternate between the Expression Pedal selection and the assigned parameter.
3. Rotate the Number 1 knob until the parameter appears in the display. See the Expression Parameter Assignment List on page 38 for a complete list of assignable Parameters.
4. Rotate the Number 2 knob to select the minimum value the parameter reaches with the Expression Pedal in the toe up position (not available when volume is the assigned parameter).
5. Rotate the Number 3 knob to select the maximum value the parameter reaches with the Expression Pedal in the toe down position (not available when volume is the assigned parameter).
6. Store your Expression Pedal assignment to your preset. See page 16 for more information on the storing procedure.

LFOs

The GNX2 includes two low frequency oscillators (LFO1 and LFO2) that can be assigned to the Expression Pedal parameters. A low frequency oscillator automatically varies the value of the assigned parameter at a steady rate. A minimum and maximum value can also be assigned. For instance: if the Amp Gain was assigned to LFO1, and the minimum value was set at 1 and the maximum value was set at 99, the GNX2 would automatically sweep the amount of distortion from clean to distorted and back to clean. Individual LFO speeds can also be assigned. In the previous example, the LFO speed would determine the length of time it took the LFO to sweep from the clean to the distorted sound. The procedure for assigning the LFOs in the GNX2 is as follows:

1. Press either **EFFECT SELECT** button until the Exp Assign row is selected.
2. Press the **STATUS** button to assign LFO1 (*LFO 1*) or LFO2 (*LFO 2*).
3. Rotate the Number 1 knob until the Parameter is displayed. See the Expression Parameter Assignment list on page 38 for a complete list of assignable Parameters.
4. Rotate the Number 2 knob to select the minimum value the assigned parameter reaches at the bottom turn around point for the LFO (not available when volume is the assigned parameter).
5. Rotate the Number 3 knob to select the maximum value the assigned parameter reaches at the top turn around point for the LFO (not available when volume is the assigned parameter).
6. Rotate the Number 4 knob to select the speed that the LFO oscillates from the minimum to the maximum values. LFO speed ranges from (*05 HZ*) to 10 Hz (*100 HZ*).
7. Rotate the Number 5 knob to select the waveform the LFO oscillates on. Your choices include:

Other Functions

TRIANGLE (Triangle) - a smooth rise and fall, but abrupt turn around in oscillation.

SINE (Sine) - a smooth rise, fall, and turn around in oscillation.

SQUARE (Square) - an abrupt rise, fall, and turn around in oscillation.

8. Store your LFO assignment to your preset. See page 16 for more information on the storing procedure.

Amp Footswitch

From the factory, the Amp Footswitch switches between the Green and the Red Amp Channels. However, the GNX2 allows you to select the Amp Footswitch function. The procedure for assigning the function of the Amp Footswitch is as follows:

1. Press either **EFFECT SELECT** button until the Exp Assign row is selected.
2. Press the **STATUS** button until the display reads *AMP FS* (Amp Footswitch).
3. Rotate the Number **1** knob to select the Amp Footswitch function. Your choices include:
 - G-R* - Switches between the Green and Red Amp Channels.
 - G-Y* - Switches between the Green and Yellow (Warped) Channels.
 - R-Y* - Switches between the Red and Yellow (Warped) Channels.
 - G-R-Y* - Switches between the Green, Red, and Yellow (Warped) Channels.
4. Store your Amp Footswitch assignment to your preset. See page 16 for more information on the storing.

Expression Parameter Assignment List

The following Parameters can be assigned to the any of the 3 Expression Pedal links, LFO 1, or LFO 2.

NO LINK (No Link) - No Parameter is assigned

COMPATTAK (Compressor Attack) - Controls the Compressor's Attack time.

COMP RATIO (Compressor Ratio) - Controls the Compressor's Ratio.

COMP THRESH (Compressor Threshold) - Controls the Compressor's Threshold.

COMP GAIN (Compressor Gain) - Controls the Compressor's Gain.

AMOUNT/SHIFT (Parameter 1) - Controls the interval for the IPS module.

WHAM PDL (Whammy™ Parameter 2) - Controls the pitch bend when Whammy™ is engaged.

KEY (IPS Parameter 3) - Controls the key type when the IPS module is engaged.

SCALE (IPS Parameter 2) - Controls the scale when the IPS module is engaged.

IPS MIX/IPS LVL (Wham/IPS Mix/Level) - Controls the wet/dry mix or Level for the IPS module.

Stompbox Effect Parameters

Screamer	<i>DRIVE</i>	<i>TONE</i>	<i>LEVEL</i>			
Rodent	<i>DIST</i>	<i>FILTER</i>	<i>VOLUME</i>			
DS Dist	<i>DIST</i>	<i>TONE</i>	<i>LEVEL</i>			
DOD 250	<i>GAIN</i>	<i>LEVEL</i>				
Big MP	<i>SUSTAIN</i>	<i>TONE</i>	<i>VOLUME</i>			
Guy OD	<i>DRIVE</i>	<i>LEVEL</i>				
Sparkdrv	<i>GAIN</i>	<i>TONE</i>	<i>CLEAN</i>	<i>VOLUME</i>		
Grunge	<i>GRNGGAIN</i>	<i>BUTT</i>	<i>FACE</i>	<i>LOUD</i>		
Fuzzy	<i>FUZZ</i>	<i>VOLUME</i>				
Zone	<i>DIST</i>	<i>MID FREQ</i>	<i>MID LVL</i>	<i>LOW</i>	<i>HIGH</i>	<i>LEVEL</i>

AMP CHAN (Amp Channel) - Switches Amp Channels.

AMP WARP (Amp Warp) - Warps the Green and Red Amp Models.

CAB WARP (Cabinet Warp) - Warps the Green and Red Cabinet types.

WARP (Warp) - Warps the Green and Red Channels.

Other Functions

- GRN GAIN* (Green Gain) - Controls the Amp Gain for the Green Channel.
- GRN LVL* (Green Level) - Controls the Volume of the Green Channel.
- RED GAIN* (Red Gain) - Controls the Amp Gain for the Red Channel.
- RED LVL* (Red Level) - Controls the Volume of the Red Channel.
- GATTHRES* (Gate Threshold) - Controls the Noise Gate's Threshold.
- GATATTAK* (Gate Attack) - Controls the Noise Gate's Attack time.
- PLKSENS* (Gate Pluck) - Controls the Noise Gate's Pluck Sensitivity.

Modulation Effects Parameters

Active Effect

Chorus	<i>SPEED</i>	<i>DEPTH</i>	<i>PREDLY</i>	<i>MOD BAL</i>	<i>MOD LVL</i>
Flanger	<i>SPEED</i>	<i>DEPTH</i>	<i>REGEN</i>	<i>MOD BAL</i>	<i>MOD MIX</i>
Phaser	<i>SPEED</i>	<i>DEPTH</i>	<i>REGEN</i>	<i>MOD BAL</i>	<i>MOD MIX</i>
Triggered Flanger	<i>SPEED</i>	<i>SENSIV</i>	<i>LFO ST</i>	<i>MOD MIX</i>	
Triggered Phaser	<i>SPEED</i>	<i>SENSIV</i>	<i>LFO ST</i>	<i>MOD MIX</i>	
Tremolo	<i>SPEED</i>	<i>DEPTH</i>			
Panner	<i>SPEED</i>	<i>DEPTH</i>			
Vibrato	<i>SPEED</i>	<i>DEPTH</i>			
Rotary Speaker	<i>SPEED</i>	<i>DEPTH</i>	<i>DOPPLER</i>	<i>CROSSOVER</i>	<i>MODBAL MOD MIX</i>
Auto Ya™	<i>SPEED</i>	<i>DEPTH</i>	<i>RANGE</i>	<i>MOD BAL</i>	<i>MOD MIX</i>
YaYa™	<i>YA PDL</i>	<i>DEPTH</i>	<i>RANGE</i>	<i>MOD BAL</i>	<i>MOD MIX</i>
SynthTalk	<i>ATTACK</i>	<i>RELEASE</i>	<i>VOL</i>	<i>MOD BAL</i>	<i>SENSIVITY</i>
Envelope Filter	<i>SENSIVITY</i>	<i>RANGE</i>	<i>MOD BAL</i>	<i>MOD MIX</i>	
Detune	<i>AMOUNT</i>	<i>MOD BAL</i>	<i>MOD LVL</i>		
Pitch Shift	<i>SHIFT</i>	<i>MOD BAL</i>	<i>MOD LVL</i>		

- DLY FDBK* (Delay Feedback) - Controls the amount of Delay Feedback.
- DLKTHRES* (Delay Threshold) - Controls the Ducker Threshold for the Delay.
- DLK ATTN* (Ducker Attenuation) - Controls the attenuation level applied to the Delay signal when the Ducker Threshold is exceeded.
- DLY LVL* (Delay Level) - Controls the Mix Level of the selected Delay Type.
- DLY BAL* (Delay Balance) - Controls the left/right balance of the selected Delay Type.
- RVB PRE* (Reverb Predelay) - Controls the Reverbs Predelay time.
- RVB DECAY* (Reverb Decay) - Controls the Reverbs Decay time.
- RVB LVL* (Reverb Level) - Controls the Reverbs Mix Level.
- RVB BAL* (Reverb Balance) - Controls the left/right balance of the selected Reverb Type.
- VOL PRE* (Volume Pre) - Controls the Volume after the Amp Modeling but before the Effects.
- VOL POST* (Volume Post) - Controls the Volume at the end of the Effects chain.
- LFO1 SPD* (LFO 1 Speed) - Controls the modulation speed of Expression LFO 1.
- LFO2 SPD* (LFO 2 Speed) - Controls the modulation speed of Expression LFO 2.

Utilities

The Utility section contains all of the menus for assigning global functions to the GNX2. Global functions affect the GNX2 in its entirety rather than on a per preset basis. The Utility menus include: Mono/Stereo Output, Target System Setup, Volume Pedal Update, V-Switch Threshold, Expression Pedal Calibration, Dry Track Enable, Bank Naming, MIDI Channel, MIDI Sysex Dumps, Amp Dumps, MIDI Mapping, MIDI Merge, and Factory Reset. To enter the Utility section, press the Utility button. Once in the Utility menu, the Rhythm button selects the next menu (scrolls to the right), and the FX Mode button selects the previous menu (scrolls to the left). Each of these Utility menus is described in more detail in the following pages.

Other Functions

Mono/Stereo Output

The GNX2 needs to be set to stereo or mono mode. In Stereo mode, the GNX2 produces a wide stereo image when the Right and Left Outputs are connected to two different amplifiers. In Mono mode, the same signal appears at the Left and Right Outputs. The procedure for selecting the output mode is as follows:

1. Press the **UTILITY** button. The Utility button's LED lights indicating you are in the Utility section.
2. Using the **FX MODE** or **RHYTHM** buttons, scroll to the left or right until *STEREO*, or *MONO* is displayed as the active output mode.
3. Use the **DATA WHEEL** to select the output mode.
4. Press **EXIT** to return to the GNX2 presets.

Target System Setup

The GNX2 can be connected to any type of amplification system. However, the signal requirement changes depending upon the type of amplification system. The Target System Setup optimizes the GNX2 for the type of amplification system it will be used with. The procedure for selecting the Target System is as follows:

1. Press the **UTILITY** button. The Utility button's LED lights indicating you are in the Utility section.
2. Using the **FX MODE** or **RHYTHM** button, scroll to the left or right until one of the following target listings is displayed

<i>DIRECT</i> For direct to console applications	<i>FXLP2x12</i> Input into the effect return of a 2x12 combo
<i>INPT1x12</i> Instrument input of a 1x12 combo amp	<i>INPT4x12</i> Instrument input of a 4x12 combo
<i>FXLP1x12</i> Input into the effect return of a 1x12 combo	<i>FXLP4x12</i> Input into the effect return of a 4x12 combo
<i>INPT2x12</i> Instrument input of a 2x12 combo amp	

3. Rotate the **DATA WHEEL** to select the type of amplification system to be used.
4. Press **EXIT** to return to the GNX2 presets.

Volume Pedal Update

The GNX2 provides the option of selecting the Expression Pedal's position to be updated after changing presets when it is linked to the Volume Parameter. This feature lets you change presets and keep the volume level from the previous preset, if the Expression Pedal controls the volume for both presets. If this feature is disabled, new presets are set to the volume level value stored with the preset. The procedure for enabling or disabling the Volume Pedal Update is as follows:

1. Press the **UTILITY** button. The Utility button's LED lights indicating you are in the Utility section.
2. Using the **FX MODE** or **RHYTHM** button, scroll to the left or right until *VOLUME PEDAL UPDATE* (Volume Pedal Update) is displayed.
3. Rotate the **DATA WHEEL** to select *ON* (enabled), or *OFF* (disabled).
4. Press **EXIT** to return to the GNX2 presets.

V-Switch Threshold

Applying extra pressure to the toe of the Expression Pedal engages a feature called V-Switch. V-Switch is used to alternate between controlling assigned Parameter(s) with the pedal, and using the pedal as a Wah pedal. The sensitivity of the V-Switch can be set to the amount of pressure you want to use. The following steps explain how to set the V-Switch threshold:

Other Functions

1. Press the **UTILITY** button. The Utility button's LED lights indicating you are in the Utility section.
2. Using the **FX MODE** or **RHYTHM** buttons, scroll to the left or right until **V SWITCH** (V-Switch).is displayed
3. Rotate the **DATA WHEEL** to select the threshold setting. Ranges from 1 to 99 (with 99 requiring more pressure to engage). The sensitivity may be auditioned while making adjustments. Depending on the status of the Wah the display reads either **WAH ON**, or **WAH OFF** as the V-Switch engages and disengages.
4. Press **EXIT** to return to the GNX2 presets.

Expression Pedal Calibration

The Expression Pedal on the GNX2 needs to be recalibrated for use after a factory reset has been performed. This calibration procedure is automatically activated after a factory reset procedure. In the event the pedal's calibration fails, or if the pedal does not function properly, it can be re-calibrated using the Pedal Calibration menu. The procedure for Calibrating the Expression Pedal is as follows:

1. Press the **UTILITY** button. The Utility button's LED lights indicating you are in the Utility section.
2. Using the **FX MODE** or **RHYTHM** buttons, scroll to the left or right until **PEDALCAL** is displayed.
3. Press the blinking **STORE** button to enter the Pedal Calibration Menu. The display reads **TOE DN** (Toe Down).
4. Rock the Expression Pedal all the way forward to the toe down position and press the blinking number **2 Footswitch**. The display changes to read **TOE UP** (toe up).
5. Rock the Expression Pedal all the way back to the toe up position and press the blinking number **3 Footswitch**. **V SWITCH** is displayed and allows you to adjust the V-Switch threshold.
6. Rock the Expression Pedal forward and apply the V-Switch pressure to the toe of the pedal. If further adjustment to the threshold is required, use the Data Wheel to select the threshold.

Note: If the Display shows ERROR, an error has occurred and steps 2 through 5 should be repeated.

7. Press **EXIT** to return to the GNX2 presets.

Bank Names

The GNX2 lets you customize the names of the 16 User Banks where the 64 User presets reside. Customized Bank names aids in quickly identifying the User Bank containing the presets you may need for a particular song or set. The procedure for naming the User Banks is as follows:

1. Press the **UTILITY** button. The Utility button's LED lights indicating you are in the Utility section.
2. Using the **FX MODE** or **RHYTHM** buttons, scroll to the left or right until **BANKS** is displayed.
3. Use the **DATA WHEEL** to select the User Bank you want to rename.
4. Press **STORE** to access the naming menu. The far left character of the Bank name begins to blink.
5. Use the **DATA WHEEL** to select the desired alpha-numeric character.
6. Press the **RHYTHM** button to select the next character to the right, and the **FX MODE** button to select the previous character to the left.
7. Repeat steps 5 and 6 until the Bank name appears in the display.
8. Once the Bank name appears correctly in the display, press **STORE** again. **NAME SAV D** is displayed briefly indicating the Bank name has been saved, and then new Bank name appears.
9. Press **EXIT** to return to the GNX2 presets.

Other Functions

MIDI Channel

The GNX2 MIDI channel is only used for receiving incoming MIDI data. The GNX2 does not send MIDI program change commands or CC data. The procedure for selecting the MIDI channel is as follows:

1. Press the **UTILITY** button. The Utility button's LED lights indicating you are in the Utility section.
2. Using the **FX MODE** or **RHYTHM** buttons, scroll to the left or right until *MIDI CHANNEL* is displayed. The numeric display show the currently selected MIDI channel.
3. Rotate the **DATA WHEEL** to select the MIDI channel. Your choices include 1 through 16, ALL (all), and OFF (off).
4. Press **EXIT** to return to the GNX2 presets.

Bulk Dump

The Sysex Bulk Dump uploads all the GNX2 presets and utility data to a sysex librarian, or MIDI recording device. This is useful for making a backup copy of all your customized settings. The procedure for performing a Bulk Dump is as follows:

1. Connect a MIDI cable from the GNX2 MIDI Out to the the MIDI In of a MIDI recording device.
2. Press the **UTILITY** button. The Utility button's LED lights indicating you are in the Utility section.
3. Using the **FX MODE** or **RHYTHM** buttons, scroll to the left or right until *BULK DUMP* is displayed. The Store button blinks indicating it must be pressed to begin the bulk dump.
4. Set the MIDI recording device to record.
5. Press **STORE** to begin the dump. The display reads *SEND BULK* until the dump is complete at which time the display reads *BULK DUMP*.
6. Press **EXIT** to return to the GNX2 presets.

NOTE: The Bulk Dump sends information on the MIDI channel defined in the MIDI Channel menu.

MIDI Preset Dump

The Sysex Preset Dump uploads individual GNX2 presets to a sysex librarian, or MIDI recording device. This is useful for making a backup copy of customized presets, or loading your presets into another GNX2. The procedure for performing a Sysex Preset Dump is as follows:

1. Connect a MIDI cable from the GNX2 MIDI Out to the the MIDI In of a MIDI recording device or the MIDI in of another GNX2.
2. Press the **UTILITY** button. The Utility button's LED lights indicating you are in the Utility section.
3. Using the **FX MODE** or **RHYTHM** buttons, scroll to the left or right until *PRESET DUMP* (Preset Dump) is displayed.
4. Use the **DATA WHEEL** to select the preset number you want to dump.
5. Press **STORE**. The Display reads *SEND TO*.
6. Use the **DATA WHEEL** to select the destination preset number.
7. Set the MIDI recording device to record.
8. Press **STORE** again. The display reads *SEND PST* until the dump is complete at which time the display briefly reads *DONE* before it returns to *PRESET DUMP*.
9. Press **EXIT** to return to the GNX2 presets.

The Preset Dump sends information on the MIDI channel defined in the MIDI Channel menu.

NOTE: The Preset Dump sends information on the MIDI channel defined in the MIDI Channel menu.

User Amp Dump

User Amp Dump uploads the GNX2 Amp HyperModels™ to a sysex librarian, or MIDI recording device. This is useful for making a backup copy of your customized Amp HyperModels™, and loading your HyperModels™ into another GNX2. The procedure for performing a User Amp Dump is as follows:

1. Connect a MIDI cable from the GNX2 MIDI Out to the the MIDI In of a MIDI recording device or the MIDI in of another GNX2.
2. Press the **UTILITY** button. The Utility button's LED lights indicating you are in the Utility section.
3. Using the **FX MODE** or **RHYTHM** button, scroll to the left or right until *AMP DUMP* (Amp Dump) is displayed.
4. Use the **DATA WHEEL** to select the Amp number you want to dump.
5. Press **STORE**. The display reads *SEND TO*.
6. Use the **DATA WHEEL** to select the destination User Amp number.
7. Set the MIDI recording device to record.
8. Press **STORE** again. The display reads *SEND AMP* until the dump is complete at which time the display briefly reads *DONE* before it displays *AMP DUMP*.
9. Press **EXIT** to return to the GNX2 presets.

NOTE: The Amp Dump sends information on the MIDI channel defined in the MIDI Channel menu.

MIDI Mapping

MIDI Mapping allows access to all factory and user presets from external MIDI program change commands that may not correspond to the GNX2 preset. This is useful when multiple MIDI devices are chained together and controlled by one central unit. For example, the main MIDI controller can send out a program change command telling a particular MIDI unit to change to Program 10, but you may want the GNX2 to change to User Preset 27. You can remap the GNX2 so when it receives MIDI Program change 10, it calls up User Preset 27. The Procedure for mapping MIDI program changes is as follows:

1. Press the **UTILITY** button. The Utility button's LED lights indicating you are in the Utility section.
2. Using the **FX MODE** or **RHYTHM** buttons, scroll to the left or right until *MIDU* is displayed.
3. Use the **DATA WHEEL** to select the incoming MIDI program number you want to remap. Notice the flashing number to the right of the *M* increments and decrements as you turn the Data Wheel.
4. Press the **RHYTHM** button. Notice the number in the red numeric display begins flashing. This number represents the GNX2 preset number that is accessed when the GNX2 receives the MIDI program number shown to the right of the *M* in the alpha-numeric display.
5. Rotate the **DATA WHEEL** to select the preset number the GNX2 will use when it receives the selected MIDI program change.
6. Press **EXIT** to return to the GNX2 presets.

MIDI Merge

The MIDI Merge function echos the incoming MIDI data to the MIDI Out port of the GNX2. This is useful when multiple MIDI devices are chained together, and you want to pass incoming MIDI Data on to MIDI devices downstream from the GNX2. The procedure for enabling or disabling the MIDI Merge function is as follows:

1. Press the **UTILITY** button. The Utility button's LED lights indicating you are in the Utility section.
2. Using the **FX MODE** or **RHYTHM** buttons, scroll to the left or right until *MIDIMERGE* is displayed. The red numeric display reflects the current MIDI Merge status *ON* or *OFF*.
3. Rotate the **DATA WHEEL** to select the status.
4. Press **EXIT** to return to the GNX2 presets.

Other Functions

Digital Level

When plugging the GNX2's digital output into a recording device, it is important that the recording device gets as much signal as possible without being pushed into digital clipping. If there are cases where your recorder is not receiving enough level from the GNX2's digital output, you can boost it using the Digital Level option in the Utility menu. The procedure for adjusting the Digital Level is as follows:

1. Press the **UTILITY** button. The Utility button's LED lights indicating you are in the Utility section.
2. Using the **FX MODE** or **RHYTHM** buttons, scroll to the left or right until **DIGLEVEL** is displayed. The red numeric display reflects the current Digital Level.
3. Rotate the **DATA WHEEL** to increase or decrease the amount of Digital Level boost needed. Range is from 1-20..
4. Press **EXIT** to return to the GNX2 presets.

Dry Track

This feature is useful for recording dry guitar tracks with the intent of adding processing after the guitar tracks have been recorded. All effects can be monitored through the analog left/right and headphone outputs when Dry Track is enabled. Dry Track can tap the signal before or after the Mod Effects, Delay, and Reverb modules, or off the Input. With Dry Track 1 enabled, the signal delivered to the Digital Output signal includes processing from the Pickup Modeling module through the Noise Gate module. With Dry Track 2 enabled, the signal is tapped of the input jack and sent directly to the digital output. This lets you record an unprocessed signal that can be fed back into the input for the purpose of 're-amping' your signal through different amp models. If Dry Track is disabled, the signal is tapped off after all effects (same as the analog outputs). To access the Dry Track option:

1. Press the **UTILITY** button. The Utility button's LED lights indicating you are in the Utility section.
2. Using the **FX MODE** or **RHYTHM** buttons, scroll to the left or right until **DRYTRACK** (Dry Track) is displayed.
3. Rotate the **DATA WHEEL** to select **OFF** (disabled), **1** (Dry Track 1), or **2** (Dry Track 2).

Factory Reset

This function resets the GNX2 settings to its original factory settings. This procedure erases ALL custom user presets, utility settings, and recalibration of the Expression Pedal. The procedure for performing a Factory Reset is as follows:

NOTE: Performing this function will erase all user-programmed data. Be sure you want to erase the memory and start fresh before continuing with this procedure.

1. Press the **UTILITY** button. The Utility button's LED lights indicating you are in the Utility section.
2. Using the **FX MODE** or **RHYTHM** buttons, scroll to the left or right until **RESET** (Reset) is displayed.
3. Rotate the **DATA WHEEL** clockwise, until the display reads **NO YES** (No Yes) and NO is blinking.

NOTE: This procedure resets ALL user settings. Rotate the DATA WHEEL counterclockwise, or press EXIT while NO is blinking in the display to abort.

4. Press the **RHYTHM** button. Yes begins blinking in the display.
5. Press **STORE** to reset the GNX2. The display returns to the Reset screen.
6. Press **EXIT** to return to the GNX2 presets.

GENEDIT™ Editor/Librarian

The possibilities are endless when you install the GENEDIT™ Editor/Librarian software on your home computer. Before installing GENEDIT™ on your Mac or PC, connect the computer's MIDI output to the GNX2 MIDI input, and the GNX2 MIDI output to the computer's MIDI input. Then insert the GENEDIT™ CD ROM into the CD ROM drive on your computer, and follow the install instructions that appear on the screen.

PC

If the install instructions do not appear automatically after inserting the CD, select **RUN** from the Start menu, and double-click **SETUP.EXE** located on the CD ROM drive.

Mac

If the install instructions do not appear automatically after inserting the CD, double click the **CD** icon on your monitor. Double-click the **INSTALLER** icon and follow the installation instructions.

Appendix

Appendix

Preset List

Bank 1 (SHOWCASE)

1. HYBRID
2. CLNCHORS
3. 2CHUNK
4. BAD BASS

Bank 2 (GENETX)

5. WARP ME
6. BLAKBASS
7. MEAT X 2
8. GNX DIRT

Bank 3 (STARS)

9. ERIC J
10. CARLOS
11. KOBB
12. OLD EVH

Bank 4 (AMPS)

13. BASS MAN
14. MATCHED
15. VOXTOP
16. HIWATTAG

Bank 5 (BLUES)

17. BLUE DLY
18. BLUEBALL
19. TEX BLUE
20. GTRORGAN

Bank 6 (COUNTRY)

21. PICKEN
22. PDLSTEEL
23. A MIXLDN
24. HODOWN

Bank 7 (ROCK)

25. MO WAH
26. FAZE OUT
27. THICKRER
28. WARM PIE

Bank 8 (CLEAN)

29. ACOUSTIC
30. COMP CLN
31. WARM CLN
32. CLEANEXP

Bank 9 (METAL)

33. RECTIFY
34. SOLO
35. WHAMMY
36. THE ZONE

Bank 10 (STUDIO)

37. STACKED
38. VOLSWELL
39. BIG DUCK
40. FATBOY

Bank 11 (JAZZ)

41. JAZZY
42. 5THS
43. FUSOLO
44. JAZZDRIV

Bank 12 (VINTAGE)

45. SURFIN
46. FUZZO
47. TREMBO
48. HILLBLLY

Bank 13 (FUNK)

49. CLEANWAH
50. FUNKPHAS
51. ENVELOPE
52. FUNKLEAD

Bank 14 (HYBRID)

53. BLAKFUZZ
54. TUNE CAB
55. AUTOWARP
56. CLNCRNCH

Bank 15 (EXPRESSION)

57. PDL SYNTH
58. ROTARY
59. YAYA
60. MO SLIDE

Bank 16 (SPECIAL)

61. STUTTER
62. TRIPLET
63. DIVEBOMB
64. RIFMATIC

MIDI CC List

Parameter	CC#	Parameter	CC#
Pickup Type/Off	CC 1	Amp Morph	CC 79
		Cabinet Morph	CC 80
Wah On/Off	CC 2	Amp/Cabinet Morph	CC 81
Wah Type	CC 3		
Wah Minimum	CC 4	Gate On/Off	CC 50
Wah Maximum	CC 5	Gate Type	CC 51
Wah Pedal	CC 6	Gate Threshold	CC 52
		Gate Attack	CC 53
Comp On/Off	CC 8	Gate Pluck	CC 54
Comp Attack	CC 9		
Comp Threshold	CC 10	Talker Type	CC 82
Comp Ratio	CC 11	Talker Sensitivity	CC 83
Comp Gain	CC 12		
		Effect On/Off	CC 55
IPS On/Off	CC 13	Effect Type	CC 56
IPS Type	CC 14	Effect Level	CC 57
IPS Level	CC 15	Effect Param 1	CC 58
IPS Param 1	CC 16	Effect Param 2	CC 59
IPS Param 2	CC 17	Effect Param 3	CC 60
IPS Param 3	CC 18	Effect Param 4	CC 61
Whammy Pedal	CC 19	Effect Param 5	CC 62
Stompbox On/Off	CC 84	Delay On/Off	CC 63
Stompbox Type	CC 85	Delay Type	CC 120
Stompbox Gain	CC 86	Delay Level	CC 65
Stompbox Level	CC 87	Delay Time (Coarse)	CC 66
Stompbox Param 1	CC 88	Delay Time (Fine)	CC 67
Stompbox Param 2	CC 89	Delay Feedback	CC 68
Stompbox Param 3	CC 90	Ducker Threshold	CC 69
Stompbox Param 4	CC 91	Ducker Attenuation	CC 70
		Delay Balance	CC 71
Amp Channel (FS)	CC 20		
		Reverb On/Off	CC 72
Green Amp Type	CC 22	Reverb Type	CC 73
Green Amp Gain	CC 23	Reverb Level	CC 74
Green Amp Level	CC 24	Reverb Decay	CC 75
Green Cab Type	CC 25	Reverb Damping	CC 76
Green Cab Tuning	CC 26	Reverb PreDelay	CC 77
Green Bass Level	CC 29	Reverb Balance	CC 78
Green Mid Freq (Coarse)	CC 30		
Green Mid Freq (Fine)	CC 31	Volume Pre	CC 7
Green Mid Level	CC 32	Volume Post	CC92
Green Treble Freq (Coarse)	CC 33		
Green Treble Freq (Fine)	CC 34	LFO 1 Speed	CC 105
Green Treble Level	CC 35	LFO 1 Waveform	CC 106
		LFO 2 Speed	CC 110
Red Amp Type	CC 36	LFO 2 Waveform	CC 111
Red Amp Gain	CC 37		
Red Amp Level	CC 38		
Red Cab Type	CC 39		
Red Cab Tuning	CC 40		
Red Bass Level	CC 43		
Red Mid Freq (Coarse)	CC 44		
Red Mid Freq (Fine)	CC 45		
Red Mid Level	CC 46		
Red Treble Freq (Coarse)	CC 47		
Red Treble Freq (Fine)	CC 48		
Red Treble Level	CC 49		

Appendix

MIDI Implementation

Function	Transmitted	Received	Remarks
MIDI Channel	1 - 16	1 - 16	
Mode	X	2, 4	
Note Number	X	X	
Velocity	X	X	
After Touch	X	X	
Pitchbend	X	X	
Control Change	X	0 - 127	See MIDI CC List
Program Change	O	0 - 128	
System Exclusive	O	O	
System Common			
Song Position:	X	X	
Song Select:	X	X	
Tune:	X	X	
System Real Time			
Clock:	X	X	
Commands:	X	X	
Aux Messages	X	X	

Mode 2: Omni On, Mono
Mode 4: Omni Off, Mono

O: Yes
X: No

Specifications

A/D Converter: 24 bit
D/A Converter: 24 bit
Sampling Frequency: 44.1 kHz

DSP Section:

Dual Audio DNA™ DSP architecture

Connections:

Guitar Input and Outputs: 1/4" TS
Jam-A-Long/Learn-A-Lick: 1/8" Stereo TRS
Mic Input and Output: Balanced XLR
Headphone: 1/4" Stereo TRS
MIDI: In and Out/Thru
S/PDIF Output: RCA connector

General:

Frequency Response: 20 Hz. – 20 kHz. +0, -3 dB
S/N ratio: > 97dB; ref = max signal, 22kHz measurement bandwidth.
Total Harmonic Distortion: Less than 0.04% (1kHz).
Memory Capacity: 64 Factory Presets, 64 User Presets

Power Requirements:

US and Canada: 120 VAC, 60 Hz Adapter: PSS3-120
Japan: 100 VAC, 50/60 Hz Adapter: PSS3-100
Europe: 230 VAC, 50 Hz Adapter: PSS3CE-230
UK: 240 VAC, 50 Hz Adapter: PSS3-240

Power Consumption: 23 watts
Dimensions: Length 17.5" Width 9" Height 3"
Unit Weight: 7.8 lbs.

Block Diagram

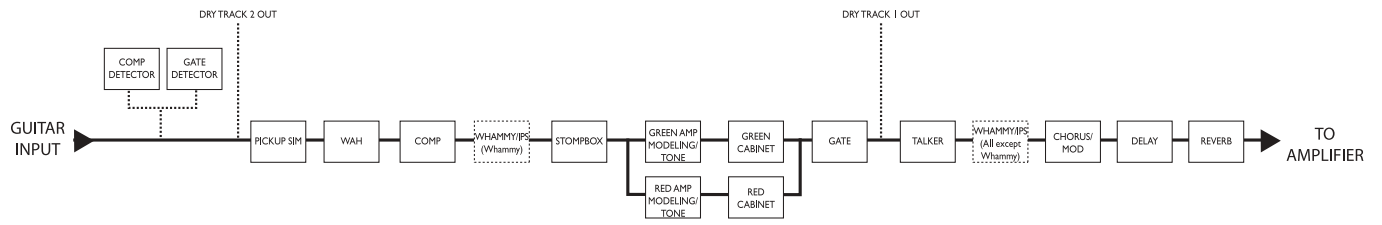

DIGITECH

**8760 S. SANDY PARKWAY
SANDY, UTAH 84070**

PH (801) 566-8800 FAX (801) 566-7005

INTERNATIONAL DISTRIBUTION

**8760 S. SANDY PARKWAY
SANDY, UTAH 84070 USA**

PH (801) 566-8800 FAX (801) 566-7005

**DIGITECH, GeNETX, AUDIO DNA, AND GNX2 ARE TRADE MARKS OF THE
HARMAN MUSIC GROUP INC.**

COPYRIGHT THE HARMAN MUSIC GROUP

PRINTED IN THE USA 06/2001

MANUFACTURED IN THE USA

GNX2 USER'S GUIDE 18-6384-A

**PLEASE VISIT DIGITECH ON THE WORLD WIDE WEB AT:
<http://www.digitech.com>**