

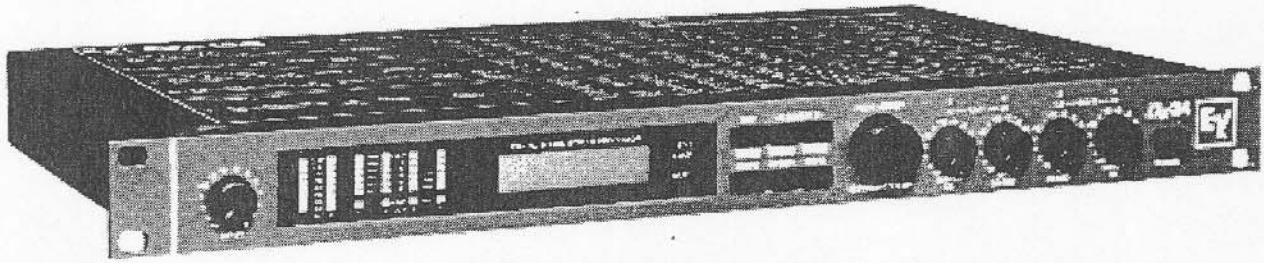

Electro-Voice®

OWNER'S MANUAL



✓ 1

Dx34

Digital Sound System Processor

INTRODUCTION

GENERAL

The Electro-Voice Dx34 is a multifunctional digital sound system processor. Its high degree of flexibility enables the set up and optimization of active multiway systems with variables previously unavailable in a single-rack-space device. The unit can be configured in two-way stereo, two-way dual mono, three-way mono with a direct out and four-way mono. Functional blocks in the unit include high- and low-pass filters, tunable low-cut filters to extend the low-end response of bass cabinets, parametric equalizers, low- and high-shelving equalizers, limiters and delays.

The Dx34 addresses many different sound system configurations. The Dx34 is factory programmed for the Electro-Voice MT-4 four-way systems, MT-2 and PI modular three-way systems, MH stadium horn systems and portable sound reinforcement systems. Additional listings of parameter values for other EV components and systems can be downloaded off the Electro-Voice BBS at 616/695-4791 (8,N,1).

The unit can be set to operate in one of two modes. Preset mode allows the user to select factory presets from a list of loudspeaker cabinets and only gives the user control of the limiter parameters at each output. Full-edit mode provides access to all parameters, allowing adjustment and saving of all settings. A total of 16 user presets is available.

The A/D/A conversion in the Dx34 is done with linear 18-bit converters. The input A/D section is a 64-times oversampled sigma-delta convertor and the output D/A is oversampled eight times. Internal resolution is 24 bits, using the Motorola DSP56004 processor.

All inputs and outputs are electronically balanced with XLR-type sockets. These inputs and outputs can be retrofitted with isolating balanced transformers. EV part number TRB-5 is the optional input transformer. EV part number TRB-4 is the optional output transformer.

FEATURE SUMMARY

- 1st-, 2nd- and 4th-order Bessel, Butterworth and Linkwitz-Riley, 3rd-order Bessel and Butterworth filter responses.
- 2nd-order tunable low-cut (high-pass) filters with up to 6 db ($Q = 2.0$) of boost to extend the low end response of bass cabinets.
- 6- and 12- dB slopes on the low- and high-shelving EQ. Gain range is ± 12 dB for both low-shelve slopes, ± 12 dB for the 6-dB high-shelve slope and +6, -12 dB for the 12-dB high-shelve slope.
- Two parametric EQ's in the high-pass channels for horn equalization. The Q range is from 0.4 to 20. Gain range is ± 12 dB.
- Up to 10-ms individual channel delay with a resolution of 21 μ s.
- Delay units are selectable in distance or time.
- Polarity switch on each output channel.
- Digital gain stage with a range of -24 to +6 dB.
- Individual output channel limiters with adjustable threshold, decay rate and hold time.
- "Lock-out" feature to prevent unauthorized use.
- "Slow," "peak hold" and "no peak" meter display modes.
- MIDI addressable.
- MIDI dumps to save and transfer user presets.
- Mutes on each output channel.

DESCRIPTION AND FEATURES

SPECIFICATIONS

Primary ac voltage	90–250 V ac, 50-60 Hz (without switching)
Power Consumption	21 W maximum
Safety Class	1
Inputs	Two female XLR's, electronically balanced, transformer optional
Input Voltage (nominal)	+4 dBu (1.23 V)
Maximum Input Voltage	+21 dBu (8.7 V)
Input Impedance	20 kilohms
CMRR	> 70 dB (1 kHz)
Insertion Loss of the Input Transformer	< 1.5 dB
A/D Conversion	18 bit linear, sigma-delta, 64-times oversampling, linear phase
Outputs	Four male XLR's, electronically balanced, transformers optional
Output Voltage (nominal)	+4 dBu (1.23 V)
Maximum Output Voltage	+21 dBu (8.7 V)
Output Impedance	< 100 ohms
Minimum Load Impedance	600 ohms
D/A Conversion	18 bit linear, eight-times oversampling, linear phase
Frequency Response	20-20,000 Hz, ± 0.3 dB
S/N Ratio	> 102 dB (typical)
THD without Transformer	< 0.01% (1 kHz)
THD with Transformer	< 0.1% (1 kHz)
Crossovers	6-, 12-, 18- and 24-dB-per-octave slopes; Butterworth, Bessel and Linkwitz-Riley characteristics
Equalizers	Low-shelving EQ's Eight parametric EQ's Two high-shelving EQ's Two low-cut filters (B_0 alignment switchable)
Limiter	Four digital limiters
Delay	One master delay (2 ms - 1,000 ms) Four channel delays (0 ms - 10 ms) Delay increment 21 μ sec
Data Format	18-bit linear, 24-bit internal
Sampling Rate	46.875 kHz
MIDI IN/OUT	Data dump, master/slave operation
Display	2 x 16-digit alphanumerical LCD with LED back light
Ground Lift	Disconnects ground from housing
Dimensions (hwd)	43.6 mm x 483 mm x 287 mm (1.75 in. x 19 in. x 11.25 in.)
Weight	4 kg (8.8 lb)
Lock Operation	Disable and enable access to internal functions of unit
Retrofitting Kits	TRB-5 (one input transformer) TRB-4 (one output transformer)

SPECIFICATIONS SUBJECT TO CHANGE WITHOUT NOTICE

DESCRIPTION AND FEATURES

DIMENSIONS

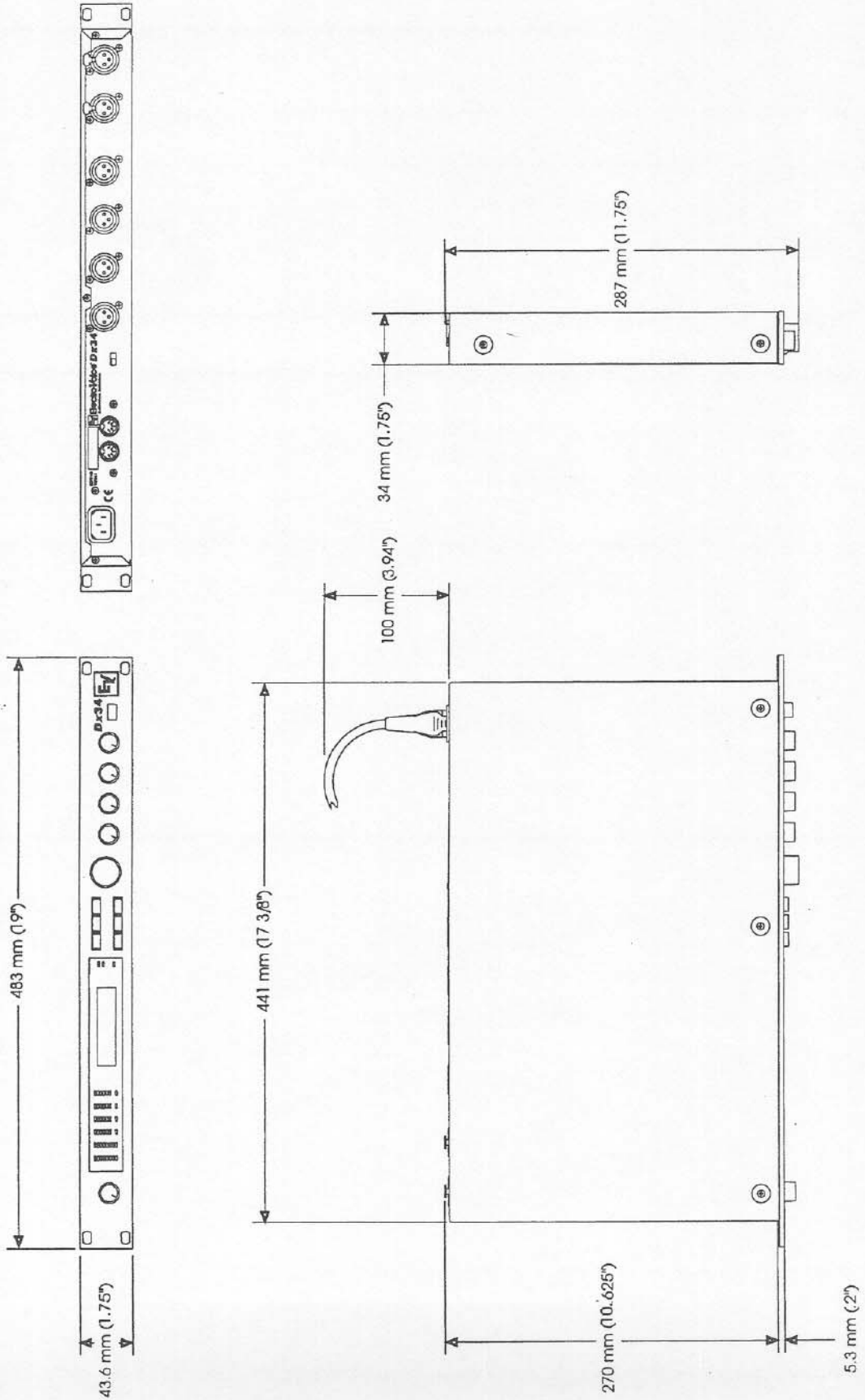

DESCRIPTION AND FEATURES

TYPICAL FILTER RESPONSE CURVES

1. 6 dB
2. 12 dB Q 0.5
3. 12 dB Q 0.7
4. 12 dB Q 0.8
5. 12 dB Q 1.0
6. 12 dB Q 1.2
7. 12 dB Q 1.5
8. 12 dB Q 2.0

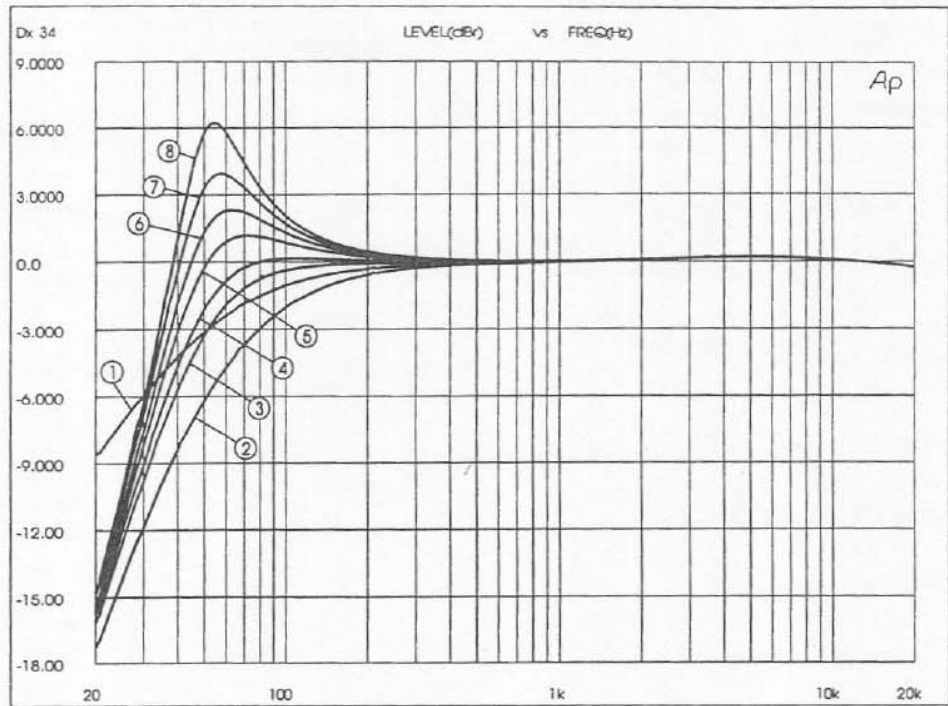

Dx34 Low-Cut filters, $f = 50$ Hz

1. Gain = +12 dB
2. Gain = +9 dB
3. Gain = +6 dB
4. Gain = +3 dB
5. Gain = -3 dB
6. Gain = -6 dB
7. Gain = -9 dB
8. Gain = -12 dB

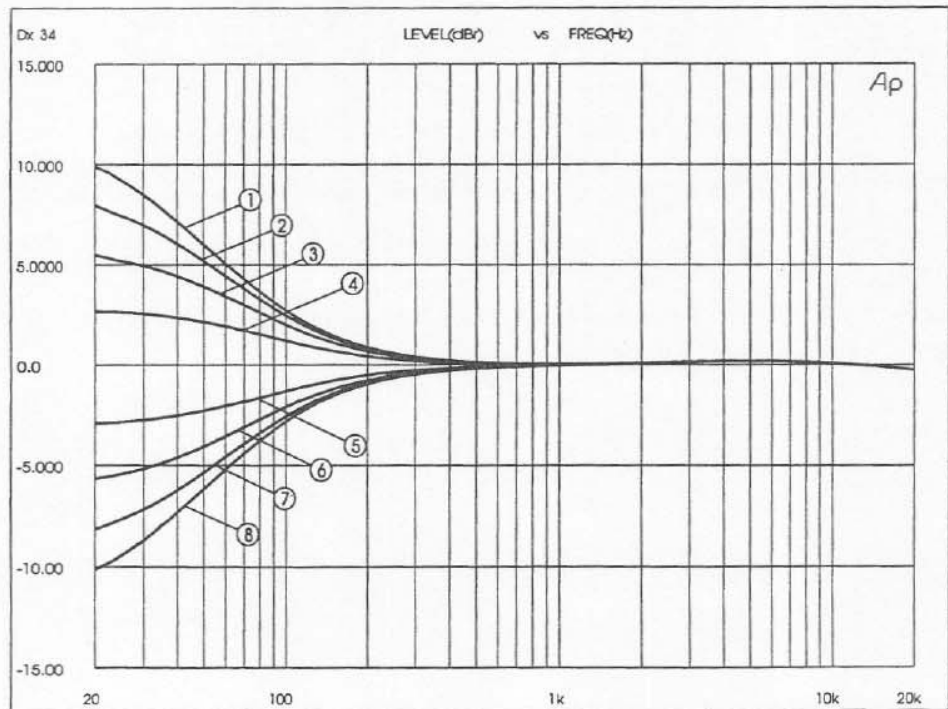

Dx34 Low-Shelve, 6 dB/octave, $f = 100$ Hz

DESCRIPTION AND FEATURES

TYPICAL FILTER RESPONSE CURVES

1. Gain = +12 dB
2. Gain = +9 dB
3. Gain = +6 dB
4. Gain = +3 dB
5. Gain = -3 dB
6. Gain = -6 dB
7. Gain = -9 dB
8. Gain = -12 dB

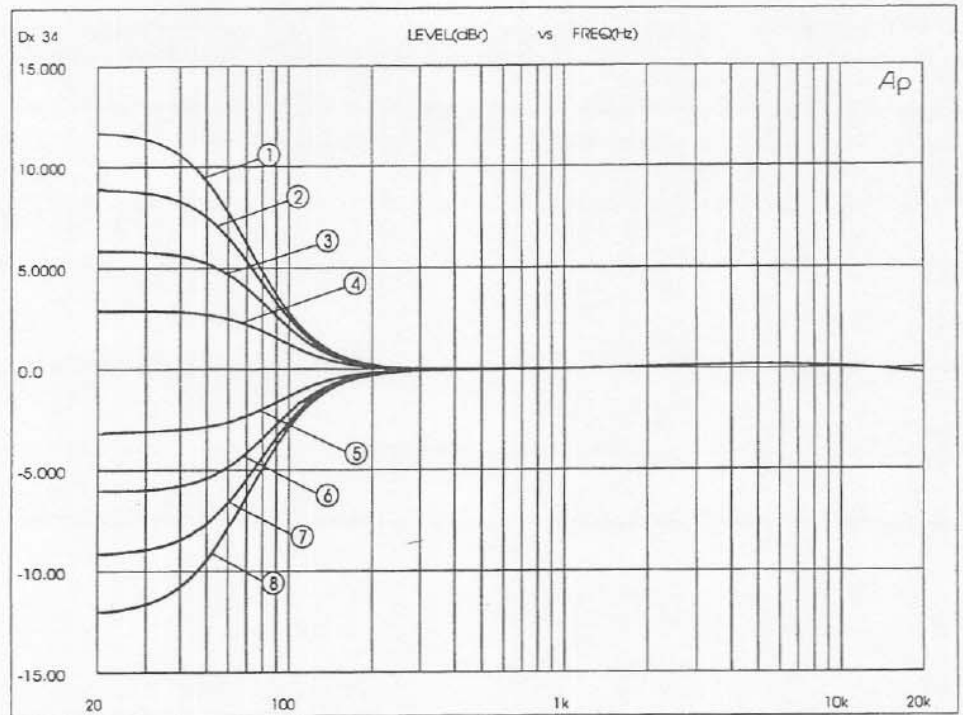

Dx34 Low-Shelve, 12 dB/octave, $f = 100$ Hz

1. Gain = +12 dB
2. Gain = +9 dB
3. Gain = +6 dB
4. Gain = +3 dB
5. Gain = -3 dB
6. Gain = -6 dB
7. Gain = -9 dB
8. Gain = -12 dB

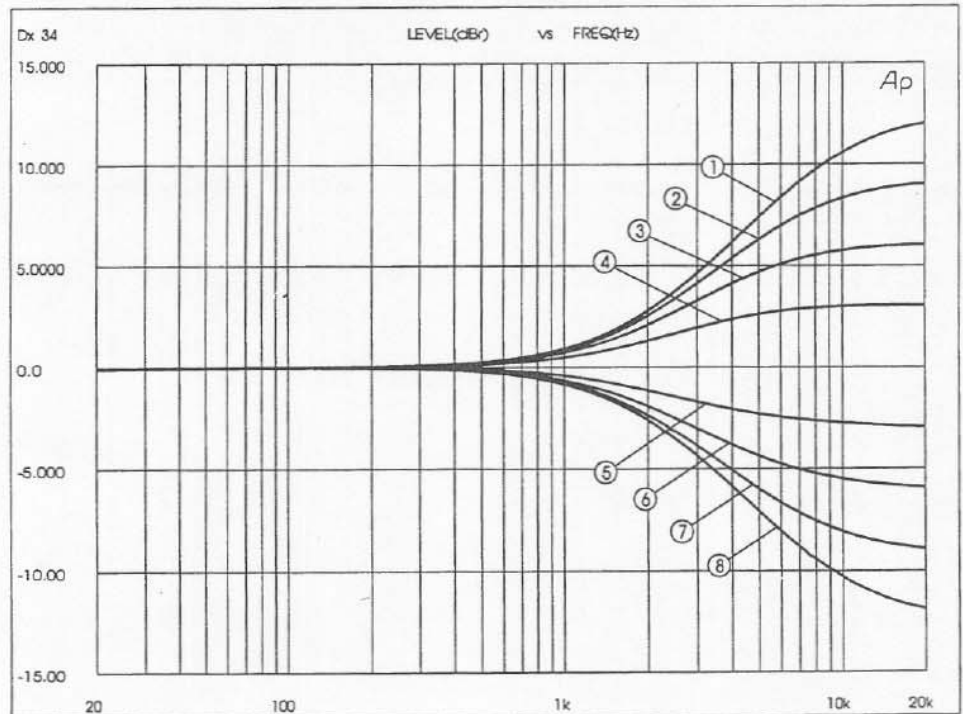

Dx34 High-Shelve filter, $f = 2$ kHz

DESCRIPTION AND FEATURES

TYPICAL FILTER RESPONSE CURVES

1. Gain = +6 dB
2. Gain = +3 dB
3. Gain = -3 dB
4. Gain = -6 dB
5. Gain = -9 dB
6. Gain = -12 dB

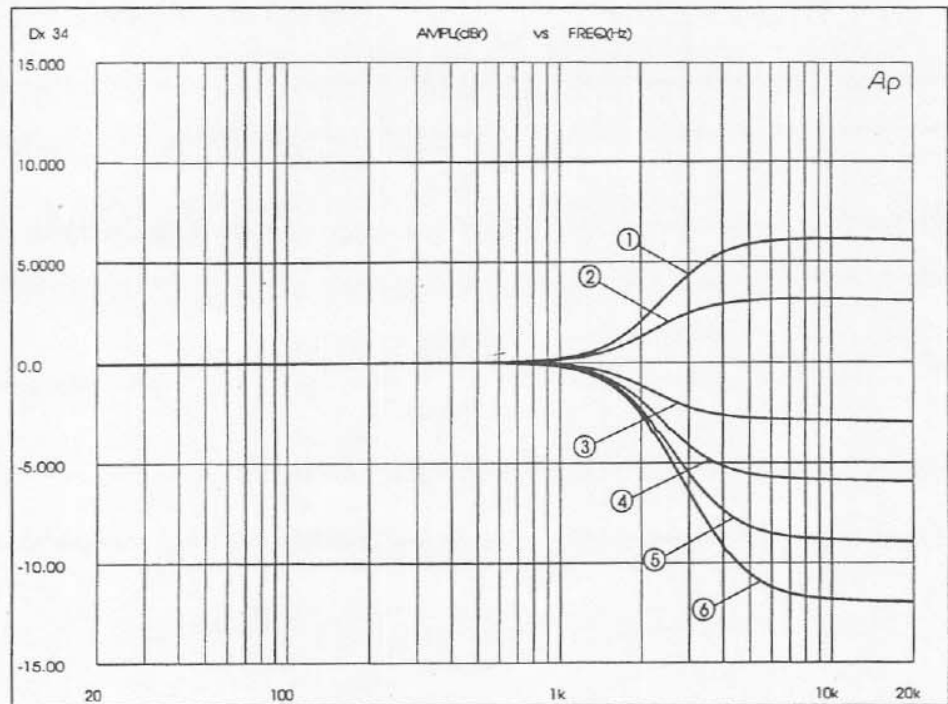

DxD34 High-Shelve filter, $f = 2$ kHz

1. Gain = +12 dB
2. Gain = +6 dB
3. Gain = 0 dB
4. Gain = -6 dB
5. Gain = -12 dB

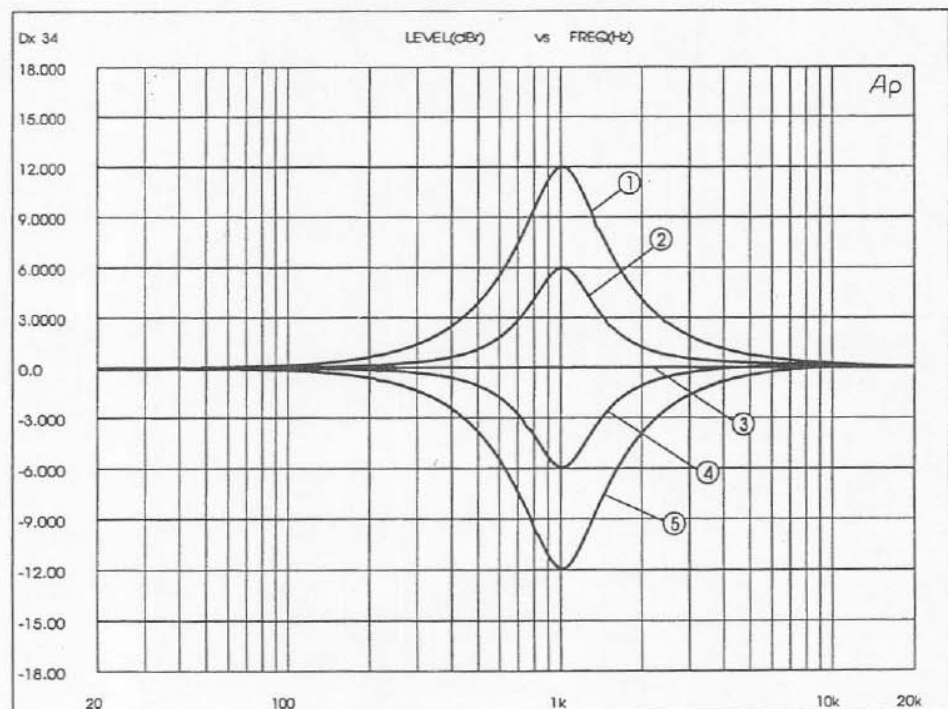

DxD34 Parametric EQ, $f = 1$ kHz, $Q = 2.0$

DESCRIPTION AND FEATURES

TYPICAL FILTER RESPONSE CURVES

- 1. $Q = 0.4$
- 2. $Q = 1.0$
- 3. $Q = 2.0$
- 4. $Q = 5.0$
- 5. $Q = 10.0$
- 6. $Q = 20.0$

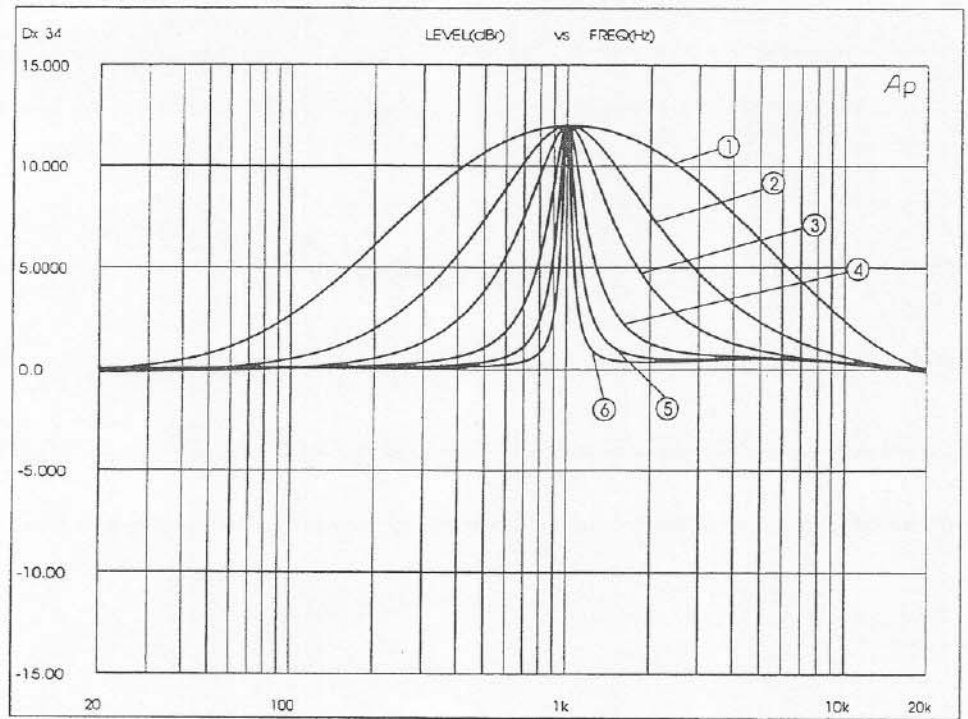

Dx34 Parametric EQ, $f = 1$ kHz, Gain = +12 dB

- 1. $Q = 0.4$
- 2. $Q = 1.0$
- 3. $Q = 2.0$
- 4. $Q = 5.0$
- 5. $Q = 10.0$
- 6. $Q = 20.0$

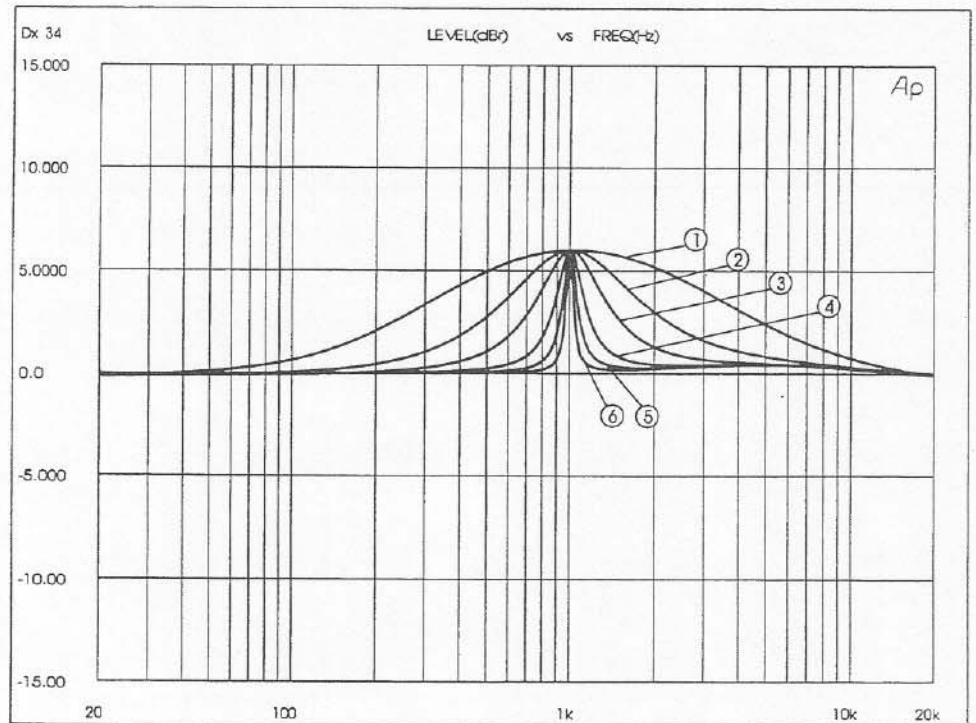

Dx34 Parametric EQ, $f = 1$ kHz, Gain = +6 dB

DESCRIPTION AND FEATURES

TYPICAL FILTER RESPONSE CURVES

1. High-pass 6 dB
2. High-pass Bessel 12 dB
3. High-pass Butterworth 12 dB
4. Low-pass 6 dB
5. Low-pass Bessel 12 dB
6. Low-pass Butterworth 12 dB

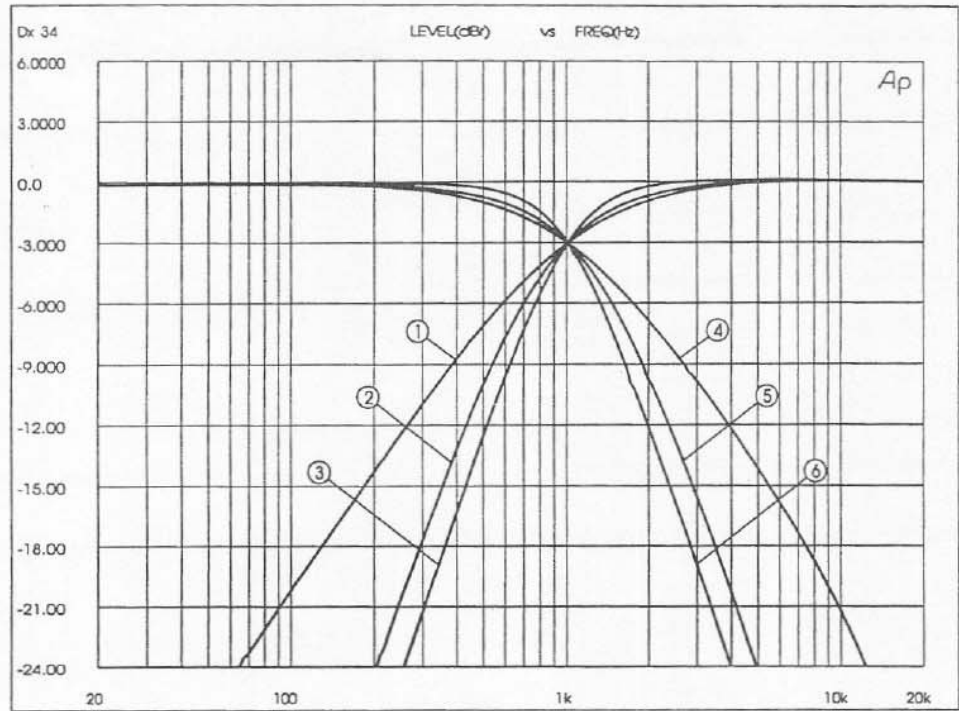

Dx34 Crossover filters, $f = 1$ kHz

1. High-pass Bessel 18 dB
2. High-pass Bessel 24 dB
3. High-pass Butterworth 18 dB
4. High-pass Butterworth 24 dB
5. Low-pass Bessel 18 dB
6. Low-pass Bessel 24 dB
7. Low-pass Butterworth 18 dB
8. Low-pass Butterworth 24 dB

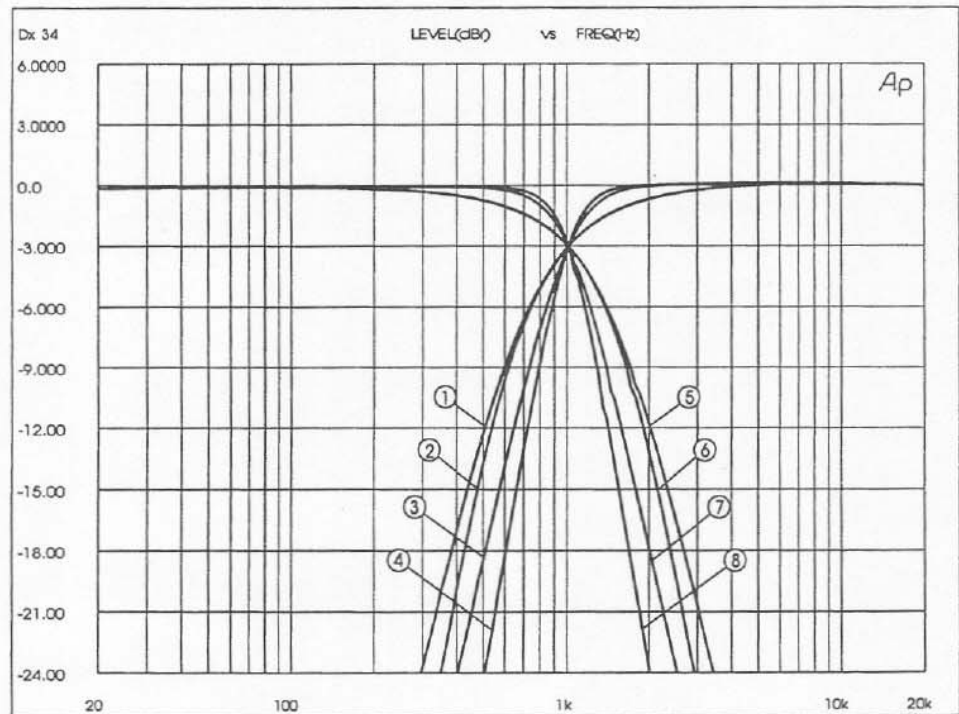

Dx34 Crossover filters, $f = 1$ kHz

DESCRIPTION AND FEATURES

TYPICAL FILTER RESPONSE CURVES

1. High-pass Linkwitz-Riley 12 dB
2. High-pass Linkwitz-Riley 24 dB
3. Low-pass Linkwitz-Riley 12 dB
4. Low-pass Linkwitz-Riley 12 dB

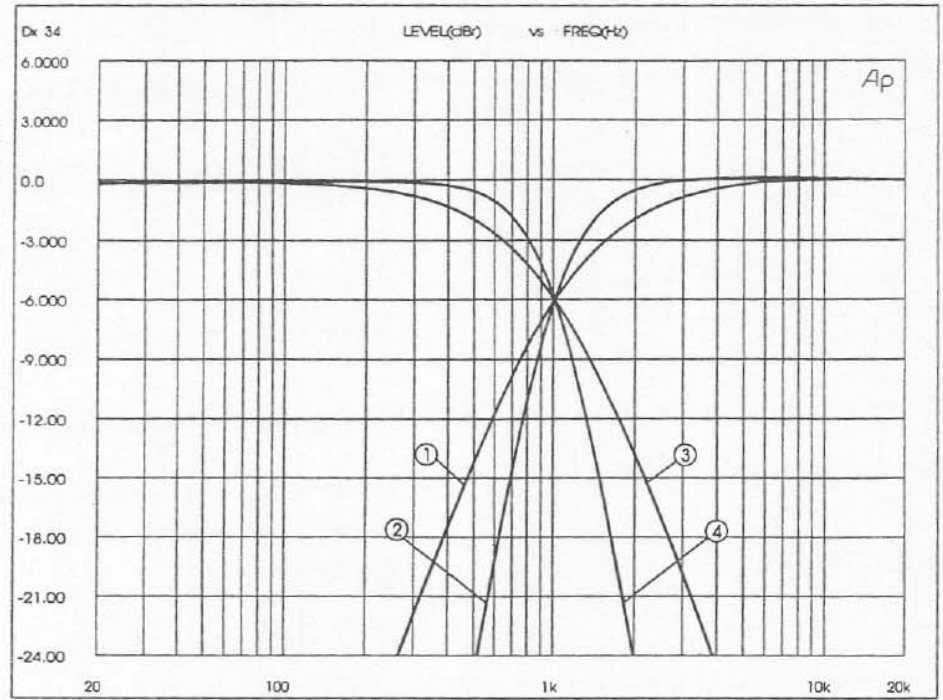

Dx34 Crossover filters, $f = 1$ kHz

BLOCK DIAGRAM

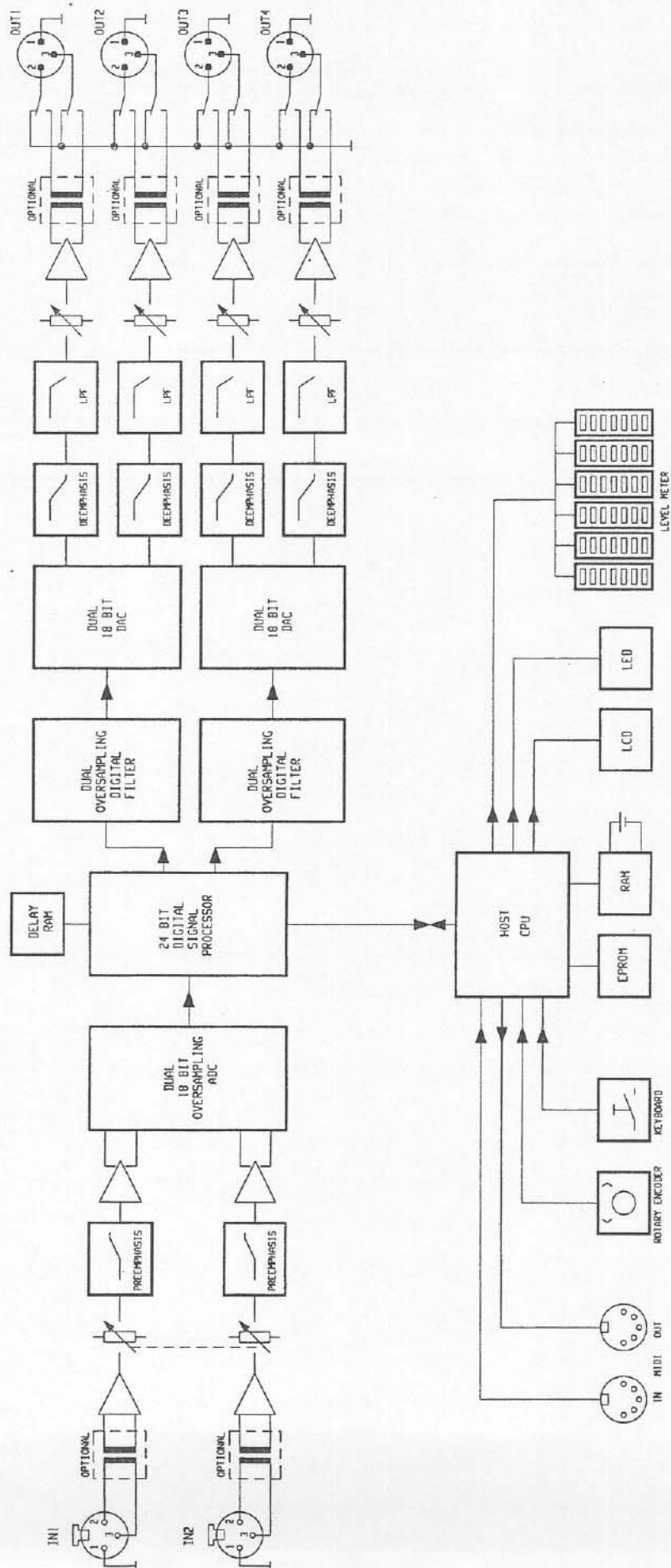

1 FRONT-PANEL INDICATORS AND CONTROLS

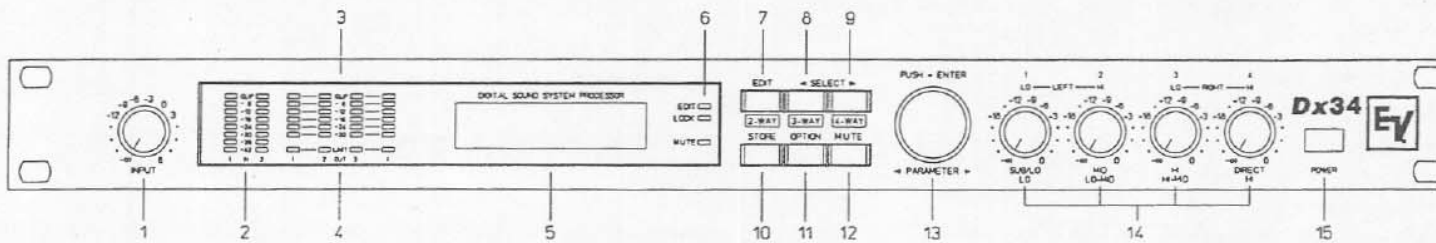

1. INPUT CONTROL

This rotary control adjusts the input level of the Dx34. Adjust to maintain as high of a level on the input meters without clipping for best signal-to-noise ratio (S/N).

2. LEVEL INDICATORS IN 1/IN 2

These monitor the input signal, indicating the peak value of the input level in each case. Adjust the input control so that the level indicators show approximately -12 dB. If the clip LED's should light, the unit is being overdriven internally. A "peak-hold" or a "slow-mode" function can be chosen for the indicators.

3. LEVEL INDICATORS OUT 1-4

These show the peak level of the corresponding outputs. The Dx34 should be operated in such a way that the clip LED's do not light. A "peak-hold" or a "slow-mode" function can be chosen for the indicators.

4. LIMITER INDICATORS OUT 1-4

The "limit" LED's light up when the limiter is active in the respective channel, i.e., the output level is limited when the signal level has exceeded the preselected limiter threshold for that channel.

5. MULTIFUNCTIONAL DISPLAY

This is a 2 x 16 character LCD display. In playmode, the program name or the cabinet type and configuration are displayed. In edit mode, the parameter name, a graphic and a numeric parameter value are displayed. Depending on the current status, option menus, status messages, user guide messages, etc., appear.

6. STATUS/MODE LED'S

These LED's indicate the Dx34's current status. If the edit LED lights, the edit mode has been entered. The lock LED indicates that the Dx34 is in write-protect mode and that no values can be entered. The mute LED indicates when one or more of the outputs are disabled.

7. EDIT/2-WAY KEY

This key places the unit in edit mode. After pressing this key, the first parameter of the active program is displayed. Further parameters are accessed with the select keys. The current value of the parameter can be changed with the rotary encoder. For further information please see chapter 4.6.

The Dx34 is configured for two-way operation by pressing and holding this key while switching the power on.

8. < SELECT/3-WAY KEY

In play mode, this key selects the previous program (activated by pressing "enter"). In edit mode it is used for selecting the previous parameter.

The Dx34 is configured for three-way operation by pressing and holding this key while switching the power on.

9. > SELECT/4-WAY KEY

In play mode this key selects the next program (activated by pressing "enter"). In edit mode it is used for selecting the next parameter. The Dx34 is configured for four-way operation by pressing and holding this key while switching the power on.

10. STORE KEY

With this key, the edited programs can be saved in any memory location (number 01 - 10).

For further information please see chapter 4.7.

11. OPTION KEY

This key allows access to the option menu where special settings for the unit can be made or checked.

For further information please see "OPTION FUNCTIONS," chapter 6. See chapter 6.2 for "lock," or edit protection.

12. MUTE KEY

This key displays the mute status of all four outputs. Each channel can be individually selected with the "select" keys. Mute "on/off" selected by turning or pushing the parameter wheel.

13. ROTARY ENCODER WITH ENTER KEY

In play mode, turning the encoder chooses a program, pressing the encoder (enter) activates the program. In edit mode, the encoder is used to alter parameter values. Parameter values can be changed faster by turning and pressing the encoder at the same time. Generally speaking, the encoder aids speedy operation of the Dx34 with one hand.

For further information please see chapter 4.

14. CONTROLS OUTPUT 1-4

These are attenuators that can be used to adjust the output levels of output channels 1 to 4.

15. POWER SWITCH

This switches the Dx34 on and off.

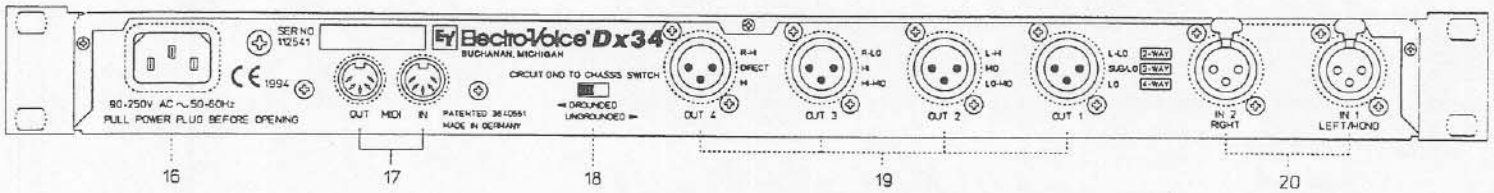

16. MAINS SOCKET

The supplied power cable plugs into this connector. The Dx34 is designed to operate with a mains voltage range of 90-250 V ac. No voltage selection is required.

17. MIDI SOCKETS IN/OUT

Several Dx34 slaves can be controlled by one master unit using these sockets. Transmission of memory data (MIDI dump) in both directions is also possible.

18. GROUND LIFT SWITCH

The ground lift switch serves to prevent hum generated by ground loops. If the housings of some units in a rack have electrical contact, all ground lift switches should be put on "UNGROUNDED" except for one.

19. SOCKETS OUT 1-4

These are balanced outputs. The audio spectrum available at each output is dependent upon the selected configuration, (two-way, three-way, four-way). Connections for the different configurations must be made according to the corresponding label. The wiring for the inputs and outputs is explained in chapter 4.10.

20. SOCKETS IN 1/IN 2

These are balanced inputs. In stereo mode, and in mono subwoofer operation, both sockets (LEFT/RIGHT) must be connected. In all other modes, only IN 1 (MONO) need be connected. The connections for the inputs and outputs are explained in chapter 4.10. Connection examples for different configurations are explained in chapter 4.4.

3 QUICK START

This chapter instructs you how to accomplish some of the more popular aspects of the Dx34. More details about the functions that the unit is capable of, and how to access those capabilities, will only be revealed by selectively reading the contents of the manual. This section assumes that you are already familiar with connecting audio systems and how to properly use a crossover and EQ.

PREFLIGHT CHECKLIST

Before turning the unit on you should know the answers to the following questions:

What system configuration (two-, three-, four-way) are you interfacing the Dx34 with?

Do you want to set the unit up with a factory preset that is ready for an existing EV speaker system?

Do you want access to all the variables that are available in the unit?

PRIMARY POWER CONNECTION

Connect the ac power cord. There's no voltage selection switch because it's a universal supply that operates from 90-250 V ac, 50/60

SELECT CONFIGURATION

A. PRESET MODE

If you want to configure the unit for an existing EV cabinet that appears in the supported list and not modify any settings except for limits thresholds, this is for you.

1. Press and hold in the appropriate configuration key while turning on the power. Hold for about three seconds.
2. Select the described system using the select (8 and 9) keys and enter (13).
3. This preset will be saved to memory and will be recalled the next time you turn the unit on.
4. Refer to the index for more information.

B. FULL-EDIT MODE

Use if you want to do a custom setting, starting from scratch.

1. Press and hold in the appropriate configuration key and store while turning on the power. Hold for about three seconds.
2. Press the edit key and adjust the various parameters to your hearts content. Refer to the edit section in the OPERATION / INSTALLATION chapter and the PARAMETERS chapter.
3. Save the preset by following the instructions in section 4.7.
4. If you want to modify a factory preset, read section 4.8.

SET INPUT LEVEL

to set power up with select switches

Adjust the input level control until the input meters display a nominal value of -6 to -12 dB with little or no clipping. This will yield the best S/N.

AVAILABLE PRESETS

FOUR-WAY

MT-4A
MT-4/64B
MT-4/42B

THREE-WAY

PI64+PI218L
PI94+PI218L
PI640C/PI6415
PI660C/PI6615
PI940C/PI9415
MT-2/64
MT-2/94
T53 + T18

TWO-WAY

MH6040C
MH9040C
MH4020C
Sx200 + S-181
T52 + T18

Select ▶

Select ◀

Edit

Preset only

*Full edit mode
Press store key*

EDIT PRESETS

Common things that you might want to do right away without digging through the manual are referenced in the index at the rear of this manual. Please refer to the index to find out how to quickly:

1. Adjust parametric EQ for horn equalization.
2. Set crossover frequency and order.
3. Operate mutes.
4. Adjust output levels.
5. Adjust signal delays for alignment.
6. Save a user preset (program).
7. Modify a factory preset and save it in a user preset.
8. Access the EV BBS for presets of new speaker systems.

4 OPERATION AND INSTALLATION

4.1 SWITCHING THE UNIT ON

1. The Dx34 is switched on using the power switch (15). The unit recalls the last program that had been stored to memory before it was shut off.

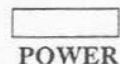

2. The following appears on the display:



3. The Dx34 is now ready for operation. The following may appear on the display:

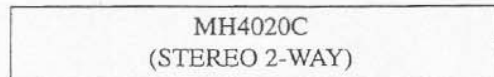

The display indicates that the unit is in the stereo two-way configuration. The unit is set to active two-way operation for the MH4020C. This is one of the factory settings of the Dx34.

To configure other cabinets or enter another mode, please proceed to chapter 4.3.

ATTENTION!

If the display on the right appears after the unit has been switched on, contact an Electro-Voice service center to have the internal battery changed. There are no user servicable parts inside.

When the battery voltage has dropped below a minimum value, there is no guarantee that your program data will be maintained in memory after the unit has been disconnected from the mains supply. It is recommended that you save your user presets by doing a MIDI dump to a permanent storage medium for reloading after the new battery has been installed.



4.2. LEVEL SETTING

1. The INPUT control (1) is used to adjust the input level of the Dx34.

2. While adjusting the input level with the INPUT control (1), check the maximum indication on each corresponding level meter (2). The optimum value is between -12 dB to -6 dB. The clip LED indicates an internal overload and should only light occasionally or not at all.

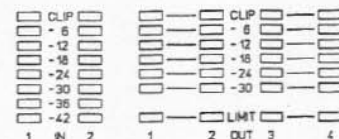

4.3 OPERATING MODES OF THE Dx34

The Dx34 can be operated in "factory preset mode" or "full-edit mode."

There are three configurations in each mode. These basic modes are accessed while simultaneously switching the unit on and pressing one or two function keys at the same time for approximately three seconds.

To select a different operating mode or a new configuration, the Dx34 must be switched off and switched back on again while pressing the appropriate function key(s). The procedure is described in the following paragraphs.

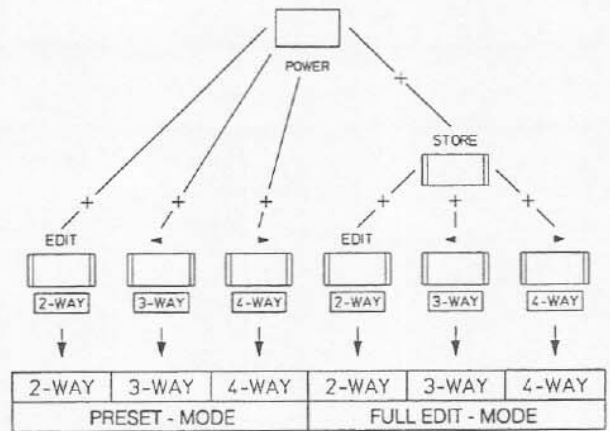

4.3.1 FACTORY PRESET MODE

The preset mode is the simplest way to achieve good results with the Dx34. In preset mode, the desired loudspeaker is selected from a list. The Dx34 automatically sets the optimum parameter for the selected components. The user can then set and save the limiter threshold values in the individual channels. Please turn to chapter 5.3 for a detailed description of all the parameters.

The user gains access to preset mode by pressing one of the three keys: two-way, three-way or four-way (depending upon the desired configuration) for approximately three seconds while switching the unit on. A brief message indicating the selected configuration appears on the display during initialization.

The unit then displays the cabinet selections that are available. The following may appear on the display:

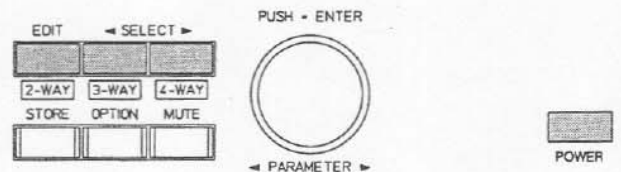

SELECT APPLICAT:
PI640C/PI6415

4 OPERATION AND INSTALLATION

Select the desired system by turning the rotary encoder (13). Confirm the selection by pressing the encoder knob (ENTER).

Once the desired system has been selected, the Dx34 sets the appropriate parameters. The unit is then ready for operation. The display may show the following:

If need be, the user can edit and save the limiter parameters as described in chapter 5.1.

4.3.2 FULL-EDIT MODE

In full-edit mode, all parameters can be set. A finished program can be saved in one of the ten memory spaces for the current configuration.

For access to full-edit mode, press and hold the store key (10), and at the same time one of the three keys: two-way, three-way or four-way, depending on the desired configuration, for approximately three seconds while turning on the power. The display shows a brief message while initializing.

The unit is now ready for operation and is in play mode. The display may show the following:

You now have access to all parameters and you can create and save up to ten programs for the current configuration. Please turn to chapter 4.5 for details on procedures. Chapter 5 contains descriptions of all parameters, their setting ranges and their effects. You can download the latest Electro-Voice speaker presets off the Electro-Voice BBS at 616/695-4791 (8,N,1), and use this list of presets as a basis for your own program creations. The preset file contains all parameter settings for the loudspeakers available.

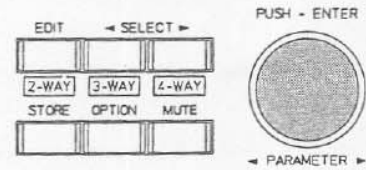

MT-2/64B
(3-WAY/SUB+1)

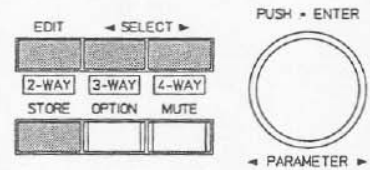

01 USER PROGRAM
(STEREO 2-WAY)

4.4 SELECT CONFIGURATION (TWO-, THREE-, FOUR-WAY)

The Dx34's configurations are as follows:

- STEREO TWO-WAY
- TWO-WAY DUAL MONO
- THREE-WAY/SUB + ONE
- FOUR-WAY

Stereo two-way is a two-way crossover in stereo. All channels feature limiters, polarity switches, delay lines and digital gain to compensate for different loudspeaker efficiencies. Each low channel has a parametric peak-dip filter (parametric equalizer, PEQ), a tunable low-cut filter, a low-shelving EQ and crossover filter. The high channels have two parametric peak-dip filters, a high-shelving EQ and the complementary crossover filter. The master section includes a master delay to delay signals for distributed systems and a parametric peak-dip filter.

A typical stereo two-way configuration is illustrated on the right. The block diagram below shows the structure of this configuration.

Two-way dual mono is accessed in the options menu using the two-way parameter window.

STEREO TWO-WAY

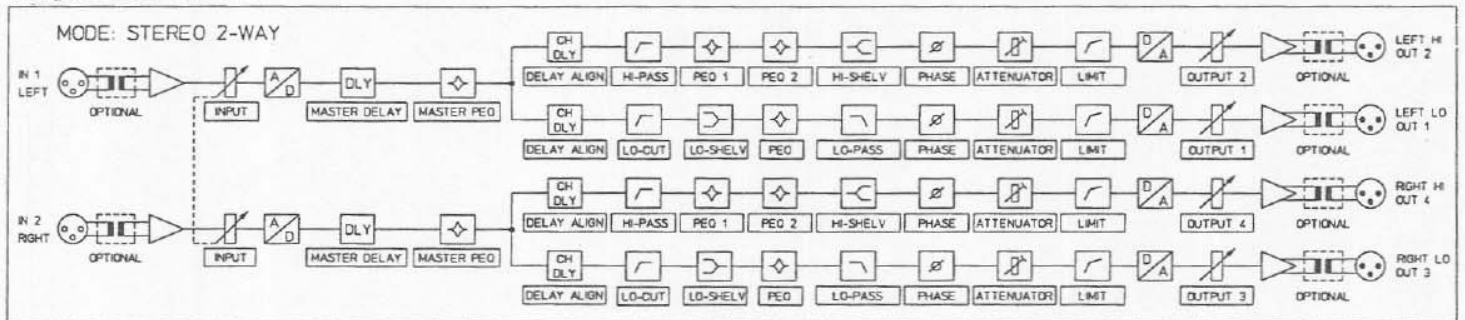
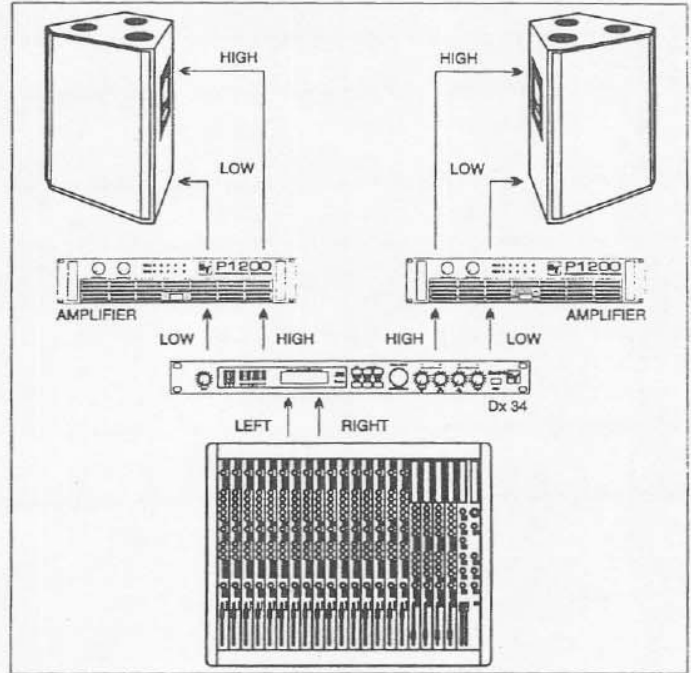

Three-way/sub + one is a three-way crossover in mono with an additional direct output. Limiters, polarity switches, digital gain and delay lines are available in all crossover channels. In the low channel, there is a parametric peak-dip filter (parametric equalizer, PEQ), a tunable low-cut filter, a low-shelve EQ and crossover filter. The mid channel is equipped with two PEQ's and two crossover filters for low and high frequencies. The high channel has two PEQ's, a high-shelving EQ and a crossover filter. The direct channel has its own delay, polarity switch and digital gain. The inputs feature a master delay for distributed loudspeaker systems. The low output can be switched to mono sum to accommodate stereo three-way systems (using two Dx34's) with a mono subwoofer. The direct output also receives a mono signal when (MONO) is selected in the (LO & CH4) mode window.

MONO THREE-WAY

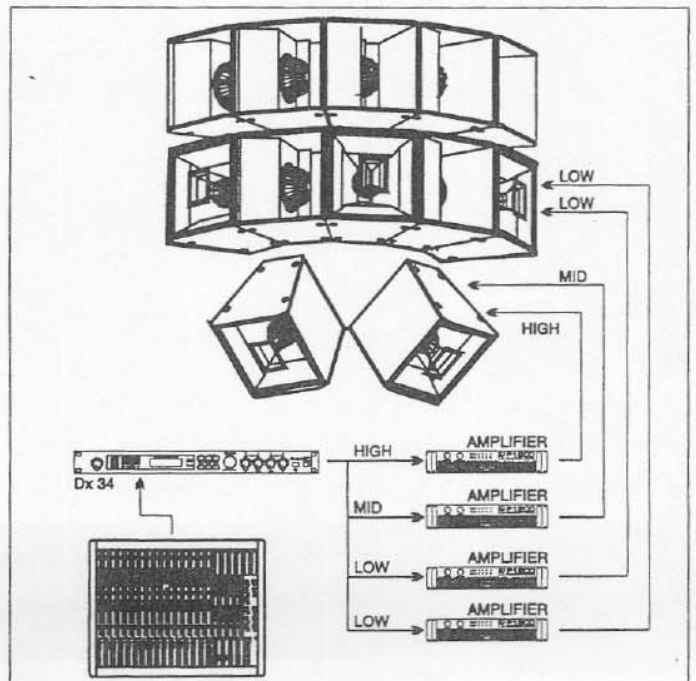

4 OPERATION AND INSTALLATION

The figure on the right shows a typical three-way/sub + one configuration, using PI Modular Series™ boxes.

This figure shows the use of a mono subwoofer. Both input channels of one Dx34 must be used in this case. Mono-summing occurs within the unit.

The internal structure of the three-way/sub + one configuration is shown in the following block diagram.

STEREO THREE-WAY/SUB

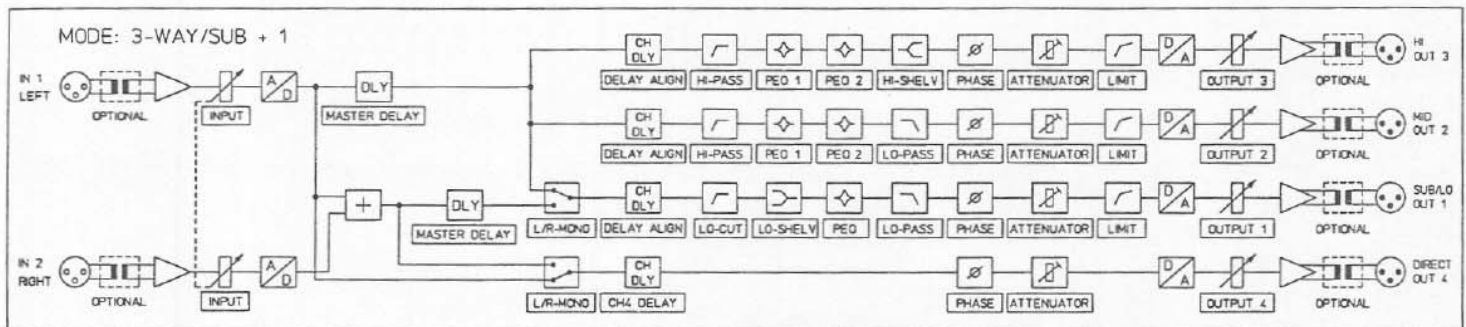
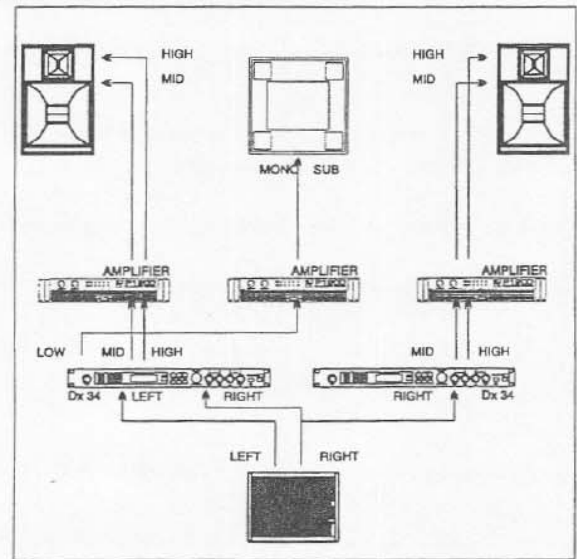

STEREO FOUR-WAY

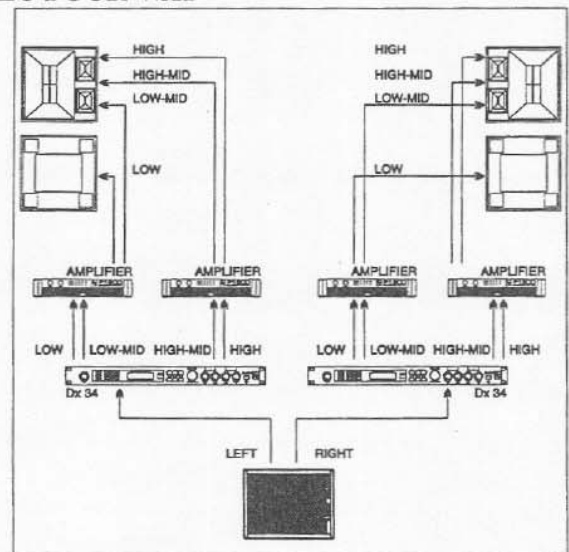

The four-way configuration is a four-way crossover in mono. All channels provide limiters, digital gain, polarity switches, delay lines and parametric peak-dip filters (parametric equalizers, PEQ's). In addition, there are a low-cut and low-shelving EQ in the low channel, and a high-shelving EQ and a second PEQ in the high channel. Each channel supports the appropriate crossover function(s). There is a master delay in the input.

The figure on the right shows a typical four-way configuration with two Dx34's for stereo mode. The block diagram below shows the internal structure of the four-way configuration.

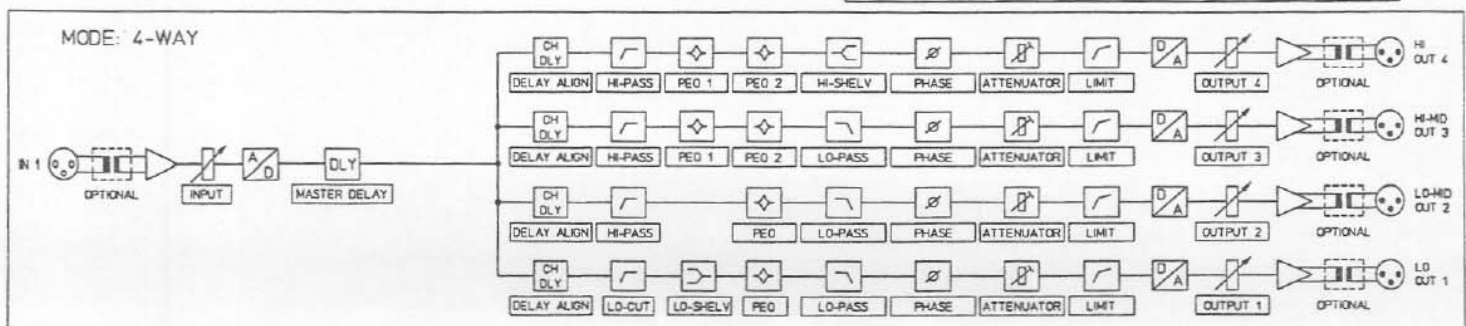

The user interfaces with the Dx34 using a rotary encoder with push function (ENTER) and six function keys.

There are five different modes which can be opened and closed by the corresponding keys.

1. PLAY MODE

- Mode after switching on
- Normal state of operation
- Program selection in user mode
- Mode indication

2. EDIT MODE

- Alteration of parameters
- Indicated with the edit LED
- Activated with the edit key
- Return to play mode with the edit key

3. STORE MODE

- Storing and copying programs
- Entering the program name in user mode
- Activated with the store key
- End with the store key

4. OPTION MODE

- Editing functions pertaining to equipment
- Activation via option key
- Return to play mode via the option key
- Switching the edit protection on/off

5. MUTE MODE

- Mute individual outputs
- Mute all outputs simultaneously
- Activated with the mute key

4.5 PROGRAM SELECTION

If the Dx34 is operated in full-edit mode, you can select up to ten different programs in each configuration (two-way, three-way, four-way).

Programs can only be accessed when the Dx34 is in play mode. Each of the ten programs can be edited freely and can be saved in any of the ten memory locations.

1. A memory location can be reached by searching for the program you want with the rotary encoder (13) or with the two select keys (8) and (9).

2. The new program name appears on the display. The program number in the top left corner of the display flashes on and off. The unit configuration is shown in the second display line.

3. Activate the program by pressing the rotary encoder (13) (ENTER). The program number stops flashing.

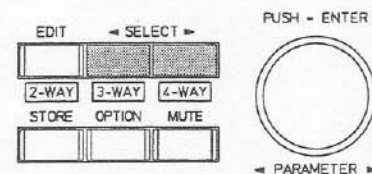

03 USER PROGRAM
(STEREO 2-WAY)

4 OPERATION AND INSTALLATION

4.6 EDITING

All parameters can be changed in full-edit mode. For a description of the parameters please turn to chapter 5.

1. Press the edit key (7).
2. The unit is now in edit mode. The edit LED lights up and the name and the value of the first parameter in the active program appear on the display. The channel number (1,2,3,4) and the channel name (LO, HI, ...) precede the parameter name. A graphic indication of the parameter value, where applicable, provides information about the current position in the parameter range.
3. The rotary encoder (13) can now be used to alter the parameter value. The rate of scrolling through the values can be increased by pushing in the parameter wheel while turning.
4. The selected value appears on the display and the change is immediately audible. The edit LED then flashes to show that the program has been altered. If you do not want to change any other parameters, proceed directly to point seven.
5. The select keys (8) and (9) access the previous or next parameter.
6. The following may appear on the display:
Points 3-6 can be repeated as often as required.
7. By pressing the edit key (7) again, you return to play mode.

CAUTION! Your program alterations have not yet been stored and will be lost at the next program change!

8. The program number, the program name and the unit configuration appear on the display. The edit LED continues to flash.
 - if you would like to store the edited program in a memory, proceed to chapter 4.7.
 - if you would like to continue to alter parameters, go back to step one.
 - if you want to retain the original program, press the rotary encoder (13) (ENTER). This deletes all alterations of the parameter values. The edit LED goes off.

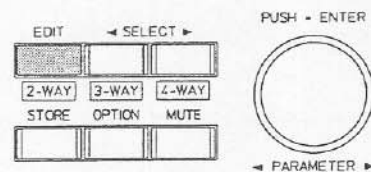

1 LO>LO-CUT FREQ
30 Hz

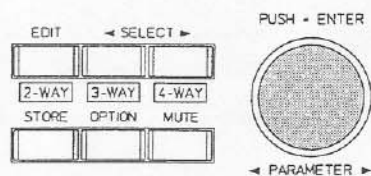

1 LO>LO-CUT FREQ
48 Hz

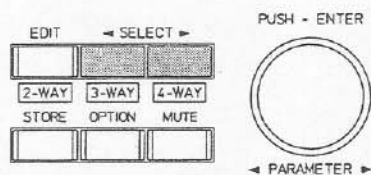

1 LO>LO-CUT RESP
12 dB Q 0.7

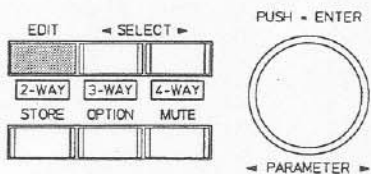

03 USER PROGRAM
(STEREO 2-WAY)

NOTE:

You can enter the store mode directly by pressing the store key (10)!

4.7 NAMING AND SAVING PROGRAMS

The procedures for saving an edited program and copying a program from one memory location to another are the same.

In preset mode, parameters are stored by pressing the store key (10) once, since no program numbers or names can be selected here. The following appears briefly on the display:

The following description applies to full-edit mode:

The procedure to store a program begins and ends with the store key (10). You can exit the store mode by pressing store (10) a second time before changing the program number or name.

1. Press the store key (10) to initiate the saving of a program.

The following may appear on the display:

2. To store the program in the current location without changing the name, go to step six. If you only want to edit the name but not the memory location, go to step four.

3. Select the desired memory location with the rotary encoder (13).

The following may appear on the display:

Proceed to step six if the name will not change.

4. Move the cursor to the first or last character of the program name using the select keys (8) and (9).

The following appears on the display:

5. Move the cursor to the desired position by rotating the encoder (13) knob. A blank can be inserted in the active position by pushing enter. Use the select keys (8) and (9) to move the cursor back and forth, then enter each character individually, e.g., "X-Over 200 Hz." There are 13 characters available for the program name. To continue, move the cursor back to the program number on the left-hand side of the display.

6. Press the rotary encoder (13) (ENTER) to confirm the selected program number and name. The display then shows the following:

7. The edited program is written to memory by pressing store (8) again.

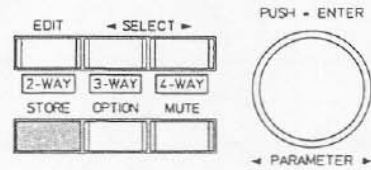

PARAMETERS
STORED...

STORE TO PROGRAM
03 USER PROGRAM

STORE TO PROGRAM
07 USER PROGRAM

EDIT TITLE
07 USER PROGRAM

OVERWRITE?=STORE
07 X-OVER 200Hz

07 X-OVER 200Hz
(STEREO 2-WAY)

CAUTION!

The previous program in this memory location will be overwritten! Therefore make certain that the chosen program number is correct. The store procedure can be cancelled by pressing any other key.

The following may appear on the display after storing:

The unit returns to play mode.

4 OPERATION AND INSTALLATION

4.8 MODIFYING A FACTORY PRESET

A factory preset can be transferred to a user program for editing in the full-edit mode.

1. Select the appropriate two-, three-, or four-way configuration by switching the unit on while pressing the desired configuration key (7, 8 or 9). The display may show:
2. Select the factory preset that you would like to edit from the list and load it into memory by pressing the parameter wheel (ENTER).
3. Turn the unit off. The preset will remain in memory.
4. Enter full-edit mode by switching the unit on while pressing the desired configuration key (7, 8 or 9) and store key (10).
5. Select memory location 00 with the select key (8) and reload the factory preset by pressing the parameter wheel (ENTER). The edit light will begin to flash at this time, prompting you to make changes by pressing edit (7) or store the program to a new location.
6. Press store (10) and select a new memory location in which to save the preset with the parameter wheel. The name can also be changed at this time. Push the parameter wheel (ENTER). The display may show:
7. Pressing store once more will save the program to the selected memory location. Further modifications can be done at any time on the saved program when in full-edit mode. See Section 4.6.

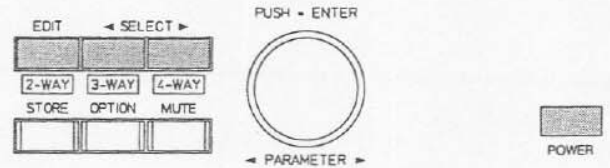

SELECT APPLICAT:
PI660C/PI6615

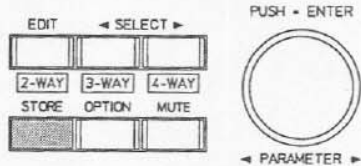
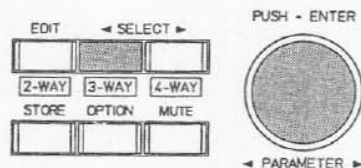
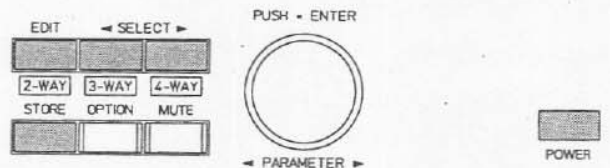

STORE TO PROGRAM
01 PI660C MYWAY

4.9 INSTALLING THE OPTIONAL TRB-5 INPUT AND TRB-4 OUTPUT TRANSFORMERS

Installation of input transformer (TRB-5):

1. Switch the unit off and pull the power plug.
2. Remove the cover (three screws on top, four on side and three on rear).
3. Cut the two wire jumpers (A) per transformer (see Figure 1).
4. Solder the resistor into PCB (see Figure 1, R 104, R 204).
5. Plug the input transformer TRB-5 into prepared socket on PCB (see Figure 1, T 101, T 201).
6. Fix the transformer with cable binder or rubber moss (see Figure 2).
7. Replace the cover.

Installation of output transformer (TRB-4):

1. Switch the unit off and pull power plug.
2. Remove the cover (three screws on top, four on side and three on rear).
3. Cut the two wire jumpers (A) per transformer (see Figure 1).
4. Short the two output electrolytic capacitors per transformer. Use the two provided solder areas (B) (see Figure 1, C 326, C 324, C 340, C 338, C 426, C 424, C 440, C 438).
5. Plug the input transformer TRB-4 into prepared socket on PCB (see FIG 1, T 301, T 302, T 401, T 402).
6. Fix the transformer with cable binder or rubber moss (see Figure 2).
7. Replace the cover.

FIGURE 1 POSITION OF COMPONENTS IN THE D_x34

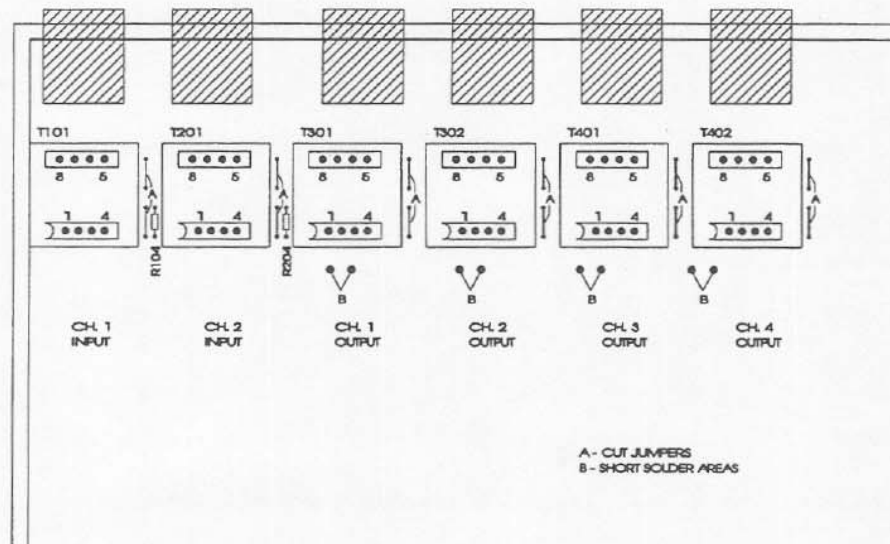
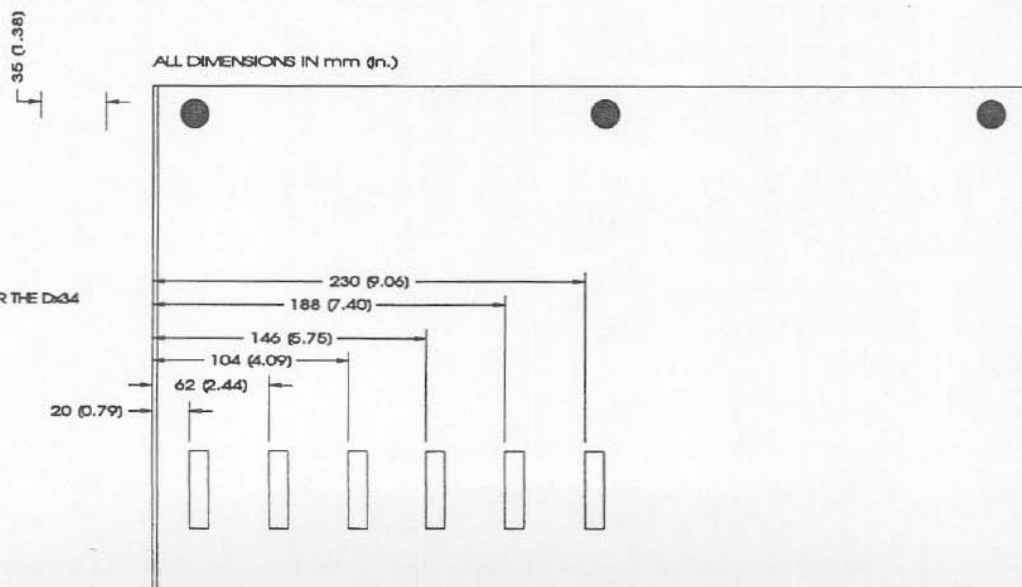

FIGURE 2 COVER FOR THE D_x34



4 OPERATION AND INSTALLATION

4.10 CONNECTOR AND CABLE WIRING GUIDELINES

To achieve the best results with the Dx34, the unit must be connected properly. To begin, connect the enclosed ac power cable with the Dx34's mains socket and your outlet.

To avoid temperature related problems, the unit should have adequate ventilation and not be operated at ambient temperatures above 40 °C.

Before turning on the Dx34, all connections should be completed. Connections will vary depending upon the selected configuration.

IMPORTANT:

- Always use well-shielded audio cables.
- To avoid high frequency losses, the source lines, especially to the inputs, should not exceed 10 m (33 ft)
- Do not position the unit directly on or under a power amplifier, TV monitor, etc., as the leakage field of the transformers in such devices could induce hum into the Dx34.

BALANCED INPUT WIRING

Connect the noninverting (+) lead of the cable to pin 2 of the XLR connector and the inverting (-) lead to pin 3 of the XLR connector. The shield is connected to pin 1 of the XLR connector. If one or more isolation transformers are used, the shield should not be connected to the ground of the source. Any balanced cable that connects two pieces of equipment should have the shield connected at only one end.

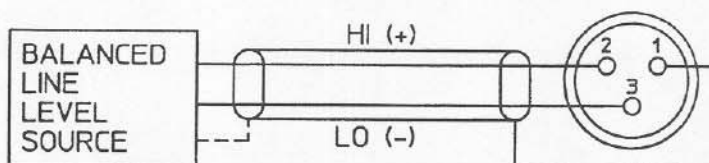

UNBALANCED INPUT WIRING

Connect the "hot" lead of the cable to pin 2 of the XLR connector and the shield to pin 1 of the XLR connector. To avoid a level loss of 6 dB, short Pin 1 and 3 of the XLR connector. If noise occurs as a result of this connection, disconnect it.

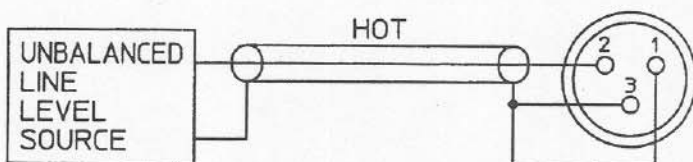

BALANCED OUTPUT WIRING

Connect the noninverting (+) lead of the cable to pin 2 of the XLR connector and the inverting (-) lead to pin 3 of the XLR connector. If an isolation transformer is used, the shield should not be connected to the Dx34 ground. Tie the shield to the receiving unit.

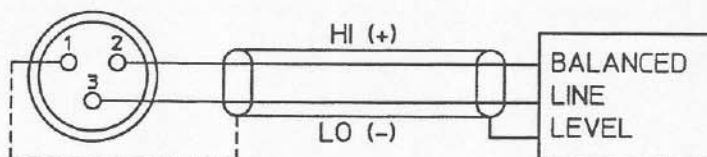

UNBALANCED OUTPUT WIRING

Connect the "hot" lead of the cable to pin 2 of the XLR connector and the shield to pin 1 of the XLR connector. To avoid a level loss of 6 dB, short Pin 1 and 3 of the XLR connector. If noise occurs as a result of this connection, disconnect it.

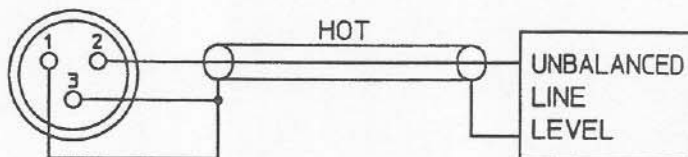

POSITION OF THE GROUND LIFT SWITCH

The ground lift switch helps prevent ground loops. It separates the circuit ground from the housing. If more than one unit in a common case has electrical contact (e.g., installation in a rack), all ground lift switches except one should be in the "UNGROUNDING" position. This is typical, but there are exceptions. Sometimes the optimum position of the ground lift switch can only be determined by trial and error.

CIRCUIT GND TO CHASSIS SWITCH



4.11 MIDI

This section contains information for programmers who wish to write software for the Dx34. All the commands needed to transmit or receive data over the MIDI interface are defined.

A MIDI data transfer is only possible if a MIDI receive channel has been set (OMNI, 1 - 16). With MIDI channel off, no communication will take place (see section 6.8).

GENERAL MIDI COMMANDS:

Program Change	MIDI-byte	Description
	0xCn (hex)	n = MIDI CHANNEL 0-15
	0xxx xxx (bin)	1..10 = PROGRAM NUMBER 1..10

MIDI SYSTEM EXCLUSIVE IMPLEMENTATION:

This command sequence requests the Dx34 to report its identity number.

Identity Request (recognized)	MIDI-byte	Description
	0xF0	SYSTEM EXCLUSIVE
	0x7E	UNIVERSAL SYSTEM EXCLUSIVE NON-REAL TIME HEADER
	0x0n	MIDI CHANNEL NUMBER 0-15, 0x7F = ALL CHANNELS
	0x06	GENERAL INFORMATION
	0x01	IDENTITY REQUEST
	0xF7	EOX

The Dx34 transmits this identity code in answer to an identity request. The following numbers are transmitted: ID number 118, the Dx34 device ID number 34, a three-byte device code number and the revision number

Identity Reply (transmitted when identity request is received)	MIDI-byte	Description
	0xF0	SYSTEM EXCLUSIVE
	0x7E	UNIVERSAL SYSTEM EXCLUSIVE NONREAL-TIME HEADER
	0x0n	MIDI CHANNEL NUMBER 0-15, 0x7F = ALL CHANNELS
	0x06	GENERAL INFORMATION
	0x02	IDENTITY REPLY
	0x76	EV ID: NUMBER 118
	0x22	Dx34 ID: 34
	DEV_CODE	RESERVED THREE BYTE DEVICE CODE
	REVISION	REVISION: FOUR DIGIT ASCII CODE
	0xF7	EOX

This command sequence requests the Dx34 to transmit the program currently in the buffer.

Current Program Dump Request (recognized)	MIDI-byte	Description
	0xF0	SYSTEM EXCLUSIVE
	0x00, 0x00	EXTENDED ID (TWO BYTES)
	0x76	EV ID: NUMBER 118
	0x0n	MIDI CHANNEL NUMBER: 0-15, 0X7F = ALL CHANNELS
	0x22	Dx34 ID: 34
	0x11	FUNCTION ID: CURRENT PROGRAM DUMP REQUEST
	0xF7	EOX

4 OPERATION AND INSTALLATION

Here only the program currently in the buffer is transmitted or received. USER programs are not altered.

Current Program	MIDI-byte	Description
Dump Request (recognized + transmitted)	0xF0	SYSTEM EXCLUSIVE
	0x00, 0x00	EXTENDED ID (TWO BYTES)
	0x76	EV ID: NUMBER 118
	0x0n	MIDI CHANNEL NUMBER: 0-15, 0X7F = ALL CHANNELS
	0x22	Dx34 ID: 34
	0x31	FUNCTION ID: CURRENT PROGRAM DUMP
	DATA	8/7 CODE (72 BYTE)
	CHECKS	CHECKSUM OF RECEIVED DATA (7 BIT, 2'S COMPLEMENT)
	0xF7	EOX

This command sequence requests the Dx34 to transmit all 30 USER programs.

All User Programs	MIDI-byte	Description
Dump Request (recognized)	0xF0	SYSTEM EXCLUSIVE
	0x00, 0x00	EXTENDED ID (TWO BYTES)
	0x76	EV ID: NUMBER 118
	0x0n	MIDI CHANNEL NUMBER: 0-15, 0X7F = ALL CHANNELS
	0x22	Dx34 ID: 34
	0x12	FUNCTION ID: ALL PROGRAMS DUMP REQUEST
	0xF7	EOX

The Dx34 transmits or receives all 30 USER programs. This procedure lasts approximately three seconds. All user programs are overwritten. The program currently in the buffer is not altered.

All User Programs	MIDI-byte	Description
Dump Request (recognized + transmitted)	0xF0	SYSTEM EXCLUSIVE
	0x00, 0x00	EXTENDED ID (TWO BYTES)
	0x76	EV ID: NUMBER 118
	0x0n	MIDI CHANNEL NUMBER: 0-15, 0X7F = ALL CHANNELS
	0x22	Dx34 ID: 34
	0x32	FUNCTION ID: ALL PROGRAMS DUMP
	DATA	8/7 CODE
	CHECKS	CHECKSUM OF RECEIVED DATA (7 BIT, 2'S COMPLEMENT)
	0xF7	EOX

This information is transmitted if a dump was received and processed.

Dump Processed (transmitted)	MIDI-byte	Description
	0xF0	SYSTEM EXCLUSIVE
	0x00, 0x00	EXTENDED ID (TWO BYTES)
	0x76	EV ID: NUMBER 118
	0x0n	MIDI CHANNEL NUMBER: 0-15, 0X7F = ALL CHANNELS
	0x22	Dx34 ID: 34
	0x20	FUNCTION ID: DUMP PROCESSED
	0xF7	EOX

This sequence addresses the output channel mutes of the unit.

MIDI Mute (recognized)	MIDI-byte	Description
	0xF0	SYSTEM EXCLUSIVE
	0x00, 0x00	EXTENDED ID (TWO BYTES)
	0x76	EV ID: NUMBER 118
	0x0n	MIDI CHANNEL NUMBER: 0-15, 0X7F = ALL CHANNEL
	0x22	Dx34 ID: 34
	0x1F	FUNCTION ID: MIDI MUTE
	mBits	BIN: 0000xxxx x: 1 = MUTED, 0 = NON MUTED (LS BIT: CHANNEL 1)
	0xF7	EOX

OPERATION AND INSTALLATION 4

In the listing below, a special parameter of the program currently in the buffer is altered.

Single Parameter	MIDI-byte	Description
Adjust (transmitted + received)	0xF0	SYSTEM EXCLUSIVE
	0x00, 0x00	EXTENDED ID (TWO BYTES)
	0x76	EV ID: NUMBER 118
	0x0n	MIDI CHANNEL NUMBER: 0-15, 0x7F = ALL CHANNEL
	0x22	Dx34 ID: 34
	0x30	FUNCTION ID: MIDI MUTE
	NUMBER	PARAMETER NUMBER
	LSB	7 BIT DATA LSB (0-127)
	MSB1	7 BIT DATA MSB1 (NOT NECESSARY)
	MSB2	7 BIT DATA MSB2 (NOT NECESSARY)
	0xF7	EOX

Parameter Numbers (decimal):

STEREO TWO-WAY

Channel 1, LOW:	Channel 2, HIGH:	Channel 3, LOW:	Channel 4, HIGH:	Input Channel:
4 LOCUT FREQ	20 HIPASS FREQ	41 LOCUT FREQ	57 HIPASS FREQ	LEFT:
5 LOCUT RESP	21 HIPASS RESP	42 LOCUT RESP	58 HIPASS RESP	0 MASTER DELAY
6 LOSHELV FREQ	22 PEQ 1 FREQ	43 LOSHELV FREQ	59 PEQ 1 FREQ	1 MASTER PEQ FREQ
7 LOSHELV SLOPE	23 PEQ 1 Q	44 LOSHELV SLOPE	60 PEQ 1 Q	2 MASTER PEQ Q
8 LOSHELV GAIN	24 PEQ 1 GAIN	45 LOSHELV GAIN	61 PEQ 1 GAIN	3 MASTER PEQ GAIN
9 PEQ FREQ	25 PEQ 2 FREQ	46 PEQ FREQ	62 PEQ 2 FREQ	
10 PEQ Q	26 PEQ 2 Q	47 PEQ Q	63 PEQ 2 Q	RIGHT:
11 PEQ GAIN	27 PEQ 2 GAIN	48 PEQ GAIN	64 PEQ 2 GAIN	37 MASTER DELAY
12 LOPASS FREQ	28 HISHELV FREQ	49 LOPASS FREQ	65 HISHELV FREQ	38 MASTER PEQ FREQ
13 LOPASS RESP	29 HISHELV SLOPE	50 LOPASS RESP	66 HISHELV SLOPE	39 MASTER PEQ Q
14 DELAY ALIGNM	30 HISHELV GAIN	51 DELAY ALIGNM	67 HISHELV GAIN	40 MASTER PEQ GAIN
15 POLARITY	31 DELAY ALIGNM	52 POLARITY	68 DELAY ALIGNM	
16 OUTPUT GAIN	32 POLARITY	53 OUTPUT GAIN	69 POLARITY	
17 LIMIT THRESH	33 OUTPUT GAIN	54 LIMIT THRESH	70 OUTPUT GAIN	
18 LIMIT DECAY	34 LIMIT THRESH	55 LIMIT DECAY	71 LIMIT THRESH	
19 LIMIT HOLD	35 LIMIT DECAY	56 LIMIT HOLD	72 LIMIT DECAY	
	36 LIMIT HOLD		73 LIMIT HOLD	

THREE-WAY/SUB + ONE

Channel 1, LOW:	Channel 2, MID:	Channel 3, HIGH:	Channel 4, Direct:	Input Channel:
1 LOCUT FREQ	17 HIPASS FREQ	33 HIPASS FREQ	50 DELAY	0 MASTER DELAY 1-3
2 LOCUT RESP	18 HIPASS RESP	34 HIPASS RESP	51 POLARITY	
3 LOSHELV FREQ	19 PEQ 1 FREQ	35 PEQ 1 FREQ	52 OUTPUT GAIN	
4 LOSHELV SLOPE	20 PEQ 1 Q	36 PEQ 1 Q	53 LOW & CH4 MODE	
5 LOSHELV GAIN	21 PEQ 1 GAIN	37 PEQ 1 GAIN		
6 PEQ FREQ	22 PEQ 2 FREQ	38 PEQ 2 FREQ		
7 PEQ Q	23 PEQ 2 Q	39 PEQ 2 Q		
8 PEQ GAIN	24 PEQ 2 GAIN	40 PEQ 2 GAIN		
9 LOPASS FREQ	25 LOPASS FREQ	41 HISHELV FREQ		
10 LOPASS RESP	26 LOPASS RESP	42 HISHELV SLOPE		
11 DELAY ALIGNM	27 DELAY ALIGNM	43 HISHELV GAIN		
12 POLARITY	28 POLARITY	44 DELAY ALIGNM		
13 OUTPUT GAIN	29 OUTPUT GAIN	45 POLARITY		
14 LIMIT THRESH	30 LIMIT THRESH	46 OUTPUT GAIN		
15 LIMIT DECAY	31 LIMIT DECAY	47 LIMIT THRESH		
16 LIMIT HOLD	32 LIMIT HOLD	48 LIMIT DECAY		
		49 LIMIT HOLD		

4 OPERATION AND INSTALLATION

FOUR-WAY

Channel 1, LOW:	Channel 2, LOW-MID:	Channel 3, HIGH-MID:	Channel 4, HIGH:	Input Channel:
1 LOCUT FREQ	17 HIPASS FREQ	30 HIPASS FREQ	46 HIPASS FREQ	0 MASTER DELAY
2 LOCUT RESP	18 HIPASS RESP	31 HIPASS RESP	47 HIPASS RESP	
3 LOSHELV FREQ	19 PEQ FREQ	32 PEQ 1 FREQ	48 PEQ 1 FREQ	
4 LOSHELV SLOPE	20 PEQ Q	33 PEQ 1 Q	49 PEQ 1 Q	
5 LOSHELV GAIN	21 PEQ GAIN	34 PEQ 1 GAIN	50 PEQ 1 GAIN	
6 PEQ FREQ	22 LOPASS FREQ	35 PEQ 2 FREQ	51 PEQ 2 FREQ	
7 PEQ Q	23 LOPASS RESP	36 PEQ 2 Q	52 PEQ 2 Q	
8 PEQ GAIN	24 DELAY ALIGNM	37 PEQ 2 GAIN	53 PEQ 2 GAIN	
9 LOPASS FREQ	25 POLARITY	38 LOPASS FREQ	54 HISHELV FREQ	
10 LOPASS RESP	26 OUTPUT GAIN	39 LOPASS RESP	55 HISHELV SLOPE	
11 DELAY ALIGNM	27 LIMIT THRESH	40 DELAY ALIGNM	56 HISHELV GAIN	
12 POLARITY	28 LIMIT DECAY	41 POLARITY	57 DELAY ALIGNM	
13 OUTPUT GAIN	29 LIMIT HOLD	42 OUTPUT GAIN	58 POLARITY	
14 LIMIT THRESH		43 LIMIT THRESH	59 OUTPUT GAIN	
15 LIMIT DECAY		44 LIMIT DECAY	60 LIMIT THRESH	
16 LIMIT HOLD		45 LIMIT HOLD	61 LIMIT DECAY	
			62 LIMIT HOLD	

MIDI Implementation Chart

Function		Transmitted	Recognized	Remark
Basic Channel	Default Changed	X X	1-16, -OFF- 1-16, -OFF-	Memorized
Mode	Default Messages Altered	X X	Mode 1,3 X	Memorized
Note Number	True Voice	X	X	
Velocity	Note On Note Off	X X	X X	
After Touch	Key's Ch's	X X	X X	
Pitch Bend		X	X	
Control Change		X	X	
Prog Change	True	X	0 - 10 1 - 10	
System	Exclusive	O	O	
System Common	Song Pos Song Sel Tune	X X X	X X X	
System Real Time	Clock Commands	X X	X O	
Aux Messages	Local ON/OFF All Notes OFF Active Sense Reset	X X X X	X X X O	
NOTES				

Mode 1: OMNI ON, POLY
Mode 3: OMNI OFF, POLY

Mode 2: OMNI ON, MONO
Mode 4: OMNI OFF, MONO

O:Yes
X:No

The number of parameters that are available to the user depends upon the configuration and operating mode of the Dx34. Adjustable parameters are available in each of the four output channels and the input channel of the two way configuration. The channel number and name (LO, MID, HI...) appears at the top left-hand side of the display. The parameter name appears next to it. The second line contains the parameter value and the corresponding bar graph. The diagram on the right shows a typical example of a parameter window.

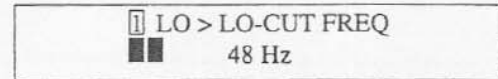

The channel name convention for each configuration appears below. The abbreviations used in the display are indicated in parenthesis.

STEREO TWO-WAY,

AND TWO-WAY DUAL MONO: Channel 1 = Left Low (LO)
 Channel 2 = Left High (HI)
 Channel 3 = Right Low (LO)
 Channel 4 = Right High (HI)

THREE-WAY/SUB + ONE: Channel 1 = Sub/Low (LO)
 Channel 2 = Mid (MD)
 Channel 3 = High (HI)
 Channel 4 = Direct

FOUR-WAY: Channel 1 = Low (LO)
 Channel 2 = Low-Mid (LM)
 Channel 3 = High-Mid (HM)
 Channel 4 = High (HI)

The following sections contain descriptions of all parameters, their settings and other useful information.

5.1 PARAMETERS IN PRESET MODE

The parameters for the stereo two-way configuration are as follows:

Channel 1, LOW:	Channel 2, HIGH:	Input Channel:
LIMIT THRESH (Parameters are valid also for channel 3)	LIMIT THRESH (parameters are valid also for channel 4)	MASTER DELAY

The parameters for the three-way/sub + one configuration are as follows:

Channel 1, LOW:	Channel 2, MID:	Channel 3, HIGH:	Channel 4, Direct:	Input Channel:
LIMIT THRESH	LIMIT THRESH	LIMIT THRESH	CH4 DELAY	MASTER DLY 1-3

The parameters for the four-way configuration are as follows:

Channel 1, LOW:	Channel 2, LOW-MID:	Channel 3, HIGH-MID:	Channel 4, HIGH:	Input Channel:
LIMIT THRESH	LIMIT THRESH	LIMIT THRESH	LIMIT THRESH	MASTER DLY

5 PARAMETERS

5.2 PARAMETERS IN FULL-EDIT MODE

All parameters are accessible in full-edit mode. There are slight differences in the parameters, depending upon the chosen configuration. The following tables give an overview of the parameter list.

In stereo two-way configuration, the following parameters are available.

Channel 1, LOW:	Channel 2, HIGH:	Input Channel:
LOCUT FREQ	HIPASS FREQ	MASTER PEQ FREQ
LOCUT RESP	HIPASS RESP	MASTER PEQ Q
LOSHELV FREQ	PEQ 1 FREQ	MASTER PEQ GAIN
LOSHELV SLOPE	PEQ 1 Q	MASTER DELAY
LOSHELV GAIN	PEQ 1 GAIN	
PEQ FREQ	PEQ 2 FREQ	
PEQ Q	PEQ 2 Q	
PEQ GAIN	PEQ 2 GAIN	
LOPASS FREQ	HISHELV FREQ	
LOPASS RESP	HISHELV SLOPE	
DELAY ALIGNM	HISHELV GAIN	
POLARITY	DELAY ALIGNM	
OUTPUT GAIN	POLARITY	
LIMIT THRESH	OUTPUT GAIN	
LIMIT DECAY	LIMIT THRESH	
LIMIT HOLD	LIMIT DECAY	
(Parameters are valid also for channel 3)	LIMIT HOLD	
	(Parameters are valid also for channel 4)	

The parameters for the three-way/sub + one configuration are as follows:

Channel 1, LOW:	Channel 2, MID:	Channel 3, HIGH:	Channel 4, Direct:	Input Channel:
LOCUT FREQ	HIPASS FREQ	HIPASS FREQ	CH4 DELAY	MASTER DLY 1-3
LOCUT RESP	HIPASS RESP	HIPASS RESP	CH4 POLARITY	
LOSHELV FREQ	PEQ 1 FREQ	PEQ 1 FREQ	CH4 OUTPUT GAIN	
LOSHELV SLOPE	PEQ 1 Q	PEQ 1 Q	LOW & CH4 MODE	
LOSHELV GAIN	PEQ 1 GAIN	PEQ 1 GAIN		
PEQ FREQ	PEQ 2 FREQ	PEQ 2 FREQ		
PEQ Q	PEQ 2 Q	PEQ 2 Q		
PEQ GAIN	PEQ 2 GAIN	PEQ 2 GAIN		
LOPASS FREQ	LOPASS FREQ	HISHELV FREQ		
LOPASS RESP	LOPASS RESP	HISHELV SLOPE		
DELAY ALIGNM	DELAY ALIGNM	HISHELV GAIN		
POLARITY	POLARITY	DELAY ALIGNM		
OUTPUT GAIN	OUTPUT GAIN	POLARITY		
LIMIT THRESH	LIMIT THRESH	OUTPUT GAIN		
LIMIT DECAY	LIMIT DECAY	LIMIT THRESH		
LIMIT HOLD	LIMIT HOLD	LIMIT DECAY		
		LIMIT HOLD		

In the four-way configuration, the following parameters are available.

Channel 1, LOW:	Channel 2, LOW-MID:	Channel 3, HIGH-MID:	Channel 4, HIGH:	Input Channel:
LOCUT FREQ	HIPASS FREQ	HIPASS FREQ	HIPASS FREQ	MASTER DELAY
LOCUT RESP	HIPASS RESP	HIPASS RESP	HIPASS RESP	
LOSHELV FREQ	PEQ FREQ	PEQ 1 FREQ	PEQ 1 FREQ	
LOSHELV SLOPE	PEQ Q	PEQ 1 Q	PEQ 1 Q	
LOSHELV GAIN	PEQ GAIN	PEQ 1 GAIN	PEQ 1 GAIN	
PEQ FREQ	LOPASS FREQ	PEQ 2 FREQ	PEQ 2 FREQ	
PEQ Q	LOPASS RESP	PEQ 2 Q	PEQ 2 Q	
PEQ GAIN	DELAY ALIGNM	PEQ 2 GAIN	PEQ 2 GAIN	
LOPASS FREQ	POLARITY	LOPASS FREQ	HISHELV FREQ	
LOPASS RESP	OUTPUT GAIN	LOPASS RESP	HISHELV SLOPE	
DELAY ALIGNM	LIMIT THRESH	DELAY ALIGNM	HISHELV GAIN	
POLARITY	LIMIT DECAY	POLARITY	DELAY ALIGNM	
OUTPUT GAIN	LIMIT HOLD	OUTPUT GAIN	POLARITY	
LIMIT THRESH		LIMIT THRESH	OUTPUT GAIN	
LIMIT DECAY		LIMIT DECAY	LIMIT THRESH	
LIMIT HOLD		LIMIT HOLD	LIMIT DECAY	
			LIMIT HOLD	

5.3 DESCRIPTION OF PARAMETERS

This is a description of the unit's parameters which may appear in any mode. Value ranges or possible settings are specified for all parameters.

In edit mode, either the first parameter in the list of parameters will appear, or the last parameter edited will appear.

LO-CUT FREQ

This sets the cut-off frequency of the low-cut filter in the LO channel. This filter can be used to suppress infrasonic signals.

Value range: 20 - 200 Hz

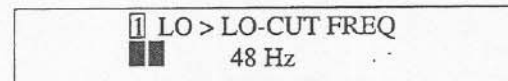

LO-CUT RESP

This parameter determines the response of the Low-Cut filter. Various filter slopes and Q-factors can be set in the transition range and the filter can be switched off. It is possible to set "B₀" alignments (step-down mode) which gives a resonant boost at the filter cut-off frequency.

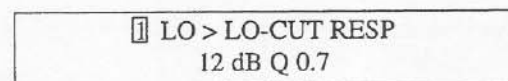

The diagram on the right and the filter response curves section in the Description and Features section contain examples of possible settings.

- Settings:
- thru
 - 6 dB
 - 12 dB Q 0.5
 - 12 dB Q 0.6
 - 12 dB Q 0.7
 - 12 dB Q 0.8
 - 12 dB Q 1.0
 - 12 dB Q 1.2
 - 12 dB Q 1.5
 - 12 dB Q 2.0

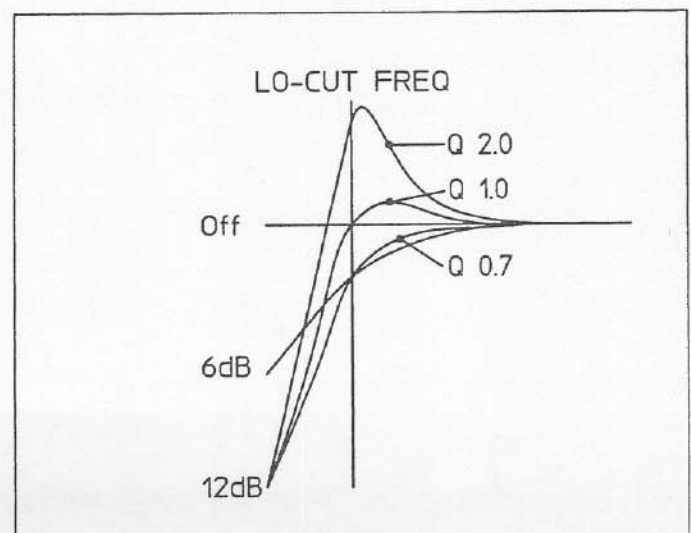

5 PARAMETERS

LOSHELV FREQ

The low channel features a low-shelving filter. This parameter sets the upper cut-off frequency, i.e., the frequency below which the filter takes effect.

Value range: 50 - 500 Hz

LOSHELV SLOPE

The slope of the filter can be either 6 dB/octave or 12 dB/octave. The 1st-order slope (6 dB) is useful for most EQ purposes. The 2nd-order slope (12 dB) can be used in situations where it is required. Typical uses are: compensating for room acoustics, adjusting for acoustic coupling (from multiple cabinets) and setting a user preference curve.

Value range: 6 dB, 12 dB or (thru)

LOSHELV GAIN

Low-shelving gain is used to set the amount of boost or cut of the low-shelving EQ. The diagram on the right shows various filter characteristics at different gain settings.

Please turn to the Filter-Response Curves section for further examples.

Value range: ± 12 dB

PEQ (1,2) FREQ, MASTER PEQ FREQ

The Dx34 has several parametric peak-dip filters (parametric equalizers, PEQ's). There are two such filters in the mid and high channels. These are designated PEQ 1 and PEQ 2. The remaining channels always have a parametric filter which is simply called PEQ. The two-way input has a parametric filter termed MASTER PEQ. Since this filter is in the input master, it affects the broadband frequency response.

The center frequencies of the equalizer filter are set with the PEQ FREQ (PEQ 1 FREQ, PEQ 2 FREQ, MASTER PEQ FREQ) parameters.

Value ranges: 20-2,500 Hz (LO, 2-WAY)
50-20,000 Hz (HI, 2-WAY)

20-5,000 Hz (LO, 3-WAY)
50-12,500 Hz (MD, 3-WAY)
500-20,000 Hz (HI, 3-WAY)

20-5,000 Hz (LO, 4-WAY)
20-5,000 Hz (LM, 4-WAY)
500-20,000 Hz (HM, 4-WAY)
500-20,000 Hz (HI, 4-WAY)

20-20000 Hz (MASTER PEQ)

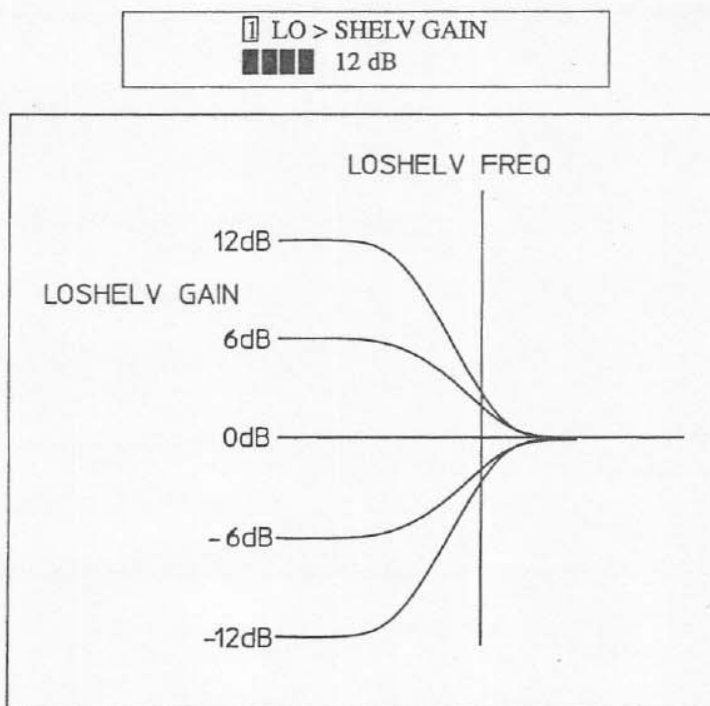
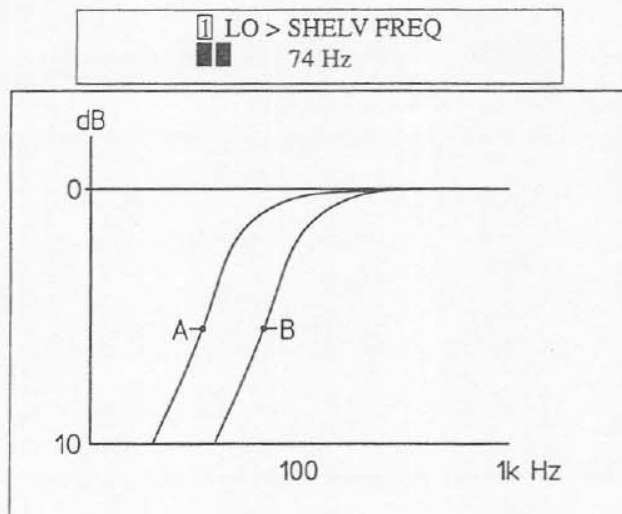

PEQ (1,2) Q, MASTER PEQ Q

The Q parameter in PEQ 1 Q, PEQ 2 Q and MASTER PEQ Q set the quality-factor (bandwidth) of the parametric EQ. A high-Q value produces a narrow-band filter, a low-Q value produces a broad-band filter. The filter response curves section shows several filter responses with the appropriate parameter settings. These examples demonstrate the effect of the Q parameter.

Value range: 0.4 - 20.0

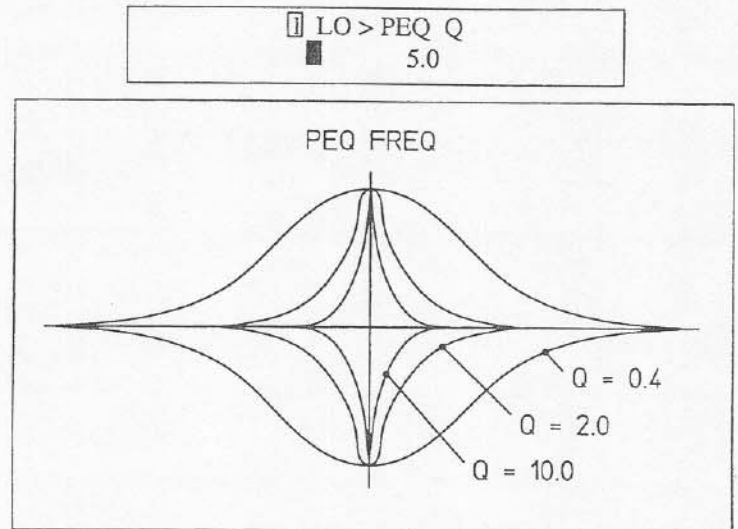

PEQ (1,2) GAIN, MASTER PEQ GAIN

The GAIN parameter in PEQ 1, PEQ 2 and MASTER PEQ sets the amount of boost or cut in the parametric. The resolution is one dB.

Value range: ±12 dB

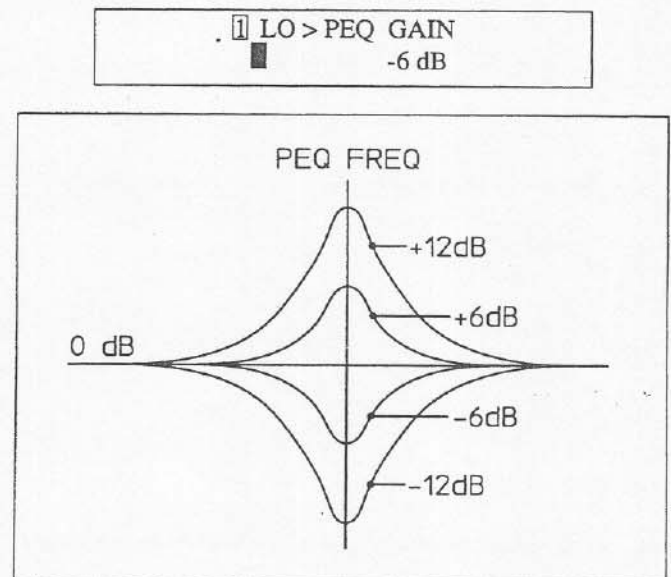

LO-PASS FREQ

The crossover filter consists of a low pass in one channel and a high pass in the adjacent channel. The cutoff frequency for the low pass of the crossover filter is set with this parameter. The corresponding high pass will normally be set at the same cut-off frequency.

- Value ranges:
- 50-2,500 Hz (LO, 2-WAY)
 - 30-3,000 Hz (LO, 3-WAY)
 - 500-12,500 Hz (MD, 3-WAY)
 - 30-3,000 Hz (LO, 4-WAY)
 - 160-3,000 Hz (LM, 4-WAY)
 - 800-12,500 Hz (HM, 4-WAY)

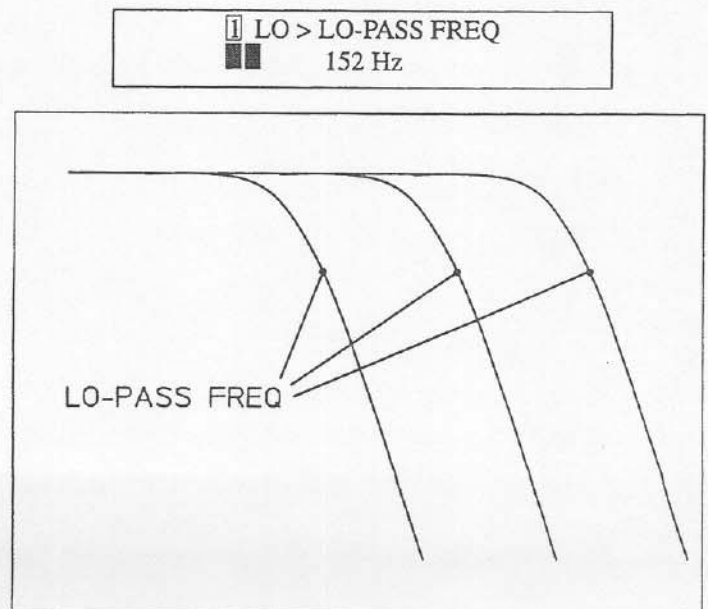

5 PARAMETERS

LO-PASS RESP

This determines the filter characteristics for the low pass of the crossover filter. Various filter slopes and filter responses (Bessel, Butterworth and Linkwitz-Riley) can be selected or the filter can be by-passed. The corresponding high pass will normally be set to the same filter type.

Settings:

- thru
- 6 dB
- Bessel 12 dB
- Butter 12 dB
- Linkwitz 12 dB
- Bessel 18 dB
- Butter 18 dB
- Bessel 24 dB
- Butter 24 dB
- Linkwitz 24 dB

LO > LO-PASS RESP
BUTTER 18 dB

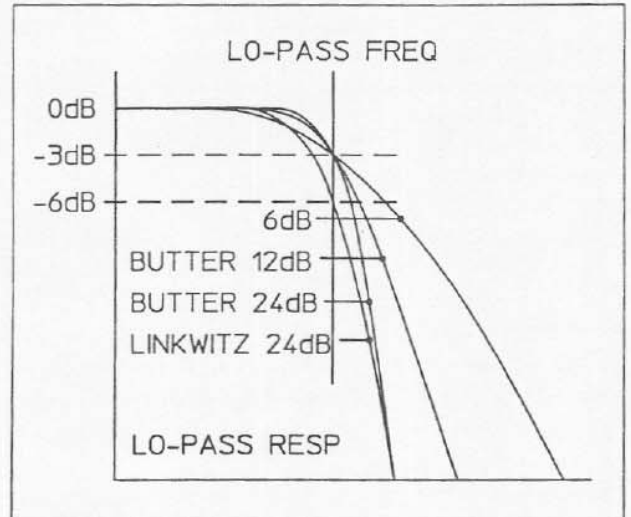

DELAY ALIGNM

This sets the time delay in channels 1-4. These delays enable the user to compensate for different propagation times that result from different radiation planes of the individual loudspeakers.

Value ranges:

- 0 ms to 10 ms
- 0 μ s to 10005 μ s
- 0 ft to 11 ft
- 0 in. to 135 in.
- 0 m to 3 m
- 0 cm to 343 cm

LO > LO-DELAY ALIGNM
 0 ms

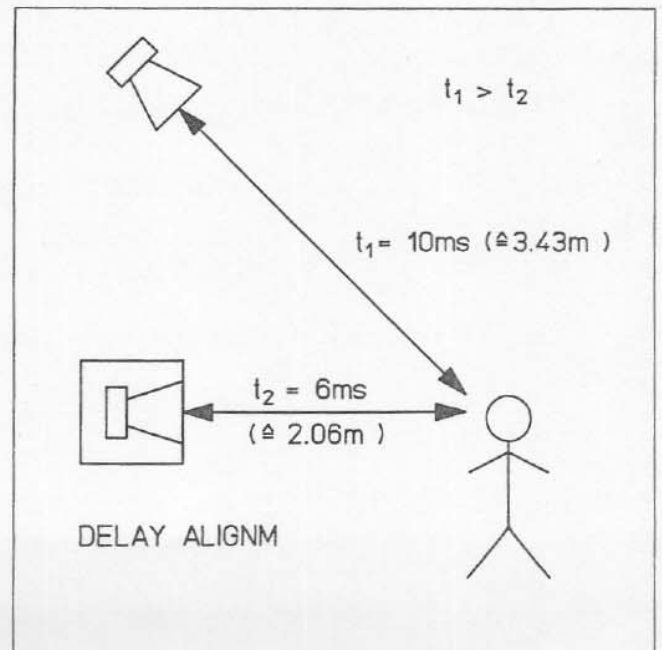

POLARITY

Selects the polarity of the signal in each individual output 1-4. The characteristics of the selected crossover type may make it necessary to invert the signal in one channel.

Settings: not inverted
inverted



OUTPUT GAIN

This is a digital gain section to compensate for different driver efficiencies.

Value range: -24 dB to +6 dB

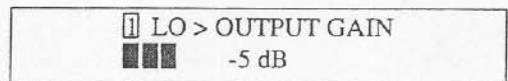

LIMIT THRESH

This parameter sets the threshold of the digital limiter. If a signal peak exceeds this threshold it will be limited to the threshold value.

The limiter threshold can be calibrated in dB (relative to full modulation), dBu (0.775 V. ref.) or volts. The units are selected in the option menu (see chapter 6.5).

Value ranges: -21 dB to 0 dB
0 dBu to 21 dBu
0.7 V to 8.7 V

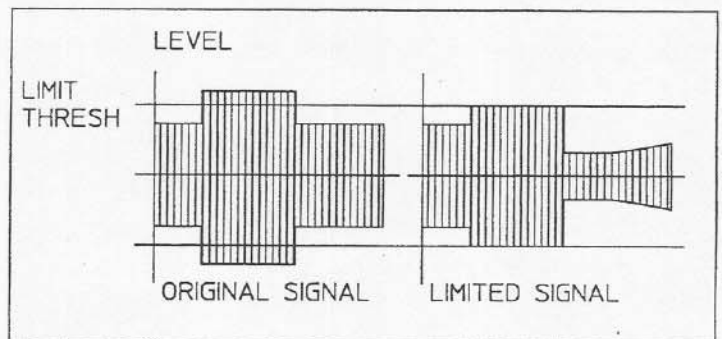
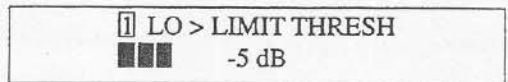

LIMIT DECAY

This parameter sets the decay time of the limiter. If the signal level falls below the limiter threshold, the signal returns to its original value. The decay time is expressed in dB/s.

Value range: 1 dB/s to 100 dB/s

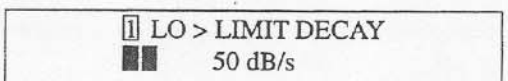

LIMIT HOLD

This sets the hold time of the limiter. When the signal level falls below the limiter threshold, the amount of gain reduction that occurred during the offending transient continues (is held) for this amount of time. The limiter will not begin to return to a state of non-limiting until after the hold time has expired. If signal peaks continue to exceed the limiter threshold value, the signal will be repeatedly attenuated. An audible "pumping" effect can be heard under these conditions. This pumping effect can be significantly reduced by judicious use of the hold time parameter.

Value range: 0 ms to 100 ms

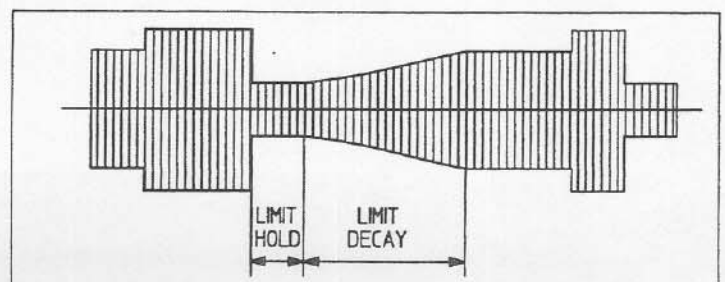
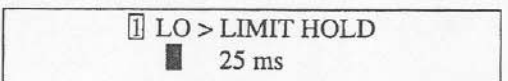

5 PARAMETERS

HI-PASS FREQ

The crossover filter consists of a low pass in one channel and a high pass in the adjacent channel. This parameter is used to set the cutoff frequency for the high pass section of the crossover. The corresponding low pass will normally be set at the same cutoff frequency.

Value ranges:

- 50-2,500 Hz (HI, 2-WAY)
- 50-3,000 Hz (MD, 3-WAY)
- 500-12,500 Hz (HI, 3-WAY)
- 30-3,000 Hz (LM, 4-WAY)
- 125-3,000 Hz (HM, 4-WAY)
- 500-12,500 Hz (HI, 4-WAY)

HI > HI-PASS FREQ
 152 Hz

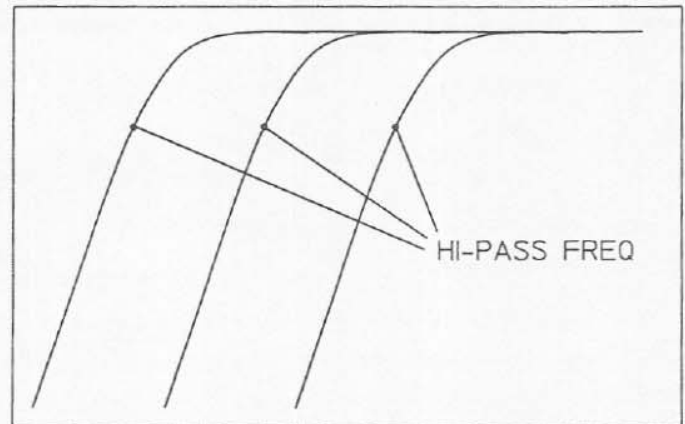

HI > HI-PASS RESP
 BUTTER 18 dB

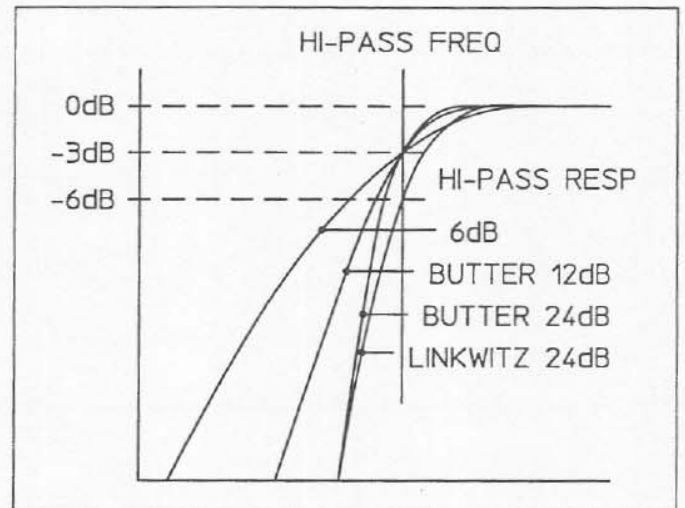

HI > SHELV FREQ
 3500 Hz

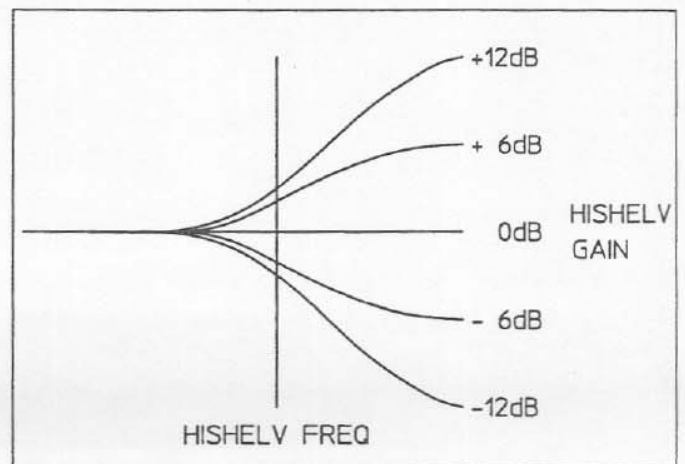

HI-PASS RESP

This parameter determines the filter characteristics for the high pass of the crossover filter. Various filter slopes and filter characteristics (Bessel, Butterworth and Linkwitz-Riley) can be selected and the filter can be bypassed. The corresponding low-pass will normally be set to the same filter type.

Settings:

- thru
- 6 dB
- Bessel 12 dB
- Butter 12 dB
- Linkwitz 12 dB
- Bessel 18 dB
- Butter 18 dB
- Bessel 24 dB
- Butter 24 dB
- Linkwitz 24 dB

HISHELV FREQ

A high-shelving filter is included in the high channel to allow boost or cut for the high frequencies. This parameter is used to set the cutoff frequency, i.e. the frequency from which the filter begins to take effect.

Value range: 1,000 - 10,000 Hz

HISHELV SLOPE

The slope of the filter can be either 6 dB/octave or 12 dB/octave. The 1st-order slope (6 dB) is useful for most EQ purposes. The 2nd-order slope (12 dB) can be used in situations where it is required. Typical uses are compensating for room acoustics, and setting a user preference curve.

Value range: 6 dB, 12 dB or (thru).

HISHELV GAIN

This parameter is used to set the boost or cut of the high-shelve filter.

Value range: 6 dB/octave slope: ± 12 dB
12 dB/octave slope: -12 dB to +6 dB

MASTER DELAY/MASTER DLY 1-3

This delay is in the master input section before the crossover. Therefore it affects all crossover channels. In the three-way/sub + one configuration, it affects channels 1-3, in the two-way and four-way configurations, it affects all four channels.

The delay units can be specified in milliseconds, feet, inches, meters or centimeters.

Value ranges: 2 ms to 1,000 ms
2 ft to 1,127 ft
27 in. to 13,521 in.
1 m to 343 m
70 cm to 34,345 cm

CH4 DELAY

This parameter appears only in the three-way/sub + one configuration. This parameter sets the delay time in channel four (DIRECT). This delay can be used to supply groups of loudspeakers with a delayed direct signal.

Value ranges: 2 ms to 1,000 ms
2 ft to 1,127 ft
27 in. to 13,521 in.
1 m to 343 m
70 cm to 34,345 cm

CH4 POLARITY

This parameter appears only in the three-way/sub + one configuration. It is used to select the polarity of the signal in output four.

Settings: not inverted
inverted

HI > SHELV SLOPE
6 dB

HI > SHELV GAIN
 +6 dB

MASTER DELAY
 500 ms

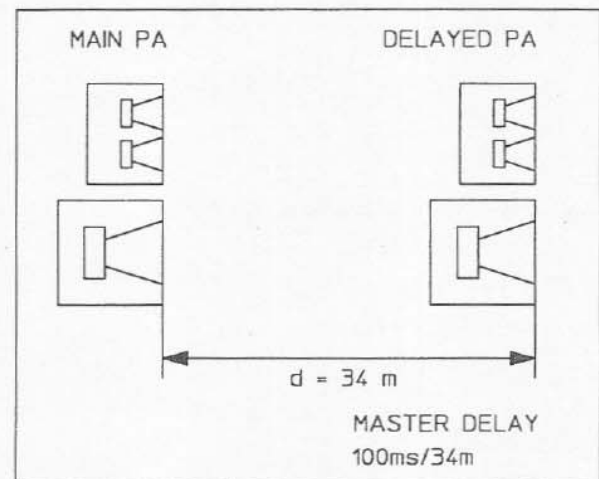

CH4 DELAY
 220 ms

CH4 POLARITY
NOT INVERTED

5 PARAMETERS

CH4 OUTPUT GAIN

This parameter appears only in the three-way/sub + one configuration. It is the digital gain section for output four.

Value range: -24 dB to +6 dB

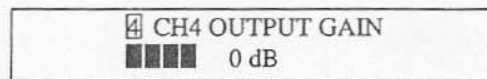

LO & CH4 MODE

This parameter appears only in the three-way/sub + one configuration. The input signal for channel one (LO) and channel four (DIRECT) is assigned with this software switch. In L/R position, the signal is derived from input one (Left) and applied to outputs 1 - 4. In the MONO position, inputs one and two are summed and applied to channels one and four, channels two and three continue to receive their signal from input one.

The mono sum feature accommodates stereo three-way + sub configurations when using two Dx34's (see the mode: three-way/sub + one block diagram in section 4.4).

Settings: L/R
 Mono

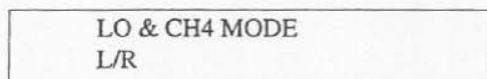

The Option menu contains a number of important additional functions and default settings.

The following functions are accessed with the select keys:

- setting of the LCD CONTRAST
- edit protection (LOCK)
- setting of the DELAY UNIT
- value of the limiter threshold (LIMIT THRESH IN)
- display mode of the level displays (VU DISPLAY MODE)
- setting of the MIDI CHANNEL
- transmission of MIDI data (MIDI DATA DUMP)
- function of MIDI OUT
- display of the software version number (Dx34 software)

1. Press the option key (11) to open the Option menu.
2. The option program used last appears on the display, e.g.:
3. Find the desired option by using the select keys (8, 9).
4. Use the rotary encoder (13) to set the Option values.
5. The option mode can be cancelled by pressing the option key (11) again or another mode key, (e.g. switching to edit mode by pressing the edit key).

6.1 SETTING THE LCD CONTRAST

The LCD contrast or viewing angle can be adjusted between -10 (viewed from below) and +10 (viewed from above).

6.2 EDIT PROTECTION (LOCK)

The Dx34 has an edit protection feature which can be enabled to prevent unauthorized changes to the settings.

To activate the edit protection feature, first press the key option (11) and select the lock store window. Then enter your code number using the rotary encoder (13) and confirm by pressing store (10) and enter (13), e.g.:

To alter any of the unit's settings, the display will show:

In this status, nothing can be entered with the keys.

To switch off edit protection, select the "LOCK" window again. The display shows:

Enter your code number and press store (10).

The following appears briefly on the display:

Lock is now disabled and parameters are accessible.

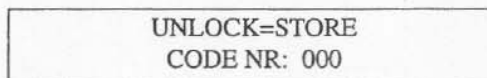
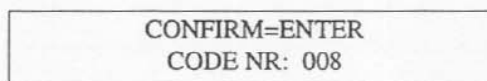
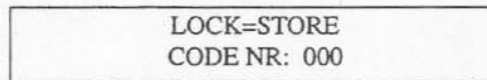
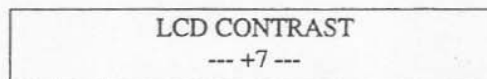
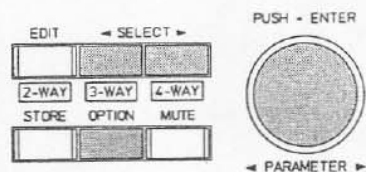
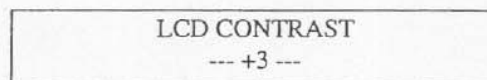
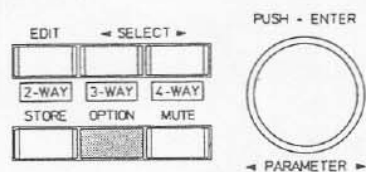

6 OPTION FUNCTIONS

NOTE:

If you have forgotten the code number you can switch the edit protection feature off again by pressing the keys: store (10) and mute (12) simultaneously while switching the unit on. To view the forgotten code, select the "LOCK" window in the option menu.

6.3 TWO-WAY PARAMETERS

The parameters for each of the two input channels may be set together for stereo operation or independently for dual mono operation.

TWO-WAY PARAMETERS
INDEPENDENT

6.4 SELECTING THE DELAY UNIT

The user can choose the delay units for the delay line in the Dx34.

The display then shows:

Distance settings are automatically converted into delay times.

Possible settings:

- milli-sec.
- µsec
- feet
- inch
- meter
- centimeter

DELAY UNIT
milli-sec

6.5 LIMITER THRESHOLD REFERENCE

The limiter threshold has three selectable references. They are:

dB FROM CLIP:

The value for the limiter threshold is in dB relative to clipping (0 dB = clipping).

dBu (0.775V):

The Limiter threshold is in dBu
(0 dBu = 0.775 V).

VOLTS:

The Limiter threshold is in volts.

LIMIT THRESH IN
dB from Clip

6.6 LEVEL INDICATOR RESPONSE

PEAK HOLD:

The Peak-Hold Function is switched on. This will help the user to set the level.

NO PEAK:

The Peak-Hold Function is switched off. The level display works normally with a short decay time constant of approximately 600 dB/second

SLOW:

In this setting, the dynamics of the display is slowed by a longer decay time (approximately 60 dB/second).

VU DISPLAY MODE
Peak hold

6.7 MIDI CHANNEL SELECTION

The MIDI channel on which the Dx34 is to transmit and receive MIDI data is set in this option. The setting also applies to transmitting and receiving System Exclusive Data (SysEx). The following may appear on the display:

MIDI CHANNEL
2

The following settings can be made with the rotary encoder:

- OFF** - The DSP does not react to any MIDI data. No MIDI data are transmitted. SysEx is switched off.
- OMNI** - The Dx34 can receive MIDI data on all 16 MIDI channels. Data is transmitted on channel one.
- 1 - 16** - The DSP only transmits and receives MIDI data on the MIDI channel selected between 1 and 16. This setting is equally applicable for SysEx data.

6.8 TRANSMISSION OF MIDI DATA (MIDI DUMP)

All user programs and system data of a Dx34 can be transmitted via MIDI, provided that the MIDI out socket of the Dx34 is connected to the MIDI in socket of a unit which can recognize this data, e.g. another Dx34, computer etc. Please ensure that the MIDI channels in both units correspond with each other.

The following may appear on the display:

MIDI DATA DUMP
START=ENTER

Pressing the rotary encoder (ENTER) activates the MIDI dump and all data is transmitted.

During transmission, the display shows the following:

SENDING MIDI
DATA DUMP..

The display then returns to its original state.

To transfer data back to the Dx34, connect the MIDI in socket of the Dx34 with the MIDI out socket of the transmission device. The MIDI dump must then be started on the transmission device (2nd Dx34, computer, etc.).

To control other devices from the Dx34, first ensure that all the units have the same configuration. To do so, transfer all device data using MIDI dump from the master to the connected slaves. All devices then have identical settings and are synchronized. The master Dx34 can then transmit all operating steps to the connected slaves. The settings are immediately activated.

6 OPTION FUNCTIONS

6.9 FUNCTION OF MIDI OUT

The function of the MIDI output can be selected here. The following settings can be made using the rotary encoder:

- send off** - The MIDI out socket is used as a MIDI through socket. All received MIDI data is retransmitted through MIDI out without being changed. If several Dx34 units are to be controlled from a single master, this setting should be used in the slave units.
- send on** - MIDI data dump, or MIDI linked control information, can be transmitted via the MIDI out socket. Select this setting to use the Dx34 as a master unit for other Dx34 units or to transfer data to other units.

The adjacent diagrams are intended to clarify the MIDI settings described here.

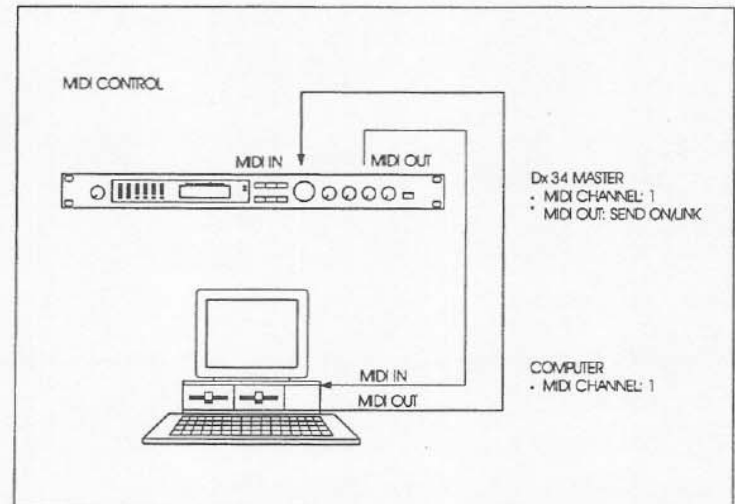
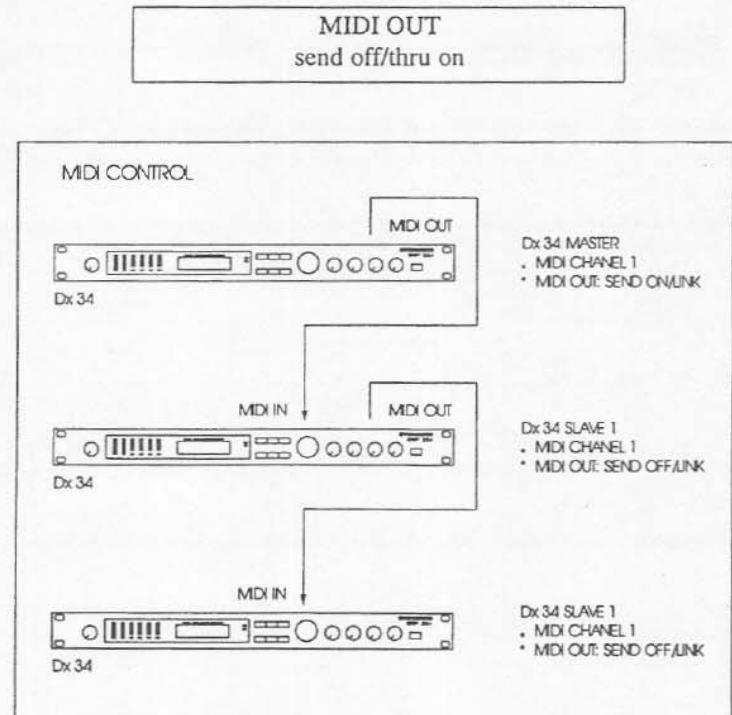

DX34
SOFTWARE V 1.00

6.10 SOFTWARE VERSION NUMBER

The display shows the software version of the Dx34's host processor, e.g. version 1.00.

SCHEMATIC DIAGRAMS

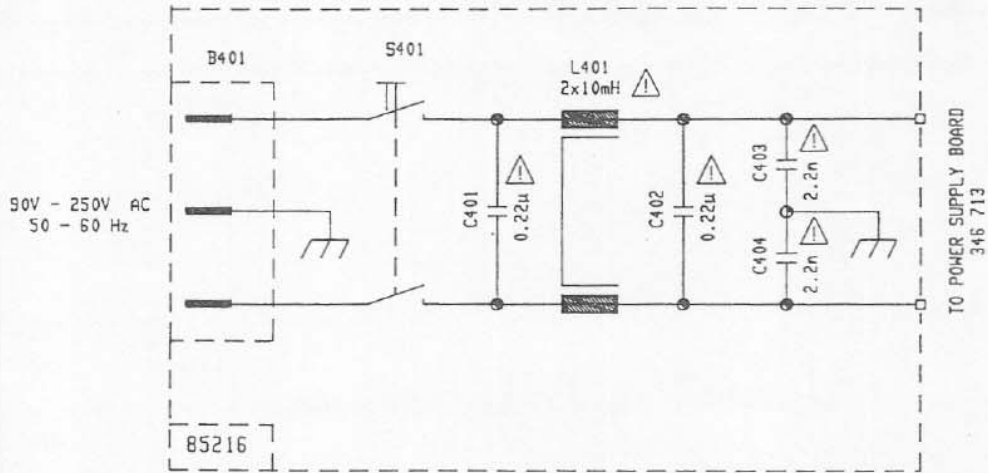

SAFETY COMPONENT
(MUST BE REPLACED BY ORIGINAL PART)

Line Filter Circuit Diagram

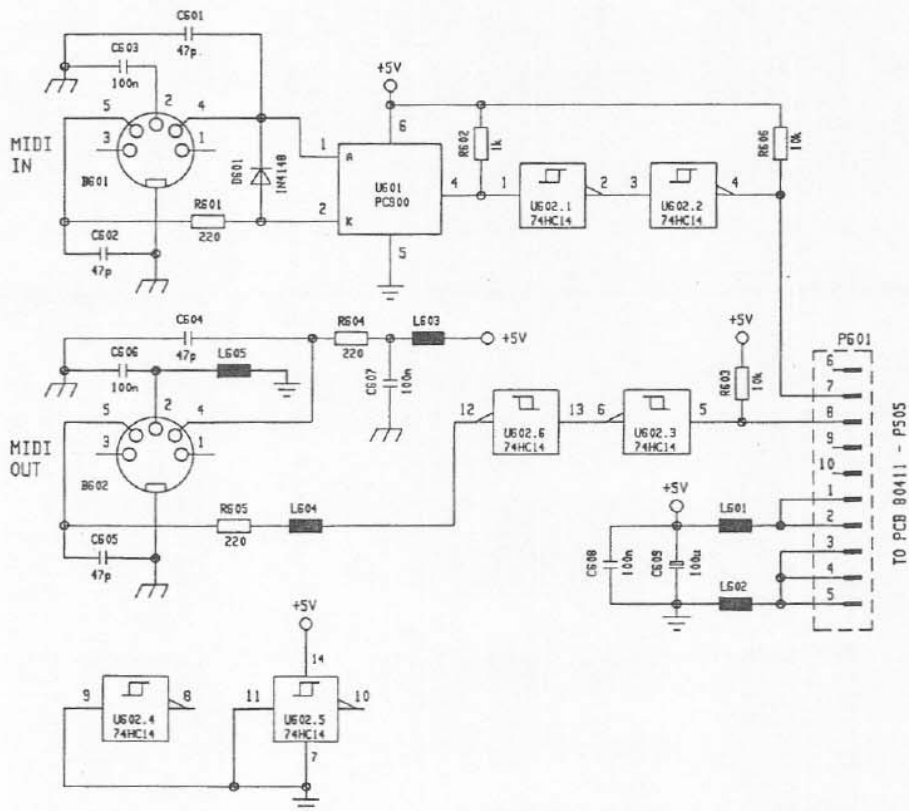

MIDI Board Circuit Diagram

SCHEMATIC DIAGRAMS

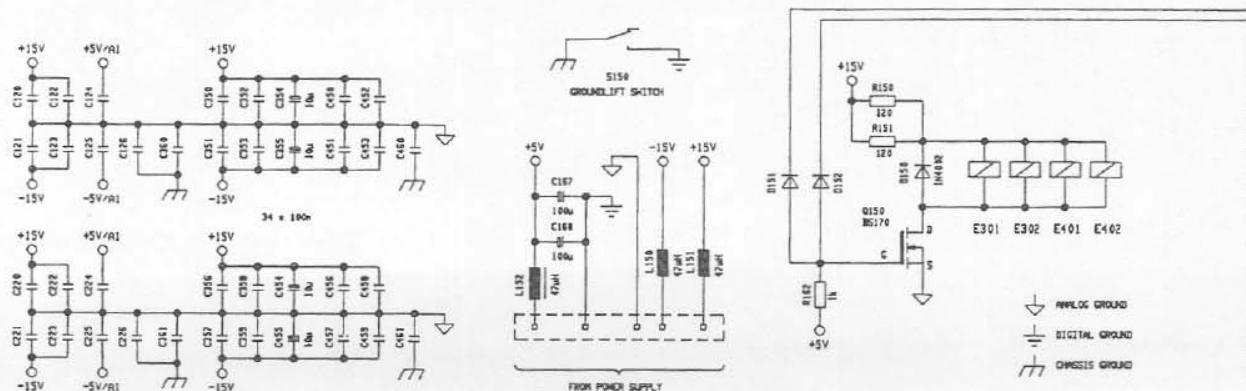
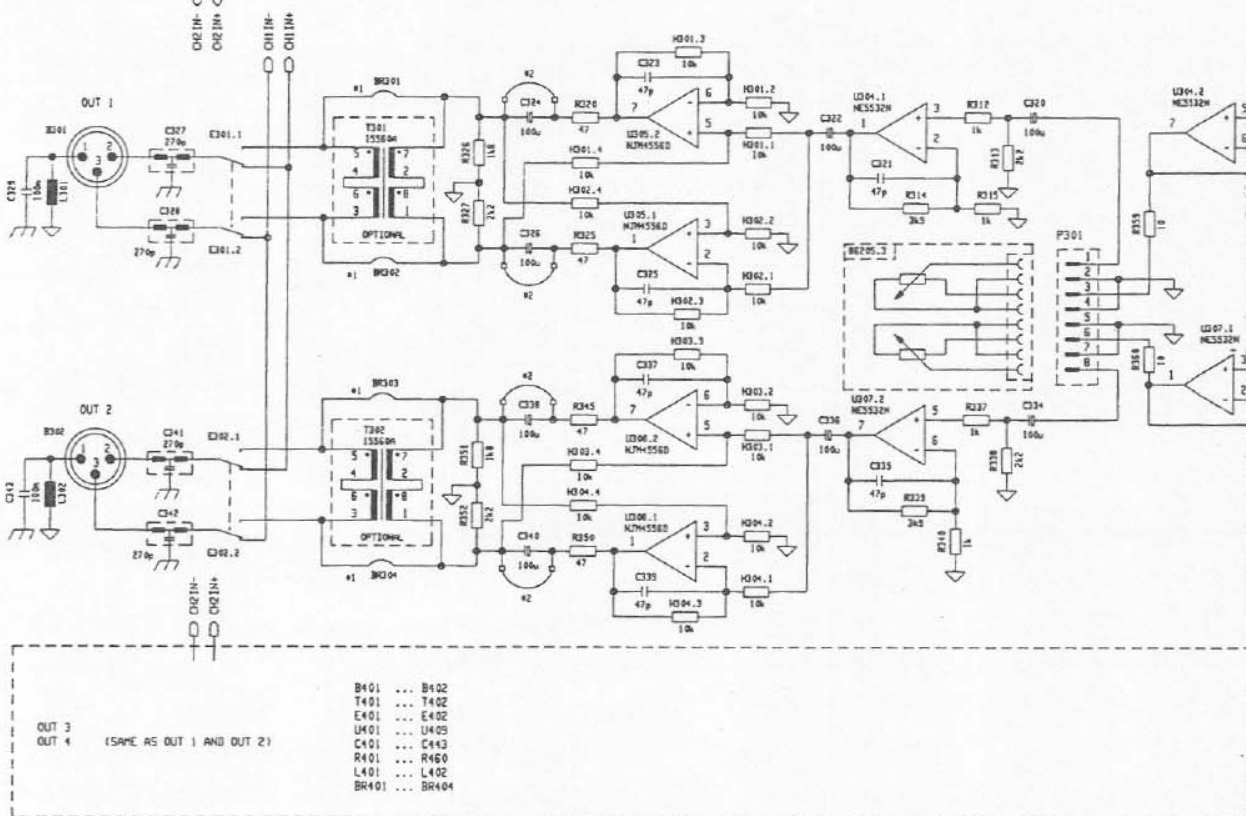
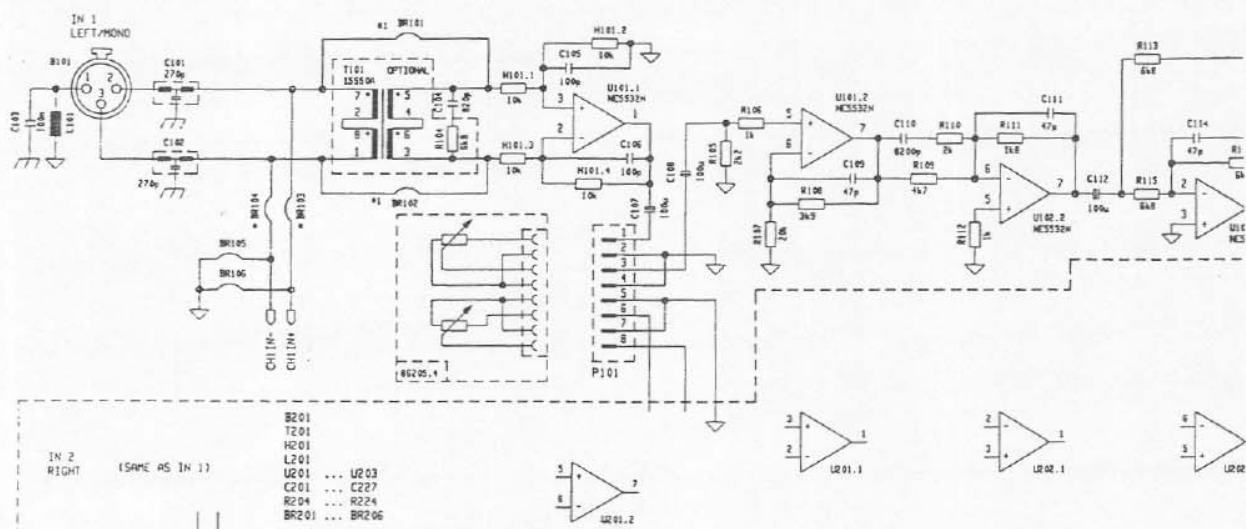

SCHEMATIC DIAGRAMS

TO ANALOG CIRCUIT
DRAWING NR. 348 963

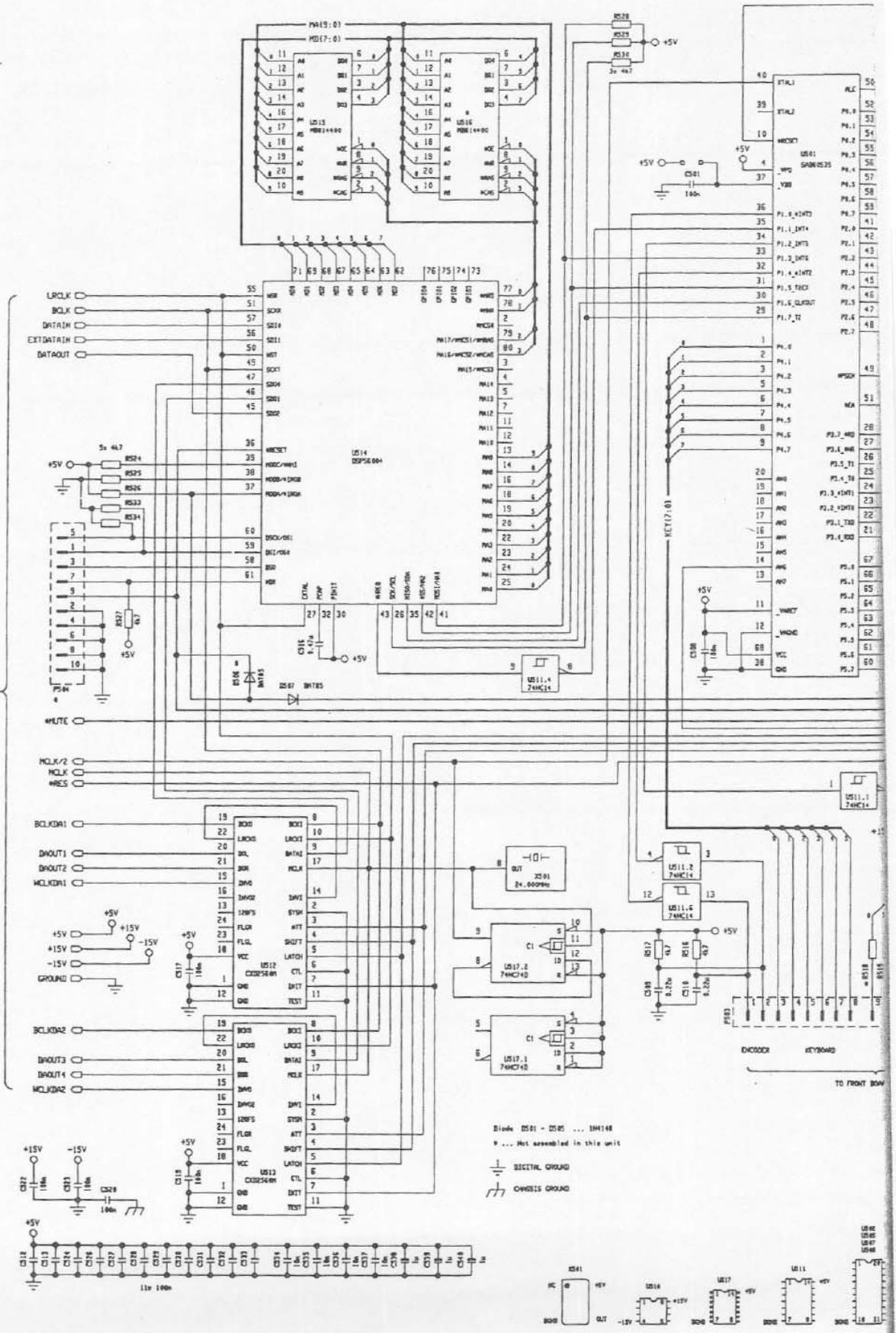

SCHEMATIC DIAGRAMS

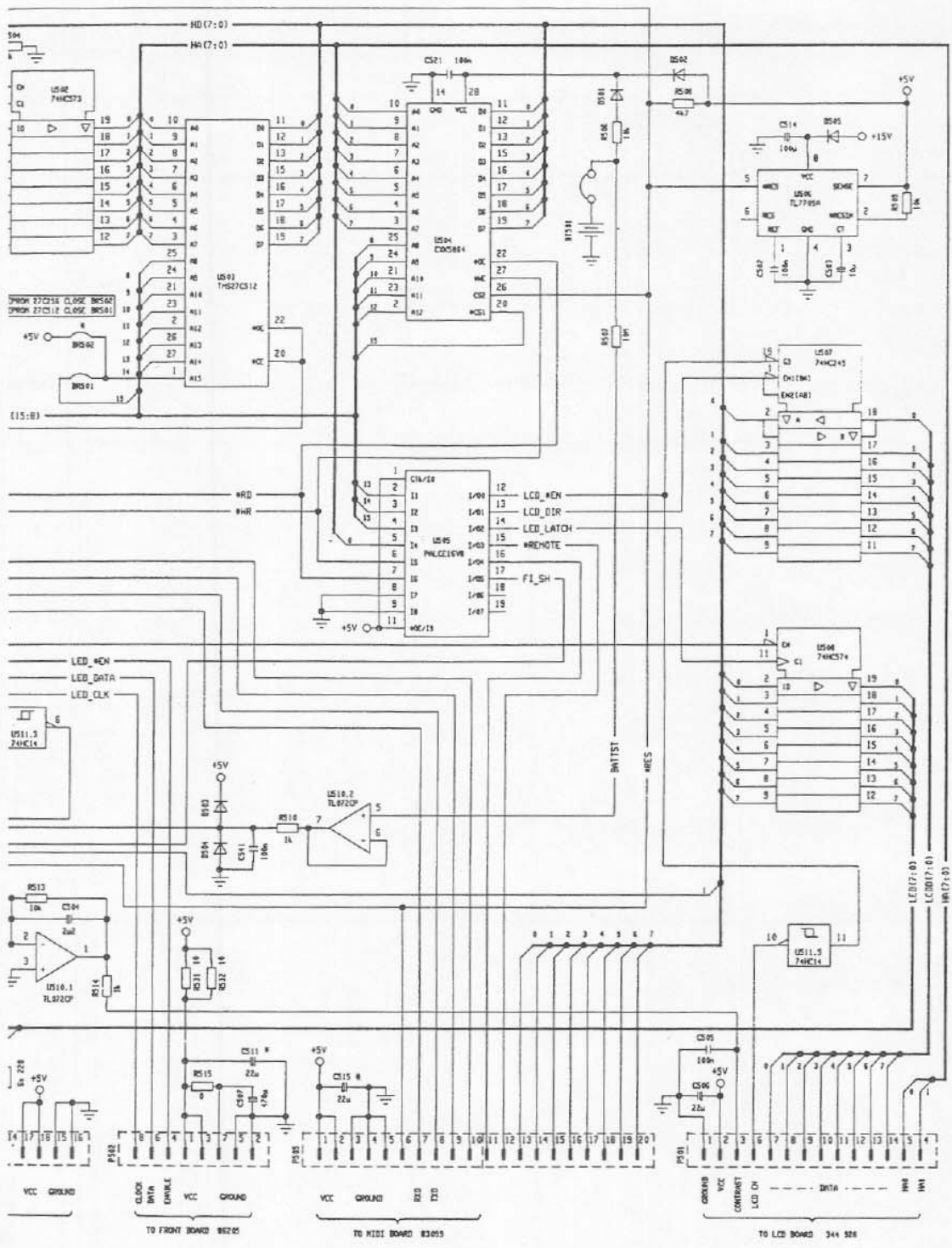

CIRCUIT DIAGRAM CONSISTS OF 2 DRAWINGS : 348 963 2-
348 964 2-

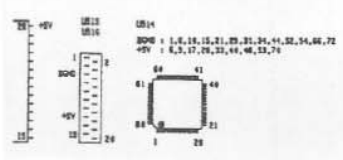

SCHEMATIC DIAGRAMS

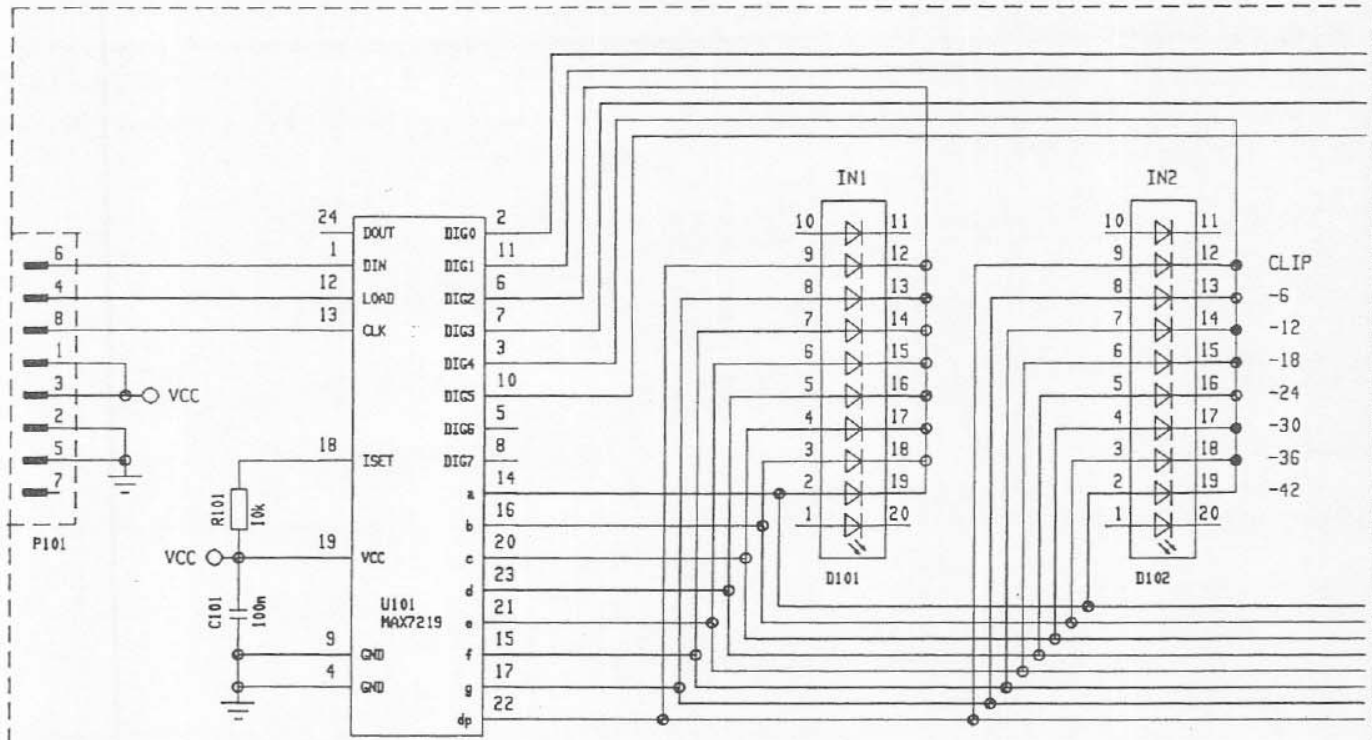

86205

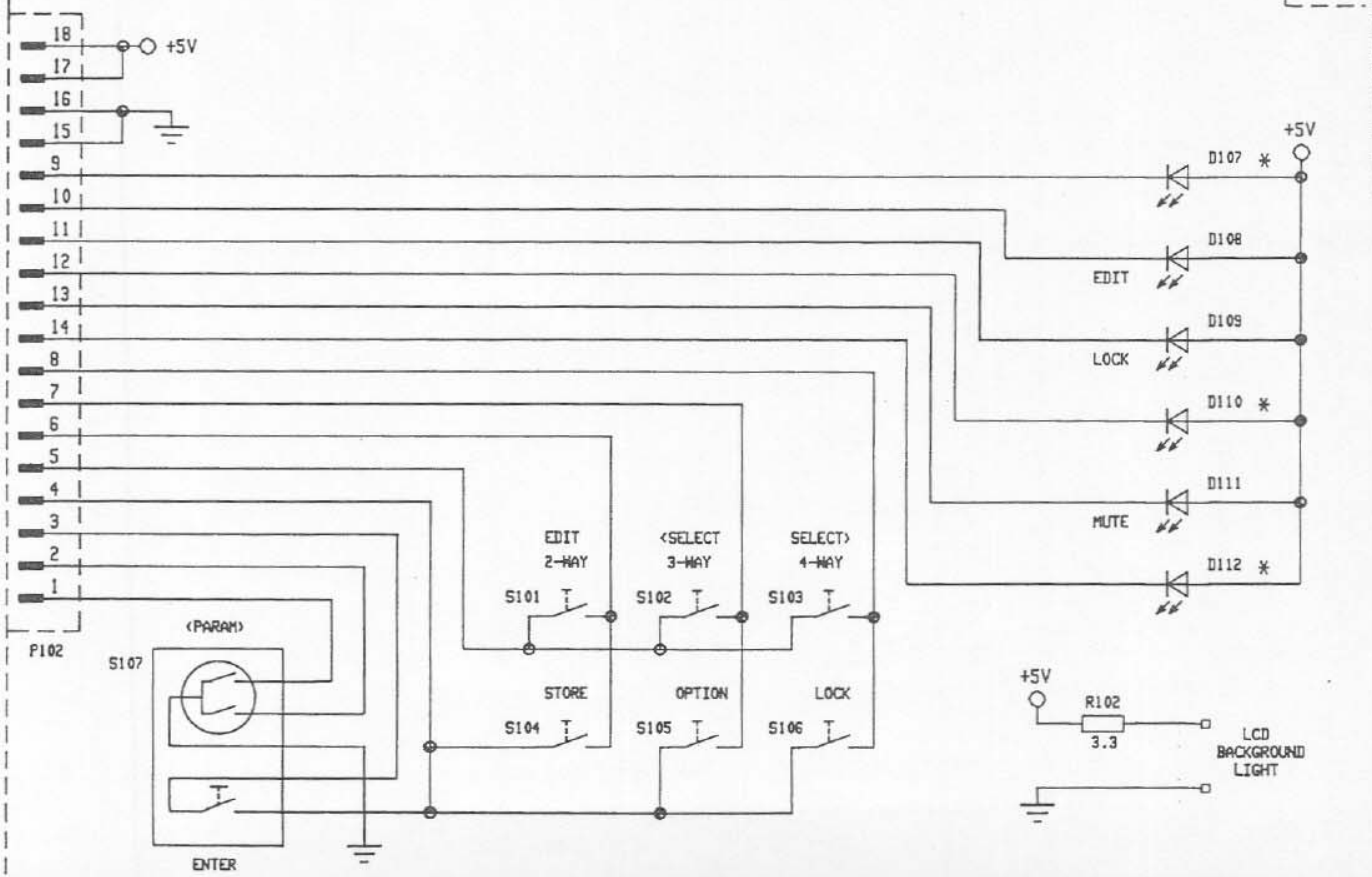

* ... NOT ASSEMBLED IN THIS UNIT

SCHEMATIC DIAGRAMS

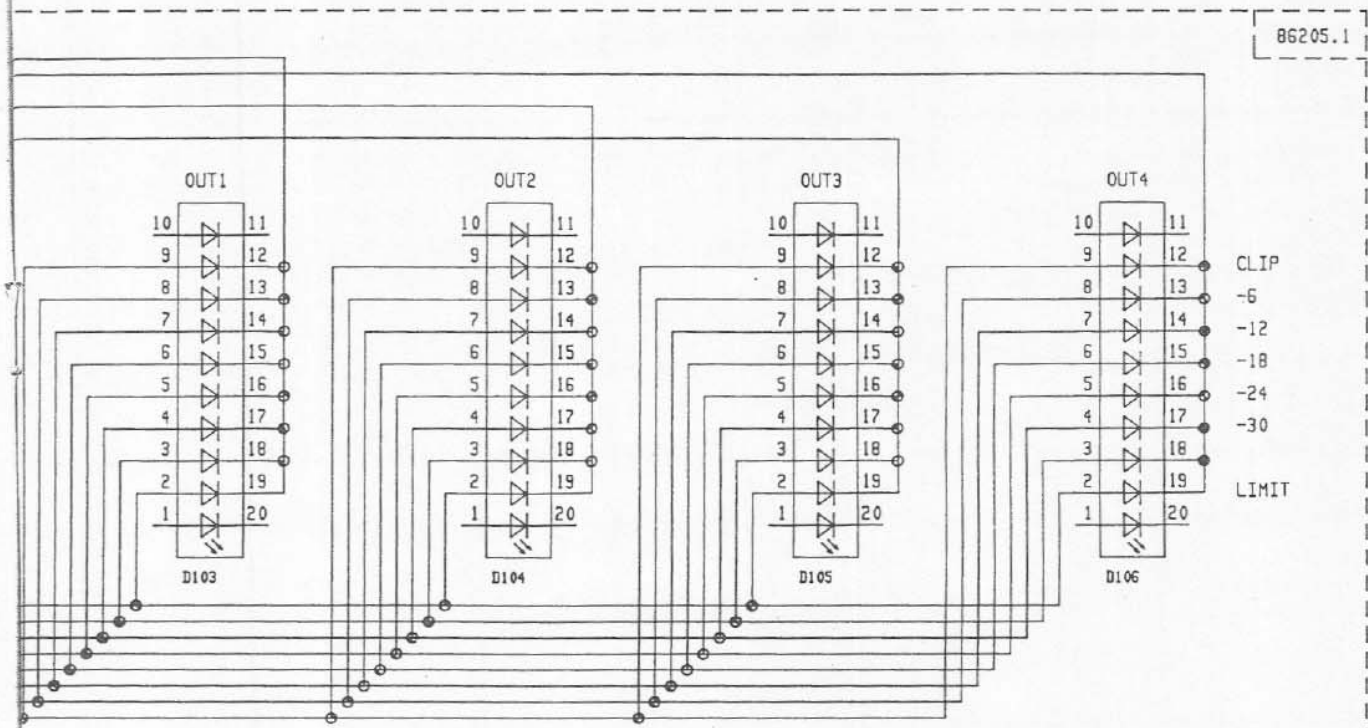

86205.4

86205.3

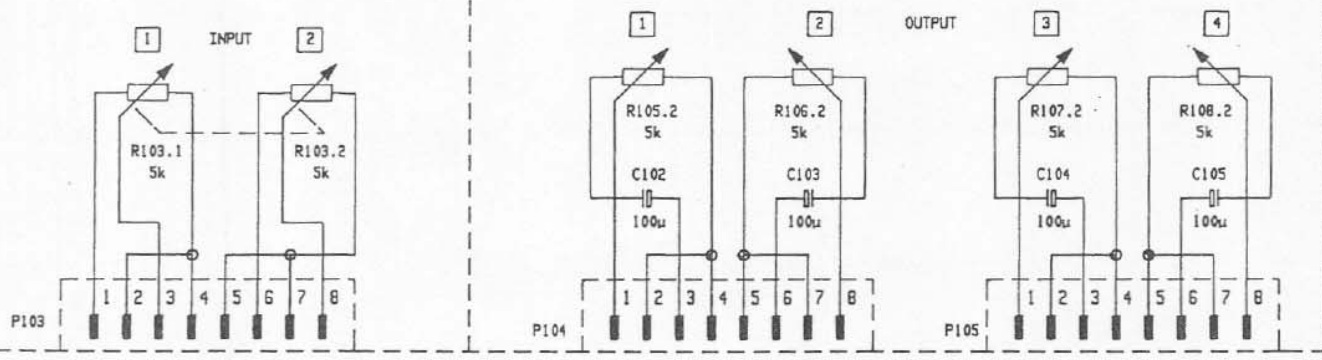

SERVICE WARRANTY INFORMATION

ELECTRO-VOICE BBS

Electro-Voice operates a Bulletin-Board Service at 616/695-4791 (8,N,1). A current list of presets for Electro-Voice speakers can be downloaded from this service.

SHIPPING DAMAGE

Inspect the shipping carton for possible damage. If damage is found, notify the transportation company immediately. Save the carton as evidence for the carrier to inspect. If damage occurs during shipping, it is the responsibility of the consignee to file a claim with the carrier. If the carton is in good condition but the unit is damaged, call Electro-Voice at 800/234-6831.

Included in the box with the Dx34 is a power cord, warranty card and this manual.

FIELD SERVICE

CONTROLLER POWER INSPECTION

If the Dx34 power indicator does not light:

1. Check the power switch.
2. Check the power cable.

WARRANTY (Limited)

Electro-Voice products are guaranteed against malfunction due to defects in materials or workmanship for a specified period, as noted in the individual product-line statement(s) below, or in the individual product data sheet or owner's manual, beginning with the date of original purchase. If such malfunction occurs during the specified period, the product will be repaired or replaced (at our option) without charge. The product will be returned to the customer prepaid.

Exclusions and Limitations: The Limited Warranty does not apply to: (a) exterior finish or appearance; (b) certain specific items described in the individual product-line statement(s) below, or in the individual product data sheet or owner's manual; (c) malfunction resulting from use or operation of the product other than as specified in the product data sheet or owner's manual; (d) malfunction resulting from misuse or abuse of the product; or (e) malfunction occurring at any time after repairs have been made to the product by anyone other than Electro-Voice or any of its authorized service representatives.

Obtaining Warranty Service: To obtain warranty service, a customer must deliver the product, prepaid, to Electro-Voice or any of its authorized service representatives together with proof of purchase of the product in the form of a bill of sale or receipted invoice. A list of authorized service representatives is available from Electro-Voice at 600 Cecil Street, Buchanan, MI 49107 (616/695-6831 or 800/234-6831). **Incidental and Consequential Damages Excluded:** Product repair or replacement and return to the customer are the only remedies provided to the customer. Electro-Voice shall not be liable for any incidental or consequential damages including, without limitation, injury to persons or property or loss of use. Some states do not allow the exclusion or limitation of incidental or consequential damages so the above limitation or exclusion may not apply to you. **Other Rights:** This warranty gives you specific legal rights, and you may also have other rights which vary from state to state.

2-WAY MODE USER PROGRAM DEFAULT VALUES

PARAMETER		CH 1	CH 2	CH3	CH4
MASTER DELAY	2 ms				
MASTER PEQ FREQ	1000 Hz				
MASTER PEQ Q	1.0				
MASTER PEQ GAIN	0 dB				
LO-CUT FREQ		32 Hz		32 Hz	
LO-CUT RESP		12 dB 0.7 Q		12 dB 0.7 Q	
LOSHELV FREQ		100 Hz		100 Hz	
LOSHELV SLOPE		6 dB		6 dB	
LOSHELV GAIN		0 dB		0 dB	
HI-PASS FREQ			1200Hz		1200Hz
HI-PASS RESP			4th LW		4th LW
PEQ1 FREQ		80 Hz	2500 Hz	80 Hz	2500 Hz
PEQ1 Q		1.0	1.0	1.0	1.0
PEQ1 GAIN		0 dB	0 dB	0 dB	0 dB
PEQ2 FREQ			16000 Hz		16000 Hz
PEQ2 Q			1.0		1.0
PEQ2 GAIN			0 dB		0 dB
LO-PASS FREQ		1200 Hz		1200 Hz	
LO-PASS RESP		4th LW		4th LW	
HISHELV FREQ			10000 Hz		10000 Hz
HISHELV SLOPE			6 dB		6 dB
HISHELV GAIN			0 dB		0 dB
DELAY ALIGNM		0 us	0 us	0 us	0 us
POLARITY		+	+	+	+
OUTPUT GAIN		0 dB	0 dB	0 dB	0 dB
LIMIT THRESH		21 dBu	21 dBu	21 dBu	21 dBu
LIMIT DECAY		50 dB/s	50 dB/s	50 dB/s	50 dB/s
LIMIT HOLD		5 ms	5 ms	5 ms	5 ms

3-WAY MODE USER PROGRAM DEFAULT VALUES

PARAMETER		CH 1	CH 2	CH3	CH4
MASTER DELAY 1-	2.0 ms				
LO-CUT FREQ		32 Hz			
LO-CUT RESP		12 dB 0.7 Q			
LOSHELV FREQ		100 Hz			
LOSHELV SLOPE		6 dB			
LOSHELV GAIN		0 dB			
HI-PASS FREQ			160 Hz	1800 Hz	
HI-PASS RESP			4th LW	4th LW	
PEQ1 FREQ		80 Hz	180 Hz	5000 Hz	
PEQ1 Q		1.0	1.0	1.0	
PEQ1 GAIN		0 dB	0 dB	0 dB	
PEQ2 FREQ			1600 Hz	16000 Hz	
PEQ2 Q			1.0	1.0	
PEQ2 GAIN			0 dB	0 dB	
LO-PASS FREQ		160 Hz	1800 Hz		
LO-PASS RESP		4th LW	4th LW		
HISHELV FREQ				10000 Hz	
HISHELV SLOPE				6 dB	
HISHELV GAIN				0 dB	
DELAY ALIGNM		0 us	0 us	0 us	2 ms
POLARITY		+	+	+	+
OUTPUT GAIN		0 dB	0 dB	0 dB	0 dB
LIMIT THRESH		21 dBu	21 dBu	21 dBu	
LIMIT DECAY		50 dB/s	50 dB/s	50 dB/s	
LIMIT HOLD		5 ms	5 ms	5 ms	
1LO & CH4 MODE					L/R

4-WAY MODE USER PROGRAM DEFAULT VALUES

PARAMETER		CH 1	CH 2	CH3	CH4
MASTER DELAY	2 ms				
LO-CUT FREQ		32 Hz			
LO-CUT RESP		12 dB 0.7 Q			
LOSHELV FREQ		100 Hz			
LOSHELV SLOPE		6 dB			
LOSHELV GAIN		0 dB			
HI-PASS FREQ			160 Hz	800 Hz	8000 Hz
HI-PASS RESP			4th LW	4th LW	4th LW
PEQ1 FREQ		80 Hz	180 Hz	5000 Hz	5000 Hz
PEQ1 Q		1.0	1.0	1.0	1.0
PEQ1 GAIN		0 dB	0 dB	0 dB	0 dB
PEQ2 FREQ				16000 Hz	16000 Hz
PEQ2 Q				1.0	1.0
PEQ2 GAIN				0 dB	0 dB
LO-PASS FREQ		160 Hz	800 Hz	8000 Hz	
LO-PASS RESP		4th LW	4th LW	4th LW	
HISHELV FREQ					10000 Hz
HISHELV SLOPE					6 dB
HISHELV GAIN					0 dB
DELAY ALIGNM		0 us	0 us	0 us	0 us
POLARITY		+	+	+	+
OUTPUT GAIN		0 dB	0 dB	0 dB	0 dB
LIMIT THRESH		21 dBu	21 dBu	21 dBu	21 dBu
LIMIT DECAY		50 dB/s	50 dB/s	50 dB/s	50 dB/s
LIMIT HOLD		5 ms	5 ms	5 ms	5 ms

2-WAY MODE

DATE: _____

AUTHOR: _____

SOFTWARE
VERSION: _____

TITLE: _____

SPEAKER SYSTEM NAME: _____

PARAMETER		CH 1	CH 2	CH3	CH4
MASTER DELAY	ms				
MASTER PEQ FREQ	Hz				
MASTER PEQ Q					
MASTER PEQ GAIN	dB				
LO-CUT FREQ		Hz		Hz	
LO-CUT RESP		dB Q		dB Q	
LOSHELV FREQ		Hz		Hz	
LOSHELV SLOPE		dB		dB	
LOSHELV GAIN		dB		dB	
HI-PASS FREQ			Hz		Hz
HI-PASS RESP					
PEQ1 FREQ		Hz	Hz	Hz	Hz
PEQ1 Q					
PEQ1 GAIN		dB	dB	dB	dB
PEQ2 FREQ			Hz		Hz
PEQ2 Q					
PEQ2 GAIN			dB		dB
LO-PASS FREQ		Hz		Hz	
LO-PASS RESP					
HISHELV FREQ			Hz		Hz
HISHELV SLOPE			dB		dB
HISHELV GAIN			dB		dB
DELAY ALIGNM		us	us	us	us
POLARITY					
OUTPUT GAIN		dB	dB	dB	dB
LIMIT THRESH		dBu	dBu	dBu	dBu
LIMIT DECAY		dB/s	dB/s	dB/s	dB/s
LIMIT HOLD		ms	ms	ms	ms

3-WAY MODE

DATE: _____

AUTHOR: _____

SOFTWARE
VERSION: _____

TITLE: _____

SPEAKER SYSTEM NAME: _____

PARAMETER		CH 1	CH 2	CH3	CH4
MASTER DELAY 1-	ms				
LO-CUT FREQ		Hz			
LO-CUT RESP		dB Q			
LOSHELV FREQ		Hz			
LOSHELV SLOPE		dB			
LOSHELV GAIN		dB			
HI-PASS FREQ			Hz	Hz	
HI-PASS RESP					
PEQ1 FREQ		Hz	Hz	Hz	
PEQ1 Q					
PEQ1 GAIN		dB	dB	dB	
PEQ2 FREQ			Hz	Hz	
PEQ2 Q					
PEQ2 GAIN			dB	dB	
LO-PASS FREQ		Hz	Hz		
LO-PASS RESP					
HISHELV FREQ				Hz	
HISHELV SLOPE				dB	
HISHELV GAIN				dB	
DELAY ALIGNM		us	us	us	ms
POLARITY					
OUTPUT GAIN		dB	dB	dB	dB
LIMIT THRESH		dBu	dBu	dBu	
LIMIT DECAY		dB/s	dB/s	dB/s	
LIMIT HOLD		ms	ms	ms	
1LO & CH4 MODE					

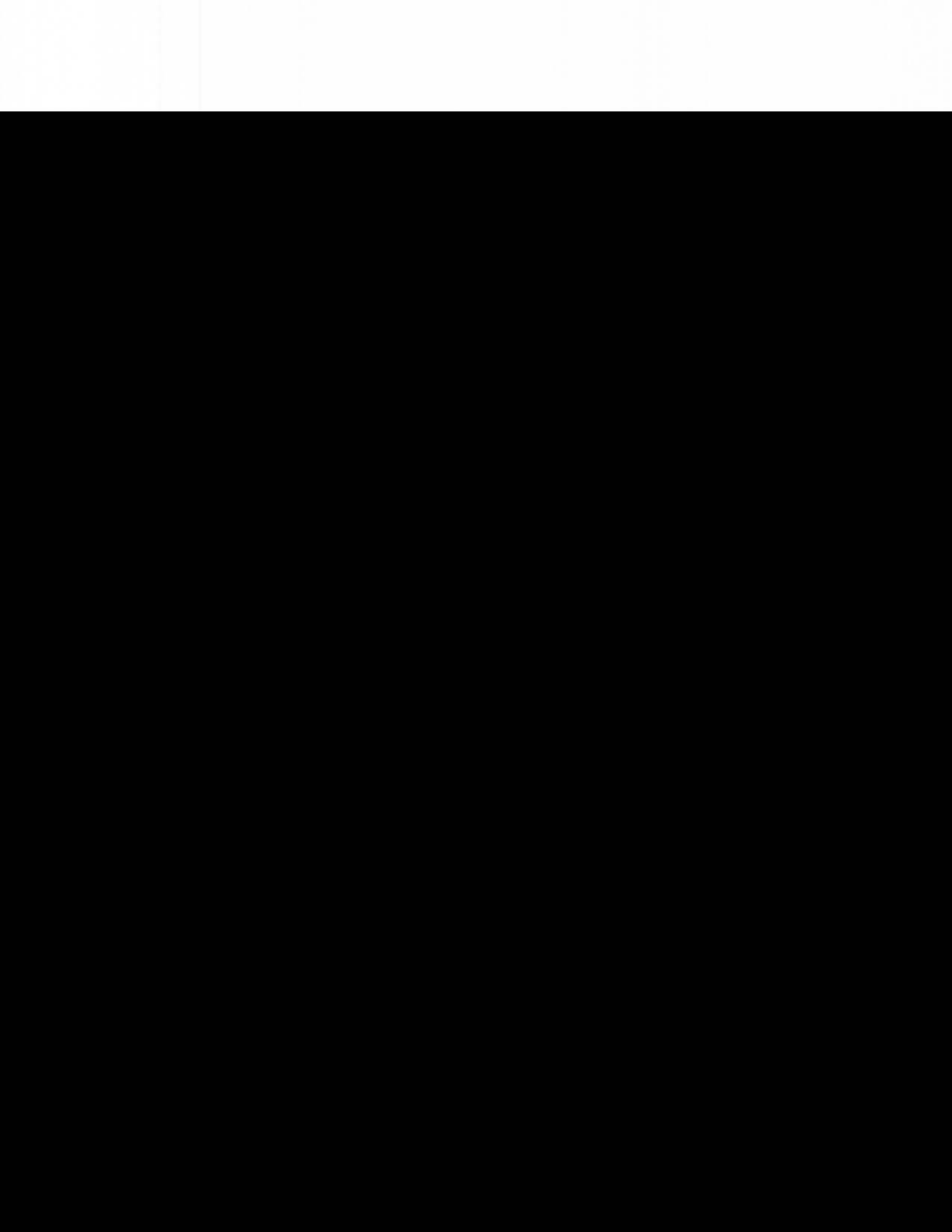

4-WAY MODE

DATE: _____

AUTHOR: _____

SOFTWARE
VERSION: _____

TITLE: _____

SPEAKER SYSTEM NAME: _____

PARAMETER		CH 1	CH 2	CH3	CH4
MASTER DELAY	ms				
LO-CUT FREQ		Hz			
LO-CUT RESP		dB Q			
LOSHELV FREQ		Hz			
LOSHELV SLOPE		dB			
LOSHELV GAIN		dB			
HI-PASS FREQ			Hz	Hz	Hz
HI-PASS RESP					
PEQ1 FREQ		Hz	Hz	Hz	Hz
PEQ1 Q					
PEQ1 GAIN		dB	dB	dB	dB
PEQ2 FREQ				Hz	Hz
PEQ2 Q					
PEQ2 GAIN				dB	dB
LO-PASS FREQ		Hz	Hz	Hz	
LO-PASS RESP					
HISHELV FREQ					Hz
HISHELV SLOPE					dB
HISHELV GAIN					dB
DELAY ALIGNM		us	us	us	us
POLARITY					
OUTPUT GAIN		dB	dB	dB	dB
LIMIT THRESH		dBu	dBu	dBu	dBu
LIMIT DECAY		dB/s	dB/s	dB/s	dB/s
LIMIT HOLD		ms	ms	ms	ms

REPAIR PARTS LIST

REF #	DESCRIPTION	PART #	REF #	DESCRIPTION	PART #
Z0080	rubber foot	345095	C 101	saftey component	346765
00010	plexiglass panel Dx34	349978	C 102	saftey component	346765
00040	push button black 12.5x7	337059	C 201	saftey component	346765
00050	push button black 6.4x3.4	342496	C 202	saftey component	346765
00060	rotary knob black 16	342120	C 301	KO-EL 1 μ F 50V	340520
00070	rotary knob black	348055	C 302	KO-EL 1 μ F 50V	340520
00080	power supply	346713	C 327	safety component	346765
00090	display	344928	C 328	safety component	346765
00010	display	345483	C 341	safety component	346765
00010	PCB Dx34	852168	C 342	safety component	346765
B 401	connector	338835	C 401	KO-EL 1 μ F 50V	340520
C 401	safety component 0.22 μ F	344934	C 402	KO-EL 1 μ F 50V	340520
C 402	safety component 0.22 μ F	344934	C 427	safety component	346765
C 403	safety component 2.2nF	334682	C 428	safety component	346765
C 404	safety component 2.2nF	334682	C 441	safety component	346765
L 401	coil 2x10 mH	332961	C 442	safety component	346765
S 401	mains switch	331175	C 538	KO-EL 1 μ F 50V	340520
00020	PCB	862058	C 539	KO-EL 1 μ F 50V	340520
D 101	led 7xgn+3xred	348813	C 540	KO-EL 1 μ F 50V	340520
D 102	led 7xgn+3xred	348813	D 150	diode 1N 4002	304360
D 103	led 7xgn+3xred	348813	D 151	diode 1N 4148	301254
D 104	led 7xgn+3xred	348813	D 152	diode 1N 4148	301254
D 105	led 7xgn+3xred	348813	D 501	diode 1N 4148	301254
D 106	led 7xgn+3xred	348813	D 502	diode 1N 4148	301254
D 108	led red 6x3.8mm	348453	D 503	diode 1N 4148	301254
D 109	led red 6x3.8mm	348453	D 504	diode 1N 4148	301254
D 111	led red 6x3.8mm	348453	D 505	diode 1N 4148	301254
R 103	potentiometer 2x5k ohm log	345484	D 507	diode BAT 85	301297
R 105	potentiometer 2x5k ohm log	345484	E 301	relay AZ 845	346760
R 106	potentiometer 2x5k ohm log	345484	E 302	relay AZ 845	346760
R 107	potentiometer 2x5k ohm log	345484	E 401	relay AZ 845	346760
R 108	potentiometer 2x5k ohm log	345484	E 402	relay AZ 845	346760
S 101	switch	339674	H 101	res.network rkl 8A 103J	343457
S102	switch	339674	H 201	res.network rkl 8A 103J	343457
S 103	switch	339674	H 301	res.network rkl 8A 103J	343457
S 104	switch	339674	H 302	res.network rkl 8A 103J	343457
S 105	switch	339674	H 303	res.network rkl 8A 103J	343457
S 106	switch	339674	H 304	res.network rkl 8A 103J	343457
S 107	rotary encoder	346797	H 401	res.network rkl 8A 103J	343457
00040	PCB	830998	H 402	res.network rkl 8A 103J	343457
B 601	socket	303093	H 403	res.network rkl 8A 103J	343457
B 602	socket	303093	H 404	res.network rkl 8A 103J	343457
D 601	diode 1N 4148	301254	L 101	coil	339139
L 601	coil	339139	L 150	coil	335966
L 602	coil	339139	L 151	coil 47 μ H	335966
L 603	coil	339139	L 152	coil 47 μ H/5.5A	333717
L 604	coil	339139	L 201	coil	339139
L 605	coil	339139	L 301	coil	339139
U 601	IC PC 900	333739	L 302	coil	339139
U 602	IC MC 74 HC 14	333458	L 401	coil	339139
00050	PCB	804118	L 402	coil	339139
B 101	socket XLR 3pol.	346791	Q 150	trans. BS 170	346764
B 201	socket XLR 3pol.	346791	S 150	sliding switch	338886
B 301	connector XLR 3pol.	346792	U 101	IC NE 5532 N	327197
B 302	connector XLR 3pol.	346792	U 102	IC NE 5532 N	327197
B 401	connector XLR 3pol.	346792	U 103	IC NE 5532 N	327197
B 402	connector XLR 3pol.	346792	U 150	IC AD 1879	346763
BT501	battery	341655	U 151	IC MC 7805 C	309719

REPAIR PARTS LIST

REF #	DESCRIPTION	PART #
U 152	IC MC 7905 CP	338834
U 201	IC NE 5532 N	327197
U 202	IC NE 5532 N	327197
U 203	IC NE 5532 N	327197
U 301	IC PCM 69	346849
U 302	IC NE 5532 N	327197
U 303	IC NE 5532 N	327197
U 304	IC NE 5532 N	327197
U 305	IC NJM 4556	344864
U 306	IC NE 5532 N	327197
U 307	IC NE 5532 N	327197
U 308	IC NJM 4556 D	344864
U 309	IC MC 78 L 50 ACP	346343
U 401	IC PCM 69	346849
U 402	IC NE 5532 N	327197
U 403	IC NE 5532 N	327197
U 404	IC NE 5532 N	327197
U 405	IC NJM 4556 D	344864
U 406	IC NE 5532 N	327197
U 407	IC NE 5532 N	327197
U 408	IC NJM 4556 D	344864
U 409	IC MC 78 L 05 ACP	346343
U 501	ICSAB 80535 N	341631
U 502	IC SN 74 HC573	341636
U 504	IC HM 6264 P20	334590
U 505	IC P-IC DDL 204	346952
U 506	IC TL 7705	335857
U 507	IC SN 74 HC245 N	338389
U 508	IC SN 74 HC574 N	341637
U 510	IC TL 072 CP	331340
U 511	IC MC 74 HC 14	333458
U 515	IC MB 814400A	346762
X 501	24.0000 MHz crystal	346851

INDEX

Battery	parametric	Schematic
B ₆ alignment	adjustment of	Service
Block diagram	description of	Specifications
Bulletin-board	Features	Store
Configurations	Filters	user preset
two-way	EQ - see EQ	Time delay - see Delay
full-edit	high pass	Time alignment - see Delay
preset	adjustment of	Transformer option
three-way	description of	input
full-edit	low pass	output
preset	adjustment of	Version of software
four-way	description of	Wiring - see Connections
full-edit	Grounding	
preset	Hum - see Grounding	
Connections	Level	
input	adjustment of:	
balanced	input	
unbalanced	output	
output	Limiter	
balanced	decay	
unbalanced	adjustment of	
power	description of	
Connectors	hold	
input	adjustment of	
MIDI	description of	
output	threshold	
power	adjustment of	
Contrast	description of	
LCD	Lock	
Crossover	Meters	
Bessel	MIDI	
Butterworth	connectors	
Linkwitz-Riley	dump	
order	implementation chart	
slope comparison	out	
Data wheel - see Encoder	system exclusive	
Delay	Modes	
alignment	preset	
system	full-edit	
units	Mute	
Dimensions	Output gain	
Editing	Parameters	
factory preset	adjustment of	
parameters	default values	
Encoder	description of	
EQ	user work sheets	
high-shelve	Polarity	
adjustment of	Presets	
description of	factory	
low-cut	user	
adjustment of	Protect	
description of	how to enable	
low-shelve	Repair parts	
adjustment of	Saving - see Store	
description of		