

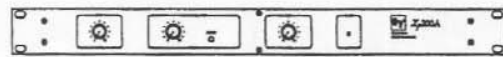

Electro-Voice[®]

SYSTEM 200[™] MODULAR PRO AUDIO

OWNER'S MANUAL

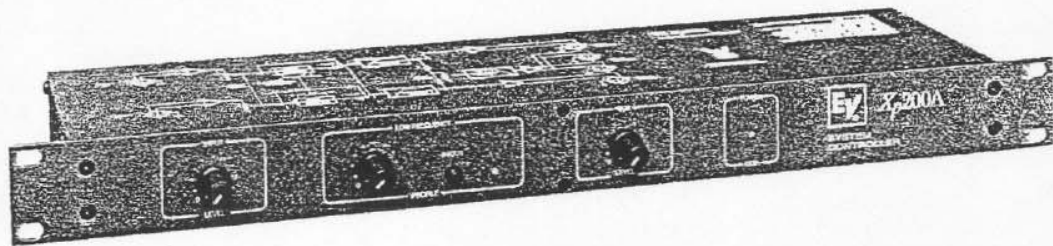

Xp200A

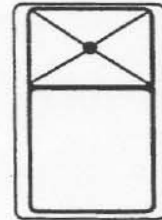

Sx200

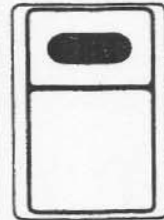

Sb120
Sb120a

**Xp200A CONTROLLER
AND ITS USE WITH THE
Sx200, Sb120a and Sb120 SPEAKER SYSTEMS**

TABLE OF CONTENTS**DESCRIPTION**

General	page 1
Xp200A Feature Summary	page 1

SPECIFICATIONS

Xp200A Controller	page 2
System 200™ Speaker System Specifications (selected)	page 3

FREQUENCY AND POLAR RESPONSE CURVES page 4

Xp200A Controller
Sx200 Full-Range Speaker System
Sb120a Powered Bass Module
Sb120 Nonpowered Bass Module

Xp200A BLOCK DIAGRAM page 5**OPERATION AND INSTALLATION**

Front-Panel Indicators and Controls	page 6
Back-Panel Connections	page 7
Mounting/Installation	page 8
Typical System 200™ Modular Pro Audio Configurations	pages 8-12
Connector and Cable Requirements	pages 13-14

SCHEMATIC DIAGRAMS pages 16-18**SERVICE/WARRANTY INFORMATION**

Shipping Damage	page 19
Field Service	page 19
Warranty	page 19

REPAIR PARTS LIST page 20

**WARNING: TO REDUCE THE RISK OF FIRE OR ELECTRIC SHOCK,
DO NOT EXPOSE THIS EQUIPMENT TO RAIN OR MOISTURE.**

DESCRIPTION**GENERAL**

The Xp200A controller is the electronic "heart" of the Electro-Voice System 200™ modular sound reinforcement system. It links together and enhances the performance of one or more stereo pairs of the Sx200 full-range speaker systems and one or more Sb120a (powered) or Sb120 (nonpowered) bass modules.

Full speaker system details may be obtained by requesting the individual engineering data sheets from Electro-Voice. A few key specifications are given in the Specifications section of this manual (page 3). Typical System 200™ set ups are shown in the Operation and Installation section (page 6).

Xp200A FEATURE SUMMARY

- A unique, low-frequency profile circuit enhances low-frequency performance of both the Sx200 full-range system and the Sb120a or Sb120 bass modules.
- In a side-chain circuit, low frequencies are slightly delayed in time as they are boosted, then summed with the original direct signal. This combination of delayed and direct signals changes the relative levels of the musical fundamental and its harmonics, in an audibly attractive way. The resultant modification of timbre is as dynamic and continually changing as the musical input itself.
- A low-frequency profile control adjusts the degree of bass enhancement, up to a maximum of 12 dB. An in/out switch makes it easy to assess the degree of enhancement.
- An in/out LED illuminates green when the Low-Frequency Profile is switched on.
- Input Level and Sub Level controls facilitate easy balancing of a complete System 200™.
- A power/clip LED shows constant green with power on. If clipping occurs, the LED changes from green to flashing red.
- The full-range, left and right outputs of the Xp200A feature a 40-Hz, 24-dB-per-octave high-pass filter that keeps the bass output of the Sx200 speaker systems very tight and clean, by eliminating excessive cone excursion caused by very low, infrasonic frequencies.
- The mono-summed subwoofer output incorporates 24-dB-per-octave filters that roll off response above 100 Hz and below 37 Hz for a high degree of placement flexibility and infrasonic protection for the Sb120a and Sb120 bass modules.
- Inputs and outputs are electronically balanced, with XLR 3-pin type connectors. Two paralleled sub outputs are provided, for easy connection of two subwoofer amplifiers or Sb120a powered bass modules.
- Outputs are compatible with both balanced and unbalanced loads. A cross-coupled output circuit automatically senses an unbalanced signal connection and increases the gain of the circuit by 6 dB to maintain the same output voltage at the power amplifier input.

Xp200A SYSTEM CONTROLLER SPECIFICATIONS

Measurement conditions and notes:

1. Measurements at 1,000 Hz unless otherwise specified.
2. All level controls full clockwise.
3. 0-dBu input voltage.
4. 120 V ac maintained at power input.
5. 0 dBu = 0.775 V rms.
6. 0 dBm = 1 mW.

Number of Channels:

Two

Front-Panel Controls and Indicators:

Input level (stereo rotary)
 Low-frequency profile (stereo rotary)
 Low-frequency profile in/out switch
 Subwoofer level (rotary)
 Power on/clip LED
 Low Frequency Profile LED

Low-Frequency Profile:

Side-chain equalization circuit summed with direct signal, with up to 12 dB of enhancement at 70 Hz

Left and Right Main Inputs,**Type:**

Electronically balanced differential

Impedance:

30 kilohms

Maximum Input Level:

+22 dBu (9.8 V)

Nominal Input Level:

0 dBu (0.775 V)

Connectors:

3-pin type XLR (Female)

Left and Right Outputs,**Type:**

Electronically balanced, cross-coupled
 output topology

Source Impedance:

150 ohms

Load Impedance, Recommended/Minimum:

>1,500 ohms/600 ohms

Bandwidth:

40-20,000 Hz (40-Hz, 24-dB-per-octave
 high-pass filter for infrasonic speaker protection)

Maximum Output,**Power:**

+19 dBm (79 mW)

Voltage (15,000-ohm load):

+22 dBu (9.8 V)

Nominal Output Power (low-frequency profile switched out):

0 dBm (1 mW)

Clipping Indication:

Green power-on LED turns to flashing red at
 +19-dBm output

Connectors:

3-pin type XLR (Male)

Subwoofer Output (monaural, sum of left and right inputs),**Type:**

Electronically balanced, cross-coupled
 output topology

Source Impedance:

150 ohms

Load Impedance, Recommended/Minimum:

>1,500 ohms/600 ohms

Bandwidth:

37-100 Hz, typical (24-dB-per-octave filters,
 37-Hz high pass for infrasonic speaker protection
 and 100 Hz low pass for crossover)

Maximum Output,**Power:**

+19 dBm (79 mW)

Voltage (15,000-ohm load):

+22 dBu (9.8 V)

Nominal Output Power (low-frequency profile switched out),

0-dBu Signal Applied at 70 Hz to Left
 and Right Inputs:

+3 dBm (2 mW)

0-dBu Signal Applied at 70 Hz to Left
 or Right Input:

0 dBm (1 mW)

Clipping Indication:

Green power-on LED turns to flashing red at
 +19-dBm output

Connectors:

3-pin type XLR (Male)

Total Harmonic Distortion Plus Noise at 0-dBm Output (40-20,000 Hz):

<0.1%

Output Noise, A-Weighted:

<-90 dBm

Channel Separation (output on one channel when the other channel is driven at 0 dBu):

<-85 dBm

Power Requirements selectable:

100-120 V ac, 50/60 Hz, 10 W or

220-240 V ac, 50/60 Hz, 10 W

Supplied Items and Accessories:

Owner's manual; hardware kit (mounted); pad of
 rubber feet

Chassis Construction:

Painted steel

Colors,**Overall:**

Gray

Nomenclature,**Front Panel:**

Pearlized light gray

Top and Rear Panel:

White

Dimensions:**Height:** 4.37 cm (1.72 in.)**Width:** 48.3 cm (19.0 in.)**Depth:** 12.3 cm (4.8 in.)**Net Weight:**

1.73 kg (3.82 lb)

Shipping Weight:

2.43 kg (5.36 lb)

Specifications subject to change without notice.

SYSTEM 200™ SPEAKER SYSTEM SPECIFICATIONS (SELECTED)			
	Sx200 Full-Range Speaker System	Sb120 Nonpowered Bass Module	Sb120a Powered Bass Module
Frequency Response (swept sine-wave input, 4 volts at 10 ft on axis, half-space anechoic environment, normalized for 1 meter and a 1-watt speaker input) (see Figures 4, 5 and 6):	80-25,000 Hz	50-500Hz	50-180 Hz
Usable Low-Frequency Limit with Xp200A Processor (10-dB-down point):	55 Hz	43 Hz	43 Hz
Long-Term Average Power-Handling Capacity per EIA Standard RS-426A:	300 watts	300 watts	N/A (integral, 400-watt amplifier supplied)
Sensitivity (SPL at 1 meter, 1 watt input, anechoic environment, band-limited pink-noise signal over indicated range):	101.5 dB (300-2,000 Hz)	94 dB (50-200 Hz)	N/A
SPL at 1 Meter, Maximum Gain and Amplifier at Clipping Threshold, 0 dBu (0.775 volts) into Balanced Input, Half-Space Anechoic Environment, 50- to 200-Hz Average:	N/A	N/A	120 dB
Dispersion Angle Included by 6-dB-Down Points on Polar Responses, Indicated Bands of Pink Noise, Horizontal and Vertical (see Figure 7):	65° x 65° (2,000-20,000 Hz)	Essentially omni-directional (45-200 Hz)	Essentially omni-directional (45-200 Hz)
Transducer Complement, High Frequency:	DH2010A 1-in. compression driver	N/A	N/A
Low Frequency:	12-inch Pro-Line	Long-throw, 12-inch DL12sb	Long-throw, 12-inch DL12sb
Nominal Impedance:	8 ohms	8 ohms	10,000 ohms (balanced input)
Input Connections:	One Neutrik Speakon® NL4MP in parallel with one 1/4-in. jack	One Neutrik Speakon® NL4MP in parallel with one 1/4-in. jack	Neutrik all-in-one 3-pin XLR/1/4-in. phone jack
Enclosure Materials and Colors:	Black polypropylene structural foam	Black polypropylene structural foam	Black polypropylene structural foam
Optional Accessories:	100BK mounting stand; Mb200 mounting bracket	100BK mounting stand; Mb200 mounting bracket	100BK mounting stand; Mb200 mounting bracket
Hanging Inserts:	Four metric M8 x 14 mm	Four metric M8 x 14 mm	Three metric M8 x 14 mm
Power Requirements (ac):	N/A	N/A	50 watts maximum average; 100-130 V ac, 50-60 Hz (Sb120a); 200-250 V ac, 50-60 Hz (Sb120a Export)
Dimensions, Height: Width: Depth:	58.7 cm (23.1 in.) 42.9 cm (16.9 in.) 31.2 cm (12.3 in.)	58.7 cm (23.1 in.) 42.9 cm (16.9 in.) 31.2 cm (12.3 in.)	58.7 cm (23.1 in.) 42.9 cm (16.9 in.) 31.2 cm (12.3 in.)
Net Weight:	17.7 kg (39.0 lb)	14.6 kg (32.2 lb)	15.8 kg (34.8 lb)

Specifications subject to change without notice.

FIGURE 1 — Xp200A Frequency Response, Left and Right Outputs, Profile Control Off (full counterclockwise)

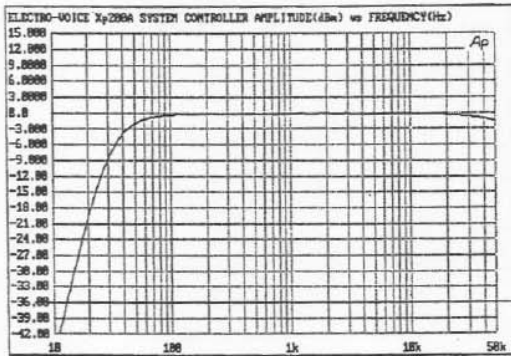

FIGURE 2 — Xp200A Frequency Response, Subwoofer Output, Profile Control Off (full counterclockwise)

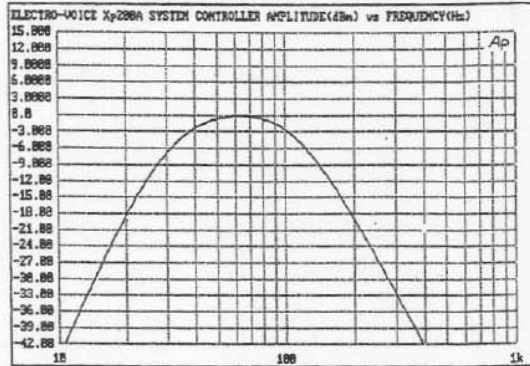

FIGURE 3 — Xp200A Frequency Response, Left and Right Outputs, Profile Control Advanced to Full Clockwise in 3-dB Steps

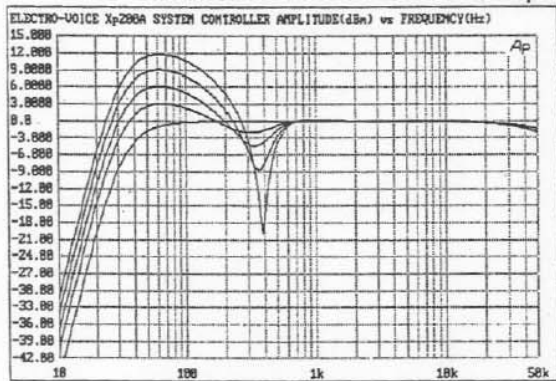

FIGURE 4 — Sx200 Frequency Response, 1 Watt/ 1 Meter (half-space anechoic environment)

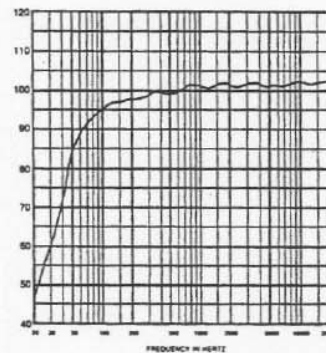

FIGURE 5 — Sb120 Frequency Response, 1 Watt/ 1 Meter (half-space anechoic environment)

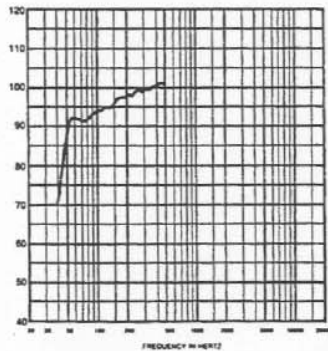

FIGURE 6 — Sb120a Frequency Response, 1 Watt into Woofer, 1 Meter (half-space anechoic environment)

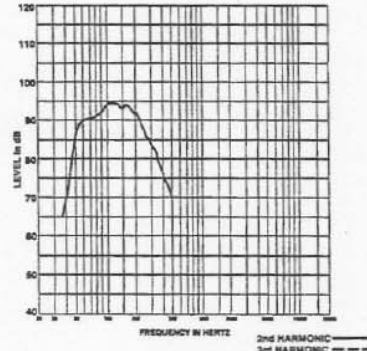
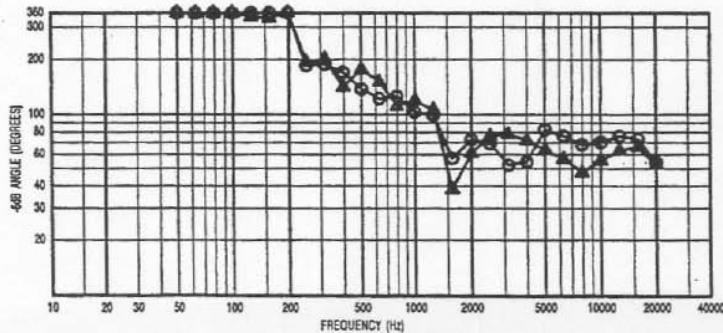

FIGURE 7 — Sx200 Beamwidth vs. Frequency (anechoic environment)



BLOCK DIAGRAM

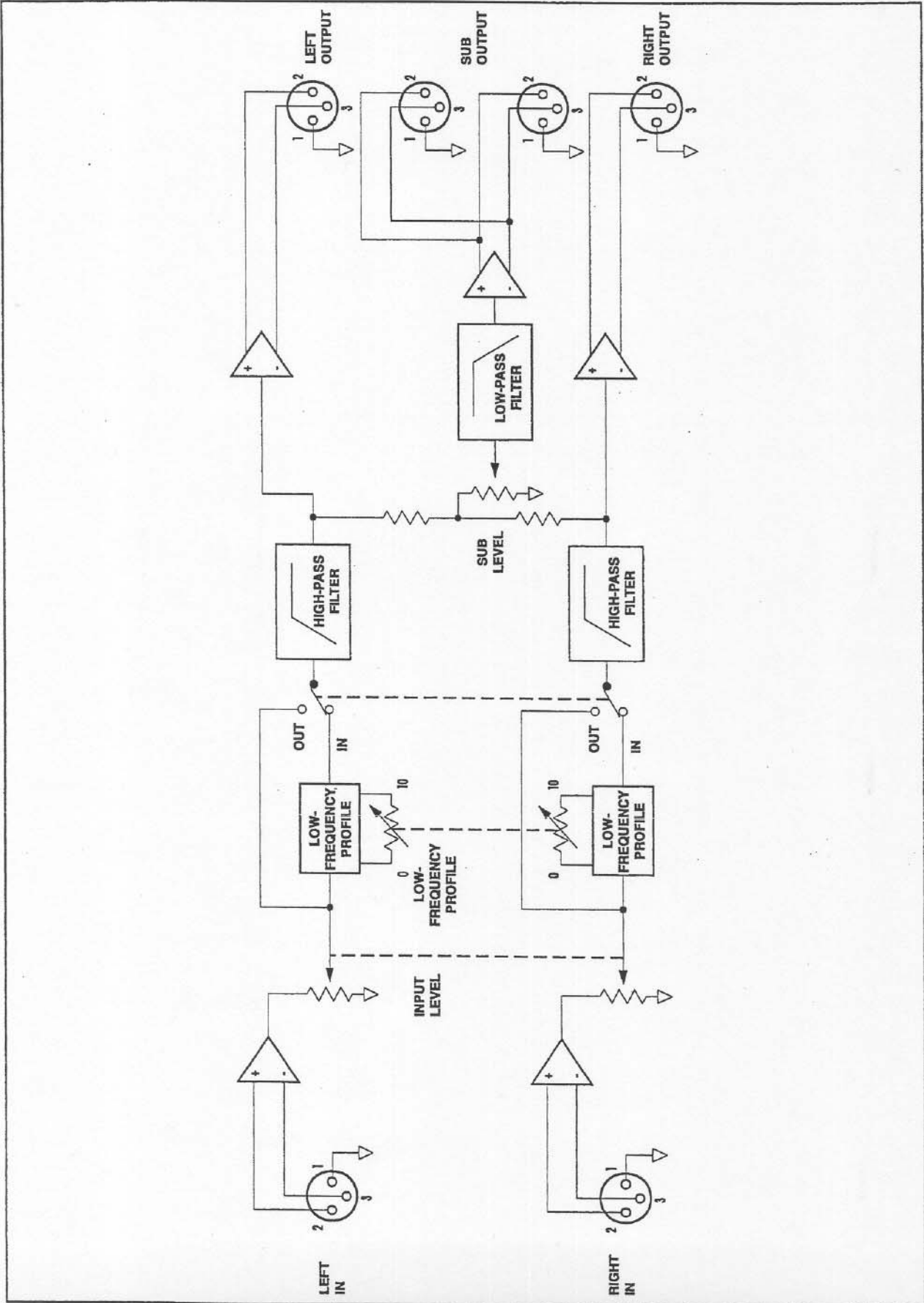
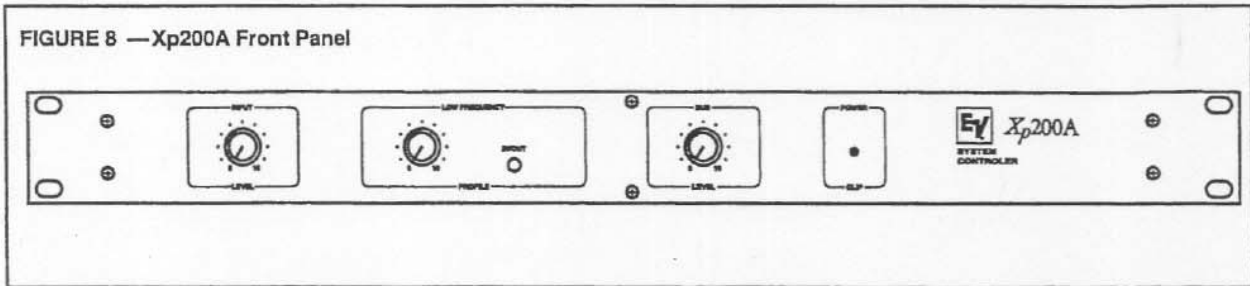

FIGURE 8 — Xp200A Front Panel



OPERATION AND INSTALLATION

FRONT-PANEL INDICATORS AND CONTROLS

The front-panel layout is shown in Figure 8 and described below:

- 1. INPUT LEVEL CONTROL:** This control attenuates the left and right inputs, and thus affects the left, right and subwoofer outputs. Attenuation is zero in the full-on, clockwise position (unity gain). Normally, for best overall system signal-to-noise ratio, this control would be set in the unity-gain position with level adjustments made at other points in the signal chain, most likely at the power amplifier or mixer/preamplifier.
- 2. LOW-FREQUENCY PROFILE CONTROL:** This control adjusts the degree of low-frequency enhancement, from a minimum of zero or off (full counterclockwise) to a maximum of +12 dB (full clockwise). The setting of this control is a matter of taste and is dependent on a variety of factors, including speaker performance characteristics and placement, room acoustics and program material. Feel free to experiment. A good starting point is a midway setting of the control.
- 3. LOW-FREQUENCY PROFILE IN/OUT SWITCH:** This switch switches the low-frequency enhancement in and out. It makes it easy to assess the effect of changes in the low-frequency profile control.
- 4. LOW-FREQUENCY PROFILE IN/OUT LED:** This LED illuminates green when the in/out switch is pushed in.
- 5. SUB LEVEL CONTROL:** This control attenuates the subwoofer output. (Keep in mind that the sub level is also affected by the Input Level control.) With both the sub and input

level controls set full on (clockwise) and the profile control off (counterclockwise), overall gain through the Xp200A is unity when a signal is present at **either** the left or right input. For stereo program with common signals in the subwoofer range, (a common condition) the sub output will offer 6 dB of gain in the full-on (clockwise) position. (This gain characteristic results because the sub output is derived from a sum of the left and right inputs.)

There is no "correct" setting of the Sub Level control. Adjust until the bass level and impact are right for your ears/application. The setting may be less than full on, especially if the Low Frequency Profile control is advanced.

NOTE: The Sb120a powered bass module has a System Gain control on its back panel which attenuates the input signal and thus reduces speaker output much as the Xp200A's Sub Level control does.

- 6. POWER/CLIP INDICATOR:** When constant green, this LED indicates power on and undistorted operation. If clipping occurs at any point within the Xp200A (+19 dBu output voltage), the LED changes from constant green to flashing red.

When clipping is indicated, for best sound quality, one or more Xp200A rotary controls should be turned down until undistorted operation is once again indicated. For the usual program material, the following sequence is probably the best: (1) Low-Frequency Profile, (2) Sub Level and (3) Input Level.

FIGURE 9 — Xp200A Back Panel

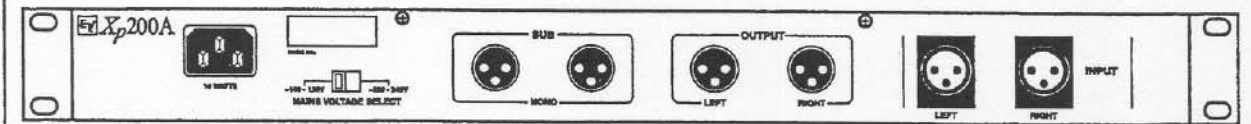

BACK-PANEL CONNECTIONS

The back-panel layout is shown in Figure 9 and described below:

1. **OUTPUTS (GENERAL):** All outputs are electronically balanced 3-pin type XLR (Male) connectors. Either balanced (three circuit) or unbalanced (two circuit) loads may be driven: the Xp200A's cross-coupled output topology automatically detects an unbalanced signal connection, and the gain of the circuit is increased by 6 dB to maintain the same output voltage at the power amplifier input.

The outputs of the Xp200A should ideally "see" (be loaded with) 1,500 ohms or more (600 ohms minimum). This is not a difficult condition to meet, since a typical amplifier input impedance is 30,000 ohms. See Connector and Cable Requirements section for additional wiring information.

2. **SUB OUTPUTS:** These connectors are in parallel and are the subwoofer output, derived from the sum of the left and right inputs, with a bandpass of 37-100 Hz (3 dB down, with 24-dB-per-octave slopes above and below these frequencies). Either one of the outputs should be connected to the input of the subwoofer power amplifier. Alternatively, the output may be connected to the input of an Sb120a powered bass module. The second, paralleled connector simplifies connection to a second power amplifier channel or Sb120a powered bass module. (Also, the Sb120a has two paralleled input connectors, so a second Sb120a may get its signal from the first Sb120a, if that is more convenient.)

The sub outputs are affected by the Sub Level, Input Level and Low Frequency Profile controls.

NOTE: If two amplifier channels are connected to the sub outputs, their combined, paralleled load should meet the conditions outlined in Section 2, above. For example, two paralleled 30,000-ohm amplifier inputs present a 15,000-ohm load to the controller output (a reduction of 50 percent).

3. **LEFT AND RIGHT OUTPUTS:** These connectors are the main, full-range/high-passed outputs and should be connected to the main power amplifier channels. With the Input Level control in the full-on, clockwise position, output levels are identical to the input levels, except that response is down 3 dB at 40 Hz with a 24-dB-per-octave roll-off below, for infrasonic speaker protection. The left and right outputs are also affected by the Low Frequency Profile control.
4. **LEFT AND RIGHT INPUTS:** These connectors are for the full-range right and left stereo signal inputs to the Xp200A controller. They are electronically balanced, with a high, 30,000-ohm input impedance, making them compatible with a wide range of sources. See Connector and Cable Requirements section for additional wiring information.
5. **AC POWER:** Plug the power cord into the IEC receptacle.

MOUNTING/INSTALLATION

The Xp200A is ready to install in one rack unit (1.75 in. high) of an EIA 19-in. rack. While the overall depth behind the front panel is about 12.3 cm (4.84 in.), about 7.6 cm (3.0 in.) of additional depth must be provided for typical connector/cable clearance.

TYPICAL SYSTEM 200™ MODULAR PRO AUDIO CONFIGURATIONS

The Xp200A controller will enhance the performance of one or more pairs of Sx200 full-range speaker systems used alone, or the performance of Sx200's used in combination with one or more Sb120a (powered) or Sb120 (nonpowered) bass modules.

Amplifier Power Recommendations

The power amplifiers shown in Figures 10 through 13 are typical, relatively conservative choices: different output power ratings are quite workable, including larger ratings:

1. To use a speaker system to full capacity, skilled experts in sound system installation and operation will obtain the best results if the power amplifier is 2.0 to 4.0 times the long-term average noise power rating of the speaker system. For the Sb120 and Sx200 systems, this is 600 to 1,200 watts.

The **caution** cannot be made strongly enough, however, that **this arrangement is only for experts** or for those who can discipline themselves against "pushing" the system for ever-higher sound levels and who can avoid "accidents" such as catastrophic feedback or dropped microphones.

2. A more conservative, "nominal" amplifier size, which will produce audible results nearly equal to those of the "expert" recommendation, is 1.0 to 1.4 times the long-term average noise power rating of the speaker. For the Sb120 and Sx200 speaker systems, this is 300 to 420 watts.
3. To be very conservative, one can use an amplifier rated at 0.5 to 0.7 times the long-term average rating of the loudspeaker. For the Sb120 and Sx200 speaker systems, this is 150 to 210 watts.

Request P.A. Bible Addition No. Two ("Power Handling Capacity") for more background on these recommendations.

Configurations Shown

Figure 10 shows the most basic setup: a pair of Sx200's. In this setup, the Xp200A provides low-frequency enhancement and infrasonic speaker protection for the Sx200's.

Figure 11 shows how to add one or two Sb120a powered bass modules. (The second module and its connection are shown in grey.)

Figure 12 shows how to add one Sb120 nonpowered bass module.

Figure 13 shows how to add two Sb120 nonpowered bass modules.

FIGURE 10 — Basic Hookup of the Xp200 Controller and a Pair of Sx200 Full-Range Speaker Systems

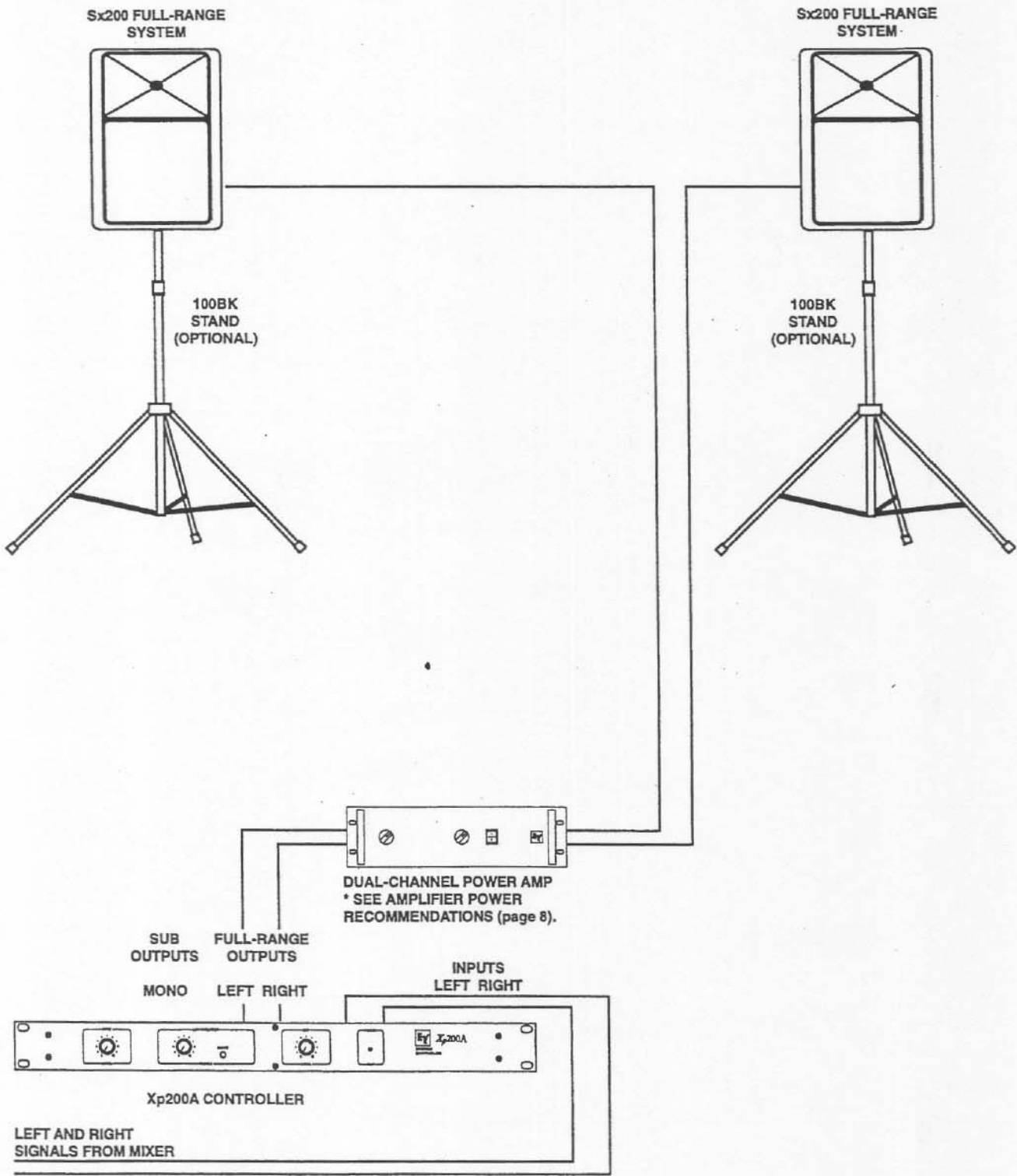

FIGURE 11 — Hookup of an Xp200A Controller with a Pair of Sx200 Full-Range Speakers and One or Two Sb120a Powered Bass Modules

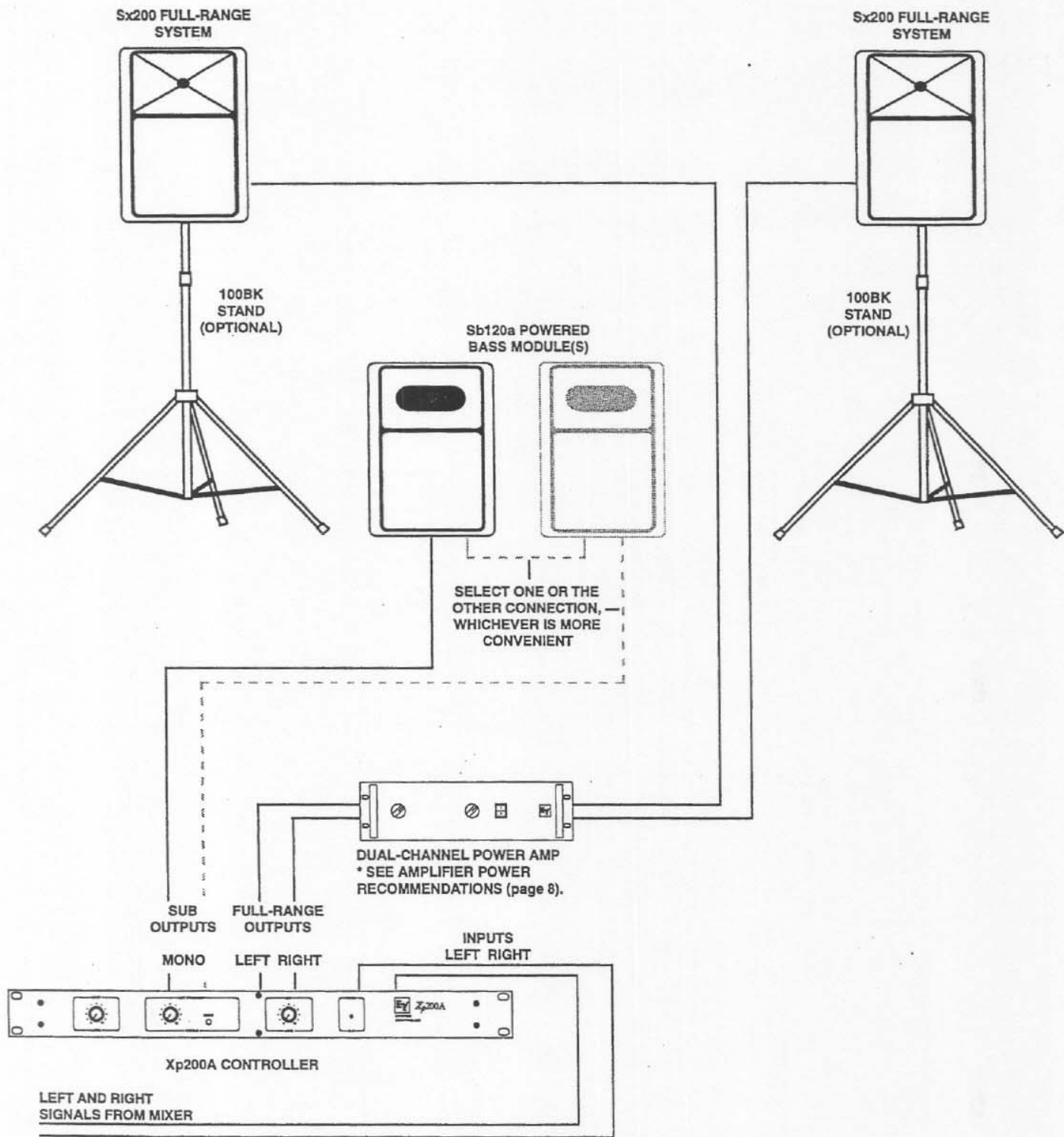

FIGURE 12 — Hookup of an Xp200A Controller and a Pair of Sx200 Full-Range Speakers and One Sb120 Nonpowered Bass Module

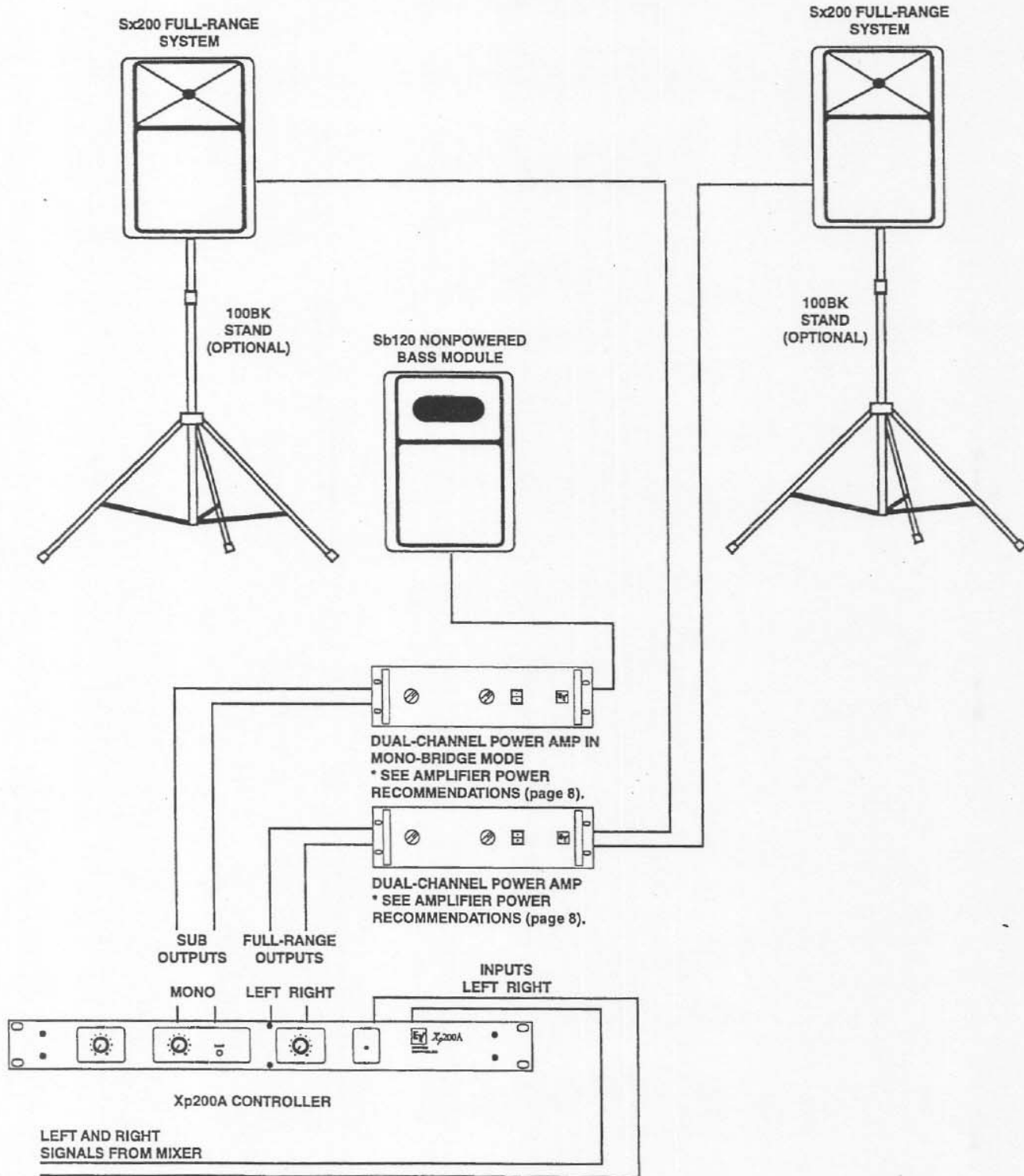
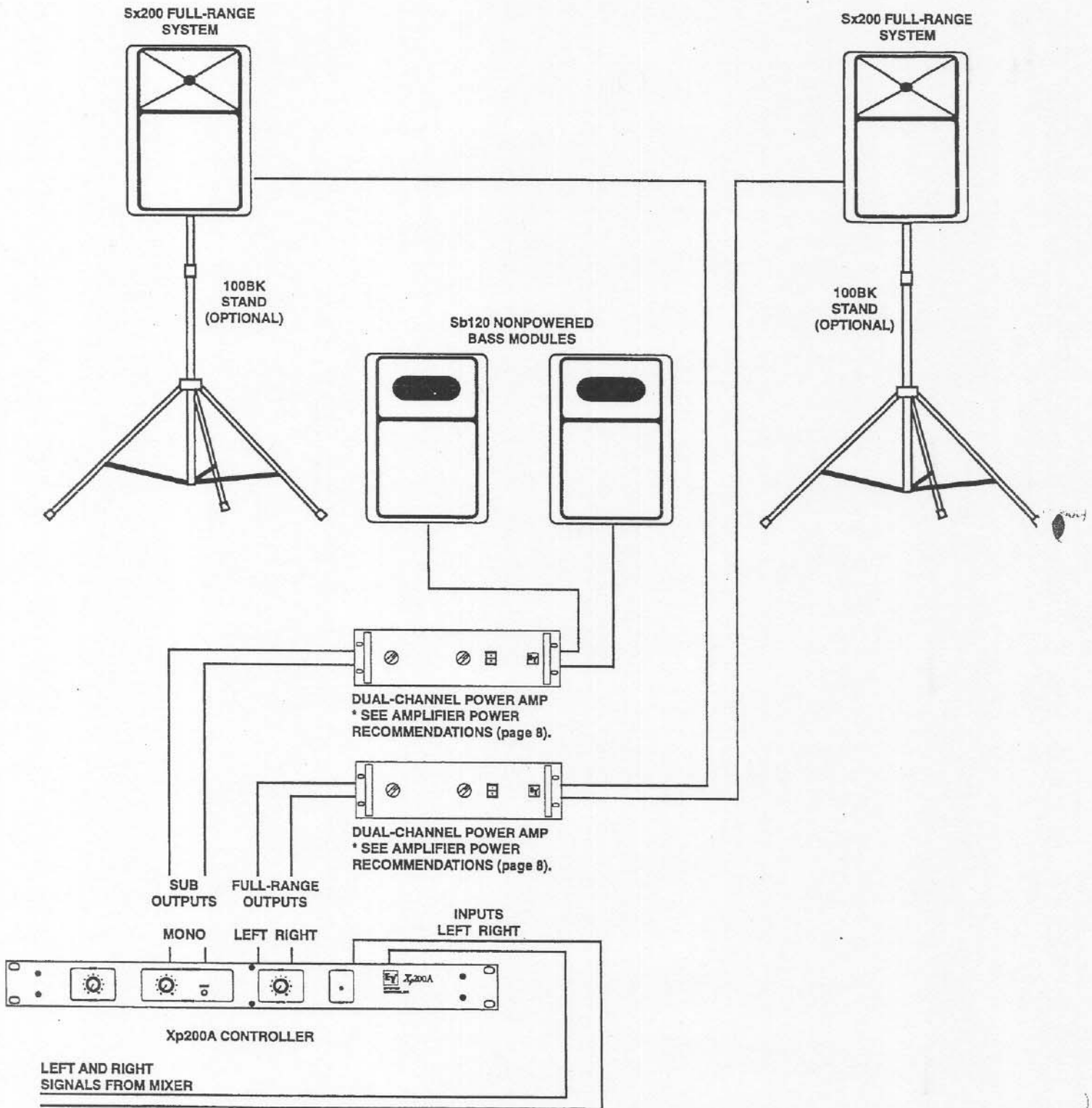

FIGURE 13 — Hookup of an Xp200A Controller and a Pair of Sx200 Full-Range Speakers and Two Sb120 Nonpowered Bass Modules



CONNECTOR AND CABLE REQUIREMENTS

Xp200A Input Connections

The Xp200A is compatible with both balanced and unbalanced signal sources.

Balanced Sources: Balanced signal sources are least susceptible to noise and should be used when possible. Figure 14A shows a 3-pin XLR-type plug used with two-conductor shield cable. This arrangement is appropriate for long runs, up to and beyond 100 feet. Note that the cable shield is not connected at the Xp200A input. This prevents the formation of ground loops, a major source of hum and noise.

Unbalanced Sources: For long cable runs from unbalanced sources (greater than about six feet and up to about 100 feet), the connection is shown in Figure 14B with pins 1 and 3 connected within the connector.

For short unbalanced cable runs (up to six feet), Figure 14C shows a 3-pin XLR-type plug with pins 1 and 3 connected together within the connector.

Xp200A Output Connections

Balanced Loads: Power amplifiers with balanced inputs are the least susceptible to noise, and should therefore be used when possible. Figures 15A and 15B show an appropriate cable configuration, with a 3-pin XLR-type plug on the Xp200A end and connections for a 1/4-inch TRS plug and a 3-pin XLR-type plug, respectively, at the amplifier end. (The Sb120a powered bass module accepts

either type.) Note that two-conductor shielded cable is used throughout. Also, note that the cable shield is not connected to the connector sleeve at the power amp input. This prevents the formation of ground loops, a major source of hum and noise.

Unbalanced Loads: When unbalanced power amplifiers must be used, the cable shown in Figure 15C is recommended for the lowest noise and long runs (up to about 100 feet). Note that two-conductor shielded cable is used and that the shield is not connected at the Xp200A end but is connected to ground at the amplifier end. The Xp200A's cross-coupled output topology increases the gain of the circuit by 6 dB, keeping the Xp200A's output voltage the same at the power amplifier input.

For short runs to unbalanced amplifiers (up to about six feet), a 3-pin XLR-type plug on the Xp200A end and connections for a 1/4-inch TRS plug on the amplifier input. See Figure 15D. The Xp200A's cross-coupled output topology increases the gain of the circuit by 6 dB, keeping the Xp200A's output voltage the same at the power amplifier.

Sx200 and Sb120 Speaker System Connections

The Sb120 and Sx200 are equipped, as standard, with one Neutrik Speakon® NL4MP and one 1/4-in. phone jack connected in parallel, a configuration which allows for daisy-chaining of speaker systems. Additional Neutrik Speakon NL4MP and 1/4-in. phone jacks are supplied for

FIGURE 14 — Connecting the Xp200A Controller to the Signal Source

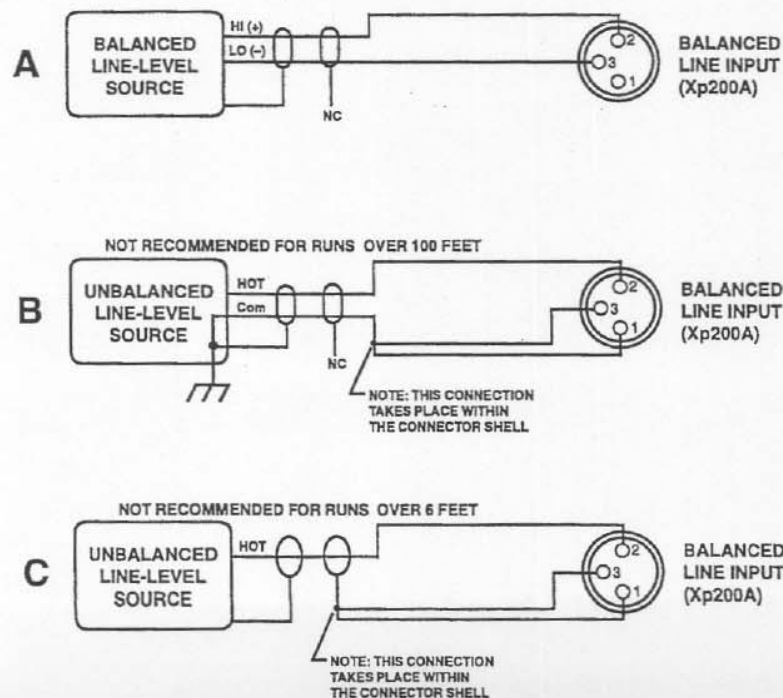

maximum flexibility.

In continued high-powered applications, Electro-Voice recommends the use of the Speakon connector. However, to provide a high level of compatability, the 1/4-in. phone jacks are also provided. The Speakon NL4MP will mate to a NL4FC Speakon connector, which is a 4-pin connector. Figure 16 shows typical wiring configurations using banana plugs or 1/4-in. phone plugs (the banana plug provides the more reliable connection). Cable connections should be made to the 1+ and 1- terminals only. Cables utilizing the Speakon NL4FC connector are available from

your local dealer or from the companies listed below.

Pro Co Sound, Inc.
135 E. Kalamazoo Ave.
Kalamazoo, MI 49007
616/388-9675

Whirlwind Music Distributors, Inc.
P.O. Box 1075
Rochester, NY 14603
716/663-8820

Neutrik USA, Inc.
195-S3 Lehigh Ave.
Lakewood, NJ 08701
908/901-9488

FIGURE 15 — Connecting the Xp200A Controller to Power Amplifiers and the Sb120a Powered Bass Modules Sx200 and Sb120 Speaker System Connections

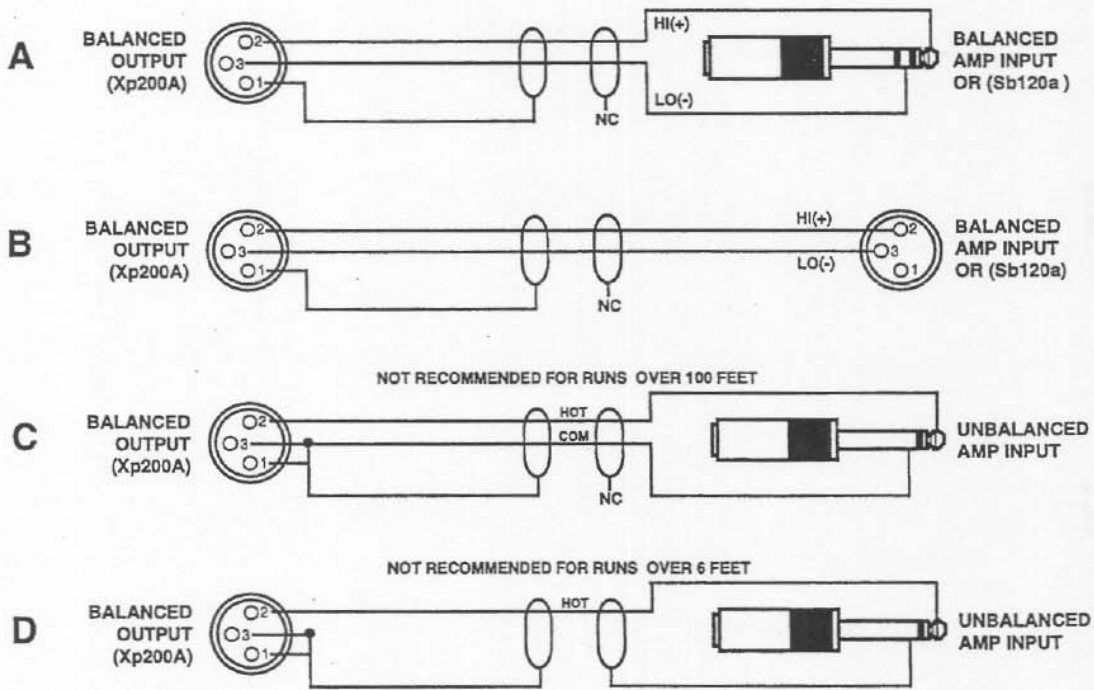
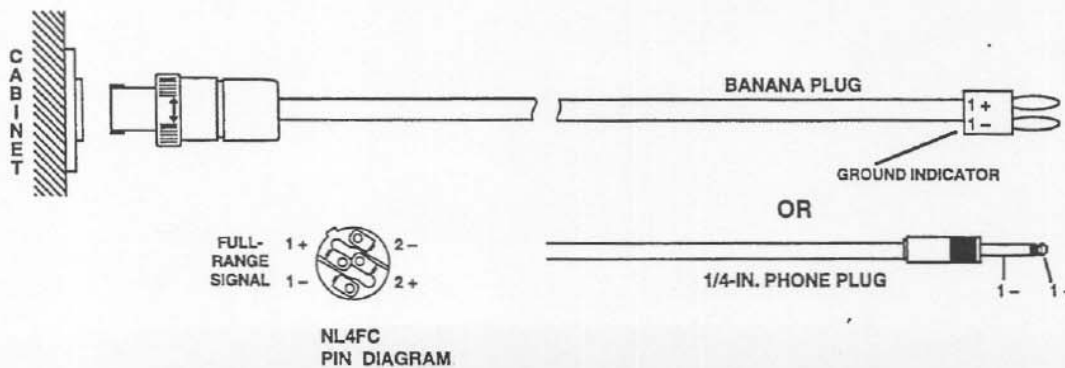

FIGURE 16 — Two-Conductor Cable Configurations for Sx200 and Sb120 Speaker Systems Using Neutrik Speakon® NL4FC Connector



SERVICE INFORMATION

*****CAUTION*****

NO USER SERVICEABLE PARTS INSIDE. EXTREMELY HAZARDOUS VOLTAGES AND CURRENTS MAY BE ENCOUNTERED WITHIN THE CHASSIS. THE SERVICING INFORMATION CONTAINED WITHIN THIS DOCUMENT IS ONLY FOR USE BY ELECTRO-VOICE AUTHORIZED WARRANTY REPAIR STATIONS AND QUALIFIED PERSONNEL. TO AVOID ELECTRIC SHOCK, DO NOT PERFORM ANY SERVICING OTHER THAN THAT CONTAINED IN THE OPERATING INSTRUCTIONS UNLESS YOU ARE QUALIFIED TO DO SO. OTHERWISE, REFER ALL SERVICING TO QUALIFIED SERVICE PERSONNEL.

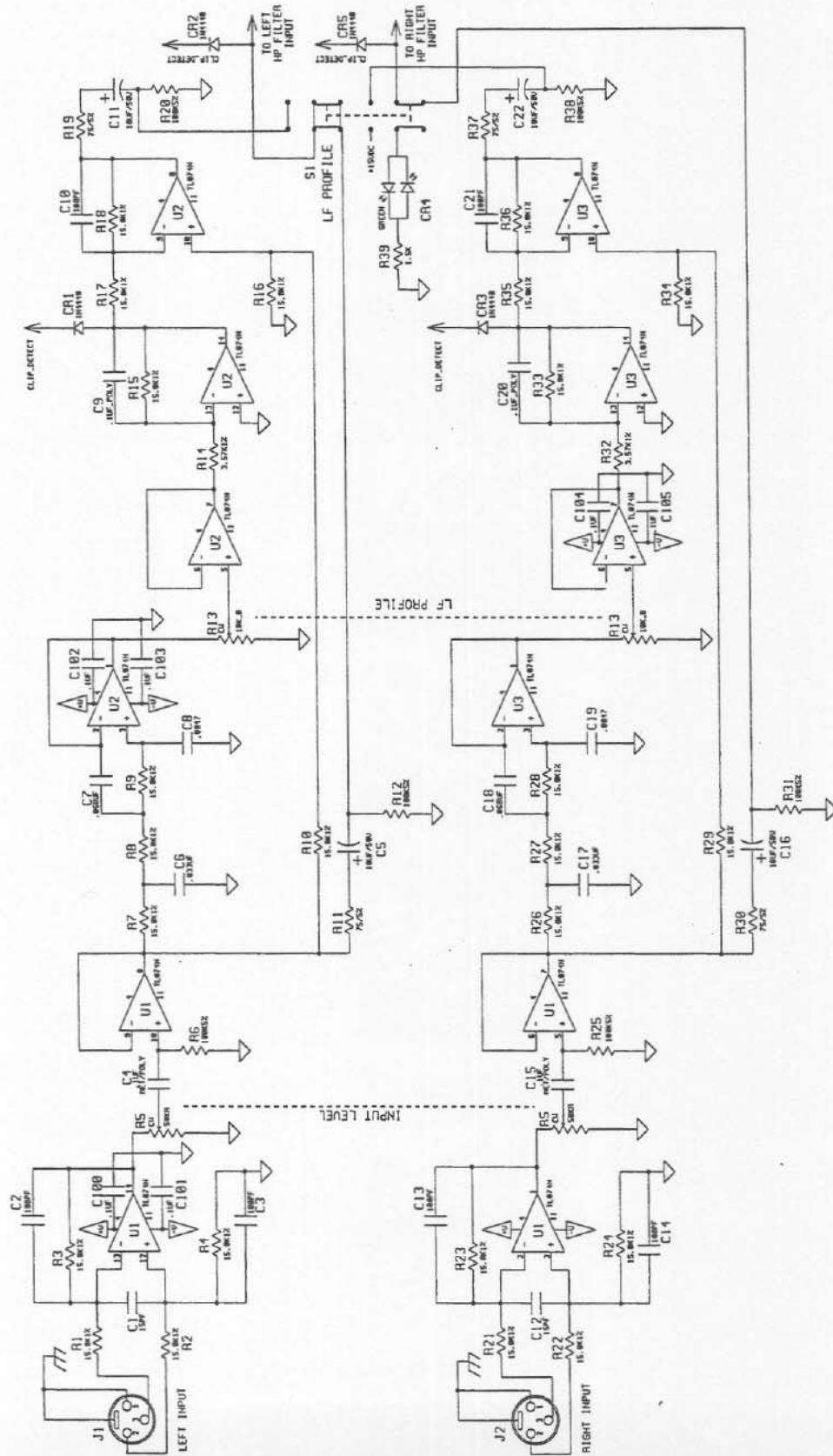

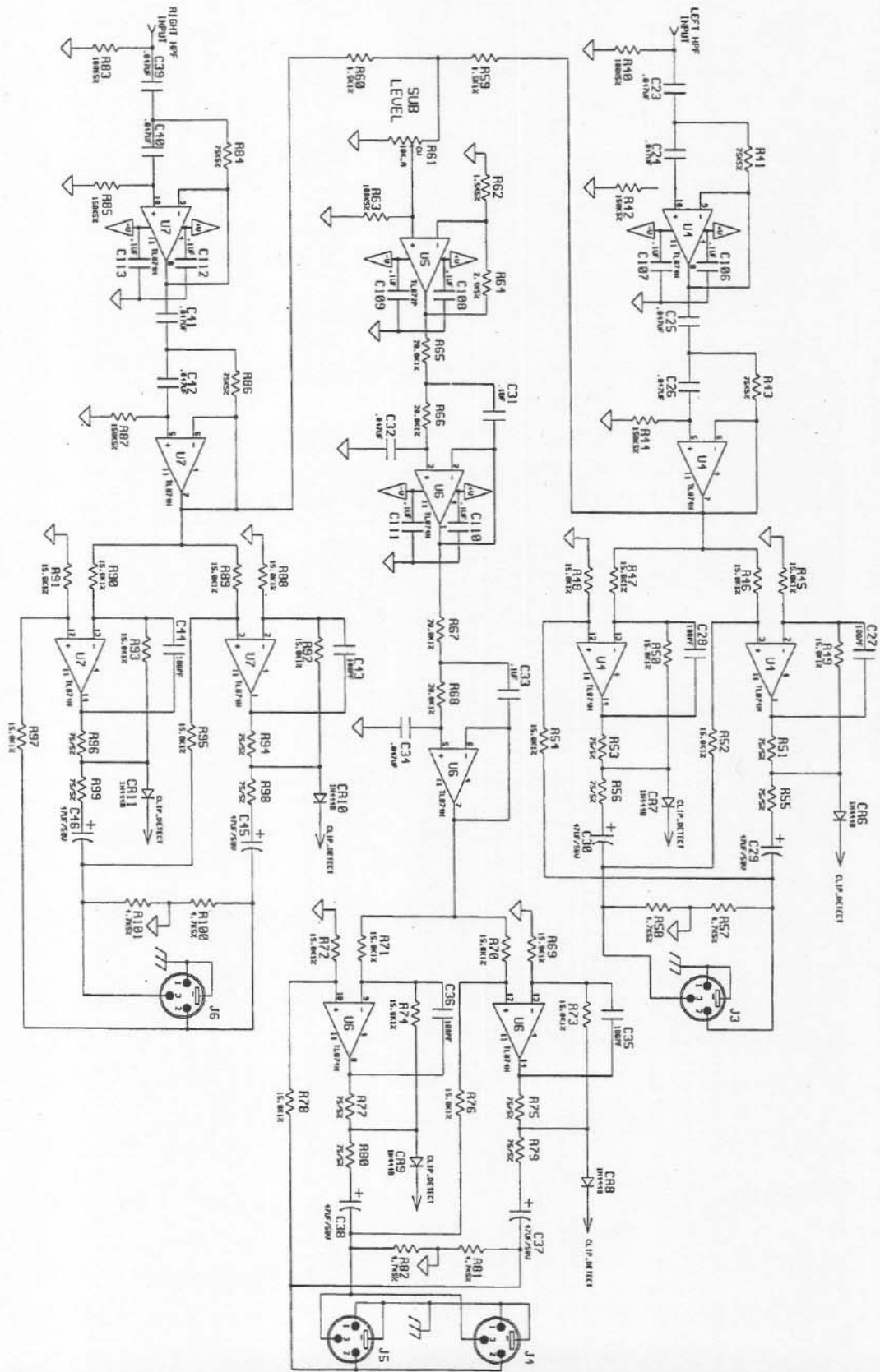

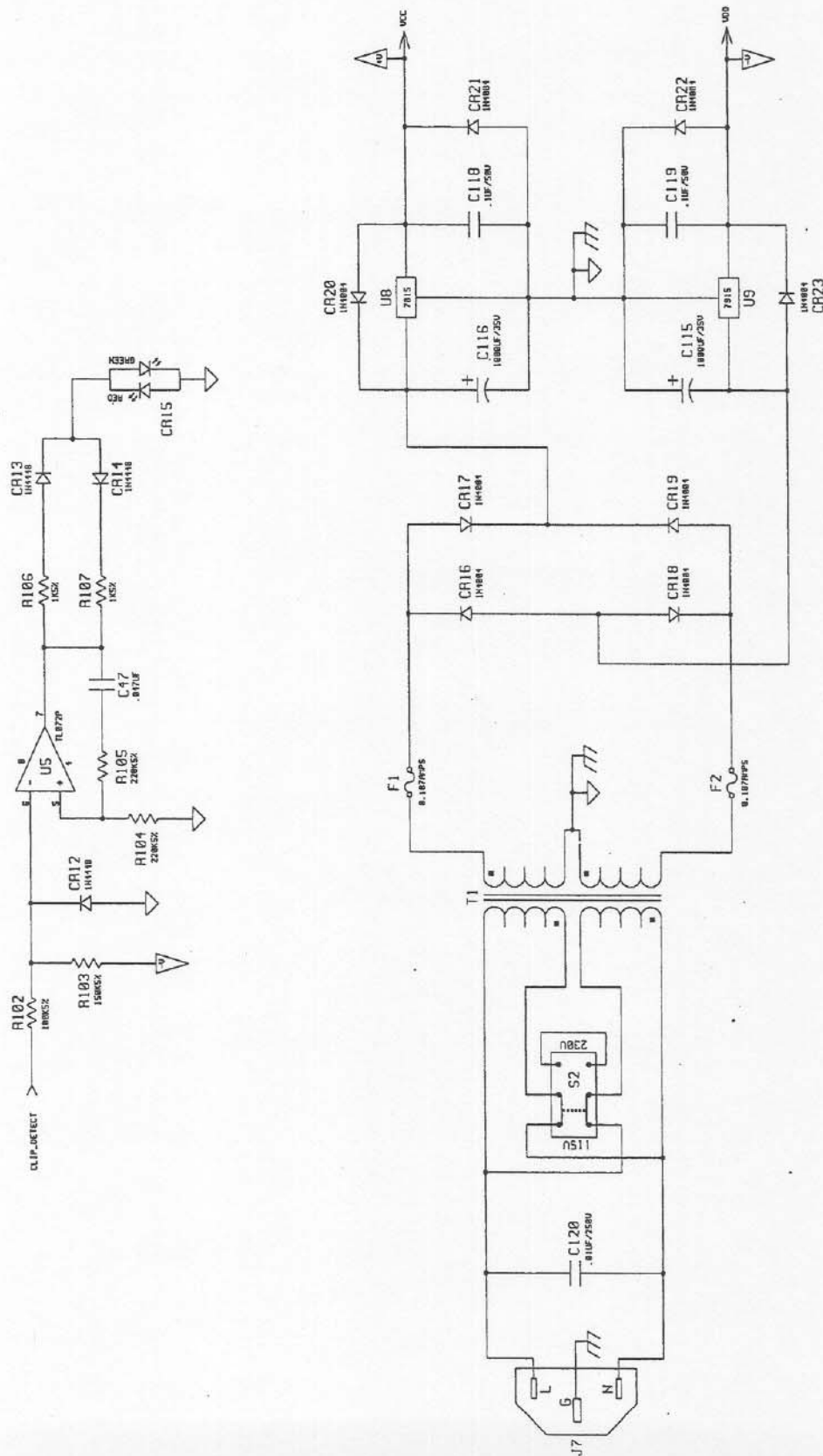

SERVICE/WARRANTY INFORMATION**SHIPPING DAMAGE**

Inspect the shipping carton for possible damage. If damage is found, notify the transportation company immediately. Save the carton as evidence for the carrier to inspect. If damage occurs during shipping, it is the responsibility of the consignee to file a claim with the carrier. If the carton is in good condition but the unit is damaged, call Electro-Voice.

Included in the box with the Xp200A controller are hardware kit (mounted), pad of rubber feet, power cord, Product Evaluation Questionnaire and this manual.

FIELD SERVICE**Controller Power Inspection**

If the Xp200A power indicator does not light, check the power supply connections.

WARRANTY (Limited)

Electro-Voice products are guaranteed against malfunction due to defects in materials or workmanship for a specified period, as noted in the individual product-line statement(s) below, or in the individual product data sheet or owner's manual, beginning with the date of original purchase. If such malfunction occurs during the specified period, the product will be repaired or replaced (at our option) without charge. The product will be returned to the customer prepaid. **Exclusions and Limitations:** The Limited Warranty does not apply to: (a) exterior finish or appearance; (b) certain specific items described in the individual product-line statement(s) below, or in the individual product data sheet or owner's manual; (c) malfunction resulting from use or operation of the product other than as specified in the product data sheet or owner's manual; (d) malfunction resulting from misuse or abuse of the product; or (e) malfunction occurring at any time after repairs have been made to the product by anyone other than Electro-Voice or any of its authorized service representatives.

Obtaining Warranty Service: To obtain warranty service, a customer must deliver the product, pre-paid, to Electro-Voice or any of its authorized service representatives together with proof of purchase of the product in the form of a bill of sale or receipted invoice. A list of authorized service representatives is available from Electro-Voice at 600 Cecil Street, Buchanan, MI 49107 (616/695-6831 or 800/234-6831). **Incidental and Consequential Damages Excluded:** Product repair or replacement and return to the customer are the only remedies provided to the customer. Electro-Voice shall not be liable for any incidental or consequential damages including, without limitation, injury to persons or property or loss of use. Some states do not allow the exclusion or limitation of incidental or consequential damages so the above limitation or exclusion may not apply to you. **Other Rights:** This warranty gives you specific legal rights, and you may also have other rights which vary from state to state.

Electro-Voice Speakers and Speaker Systems are guaranteed against malfunction due to defects in materials or workmanship for a period of five (5) years from the date of original purchase. The Limited Warranty does not apply to burned voice coils or malfunctions such as cone and/or coil damage resulting from improperly designed enclosures. **Electro-Voice Electronics** are guaranteed against malfunction due to defects in materials or workmanship for a period of three (3) years from the date of original purchase. **Electro-Voice Flying Hardware** (including enclosure-mounted hardware and rigging accessories) is guaranteed against malfunction due to defects in materials or workmanship for a period of one (1) year from the date of original purchase. Additional details are included in the Uniform Limited Warranty statement.

Service and repair address for this product: Electro-Voice, Inc., 600 Cecil Street, Buchanan, Michigan 49107 (616/695-6831 or 800/234-6831).

Specifications subject to change without notice.

PARTS LIST
CIRCUIT BOARD ASSEMBLY (27-01-039954)

Reference Designator	Part Number	Description
R1-4,7-10,15-18,21-24,26-29,33-36,45-50	47-03-124484	Res 15.0 k Ohm/1%/.25W Met Fim Ax
R52,54,69,70-74,76,78,88,89,90-93,95,97		
R5 - Input Level	47-06-039348	Pot 10 k Ohm/Dual/ Taper A
R6,12,20,25,31,38,40,63,82,102	47-01-102127	Res 100 k Ohm/5%/.25W Car Fim Ax
R11,19,30,37,51,53,55,56,75,77,79,80,96, R98,99	47-01-102051	Res 75 Ohm/5%/.25W Car Fim Ax
R13 - Low Frequency Profile Level	47-06-039346	Pot 10 k Ohm/Dual/ Taper B
R14,32	47-03-124651	Res 3.57 k Ohm/1%/.25W Met Fim Ax
R42,44,85,87,103	47-01-102131	Res 150 k Ohm/5%/.25W Car Fim Ax
R57,58,81,82,100,101	47-01-102094	Res 4.7 k Ohm/5%/.25W Car Fim A
R59,60	47-03-124669	Res 1.50 k Ohm/1%/.25W Met Fim Ax
R61 - Sub Output Level	47-06-039347	Pot 10 k Ohm/Single/Taper A
R64	47-06-102087	Res 2.4 k Ohm/5%/.25W Car Fim Ax
R65-68	47-03-109434	Res 20.0 k Ohm/1%/.25W Met Fim Ax
R104,105	47-01-107043	Res 220 k Ohm/5%/.25W Car Fim Ax
R106,107	47-01-102078	Res 1 k Ohm/5%/.25W Car Fim Ax
R41,43,84,86	47-01-102124	Res 75 k Ohm/5%/.25W Car Fim Ax
R39,62	47-01-102082	Res 1.5 k Ohm/5%/.25W Car Fim Ax
C1,12	15-02-029032	Cap 15 pF/10%/50V Cer Disk Rad
C2,3,10,13,14,21,27,28,35,36,43,44	15-06-037468	Cap 100 pF/630V/ Polyprop Ax
C4,15,31,33	15-06-124637	Cap .1 uF/5%/100V/ Poly Rad
C6,17	15-06-028021	Cap .033 uF/10%/50V Mylar Rad
C7,18	15-06-028023	Cap .068 uF/10%/50V Mylar Rad
C8,19	15-06-124611	Cap .0047 uF/5%/100V Mylar Rad
C9,20	15-06-037653	Cap .1 uF/2%/100V Poly Rad
C23-26,32,34,39-42,47	15-06-027367	Cap .047 uF/5%/50V Mylar Rad
C29,30,37,38,45,46	15-01-026641	Cap 47 uF/50V Al Elec Rad
C100-113,118,119	15-02-124437	Cap .1 uF/50V Cer Disk Rad
C5,11,16,22	15-01-028691	Cap 10 uF/50V AL Elec Ax
C115,116	15-01-028635	Cap 1000 uF/50V Al Elec Ax
C5,11,16,22	15-01-028691	Cap 10 uF/50V Al Elec Rad
C120	15-02-026884	Cap .01 uF/250V UL car
CR1-3,5-14	48-01-122601	Dio 1N4448 75V/10mA/.5W
CR6-23	48-02-042787	Dio 1N4004/400V/1A
CR4,15	39-01-039375	Led, dual - red/green
Sleeving, LED leads	31-03-113272	Slvg, 20GA Teflon 0.016(.75 in/lead)
U1-4,6,7	17-01-124461	IC TL074CN opamp, quad
U5	17-01-124688	IC TL072CP opamp, dual
U8	17-01-121660	IC MC7815CT volt reg, +15VDC
U9	17-01-121659	IC MC7915CT volt reg, -15VDC
J1,2	21-01-124470	Conn XLR fem rtang pcmt
J3-6	21-01-124642	Conn XLR male rtang pcmt
S1	51-02-124479	Sw, pushbutton/pcmt/dpdt

CIRCUIT BOARD ASSEMBLY (27-01-039954)

S2	51-02-050016	Sw,slide/ voltage select pcmt
Power Transformer	56-08-050014	Xfmr, pcmt 36VCT/10VA
Fuse clips	51-04-038147	Fuse clips 5mm pcmt (4 required)
Fuses	51-04-038138	Fuse, 0.16A/250V sb 5x20mm (2 required)
Heatsink, Voltage Regulators	14-05-045222	Htsk, Al block (2 required)
4-40 x 3/8 Machine PH screw	28-01-113969	Scr, mch 4-40 x 3/8 (2 required)
4-40 Hex Nut	28-02-113970	Nut, kps 4-40 hex stl (2 required)
Receptacle, IEC	21-02-124466	Recpt, IEC/pcmt
Power Cord	60-06-124962	Cbl, power 18 ga/3 conductor

PARTS LIST (cont.)
ACCESSORIES

Reference Designator	Part Number	Description
Control Knobs	24-04-038872	Knob, body-blk/cap-blk/line-white
Switch Knob	24-04-039407	Knob push-button, Blk
Rubber Feet	28-09-027303	Foot, rubber, Blk (4 required)
Insulator, Mylar	31-02-050048	Insul, mylar 4.625 x 5.0 in.
Ring, XLR Female	14-20-026511	Ring, XLR female (2 required)
Hardware Kit	28-13-026422	Rack mount hardware kit
Panel Nut, Black	28-02-026761	Nut, 75mm x .75 mm (2 required)

HARDWARE

4-24 x 3/8 type AB FH screw	28-01-028302	Secures top to chassis/front (2 required)
4-40 x 1/4 Rolox PH screw	28-01-124701	Secures top to chassis/back (2 required)
6-32 x 5/16 Rolox PH screw	28-01-125083	Secures top to chassis/sides(4 required)
6-32 x 5/16 Rolox PH screw	28-01-125083	Secures IEC connector to chassis (2 required)
6-32 x 1/4 machine PH screw	28-01-115517	Secures PCB to chassis (10 required)
6-32 x 3/8 Rolox FH screw	28-01-124965	Secures front panel to chassis (4 required)