

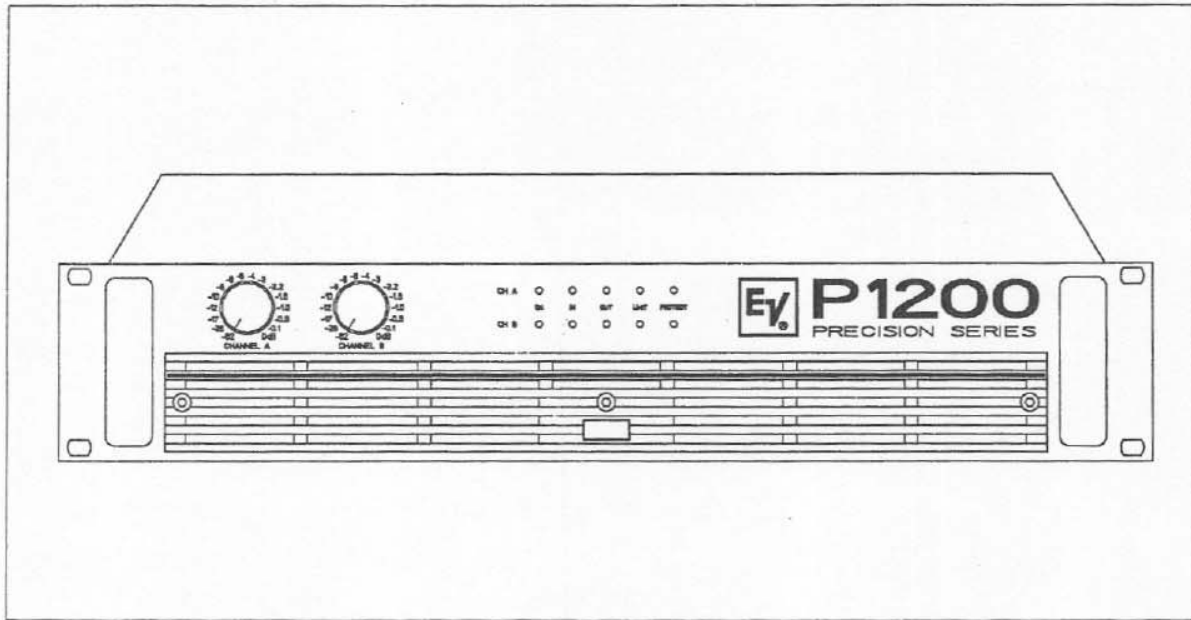

# Electro-Voice®

## OWNER'S MANUAL



P 1200

PRECISION SERIES

**DESCRIPTION**

Thank you very much for choosing an EV PRECISION SERIES amplifier. We are sure it will give you many years of satisfying performance.

EV power amplifiers of the PRECISION SERIES meet the stringent requirements of tough touring applications. They are protected against over-temperature, overload, shorted outputs, radio frequency interference and DC faults. The power transistors are protected from damage from reverse feeding of electrical energy by means of an additional special protective circuit. For the so-called soft-start, the power outputs are switched on delayed via relays. An inrush current limiter circuit prevents the mains fuses from being blown.

Maximum precision is also guaranteed as regards mechanical construction and finish. The robust steel chassis features remarkable torsion resistance and is specially designed to cope with the tough wear and tear associated with going on tour. Thermal stability is guaranteed by several low noise 3-stage fans which also means that they can be used inside the studio.

Comparator circuits constantly compare the power amplifiers' input and output signal and control the limiters under non-linear operating conditions. They protect the loudspeakers from overload due to power stage clipping. The PRECISION SERIES power amplifiers feature excellent transmission properties. The power amplifier topology also makes for extremely low distortion rates. Distortion factor (THD), intermodulation distortion (SMPTE-IM) and transient intermodulation distortion (DIM 30 and DIM 100) are so low that they are only detectable with the most sophisticated measuring equipment. Generously dimensioned power supplies with low-leakage toroidal-core transformers provide considerable headroom well above the nominal ratings. V/I foldback limiter circuits were deliberately not included in the PRECISION SERIES power amplifiers to facilitate operation at complex loads up to a phase angle of  $\pm 90^\circ$ .

The inputs are electronically balanced on XLR connectors. (Isolation transformers can be retrofitted). Direct Outs in the form of XLR connectors (male), to loop the signal through, are also standard features. The modes DUAL/Stereo or PARALLEL/Mono can be selected via the Input Routing Switch. Furthermore, the PRECISION SERIES power amplifiers can also be operated in "Mono Bridged" mode.

The front panel accommodates the dB-calibrated input Gain controls which are designed as especially precise and safe-to-operate detented potentiometers. The LED display provides information about the power amplifiers' operating status. For the two channels, they demonstrate readiness to operate, whether there is a signal at the input or output, when the Limiters have been activated and whether one of the protective features has been triggered. The power outputs Channel A, Channel B and Bridged Out are available on Speakon connectors. The rear side of the unit accommodates the ON/OFF switches for the integrated Hi and Lo cut filters, a groundlift switch which separates the housing from the circuit ground thus helping to prevent hum loops and the operating modes selector to mono bridged operation. They also feature extremely quiet fans with front-to-rear airflow, facilitating operation in large and narrow amplifier racks.

This Owner's Manual is meant to help you familiarize yourself with all the PRECISION SERIES' other features. Please read it through carefully and we guarantee that your new power amplifier of the PRECISION SERIES from EV will give you great pleasure.

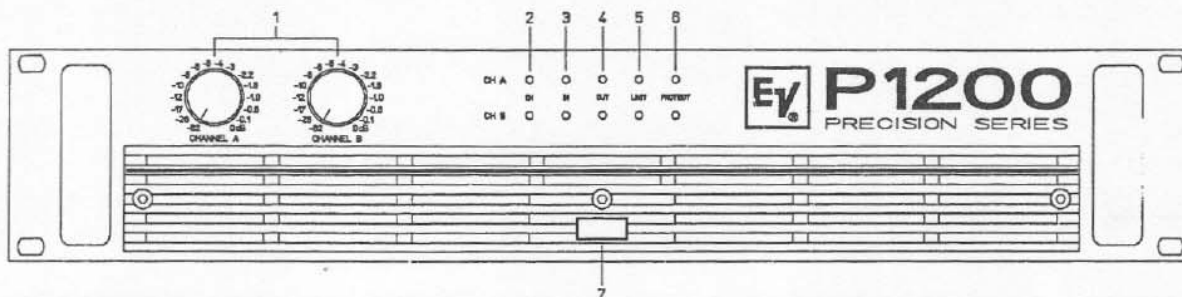

### 1. Level Control

Calibrated detented potentiometers to alter the total gain of the power amplifier. In order to avoid distortion in mixing consoles upstream, these controls should normally be positioned between 0 dB and -6 dB. The calibrated markings show the additional attenuation directly.

### 2. Power ON indication

This LED lights up when the mains switch is pressed. If it does not light up, the unit is not connected to the mains or the mains fuse has blown.

### 3. Input indication

This LED lights up if a signal is present at the power amplifier input. The indicator does not light up when the input controls are turned down completely.

### 4. Output indication

This LED lights up if a signal is present at the power amplifier output. The indicator goes off when the speaker line has shorted or a protective circuit has been activated thus indicating that there is no signal at the speaker output terminals.

### 5. LIMIT

This LED lights up if the limiter has been activated and the power amplifier is being operated at the clip level. If the LED flashes briefly, this is not a cause for concern. If this LED is lit permanently, the volume should be reduced to avoid overload damages to the connected loudspeaker systems.

### 6. PROTECT

When this LED lights up during operation, one of the protection circuits against over-temperature, overload, shorted outputs, radio frequency interference or DC faults has been triggered. The cause of the error e.g. a shorted loudspeaker line must be remedied. In case of overheating, wait a little until the amplifier switches back to operating mode itself.

### 7. POWER Switch

The unit is switched on via the power switch. The loudspeaker outputs are switched on via delayed relays so that no startup transients are audible. A current limiter prevents startup peaks on the mains line and prevents the mains fuse from blowing.

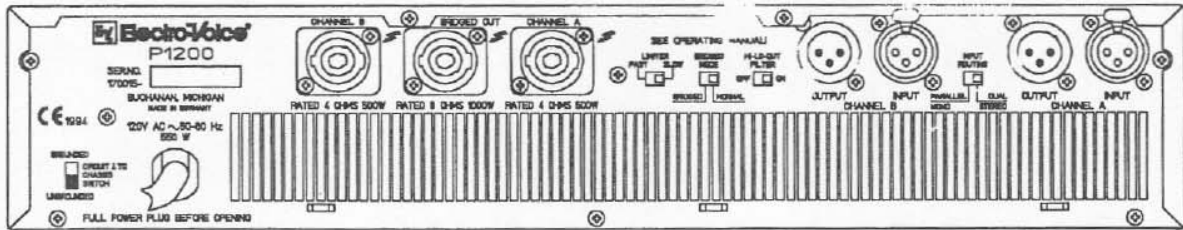

## REAR SIDE

### Power amplifier input connectors

XLR connectors (male) are provided for "Looping" the signal to other power amplifiers. These are wired parallel to the XLR input connectors in each channel.

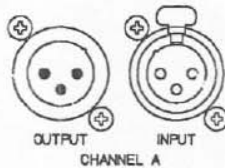

The inputs of the power amplifier are electronically balanced and wired according to IEC 268. Isolation transformers can be retrofitted in order to avoid hum interference in larger sound reinforcement systems. Please contact your dealer if you have any problems.

### Input wiring XLR

- PIN 1: SHIELD
- PIN 2: a, +, hot
- PIN 3: b, -, cold

The inputs are electronically balanced.

The input sensitivity is set to 0dBu (775 mV) by the factory. Please contact your local dealer if you want to change to 6dBu or 26 dB gain.

## INPUT ROUTING

### PARALLEL MONO

If the mode selector is in position PARALLEL MONO, the input connectors channel A and B are directly wired in parallel, but the volume for channel A or B can be adjusted independently using the input controls A or B.

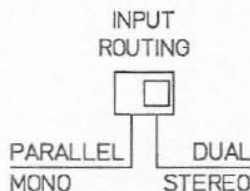

### DUAL STEREO

If the mode selector is in position DUAL STEREO, channel A and B are amplified separately.

Many mixing consoles have XLR connectors in the outputs, but are wired in such a way that they are unbalanced. If a mixer is used with unbalanced outputs, PIN 1 and PIN 3 of the power amplifier's input connectors must be connected by a jumper or PIN 3 must not be connected to the connection cable.

If signals are taken from unbalanced units via PIN 3 (b, -, cold) and PIN 2 (a, +, hot), strange hum interference or high frequency oscillations can occur. These effects can cause power amplifiers or loudspeakers to malfunction.

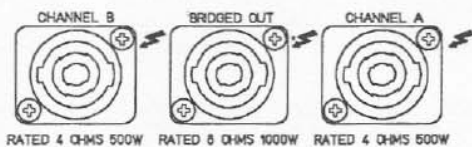

**POWER AMPLIFIER OUTPUT CONNECTORS**

SPEAKON output connectors are provided for the power amplifier channels A (left) and B (right). The Bridged Out connector for bridged operation is sealed with a plastic cover to prevent connection errors.

**WARNING:**

Please make sure not to hook Speakers up to the BRIDGED OUTput in NORMAL mode or damage will result.

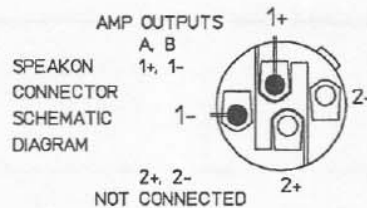

**LIMITER**

The time constant of the built-in limiter to avoid overdriving is adjustable. Position "SLOW" is the factory preset and this should also be the normal position.

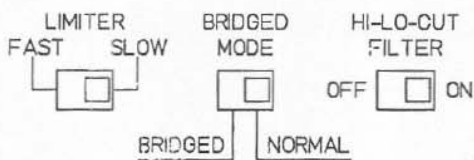

If the power amplifier is used as a MID/HI-frequency amplifier in active multi-way systems, the limiter switch should be set to "FAST".

If the power amplifier is used as LOW-frequency amplifier in active multi-way systems, the limiter switch should be set to "SLOW".

**BRIDGED MODE**

Slide switch to change from Normal Stereo mode to Bridged mode. In Bridged mode the built-in power amplifiers operate in "push- pull" and the double output voltage from channel A and B appears at the Bridged output connector. The phases of Channel A and B are in opposite and therefore the individual channels must not be used as loudspeaker outputs.

**HI-LO-CUT FILTER**

This filter attenuates subsonic and high frequency signals so that the power amplifiers are not modulated with these signals. This switch should normally always be in position ON. The OFF position is only for applications where an upstream unit, e.g. a crossover or a equalizer, has integrated HI-Cut and LO-Cut filters.

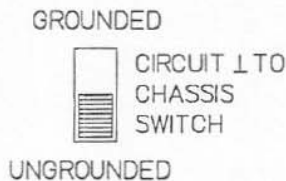

**GROUND LIFT SWITCH**

Hum loops can be avoided with the groundlift switch. If the power amplifier is operated together with other units in one 19" rack, the switch should be in GROUND position. If the power amplifier is used with units which have different earthing potentials, the switch should be adjusted to the UNGROUND position.

**TECHNICAL SPECIFICATIONS** at rated output power 8ohms, one channel driven, unless otherwise specified

<b>Model</b>	<b>P 1200</b>
<b>Output Power</b> (20Hz - 20kHz / THD = 0.1%)	
into 8 Ohms	2 x 350 W
into 4 Ohms	2 x 500 W
into 8 Ohms bridged	1 x 1000 W
<b>Output Power</b> (1kHz / THD = 1.0%)	
into 8 Ohms	2 x 370 W
into 4 Ohms	2 x 550 W
into 8 Ohms bridged	1 x 1100 W
<b>Technical Specification</b>	
Frequency Response	10 Hz - 30 kHz / -1dB
Max. Output Level before Clipping, reference 1 KHz / THD = 1%	66V / RMS
Voltage Gain reference 1kHz	26 dB (constant gain option)
Input Sensitivity at rated output power 4 ohms, reference 1 kHz	0 dBu/0.775 V 6 dBu/1.55 V
Maximum Input Level	21 dBu / 9 V
Input Impedance active balanced	20 kOhm
THD at rated output power MBW = 80 kHz, f = 1kHz	< 0.05%
IMD - SMPTE 60 Hz, 7 kHz	< 0.01%
Signal / Noise Ratio A-weighted, RMS, input sensitivity 6 dBu	> 105 dB
Crosstalk at rated output power reference 1 kHz	< -70 dB
Damping Factor internal, 1kHz	> 300
DIM 30	< 0.01%
DIM 100	< 0.01%
Slew Rate internal	> 30 V / $\mu$ s
Power Consumption 1/8 rated output power 4 Ohm	660 VA
Dimensions (WxHxD)	483 x 88.1 x 426 mm 19 x 3.47 x 16.77 (in)
Weight	17 kg (37.4 lbs)
Optional Input Transformer	90176

# BLOCKDIAGRAM

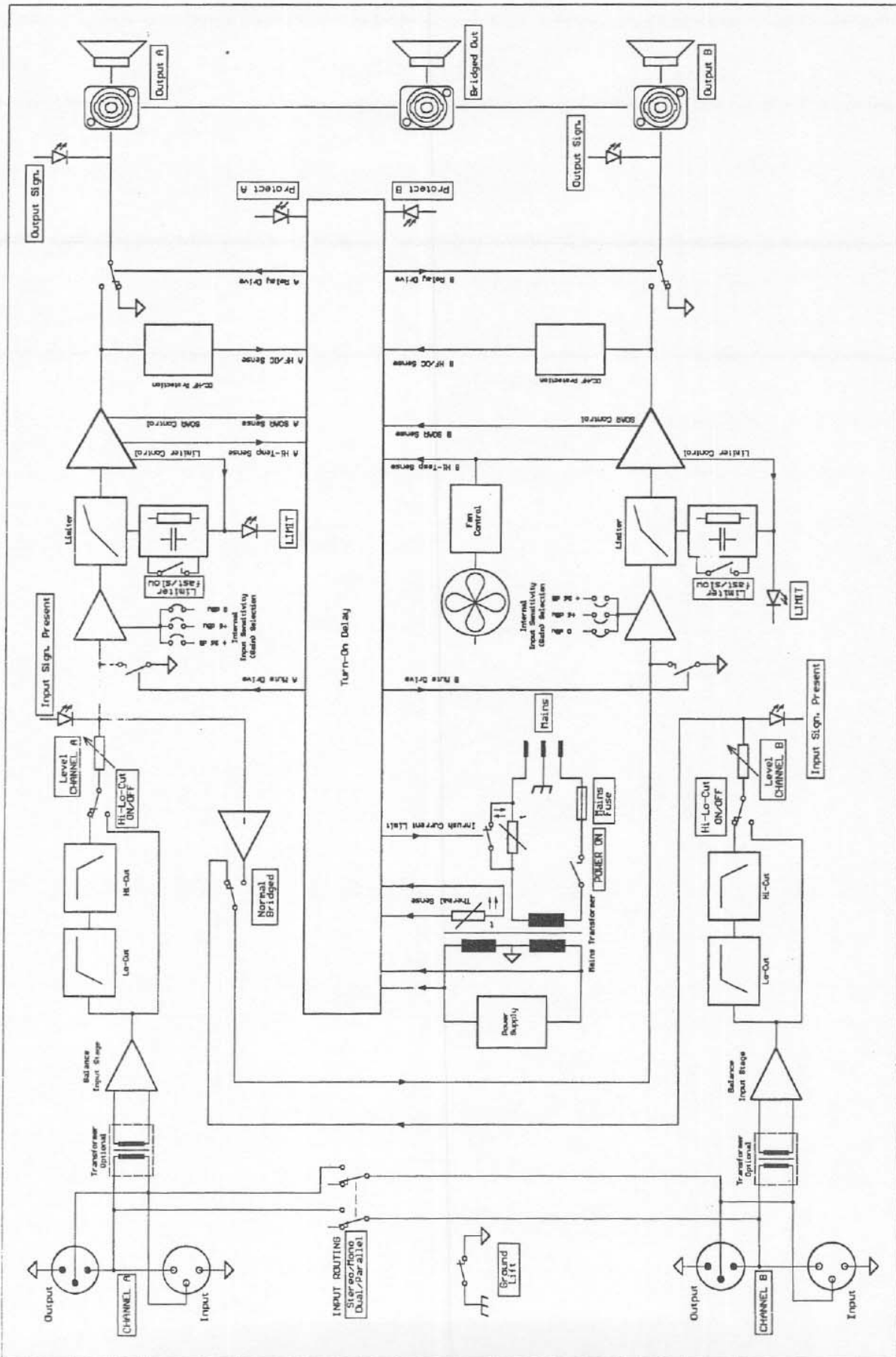

Dimensions in mm (inch)

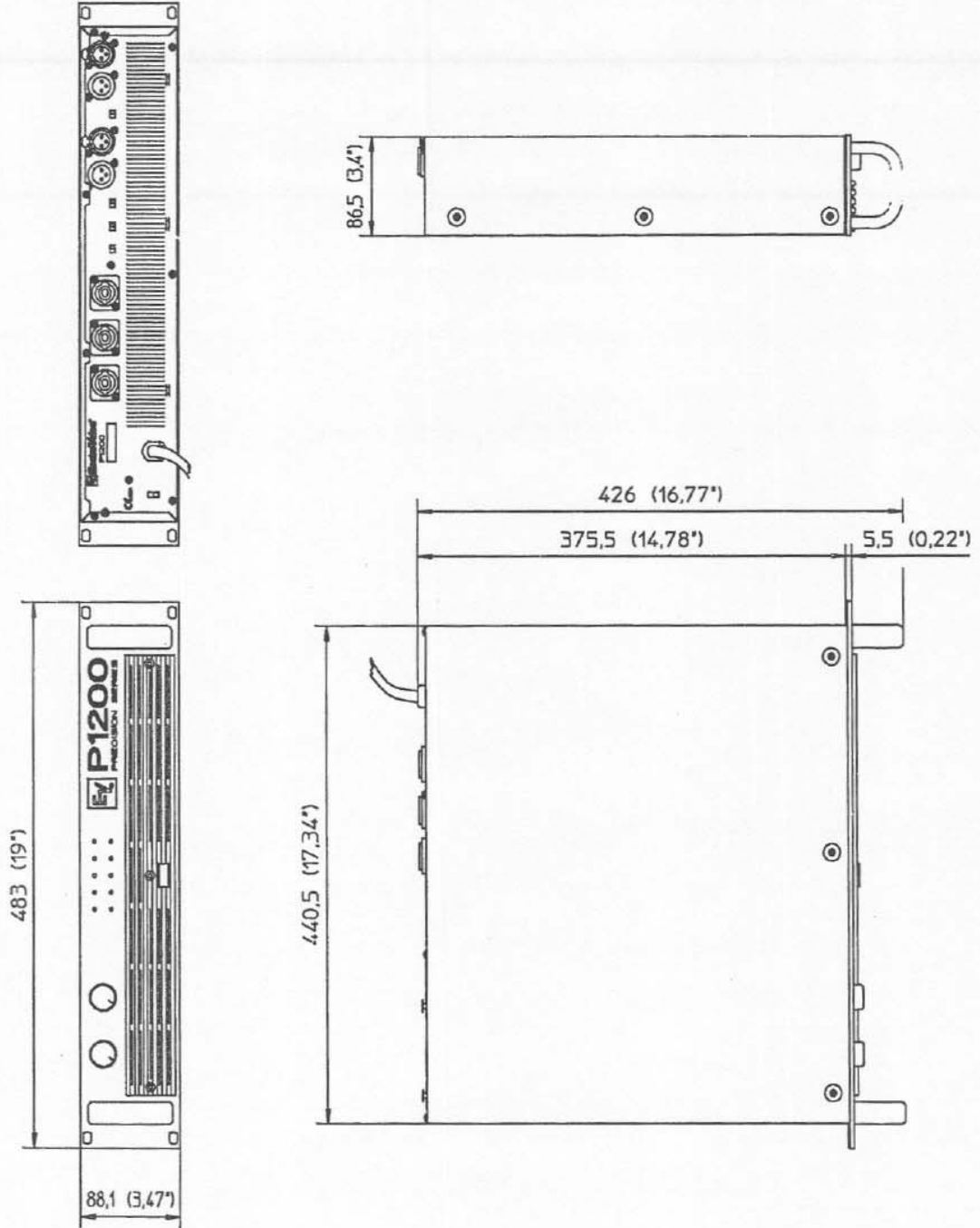



## SPECIFICATIONS: P 1200 complete unit

Standard specifications: IEC 268 part 3, IHF-A

0 dBu = 775 mV (RMS)

### A. POWER SUPPLY

1. Mains:	AC
2. Rated mains voltage:	120 V
3. Rated mains frequency:	50 - 60 Hz
4. Rated power consumption:	1900 watts
5. Normal power consumption:	600 watts
6. Tolerance of mains voltage:	+/-10%

### B. INPUT CHARACTERISTICS

Input sockets	Rated Input Level *1	Max. Input Level
CHANNEL A/B	0dBu (775mV)	+21dBu (9.0V)
CHANNEL A/B *2	+6dBu (1.55V)	+21dBu (9.0V)
CHANNEL A/B *3	+9dBu (2.24V)	+21dBu (9.0V)

\*1: All level controls fully opened

\*2: Internally jumpered to +6dBu

\*3: Internally jumpered to 26dB total gain

### C. OUTPUT CHARACTERISTICS

Output sockets	Rated Load Impedance	Output Power	
		Rated Value	Max. Power before clipping
SPEAKER (A, B)	4 ohms	500W	560W
	8 ohms	250W	380W
SPEAKER BRIDGED	8 ohms	1000W	1100W

### SINGLE CHANNEL OUTPUT POWER

(measured with "Dynamic Headroom" test signal according IHF-A: 1 kHz tone burst, 20 ms ON, 480 ms OFF, 4 ohms load)

SPEAKER (A or B)

800 W

### D. FREQUENCY RESPONSE

-3 dB loss against level at norm frequency

1. INPUT --> SPEAKER : 6 Hz - 65 kHz  
- HI-LO-CUT off
2. INPUT --> SPEAKER : 20 Hz - 40 kHz  
- HI-LO-CUT on

### E. PHASE RESPONSE

+/- 22.5 degrees (10 Hz - 30 kHz)

### F. INPUT IMPEDANCE

20 kohms

### G. AMPLITUDE NON-LINEARITIES

1. Rated Total Harmonic Distortion (1 kHz)	$k \leq 0.05 \%$
2. IMD - SMPTE - 60 Hz, 7 kHz	$k \leq 0.01 \%$
3. DIM 30	$k \leq 0.01 \%$
4. DIM 100	$k \leq 0.01 \%$

### H. CROSSTALK

- at  $f = 1$  kHz and rated power  $< -70$  dB

### I. DAMPING FACTOR

- internal at  $f = 1$  kHz  $> 300$

### J. SLEW RATE

- internal  $> 30$  V/ $\mu$ s

### K. NOISE

- $E_{(F)}$  = Noise voltage, unweighted with  $B = 20$  Hz ... 20 kHz, RMS (IEC 268-1)
- $E_{(G)}$  = Noise voltage, frequency weighting filter according CCIR, quasi peak-weighted (IEC 268-1)
- $E_{(A)}$  = Noise voltage, dB(A) frequency-weighted, RMS (IEC 268-1)
- S/N ratios ref. rated output voltage
- HI/LO-CUT ON

#### 1. Rated noise level (typ.)

	Noise-Voltage	S/N-Ratio	equiv. input noise voltage	equiv. input noise level
1.1 $E_{(F)}$	370 $\mu$ V	102 dB	6.5 $\mu$ V	- 102 dBu
1.2 $E_{(G)}$	1.1 mV	93 dBqp	17 $\mu$ V	- 93 dBu (G)
1.3 $E_{(A)}$	230 $\mu$ V	106 dBp	4.0 $\mu$ V	- 106 dBu (A)

#### 2. Residual output noise (All level controls fully counterclockwise)

- 2.1  $U_{(F)}$  = 270  $\mu$ V
- 2.2  $U_{(G)}$  = 800  $\mu$ V
- 2.3  $U_{(A)}$  = 180  $\mu$ V

### L. Dimensions

Height : 88.1mm (3.47 in)  
Width : 483 mm (19 in)  
Depth : 426 mm (16.77 in)

### M. Weight

17 kg (37.4 lbs)

## TEST DATA: P 1200 complete unit

General measuring conditions unless specified otherwise elsewhere:

* Measuring Tolerance:	$\Delta X = 1.5 \text{ dB}$
* Test Frequency:	$f = 1 \text{ kHz}$
* All Levels referred to:	$E = 775 \text{ mV (0dBu)}$
* Level controls fully to the right	
* Pinning of the XLR - socket:	PIN 1 = SHIELD, GROUND PIN 2 = + INPUT PIN 3 = - INPUT

\* Source impedance for feed-in via XLR socket:

$R(S) = 50 \text{ ohms}$

### 1. MAINS VOLTAGE:

$E(P) = 120V / 60Hz$

- can be plugged to 100V

### 2. POWER CONSUMPTION:

2.1. without load

$P(B) = 80 - 120 \text{ W}$

2.2 at nominal operation

$P(B) = 1950 \text{ W}$

### 3. ADJUSTMENTS:

#### 3.1. ADJUSTMENT OF IDLE CURRENT:

Connect a test resistor 4.7 ohms to the double jumpers J1 and J2 at pcb 84154 and measure the DC voltage over this resistor and adjust it (without load).

Adjust with VR2 or VR302

$U_- = 5.0 \text{ mV}$

at room temperature

Room temperature: the unit must be left to cool down for several hours, after it has been in operation.

#### 3.2. PROCESSOR (VCA) - OFFSET:

Open and close service switches S001 and S301 at the power amplifier pcb 84154 periodically and adjust with VR001 or VR301 to a minimum offset (with oscilloscope to minimum peak or by ear to minimum noise volume) at the amplifier output.

#### 3.3 Adjustment of indications

- Level control fully clockwise

-  $f = 1 \text{ kHz}$

Feed in a signal  $E(I)$  via Input A or B, until the IN LED lights up. Adjust the corresponding OUT LED to the same brightness via trimmer VR3 or VR4 on pcb 81303.

#### 4. FUNCTION TESTS:

##### 4.1 Output Offset Voltage

DC measurement at the loudspeaker outputs CHANNEL A/B

$$U_{-} \leq \pm 10 \text{ mV}$$

##### 4.2 LIMITER TEST:

###### 4.2.1 Clip Test

Drive both channels until  $E(O) = 44.7 \text{ V}$  (without load);

increase input voltage by 10 dB - LIMITER LED will light up, the output voltage will only rise by approx. 3 dB to 65 V and is slightly clipped.

###### 4.2.2 FAST/SLOW Test

Test both power amplifier channels separately:

- drive the power amplifier with a burst signal ( $f = 1 \text{ kHz}$ , 1 - 10 cycles, rate = 1 sec.),  $E(I) = 10 \text{ dB}$  higher than nominal input voltage
- monitor the output signal with an oscilloscope and switch over the FAST/SLOW switch
- SLOW: after 2 - 3 signal periods the limiter responds to the strong distortion and regulates it to a small residual distortion
- FAST: after 1-2 signal periods the limiter has already regulated the strong distortion to a small residual distortion

Position SLOW is the factory preset!

##### 4.3 POWER-ON DELAY

After approx 2 sec. the relays E001 (current limiter, pcb 85246), E001 and E301 (AF Output, pcb 84154) will pick up together.

##### 4.4. FAN CONTROL:

The fan does not run when the power amplifier is cold!

The fan can be tested with the service switch S1 on pcb 85246 by closing it briefly.

##### 4.5. SOAR PROTECTION CIRCUIT TEST:

Drive both channels separately to 44.7 V into 4 ohms . Connect a 0.1 ohm resistor parallel; protection circuit responds and always tries to switch on again!

The Protect LED flashes at the same rhythm.

##### 4.6 SHORT CIRCUIT - CURRENT LIMITER TEST:

Test the two channels individually:

- drive the power amplifier to maximum output ( $E(O) = 65 \text{ V}$ ) with a burst signal ( $f = 1 \text{ kHz}$ , 1 - 10 cycles, rate: = 1 sec.), without load
- terminate with load resistor 1 ohm:
- the short circuit current limiter limits the output voltage over the load resistor symmetrically (monitor with oscilloscope!) to a peak value of approx. 30 V (approx. 30 amps).

#### 4.7 DC VOLTAGE PROTECTION CIRCUIT TEST

Test the two channels individually:

- drive the power amplifier with a test signal ( $f = 10 \text{ Hz}$ ) (without load resistor)
- the protection circuit responds at a loudspeaker output voltage of  $E(O) \approx 63 \text{ V}$  and always tries to switch on again!

The Protect LED flashes at the same rhythm.

#### 4.8 RF PROTECTION CIRCUIT TEST

Only for power amplifier pcb test!

### 5. LEVELS CHANNEL A and B

- \* Level control fully clockwise
- \* INPUT ROUTING switch into position DUAL/STEREO
- \* HI-LO-CUT switch: ON (factory preset)
- \* BRIDGED MODE: NORMAL
- \* LIMITER: SLOW (factory preset)

#### 5.1 Nominal Levels

Input	E(I)	Test point	E(O)	Comment
CH. A/B	775 mV	SPEAKER A/B	44.7 V	
CH. A/B	1.55 V	SPEAKER A/B	44.7 V	J2/5 jumpered internally
CH. A/B	2.24 V	SPEAKER A/B	44.7 V	J3/6 jumpered internally

#### 5.2 Max. Input Levels

Input	E(I)	Test point	E(O)	Comment
CH. A/B	9.0 V	SPEAKER A/B		
CH. A/B	9.0 V	SPEAKER A/B		J2/5 jumpered internally
CH. A/B	9.0 V	SPEAKER A/B		J3/6 jumpered internally

### 6. INPUT ROUTING Switch

DUAL/STEREO (factory preset!)

- Channels A and B must be driven separately

PARALLEL/MONO

- Channels A and B are switched in parallel at the input; both channels can be driven by one signal source.

### 7. BRIDGED MODE Switch

NORMAL (factory preset!)

BRIDGED: The double output voltage is available at the BRIDGED OUT socket  
The CHANNEL A input socket must be used; the CHANNEL B input socket has no function

## 8. GROUND LIFT Switch

GROUNDING : factory preset

Check the correct function of the switch with an ohm-meter:

- Circuit ground (at the input or output socket) is connected or disconnected with chassis ground (contact at the earth-terminal screw at the rear or protective-conductor of the mains cable)

## 9. Harmonic Distortion

9.1 Rated Total Harmonic Distortion (1 kHz; 8 ohms load)

$k \leq 0.005 \%$

9.2 Norm Total Harmonic Distortion (1 kHz; -10dB; 8 ohms load )

$k \leq 0.009 \%$

## 10. Frequency responses

- Feed in E(I) via input
- E(O) at SPEAKER A/B
- Curve 1: HI-LO-CUT ON
- Curve 2: HI-LO-CUT OFF

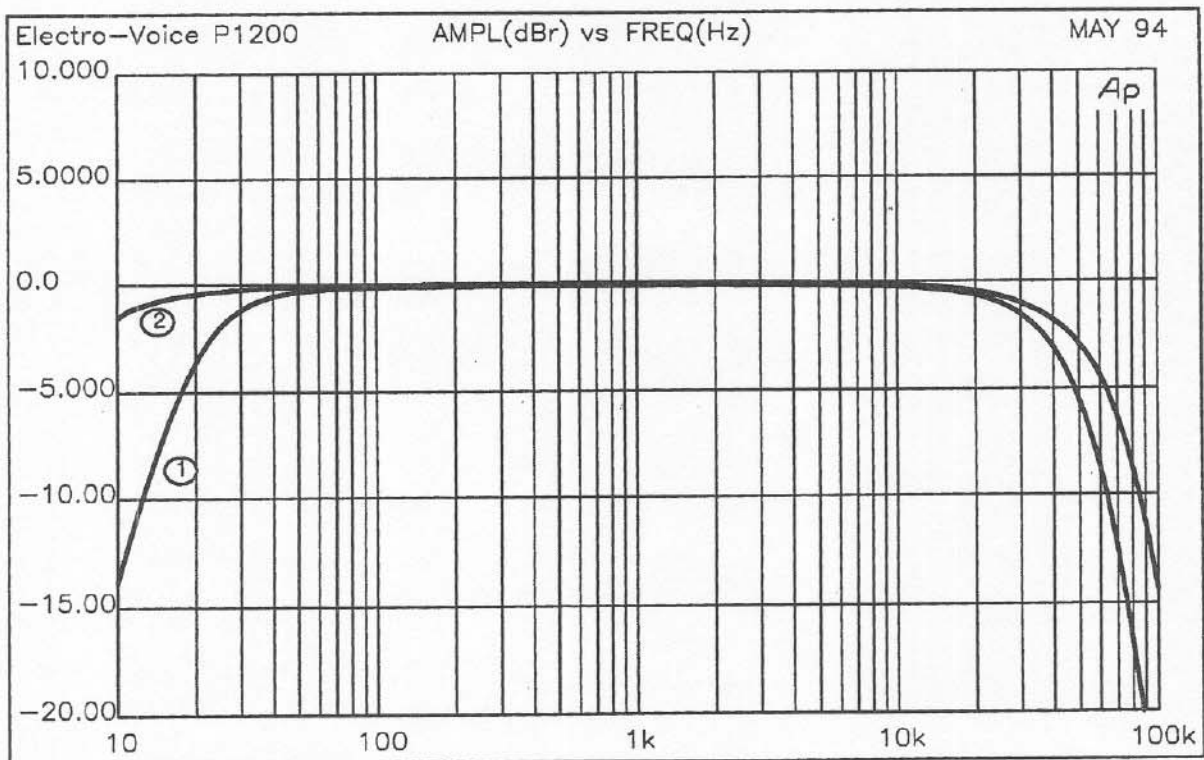

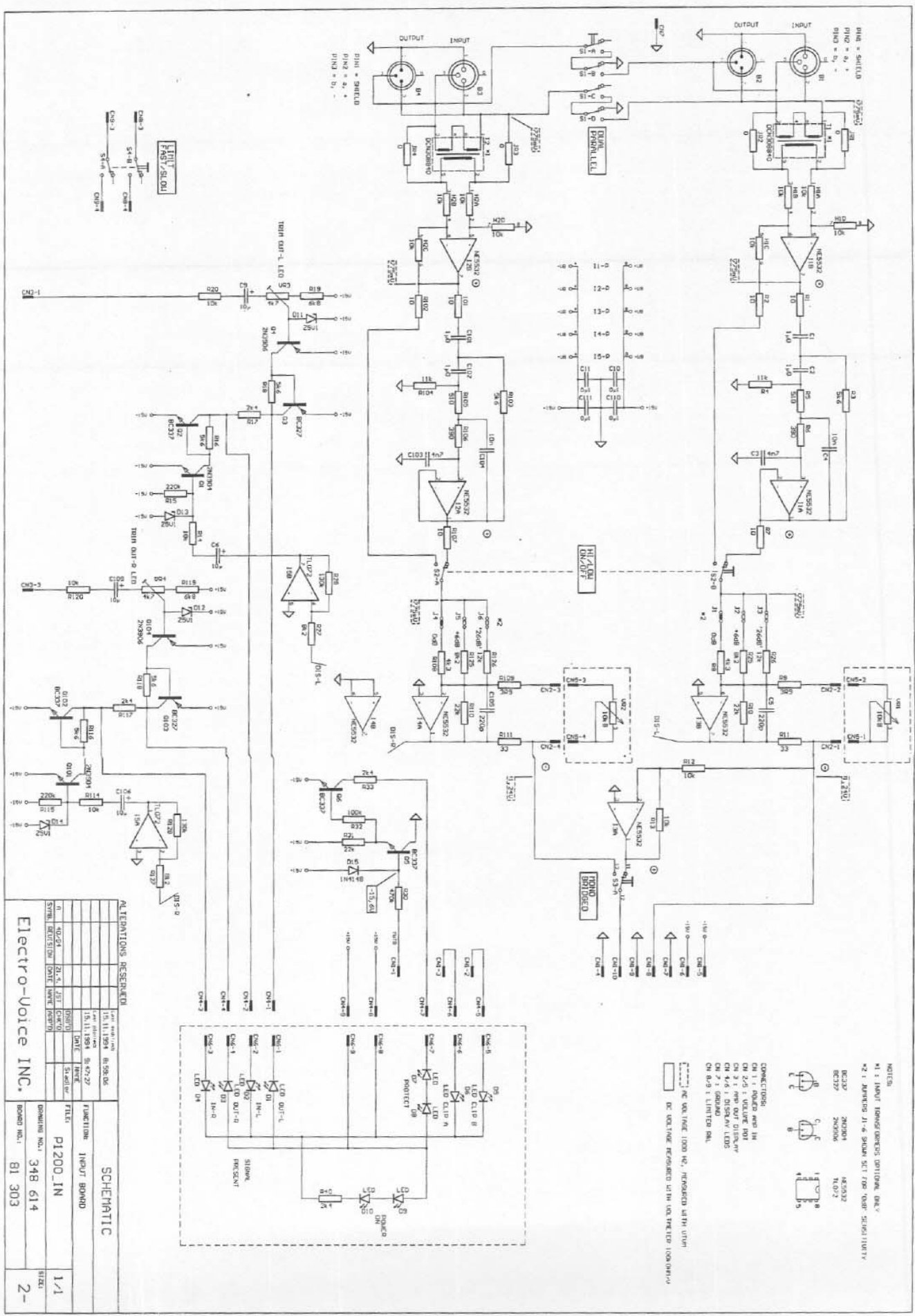

ATTENTIONS RESERVED

REV	DATE	BY	REASON
0	10/24	21.6. JET	CHG-0
1	13/11	DAE	REVISION
2	13/11	DAE	REVISION

SCHEMATIC

FUNCTION	INPUT BOARD
FILE	P1200_IN
DRAWING NO.	348 614
BOARD NO.	B1 303

Electro-Voice INC.

- NOTES
- #1: INPUT INDICATORS OPTIONAL ONLY
  - #2: PARTS LIST & SHOWN SET FOR PART SPECIFICATION
- COMPONENTS:
- OP 1: ANALOG AMP II
  - OP 2-5: VOLUME POT
  - OP 3: 100K BRIDGE
  - OP 4: 100K BRIDGE
  - OP 5: 100K BRIDGE
- DC VOLTAGE RESERVED WITH VOL. CONTROL





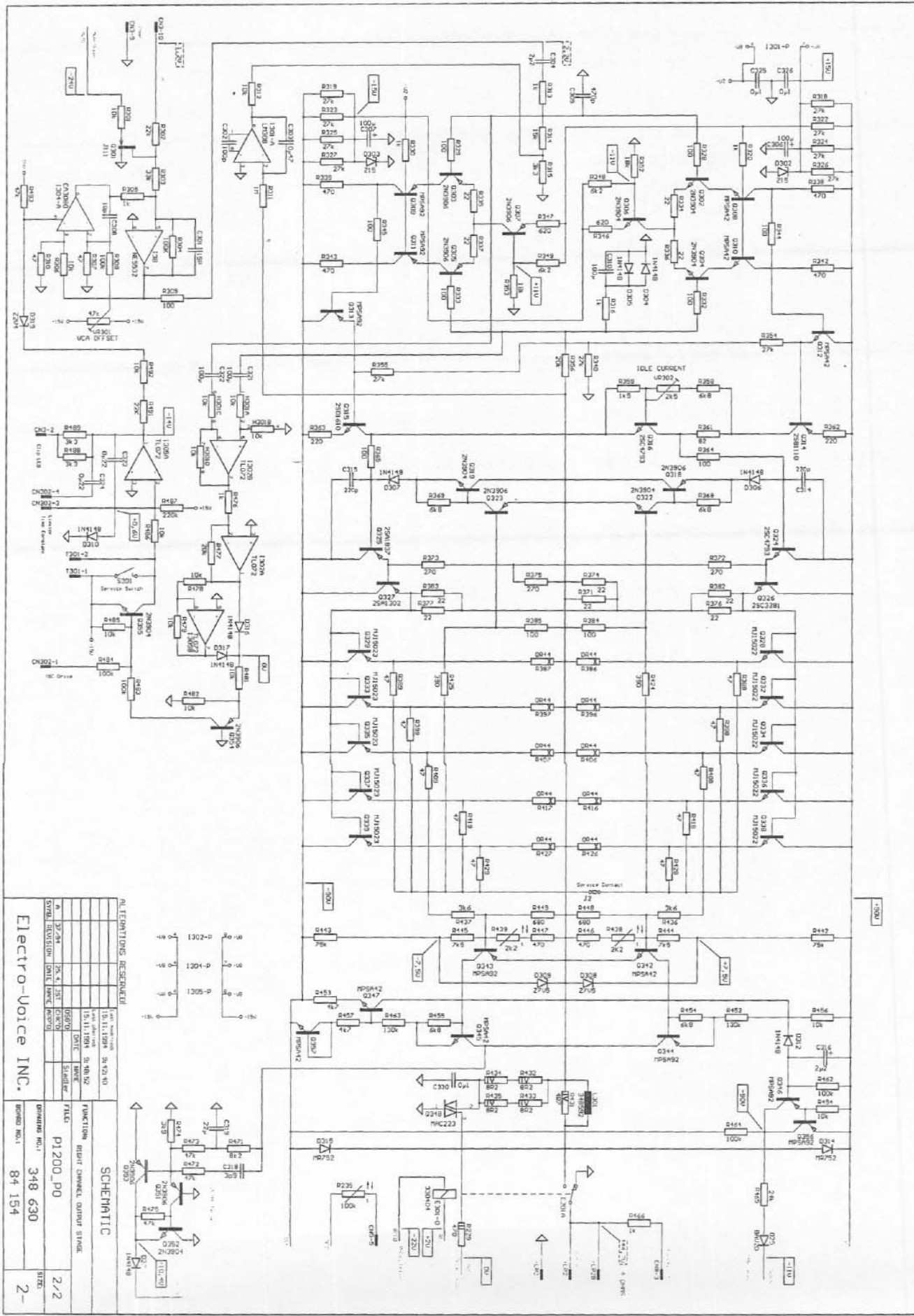

ALTERNATIONS DESCRIBED		SCHEMATIC	
1	15.11.1398	38 V2340	
2	15.11.1398	38 V2340	
3	15.11.1398	38 V2340	
4	15.11.1398	38 V2340	
5	15.11.1398	38 V2340	
6	15.11.1398	38 V2340	
7	15.11.1398	38 V2340	
8	15.11.1398	38 V2340	
9	15.11.1398	38 V2340	
10	15.11.1398	38 V2340	
11	15.11.1398	38 V2340	
12	15.11.1398	38 V2340	
13	15.11.1398	38 V2340	
14	15.11.1398	38 V2340	
15	15.11.1398	38 V2340	
16	15.11.1398	38 V2340	
17	15.11.1398	38 V2340	
18	15.11.1398	38 V2340	
19	15.11.1398	38 V2340	
20	15.11.1398	38 V2340	
21	15.11.1398	38 V2340	
22	15.11.1398	38 V2340	
23	15.11.1398	38 V2340	
24	15.11.1398	38 V2340	
25	15.11.1398	38 V2340	
26	15.11.1398	38 V2340	
27	15.11.1398	38 V2340	
28	15.11.1398	38 V2340	
29	15.11.1398	38 V2340	
30	15.11.1398	38 V2340	
31	15.11.1398	38 V2340	
32	15.11.1398	38 V2340	
33	15.11.1398	38 V2340	
34	15.11.1398	38 V2340	
35	15.11.1398	38 V2340	
36	15.11.1398	38 V2340	
37	15.11.1398	38 V2340	
38	15.11.1398	38 V2340	
39	15.11.1398	38 V2340	
40	15.11.1398	38 V2340	
41	15.11.1398	38 V2340	
42	15.11.1398	38 V2340	
43	15.11.1398	38 V2340	
44	15.11.1398	38 V2340	
45	15.11.1398	38 V2340	
46	15.11.1398	38 V2340	
47	15.11.1398	38 V2340	
48	15.11.1398	38 V2340	
49	15.11.1398	38 V2340	
50	15.11.1398	38 V2340	
51	15.11.1398	38 V2340	
52	15.11.1398	38 V2340	
53	15.11.1398	38 V2340	
54	15.11.1398	38 V2340	
55	15.11.1398	38 V2340	
56	15.11.1398	38 V2340	
57	15.11.1398	38 V2340	
58	15.11.1398	38 V2340	
59	15.11.1398	38 V2340	
60	15.11.1398	38 V2340	
61	15.11.1398	38 V2340	
62	15.11.1398	38 V2340	
63	15.11.1398	38 V2340	
64	15.11.1398	38 V2340	
65	15.11.1398	38 V2340	
66	15.11.1398	38 V2340	
67	15.11.1398	38 V2340	
68	15.11.1398	38 V2340	
69	15.11.1398	38 V2340	
70	15.11.1398	38 V2340	
71	15.11.1398	38 V2340	
72	15.11.1398	38 V2340	
73	15.11.1398	38 V2340	
74	15.11.1398	38 V2340	
75	15.11.1398	38 V2340	
76	15.11.1398	38 V2340	
77	15.11.1398	38 V2340	
78	15.11.1398	38 V2340	
79	15.11.1398	38 V2340	
80	15.11.1398	38 V2340	
81	15.11.1398	38 V2340	
82	15.11.1398	38 V2340	
83	15.11.1398	38 V2340	
84	15.11.1398	38 V2340	
85	15.11.1398	38 V2340	
86	15.11.1398	38 V2340	
87	15.11.1398	38 V2340	
88	15.11.1398	38 V2340	
89	15.11.1398	38 V2340	
90	15.11.1398	38 V2340	
91	15.11.1398	38 V2340	
92	15.11.1398	38 V2340	
93	15.11.1398	38 V2340	
94	15.11.1398	38 V2340	
95	15.11.1398	38 V2340	
96	15.11.1398	38 V2340	
97	15.11.1398	38 V2340	
98	15.11.1398	38 V2340	
99	15.11.1398	38 V2340	
100	15.11.1398	38 V2340	

Electro-Voice INC.

BOARD NO. 84 154

348 630

2-2

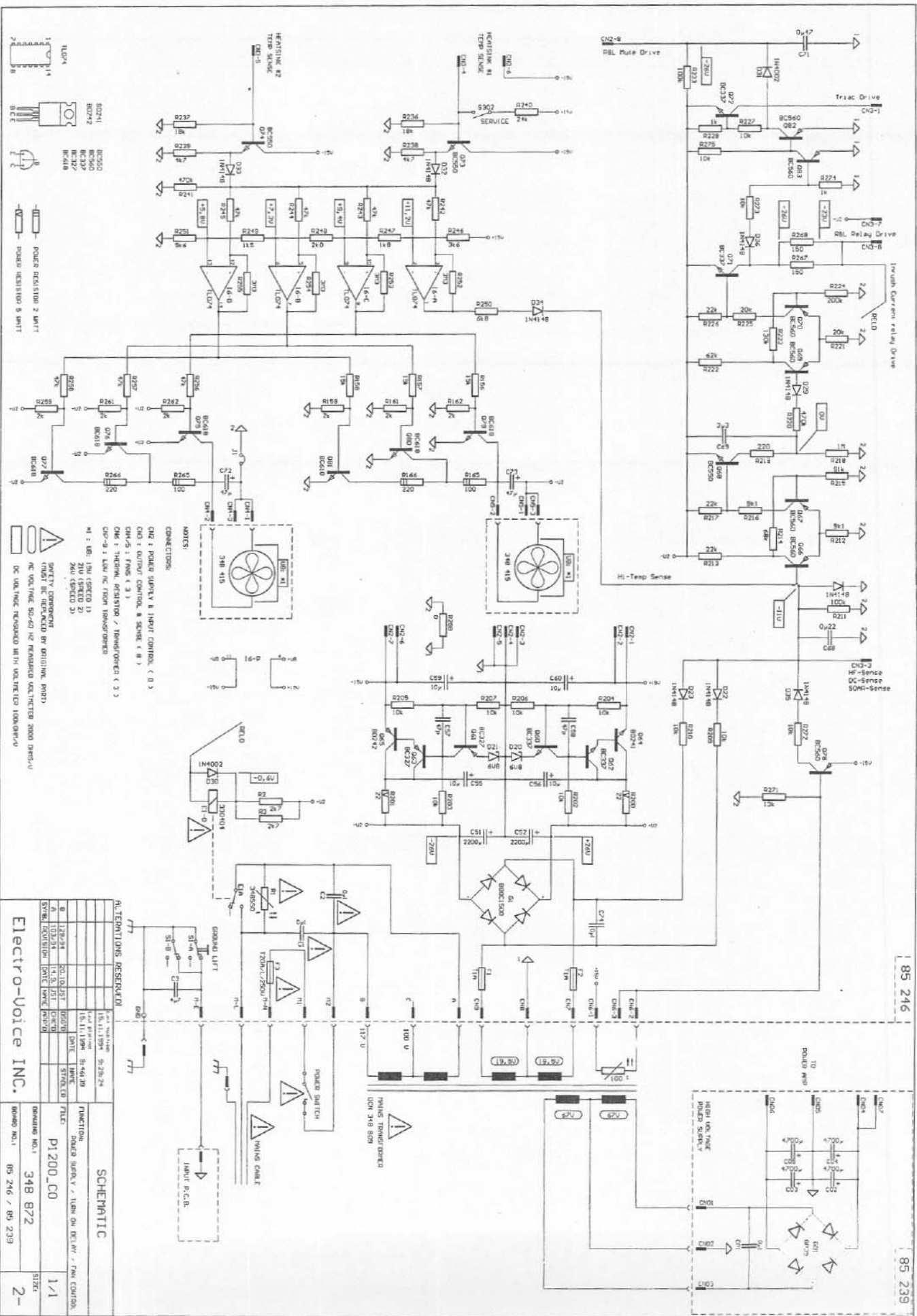

- IC1: 7805V
- IC2: 7805V
- IC3: PIC16C505
- Q1: 2N2222
- Q2: 2N2222
- Q3: 2N2222
- Q4: 2N2222
- REL1: RELAY
- T1: TRANSFORMER
- TACH: TACHOMETER
- PEYE: PHOTO EYE
- THERM: THERMISTOR
- BR1: BRIDGE RECTIFIER
- C1: 1000µF CAPACITOR
- C2: 1000µF CAPACITOR
- C3: 100µF CAPACITOR

NOTES:

CONNECTIONS:

Q1: POWER SUPPLY & INPUT CONTROL ( 0 3 )

Q2: OUTPUT CONTROL & SENSE ( 8 1 )

Q3: 1 ( 1 3 )

Q4: 1 ( 1 3 )

REL: THERM. RESISTOR / TACHOMETER ( 3 3 )

TACH: 1 ( 1 3 )

PEYE: 1 ( 1 3 )

THERM: 1 ( 1 3 )

BR: 1 ( 1 3 )

C1: 1 ( 1 3 )

C2: 1 ( 1 3 )

C3: 1 ( 1 3 )

CAUTION: HIGH VOLTAGE

DO NOT TOUCH

DC VOLTAGE MEASURED WITH VOLTMETER 1000Ω/V

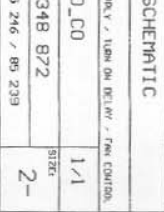
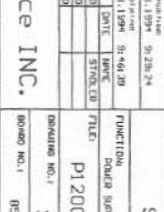
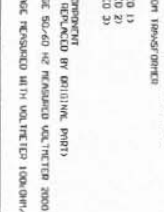
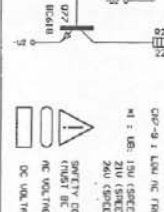

REVISIONS		DATE		BY		CHECKED	
1	10/11/1994	SI-461/20	SI-461/20	SI-461/20	SI-461/20	SI-461/20	SI-461/20
2	10/11/1994	SI-461/20	SI-461/20	SI-461/20	SI-461/20	SI-461/20	SI-461/20
3	10/11/1994	SI-461/20	SI-461/20	SI-461/20	SI-461/20	SI-461/20	SI-461/20
4	10/11/1994	SI-461/20	SI-461/20	SI-461/20	SI-461/20	SI-461/20	SI-461/20
5	10/11/1994	SI-461/20	SI-461/20	SI-461/20	SI-461/20	SI-461/20	SI-461/20

Electro-Voice INC.

PI2000.CO

348 872

85 246 / 85 239

Pos. in diagram	description	Part-No.	Pos. in diagram	description	Part-No.
B0010	speaker socket 4pol.	341343	VR004	trimpot 4.70 kohm lin	348487
S0010	power switch	346720	00030	shorting plug	306397
Z0080	rubber foot	335589			
00030	power button black	341382	00010	PCB	841548
00210	handle 65 mm	351213	C0016	KO-EL 2.2MF 50V	304986
00510	fan	348415	C0030	safety component	341714
00010	front panel	349823	C0316	KO-EL 2.2MF 50V	304986
			C0330	safety component	341714
00005	PCB	813038	D0002	diode zener BZX 55C 15V	309450
B0001	socket XLR 3pol.	346791	D0003	diode zener BZX 55C 15V	309450
B0002	connector XLR 3pol.	346792	D0004	diode 1N 4148	301254
B0003	socket XLR 3pol.	346791	D0005	diode 1N 4148	301254
B0004	connector XLR 3pol.	346792	D0006	diode 1N 4148	301254
CN005	connector 5pol	337593	D0007	diode 1N 4148	301254
D0001	LED green 3mm	336398	D0008	break down diode ZPD 7V5	307916
D0002	LED green 3mm	336398	D0009	break down diode ZPD 7V5	307916
D0003	LED green 3mm	336398	D0010	diode 1N 4148	301254
D0004	LED green 3mm	336398	D0011	diode 1N 4002	304360
D0005	LED red 3mm	336399	D0012	diode 1N 4148	301254
D0006	LED red 3mm	336399	D0014	diode MR 752	328769
D0007	LED red 3mm	336399	D0015	diode MR 752	328769
D0008	LED red 3mm	336399	D0016	diode 1N 4148	301254
D0009	LED green 3mm	336398	D0017	diode 1N 4148	301254
D0010	LED green 3mm	336398	D0019	diode zener BZX 55C 2V4	329511
D0011	diode zener ZPD 5V1	328788	D0024	diode BAV 20	348573
D0012	diode zener ZPD 5V1	328788	D0025	diode BAV 20	348573
D0013	diode zener ZPD 5V1	328788	D0026	diode 1N 4148	301254
D0014	diode zener ZPD 5V1	328788	D0027	diode 1N 4148	301254
D0015	diode 1N 4148	301254	D0302	diode zener BZX 55C 15V	309450
H0001	res.network RKL 8A 103J	343457	D0303	diode zener BZX 55C 15V	309450
H0002	res.network RKL 8A 103J	343457	D0304	diode 1N 4148	301254
I0001	IC NE 5532 N	327197	D0305	diode 1N 4148	301254
I0002	IC NE 5532 N	327197	D0306	diode 1N 4148	301254
I0003	IC NE 5532 N	327197	D0307	diode 1N 4148	301254
I0004	IC NE 5532 N	327197	D0308	break down diode ZPD 7V5	307916
J0005	IC TL 072 CP	331340	D0309	break down diode ZPD 7V5	307916
Q0001	trans 2N 3904	335763	D0310	diode 1N 4148	301254
Q0002	trans. BC 337-25	307150	D0312	diode 1N 4148	301254
Q0003	trans. BC 327-25	307430	D0314	diode MR 752	328769
Q0004	trans. 2N 3906	348421	D0315	diode MR 752	328769
Q0005	trans. BC 337-25	307150	D0316	diode 1N 4148	301254
Q0006	trans. BC 337-25	307150	D0317	diode 1N 4148	301254
Q0101	trans 2N 3904	335763	D0319	diode zener BZX 55C 2V4	329511
Q0102	trans. BC 337-25	307150	E0001	relay RP 310 024	330404
Q0103	trans. BC 327-25	307430	E0301	relay RP 310 024	330404
Q0104	trans. 2N 3906	348421	H0001	res.network RKL 8A 103J	343457
S0001	rotary switch	348572	H0301	res.network RKL 8A 103J	343457
S0002	rotary switch	348583	I0001	IC LM 308 A	338359
S0003	rotary switch	348583	I0002	IC TL 072 CP	331340
S0004	rotary switch	348583	I0003	IC NE 5532 N	327197
VR001	potentiometer 10kohm lin	348430	I0004	IC CA 3080 E	307421
VR002	potentiometer 10kohm lin	348430	I0005	IC TL 072 CP	331340
VR003	trimpot 4.70 kohm lin	348487	I0301	IC LM 308 A	338359

## SERVICE - LIST OF SPARE PARTS

Pos. in diagram	description	Part-No.	Pos. in diagram	description	Part-No.
I0302	IC TL 072 CP	331340	Q0301	trans. J 111 A	330264
I0304	IC CA 3080 E	307421	Q0302	trans 2N 3904	335763
I0305	IC TL 072 CP	331340	Q0303	trans. 2N 3906	348421
L0001	coil	348592	Q0304	trans 2N 3904	335763
L0301	coil	348592	Q0305	trans. 2N 3906	348421
Q0001	trans. J 111 A	330264	Q0306	trans 2N 3904	335763
Q0002	trans 2N 3904	335763	Q0307	trans. 2N 3906	348421
Q0003	trans. 2N 3906	348421	Q0308	trans. MPSA 42	348422
Q0004	trans 2N 3904	335763	Q0309	trans. MPSA 92	348423
Q0005	trans. 2N 3906	348421	Q0310	trans. MPSA 42	348422
Q0006	trans 2N 3904	335763	Q0311	trans. MPSA 92	348423
Q0007	trans. 2N 3906	348421	Q0312	trans. MPSA 42	348422
Q0008	trans. MPSA 42	348422	Q0313	trans. MPSA 92	348423
Q0009	trans. MPSA 92	348423	00010	trans. 2SB 1110	348410
Q0010	trans. MPSA 42	348422	00010	trans. 2SD 1610	348411
Q0011	trans. MPSA 92	348423	Q0316	trans. 2SC 4793	348409
Q0012	trans. MPSA 42	348422	Q0318	trans. 2N 3906	348421
Q0013	trans. MPSA 92	348423	Q0319	trans 2N 3904	335763
00010	trans. 2SB 1110	348410	Q0322	trans 2N 3904	335763
00010	trans. 2SD 1610	348411	Q0323	trans. 2N 3906	348421
Q0016	trans. 2SC 4793	348409	Q0324	trans. 2SC 4793	348409
Q0018	trans. 2N 3906	348421	Q0325	trans. 2SA 1837	348408
Q0019	trans 2N 3904	335763	Q0326	trans. 2SC 3281	348305
Q0022	trans 2N 3904	335763	Q0327	trans. 2SA 1302	348424
Q0023	trans. 2N 3906	348421	Q0328	trans. MJ 15022	331657
Q0024	trans. 2SC 4793	348409	Q0329	trans. MJ 15023	331658
Q0025	trans. 2SA 1837	348408	Q0332	trans. MJ 15022	331657
Q0026	trans. 2SC 3281	348305	Q0333	trans. MJ 15023	331658
Q0027	trans. 2SA 1302	348424	Q0334	trans. MJ 15022	331657
Q0028	trans. MJ 15022	331657	Q0335	trans. MJ 15023	331658
Q0029	trans. MJ 15023	331658	Q0336	trans. MJ 15022	331657
Q0032	trans. MJ 15022	331657	Q0337	trans. MJ 15023	331658
Q0033	trans. MJ 15023	331658	Q0338	trans. MJ 15022	331657
Q0034	trans. MJ 15022	331657	Q0339	trans. MJ 15023	331658
Q0035	trans. MJ 15023	331658	Q0342	trans. MPSA 42	348422
Q0036	trans. MJ 15022	331657	Q0343	trans. MPSA 92	348423
Q0037	trans. MJ 15023	331658	Q0344	trans. MPSA 92	348423
Q0038	trans. MJ 15022	331657	Q0345	trans. MPSA 42	348422
Q0039	trans. MJ 15023	331658	Q0346	trans. MPSA 92	348423
Q0042	trans. MPSA 42	348422	Q0347	trans. BF 391	307911
Q0043	trans. MPSA 92	348423	Q0348	triac MAC 223-6	338876
Q0044	trans. MPSA 92	348423	Q0351	trans. 2N 3906	348421
Q0045	trans. MPSA 42	348422	Q0352	trans 2N 3904	335763
Q0046	trans. MPSA 92	348423	Q0353	trans. 2N 3906	348421
Q0047	trans. BF 391	307911	Q0354	trans. 2N 3906	348421
Q0048	triac MAC 223-6	338876	Q0355	trans 2N 3904	335763
Q0051	trans. 2N 3906	348421	Q0356	trans. MPSA 92	348423
Q0052	trans 2N 3904	335763	Q0357	trans. BF 391	307911
Q0053	trans. 2N 3906	348421	R0131	resistor 4.70 ohm 4 watt	341713
Q0054	trans. 2N 3906	348421	R0138	safety component NTC	348593
Q0055	trans 2N 3904	335763	R0139	safety component NTC	348593
Q0056	trans. MPSA 92	348423	00005	safety component NTC	348490
Q0057	trans. BF 391	307911	00005	safety component NTC	348490

Pos. in diagram	description	Part-No.	Pos. in diagram	description	Part-No.
R0431	resistor 4.70 ohm 4 watt	341713	Q0072	trans. BC 337-25	307150
R0438	safety component NTC	348593	Q0073	trans. BC 550 B	301184
R0439	safety component NTC	348593	Q0074	trans. BC 550 B	301184
VR001	trimpot. 47 kohm lin	348486	Q0075	trans. BC 618	348591
VR002	trimpot. 2.50 kohm lin	348675	Q0076	trans. BC 618	348591
VR301	trimpot. 47 kohm lin	348486	Q0077	trans. BC 618	348591
VR302	trimpot. 2.50 kohm lin	348675	Q0078	trans. BC 560 B	306928
			Q0079	trans. BC 618	348591
00015	PCB	852398	Q0080	trans. BC 618	348591
C0001	safety component	341714	Q0081	trans. BC 618	348591
C0002	KO-EL 4700.000MF 100V	340437	Q0082	trans. BC 560 B	306928
C0003	KO-EL 4700.000MF 100V	340437	Q0083	trans. BC 560 B	306928
C0004	KO-EL 4700 000MF 100V	340437	R0200	wire-wound resistor 22 ohm	301726
C0005	KO-EL 4700.000MF 100V	340437	R0201	wire-wound resistor 22 ohm	301726
G0001	rectifier KBPC 3504 W	348526	S0001	sliding switch	338886
			S0302	control element on/off	327947
00020	PCB	852468	00025	mains transformer	348809
C0001	safety component	341714			
C0002	safety component	341714			
C0051	capacitor 2200uF 35V	335935			
C0052	capacitor 2200uF 35V	335935			
C0072	KO-EL 47MF 50V	343530			
C0073	KO-EL 47MF 50V	343530			
D0020	break down diode ZPD 6V8	304992			
D0021	break down diode ZPD 6V8	304992			
D0022	diode 1N 4148	301254			
D0023	diode 1N 4148	301254			
D0028	diode 1N 4148	301254			
D0029	diode 1N 4148	301254			
D0030	diode 1N 4002	304360			
D0031	diode 1N 4002	304360			
D0032	diode 1N 4148	301254			
D0033	diode 1N 4148	301254			
D0034	diode 1N 4148	301254			
D0035	diode 1N 4148	301254			
D0036	diode 1N 4148	301254			
F0001	relay RF 310 024	330404			
F0001	fuse holder	306838			
F0002	fuse holder	306838			
G0001	rectifier B40 C1500	331965			
I0006	IC TL 074 CN	332985			
Q0060	trans. BC 337-25	307150			
Q0061	trans. BC 327-25	307430			
Q0062	trans. BC 337-25	307150			
Q0063	trans. BC 327-25	307430			
Q0064	trans. BD 241B	301236			
Q0065	trans. BD 242B	301235			
Q0066	trans. BC 560 B	306928			
Q0067	trans. BC 560 B	306928			
Q0068	trans. BC 550 B	301184			
Q0069	trans. BC 560 B	306928			
Q0070	trans. BC 560 B	306928			
Q0071	trans. BC 337-25	307150			

## # SERVICE INFORMATION

**WARNING:** No user serviceable parts inside. Extremely hazardous voltages and currents may be encountered within the chassis. The servicing information contained within this document is only for use by Electro-Voice Authorized warranty repair stations and qualified service personnel. To avoid electric shock DO NOT perform any servicing other than that contained in the Operating instructions unless you are qualified to do so. Otherwise, refer all servicing to qualified service personnel.

**NOTICE:** Modification to Electro-Voice products is not recommended. Such modifications shall be at the sole expense of the person(s) or company responsible, and any damage resulting therefrom shall not be covered under warranty or otherwise.

### #.1 ORDERING REPLACEMENT PARTS

TO ORDER REPLACEMENT PARTS, LOOK UP THE ORDERING NUMBER FROM THE COMPONENT PARTS LISTING AND CALL E. S. T. (616) 695-6831, FAX (800) 685-6386, OR WRITE:

ELECTRO-VOICE SERVICE  
600 CECIL STREET  
BUCHANAN, MICHIGAN 49107  
U. S. A.

### #.2 ELECTRO-VOICE UNIFORM LIMITED WARRANTY STATEMENT

Electro-Voice products are guaranteed against malfunction due to defects in materials or workmanship for a specified period, as noted in the individual product-line statement(s) below, or in the individual product data sheet or owner's manual, beginning with the date of original purchase. If such malfunction occurs during the specified period, the product will be repaired or replaced (at our option) without charge. The product will be returned to the customer prepaid. **Exclusions and Limitations:** The Limited Warranty does not apply to: (a) exterior finish or appearance; (b) certain specific items described in the individual product-line statement(s) below, or in the individual product data sheet or owner's manual; (c) malfunction resulting from use or operation of the product other than as specified in the product data sheet or owner's manual; (d) malfunction resulting from misuse or abuse of the product; or (e) malfunction occurring at any time after repairs have been made to the product by anyone other than Electro-Voice or any of its authorized service representatives. **Obtaining Warranty Service:** To obtain warranty service, a customer must deliver the product, prepaid, to Electro-Voice or any of its authorized service representatives together with proof of purchase of the product in the form of a bill of sale or receipted invoice. A list of authorized service representatives is available from Electro-Voice at 600 Cecil Street, Buchanan, MI 49107 (616/695-6831 or 800/685-2606). **Incidental and Consequential Damages Excluded:** product repair or replacement and return to the customer are only remedies provided to the customer. Electro-Voice shall not be liable for any incidental or consequential damages including, without limitation, injury to persons or property or loss of use. Some states do not allow the exclusion or limitation of incidental or consequential damages so the above limitation or exclusion may not apply to you. **Other Rights:** This warranty gives you specific legal rights, and you may also have other rights which vary from state to state.

**Electro-Voice Electronics** are guaranteed against malfunction due to defects in materials or workmanship for a period of three (3) years from the date of original purchase. Additional details are included in the Uniform Limited Warranty statement.

### #. 3 Technical Assistance

For applications assistance or other technical information, contact the Applications Engineer. You can call (616) 695-6831, FAX (616) 695-1304, or write:

Electro-Voice Applications Engineer 600 Cecil Street Buchanan, MI 49107 U. S. A.

Electro-Voice a MARK IV company



600 Cecil Street, Buchanan, Michigan 49107, Phone (616) 695-6831, Fax: 616-695-1304  
8234 Doe Avenue, Visalia, California 93291, Phone (209) 651-7777, Fax: (209) 651-0164  
Mark IV Audio Canada, Inc. 345 Herbert St., Gananoque, Ontario, Canada K7G 2V1, Phone (613)382-2141,  
Fax (613)382-7466