

Ibanez SERVICE MANUAL

CS505 CHORUS

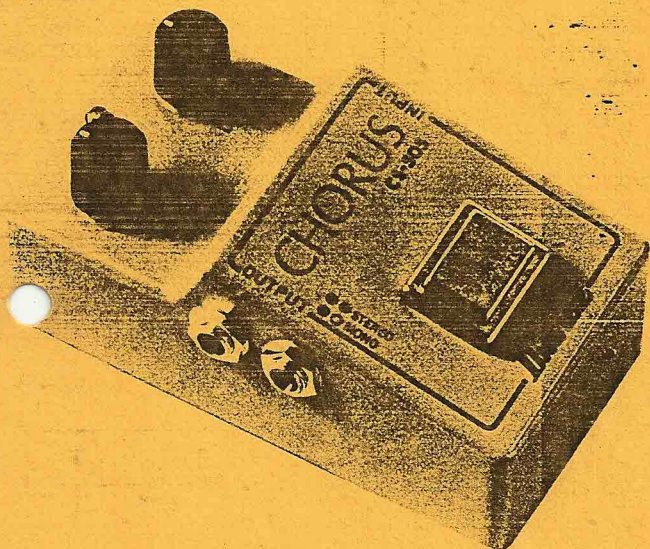

DISPOSITION OF PARTS

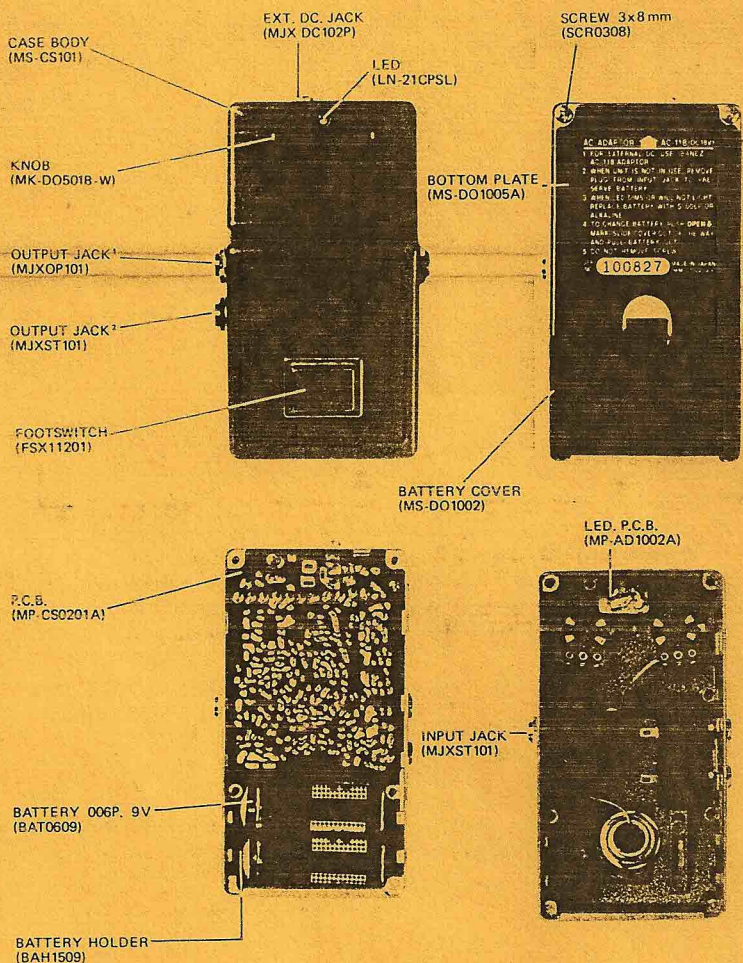

PARTS LIST

PARTS NAME	TYPE	PARTS NO.	REF. NO.
CASE BODY		MS CS101	
BOTTOM-PLATE		MS DO1005A	
BOTTOM-RUBBER		BR DO1003A	
BATTERY-COVER		MS DO1002	
BATTERY-RUBBER		BR DO1004A	
P.C.B.		MP CS0201A	
FOOTSWITCH	ELECTRIC	FSX11201	
INPUT JACK	MOLD STEREO	MJXST101	
OUTPUT JACK	MOLD STEREO	MJXST101	
OUTPUT JACK	MOLD OPEN	MJXOP101	
KNOB		MK-DO501B-W	
BATTERY	006P, 9V	BAT0609	
BATTERY HOLDER	200mm	BAH1509	
SCREW	3x8mm	SCR0308	
LED	LN-21CPSL	LN-21CPSL	
LED P.C.B.		MP-AD1002A	
EXT. DC JACK		MJX. DC. 102P	
IC	MN3007	MN3007	IC102
IC	MN3101	MN3101	IC103
IC	TL022CP	TL022CP	IC101, 105
IC	MA741CP	MA741CP	IC104
IC	MC78L12CP	MC78L12CP	IC106
TRANSISTER	2SC536SPE	2SC536SPE	Q101 - 103, 108 - 113
FET	2SK44SPC ₂	2SK44SPC ₂	Q104 - 107
DIODE	RD11EB	RD11EB	D107
DIODE	W03C	W03C	D110
DIODE	MA150	MA150	D101 - 106, 108 - 109
VARIABLE RESISTOR	16 ϕ 100KB	PMXB155R104BSC	
SEMI FIXED RESISTOR	10K3P	RSFST103P3	VR102
SEMI FIXED RESISTOR	200K3P	RSFST204P3	VR101

P.C.B.

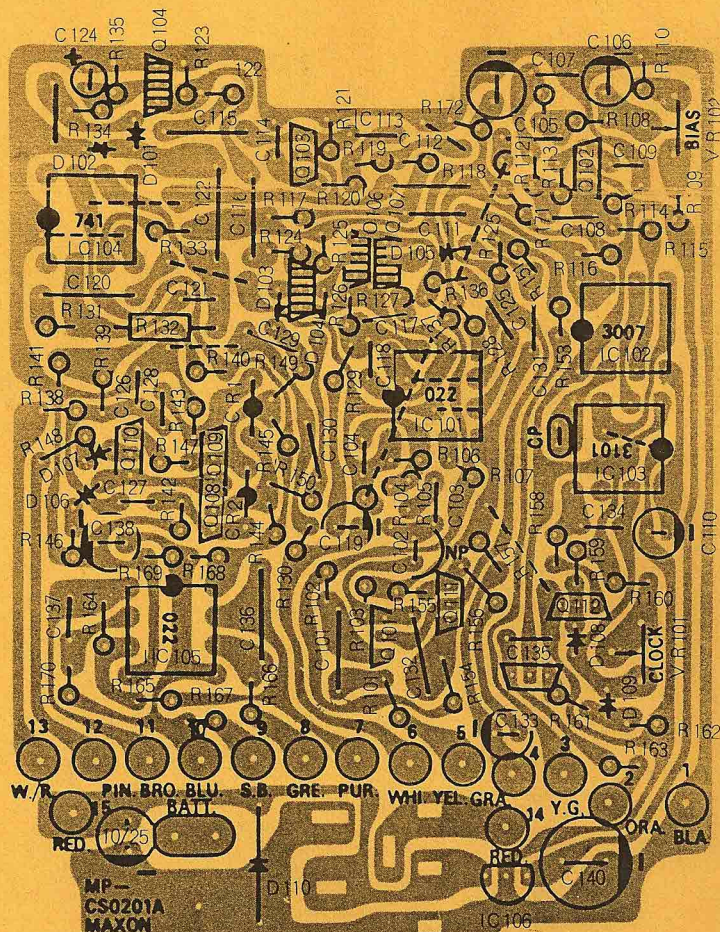

BLOCK DIAGRAMS

TROUBLE SHOOTING

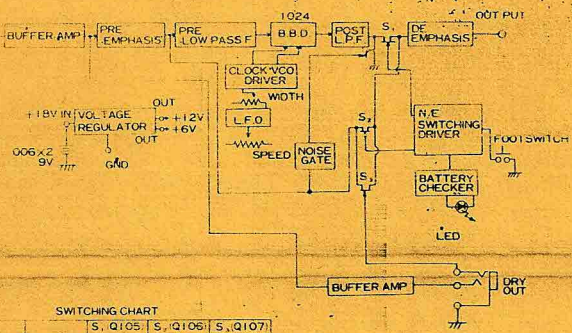

SWITCHING CHART

	S. Q105	S. Q106	S. Q107
STEREO	NORMAL	OFF	ON
	EFFECT	ON	OFF
MONO	NORMAL	OFF	ON
	EFFECT	ON	OFF

ADJUSTMENT PROCEDURES

- 1) CLOCK**
1. Set SPEED controls fully CW and DEPTH controls fully CCW.
 2. Adjust VR101 for a frequency of 80KHz at marked CP.
 3. Set SPEED controls fully CCW and DEPTH controls fully CW.
 4. Make sure wave form as shown in Fig. A. or the frequency of 69KHz to 104KHz at marked CP.

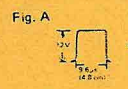

OSCILLOSCOPE
 TIME/CM: 2µsec
 VOLTS/CM: 2 to 5V
 MODE: DC

- 2) BBD BIAS**
1. Put 1V (0dB) 400Hz sinewave into INPUT.
 2. Set SPEED controls fully CW and DEPTH controls fully CCW.
 3. Adjust VR102 for a symmetrical clipped wave at output.

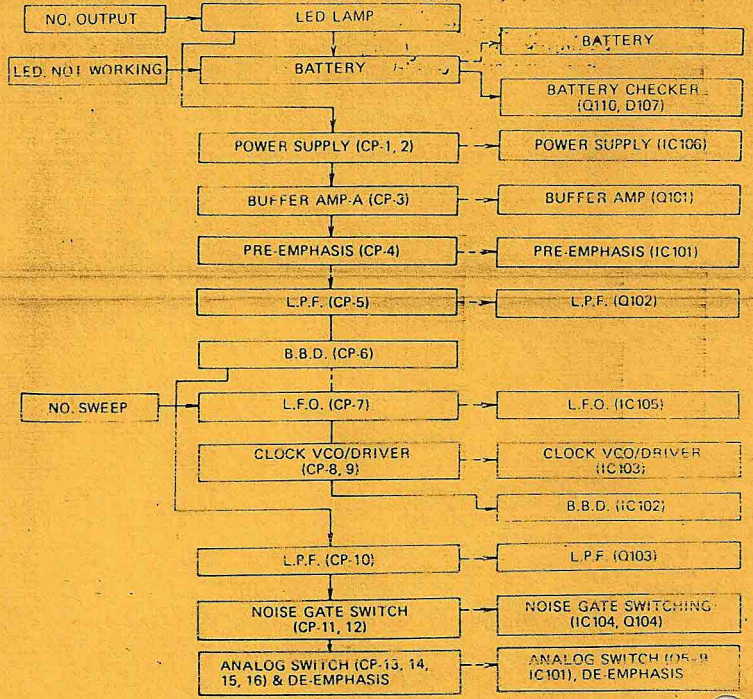

REMARK: SIGNAL OF CP IS THE WAVE INPUTTING A SINE WAVE SIGNAL TO INPUT.

CP-1	CP-2	CP-3	CP-4	CP-5	CP-6	CP-7	CP-8	CP-9	CP-10
V	V	S	S	S	S	S	S	S	S
-12V	+6V								

CON. DITION	CP-15	CP-11	CP-12	CON. DITION	CP-13	CP-14
	V	V	S		V	V
STEREO	+10V	200mV	-7.7V	EFFECT	+7V - +8V	+0.5V
MONO	+0.1V	SHORT	+10mV	NORMAL	+0.5V	+7V - +8V

SCHEMATIC DIAGRAMS

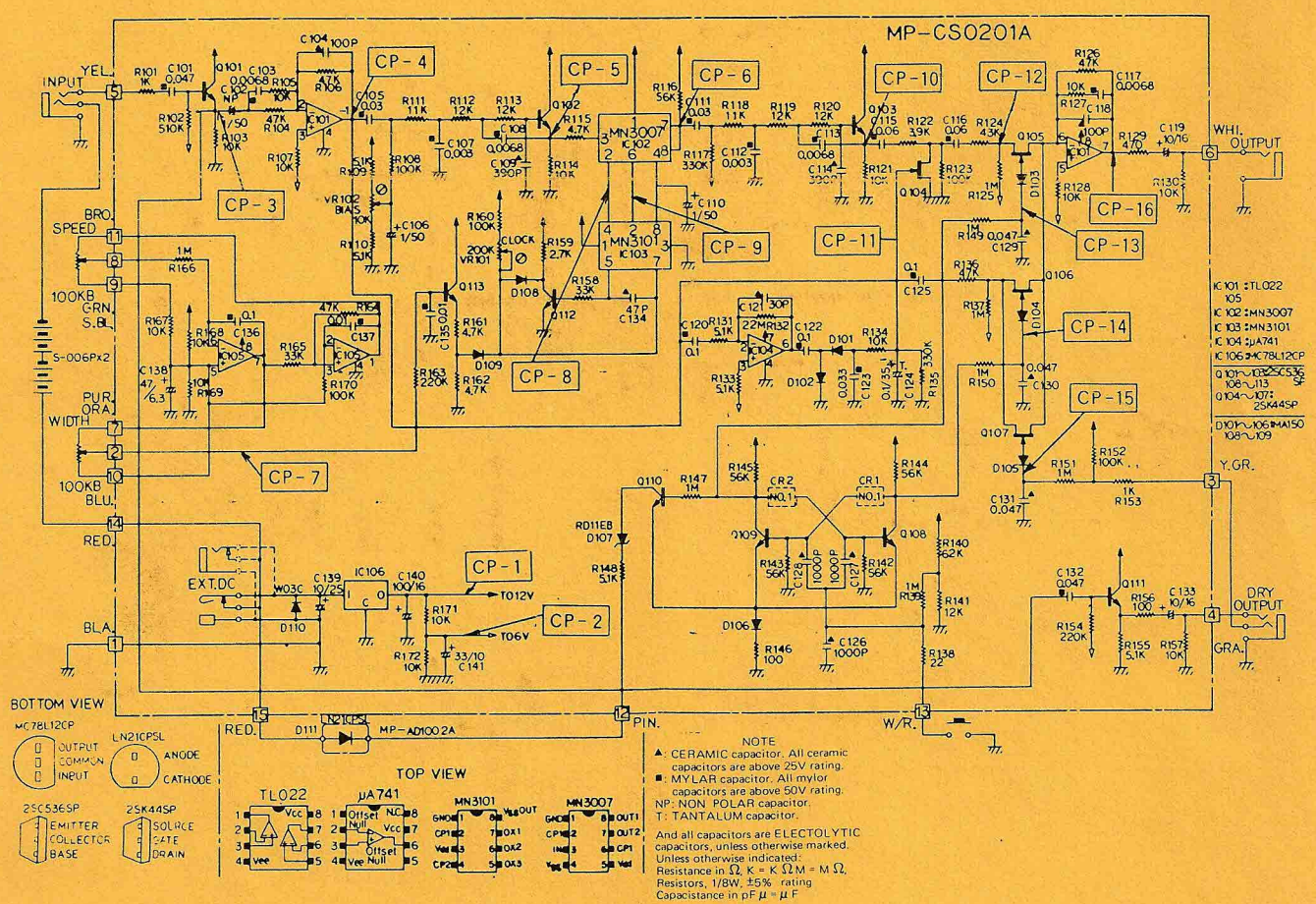

NOTE
 ▲ CERAMIC capacitor. All ceramic capacitors are above 25V rating.
 ■ MYLAR capacitor. All mylar capacitors are above 50V rating.
 NP: NON POLAR capacitor.
 T: TANTALUM capacitor.
 And all capacitors are ELECTROLYTIC capacitors, unless otherwise marked. Unless otherwise indicated: Resistance in Ω, K = K Ω, M = M Ω. Resistors: 1/8W, ±5% rating. Capacitance in pF, µ = µ F.