



# LINN

## Service Manual for LK2 Series of Power Amps Covering LK2(60), LK275 & LK280

For the purposes of this manual, we will refer to the three types as LK260, LK275 & LK280. The term LK2 will be used as an “umbrella term”, covering all three types, i.e. the LK2 series.

### CONTENTS

<b>INTRODUCTION .....</b>	<b>2</b>
ABOUT THE LK2 SERIES .....	2
HOW TO DIFFERENTIATE BETWEEN TYPES OF LK2.....	2
ABOUT THIS MANUAL.....	3
RETAILER & DISTRIBUTOR OBLIGATIONS .....	3
SPARE PARTS AVAILABILITY AND LK2 REPAIR .....	3
HOW TO USE THIS MANUAL.....	3
<b>IMPORTANT SAFETY INFORMATION &amp; INSTALLATION ADVICE .....</b>	<b>4</b>
MAINS CONNECTIONS .....	4
LETHAL VOLTAGES.....	4
PLACEMENT.....	4
<b>PROCEDURE FOR DISMANTLING AND RE-ASSEMBLING THE LK2.....</b>	<b>5</b>
<b>FAULT FINDING ON THE LK2 – HINTS &amp; TIPS .....</b>	<b>9</b>
<b>POWER-UP PROBLEMS – FAULT TABLE.....</b>	<b>10</b>
WON'T POWER UP.....	10
WON'T SWITCH OFF.....	10
FUSE BLOWING.....	11
<b>AMPLIFIER PROBLEMS – FAULT TABLE.....</b>	<b>13</b>
NO OUTPUT .....	13
TRIP (PROTECTION) PROBLEMS.....	15
DISTORTION / CRACKLING ETC.....	16
DC AT OUTPUT.....	17



## Introduction

### About the LK2 Series

There were three versions of the LK2:

- The first version was known at the time simply as the LK2. It gave an output of 60 watts per channel (into 8 ohm load) and used PCAS 003 type boards. For the purposes of this manual, we will refer to this version as the LK260.
- The second type was also usually known as the LK2 but was often called the LK275 to differentiate it from the 60-watt version, as it gave 75 watts per channel. Also used PCAS 003 type boards but with several improvements over the 60 watt version – the most obvious being the increased power output, but also had improved protection circuitry and better sound.
- The third and last type was known universally as the LK280. 80 watts per channel – used PCAS 020 boards. PCAS 020s, at first glance are similar to PCAS 003s, in that they are roughly the same size, shape and layout, but they are a completely different design of board (i.e. not just a modified version of PCAS 003) as a closer examination shows. The LK280 sounded considerably better than either of its predecessors.

### How to differentiate between types of LK2

There are several methods of determining the specification of an LK2:

- Looking at the serial number of a unit and using the **LK2 Product History** (accessible via Linfo website – Product Information) will tell you which revision it was sold as. Since, however upgrade kits were sold by Linn in large quantities to allow customers to convert their early version LK2 into the latest spec, many units are not what they seem. The following information will help you to determine the specification of a unit if its exact history is unknown.
- LK280s had “LK280” printed on the fascia – earlier units (LK2 & LK275) had “LK2” printed there, but beware – an earlier version may have been upgraded to LK280 spec.
- LK260s and LK275s had a red power LED and LK280s had a green LED. This is handy as a quick and easy indicator but is not 100% reliable (LEDs are easily changed)
- The best way to determine a unit’s spec is simply to remove the sleeve and look at the boards that are fitted (see below).

#### Distinguishing Features of Different Board Types

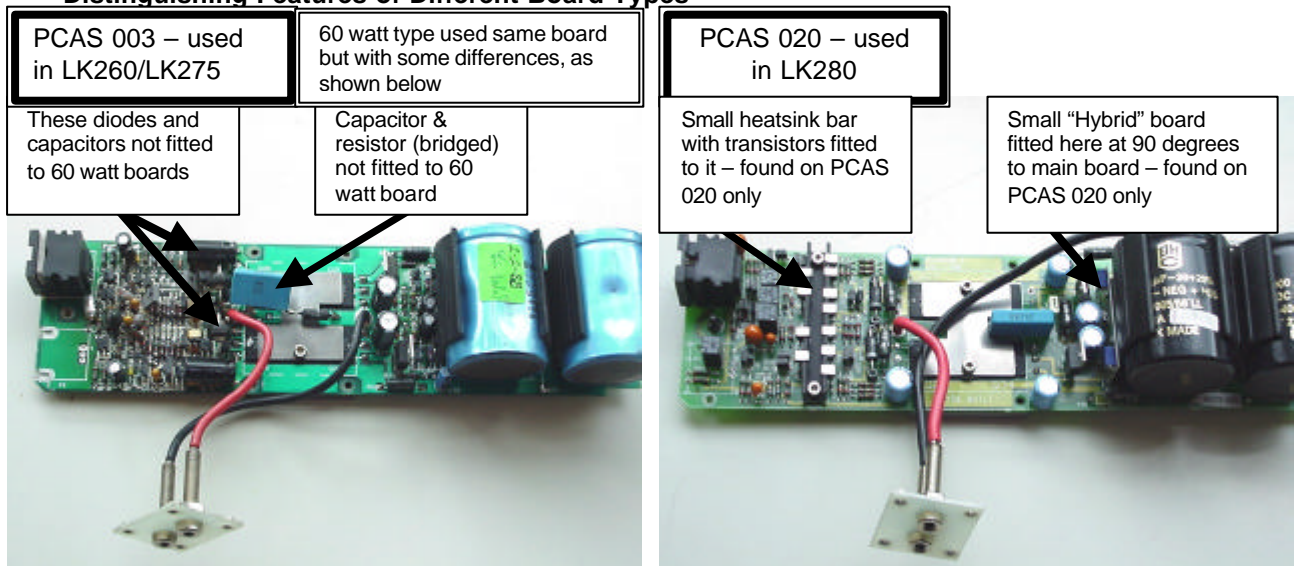

### About this manual

This manual deals effectively with three quite distinct amplifiers. The amps have enough in common to justify this approach and this avoids the confusion that might come with separate manuals. Any differences between the types will be dealt with in the "Circumstances" column – e.g. Applies to LK280 only.

This manual is designed to help you, as a Linn Retailer or Distributor, to repair as many LK2 faults at your repair centre as is practical and so provide the best possible service for your customer should a problem arise.

If you have any suggestions or comments regarding this manual, please contact Paul O'Neill at Linn Products Ltd:

By E-mail	PAULO@LINN.CO.UK
By Phone	++44 (0) 141 303 5005
By Fax	++44 (0) 141 644 4262 Marked for attention of Paul O'Neill

### Retailer & Distributor Obligations

Linn Specialist Retailers or Distributors are obliged to carry out the repairs in this manual under the terms of the contract & warranty agreements. You should return a faulty product to Linn for repair, only if the fault is not covered in this Service Manual. If a product, which is under warranty, is returned to Linn for repair and the fault is covered in the service manual, Linn may levy a charge and this charge should not be passed to the customer.

### Spare Parts Availability and LK2 repair

Please note that the LK2 has been discontinued for some considerable time now and as such, we cannot guarantee the supply of spare parts – many are simply no longer available and some others are no longer in stock. Some part numbers are listed throughout this manual, but these are provided for information only and this does not imply that these parts will be available should you request them.

Linn guarantee that we will support a product until 5 years after the final build. We take this obligation very seriously and also go much further. Beyond this date, we will repair any Linn product that we possibly can, where it is within our power to do so. However, due to the difficulty with the availability of spare parts, as explained above, it is occasionally not possible to repair a product or supply parts for repair, if the necessary parts are not available.

### How to use this manual

The main body of this manual, the fault table, is designed to be as quick and simple as possible to use when you are confronted with a faulty product and so it is arranged by fault symptom as the symptom is usually all that you will know about the fault.

Also read the "**LK2 fault finding – Hints & Tips**" section below as the information contained there may save you a lot of time.

If you are unsure about the meaning of any words or phrases, look in the **Glossary**. (accessible via Linfo Website - Product Information)

Before embarking on any Service work, you should read the **Service Procedures** section (accessible via Linfo Website - Product Information), as there are certain procedures that must be followed in order to ensure the problem is resolved quickly and permanently

### **Table of contents & fault symptoms**

Look firstly at the table of contents and find the category that covers the symptom you are seeing, then look down the list of faults in that section until you find the symptom or symptoms that best describe the problem.

### **Circumstances**

Then simply follow the table along – the table specifies circumstances surrounding the fault symptom – e.g. whether the fault is likely to be intermittent or constant, if the fault only occurs within a range of serial numbers etc.

### **Possible causes**

The next column details possible causes – this is effectively the most important section, probably the main reason you are looking at this manual at all. There may be several possible causes for the symptom you have – it is worth checking out all of these (and bear in mind that there may be more than one fault). For



some faults, simple checks are detailed that you can use to rule out the problem without replacing any parts, whereas for other faults, the simplest way to rule out the problem is to replace the component(s) listed

### **Cure**

Quite simply the action that you must take to cure the problem.

## **Important Safety Information & Installation Advice**

### Mains connections

This appliance **must** be earthed – both for Safety and functional reasons.

### Lethal Voltages

Inside the LK2, lethal voltages are present, avoid powering up an LK2 with the sleeve removed or with any live parts exposed. If you must work under such circumstances, DO NOT touch any part of the circuitry or any electrical connections and take great care to avoid electrocution.

### Placement

#### **Location & Environment**

Do not locate near electronic products that may transmit RF, such as computers, fax machines, TVs etc, or connect them to the same mains socket as these devices. Also avoid close contact with the mains or signal leads of such products – careful routing of the cable may be required.

Although the LK2 can usually be stacked along with other products with no problem, it is better if possible to keep it apart from other products to prevent its operation being adversely affected by the heat and strong electrical field emitted by some products; also - since the LK2 can emit a considerable amount of heat and has a fairly strong electrical field, it is better to keep it away from other devices that may be adversely affected by this.

Avoid locations that have high humidity or the chance of the unit getting wet.

Avoid locations where there is a lot of dust.

#### **Handling & general maintenance.**

Always handle the LK2 with great care – IT IS VERY HEAVY.

Always turn off the LK2 and wait at least 30 seconds before connecting or disconnecting any plugs to/from the sockets at the back of the unit to avoid damage to the speakers.

If you are carrying out any work on the LK2 with its' sleeve removed, **ALWAYS** take anti-static precautions as tiny static discharges from your body, which you may be completely unaware of, can damage electronic circuitry and cause major problems. Anti-static earth mats & wrist straps must be used when handling any of the circuit boards or any spare parts.



## Procedure for Dismantling and Re-assembling the LK2

### Step 1. Remove the boards from the LK2

*Remember to keep all the screws and other parts that you remove from the LK2 in a safe place to re-use later.*

1. Disconnect LK2 from everything and especially the mains (or Spark).
2. Place a soft cloth on the workbench & lie the LK2 upside down on the cloth. Using a No2 posidriv screwdriver, remove the 4 screws that hold the sleeve on to the LK2. Stand the LK2 on its fascia and slide the sleeve up and off. Carefully set it aside in a safe place where it will not get scratched or damaged.
3. Remove the 4 allen bolts or screws (older units used screws) holding the speaker sockets on to the back panel. Do this to both channels.
4. Disconnect both transformer connectors (the cables going from transformer to board) from the board
5. Lift the LK2 up so that it is standing on one of the heatsinks. Each channel is held into the tray by 2 countersunk screws that attach to the heatsink on the underside. Hold the channel that is now uppermost (to prevent it from falling once it has been freed) and remove the two screws from this channel only. Lie the LK2 down (correct way up) and remove the channel that you have just loosened – this can sometimes be tricky so follow these instructions:
  - Pull the board slightly toward the front of the unit until the 3-pin cannon input socket at the rear is clear of the back panel – it may sometimes be necessary to push the back panel slightly in the opposite direction until the socket is completely clear.
  - Lift the end of the board containing the 3-pin cannon socket upwards (see picture) until that end of the board is clear of the tray. Some delicate manoeuvring may be necessary, but don't force it.

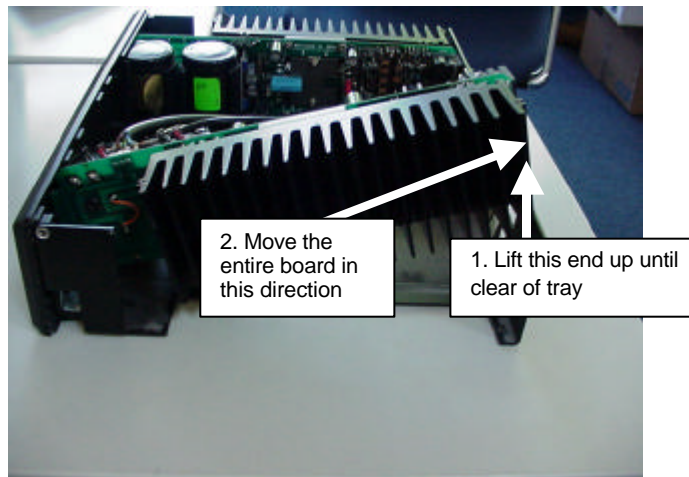

- By carefully moving the board backwards & upwards, it should now be possible to lift it up and out of the tray.
- Repeat the above instruction for the other channel

### Step 2/



**Step 2. Remove the heatsinks from the boards (if required)**

1. Using the 5.5mm spanner or nut-runner, loosen the single nut/bolt found beside the 3-pin cannon socket (see picture below) – do not remove the nut completely, but loosen it to the point where only a very small amount of the bolt is protruding from one side of the nut.
2. The board is now held on to the heatsink by 4 allen screws or 4 nuts/bolts (see picture below).
  - If nuts/bolts are fitted, loosen them but do not remove them (as with single bolt above), pull the board upwards until there is a gap between the board and the heatsink and then slide the board to one side. If the board will not move easily, check that you have loosened all 5 nuts/bolts. If all are loosened correctly and it is still not free, the board may be held on by the heatsink compound and will require some slight pressure to free it.
  - If the board is held on by allen screws, completely remove all 4 screws, lift the board away from the heatsink and slide the single bolt beside the cannon socket sideways to free the board.

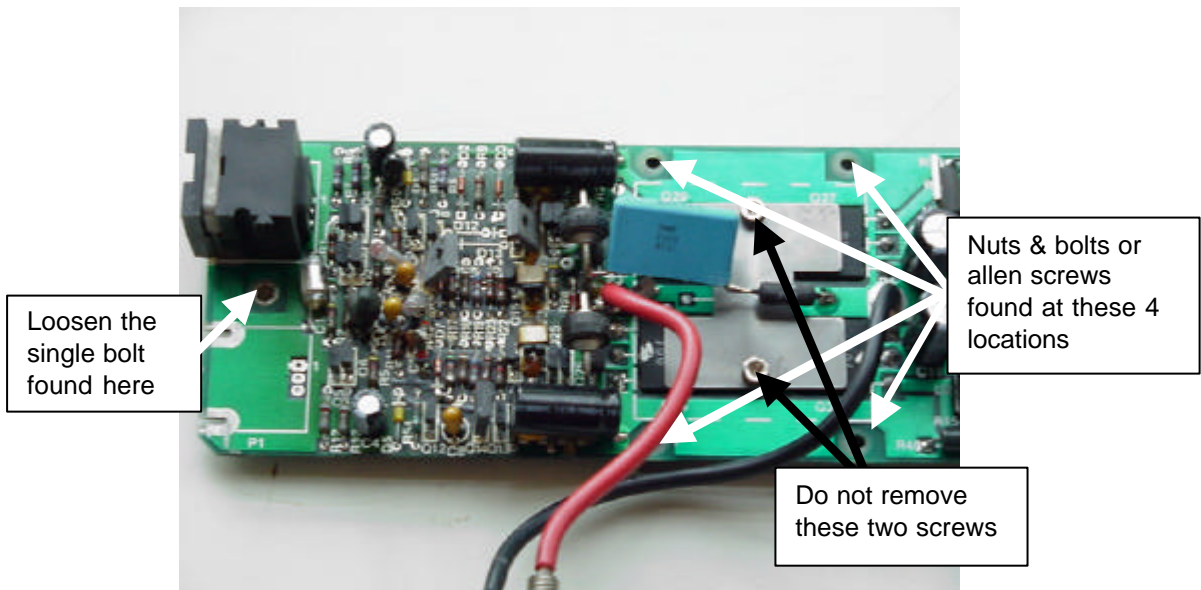

3. Use a tissue or paper towel to clean the heatsink compound from the board and from the heatsink (if you don't, you will find out very quickly that heatsink compound has a knack of ending up all over your clothes, hands, face etc)

**Step 3/**



**Step 3. Re-assemble the LK2**

1. Re-attach the heatsink:

Apply heatsink compound in a single line along the centre of the coupling block as shown below

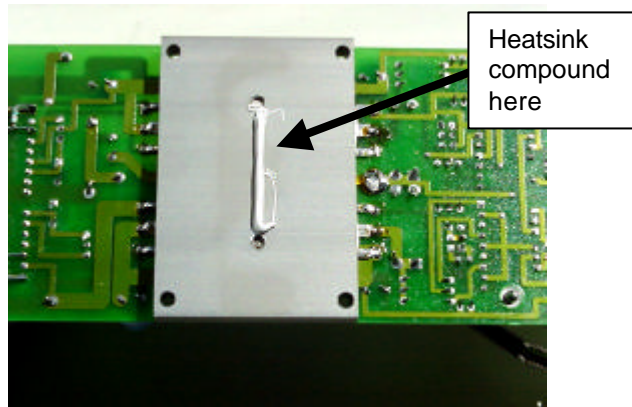

If board was attached to heatsink by nuts & bolts – follow the instructions below:

- Remove all five bolts from the board and slide the bolts into the slots, arranged as shown below

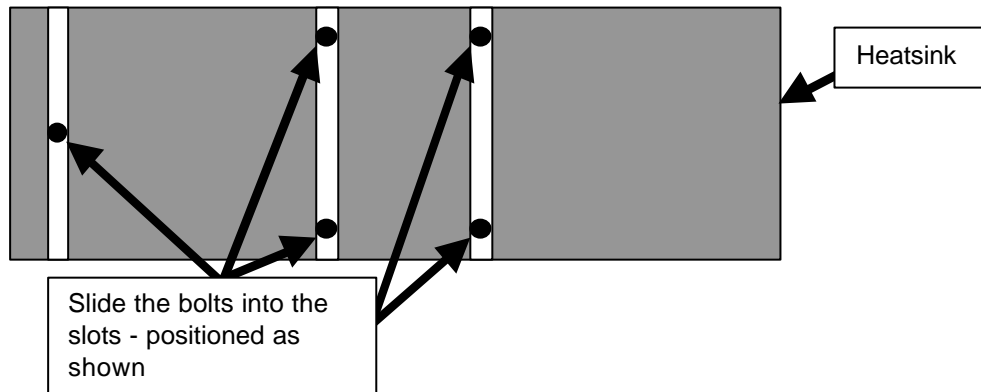

- Place the board onto the heatsink so that all the bolts pass through their respective holes on the board (some readjustment is usually necessary).
- Screw the nuts onto the bolts but do not tighten fully.
- Adjust the position of the board with respect to the heatsink so that the two are matched up – i.e. the two are parallel with each other and neither the board nor the heatsink are protruding at either side (see pictures below – exaggerated to show problems clearly)

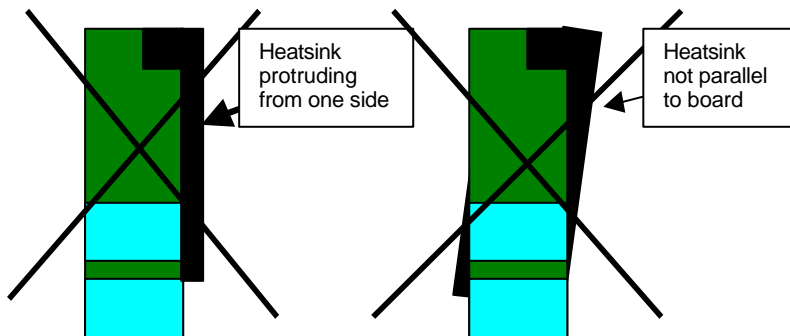

- Once heatsink and board are matched up, tighten bolts.

If heatsink was attached with allen screws:



- Slide the single nut/bolt (still attached to board) into the middle of its slot – do not tighten
  - Rest the board on the heatsink in a central position.
  - Line up the screw holes in the board with those in the heatsink and screw in all four screws – but do not tighten fully.
  - Line up the board and heatsink so that they are parallel and level with each other (as diagrams above) and then tighten the screws fully.
  - Tighten the nut/bolt
2. Refit boards into tray – just do the reverse of the dismantling process described at the start of this document.
  3. Refit sleeve
  4. Test amp fully





## Fault Finding on the LK2 – hints & tips

The LK2 circuitry is notoriously difficult to fault-find on in the traditional way (tracing signals, measuring voltages etc), so this manual seeks to help you to avoid this ordeal. Check the fault tables below firstly, to see if your fault is included and if not, use the information in this section.

### Trip

One issue that may prevent you from fault-finding is the inclusion of the “Trip” or protection circuitry which will shut down the entire board if it detects a problem that might cause damage to the amp or the speakers. If trip occurs, it makes fault finding very very difficult as no power reaches the amplifier section of the board. If this happens it is best to try to find the fault with the power off – use the information found in the Fault Tables below and in this section.

### Isolating Faulty Components in the LK2 Circuit

#### Common Faults

Around 60-70% of faults in an LK260 or LK275 board **only** (i.e. not LK280) are attributable to just 4 components. See “**LK2 Reliability Modifications**” (accessible via Linfo – Product Information) for instructions on how to replace these components and prevent re-occurrence. This modification is a good first step for a faulty PCAS 003 board and should even be carried out to working boards as a preventative measure.

#### Transistors

The majority of remaining faults on an LK2 board are caused by faulty transistors, so this is a good place to start. If the transistors develop a fault, they normally develop a short circuit (zero ohms) or low impedance across one or more junctions, so it is usually quite a simple job to trace the faulty transistor by measuring across every junction of every transistor – while the transistor is still in circuit. This might seem daunting, given the number of transistors on each board, but it is definitely a worthwhile exercise as it may save you many hours of conventional fault-finding and does not take as long as you might think (about 20 minutes per board).

Just measure the impedance across all 3 junctions (Emitter – Bass; Emitter – Collector; Bass – Collector) of every transistor on the faulty board.

In general a working junction will measure many Kohms or even Megohms, whereas a faulty junction will tend to measure almost short circuit – perhaps a few ohms – possibly up to 500ohms at most. If in doubt, compare with the same junction on the good channel and replace transistor if you suspect faulty.

It is advised that you check every single transistor on the board, i.e. don't stop if you find a faulty one, as quite often there is more than one faulty transistor on the board.

Remember to include the big transistors (the 4 that are clamped to the heatsink) when measuring.

The above test, while not absolutely guaranteed to find every faulty transistor, will find the vast majority.

Remember that it is quite common for more than one component to be faulty, as often a faulty component will cause damage to others around it in the circuit. See below for advice on how to check for this.

#### Other components

Other components are slightly less straightforward. The same principles as with Transistors above can be applied (measure using an ohmmeter) but there is a lot more work involved and a lesser chance of success as these parts are less likely to go faulty and less likely to follow such a straightforward pattern as the transistors.

If you have a fault that is not caused by any of the faults listed in this manual – i.e. the fault tables and this section - then try to narrow the fault down to an area of the circuitry using conventional fault-finding and then measure and/or replace the components in that area.

Resistors can of course be easily measured for impedance but are very unlikely to go faulty unless another component failure has damaged them, so look for telltale signs like scorching etc on or around the resistor that might indicate this.

The Capacitors on this circuit can also be checked using an ohmmeter as above. Sometimes capacitors will internally short-circuit so worth a quick measurement.

Check the components (as transistors above) using an ohmmeter.



## Power-up problems – Fault Table

Won't power up			
Symptom	Circumstances	Possible Cause(s)	Cure
Won't power up. Power LED dead & no function – both channels	Constant	Fuse blown in unit and/or in mains plug.	Replace fuse(s) with correct value & type. Fuse in mains lead should be 5A. Fuse in LK2 should be “Slow Blow” – look for a ‘T’ before the rating on the fuse. Correct types are: 100-115V - T3.15A antisurge 220-240V - T6.3A antisurge
Won't power up. Power LED dead & no function – both channels	May be intermittent	Mains lead faulty	Replace faulty mains lead.
Won't power up. Power LED dead & no function – both channels	May be intermittent	Power switch faulty	Replace power switch – use Linn part no: SWRL 006
Unit dies intermittently & stops working for a while – possible distortion or reduction in sound quality - both channels	At any time	Mains voltage dropping too low for LK2 to function correctly (known as ‘Brown outs’ as these voltage drops also sometimes cause the house lights to dim.)	Consult an electrician or your electricity supply company.
Doesn't power up or Powers up (display LED lit) but no function. or Possible distortion / poor sound quality – both channels	May be intermittent	Wrong mains voltage for LK2 type – mains voltage is too low. (e.g. 240V unit being used with 115V mains supply.)	Check voltage rating on underside of LK2. If wrong, transformer will require replacement. Correct part numbers are: MCAS 001/100 for 100V mains MCAS 001/115 for 115V mains MCAS 001/220 for 220V mains MCAS 001/240 for 240V mains Our stock of these transformers is very limited, so it may not be possible to supply the part you require.
One channel dead	May be intermittent	Transformer cable not connected to board; may be broken or may have a bad connection	Reconnect cable or repair if broken.
One channel dead	May be intermittent	Channel has “tripped”	See <b>Trip Faults</b> section below
One channel dead	May be intermittent	Board is faulty	See <b>Amplifier Faults</b> section below

## Won't switch off

Amp will not switch off using power switch	May be intermittent	Faulty power switch	Replace power switch – use Linn part no: SWRL 006
--	---------------------	---------------------	--



Fuse blowing			
Symptom	Circumstances	Possible Cause(s)	Cure
Fuse blowing	May be intermittent	Wrong type of fuse fitted	Replace fuse(s) with correct value & type. Fuse in mains lead should be 5A. Fuse in LK2 should be "Slow Blow" – look for a 'T' before the rating on the fuse. Correct types are: 100-115V - T3.15A antisurge 220-240V - T6.3A antisurge
Fuse blowing	May be intermittent	Mains surges	Consult an electrician or your electricity supply company..
Doesn't power up or Powers up (display LED lit) but no function.  Possible distortion or poor sound quality	May be intermittent	Wrong mains voltage for LK2 type – mains voltage is too high (e.g. 115V unit being used with 240V mains supply.)	Check voltage rating on underside of LK2. If wrong, transformer will require replacement. Correct part numbers are: MCAS 001/100 for 100V mains MCAS 001/115 for 115V mains MCAS 001/220 for 220V mains MCAS 001/240 for 240V mains Our stock of these transformers is very limited, so it may not be possible to supply the part you require.
Fuse blowing	May be intermittent but usually constant	Transformer faulty. To check if it is definitely the transformer, power down the unit, replace fuse, disconnect the transformer output from the Main board and power up. If the transformer IS the cause, the fuse will continue to blow. If the fuse remains intact, the fault is more likely to be on the board.	Replace transformer. Correct part numbers are: MCAS 002/100 for 100V mains MCAS 002/115 for 115V mains MCAS 002/220 for 220V mains MCAS 002/240 for 240V mains Our stock of these transformers is very limited, so it may not be possible to supply the part you require.
Fuse blowing	Constant	Bridge rectifier diode on amplifier board faulty (probably internally short circuit). These are the four large diodes which can be found on the underside of each amplifier board, under the big capacitors Try measuring across all four with an ohmmeter – if one has an internal short circuit, it should be quite obvious.	Replace faulty bridge rectifier diode(s) Part details: MR752 6A 200V Rectifier diode (Linn Part no: MISS 010)



Fuse blowing	Constant	Big capacitor(s) faulty – probably internally short circuit. Measure across both capacitors on the channel that is causing the fuse to blow – a faulty capacitor will measure short circuit or certainly low impedance. If in doubt, compare with good channel . See <b>Introduction to Fault Finding</b> section (accessible via Linfo Website - Product Information) for tips on how to isolate faulty board	Replace faulty capacitor Part details: 10000uF; +/- 20%; 64V; Electrolytic Capacitor (Linn part no: CAP 085) Same part can be used for any version of LK2
Fuse blowing	Constant	Fault inside LK2, e.g. short circuit or similar.	See <b>Introduction to Fault Finding</b> section (accessible via Linfo Website - Product Information) for tips on tracing the fault. Also see circuit diagrams.



## Amplifier problems – Fault Table

No output			
Symptom	Circumstances	Possible Cause(s)	Cure
No output from both channels	Possibly intermittent	Unit not powering up correctly.	See 'Power up problems' section above
No output from one channel	Applies only to LK260 & LK275  Probably constant	One of the "Reliability Modification" components has failed	Carry out " <b>LK2 Reliability Modifications</b> " – procedure can be accessed via Linfo – Product Information.
No output from one channel OR occasionally may affect both channels	May be intermittent	Amp has tripped.	See 'Trip Faults' section below.
No output from one channel	Applies only to LK280  Probably constant	Power transistor (the large transistors clamped to the heatsink) faulty. It is sometimes possible to measure these transistors using an ohmmeter to check if faulty (usually internal short-circuit across one or more of the junctions), but also there is the possibility that the transistor measures okay but is indeed faulty. It will sometimes be necessary to change them to confirm or rule out this fault.	Check / replace power transistor(s). Part details – Q23 & Q30 – 2SA1386; PNP; 160V; 15A; MT100 (Linn part no: TRAN 017)  Q24 & Q34 – 2SC3519; NPN; 160V; 15A; MT100 (Linn part no: TRAN 018)
No output from one channel	Applies only to LK275 & later versions of LK260.  Probably constant	Power transistor (the large transistors clamped to the heatsink) faulty. It is sometimes possible to measure these transistors using an ohmmeter to check if faulty (usually internal short-circuit across one or more of the junctions), but also there is the possibility that the transistor measures okay but is indeed faulty. It will sometimes be necessary to change them to confirm or rule out this fault.	Check / replace power transistor(s). Part details – Q20 & Q27 – 2SA1386; PNP; 160V; 15A; TO218 (Linn part no: TRAN 017)  Q24 & Q31 – 2SC3519; NPN; 160V; 15A; MT100 (Linn part no: TRAN 018)



No output from one channel	Applies only to earlier versions of LK260  Probably constant	Power transistor (the large transistors clamped to the heatsink) faulty. It is sometimes possible to measure these transistors using an ohmmeter to check if faulty (usually internal short-circuit across one or more of the junctions), but also there is the possibility that the transistor measures okay but is indeed faulty. It will sometimes be necessary to change them to confirm or rule out this fault.	Check / replace power transistor(s). Parts may be as listed in the box above or they may be as listed below, depending on whether it is an earlier or later version of LK260. Part details – Q20 & Q27 – TIP36C; PNP; 100V; 25A; TO218 (Linn part no: TRAN 005)  Q24 & Q31 – TIP35C; NPN; 160V; 15A; TO218 (Linn part no: TRAN 004)
No output from one channel	May be intermittent	Regulator U1 or U2 faulty	Replace faulty regulator – part details: U1 – LM317T Voltage regulator (Linn part no: IC 005) U2 – LM337T Voltage regulator (Linn part no: IC 006)
No output from one channel	Applies to LK280 only  May be intermittent or may be constant	U3 (hybrid card) faulty. U3 is the small board that is connected at 90degrees to the main board beside the big caps.	Replace U3 – Linn part number IC 030 (not available elsewhere). Take great care when removing U3 from the board as it is very easy to rip tracks. The pins in the middle are especially difficult to de-solder – use heat & patience – not force.  It is also worth checking / replacing regulators U1 & U2 (part details above) and the big resistors at either side – R37 & R46 – part details: 0.1ohm; 10%; 2.5W; 100V. (Linn part no: RES 050).
No output from one channel	May be intermittent	Faulty component in circuit.	See “ <b>Fault Finding on the LK2 – hints &amp; tips</b> ” section at the beginning of this manual.



## Trip (protection) problems

### Important information about the Trip / Protection circuitry

#### About 'Trip'

The LK2 series had a trip circuit for each channel, which was designed to protect the LK2 board and/or speakers from a potentially damaging "over-current" situation. This means that if the LK2 senses that it is drawing too much current, it shuts down the affected channel. This situation may be caused by a faulty speaker (internal short circuit), speaker cables shorted together, very loud music, faulty pre-amp etc.

#### How to clear trip

Once a channel trips, it will remain in 'trip-mode' until the LK2 is switched off for up to 20 minutes. It is best to ensure that you leave the unit switched off for the full 20 minutes – if you power it up before it has fully discharged / un-tripped, the trip capacitors will charge up again and you will have to wait another full 20 minutes. We have heard of customers who do not leave it switched off for long enough, switching it on before it is ready and perhaps doing this a few times then think the product has a permanent fault.

#### Continuous or repeated tripping

It is important to remember that the trip circuitry is included as protection and the LK2 may be tripping for a very good reason. If tripping occurs continuously or even occasionally, it may be because the LK2 is doing its job correctly and something within the system is causing it to trip. The source of the problem needs to be isolated and removed (perhaps the speaker or the speaker cable, the pre-amp is faulty etc). See

**Introduction to Fault Finding** for tips on how to trace (accessible via Linfo – Product Information).

It is, of course also possible that the LK2 is faulty, in which case, see table below.

Symptom	Circumstances	Possible Cause(s)	Cure
Tripping	May be intermittent	Power transistor (the large transistors clamped to the heatsink) faulty.	Check / replace power transistor(s). Part details – Q23 & Q30 – 2SA1386; PNP; 160V; 15A; MT100 (Linn part no: TRAN 017)  Q24 & Q34 – 2SC3519; NPN; 160V; 15A; MT100 (Linn part no: TRAN 018)
Tripping	May be intermittent	Regulator U1 or U2 faulty	Replace faulty regulator – part details: U1 – LM317T Voltage regulator (Linn part no: IC 005) U2 – LM337T Voltage regulator (Linn part no: IC 006)
Tripping	Applies to LK280 only  May be intermittent or may be constant	U3 (hybrid card) faulty. U3 is the small board that is connected at 90degrees to the main board beside the big caps.	Replace U3 – Linn part number IC 030 (not available elsewhere). It is also worth checking / replacing regulators U1 & U2 (part details above) and the big resistors at either side – R37 & R46 – part details: 0.1ohm; 10%; 2.5W; 100V. (Linn part no: RES 050)



Tripping	Applies only to LK280  Probably constant	Power transistor (the large transistors clamped to the heatsink) faulty. It is sometimes possible to measure these transistors using an ohmmeter to check if faulty (usually internal short-circuit across one or more of the junctions), but also there is the possibility that the transistor measures okay but is indeed faulty. It will sometimes be necessary to change them to confirm or rule out this fault.	Check / replace power transistor(s). Part details – Q23 & Q30 – 2SA1386; PNP; 160V; 15A; MT100 (Linn part no: TRAN 017)  Q24 & Q34 – 2SC3519; NPN; 160V; 15A; MT100 (Linn part no: TRAN 018)
Tripping	Applies only to LK275 & later versions of LK260.  Probably constant	Power transistor (the large transistors clamped to the heatsink) faulty. It is sometimes possible to measure these transistors using an ohmmeter to check if faulty (usually internal short-circuit across one or more of the junctions), but also there is the possibility that the transistor measures okay but is indeed faulty. It will sometimes be necessary to change them to confirm or rule out this fault.	Check / replace power transistor(s). Part details – Q20 & Q27 – 2SA1386; PNP; 160V; 15A; TO218 (Linn part no: TRAN 017)  Q24 & Q31 – 2SC3519; NPN; 160V; 15A; MT100 (Linn part no: TRAN 018)
Tripping	Applies only to earlier versions of LK260  Probably constant	Power transistor (the large transistors clamped to the heatsink) faulty. It is sometimes possible to measure these transistors using an ohmmeter to check if faulty (usually internal short-circuit across one or more of the junctions), but also there is the possibility that the transistor measures okay but is indeed faulty. It will sometimes be necessary to change them to confirm or rule out this fault.	Check / replace power transistor(s). Parts may be as listed in the box above or they may be as listed below, depending on whether it is an earlier or later version of LK260. Part details – Q20 & Q27 – TIP36C; PNP; 100V; 25A; TO218 (Linn part no: TRAN 005)  Q24 & Q31 – TIP35C; NPN; 160V; 15A; TO218 (Linn part no: TRAN 004)
Tripping	May be intermittent	Faulty component in circuit.	See <b>“Fault Finding on the LK2 – hints &amp; tips”</b> section at the beginning of this manual.

Distortion / crackling etc			
Symptom	Circumstances	Possible Cause(s)	Cure
Output distorted – may one or both channels	May be intermittent	Power-up problem – if amp receives insufficient power it will struggle to amplify the signal and distortion will occur	See <b>Power-up problems</b> section above.





Output very badly distorted	Applies only to LK260 & LK275 Probably constant	One of the "Reliability Modification" components has failed	Carry out " <b>LK2 Reliability Modifications</b> " – procedure can be accessed via Linfo – Product Information.
Distorted output	May be intermittent	Faulty component in circuit.	See " <b>Fault Finding on the LK2 – hints &amp; tips</b> " section at the beginning of this manual.
Crackling noise from output	Probably intermittent – may be temperature dependent	Transistor in circuit faulty – junction is 'breaking down'	See " <b>Introduction to Fault Finding</b> " (accessible via Linfo – Product Information) Or See " <b>Fault Finding on the LK2 – hints &amp; tips</b> " section at the beginning of this manual.

DC at output			
Symptom	Circumstances	Possible Cause(s)	Cure
DC voltage at output. Fault symptoms vary – levels of voltage etc.	Probably constant	Regulator U1 or U2 faulty	Replace faulty regulator – part details: U1 – LM317T Voltage regulator (Linn part no: IC 005) U2 – LM337T Voltage regulator (Linn part no: IC 006)
DC at output	May be intermittent	Faulty component in circuit.	See " <b>Fault Finding on the LK2 – hints &amp; tips</b> " section at the beginning of this manual.





# LINN

## **LK2(60) & LK275 Reliability Modifications**

Some components on the PCAS 003 (used in the LK260 & LK275) are sometimes prone to failure after many years of use.

This modification can be carried out as a preventative measure to prolong the life of the amplifier or as a combined repair / prevention if one of the components has failed.

Carrying out this modification will repair around 60 – 70% of LK2 faults

### Important Information about this modification

- Please read through this procedure in its entirety before starting any work.
- It is important to follow ALL instructions carefully and exactly
- This procedure involves soldering and de-soldering and it is advised that only personnel with a fairly high degree of soldering skill undertake this task. Due to the age and the years of heat stress – some of the solder joints may have changed their chemical properties and if this is the case it will be quite difficult to melt them. Use flux (or melt new solder onto the old solder joint), Use heat and patience - not force.
- The changes outlined in this procedure will protect the LK2 from similar potential failures in the future by using higher wattage resistors than were originally used and adjusting the position of some components to minimise heat damage
- It is advised that all these modifications are carried out to both channels.

### Estimated time for completion of this task:

1 hour

### CAUTION – Important Safety Information

- **Residual Voltage.** With certain faults especially but also under normal circumstances, there can be residual voltage stored in the boards which could cause quite a serious electric shock. To avoid this, it is best to leave the LK2 switched off for a few hours before starting work on it and then using a voltmeter, measure across the metal contacts of each of the big capacitors (DO NOT TOUCH) on each channel (DC voltage). If there is a voltage remaining on these capacitors then it is important to discharge it – either short across the + & - contacts with a screwdriver – this can cause a harmless but spectacular and terrifying bang combined with a huge spark. It is much more pleasant to connect one of the resistors that you will use for the mod – the 2.4Kohm/2.5Watt and connect this across the contacts of the capacitors until the voltage has discharged.
- **The LK2 is very heavy and has sharp fins** on the heatsink – be very careful when lifting, handling, dismantling and re-assembling not to injure yourself.



## Fault Symptoms

There are several different symptoms, depending on what component has failed (symptoms usually affect one channel only):

- No output at all
- Bad distortion at output
- DC at output

## Units affected

Potentially all LK260s or LK275s (those not upgraded to LK280)

## Equipment Required

*(Those items marked ~ may not definitely be required)*

Workbench clear of debris and clutter

No2 Posidriv (Supadriv) Screwdriver

~ No1 Posidriv (Supadriv) Screwdriver

~ 2.5mm Hex key or Allen Key

~ Medium sized flat-blade screwdriver

7mm spanner or nut-runner

5.5mm spanner or nut-runner

Soldering Iron, temperature controlled 25 watt with fine tip

Solder Sucker

Fine solder

Paper handkerchiefs or paper towels

Heatsink compound (a white grease-like substance that improves heat conduction)

Fine Pliers

Soft cloth

## Parts Required

20Kohm, 2.5Watt resistor Qty 2 (per unit)

2.4Kohm, 2.5Watt resistor Qty 2 (per unit)

220pF 160V Polystyrene capacitor Qty 2 (per unit)

68pF 160V Polystyrene capacitor Qty 2 (per unit)

Note – if you cannot find the above parts available in your local area, some alternatives are available in the case of the resistor wattage values:

It is possible to use a higher wattage resistor in each case, although it tends to be the case that the higher the wattage, the larger the resistor and it may not be able to physically fit in the space available or may touch against another device or component, especially in the case of R33 (not a good idea).

It is possible to use a slightly lower wattage resistor in each case, however if too low. this will shorten the life of the resistor and the fault may re-occur. A minimum of 1 watt is recommended.



## Procedure

### **Step 1. Remove the boards from the LK2**

*Remember to keep all the screws and other parts that you remove from the LK2 in a safe place.*

1. Disconnect LK2 from everything and especially the mains (or Spark).
2. Place a soft cloth on the workbench & lie the LK2 upside down on the cloth. Using a No2 posidriv screwdriver, remove the 4 screws that hold the sleeve on to the LK2. Stand the LK2 on its fascia and slide the sleeve up and off and carefully set it aside in a safe place where it will not get scratched or damaged.
3. Remove the 4 allen bolts or screws (older units used screws) holding the speaker sockets on to the back panel. Do this to both channels.
4. Disconnect both transformer connectors (the cables going from transformer to board) from the board
5. Lift the LK2 up so that it is standing on one of the heatsinks. Each channel is held into the tray by 2 countersunk screws that attach to the heatsink on the underside. Hold the channel that is now uppermost (to prevent it from falling once it has been freed) and remove the two screws from this channel only. Lie the LK2 down (correct way up) and remove the channel that you have just loosened – this can sometimes be tricky so follow these instructions:
  - Pull the board slightly toward the front of the unit until the 3-pin cannon input socket at the rear is clear of the back panel – it may sometimes be necessary to push the back panel slightly in the opposite direction until the socket is completely clear.
  - Lift the end of the board containing the 3-pin cannon socket upwards (see picture) until that end of the board is clear of the tray. Some delicate manoeuvring may be necessary, but don't force it.

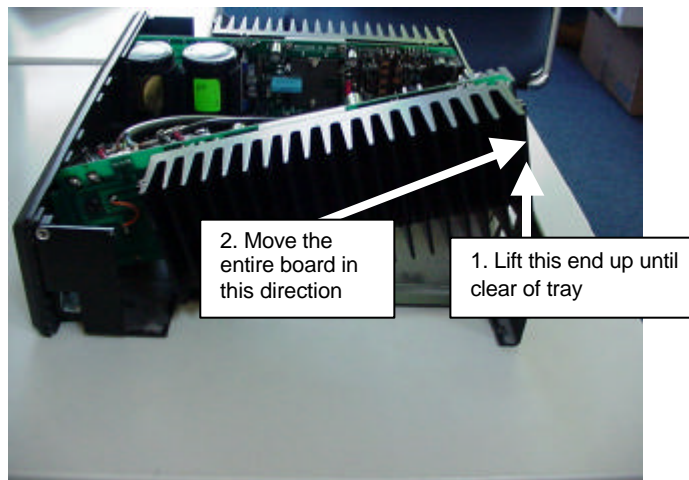

- By carefully moving the board backwards & upwards, it should now be possible to lift it up and out of the tray.
- Repeat the above instruction for the other channel



**Step 2. Remove the heatsinks from the boards**

1. Using the 5.5mm spanner or nut-runner, loosen the single nut/bolt found beside the 3-pin cannon socket (see picture below) – do not remove the nut completely, but loosen it to the point where only a very small amount of the bolt is protruding from one side of the nut.
2. The board is now held on to the heatsink by 4 allen screws or 4 nuts/bolts (see picture below).
  - If nuts/bolts are fitted, loosen them but do not remove them (as with single bolt above), pull the board upwards until there is a gap between the board and the heatsink and then slide the board to one side. If the board will not move easily, check that you have loosened all 5 nuts/bolts. If all are loosened correctly and it is still not free, the board may be held on by the heatsink compound and will require some slight pressure to free it.
  - If the board is held on by allen screws, completely remove all 4 screws, lift the board away from the heatsink and slide the single bolt beside the cannon socket sideways to free the board.

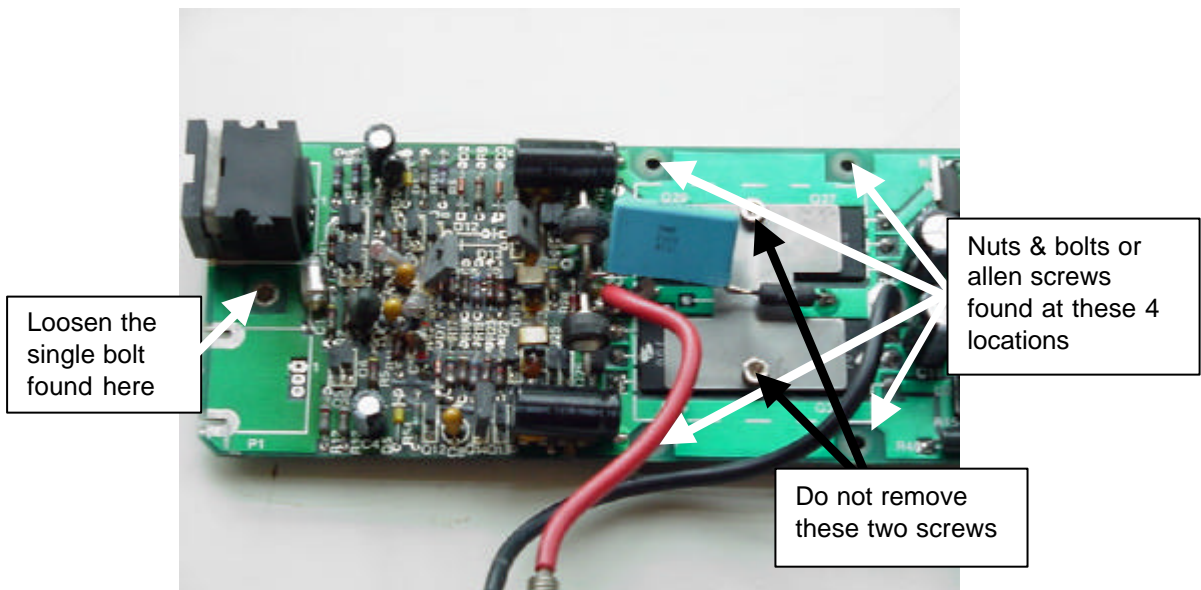

3. Use a tissue or paper towel to clean the heatsink compound from the board and from the heatsink (if you don't, you will find out very quickly that heatsink compound has a knack of ending up all over your clothes, hands, face etc)



**Step 3. Carry out the modification**

1. Locate the components as listed in the table below and replace with the values shown (see pictures below for location of these components). Do this for both channels.

**Please note – R49** – depending on what size of part you have purchased, it may be too big for the space available. If so, the part can be inserted to stand up as shown below.

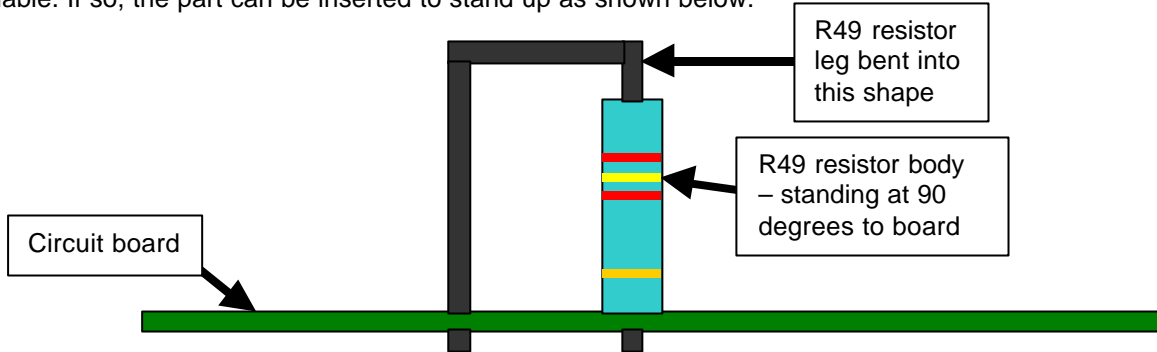

**Please note – R33** is located underneath one of the big capacitors C16 (see picture below). The capacitor holder must be removed from the board to access the resistor. Turn the board upside down and you will see that the capacitor holder is held by two nuts/bolts. Remove the two nuts and the capacitor will come away from the board – but be careful, as it will still be held by a pair of wires. If the nuts/bolts keep spinning instead of coming loose, insert a medium sized flat-blade screwdriver under the capacitor and press it against the head of the bolt while turning the nut – this usually provides enough grip to hold the bolt so that the nut comes free.

Component	Replace with:
R33	20Kohm, 2.5Watt resistor
R49	2.4Kohm, 2.5Watt resistor
C6	68pF 160V Polystyrene capacitor
C19	220pF 160V Polystyrene capacitor

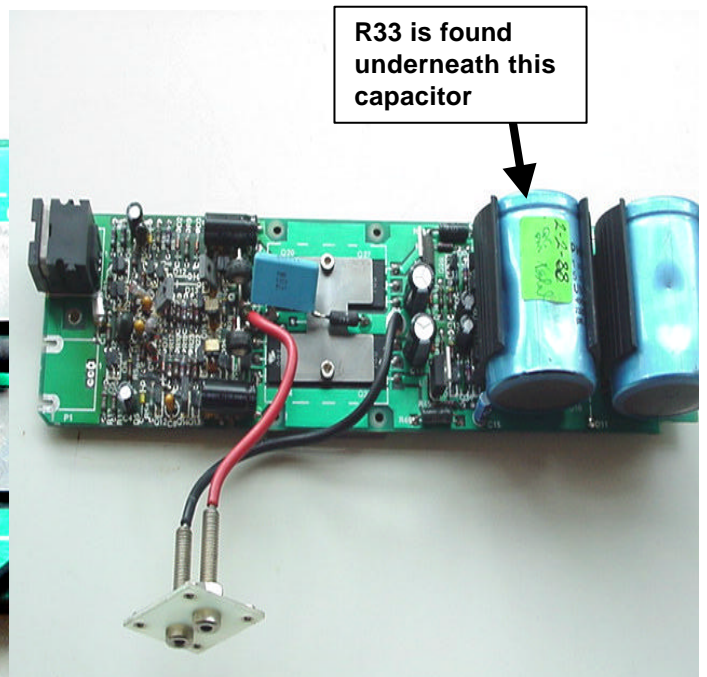
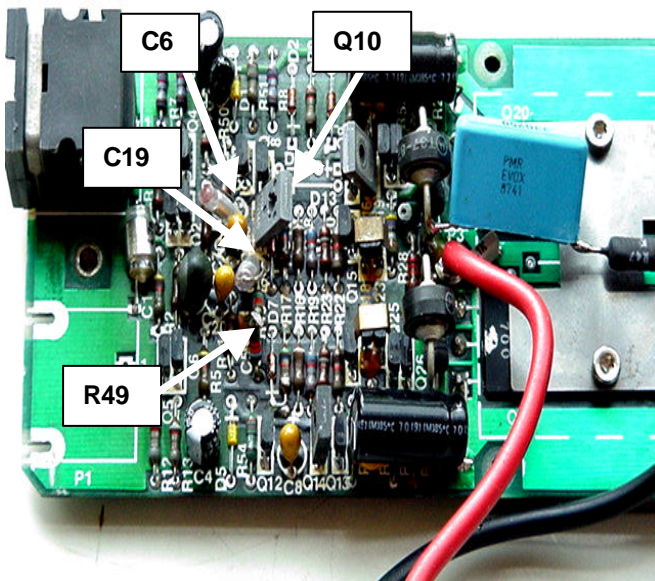

R33 is found underneath this capacitor

2. In order to prevent the two polystyrene capacitors that you have just replaced from failing at a later date, make the following small adjustments to the position of some components:
- Bend Q10 away from C6 (towards the middle of the board). As shown in picture above
  - Bend C6 away from Q10 (towards the 3-pin cannon socket). As shown in picture above
  - Bend C19 away from Q10 towards R49 but **do not** bend it too close to R49 – position it so that it is about half way between Q10 and R49. As shown in picture above

These steps are advised because Q10 and R49 get quite hot and can sometimes melt the polystyrene capacitors (over a period of many years). Positioning the components as above minimises the effect of this heat and prolongs the life of the capacitors.



**3. Step 4. Re-assemble the LK2**

1. Re-attach the capacitor C16 that you removed to access R33. Use a medium sized flat-bladed screwdriver to hold the head of the bolt while you screw the nut back into place. Ensure nuts are tight as, if they come loose later, they may short out the circuitry while the unit is powered up and cause major damage.
2. Re-attach the heatsink:  
Apply heatsink compound in a single line along the centre of the coupling block as shown below

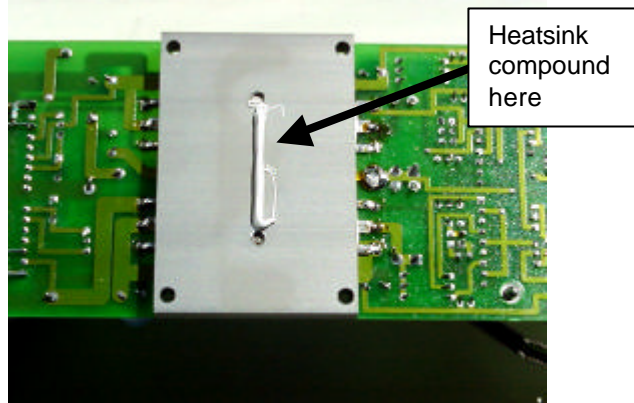

If board was attached to heatsink by nuts & bolts – follow the instructions below:

- Remove all five bolts from the board and slide the bolts into the slots, arranged as shown below

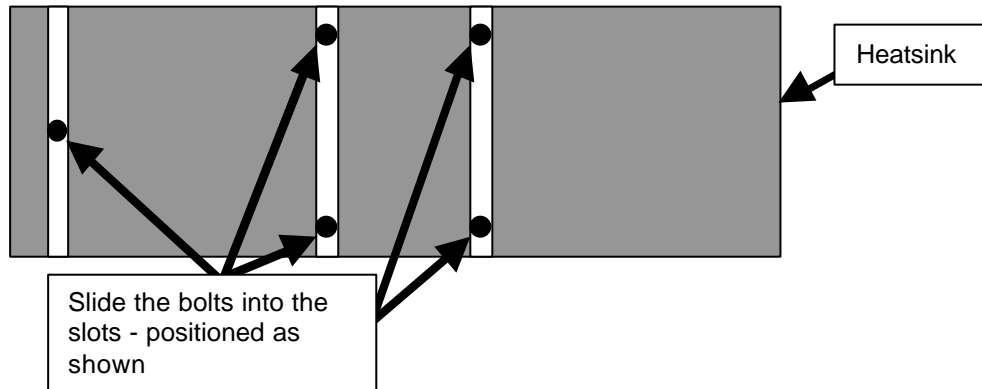

- Place the board onto the heatsink so that all the bolts pass through their respective holes on the board (some readjustment is usually necessary).
- Screw the nuts onto the bolts but do not tighten fully.
- Adjust the position of the board with respect to the heatsink so that the two are matched up – i.e. the two are parallel with each other and neither the board nor the heatsink are protruding at either side (see pictures below – exaggerated to show problems clearly)

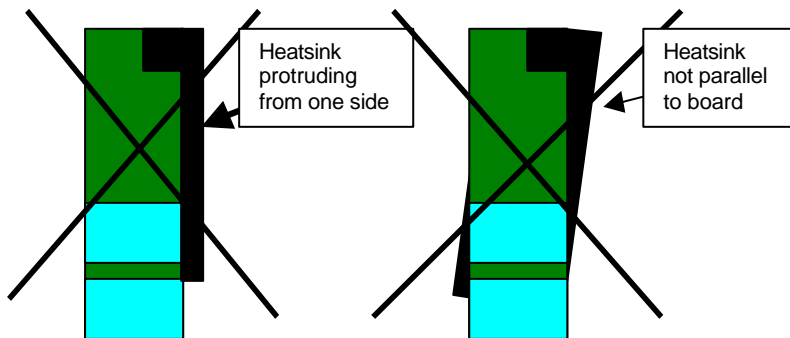



- Once heatsink and board are matched up, tighten bolts.

If heatsink was attached with allen screws:

- Slide the single nut/bolt (still attached to board) into the middle of its slot – do not tighten
- Rest the board on the heatsink in a central position.
- Line up the screw holes in the board with those in the heatsink and screw in all four screws – but do not tighten fully.
- Line up the board and heatsink so that they are parallel and level with each other (as diagrams above) and then tighten the screws fully.
- Tighten the nut/bolt

3. Refit boards into tray – just do the reverse of the dismantling process described at the start of this document.
4. Refit sleeve
5. Test amp fully





**LINN**  
*the only sound<sup>®</sup>*

## Linn Parts List (Bill of Materials) for PCAS 003

### Amplifier Board for LK2 (60) & LK275 Power Amps

**Please note** that this list is provided for guidance only. Linn Products cannot guarantee the accuracy of the information contained in the list and will not be held responsible for any errors that occur as a result of its use. Please double check that the details listed match the component that you are replacing.

#### How to follow a Bill of Materials (BOM)

The BOM may, at first glance seem quite confusing. Once a few things are explained however, you should have no problems following it.

The main part of this document, i.e. the table, is split into nine columns as shown in the example below:

Quantity	Units	T	C.Des	Part Number	Description	Type	Kit	Cost
-----	-----	-	-----	-----	-----	-----	-----	-----
1.00000	ONES	R	C001	CAP 003	22UF,+50%,-20%,50V,ELTR,TH,PCO100, ,,,,,NCC,,RUBYCON,,MULLARD	C	Y	Y

**Ignore all columns except for the middle three – these contain all the information you require as explained below:**

#### C.Des (Component Designator)

Every component on every Linn circuit board has an individual identification code known as a 'Component Designator' (C001, Q012, R345 etc). The designator shown in the table matches that printed on the circuit board beside each component.

These designators are coded according to type of component – at the start of each designator there is a letter and this describes the component type. The main types are shown below:

- C - Capacitor
- P - Connector
- Q - Transistor
- R - Resistor
- U - IC

**The components are listed in alphabetical order by Component Designator**

#### Part Number

Our internal part number for the component. Quote this part number if ordering the part from Linn.

We advise however that you try to source parts locally as most components are commonly available from any good electronic parts supplier much faster and cheaper than we can supply and also, not every part listed here can be ordered from Linn. If you have problems finding the part locally, we will do our best to help you, but we cannot guarantee availability of any part listed.

#### Description

All the technical details that you will require to order the part from your local or national electronic spares supplier. Includes (if applicable) the name(s) of our preferred manufacturer(s) for each part.



Assembly Number: PCAS 003

POWER AMPLIFIER PCB ASSEMBLY  
\*OBSOLETE PART\*

Units: ONES BOM Type: C

Quantity	Units	T C.Des	Part Number	Description	Type	Kit	Cost
1.00000	ONES	R C001	CAP 035	4N7F,+2%,-2%,63V,PST,TH,CO400,,,,,C *****	C	N	Y
** Warning - Part OBSOLETE on 09-JAN-1995							
1.00000	ONES	R C002	CAP 034	100UF,+20%,-20%,10V,TANT,TH, PCO200,,,,,,STC TAG,,THOMSON,,	C	N	Y
1.00000	ONES	R C003	CAP 003	22UF,+50%,-20%,50V,ELTR,TH,PCO100,C ,,,,,NCC,,RUBYCON,,MULLARD	C	N	Y
1.00000	ONES	R C004	CAP 003	22UF,+50%,-20%,50V,ELTR,TH,PCO100,C ,,,,,NCC,,RUBYCON,,MULLARD	C	N	Y
1.00000	ONES	R C005	CAP 099	1NF,+10%,-10%,63V,CERA,SM,CC0805,,C *****	C	N	Y
** Warning - Part OBSOLETE on 27-APR-1989							
1.00000	ONES	R C006	CAP 039	68PF,+2%,-2%,160V,PST,TH,CO100,,,,C *****	C	N	Y
1.00000	ONES	R C007	NO INFO	33UF,+20%,-20%,10V,TANT,TH,PCO200,C ,,,,,STC TAG,,THOMSON	C	N	Y
NO LINN PART NUMBER EXISTS FOR THIS PART							
1.00000	ONES	R C008	NO INFO	33UF,+10%,-10%,63V,PEST,TH,PCO200,C ,,,,,STC TAG,,THOMSON	C	N	Y
NO LINN PART NUMBER EXISTS FOR THIS PART							
1.00000	ONES	R C009	CAP 068	100NF,+10%,-10%,63V,PEST,TH,CO200,C *****	C	N	Y
1.00000	ONES	R C010	CAP 020	100UF,+20%,-20%,63V,ELTR,TH, PCO200,,,,,,ECC,,RUBYCON,,	C	N	Y
** Warning - Part OBSOLETE on 29-OCT-1999							
1.00000	ONES	R C011	CAP 020	100UF,+20%,-20%,63V,ELTR,TH, PCO200,,,,,,ECC,,RUBYCON,,	C	N	Y
** Warning - Part OBSOLETE on 29-OCT-1999							
1.00000	ONES	R C012	CAP 003	22UF,+50%,-20%,50V,ELTR,TH,PCO100,C ,,,,,NCC,,RUBYCON,,MULLARD	C	N	Y
1.00000	ONES	R C013	CAP 003	22UF,+50%,-20%,50V,ELTR,TH,PCO100,C ,,,,,NCC,,RUBYCON,,MULLARD	C	N	Y
1.00000	ONES	R C014	CAP 022	6U8F,+10%,-10%,63V,ELTR,TH,PCO100,C *****	C	N	Y
1.00000	ONES	R C015	CAP 022	6U8F,+10%,-10%,63V,ELTR,TH,PCO100,C *****	C	N	Y
1.00000	ONES	R C016	CAP 085	10000UF,+20%,-20%,64V,ELTR,TH, PCO400,,,,,,BHC,,,,	C	N	Y
1.00000	ONES	R C017	CAP 085	10000UF,+20%,-20%,64V,ELTR,TH, PCO400,,,,,,BHC,,,,	C	N	Y
1.00000	ONES	R C018	CAP 037	470PF,+2%,-2%,160V,PST,TH,CO900,,,C *****	C	N	Y
** Warning - Part OBSOLETE on 28-MAR-1990							
1.00000	ONES	R C019	CAP 038	220PF,+2%,-2%,160V,PST,TH,CO100,,,C *****	C	N	Y



Assembly Number: PCAS 003

POWER AMPLIFIER PCB ASSEMBLY  
\*OBSOLETE PART\*

Units: ONES BOM Type: C

Quantity	Units	T C.Des	Part Number	Description	Type	Kit	Cost
1.00000	ONES	R C020	CAP 033	22UF,+20%,-20%,10V,TANT,TH,PCO200, ,,,,,STC TAG,,THOMSON,,	C	N	Y
1.00000	ONES	R C021	CAP 250	330NF,+5%,-5%,250V,PPR,TH,CO900,, ,,,,,EVOX,,ARCOTRONIC,,	C	N	Y
1.00000	ONES	R C022	CAP 020	100UF,+20%,-20%,63V,ELTR,TH, PCO200,,,,,,ECC,,RUBYCON,,	C	N	Y
** Warning -	Part OBSOLETE on		29-OCT-1999				
1.00000	ONES	R C023	CAP 020	100UF,+20%,-20%,63V,ELTR,TH, PCO200,,,,,,ECC,,RUBYCON,,	C	N	Y
** Warning -	Part OBSOLETE on		29-OCT-1999				
1.00000	ONES	R D001	MISS 009	4.7V ZENER OBSOLETE PART	C	N	Y
** Warning -	Part OBSOLETE on		29-MAR-1990				
1.00000	ONES	R D002	MISS 001	TYPE FUNCTION CASE 1N4148 DIODE	C	N	Y
1.00000	ONES	R D003	MISS 001	TYPE FUNCTION CASE 1N4148 DIODE	C	N	Y
1.00000	ONES	R D004	MISS 001	TYPE FUNCTION CASE 1N4148 DIODE	C	N	Y
1.00000	ONES	R D005	MISS 009	4.7V ZENER OBSOLETE PART	C	N	Y
** Warning -	Part OBSOLETE on		29-MAR-1990				
1.00000	ONES	R D006	MISS 001	TYPE FUNCTION CASE 1N4148 DIODE	C	N	Y
1.00000	ONES	R D007	MISS 001	TYPE FUNCTION CASE 1N4148 DIODE	C	N	Y
1.00000	ONES	R D008	MISS 010	TYPE FUNCTION GENERAL INFO MR752 6A 200V RECTIFIER	C	N	Y
1.00000	ONES	R D009	MISS 010	TYPE FUNCTION GENERAL INFO MR752 6A 200V RECTIFIER	C	N	Y
1.00000	ONES	R D010	MISS 010	TYPE FUNCTION GENERAL INFO MR752 6A 200V RECTIFIER	C	N	Y
1.00000	ONES	R D011	MISS 010	TYPE FUNCTION GENERAL INFO MR752 6A 200V RECTIFIER	C	N	Y
1.00000	ONES	R D012	MISS 010	TYPE FUNCTION GENERAL INFO MR752 6A 200V RECTIFIER	C	N	Y
1.00000	ONES	R D013	MISS 010	TYPE FUNCTION GENERAL INFO MR752 6A 200V RECTIFIER	C	N	Y



Assembly Number: PCAS 003

POWER AMPLIFIER PCB ASSEMBLY  
\*OBSOLETE PART\*

Units: ONES BOM Type: C

Quantity	Units	T C.Des	Part Number	Description	Type	Kit	Cost
1.00000	ONES	R D014	MISS 001	TYPE FUNCTION CASE 1N4148 DIODE	C	N	Y
1.00000	ONES	R D015	MISS 001	TYPE FUNCTION CASE 1N4148 DIODE	C	N	Y
1.00000	ONES	R D016	MISS 014	POWER AMP MAINS INDICATOR LED	C	N	Y
** Warning - Part OBSOLETE on 07-SEP-1992							
1.00000	ONES	R Q001	TRAN 001	ZTX653,NPN,100V,2A,ELINE,653, ZETEX,	C	N	Y
1.00000	ONES	R Q002	TRAN 001	ZTX653,NPN,100V,2A,ELINE,653, ZETEX,	C	N	Y
1.00000	ONES	R Q003	TRAN 002	ZTX753,PNP,100V,2A,ELINE,753, ZETEX,	C	N	Y
1.00000	ONES	R Q004	TRAN 002	ZTX753,PNP,100V,2A,ELINE,753, ZETEX,	C	N	Y
1.00000	ONES	R Q005	TRAN 001	ZTX653,NPN,100V,2A,ELINE,653, ZETEX,	C	N	Y
1.00000	ONES	R Q006	TRAN 001	ZTX653,NPN,100V,2A,ELINE,653, ZETEX,	C	N	Y
1.00000	ONES	R Q007	TRAN 002	ZTX753,PNP,100V,2A,ELINE,753, ZETEX,	C	N	Y
1.00000	ONES	R Q008	TRAN 002	ZTX753,PNP,100V,2A,ELINE,753, ZETEX,	C	N	Y
1.00000	ONES	R Q009	TRAN 002	ZTX753,PNP,100V,2A,ELINE,753, ZETEX,	C	N	Y
1.00000	ONES	R Q010	TRAN 007	BD140,PNP,80V,1.5A,TO126,140, MOTOR,	C	N	Y
** Warning - Part OBSOLETE on 30-OCT-1996							
1.00000	ONES	R Q011	TRAN 007	BD140,PNP,80V,1.5A,TO126,140, MOTOR,	C	N	Y
** Warning - Part OBSOLETE on 30-OCT-1996							
1.00000	ONES	R Q012	TRAN 001	ZTX653,NPN,100V,2A,ELINE,653, ZETEX,	C	N	Y
1.00000	ONES	R Q013	TRAN 001	ZTX653,NPN,100V,2A,ELINE,653, ZETEX,	C	N	Y
1.00000	ONES	R Q014	TRAN 006	BD139,NPN,80V,1.5A,TO126,139, MOTOR,	C	N	Y
** Warning - Part OBSOLETE on 30-OCT-1996							



Assembly Number: PCAS 003

POWER AMPLIFIER PCB ASSEMBLY

\*OBSOLETE PART\*

Units: ONES BOM Type: C

Quantity	Units	T C.Des	Part Number	Description	Type	Kit	Cost
1.00000	ONES	R Q015	TRAN 002	ZTX753,PNP,100V,2A,ELINE,753, ZETEX,	C	N	Y
1.00000	ONES	R Q016	TRAN 001	ZTX653,NPN,100V,2A,ELINE,653, ZETEX,	C	N	Y
1.00000	ONES	R Q017	TRAN 001	ZTX653,NPN,100V,2A,ELINE,653, ZETEX,	C	N	Y
1.00000	ONES	R Q018	TRAN 002	ZTX753,PNP,100V,2A,ELINE,753, ZETEX,	C	N	Y
1.00000	ONES	R Q019	TRAN 001	ZTX653,NPN,100V,2A,ELINE,653, ZETEX,	C	N	Y
1.00000	ONES	R Q020	TRAN 017	2SA1386,PNP,160V,15A,MT100,1386, SANKEN,	C	N	Y
1.00000	ONES	R Q021	TRAN 002	ZTX753,PNP,100V,2A,ELINE,753, ZETEX,	C	N	Y
1.00000	ONES	R Q022	TRAN 002	ZTX753,PNP,100V,2A,ELINE,753, ZETEX,	C	N	Y
1.00000	ONES	R Q023	TRAN 002	ZTX753,PNP,100V,2A,ELINE,753, ZETEX,	C	N	Y
1.00000	ONES	R Q024	TRAN 018	2SC3519,NPN,160V,15A,MT100,3519, SANKEN,	C	N	Y
1.00000	ONES	R Q025	TRAN 001	ZTX653,NPN,100V,2A,ELINE,653, ZETEX,	C	N	Y
1.00000	ONES	R Q026	TRAN 001	ZTX653,NPN,100V,2A,ELINE,653, ZETEX,	C	N	Y
1.00000	ONES	R Q027	TRAN 017	2SA1386,PNP,160V,15A,MT100,1386, SANKEN,	C	N	Y
1.00000	ONES	R Q028	TRAN 002	ZTX753,PNP,100V,2A,ELINE,753, ZETEX,	C	N	Y
1.00000	ONES	R Q029	TRAN 002	ZTX753,PNP,100V,2A,ELINE,753, ZETEX,	C	N	Y
1.00000	ONES	R Q030	TRAN 010	TYPE POLARITY MPS A93 PNP OBSOLETE	C	N	Y
** Warning -	Part	OBSOLETE	on	13-MAR-1990			
1.00000	ONES	R Q031	TRAN 018	2SC3519,NPN,160V,15A,MT100,3519, SANKEN,	C	N	Y



Assembly Number: PCAS 003

POWER AMPLIFIER PCB ASSEMBLY  
\*OBSOLETE PART\*

Units: ONES BOM Type: C

Quantity	Units	T C.Des	Part Number	Description	Type	Kit	Cost
1.00000	ONES	R Q032	TRAN 001	ZTX653,NPN,100V,2A,ELINE,653, ZETEX,	C	N	Y
1.00000	ONES	R Q033	TRAN 001	ZTX653,NPN,100V,2A,ELINE,653, ZETEX,	C	N	Y
1.00000	ONES	R Q034	TRAN 009	TYPE POLARITY MPS A43 NPN OBSOLETE	C	N	Y
** Warning - Part OBSOLETE on 13-MAR-1990							
1.00000	ONES	R R001	RES 029	1K,1%,MF,1/4W,0.25W,200V,50ppm,, ,	C	N	Y
1.00000	ONES	R R002	RES 017	4K7,1%,MF,1/4W,0.25W,200V,50ppm,, ,	C	N	Y
1.00000	ONES	R R003	RES 021	100R,1%,MF,1/4W,0.25W,200V,50ppm,, ,	C	N	Y
1.00000	ONES	R R004	RES 078	4K3,1%,MF,1/4W,0.25W,200V,50ppm,, ,	C	N	Y
1.00000	ONES	R R005	RES 017	4K7,1%,MF,1/4W,0.25W,200V,50ppm,, ,	C	N	Y
1.00000	ONES	R R006	RES 030	120R,1%,MF,1/4W,0.25W,200V,50ppm,, ,	C	N	Y
1.00000	ONES	R R007	RES 030	120R,1%,MF,1/4W,0.25W,200V,50ppm,, ,	C	N	Y
1.00000	ONES	R R008	RES 030	120R,1%,MF,1/4W,0.25W,200V,50ppm,, ,	C	N	Y
1.00000	ONES	R R009	RES 001	220R,1%,MF,1/4W,0.25W,200V,50ppm,, ,	C	N	Y
1.00000	ONES	R R010	RES 001	220R,1%,MF,1/4W,0.25W,200V,50ppm,, ,	C	N	Y
1.00000	ONES	R R011	RES 078	4K3,1%,MF,1/4W,0.25W,200V,50ppm,, ,	C	N	Y
1.00000	ONES	R R012	RES 022	820R,1%,MF,1/4W,0.25W,200V,50ppm,, ,	C	N	Y
1.00000	ONES	R R013	RES 022	820R,1%,MF,1/4W,0.25W,200V,50ppm,, ,	C	N	Y
1.00000	ONES	R R014	RES 023	910R,1%,MF,1/4W,0.25W,200V,50ppm,, ,	C	N	Y



Assembly Number: PCAS 003

POWER AMPLIFIER PCB ASSEMBLY  
\*OBSOLETE PART\*

Units: ONES BOM Type: C

Quantity	Units	T C.Des	Part Number	Description	Type	Kit	Cost
1.00000	ONES	R R015	RES 041	5K6,1%,MF,1/4W,0.25W,200V,50ppm,, ,	C	N	Y
1.00000	ONES	R R016	RES 023	910R,1%,MF,1/4W,0.25W,200V,50ppm,, ,	C	N	Y
1.00000	ONES	R R017	RES 041	5K6,1%,MF,1/4W,0.25W,200V,50ppm,, ,	C	N	Y
1.00000	ONES	R R018	RES 042	620R,1%,MF,1/4W,0.25W,200V,50ppm,, ,	C	N	Y
1.00000	ONES	R R019	RES 042	620R,1%,MF,1/4W,0.25W,200V,50ppm,, ,	C	N	Y
1.00000	ONES	R R020	RES 043	180R,1%,MF,1/4W,0.25W,200V,50ppm,, ,	C	N	Y
1.00000	ONES	R R021	RES 035	1K1,1%,MF,1/4W,0.25W,200V,50ppm,, ,	C	N	Y
1.00000	ONES	R R022	RES 035	1K1,1%,MF,1/4W,0.25W,200V,50ppm,, ,	C	N	Y
1.00000	ONES	R R023	RES 043	180R,1%,MF,1/4W,0.25W,200V,50ppm,, ,	C	N	Y
1.00000	ONES	R R024	RES 082	4R7,1%,MF,1/4W,0.25W,200V,50ppm,, ,	C	N	Y
1.00000	ONES	R R025	RES 133	4R7,5%,WWC,XX,4W,999V,999ppm,, ,	C	N	Y
1.00000	ONES	R R026	RES 133	4R7,5%,WWC,XX,4W,999V,999ppm,, ,	C	N	Y
1.00000	ONES	R R027	RES 048	12R,1%,MF,1/4W,0.25W,200V,50ppm,, ,	C	N	Y
1.00000	ONES	R R028	RES 025	22K,1%,MF,1/4W,0.25W,200V,50ppm,, ,	C	N	Y
1.00000	ONES	R R029	RES 047	0R47,10%,WWE,W21,2.5W,100V,75ppm,, ,	C	N	Y
1.00000	ONES	R R030	RES 009	27R,1%,MF,1/4W,0.25W,200V,50ppm,, ,	C	N	Y
1.00000	ONES	R R031	RES 002	150R,1%,MF,1/4W,0.25W,200V,50ppm,, ,	C	N	Y





Assembly Number: PCAS 003

POWER AMPLIFIER PCB ASSEMBLY  
\*OBSOLETE PART\*

Units: ONES BOM Type: C

Quantity	Units	T C.Des	Part Number	Description	Type	Kit	Cost
-----	-----	-----	-----	-----	-----	-----	-----
1.00000	ONES	R R032	RES 017	4K7,1%,MF,1/4W,0.25W,200V,50ppm,,	C	N	Y
1.00000	ONES	R R033	NO INFO	20K,1%,MF,2.5W, 200V,50ppm,,	C	N	Y
NOTE-ORIGINAL PART FOR R033 WAS RES 045 - HAD INSUFFICIENT POWER RATING - USE MINIMUM 1WATT PART							
1.00000	ONES	R R034	RES 033	6K2,1%,MF,1/4W,0.25W,200V,50ppm,,	C	N	Y
1.00000	ONES	R R035	RES 013	180K,1%,MF,1/4W,0.25W,200V,50ppm,,	C	N	Y
1.00000	ONES	R R036	RES 050	0R1,10%,WWE,W21,2.5W,100V,75ppm,,	C	N	Y
1.00000	ONES	R R037	RES 038	2K2,1%,MF,1/4W,0.25W,200V,50ppm,,	C	N	Y
1.00000	ONES	R R039	RES 058	33K,1%,MF,1/4W,0.25W,200V,50ppm,,	C	N	Y
1.00000	ONES	R R040	RES 017	4K7,1%,MF,1/4W,0.25W,200V,50ppm,,	C	N	Y
1.00000	ONES	R R041	RES 002	150R,1%,MF,1/4W,0.25W,200V,50ppm,,	C	N	Y
1.00000	ONES	R R042	RES 009	27R,1%,MF,1/4W,0.25W,200V,50ppm,,	C	N	Y
1.00000	ONES	R R043	RES 033	6K2,1%,MF,1/4W,0.25W,200V,50ppm,,	C	N	Y
1.00000	ONES	R R044	RES 013	180K,1%,MF,1/4W,0.25W,200V,50ppm,,	C	N	Y
1.00000	ONES	R R045	RES 038	2K2,1%,MF,1/4W,0.25W,200V,50ppm,,	C	N	Y
1.00000	ONES	R R046	RES 050	0R1,10%,WWE,W21,2.5W,100V,75ppm,,	C	N	Y
1.00000	ONES	R R048	RES 058	33K,1%,MF,1/4W,0.25W,200V,50ppm,,	C	N	Y
1.00000	ONES	R R049	NO INFO	2.4K,10%,WWE,W21,2.5W,100V,75ppm,,	C	N	Y
NOTE - ORIGINAL PART WAS 0.25W - HAD INSUFFICIENT POWER RATING. USE MINIMUM 2.5W PART							
1.00000	ONES	R R050	RES 078	4K3,1%,MF,1/4W,0.25W,200V,50ppm,,	C	N	Y
1.00000	ONES	R R051	RES 063	18R,1%,MF,1/4W,0.25W,200V,50ppm,,	C	N	Y



Assembly Number: PCAS 003

POWER AMPLIFIER PCB ASSEMBLY

\*OBSOLETE PART\*

Units: ONES BOM Type: C

Quantity	Units	T C.Des	Part Number	Description	Type	Kit	Cost
1.00000	ONES	R R052	RES 048	12R,1%,MF,1/4W,0.25W,200V,50ppm,, ,	C	N	Y
1.00000	ONES	R R053	RES 009	27R,1%,MF,1/4W,0.25W,200V,50ppm,, ,	C	N	Y
1.00000	ONES	R R055	RES 009	27R,1%,MF,1/4W,0.25W,200V,50ppm,, ,	C	N	Y
1.00000	ONES	R R056	RES 048	12R,1%,MF,1/4W,0.25W,200V,50ppm,, ,	C	N	Y
1.00000	ONES	R R057	RES 009	27R,1%,MF,1/4W,0.25W,200V,50ppm,, ,	C	N	Y
1.00000	ONES	R R059	RES 018	15K,1%,MF,1/4W,0.25W,200V,50ppm,, ,	C	N	Y
1.00000	ONES	R U001	IC 005	LM317T,VOLTAGE REGULATOR,TO220, 317T,NATSEM,	C	N	Y
1.00000	ONES	R U002	IC 006	LM337T,VOLTAGE REGULATOR,TO220, 337T,NATSEM,THOM	C	N	Y



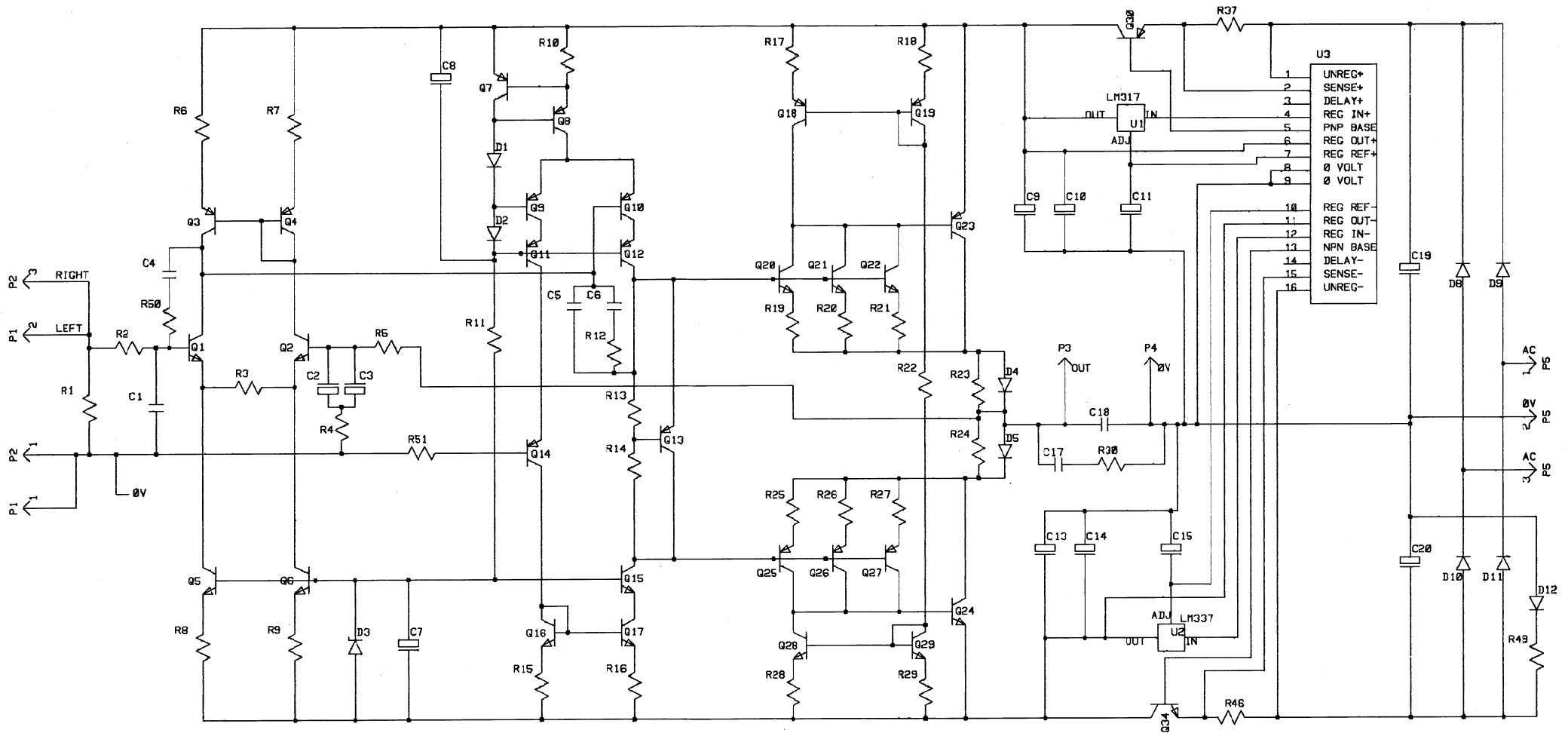

— UP TO R51      — MISSING REFS  
 — UPTO C20      — NONE  
 — UP TO D12  
 — UP TO Q37  
 — UP TO P5

CONTRACT		FIRM NAME		
DR	/ /	PCAS 020/L1R		
CHK	/ /			
ENG	/ /			
APPD	/ /	SIZE	FSCM NO.	DWG NO.
NEXT HIGHER ASSY.	-	D	-	-
09:08:44	8-Oct-83	PCAS020		SHEET X