

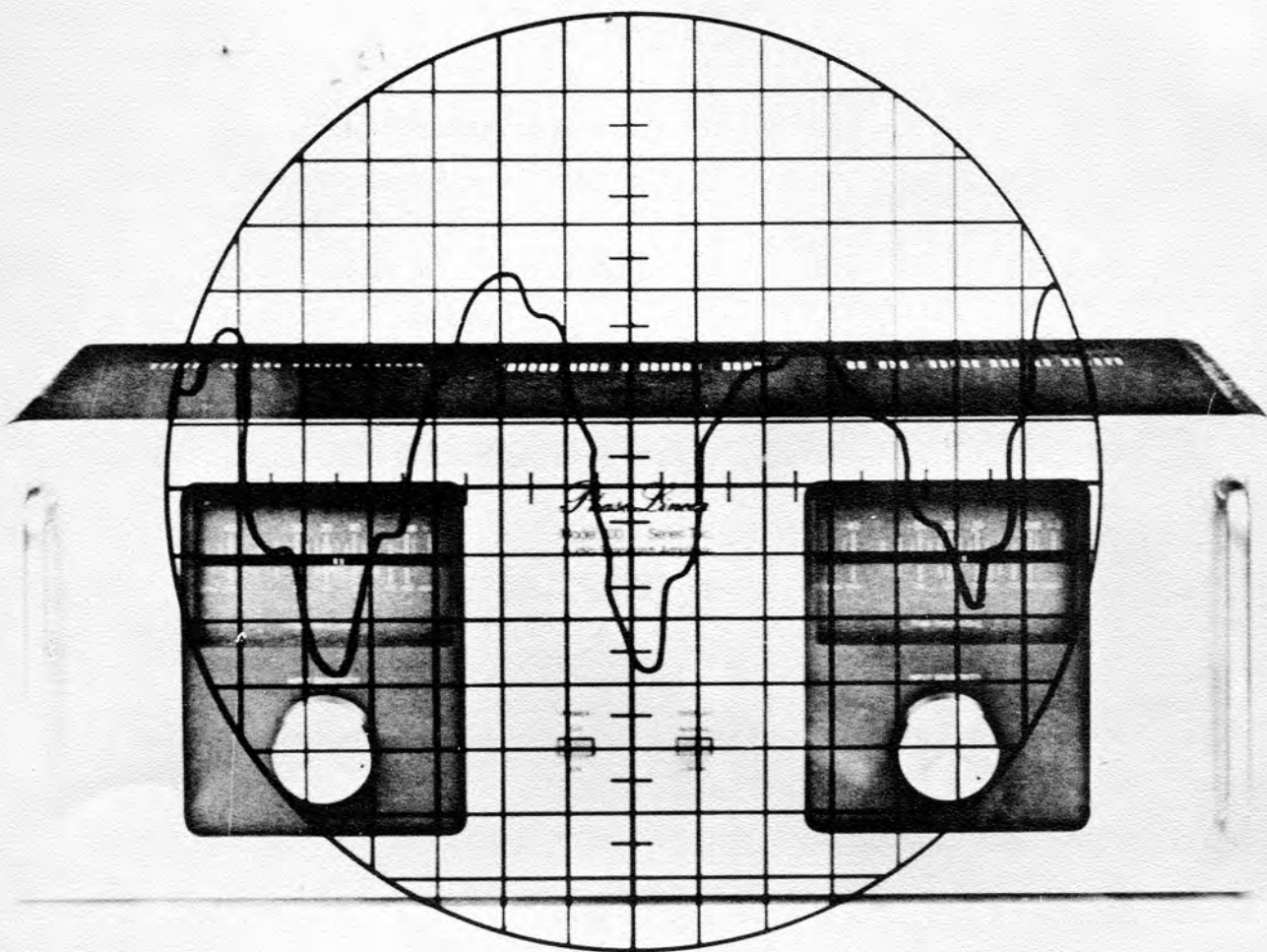

For more Hi-Fi manuals and set-up information
please visit www.hifiengine.com

700 SERIES TWO POWER AMPLIFIER

Service Manual



Phase Linear.
THE POWERFUL DIFFERENCE

700 SERIES TWO POWER AMPLIFIER

SERVICE MANUAL

CONTENTS

1-0. Technical Specifications	4
2-0. Schematics and Diagrams	5
3-0. Circuit Descriptions	12
4-0. Disassembly Procedure	14
5-0. Test Procedure	17
6-0. Troubleshooting Guide	19
7-0. Parts List	25
8-0. Service Bulletins and Supplements	26

*****CAUTION*****

THIS MANUAL IS INTENDED FOR USE ONLY BY QUALIFIED TECHNICAL SERVICE PERSONNEL. HAZARDOUS VOLTAGES MAY BE ENCOUNTERED IN THE TEST AND SERVICING OF THE 700 SERIES TWO. USE EXTREME CAUTION: READ ALL INSTRUCTIONS CAREFULLY.

1-0. Technical Specifications

POWER OUTPUT: 360 watts minimum RMS per channel into 8 ohms from 20 Hz to 20K Hz with no more than 0.09% Total Harmonic Distortion.

CONTINUOUS POWER: 450 watts per channel into 8 ohms @ 1000 Hz; 550 watts per channel into 4 ohms @ 1000 Hz.

TYPICAL TOTAL HARMONIC DISTORTION: 0.009% @ rated power output into 8 ohms @ 1000 Hz; 0.09% @ rated power output into 4 ohms @ 1000 Hz.

INTERMODULATION DISTORTION: (60 Hz: 7K Hz = 4 : 1) less than 0.09% at rated power output into 8 ohms; less than 0.09% at rated power output into 4 ohms.

FREQUENCY RESPONSE: 12 Hz to 40K Hz, +0-1 dB.

SIGNAL-TO-NOISE RATIO: 110 dB (IHF "A"-weighted).

RESIDUAL NOISE: 120 microvolts (IHF "A"-weighted).

DAMPING FACTOR: 1000 : 1 @ 1000 Hz.

INPUT IMPEDANCE: 33K ohms minimum.

SPEAKER IMPEDANCE: Will accept 4 ohm or greater speaker load.

SLEW RATE: Better than 18 volts/microsecond.

RISE TIME: (Small signal) less than 4.0 microseconds.

PHASE SHIFT: 0 degrees at 20 Hz; lagging 18 degrees at 20K Hz.

POWER REQUIREMENTS: 120 volt AC, 60 Hz (USA and Canadian models) or 100-120 volt/220-240 volt AC, 50/60 Hz.

POWER CONSUMPTION: 1200 watts (10 amps) maximum at rated power output.

DIMENSIONS: 19"w X 7"h X 10"d (48.3cm X 17.8cm X 25.4cm)

WEIGHT GROSS: 45 lbs. (20kg)

2-0. Schematics and Diagrams

- 2-1. Schematic: PL36, Main PCB
- 2-2. Layout: PL36, Main PCB
- 2-3. X-ray view and wiring diagram, PL36.
- 2-4. Schematic: PL37, Display PCB
- 2-5. Layout: PL37, Display PCB
- 2-6. X-ray view of PL37
- 2-7. Interconnect schematic

DESIGN	DATE	BY	CHKD	APPROVED
REV. 1	12/24/77	TIN	P-3-A	
CORRECTIONS PER AUDIT				

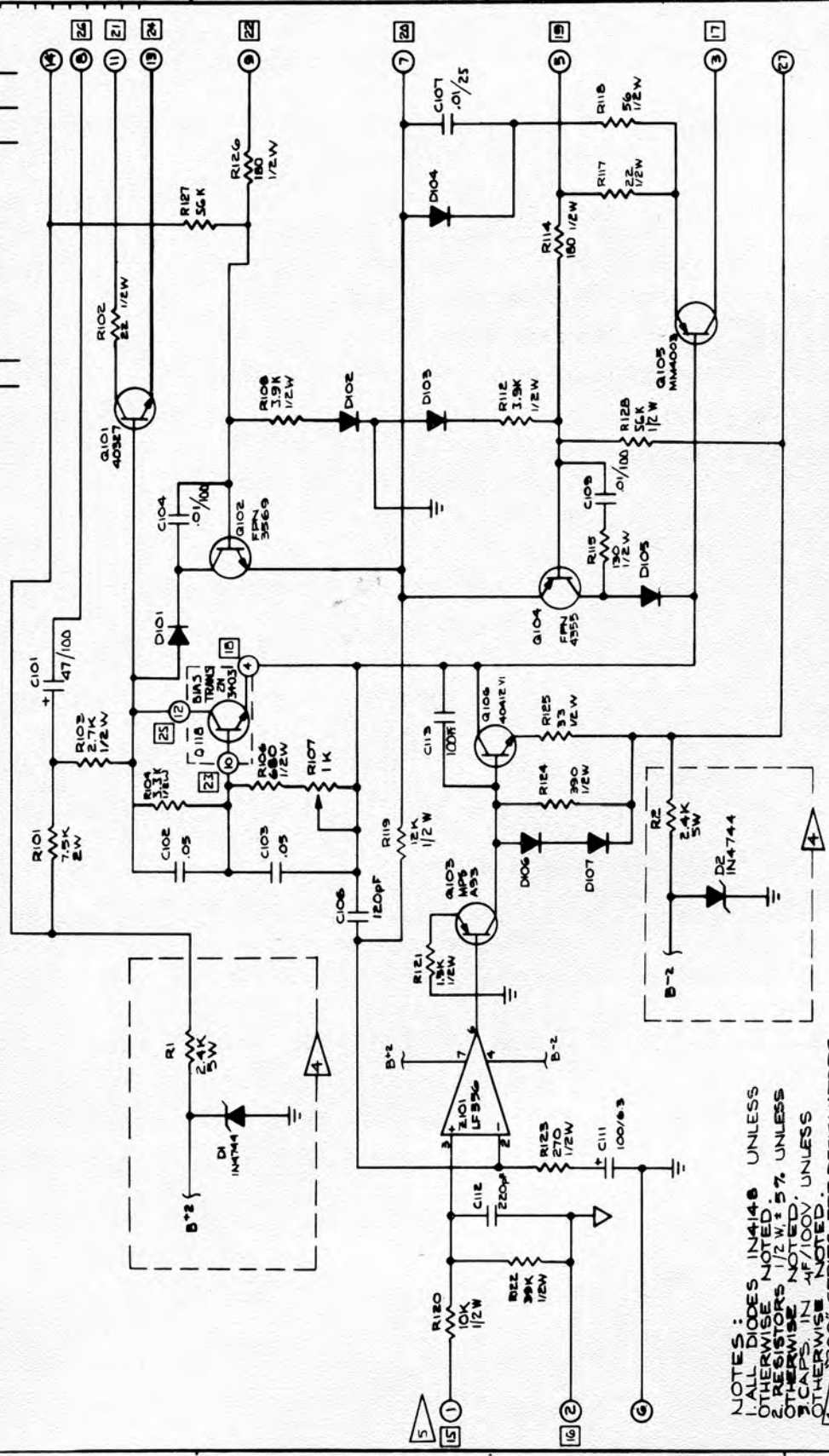

NOTES:
 1. ALL DIODES IN4148 UNLESS OTHERWISE NOTED
 2. RESISTORS 1/2 W 5% UNLESS OTHERWISE NOTED
 3. CAPS IN 4F/100V UNLESS OTHERWISE NOTED
 4. 200 SERIES REF DESIGNATORS (NOT SHOWN) IS IN IDENTICAL SCHEMATIC CONFIGURATION AS SCHEMATIC SHOWN EXCLUDING COMPONENTS INCLUDED IN 4.
 5. BOXED NUMBERS INDICATE CHANNEL B PIN-OUTS

UNLESS OTHERWISE SPECIFIED DIM. AND TOL. ARE IN INCHES (MKS) TYPICAL	DATE	6/12/77
1 DRG 21-J	CHECKED	TLP
2 DRG 21-J1	APPROVED	
3 DRG 21-J2	RELEASE STATUS	
4 DRG 21-J3		
5 DRG 21-J4		
6 DRG 21-J5		
7 DRG 21-J6		
8 DRG 21-J7		
9 DRG 21-J8		
10 DRG 21-J9		
11 DRG 21-J10		
12 DRG 21-J11		
13 DRG 21-J12		
14 DRG 21-J13		
15 DRG 21-J14		
16 DRG 21-J15		
17 DRG 21-J16		
18 DRG 21-J17		
19 DRG 21-J18		
20 DRG 21-J19		
21 DRG 21-J20		
22 DRG 21-J21		
23 DRG 21-J22		
24 DRG 21-J23		
25 DRG 21-J24		

Phase Linear	
PCB SCHEMATIC	
AMPLIFIER	
700 SERIES TWO	
SIZE	C
DWG. NO.	PL36
REV.	P
SCALE	1 OF 1
DO NOT SCALE DWG.	

Diagram 2-1. Schematic: PL36, Main PCB

REV	DESCRIPTION	BY	DATE
B	CORRECTION PER AUDIT		0612 8378

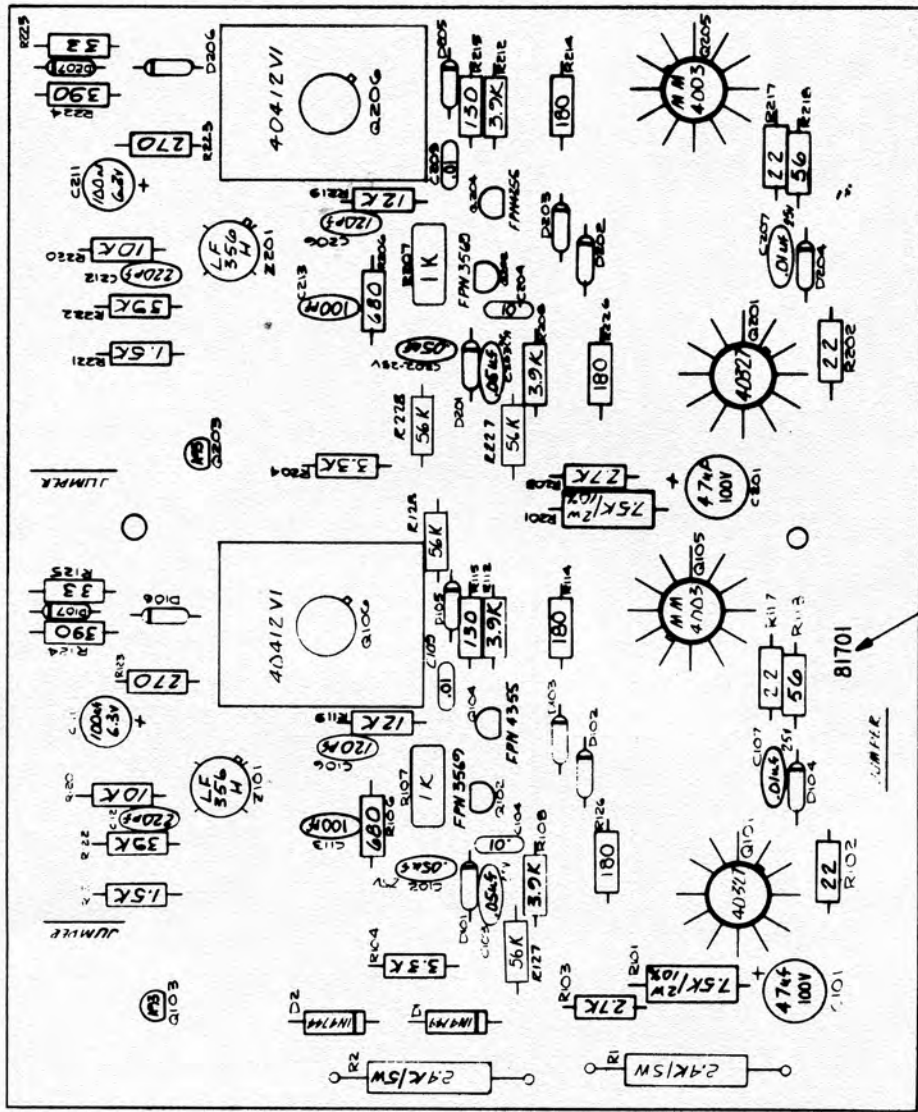

NOTES: UNLESS SPECIFIED OTHERWISE:
 1. RESISTORS IN OHMS, 100, 1K, 10K, 100K, 1M, 10M, 100M, 1K, 10K, 100K, 1M, 10M, 100M
 2. CAPACITORS IN PFD, 100P, 1N, 10N, 100N, 1U, 10U, 100U, 1M, 10M, 100M
 3. DIODES IN 4148
 4. DATECODE 81701

Phase Linear		DATE	6/18/77
PCB ASSY		DESIGNER	TLP
PWR AMP 700 SERIES TWO		RELEASE STATUS	1/1
REV	DATE	NO. OF CHG	BY
C	11/36	1	
SCALE	DO NOT SCALE DIMS.	SHEET	1

UNLESS OTHERWISE SPECIFIED AND SHALL BE INTERPRETED PER (ANSI) Y14.1-1974. TOLERANCES ARE:
 1 DEC: ±1% 2 DEC: ±1% 3 DEC: ±1% 4 DEC: ±1% 5 DEC: ±1%
 DIMS: ±0.005" 2 DEC: ±0.005" 3 DEC: ±0.005" 4 DEC: ±0.005" 5 DEC: ±0.005"

Diagram 2-2. Layout: PL36, Main PCB

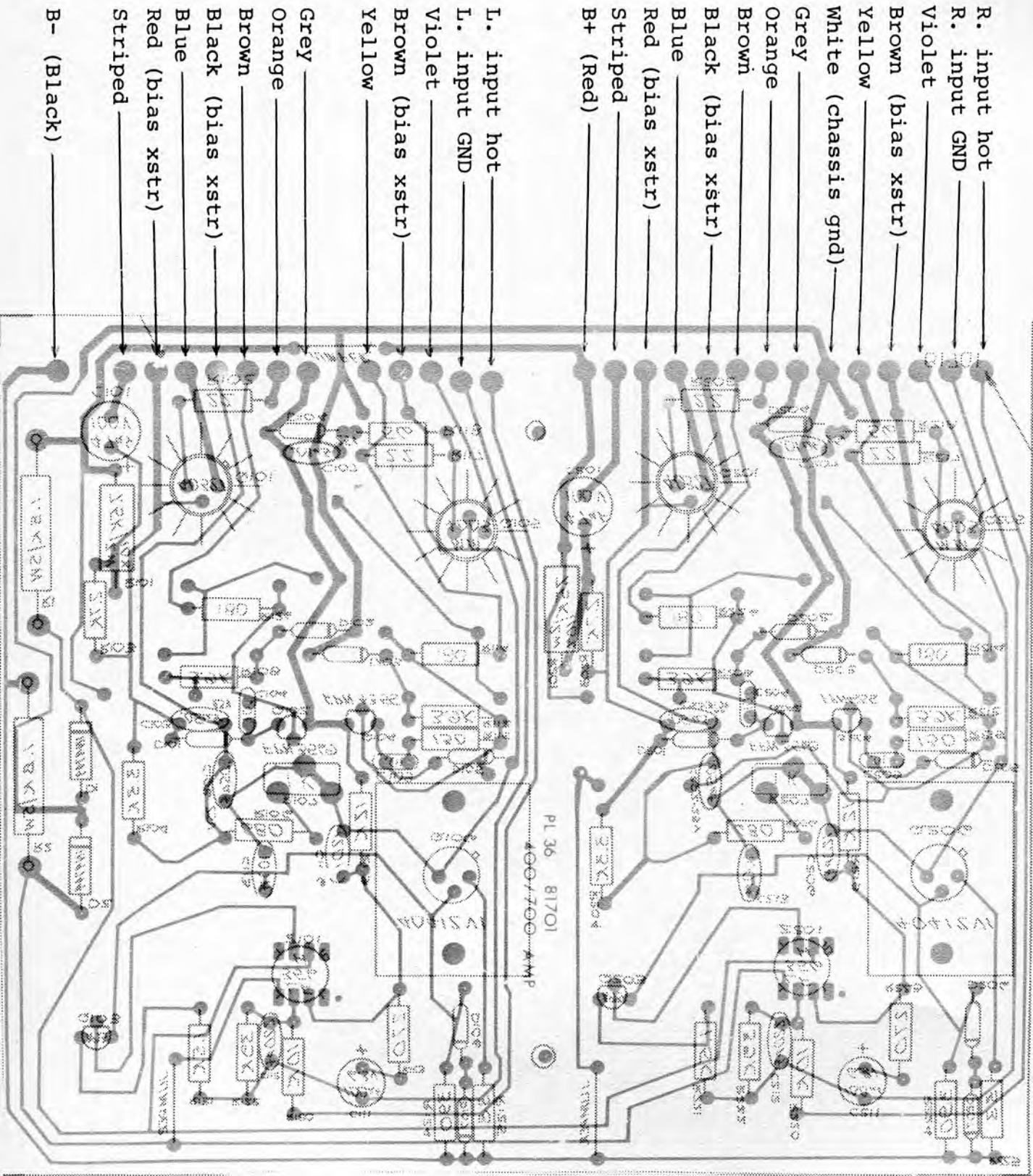
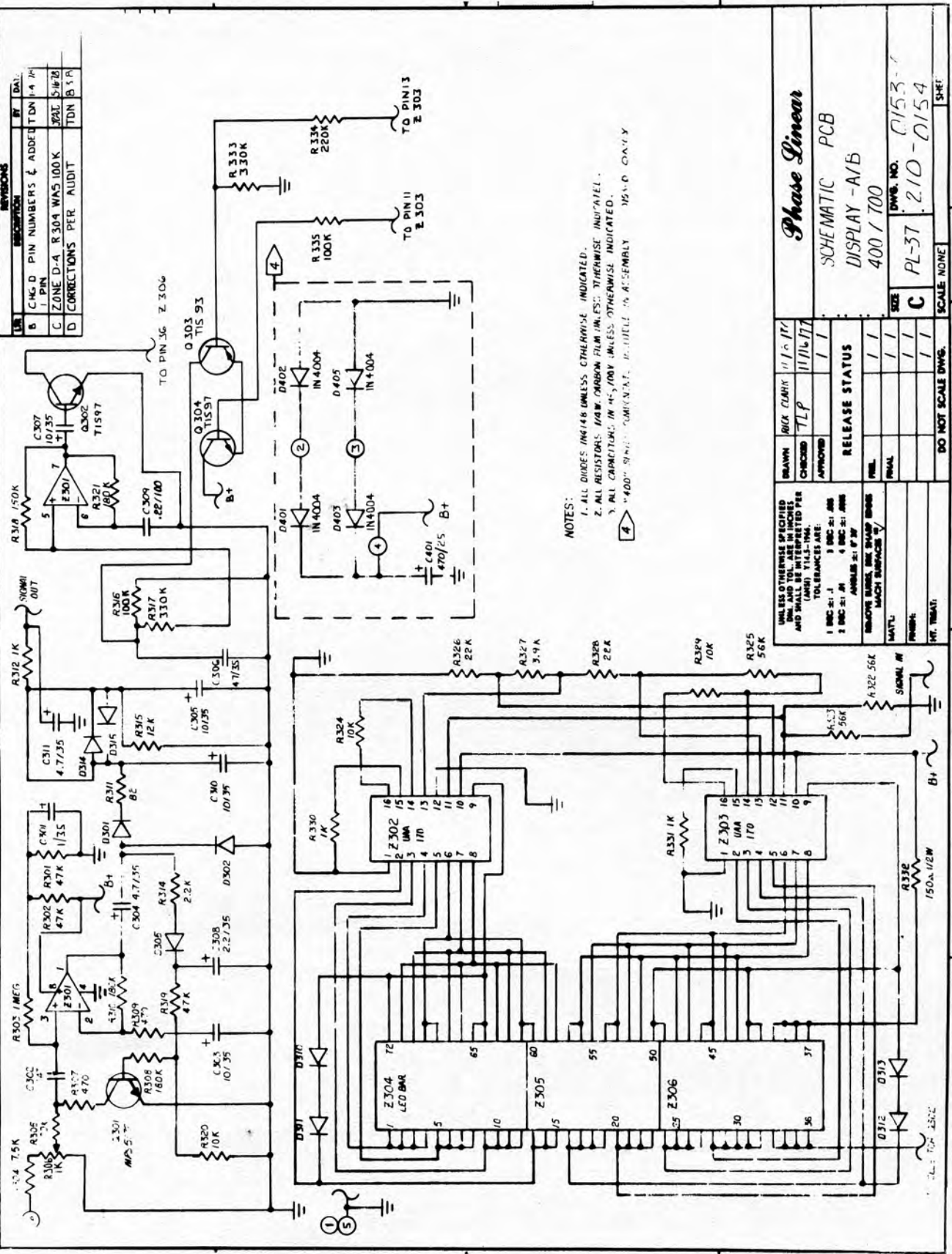

Diagram 2-3. X-ray view of PL36 and wiring diagram.



REV	DESCRIPTION	BY	DATE
B	CHK'D PIN NUMBERS & ADDRESS	TDN	1/4/72
C	ZONE D-A R304 WAS 100K	201	5/16/72
D	CORRECTIONS PER AUDIT	TDN	8/5/72

NOTES:
 1. ALL DIODES IN4148 UNLESS OTHERWISE INDICATED.
 2. ALL RESISTORS 1/8W. CARBON FILM UNLESS OTHERWISE INDICATED.
 3. ALL CAPACITORS IN 45/100V UNLESS OTHERWISE INDICATED.
 4. *400" SIGNAL COMMENT. B-TITLE IN ASSEMBLY 10-P. ONLY

Phase Linear

SCHEMATIC PCB
 DISPLAY -A/B
 400 / 700

DRAWN	CHK'D	APPROVED	RELEASE STATUS
TLP	TLP	TLP	1/1
1/1	1/1	1/1	1/1
1/1	1/1	1/1	1/1
1/1	1/1	1/1	1/1
1/1	1/1	1/1	1/1
1/1	1/1	1/1	1/1

UNLESS OTHERWISE SPECIFIED
 DIMENSIONS ARE IN INCHES UNLESS
 OTHERWISE SPECIFIED
 TOLERANCES ARE:
 1 DEC: ±.1
 2 DEC: ±.05
 3 DEC: ±.025
 4 DEC: ±.015
 ANGLES: ±.030
 UNLESS OTHERWISE SPECIFIED
 DIMENSIONS ARE IN INCHES UNLESS
 OTHERWISE SPECIFIED
 TOLERANCES ARE:
 1 DEC: ±.1
 2 DEC: ±.05
 3 DEC: ±.025
 4 DEC: ±.015
 ANGLES: ±.030
 UNLESS OTHERWISE SPECIFIED
 DIMENSIONS ARE IN INCHES UNLESS
 OTHERWISE SPECIFIED
 TOLERANCES ARE:
 1 DEC: ±.1
 2 DEC: ±.05
 3 DEC: ±.025
 4 DEC: ±.015
 ANGLES: ±.030

REMOVE BUBBLES, BUBBLES, BUBBLES
 MACH SURFACES W/

MAT'L: FR-4
 FINISH: HT. TREAT.

DO NOT SCALE DIMS.

SCALE: NONE

DWG. NO. 0153-1
 PL-37 2.10-0154

SIZE C

SHEET

Diagram 2-4. Schematic: PL37, Display PCB.

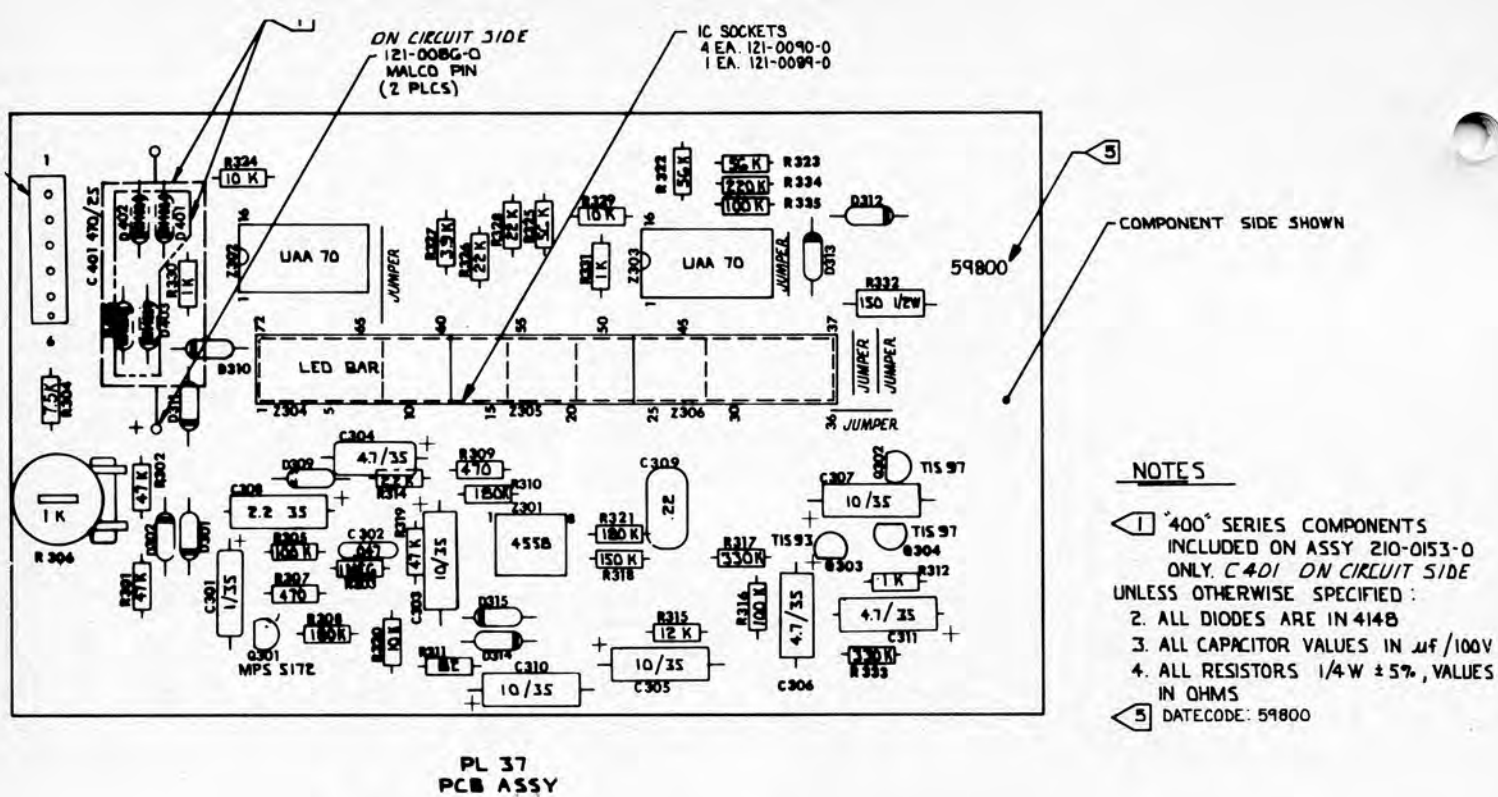

Diagram 2-5. Layout: PL37, Display PCB.

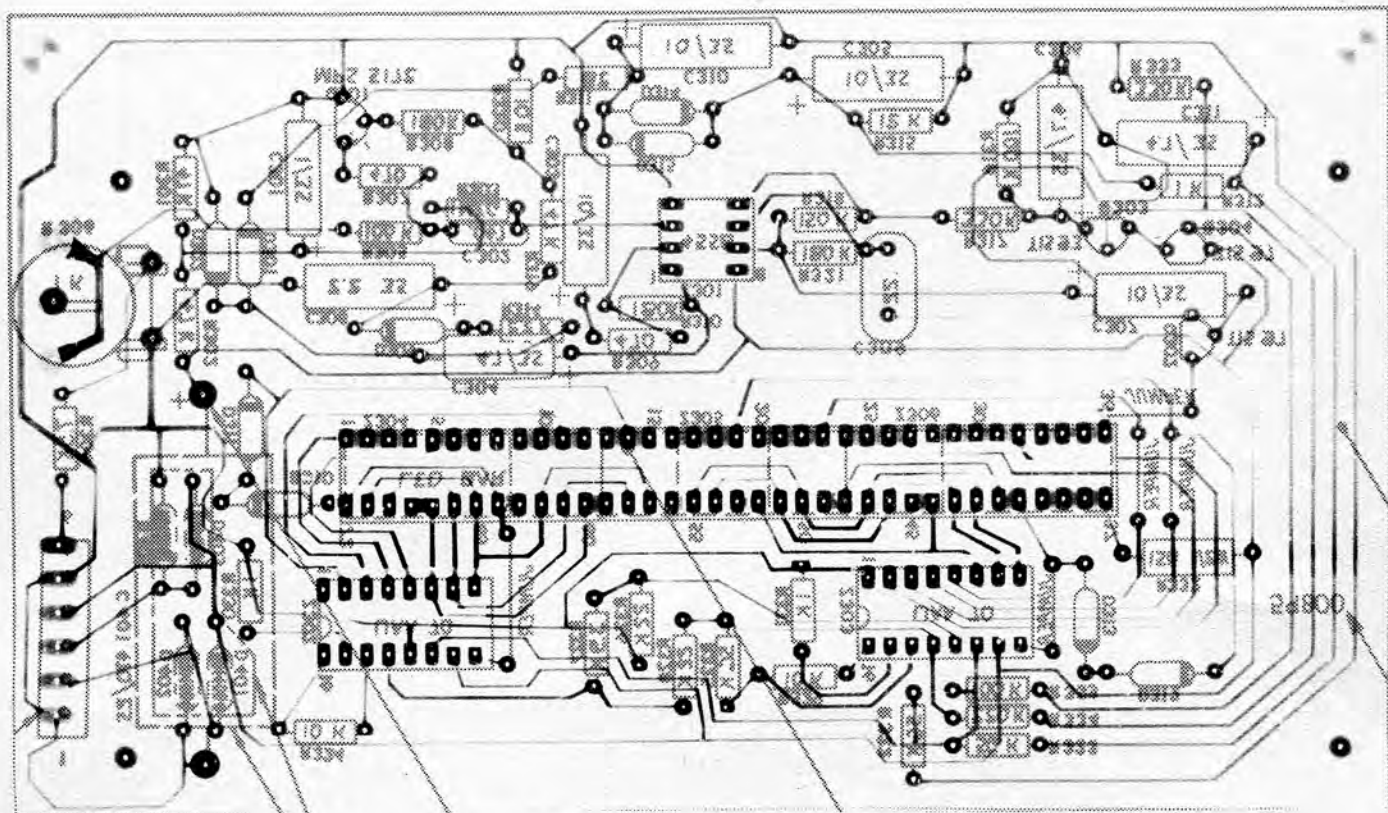
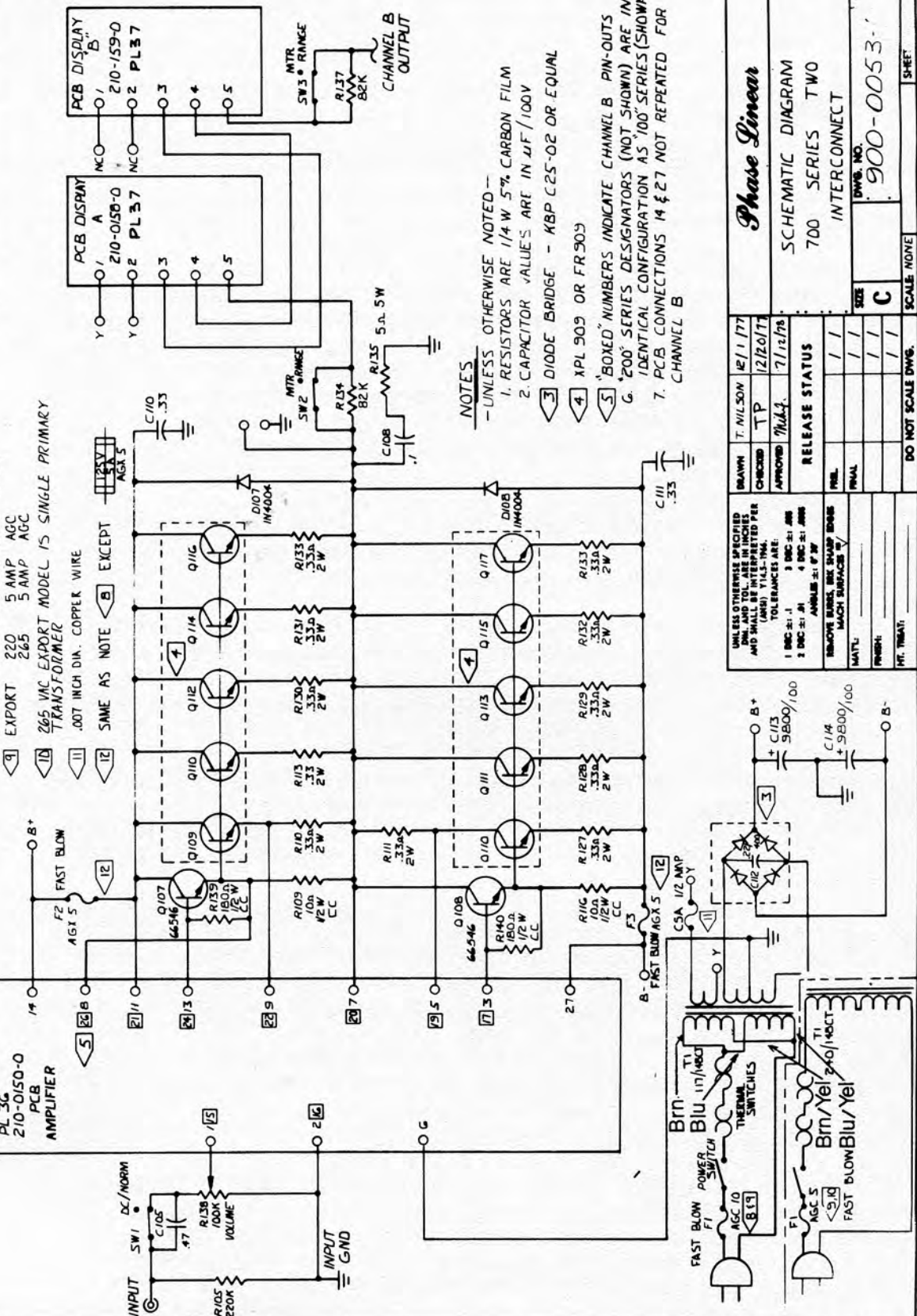
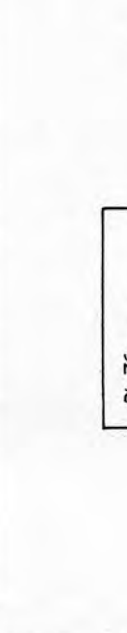

Diagram 2-6. X-ray view of PL37, from foil side.

REV.	DESCRIPTION	BY	DATE
1	ASSEMBLY		
2	CHANGE ID. FORMER TO DUAL PRIMARY. ZONE A4	TDN	2-2-74
3	ZONE C2 WAS R135, R136 10A. C249E IS 152 5A. 3W		5-10 91.0-2
4	CORRECTION PER AUDIT		2-24 13-78

NOTES CONT.—
 (8) CSA 120VOLT, US 120 VOLT
 CAUTION—
 FOR CONTINUED PROTECTION
 AGAINST FIRE HAZARD, REPLACE ONLY
 WITH SAME TYPE AND RATING OF FUSE.
 (9) EXPORT 220 5 AMP AGC
 265 5 AMP AGC
 (10) 265 VAC EXPORT MODEL IS SINGLE PRIMARY
 TRANSFORMER
 .007 INCH DIA. COPPER WIRE
 (11) SAME AS NOTE (B) EXCEPT
 (12) SAME AS NOTE (B) EXCEPT



- NOTES
 — UNLESS OTHERWISE NOTED—
 1. RESISTORS ARE 1/4 W 5% CARBON FILM
 2. CAPACITOR VALUES ARE IN μ F/100V
 (3) DIODE BRIDGE — KBP C25-02 OR EQUAL
 (4) XPL 909 OR FR 909
 (5) 'BOXED' NUMBERS INDICATE CHANNEL B PIN-OUTS
 G. '200' SERIES DESIGNATORS (NOT SHOWN) ARE IN IDENTICAL CONFIGURATION AS '100' SERIES (SHOWN)
 7. PCB CONNECTIONS 14 & 27 NOT REPEATED FOR CHANNEL B

Phase Linear
 SCHEMATIC DIAGRAM
 700 SERIES TWO
 INTERCONNECT

UNLESS OTHERWISE SPECIFIED DIM. AND TOL. ARE IN INCHES AND SHALL BE INTERPRETED PER THE FOLLOWING TOLERANCES ARE:	1 DEC. ± .1	2 DEC. ± .01	3 DEC. ± .001	4 DEC. ± .0001
INCHES DIMS. SEE DRAWING DIMS. MATCH SURFACES				
MATL:				
MT. TRMT:				
DO NOT SCALE DIMS.				
SCALE: NONE				
SIZE: C				
DWG. NO.:	900-0053			
SHEET:				

Diagram 2-7. Interconnect Schematic.

3-0. 700II Circuit Description.

- 3-1. Power Amplifier. The Phase Linear Model 700 consists of two independent direct coupled linear power amplifiers combined to form a single, dual channel unit capable of extremely high power output. Please refer to the schematic diagram for the following circuit description of the individual power amplifier.

The low level input stage employs a wideband low noise FET input integrated circuit operational amplifier (Op Amp) to provide high open loop voltage gain for minimum distortion. The input signal is applied to the noninverting input of the Op Amp while the inverting input receives a portion of the final output voltage forming a negative feedback loop. A transistor functioning as a voltage level shifter couples the output signal of the Op Amp to a common emitter amplifier. The common emitter amplifier stage, biased for class A operation, is capable of swinging the full power supply voltage of 200 volts, providing the final voltage gain of the amplifier. The output stage forms a unity voltage gain buffer, capable of delivering the required current.

A bootstrap arrangement is used to provide a high impedance load for the common emitter stage and at the same time increases the amount of drive current available to the positive predriver transistor allowing symmetrical saturation. Control of the amplifier idle current is accomplished with a transistorized biasing circuit (V_{be} multiplier) which regulates the bias conditions of the predriver, driver and output transistors. The bias regulator transistor is mounted on the output stage heat sink assembly to achieve proper thermal tracking and prevents the possibility of thermal runaway.

The output stage of each channel employs 10 high current, high voltage silicon power transistors arranged in a quasi-complementary format and biased for true class B operation. Most of the required bias current is carried by the driver transistors, resulting in very high circuit efficiency. In this design, the driver and predriver transistors serve to provide current amplification of the output signal from the common emitter stage to a level required by the parallel connected output transistors.

Voltage and current levels of the output transistors are monitored continuously during amplifier operation by the built-in, dual slope protection circuit. The protection circuit consists of two transistors; one which operates when the amplifier output is positive and one which operates when the amplifier output is negative. If the voltage and current levels in the output transistors become excessive,

the protection transistors will conduct to divert drive current entering the predriver transistors; thereby limiting the current flow in the output stage to a safe value.

- 3-2. LED Display. Output information is supplied from the amplifier to resistive divider R304-R306 which scales the voltage to appropriate levels for use by the low voltage circuitry involved in the display. This pad also sets the sensitivity of the displays.

The combination of Z301A and Q301 form a compressor to render the large changes in output level of the amplifier much smaller, such that roughly 45 dB of information may be displayed in the same area that would normally handle only 20 dB of dynamic range.

The output of the compression system is rectified by D301 and passed along to a series of resistors and capacitors. The purpose of these is to determine the dynamics of the display itself. The result of this network is a fast attack-slow decay characteristic allowing the prescribed peak responding metering system.

The combination of Z301B and Q302 is a retriggerable monostable which is activated by the compressor when it hits a level set by zener diode D303. R316, R317 and C309 set the frequency of the flasher and Q302 interfaces this system to the last four paralleled LEDs in the display.

Z302 and Z303 are a pair of voltage-controlled comparator/logic integrated circuits which are controlled by external resistive scaling and the input level provided by the compression amplifier. The outputs of these logic blocks are current sources which provide constant light level independent of power supply voltage.

4-0. Disassembly Procedure

4-1. Be sure that the 700II line cord is unplugged, then remove the bottom cover (7 phillips screws).

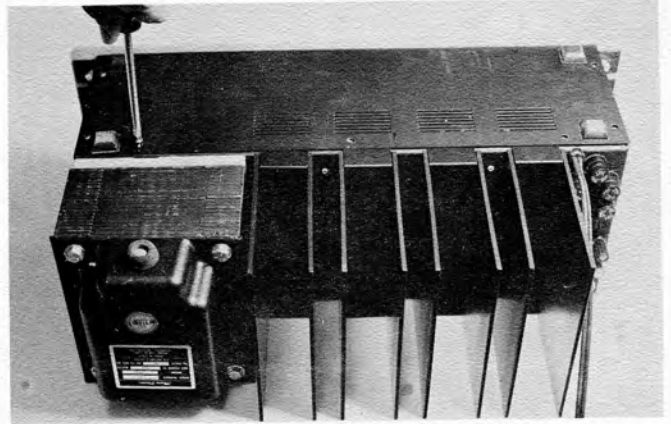

4-2. Position the amplifier with the front panel facing up. Loosen and remove all four handle screws; lift off the handles, ferrules and the front panel and set these aside (take care not to scratch these appearance parts).

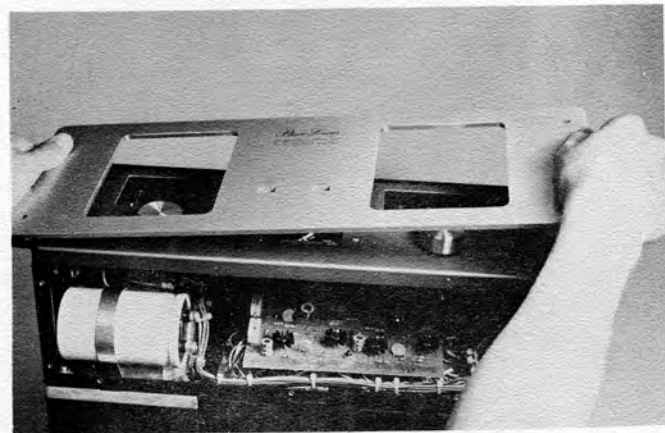
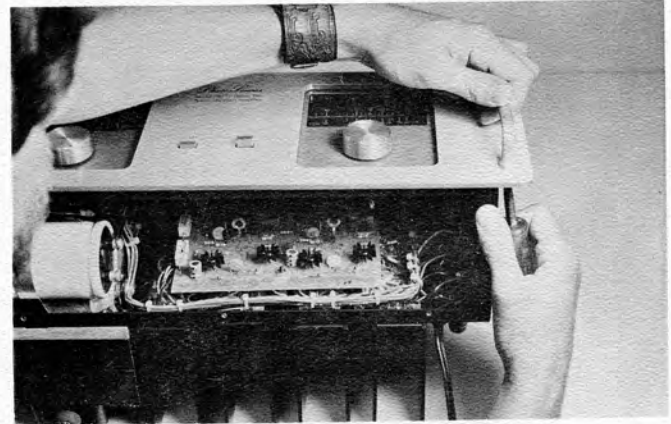

4-3. Remove the two middle and two lower sub-front mounting screws--do not remove the two upper screws.



4-4. Loosen only both upper sub-front mounting screws and then rotate the sub-front to a vertical position. Tighten either screw to hold the front panel in this position.

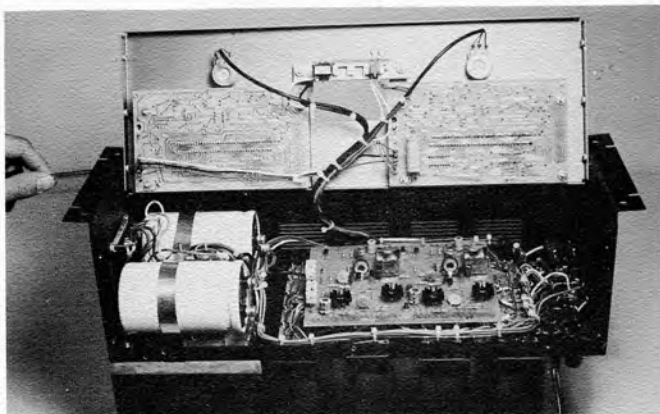

4-5. Remove both main PCB retainer nuts.

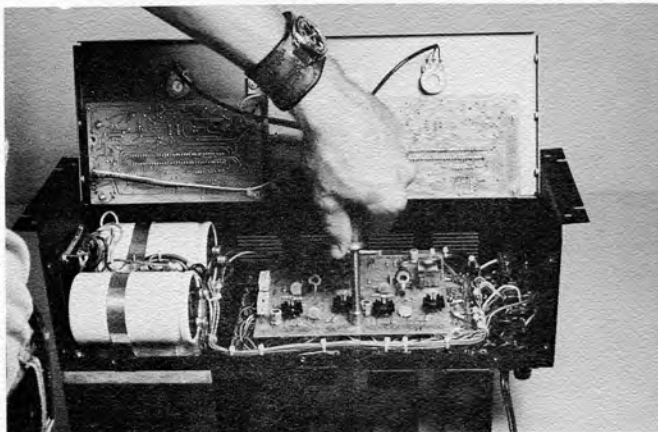

4-6. Carefully lift the main PCB from the mounting bolts and flip it over while pulling forward to gain access to the foil side of the board.

CAUTION: DO NOT ENERGIZE THE UNIT WITHOUT FIRST MAKING SURE THAT NONE OF THE COMPONENTS OR JUMPERS ON THE PCB ARE SHORTING TO THE CHASSIS OR HEATSINK ASSEMBLY.

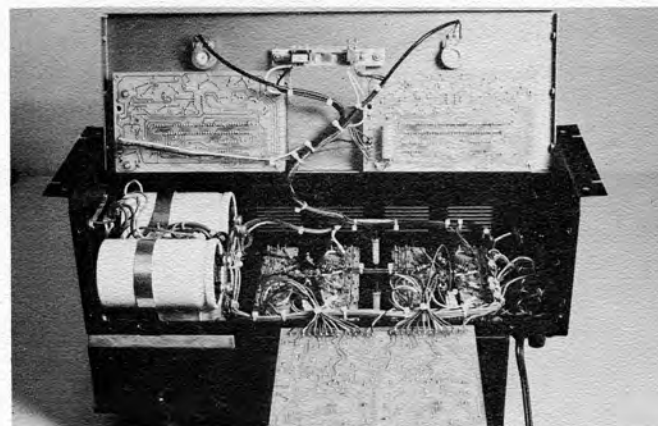
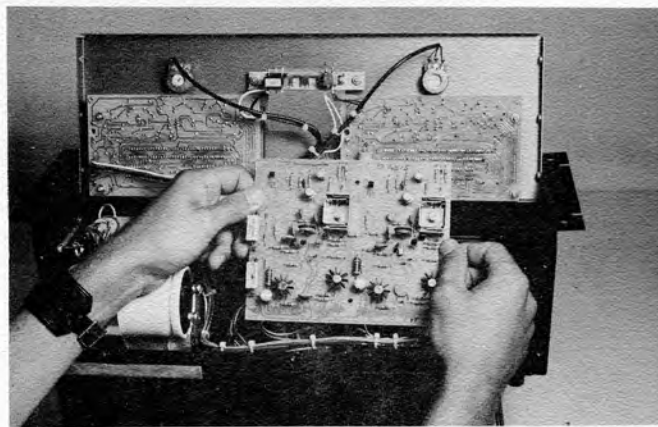

4-7. To gain access to the components on the display board, remove the four retainer nuts and slide the PCB off the mounting bolts.

NOTE: When replacing the display PCB(s), be sure that the foam rubber gaskets are properly aligned before tightening the retainer nuts.

4-8. To re-assemble, reverse the above procedure.

NOTE: When re-assembling the front panel, use the following sequence:

a) insert but do not tighten the six sub-front mounting screws.

b) secure the front panel in place with handles and screws; tighten firmly

c) while checking alignment of the switch buttons in the front panel holes, push the sub-front snug against the back of the front panel and tighten the sub-front mounting screws.

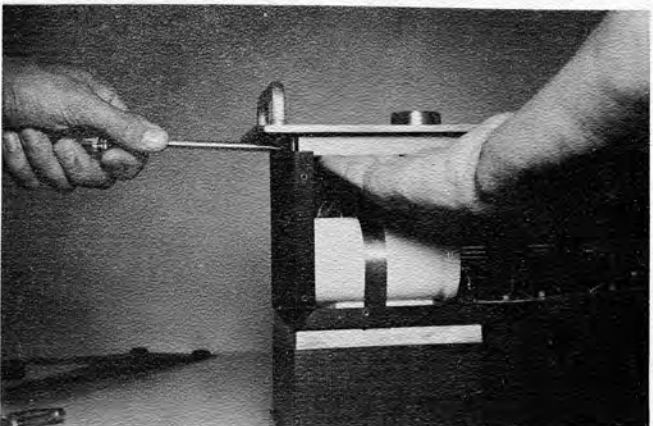
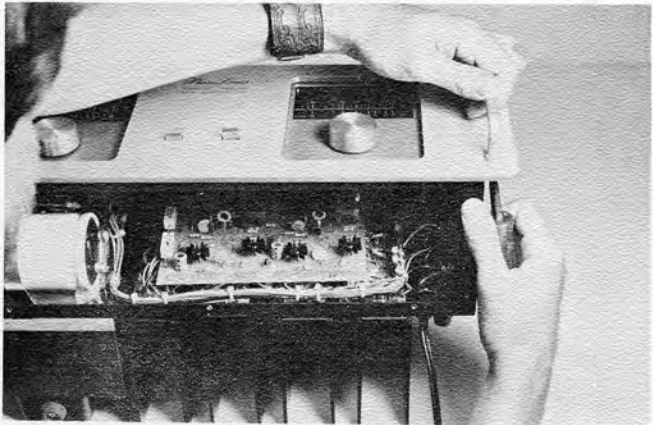
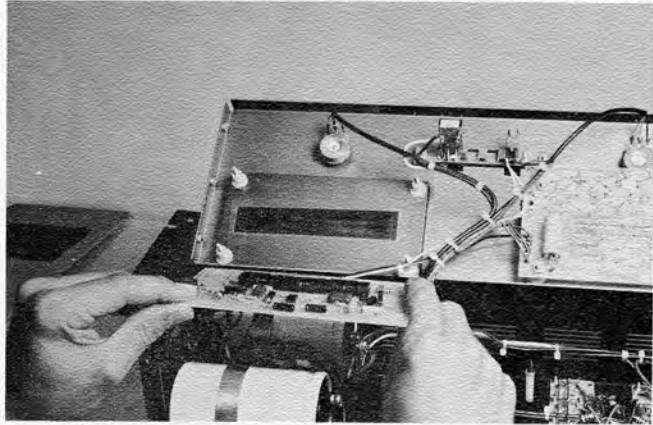
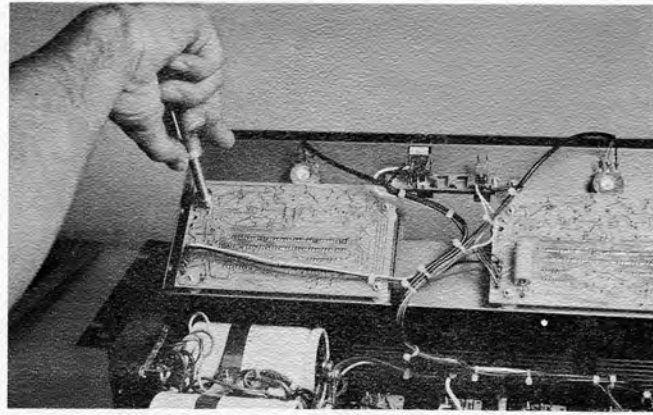

5-0. Test Procedure

Contents

- 5-1. Power Supply
- 5-2. Energizing the unit
- 5-3. Output signal without load
- 5-4. Output signal with 8 ohm load
- 5-5. Distortion
- 5-6. Offset
- 5-7. Short circuit test
- 5-8. Display

Necessary equipment:

Low distortion audio signal generator
VOM or DVM
High impedance scope
250 watt 8 ohm load

- 5-1. Power supply. Before plugging in the AC line cord on the 700, check all fuses: verify ABX-5 or AGX-8 fuses for the supply and AGC-10 for the line fuse (AGC-5 for 240 volt operation).

CAUTION: If any fuse is discovered blown, do not energize the unit, even after replacing the blown fuse(s). Follow the procedure in section 6-1 to properly energize the unit without causing possible further damage to the output stage.

- 5-2. Energizing the unit. Plug the line cord into a variable line transformer and slowly turn it up to 117 VAC or 230 VAC as required. If a line transformer is not available, plug the line cord directly into a working AC outlet of proper line voltage. Verify that the left-most LED spot in each display lights up.
Note: The LED spots may "jump" toward the right at the instant of turn-on, but should quickly settle to the extreme left position.

- 5-3. Output signal with no load. Monitor the left channel output with the scope and AC voltmeter. DO NOT connect any other load to the outputs at this time. Drive the left channel input with a 2K Hz sine wave until the output wave form is well into clipping. Verify that the clipping is symmetrical. Repeat the above with the right channel.

- 5-4. Output with 8 ohm load. Connect an 8 ohm 250 watt load resistor to the left channel output terminals and monitor the left channel output. Apply a 2K Hz signal to the left channel input and verify at least 54V RMS output before clipping. Repeat the above at 20 Hz, 200 Hz, and 20K Hz for both left and right channels.

- 5-5. Distortion. Monitor the left channel output with a THD analyzer. With an 8 ohm load connected also to the left channel output, drive the left channel to 54V RMS and verify a THD of 0.09% or less. Repeat this procedure with the right channel. This same procedure may also be used to test for IM distortion of 0.09% or less.

Note: It may be necessary to use the high filter in the THD analyzer if it is so equipped.

- 5-6. Offset. Measure across the output terminals of each channel for presence of DC voltage and verify ± 10 mV or less with NO inputs connected to the unit.
- 5-7. Short circuit test. Drive the left channel with a 200 Hz signal to an output level of 54V RMS. Now short the output terminals with a jumper wire for 2 to 4 seconds. Remove the jumper and verify that the amplifier resumes normal operation. Repeat the above with right channel.
- 5-8. Display. Remove all connections from the outputs except the scope and AC voltmeter, using these to monitor the output of either channel. Drive both inputs with a 60Hz sine wave, and slowly increase the input level while observing both LED arrays. Verify that all of the LED segments operate. Adjust the input level to obtain 54V RMS and verify that the 0 dB segment lights up within ± 2 dB of this rated output level. Adjust the input level such that the left channel -20 dB segment is lit; verify that the right channel also displays -20 dB ± 2 segments. Drive the amplifier well into clipping and verify that the last four right-hand segments flash and continue flashing 1 to 3 seconds after the input is removed.

6-0. TROUBLESHOOTING GUIDE

CONTENTS

- 6-1. Power supply malfunction
- 6-2. Unit will not energize properly
- 6-3. Output malfunction--no load
- 6-4. Output malfunction into a load
- 6-5. Excessive distortion
- 6-6. Excessive offset
- 6-7. Protection circuit malfunction
- 6-8. Display malfunction

NOTE: Most transistors and diodes in the 700 can be checked in circuit using an ohmmeter on the RX1, RX10 or 2K scale. With the 700 power OFF, measure the forward-biased resistance of the particular diode or transistor junction and verify a reading of 400 to 700 ohms on a typical DVM for a good device. Actual readings on good devices will vary from meter to meter, and some meters do not have sufficient test voltage to turn on a semiconductor. Nevertheless the shorted or open device is usually revealed quickly using this in-circuit method.

► CAUTION: BEFORE MAKING ANY MEASUREMENTS INTERNAL TO THE 700, UNLESS OTHERWISE SPECIFIED, BE SURE THAT THE LINE CORD IS UNPLUGGED AND THE POWER SUPPLY CAPACITORS ARE DISCHARGED-- WAIT AT LEAST 5 MINUTES AFTER UNPLUGGING THE AMPLIFIER TO ENSURE THAT THESE CAPACITORS ARE DISCHARGED. USE EXTREME CAUTION WHEN TAKING ANY MEASUREMENTS INTERNAL TO THE 700 WITH POWER ON--HAZARDOUS VOLTAGES ARE PRESENT. ONLY QUALIFIED PERSONNEL WITH PROPERLY INSULATED AND PROTECTED EQUIPMENT SHOULD ATTEMPT SERVICING OF THE 700 WITH POWER ON.

6-1. POWER SUPPLY MALFUNCTION

- 6-1.1. Blown supply fuse. If any of the supply fuses are found blown, there is a high probability that one or more of the output transistors is defective, especially if the blown fuse appears blackened or silvered (indicating large current surge).

► CAUTION: Do not replace the fuse(s) and energize the unit at this point since this may cause further damage to the output stage. First perform the following test to check for defective output transistors:

6-1.2. Checking for shorted outputs. Be sure that the AC line cord of the 700 is UNPLUGGED, then follow the disassembly procedure, section 4-0. Place the negative probe of an ohmmeter (set on the RX1, RX10 or 2K ohm scale) on the collector buss wire of one bank of output transistors. Touch the positive probe to any one of the output emitters in that bank. If any of the transistors in that bank are shorted, the meter will display a very low reading, usually less than an ohm.

If none of the outputs are shorted, the meter will display a typical reading for a forward biased diode (since measurement is essentially across flyback diodes D115 and D116), usually 400 to 700 ohms depending on the meter in use. Repeat the above for each remaining bank of transistors. Refer to 6-1.3. for isolation of a defective output transistor.

6-1.3. Isolating defective outputs. To isolate the defective output(s) in a bank which indicates a short, switch the ohmmeter to the lowest scale (RX1 or 200 ohm) and touch the positive probe to each output emitter in that bank, leaving the negative probe connected to the collector buss wire as in 6-1.2. One or two of the readings will be significantly lower than the rest, which indicates that that particular output transistor is shorted. Replace the defective output(s) and repeat the above until no short is indicated.

► IMPORTANT: WHENEVER ANY OUTPUT TRANSISTOR HAS BEEN REPLACED IT IS NECESSARY TO PERFORM STEP 6-1.4. TO VERIFY PROPER CURRENT SHARING OF ALL OUTPUT TRANSISTORS.

6-1.4. Current sharing test. This test is necessary to verify that ALL outputs are operating properly, ensuring a permanent repair. Although the amplifier will probably meet all specs without all outputs operational, increased current loading of the remaining outputs will result in a significant reduction in reliability.

- a) With an 8 ohm load connected to the output terminals of the left channel, drive the left input with a 200 Hz signal to obtain 53 V RMS output. Turn the line voltage down to 75 VAC.
- b) Using DC voltmeter, measure the voltage drop across the emitter resistors in each output bank. Verify that there is between 150 mV and 180 mV DC across each resistor.
- c) Replace any output transistor whose emitter resistor reading varies more than 20% from the typical; verify first that the resistor itself is not damaged.

6-1.5. Blown line fuse.

- a) Check for shorted power supply capacitor.
- b) Check for shorted rectifier diode(s).

6-2. UNIT WILL NOT ENERGIZE PROPERLY

6-2.1. Unit blows line fuse at turn-on. Refer to section 6-1.5. for power supply troubleshooting procedure.

6-2.2. Unit blows supply fuse(s) at turn-on. This suggests output transistor failure; refer to section 6-1.1.

6-2.3. One or both LED spots remain toward the right. This indicates an output stage or front end failure causing DC at the output. Refer to sections 6-1.2. and 6-6.

6-3. OUTPUT MALFUNCTION--NO LOAD

6-3.1. No output, one or both channels.

- a) Check for blown supply fuses or line fuse; refer to 6-1.
- b) With power OFF, check all transistors and diodes in-circuit as described in 6-0.
- c) Drive the inputs with 1 volt at 2K Hz; energize and check signal at pin 6 of Z101. Replace Z101 if necessary.
- d) Excessive current drawn when voltage applied to the line cord:
 - check the bias transistors carefully; replace if necessary. If the unit ceases to draw excess current to emitter, then replace the bias transistors.
 - Check outputs and output drivers (6-1.2,3.).

- e) Isolate protection circuit as outlined in 6-3.2.c).
- f) Check for loose, dirty, or worn input jacks.

6-3.2. Asymmetrical clipping.

- a) Verify matched power supply readings at the filter capacitors in the main power supply. There should be no greater than 1 volt difference between positive and negative supply reading.
- b) See 6-3.3.

6-3.3. Truncated or asymmetrical output.

- a) Possible faulty protection circuit: disconnect one end of diodes D101 and D105 and repeat the test. If the problem is now removed, check and replace D101, D105, Q102, Q104, Q109, and Q110 as necessary.
- b) Possible defective predriver or output driver; check Q101, Q105, Q107 and Q108.
- c) Possible defective Class A stage; check Q106, D106 and D107.

6-3.4. Oscillations.

- a) Check RC network located at the output terminals; replace if doubtful.
- b) Replace predriver Q101, Q105 as necessary.
- c) Replace output drivers Q107 and Q108 as necessary.
- d) Check output transistor insulators: if these are the rubber self-lubricated type, there is a possibility of parasitic oscillations caused by output transistor casing biting through the insulator as a result of thermal cycling or overtightening. It is recommended that if this situation exists, the insulators be replaced with the mica type lubricated with thermal compound.
- e) If oscillations (bursts) occur just before rated output at low test frequencies, be sure that line voltage at the line plug is 120 VAC.

NOTE: Several ferrite beads are positioned in the output stage buss wiring. These are carefully placed at the factory for maximum high frequency stability--it is recommended that these beads NOT BE ALTERED IN THE SLIGHTEST AMOUNT.

6-4. OUTPUT MALFUNCTION INTO A LOAD

6-4.1. Unit will not deliver 53 V RMS into 8 ohm load.

- a) Check for line or variac voltage sag; voltage at the line plug must be at least 117 VAC when delivering full output.
- b) Possible defective output transistor or driver; perform step 6-1.4.

6-4.2. Asymmetrical clipping (or loss of half of wave form).

- a) Check protection circuit as outlined in step 6-3.3.
- b) Check for balanced power supply voltage at the main filter capacitors while driving a load. If voltages differ by more than 2 volts, replace the capacitor which reads low.
- c) Check for defective emitter resistors; perform 6-1.4.

6-5. EXCESSIVE DISTORTION

6-5.1. Improper bias setting. Check and adjust as follows:

- a) Allow at least 5 minutes warm-up time; perform step 5-4. to accelerate warm-up.
- b) Remove all input and output connections, then measure the DC voltage drop across R109 located in the output stage.
- c) Verify a reading of no less than 0.20 VDC and no greater than 0.60 VDC. Adjust R107 as necessary.

6-5.2. THD analyzer adjustments.

- a) Activate the 80K Hz filter on the analyzer if it is so equipped and repeat THD measurement.
- b) Examine test bench grounding system for possible ground loops. Ground the analyzer directly to the 700 output ground, not to the load, scope or meter grounds. Use 16 guage wire for output ground system.

6-5.3. Defective protection circuit. Refer to 6-3.3.a),b).

6-6. EXCESSIVE OFFSET

- a) Replace Z101.
- b) Verify +15 VDC $\pm 10\%$ across D1; replace if necessary.
- c) Verify -15 VDC $\pm 10\%$ across D2; replace if necessary.

- d) Replace Q103.
- e) Replace C111.

6-7. PROTECTION CIRCUIT MALFUNCTION

6-7.1. Supply fuses open when amplifier is shorted. This indicates that the protection circuit is not shunting drive current properly.

- a) Check Q102, Q104, D101, D105 and D102, D103.
- b) Check R110, R127, Q109, Q110.
- c) Perform step 6-1.4. to verify that all output transistors are functioning properly.

6-8. DISPLAY MALFUNCTION

6-8.1. One or more LED spots do not light.

- a) Replace the appropriate LED array.
- b) Replace Z302, Z303 as necessary.

6-8.2. 0 dB segment does not correspond to rated output level.

- a) Adjust R306 as necessary.

6-8.3. Displays do not track within spec.

- a) Replace Q301; verify that Q301 is an MPS5172 for both displays.

6-8.4. Malfunction of clipping indicator.

- a) Very early productions of the display PCB contained a zener diode 1N4734, 5.1 V, between R312 and C305. If a display containing this zener exhibits premature or otherwise malfunctioning clipping indicator, replace this zener diode. If zener replacement does not render the display operable, replace BOTH display PCBs with the current type (both displays must be of the same design to track within spec).
- b) Check Z301, Q302, Q303, Q304; replace as necessary.

7-0. 700 Parts List

TRANSISTORS:

XPL909, FPL909.....126-0015-0
66546.....126-0016-0
40412V1.....126-0005-0
MM4003.....126-0006-0
40327.....126-0007-0
MPS A93.....126-0028-0
TIS 93.....126-0009-0
GES 97.....126-0033-0
MPS5172.....126-0010-0
TIS 97.....126-0020-0
2N3403.....126-0018-0
3569.....126-0044-0
4355.....126-0045-0

INTEGRATED CIRCUITS:

LF356.....126-0051-0
UAA170.....126-0048-0
4558.....126-0038-0

DIODES:

S25A20.....126-0001-0
1N4148.....126-0002-0
1N4004.....126-0003-0
1N4744.....126-0064-0
1N752.....126-0049-0
LED Array.....126-0050-0

CAPACITORS:

.01/100v myl.....127-0063-0
.01/100v cer.....127-0005-0
.05/25v cer.....127-0007-0
.22/100v myl.....127-0028-0
.22/400v myl.....127-0041-0
.33/100v myl.....127-0027-0
1/35v elec.....127-0036-0
2.2/35v elec.....127-0068-0
4.7/35v elec.....127-0037-0
10/35v elec.....127-0035-0
47/35v elec.....127-0032-0
100/6.3v elec.....127-0033-0
470/25v elec.....127-0102-0
9800/100v elec.....127-0017-0

RESISTORS:

.33/2w.....128-0350-0
7.5K/2w.....128-0366-0
10/3w.....128-0356-0
2.5K/5w.....128-0371-0

POTENTIOMETERS:

1K Trim (R107).....129-0073-0
1K Trim (R306).....129-0096-0
100K Linear (R138)..129-0005-0

SWITCHES:

2-Station ass'y
(power & range)...129-0093-0
Input slide sw.....129-0018-0
Thermal Cutout.....129-0021-0

TRANSFORMER:

117-220v Pri/148vSec125-0034-0

PRINTED CIRCUIT BOARDS:

PL36 Drive PCB.....210-0150-0
PL37 Display A.....210-0154-0
PL37 Display B.....210-0153-0

FRONT PANEL ACCESSORIES:

Knob, 1.5" Dia.....142-0038-0
Handle, Rack-Mount..142-0029-0
Handle Ferrule.....143-0015-0
Display Glass.....141-0072-0
Display Bezel.....141-0118-0
Display Gasket.....141-0119-0
Display Face Panel..220-0036-0

METALWORK:

Transistor Cover....141-0019-0
Front Panel.....220-0035-0
Sub-Front Panel....220-0037-0
Top Cover.....220-0049-0
Bottom Cover.....141-0104-0
Chassis.....141-0105-0
Heatsink (R).....142-0008-0
Heatsink (L).....142-0002-0

NOTE: When ordering replacement parts please specify model and serial number of unit.

USE ONLY REPLACEMENT PARTS ISSUED OR AUTHORIZED BY THE FACTORY SERVICE DEPT. A UNIT WILL NOT BE CONSIDERED UNDER FACOTY WARRANTY IF UNAUTHORIZED SUBSTITUTE REPLACEMENT PARTS HAVE BEEN INSTALLED,

8-0. Service Bulletins and Supplements

This section of the 700 Series Two Service Manual is reserved for the inclusion of any service bulletins, troubleshooting or other supplements which apply to the 700 Series Two.