



SUPER CHAMP X2 COMBO/ HEAD™

(This is the model name for warranty claims)

COMBO p/n 2223000000 (120V)

HEAD p/n 2223100000 (120V)

SERVICE MANUAL



ATTENTION:

WARRANTY SERVICE PROCEDURES

The Super Champ X2 Combo and Head are considered to be field serviceable to the component level. Except for the μ DSP PCB which must be replaced as a complete module. We do however understand that some circumstances may require replacement of other PCB Assemblies. Any Fender Authorized Service Center in need of a warranty replacement PCB Assembly for this unit should contact FMIC Tech Support by phone at (866) 345-3642 or email: service@fender.com



SUPER CHAMP X2 COMBO/HEAD™

(This is the model name for warranty claims)

2

IMPORTANT NOTICE

• Copyright © 2012 FMIC. All rights reserved. All information contained herein is CONFIDENTIAL and PROPRIETARY and is the property of Fender® Musical Instruments Corporation. It is not to be sold or assigned to another party and is disclosed solely for use by Fender Authorized Service Centers for purposes of product service and maintenance. All information is not to be disclosed to others without the expressed permission of Fender® Musical Instruments Corporation. All

specifications are subject to change without notice. This information and any copies produced electronically or otherwise must be surrendered upon demand of Fender® Musical Instruments Corporation.

• Parts marked with two asterisks (**) indicate the required use of that specific part. This is necessary for RELIABILITY and SAFETY requirements. **DO NOT USE A SUBSTITUTE!**

PARTS LIST CODES

The description codes used in the itemized Parts Lists are defined below:

CAPACITOR CODES

CAP AE = Aluminum Electrolytic
CAP CA = Ceramic Axial
CAP CD = Ceramic Disk
CAP CR = Ceramic Radial
CAP MPF = Metalized Polyester Film
CAP MY = Mylar
CAP PFF = Polyester Film/Foil

RESISTOR CODES

RES CC = Carbon Comp
RES CF = Carbon Film
RES FP = Flame Proof
RES MF = Metal Film
RES MOX = Metal Oxide
RES WW = Wire Wound

HARDWARE CODES

BLX = Black Oxide
CR = Chrome Plated
HWH = Hex Washer Head
M = Machine Screw
NI = Nickel Plated
OHP = Oval Head Phillips
PB = Particle Board
PHP = Pan Head Phillips
PHPS = Pan Head Phillips Sems
SMA = Sheet Metal "A" Point
SMB = Sheet Metal "B" Point
SS = Stainless Steel
TF = Thread Forming
ZI = Zinc Plated



SUPER CHAMP X2 COMBO/HEAD™

(This is the model name for warranty claims)

3

SPECIFICATIONS

Model Name:	SUPER CHAMP X2 COMBO/ HEAD	
Release Number:	PR 2259	PR 2260
Part Numbers	HEAD	COMBO
(120V, 60Hz) US:	2223000000	2223100000
(230V, 50Hz) EUR:	2223006900	2223106900
(230V, 50Hz) UK:	2223004900	2223104900
(240V, 50Hz) AUS:	2223003900	2223103900
(100V, 50Hz) JPN:	2223007900	2223007900
(220V, 50Hz) ROK:	2223009900	2223009900
(240V, 50Hz) ARG:	2223005900	2223005900
(110V, 50Hz) TW:	2223001900	2223001900
Power Requirement:	90 W	
Power Output:	15 W RMS into 8 ohms @ 10 %THD	
Power Amp Sensitivity:	10mV for 10 W into 8 ohms @ 5 %THD	
Impedances	Input (Pre-Amp):	>1M Ohms
	Effects Send:	1 kOhm
	Effects Receive:	10 kOhm
Speaker Complement:	Fender Special Design 8 ohm, 10" (P/N 0091245000)	
Footswitch	2 Button DC Footswitch Assy (P/N 0071359000)	
Dimensions	Height:	15 in (38 cm)
	Width:	17.5 in (45 cm)
	Depth:	9 in (22.9 cm)
Weight:	24 lbs (10.9 kg)	

Product specifications are subject to change without notice



SUPER CHAMP X2 COMBO/HEAD™

(This is the model name for warranty claims)

SERVICE NOTES

- 1. CHASSIS REMOVAL** is accomplished by first removing the COMBO or HEAD's cabinet's back panel. Then remove the four (4) screws from the top of the cabinet that secure the chassis. Disconnect the 1/4" speaker plug from the speaker jack (COMBO only). Then slide the chassis toward the rear of the cabinet.
- 2. MAIN PCB REMOVAL** is accomplished by removing the IEC Connector, the fuse holder, the speaker jack nut, the line out jack nut and the two screws that hold the chassis' rear panel to the chassis. Remove the rear panel and the vacuum tubes. Disconnect the ribbon cable that goes between the main PCB and the uDSP PCB. Remove all screws holding the main PCB to the stand offs on the chassis. Then remove the front panel knobs and the nuts holding the

controls to the front panel. Slide the front panel PCB back away from the front panel. Remove all the fast-ons connecting the main PCB to the power indicator, the power transformer and the output transformer. Now the main PCB can be lifted up and out of the chassis taking advantage of the slots in the back of the chassis.

- 3. The COMBO and the HEAD** share the same chassis and circuitry. The combo contains a captive 10" speaker while the head can be used with any suitable speaker cabinet such as the SC112 enclosure.

PCB EXCHANGE POLICY

Parts marked with a single asterisk (*) in the Part Lists are not field replaceable. If a failure due to one of these components is detected, please con-

tact the FMIC Customer Service Department to order the complete PCB Assembly.

CIRCUIT DESCRIPTION

This section provides concise information about new or unusual circuitry designs incorporated into this amplifier model. The purpose is to aid the service technician by providing insight into the design areas most likely to become obstacles in troubleshooting. Information is focused for its effective use while maintaining the security of Fender® proprietary information whenever possible.

MAIN PCB

The Main PCB Assy. contains the circuitry for the pre-amplifier, the power amplifier, and the power supply. The controls are located on a breakaway

section of the main PCB with ribbon cables connecting them.

PRE-AMPLIFIER

Op-amp U6-A provides the high impedance instrument input with 14db of gain. Op-amp U6-B is configured as an active filter producing high frequency pre-emphasis. U1-A provides another 20db of gain. Its' output is clamped to +/-2V. The uDSP PCB Assy. chooses either the low gain output from U6-B or the higher gain output from U1-A depending on the amplitude of the guitar input signal. Op-amp U3-A is configured as a differential input amp recovering the signal after uDSP processing and conversion back to an analog signal. The LOUT and



SUPER CHAMP X2 COMBO/HEAD™

5

(This is the model name for warranty claims)

ROUT signals are the input to the differential amp which acts as a three pole active low pass filter for de-emphasis. The output of U3-A is applied to a buffer amp U1-A which drives op-amp U1-B which provides the LINE OUT signal and the power amp input. FET Q-1 provides system muting during power up/down in conjunction with the power sense circuits composed of D9, Q2, and Q4.

USER INTERFACE

The 4 – 16 position encoders (S2 – S3) for the VOICE and EFFECT SELECT are sent to the GPIO buss of the uDSP and polled at a 1000Hz rate.

The 6 potentiometers CH1 VOLUME (R85), CH2 VOLUME (R83), CH2 GAIN (R84), TREBLE (R82), BASS (R81), and AND FX LEVEL (R80) generate DC Voltages (0.0V to +3.3V) that are polled at a 1000Hz rate by the uDSP's A/D converter.

POWER AMPLIFIER

The power amplifier consists of V1, V2, and V3. T2 and associated circuitry. The signal is fed to the gate of V1-B in common cathode configuration. The signal is then fed from the plate of V1-B to the gate of V1-A which is operating as a phase splitter driving V2 from its' plate and V3 from its' cathode. V2 and V3 are operating in Class A-B push-pull mode. T2 matches the impedance of V2's plate to the 8 Ohm speaker. Negative feedback is provided by R23 feeding signal back to V1-B's cathode.

μDSP PCB

The μDSP PCB is located in the back of the chassis opposite the power transformer. It provides the amplifier voicing and effects functions. The μDSP PCB is not field serviceable and must be replaced as an assembly.

USB PCB

The USB PCB provides the USB interface to the μDSP and ESD protection. The USB interface is used to communicate between the user's computer for the purpose of altering the amp's presets or restoring the amp to factory settings.

POWER SUPPLY

T1 has four secondary windings for the +5V regulator, the +/-12V supplies, the tube filaments and the high voltage supply. The violet winding is rectified by a fullwave bridge, filtered by C41 and fed to the μDSP PCB where it is regulated to +3.3VDC and fed back on to the main PCB. Similarly, the center tapped orange and yellow winding is rectified, filtered and fed to +/-12V zeners to provide power to the operational amplifiers and other circuitry. The red windings provide the high voltage for the vacuum tubes. The green winding provides 6.3VAC for the vacuum tube filaments. A voltage doubler is employed to produce -41.9VDC to bias the output tubes, V2 and V3.



SUPER CHAMP X2 COMBO/HEAD™

(This is the model name for warranty claims)

.PARTS LIST: MAIN PCB ASSEMBLY			
QTY.	PART #	DESCRIPTION	REFERENCE DESIGNATION
1	0091225000	*MAIN PCB ASSY SCX2	STUFFED MAIN PCB
1	0027353001	RES FILM 1W 100kohm 5%	R21
1	0091199001	RES MOX FP 1W 5% 7.5ohm	R64
1	0033095001	RES MOX FP 1W 5% 1ohm LL	R20
2	0036351001	RES MOX 2W 100ohm 5%	R87-88
1	0036921001	RES MOX 2W 1k 5%	R79
1	0041268001	RES MOX 2W 10k 5% LL	R47
2	0028021001	RES MOX 2W 470ohm 5%	R4 R25
1	0053860000	CAP MPF .1uF 275V 10%	C58
1	0038699001	CAP CA 100pF 100V 5%	C21
10	0039263001	CAP CA 1000pF 50V 5%	C7 C14 C29-35 C47
2	0039270001	CAP CA 10000pF 50V 5%	C4 C11
2	0038703001	CAP CA .1uF 50V 10%	C22-23
1	0039267001	CAP CA 3900pF 100V 5%	C15
4	0038698001	CAP CA 47pF 100V 5%	C24 C26 C66 C72
2	0051457003	CAP CD 100pF 500V NPO 5%	C13 C25
4	0051406003	CAP CD 220pF 500V 10%	C1-3 C65
1	0051458003	CAP CD 470pF 500V 10%	C43
0	0034788003	CAP CR .1uF 50V 20% .2"	
17	0034788003	CAP CR .1uF 50V 20% .2"	C9-10 C18-19 C48 C44 C39 C49-51 C54-55 C68-70 C73 C76
1	0064089001	DIODE 1N4003	D3
6	0026730001	DIODE 1N4006 800V 1A	D6-8 D12-14
2	0006260001	DIODE 1N4448 SIGNAL	D10-11
8	0064089001	DIODE 1N4003	D17-21 D23-24 D27
2	0054210001	DIODE SCHOTTKY BAT85	D15-16
2	0029690001	DIODE HV 3kV 200mA	D1-2
1	0031017001	DIODE ZEN 1N5223B 2.7V 5%	D4
1	0027327001	DIODE ZEN 1N5234B 6.2V 5%	D9
1	0029898001	DIODE ZEN 1N5236B 7.5V 5%	D5
2	0047140060	DIODE ZEN 1N5349B 12V 5W 5%	D25-26
2	0038690001	CAP AE AX 1uF 100V 20%	C28 C67
6	0038692001	**CAP AE AX 10uF 35V 20%	C12 C27 C42 C45-46 C77
1	0009512001	CAP AE AX 22uF 25V 20%	C8
2	0028471003	**CAP AE RDL 47uF 50V 20%	C59 C62
2	0028476003	**CAP AE RDL 100uF 50V 20%	C16-17
2	0028494000	**CAP AE RDL 1000uF 35V 20%	C57 C60
3	0054204000	**CAP AE RDL 22uF 450V 20%	C38 C40-41
1	0055992000	**CAP AE RDL 4700uF 16V 20%	C53
8	0026000001	FSTN TAB MALE PCB MT .187	P1-4 P6-8 P18
10	0025802000	FSTN TAB MALE .250x.032 P	P9-14 P16 P19-21
1	0027255003	CAP MPF .001uF 100V 10%	C36

* Non-serviceable part. Replace complete parent assembly. See PCB EXCHANGE POLICY section above.

shaded Unique Fender® part. Order directly from the FMIC Parts Department.

shaded + * Access to this part or assembly is controlled. Please contact the FMIC Customer Service Department.

** Safety Requirement part. Replacement must match Safety Agency...-Value, if specified -Type, if specified -Approval Mark(s) if on part.

*shaded + *** Both a unique Fender® part and a Safety Requirement part as defined above.



SUPER CHAMP X2 COMBO/HEAD™

(This is the model name for warranty claims)

2	0073586001	**FUSE QA AXIAL LEAD 1A 125V	F4-5
1	0075607001	**FUSE QA 2A 125V	F3
1	0070334001	**FUSE QA AXIAL LEAD 7A 125V	F2
2	0026368001	RES CF 1/2W 100ohm 5%	R22 R24
1	0027871001	RES CF 1/2W 1Kohm 5%	R13
1	0053869001	RES CF 1/2W 1 MEG 5%	R14
1	0026549001	RES CF 1/2W 5% 1.5kohm	R16
1	0037169001	RES CF 1/2W 1.8k 5%	R86
2	0025117001	RES CF 1/2W 220k 5%	R2-3
1	0026493001	RES CF 1/2W 2.7Kohm 5%	R23
1	0025109001	RES CF 1/2W 47ohm 5%	R17
2	0047434001	RES CF 1/2W 56k 5%	R12 R15
1	0091202000	HDR 2MM VERT 8X2 CKT	P15
1	0091201000	HDR 2MM VERT 25X2 CKT	P5
REF	0055959000	HDR .1 CTR 7x2 CKT SQ PIN	P17
8	0057350000	HEADER .1 CTR 8x2 CKT SQ	P22-P29
2	0053450000	JACK STEREO R/A	J1-2
2	0059889000	JACK STEREO R/A W/MTL BUSH	J3-4
3	REF	JUMPER WIRE 22GA	JMP1-3
2	0049948000	LED RED LONG LEAD	D22 D28
3	0027278003	CAP MPF .1uF 63V 10%	C52 C63-64
2	0027267003	CAP MPF .022uF 100V 10%	C37 C71
1	0024833000	CAP MPF RDL .022uF 400V 10%	C20
3	0024855000	CAP MPF RDL .1uF 630V 10%	C5-6 C61
6	0027941000	CONTROL SNAPIN 50k B TAPER	R80-85
1	0027873000	CONTROL PCB MNT LIN 30% 25K	R6
12	0024952001	RES CF 1/4W 100ohm 5%	R49 R58 R60-61 R66 R68-70 R77-78 R92 R100
4	0024965001	RES CF 1/4W 1k 5%	R1 R51 R89-90
7	0024981001	RES CF 1/4W 10k 5%	R5 R9 R44 R50 R54 R62-63
2	0024997001	RES CF 1/4W 100k 5%	R32 R41
2	0025069001	RES CF 1/4W 1M 5%	R43 R52
1	0025084001	RES CF 1/4W 10M 5%	R45
1	0024969001	RES CF 1/4W 1.5k 5%	R34
2	0024985001	RES CF 1/4W 15k 5%	R7 R26
1	0029005001	RES CF 1/4W 2k 5%	R91
2	0029006001	RES CF 1/4W 20k 5%	R29 R31
5	0024956001	RES CF 1/4W 220ohm 5%	R11 R33 R67 R95 R106
1	0024973001	RES CF 1/4W 3.3k 5%	R10
2	0024975001	RES CF 1/4W 3.9k 5%	R27 R42
4	0024947001	RES CF 1/4W 47ohm 5%	R65 R71 R102-103
12	0024993001	RES CF 1/4W 47k 5%	R18-19 R28 R35-36 R46 R48 R72-76
1	0028034001	RES CF 1/4W 5.1Kohm 5%	R8
4	0024994001	RES CF 1/4W 56k 5%	R37-40
1	0024995001	RES CF 1/4W 68k 5%	R30
0	0024996001	RES CF 1/4W 82k 5%	

* Non-serviceable part. Replace complete parent assembly. See PCB EXCHANGE POLICY section above.

shaded Unique Fender® part. Order directly from the FMIC Parts Department.

shaded + * Access to this part or assembly is controlled. Please contact the FMIC Customer Service Department.

** Safety Requirement part. Replacement must match Safety Agency...-Value, if specified -Type, if specified -Approval Mark(s) if on part.

shaded + ** Both a unique Fender® part and a Safety Requirement part as defined above.



SUPER CHAMP X2 COMBO/HEAD™

(This is the model name for warranty claims)

3	0015718001	RES MF 1/4W 1% 1k	R53 R55 R93
2	0015582001	RES MF 1/4W 10k 1%	R59 R96
1	0016951001	RES MF 1/4W 1% 1.21k	R97
2	0025811001	RES MF 1/4W 5.11k 1%	R56 R101
2	0016946001	RES MF 1/4W 1% 825ohm	R57 R94
1	0016739003	XSTR NPN 2N4401 TO-92	Q4
2	0016742003	XSTR PNP 2N4403 TO-92	Q1-2
1	0014689003	XSTR N-CH JFET J111 TO-92	Q3
1	0028091000	SWITCH PUSH SLFLK SHORT STROKE	S1
1	0071228000	SWITCH PUSH MOMENTARY	S4
2	0063204000	ENCODER 16-POS 4-BIT GREY CODE	S2-3
2	0091200003	CAP TAN RDL 22uF 16V 20%	C56 C74-75
2	0031611000	IC DUAL OP-AMP PC4560	U2 U5
1	0091208000	IC REGULATOR +3.3V LM1117T-3.3	U4
3	0016795000	IC DUAL OP-AMP TL072	U1 U3 U6
1	0029167000	TUBE SOCKET 9 PIN PCB MOUNT	For V1
2	0059847000	TUBE SOCKET VT8-PT	FOR V2-3
1	0066390000	**HEATSINK TO-220 .5x.75x0.375" BLACK	
1	0039420000	SCRW M 4-40x3/8PHP SS SE	
1	0097360000	NUT HEX 4-40 EX LOCK	
8	0031184000	SCRW M 6-32x1/4 PHP BLX ITLW	
4	0053931000	STANDOFF 6-32X9/16X1/4 AL RND	
2	0015585001	RES MF 1/4W 1% 100K	R 98-99
1	0055812000	LED TULIP ASSEMBLY	
.PARTS LIST: USB PCB ASSEMBLY			
1	0091226000	*PCB ASSY SUPER CHAMP X2 USB	STUFFED PCB ASSY
1	0055959000	HEADER .1 CTR 2X7 CKT SQ PIN	
1	0091203000	US-TPD2E001	
1	0091204000	USB CONNECTOR	
.PARTS LIST: CHASSIS ASSEMBLY			
1	0091223000	*PANEL FRONT SC X2	
1	0091224000	*PANEL REAR SC X2 COMBO 120V	
	0091317000	*PANEL REAR SC X2 COMBO 230V	
	0092403000	*PANEL REAR SC X2 COMBO 220V CN	
1	0091225000	*PCB ASSY SC X2 MAIN	
1	0091226000	*PCB ASSY SC X2 USB	
2	0031153000	WSHR FLAT 3/8x.614 NI	
2	0016352000	NUT HEX 3/8-32x3/32 TK NI	
1	0092163000	*PCB ASSY UNIVERSAL DSP56725	STUFFED µDSP PCB ASSY
2	0078304000	STANDOFF NYLON 7MM W/3MM DIA	
7	0031184000	SCRW M 6-32x1/4 PHP BLX ITLW	
2	0014345000	SCRW M 4-40x3/16 PHP BLX	

* Non-serviceable part. Replace complete parent assembly. See PCB EXCHANGE POLICY section above.

shaded Unique Fender® part. Order directly from the FMIC Parts Department.

shaded + * Access to this part or assembly is controlled. Please contact the FMIC Customer Service Department.

** Safety Requirement part. Replacement must match Safety Agency...-Value, if specified -Type, if specified -Approval Mark(s) if on part.

*shaded + *** Both a unique Fender® part and a Safety Requirement part as defined above.



SUPER CHAMP X2 COMBO/HEAD™

(This is the model name for warranty claims)

2	9302110021	TUBE 6V6-C GT-6V6-C	
1	0013341000	TUBE 7025/12AX7A 12AX7B SILVER	
2	0020424000	TUBE RING UNIVERSAL (277H-2)	
2	0057256000	KNOB ROTARY ARROW W/CHRM	
6	0054419000	KNOB ROTARY 180 SS W/CHR	
1	0091234000	**XFMR PWR 120V SUPER CHAMP X2	
	0091235000	**XFMR PWR 100V SUPER CHAMP X2	
	0091236000	**XFMR PWR 230V SUPER CHAMP X2	
	0091603000	**XFMR PWR 240V SUPER CHAMP X2	
4	0022004000	NUT KEPS #8-32 ZINC	
1	0091237000	**XFMR OUTPUT SUPER CHAMP X2	
2	0028684000	SCRW SMB 6x3/8 PHP BLX	
1	0054798000	JEWEL ASSEMBLY LED	
1	0031625000	NUT HOLDER PILOT LIGHT 11/16-27	
1	0031263000	BUSHING SNAP SHORT 3/4X15/16 BLK	
1	0036702000	**FUSE HOLDER 3AG FINGER GRIP	
	0036703000	**FUSE HOLDER 5MM FINGER GRIP	
1	0039287000	**SWITCH DPST .187 TAB GLOB	
1	0054642000	**CONNECTOR IEC SNAP IN	
2	0048451000	BUTTON PUSH OFF WHITE	
1	0038900000	SCRW TF 6-32X1/4 PHP ZI	
2	0055838000	NUT PLASTIC BLK REAN JACK	
1	0091238000	**GASKET O/P XFMR SUPER CHAMP XD	
1	0077982000	**FUSE QA 1-1/4X1/4 250V 3A	
	0020793000	**FUSE QA 20mmx5mm 250v 1.6A	
4	0070206000	CABLE RIBBON 16 CKT W/2 CONN 3"	
1	0091223000	*PANEL FRONT SUPER CHAMP X2	
1	0091224000	*PANEL REAR X2 COMBO 120V	
	0091317000	*PANEL REAR X2 COMBO 230V	
	0092403000	*PANEL REAR X2 COMBO 220V CN	
1	0091225000	*PCB ASSY SUPER CHAMP X2 MAIN	STUFFED SCX2 MAIN PCB ASSY
1	0091226000	*PCB ASSY SUPER CHAMP X2 USB	STUFFED SCX2 USB PCB ASSY
2	0031153000	WSHR FLAT 3/8x.614 NI	
2	0016352000	NUT HEX 3/8-32x3/32 TK NI	
1	0092163000	*PCB ASSY UNIVERSAL DSP56725	STUFFED SCX2 µDSP PCB ASSY
2	0078304000	STANDOFF NYLON 7MM W/3MM DIA	
7	0031184000	SCRW M 6-32x1/4 PHP BLX ITLW	
2	0014345000	SCRW M 4-40x3/16 PHP BLX	
2	9302110021	TUBE 6V6-C GT-6V6-C	
1	0013341000	TUBE 7025/12AX7A 12AX7B SILVER	
2	0020424000	TUBE RING UNIVERSAL (277H-2)	
2	0057256000	KNOB ROTARY ARROW W/CHRM	
6	0054419000	KNOB ROTARY 180 SS W/CHR	

* Non-serviceable part. Replace complete parent assembly. See PCB EXCHANGE POLICY section above.

shaded Unique Fender® part. Order directly from the FMIC Parts Department.

shaded + * Access to this part or assembly is controlled. Please contact the FMIC Customer Service Department.

** Safety Requirement part. Replacement must match Safety Agency...-Value, if specified -Type, if specified -Approval Mark(s) if on part.

shaded + ** Both a unique Fender® part and a Safety Requirement part as defined above.



SUPER CHAMP X2 COMBO/HEAD™

(This is the model name for warranty claims)

1	0091234000	**XFMR PWR 120V SUPER CHAMP X2	
	0091235000	**XFMR PWR 100V SUPER CHAMP X2	
	0091236000	**XFMR PWR 230V SUPER CHAMP X2	
	0091603000	**XFMR PWR 240V SUPER CHAMP X2	
4	0022004000	NUT KEPS #8-32 ZINC	
1	0091237000	**XFMR OUTPUT SUPER CHAMP X2	
2	0028684000	SCRW SMB 6x3/8 PHP BLX	
1	0054798000	JEWEL ASSEMBLY LED	
1	0031625000	NUT HOLDER PILOT LIGHT 11/16-27	
1	0031263000	BUSHING SNAP SHORT 3/4X15/16 BLK	
1	0036702000	**FUSE HOLDER 3AG FINGER GRIP	
	0036703000	**FUSE HOLDER 5MM FINGER GRIP	
1	0039287000	**SWITCH DPST .187 TAB GLOB	
1	0054642000	**CONNECTOR IEC SNAP IN	
2	0048451000	BUTTON PUSH OFF WHITE	
1	0038900000	SCRW TF 6-32X1/4 PHP ZI	
2	0055838000	NUT PLASTIC BLK REAN JACK	
1	0091238000	**GASKET O/P XFMR SUPER CHAMP XD	
1	0077982000	**FUSE QA 1-1/4X1/4 250V 3A	
	0020793000	**FUSE QA 20mmx5mm 250v 1.6A	
4	0070206000	CABLE RIBBON 16 CKT W/2 CONN 3"	
.PARTS LIST: END ITEM ASSEMBLY			
1	0050850000	*NAMEPLATE VINTAGE PLASTIC SMALL	
2	0051621000	SCRW SMA 2X9/16 FHP NI	
1	0091245000	SPEAKER 10 INCH 8 OHM SC X2	
4	0026577000	SCRW M 10-32 X 1 PHP BLX	
4	0036199000	SCRW M 8-32x1-3/16 OHP BLX CP	
4	0029527000	WSHR FNSH 8-5/8 FLNGD BLX WX	
1	0091227000	**TUBE CAGE SUPER CHAMP X2 COMBO	
4	0047821000	SCRW M 10-32 3/4 THP STL BLX	
8	0022053000	SCRW SMA 6X1-1/4 OHP STL NI	
8	0037215000	WSHR C/SUNK NICKEL #6	
1	0012582000	CLAMP CABLE NYL SCRW MNT 1/4	
1	0029828000	SCRW PB 8x3/4 PHP ZI	
1	0092061000	**CORD PWR W/IEC CONN DOM 2M	
	0047250000	**CORD PWR W/IEC CONN 250V	
	0047249000	**CORD PWR W/IEC CONN 230V UK	
	0047251000	**CORD PWR W/IEC CONN 230V	
	0057674000	**CORD PWR W/IEC 230V ARG	
	0053997000	**CORD PWR W/IEC CONN 100V JPN	
	0064354000	**CORD PWR WOEC 220V CHINA	
1	0038566000	CABLE ASSY SPKR RT ANG 13-1/2"	

* Non-serviceable part. Replace complete parent assembly. See PCB EXCHANGE POLICY section above.

shaded Unique Fender® part. Order directly from the FMIC Parts Department.

shaded + * Access to this part or assembly is controlled. Please contact the FMIC Customer Service Department.

** Safety Requirement part. Replacement must match Safety Agency...-Value, if specified -Type, if specified -Approval Mark(s) if on part.

*shaded + *** Both a unique Fender® part and a Safety Requirement part as defined above.



SUPER CHAMP X2 COMBO/HEAD™

(This is the model name for warranty claims)

1	0050850000	*NAMEPLATE VINTAGE PLASTIC SMALL	
2	0051621000	SCRW SMA 2X9/16 FHP NI	
1	0091245000	SPEAKER 10 INCH 8 OHM SC X2	
4	0026577000	SCRW M 10-32 X 1 PHP BLX	
4	0036199000	SCRW M 8-32x1-3/16 OHP BLX CP	
4	0029527000	WSHR FNSH 8-5/8 FLNGD BLX WX	
1	0091227000	**TUBE CAGE SUPER CHAMP X2 COMBO	
4	0047821000	SCRW M 10-32 3/4 THP STL BLX	
8	0022053000	SCRW SMA 6X1-1/4 OHP STL NI	
8	0037215000	WSHR C/SUNK NICKEL #6	
1	0012582000	CLAMP CABLE NYL SCRW MNT 1/4	
1	0029828000	SCRW PB 8x3/4 PHP ZI	
1	0092061000	**CORD PWR W/IEC CONN DOM 2M	
	0047250000	**CORD PWR W/IEC CONN 250V	
	0047249000	**CORD PWR W/IEC CONN 230V UK	
	0047251000	**CORD PWR W/IEC CONN 230V	
	0057674000	**CORD PWR W/IEC 230V ARG	
	0053997000	**CORD PWR W/IEC CONN 100V JPN	
	0064354000	**CORD PWR WOEC 220V CHINA	
1	0038566000	CABLE ASSY SPKR RT ANG 13-1/2"	

.PARTS LIST: COMBO CABINET ASSEMBLY

1	0091222000	*CABINET ASSY SCX2 COMBO	COMBO CABINET COMPLETE
1	0091220007	*CABINET BAFFLE ASSEMBLY	
6	0021972000	NUT T 10-32x3/4 STR 3 PRNG BLX	
1	0912200014	*CABINET TOP BACK ASSY	
1	0026570000	TOLEX "BRAVURA BLACK" BRONCO	
2	0091220016	*CABINET BOTTOM BACK ASSY	
1	0032524000	HANDLE REINFORCEMENT STEEL	
1	0037790000	HANDLE BLACK RIBBED 9.25"	
2	0022244000	SCRW M 10-32x1-1/8 OHP NI	
2	0025395000	HANDLE CAP 1 HOLE NI (DWG 17420)	
2	0011678000	SCRW SMA 8x1-1/2 OHP BLX	
2	0029527000	WSHR FNSH 8-5/8 FLNGD BLX WX	
4	0041549000	GLIDE CUP PRESS-IN NI PLATED	
0.35	0037788000	GRILL CLOTH BLACK/SILVER	

.PARTS LIST: HEAD CABINET ASSEMBLY

1	0091526000	*CABINET ASSY SCX2 HEAD	COMPLETE SCX2 HEAD CABINET ASSY
1	0091526008	*GRILLE ASSY	
0.3	0037788000	GRILL CLOTH BLACK/SILVER	
1	0091526007	*BACK ASSY	
0.8	0026570000	TOLEX "BRAVURA BLACK" BRONCO	

* Non-serviceable part. Replace complete parent assembly. See PCB EXCHANGE POLICY section above.

shaded Unique Fender® part. Order directly from the FMIC Parts Department.

shaded + * Access to this part or assembly is controlled. Please contact the FMIC Customer Service Department.

** Safety Requirement part. Replacement must match Safety Agency...-Value, if specified -Type, if specified -Approval Mark(s) if on part.

shaded + ** Both a unique Fender® part and a Safety Requirement part as defined above.



SUPER CHAMP X2 COMBO/HEAD™

12

(This is the model name for warranty claims)

2	0021972000	NUT T 10-32x3/4 STR 3 PRNG BLX	
1	0032524000	HANDLE REINFORCEMENT STEEL	
1	0037790000	HANDLE BLACK RIBBED 9.25"	
2	0022244000	SCRW M 10-32x1-1/8 OHP NI	
2	0025395000	HANDLE CAP 1 HOLE NI (DWG 17420)	
4	0072900000	SCRW SMA 8x1-1/4 OHP BLX	
4	0029527000	WSHR FNSH 8-5/8 FLNGD BLX WX	
4	0055734000	"RUBBER FOOT 3/4""DIA"	
4	0029677000	SCRW SMA 6x1 THP BLX	

* Non-serviceable part. Replace complete parent assembly. See PCB EXCHANGE POLICY section above.

shaded Unique Fender® part. Order directly from the FMIC Parts Department.

*shaded + ** Access to this part or assembly is controlled. Please contact the FMIC Customer Service Department.

** Safety Requirement part. Replacement must match Safety Agency...-Value, if specified -Type, if specified -Approval Mark(s) if on part.

*shaded + *** Both a unique Fender® part and a Safety Requirement part as defined above.



Service Diagram List

- Service Diagram COMBINED SUPER CHAMP X2 MAIN PCB
- Service Diagram COMBINEDSUPER CHAMP X2 USB PCB
- Footswitch Assembly2-BUTTON FOOTSWITCH
- Service Diagram (PCB Assembly)2-BUTTON FOOTSWITCH

REVISIONS			
REV.	DESCRIPTION	DATE	APPROVED
A	PR2259	23-Aug-11	L.E.L.

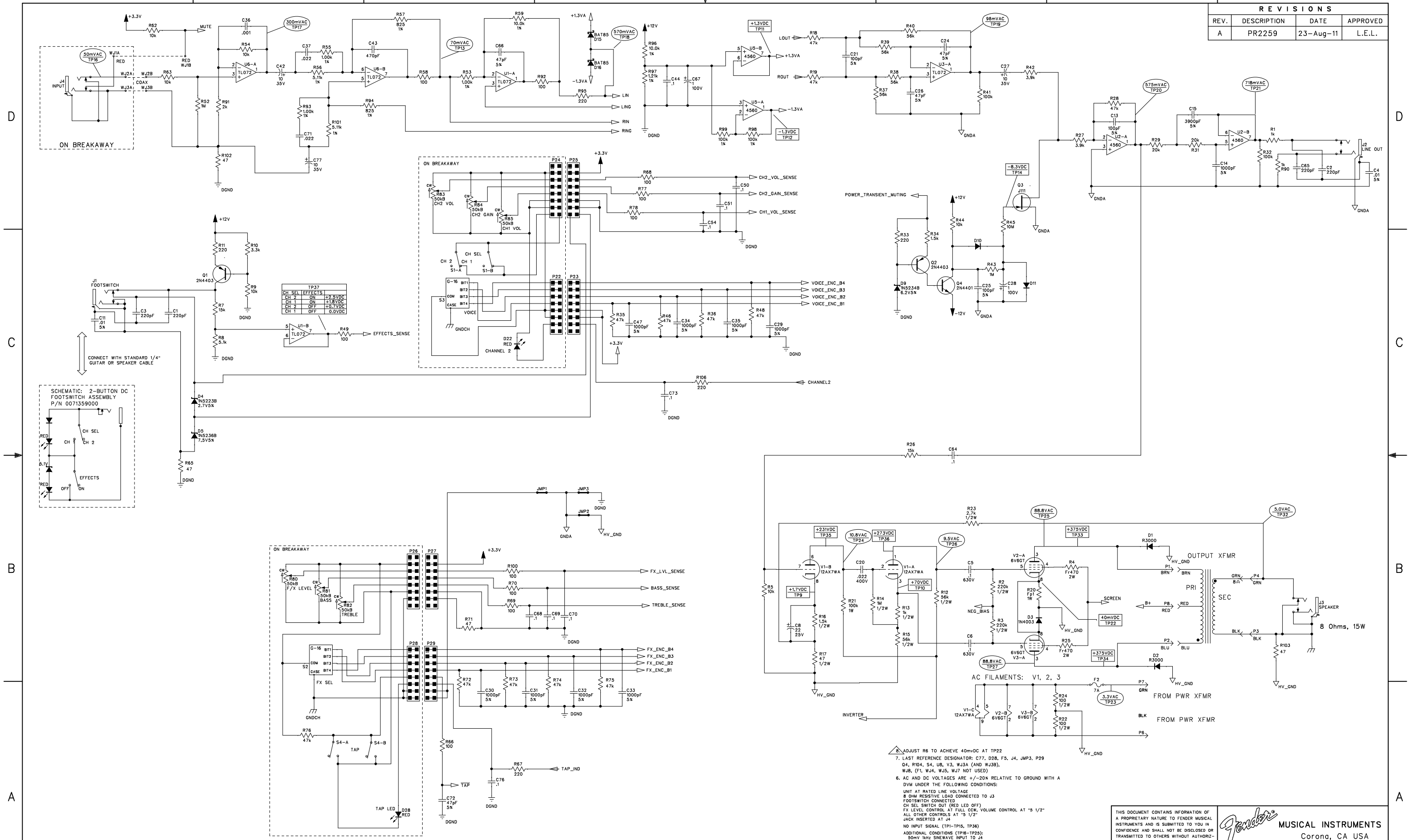

D
C
B
A

D
C
B
A

- ADJUST R6 TO ACHIEVE 40mVDC AT TP22
7. LAST REFERENCE DESIGNATOR: C77, D28, F5, J4, JMP3, P29
- Q4, R104, S4, U8, V3, WJ3A (AND WJ3B), WJ8, (F1, WJ4, WJ5, WJ7 NOT USED)
6. AC AND DC VOLTAGES ARE +/-20% RELATIVE TO GROUND WITH A DVM UNDER THE FOLLOWING CONDITIONS:
 UNIT AT RATED LINE VOLTAGE
 8 OHM RESISTIVE LOAD CONNECTED TO J3
 FOOTSWITCH CONNECTED
 CH SEL SWITCH OUT (RED LED OFF)
 FX LEVEL CONTROL AT FULL CON. VOLUME CONTROL AT "5 1/2"
 ALL OTHER CONTROLS AT "5 1/2"
 JACK INSERTED AT J4
- NO INPUT SIGNAL (TP1-TP15, TP34)
 ADDITIONAL CONDITIONS (TP16-TP25):
 50mV 1kHz SINEWAVE INPUT TO J4
- ADJUST R6 TO ACHIEVE 40mV AT TP22
5. THIS SCHEMATIC IS FOR PCB FABRICATION P/N 0091242000 AND PCB ASSEMBLY P/N 009125000
4. UNLESS OTHERWISE SPECIFIED, ALL DIODES ARE 1N4448.
3. ALL POLARIZED CAPACITORS IN UF, 20%; 50V MINIMUM.
2. ALL UNPOLARIZED CAPACITORS IN uF, 10% OR BETTER; 50V MINIMUM. (POWER SUPPLY BYPASS CAPACITORS ARE 20%).
1. ALL RESISTORS IN OHMS, 5%; 1/4W.
- NOTES: (UNLESS OTHERWISE NOTED)

THIS DOCUMENT CONTAINS INFORMATION OF A PROPRIETARY NATURE TO FENDER MUSICAL INSTRUMENTS AND IS SUBMITTED TO YOU IN CONFIDENCE AND SHALL NOT BE DISCLOSED OR TRANSMITTED TO OTHERS WITHOUT AUTHORIZATION FROM FENDER MUSICAL INSTRUMENTS.		MUSICAL INSTRUMENTS Corona, CA USA	
CHECKED BY:	DATE:	TITLE: SERVICE DIAGRAM, COMBINED (schematic)	DATE:
APPROVED BY:	DATE:	SUPER CHAMP X2 MAIN PCB	SIZE: DRAWING NUMBER
DRAWN: CURTIS	ENGR: CURTIS	D 009123000	REV. A
DATABASE FILE: Z225951	RELEASE DATE: 17-JUN-11	SHEET: 1 OF 3	

REVISIONS			
REV.	DESCRIPTION	DATE	APPROVED
2	PR2259	13-SEP-11	D.C.

D
C
B
A

D
C
B
A

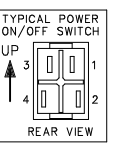
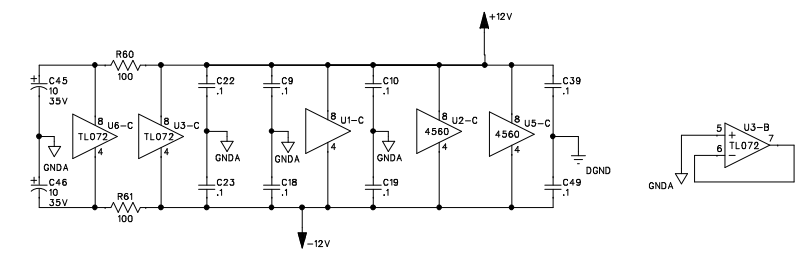
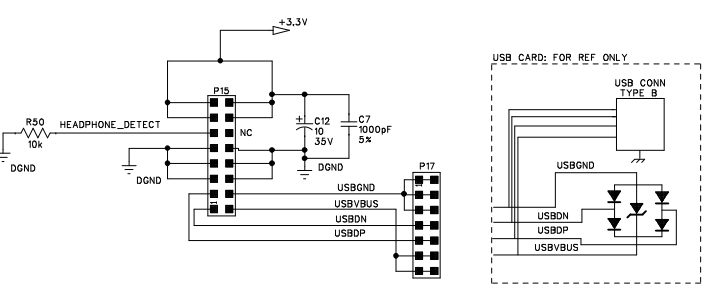
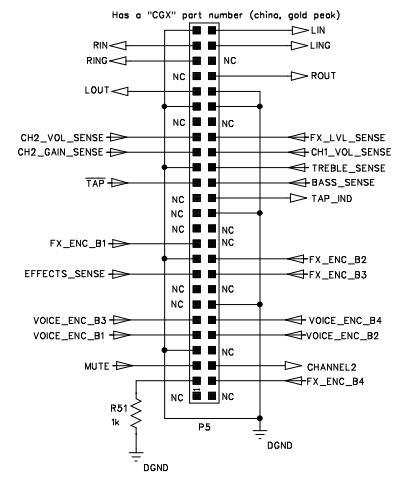

ALL FASTONS ARE 0.250" EXCEPT P105 WHICH IS 0.187"

100V	120V	220V - 240V
3.0A FAST 250V	3.0A FAST 250V	1.6A FAST 250V

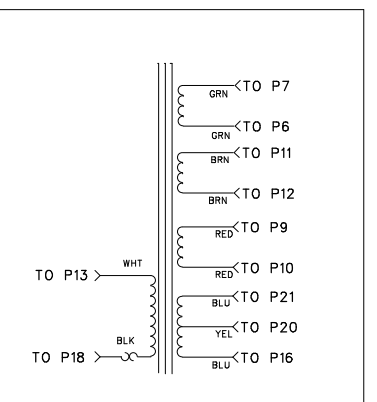
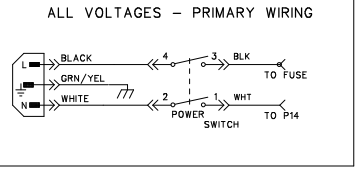

100V, 120V 230V and 240V TRANSFORMER WIRING

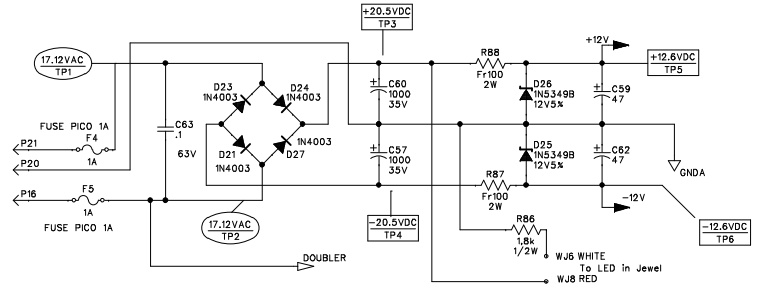
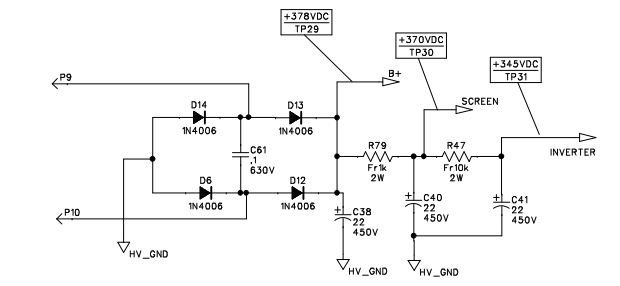
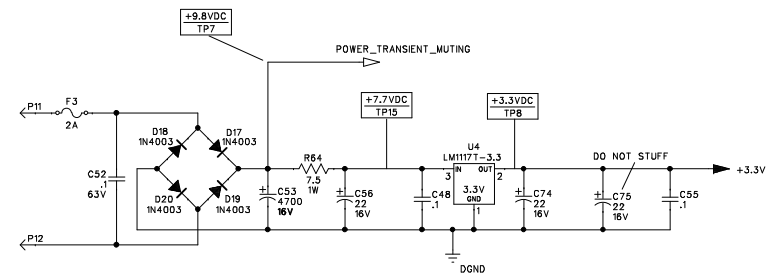
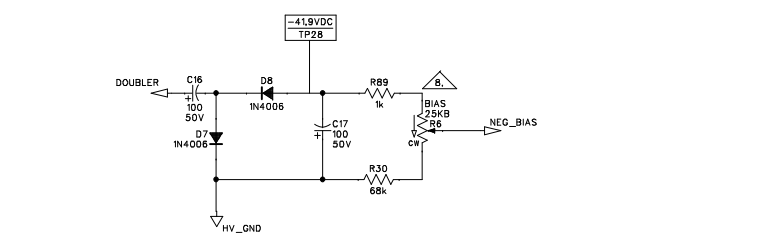

THIS DOCUMENT CONTAINS INFORMATION OF A PROPRIETARY NATURE TO FENDER MUSICAL INSTRUMENTS AND IS SUBMITTED TO YOU IN CONFIDENCE AND SHALL NOT BE DISCLOSED OR TRANSMITTED TO OTHERS WITHOUT AUTHORIZATION FROM FENDER MUSICAL INSTRUMENTS.		<p>MUSICAL INSTRUMENTS Corona, CA U.S.A.</p>		
CHECKED BY: _____ DATE: _____				TITLE: SERVICE DIAGRAM, COMBINED (schematic) SUPERCHAMP X2 MAIN PCB
APPROVED BY: _____ DATE: _____		SIZE: _____	DRAWING NUMBER: 009123000	REV: 4
DRAWN: CURTIS ENGR: CURTIS		DATABASE FILE: Z2259P1 rev 4.X RELEASE DATE: xx-xx-11 SHEET: 2 OF 3		

8

7

6

5

4

3

2

1

REVISIONS			
REV.	DESCRIPTION	DATE	APPROVED
A	PR2259	13-SEP-11	D.C.

D

D

C

C

B

B

A

A

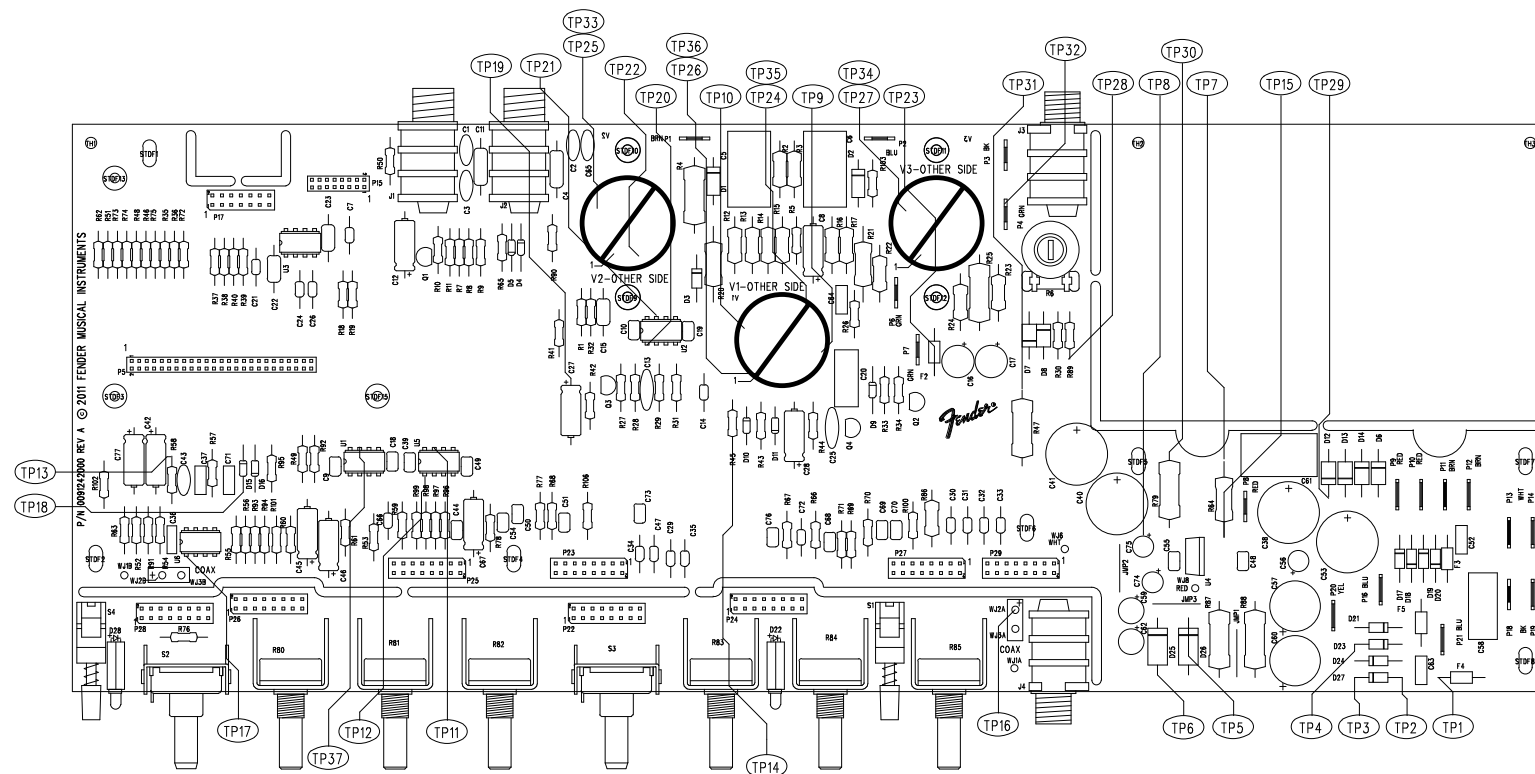

FILM/DWG: SERVICE DIAGRAM
 DATABASE: Z2259P1PCB DATE: 13-SEP-11

NOTES: (UNLESS OTHERWISE NOTED)

THIS DOCUMENT CONTAINS INFORMATION OF A PROPRIETARY NATURE TO FENDER MUSICAL INSTRUMENTS AND IS SUBMITTED TO YOU IN CONFIDENCE AND SHALL NOT BE DISCLOSED OR TRANSMITTED TO OTHERS WITHOUT AUTHORIZATION FROM FENDER MUSICAL INSTRUMENTS.		 MUSICAL INSTRUMENTS Corona, CA U.S.A.	
CHECKED BY: _____	TITLE: SERVICE DIAGRAM, COMBINED (PCB assy) SUPER CHAMP X2 MAIN PCB		
DATE: _____	SIZE: D	DRAWING NUMBER: 0091230000	REV. A
APPROVED BY: _____	DRAWN: CORBIN	ENGR: D. CURTIS	RELEASE DATE: 17-JUN-11
DATE: _____	DATABASE FILE: Z2259P1PCB	SHEET 3	OF 3

8

7

6

5

4

3

2

1