

WURLITZER

Electronic Piano Notes

Your questions or comments on

"Electronic Piano Notes" are welcome at any time.

Issued by Wurlitzer Service Dept., DeKalb, Illinois

NO. 12
DATE May 1, 1959
TITLE Simplified Regulating
Procedure for E. P.
Actions

Model 112 (Wood & Brooks Action)

1. Establish key height - should be $1\frac{13}{32}$ " from top surface of key - frame.
2. Level keys to above key height, but maintain $\frac{3}{8}$ " key dip on naturals, $\frac{5}{16}$ " key dip on sharps.
3. Check bar height - should be $4\frac{15}{16}$ ", both bass and treble.
4. Adjust capstans just to lost motion. This should give a blow distance of approximately $\frac{7}{8}$ " measured from tip of hammer to reed.
5. Adjust let off so that the hammer comes to approximately $\frac{1}{8}$ " from reed with $\frac{1}{32}$ " after touch.

Model 112A, 120, 700 (Pratt - Read Action)

1. Establish key height - should be $1\frac{15}{32}$ " from top surface of key - frame.
2. Level key to above height - maintain $\frac{13}{32}$ " key dip on naturals and $\frac{11}{32}$ " key dip on sharps.
3. Check bar height - should be 5" in the bass, $4\frac{15}{16}$ " in the treble.
4. Adjust capstans so that the tip of the hammers are approximately $1\frac{13}{16}$ " from the reed or $3\frac{13}{16}$ " from the key bed.
5. Adjust let off so that the tip of the hammer is approximately $\frac{1}{8}$ " from the reed in the treble, $\frac{3}{16}$ " from the reed in the bass with $\frac{1}{32}$ " after touch.

Note: This is a simplified procedure and is not to conflict with, or take the place of the service manual. For answers to further questions or details, refer to your service manual.

Richard L. Carlson
Richard L. Carlson
Assistant Service Manager

WURLITZER

Piano Notes

Your questions or comments on
"Piano Notes" are welcome at any time.

Issued by Wurlitzer Service Dept., DeKalb, Illinois

Piano Note No. 4

January 23, 1968

SHRINKING SOLUTION

For many years we have recommended the use of a water and alcohol solution for treating sluggish action centers.

However, for the past year we've been using a different solution and have found it to be superior to the alcohol/water mixture. The new solution consists of eight (8) parts naphtha and one (1) part mineral oil.

The advantages of the naphtha/mineral oil solution are:

1. Very fast drying.
2. Instant shrink. No need to wait overnight for action centers to dry.
3. No ill affects on flange screws or hammer travel.
4. Tests have shown that centers treated with naphtha/mineral oil will remain functional when submitted to high humidity conditions after the treatment.

While naphtha should be handled with care it shouldn't require any more precautions than were needed with alcohol.

Again, the mixture is: naphtha - 8 parts mineral oil - 1 part.

WURLITZER

Electronic Piano Notes

Your questions or comments on
"Electronic Piano Notes" are welcome at any time.

Issued by Wurlitzer Service Dept., DeKalb, Illinois

E.P. NOTE No. 14

DECEMBER 10, 1962

CIRCUIT MODIFICATION TO PROVIDE PROTECTION FOR TRANSISTOR "TR-1"

OCCASIONALLY, WHEN TUNING A REED OR SERVICING A REED BAR, AN ACCIDENTAL SHORT CIRCUIT, I.E., LEAD FILINGS, CAN OCCUR WHICH CAUSES A SPIKE PULSE TO SHOCK TRANSISTOR TR-1, RESULTING IN THE POSSIBLE FAILURE OF THE TRANSISTOR.

A 22K RESISTOR IS NOW BEING INCORPORATED BETWEEN THE INPUT PLUG AND C-1. WHENEVER SERVICING THE AMPLIFIER, WE SUGGEST YOU CHECK FOR THIS REVISION, AS ILLUSTRATED BELOW:

BEFORE

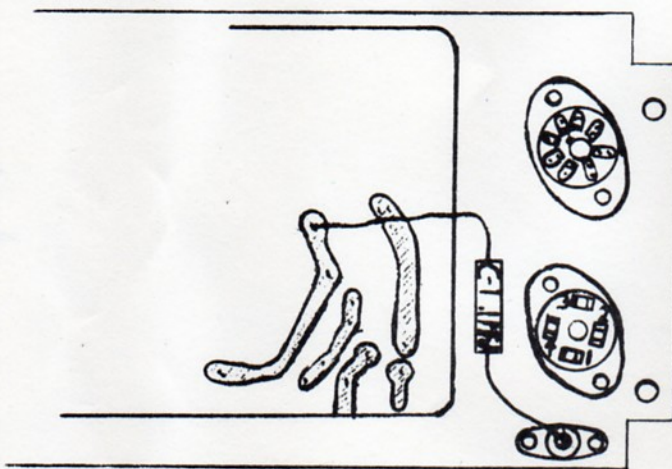

AFTER

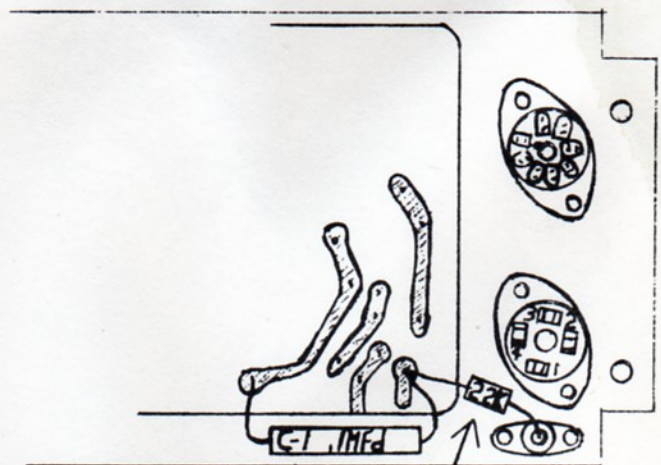

ADD THIS RESISTOR

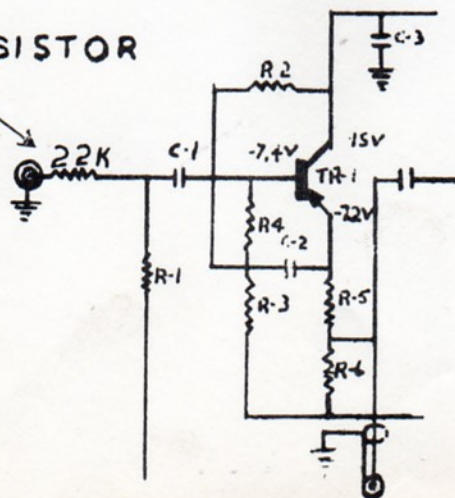

PHONO INPUT

ADD THIS RESISTOR

WURLITZER

Electronic Piano Notes

Your questions or comments on

"Electronic Piano Notes" are welcome at any time.

Issued by Wurlitzer Service Dept., DeKalb, Illinois

E.P. NOTE No. 15

JANUARY 21, 1963

CIRCUIT MODIFICATION TO REDUCE HUM IN MODEL 145 AND 720 ELECTRONIC PIANOS

SHOULD YOU ENCOUNTER EXCESSIVE HUM IN MODEL 145 OR 720 ELECTRONIC PIANOS BELOW SERIAL No. 30856 (MODEL 145,) OR SERIAL No. 40401 (MODEL 720,) MAKE THE CIRCUIT MODIFICATIONS AS SHOWN BELOW:

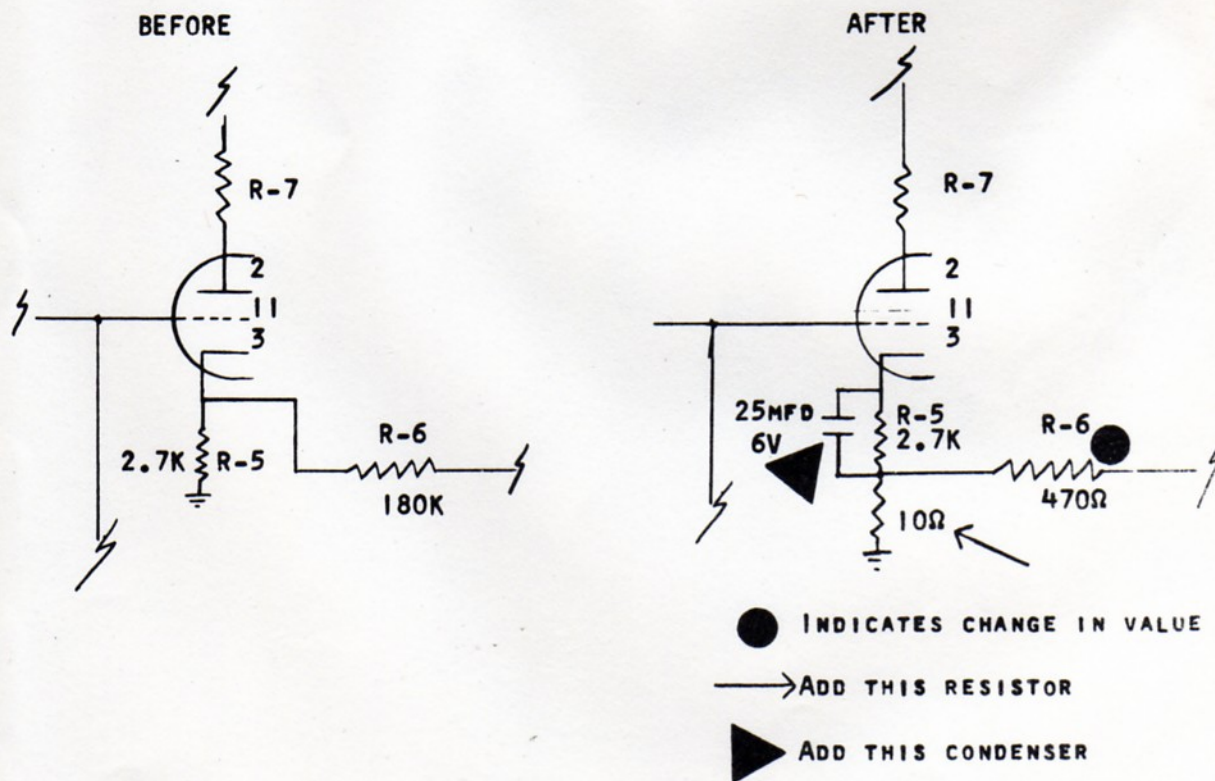

PARTS REQUIRED:

ONE	25MFD, 6 VOLT ELECTROLYTIC CONDENSER
ONE	10 OHM, 1/2 WATT RESISTOR
ONE	470 OHM, 1/2 WATT RESISTOR

THESE PARTS WILL BE FURNISHED FREE OF CHARGE BY THE DEKALB SERVICE DEPARTMENT UPON RECEIPT OF THE MODEL AND SERIAL NUMBER OF THE ELECTRONIC PIANO YOU ARE MODIFYING.

WURLITZER

Electronic Piano Notes

Your questions or comments on

"Electronic Piano Notes" are welcome at any time.

Issued by Wurlitzer Service Dept., DeKalb, Illinois

E.P. Note No. 16

August 17, 1964

140A-145A-720A
FLAT TONE OR "BUZZ" IN REED(S)

BEFORE removing a flat or "buzzing" reed from an electronic piano and BEFORE ordering replacement reeds, Be SURE TO CHECK THE REED WASHER.

A cracked washer between the reed and the screw that holds it to the reed bar will sometimes cause either a flat tone or a "buzz" in that reed. When this happens the only way to correct the condition is to replace the reed screw and washer.

The washer is captive on the screw and cannot be replaced separately. If a reed washer cracks it will be necessary to replace the screw assembly (reed screw and captive washer).

If you discover an electronic piano with one or more cracked washers, send the serial number of the piano, along with the number of screw assemblies you need to:

The Wurlitzer Company
Service Department
DeKalb, Illinois

A sufficient quantity of screws will then be mailed to you, without cost, upon receipt of your request.

WURLITZER

Electronic Piano Notes

Your questions or comments on

"Electronic Piano Notes" are welcome at any time.

Issued by Wurlitzer Service Dept., DeKalb, Illinois

E.P. Note No. 19

November 18, 1965

MODEL 930 ELECTRONIC PIANO AUXILIARY AMPLIFIER TRANSISTOR FAILURE

Should transistor failures be encountered in the Model 930 Electronic Piano Auxiliary Amplifier, it is suggested that one resistor be changed, and another resistor added to provide closer voltage regulation of the power supply. (Please refer to the schematic below and note the items in red.)

1. Remove the 27Ω resistor.
2. Replace with 50Ω, 10%, 5-watt resistor, (Part #74818-2).
3. Add 120Ω, 10%, 5-watt resistor (Part #74821-2) at point indicated.

The transistors most likely to be affected by this change will be TR-2, TR-3, TR-4, and TR-5.

We strongly suggest that any time a Model 930 Auxiliary Amplifier is serviced, a check be made to determine if these parts have been installed. If they have not, it would be wise to insert them in the circuit to provide a greater degree of protection and longevity.

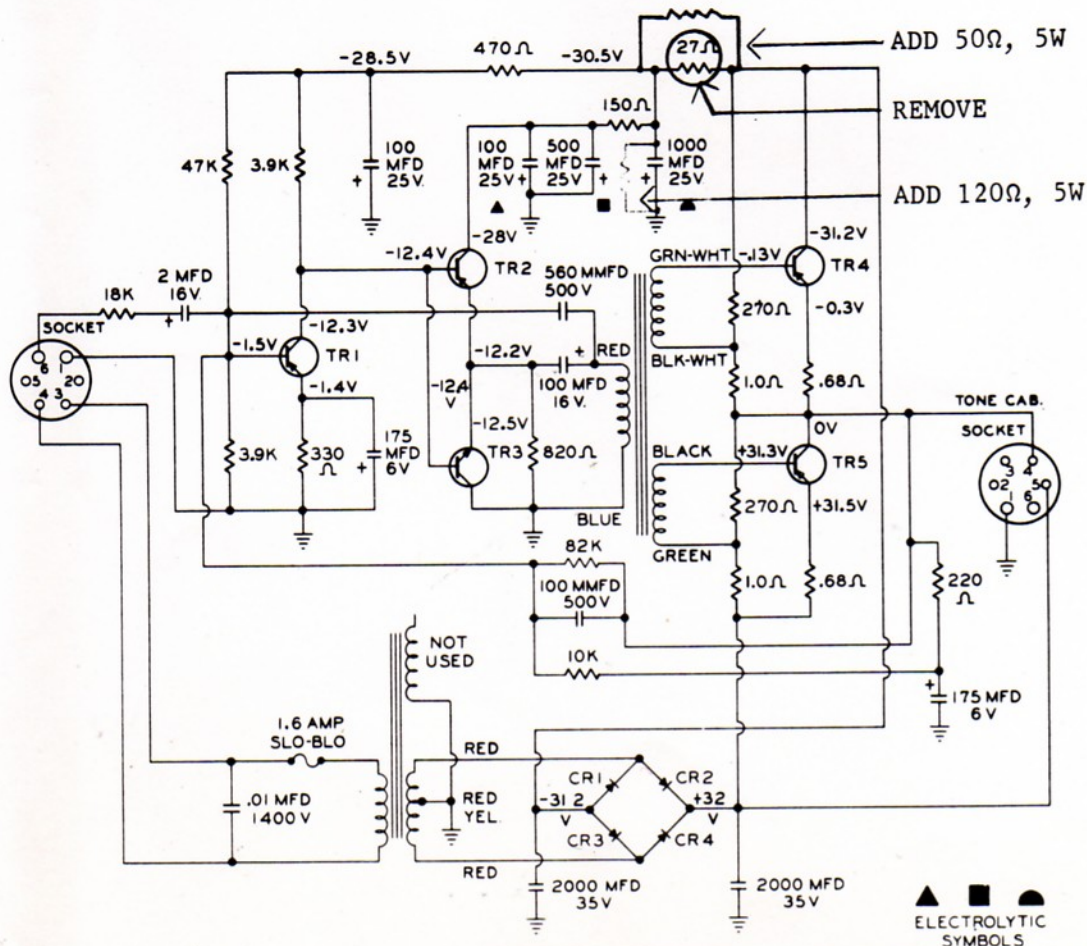

WURLITZER

Electronic Piano Notes

Your questions or comments on

"Electronic Piano Notes" are welcome at any time.

Issued by Wurlitzer Service Dept., DeKalb, Illinois

E.P. Note No. 20

Oct. 16, 1967

CHANGING THE COMMUNICATION NUMBER OF A STUDENT PIANO (Model 146 and 726) IN THE WURLITZER MUSIC LABORATORY

All Model 146 and 726 student pianos are numbered #1 through #6 on the left key block as pictured in Photo #1. The number that appears there designates the piano's number with the Electronic Communication Center, i.e. number 5 student piano will be in individual communication with the teacher only when #5 button in the Individual Instruction section on the Electronic Communication Center is activated, regardless of where the piano is physically located within its particular group.

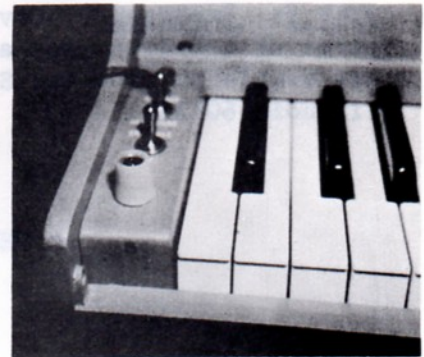

Photo #1 Piano Number 5

If, for any reason, it is desired to change the student piano's communication number, such as changing an existing number 1 piano to a number 4 piano, follow this procedure:

STEP 1: Remove the two retaining screws on each side of the ten pin male socket, as pictured in Photo #2. On the Model 146, this socket is on the right side of the back of the piano. On the Model 746 student pianos, first remove the back, which will make the ten pin male socket accessible.

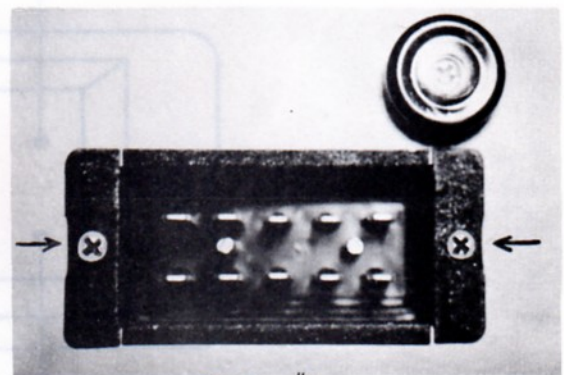

Photo #2

STEP 2: Pull the ten pin socket out of the piano toward you a few inches exposing the terminals of the wiring on the back side of the socket (as pictured in Photo #3).

NOTE: Disregard the moulded numbers 3 through 12 in front of each terminal.



Photo #3

Six wires attached to the six terminals (three front row, three back row) on the socket are color-coded. The color of the wire identifies the communication number of the pianos one through six. The diagram illustrates this.

Attached to one of the six terminal connections is a black wire in addition to the colored wire (refer to Photo #3). The color of the wire to which the black wire is joined will determine the number of that particular piano. See diagram.

STEP 3: To change the communication number of the piano remove the black wire and solder it to the desired terminal for the new number.

STEP 4: Place the socket back in the piano and put in retaining screws.

STEP 5: Important: Cover the original number on the left key block with a piece of adhesive tape and imprint thereon the new number. (Numbered decals are available from the Service Department, The Wurlitzer Company, DeKalb, Illinois 60115).

DIAGRAM OF THE BACK OF
A TEN PIN MALE SOCKET (TOP VIEW)

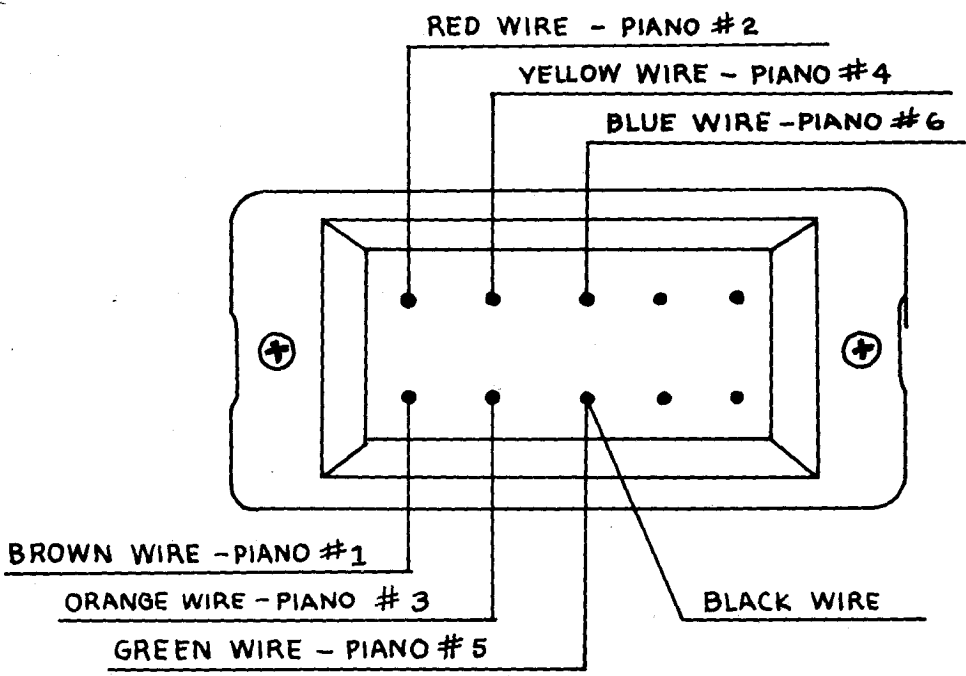

The terminal at which the black wire, in addition to the colored wire, is soldered will determine the number of that particular piano. For example, by soldering the black wire to the terminal with the green wire -- the piano becomes a #5.

WURLITZER

Electronic Piano Notes

Your questions or comments on

"Electronic Piano Notes" are welcome at any time.

Issued by Wurlitzer Service Dept., DeKalb, Illinois 60115

Electronic Piano Note No. 21

May 19, 1969

SYMPTOM : Notes that sustain after the key is released.

CAUSE : Dampers not returning.

CORRECTION: CAUTION - Disconnect AC plug from wall outlet.

1. Be sure there is at least 1/32" between the head of the adjusting screw at the back of the damper and the grey grommet. (Turn the screw counterclockwise to get a wider gap.)
2. See if the damper felt is making contact on the reed and has not been forced forward or back so it is resting on a reed plate or the pickup. (Note #43 thru #52 have reed plates.)
3. If neither of the above correct the trouble, adjust the pedal cable or the hex nut on the damper lift rod, so the damper felts rest fully on the reeds.
4. NOTE: There should be a 1/64" to 1/32" gap between the bottom of each damper lever and the strip of red felt on top of the damper lift rails. If there is no gap, use the following procedure:
 - 4.1 Disconnect piano from AC outlet.
 - 4.2 Remove lower front panel. (203-206-207)
 - 4.3 Remove the two round head Phillips head screws and the clamp from near the top of the pedal cable.
 - 4.4 Unscrew the knurled sleeve at the top of the cable from the damper lift rod.
 - 4.5 If the small steel block to which the cable clamp is screwed is located three or four inches below the keybed, remove the one flat head Phillips head screw and the steel block. If it is seven or eight inches below the keybed, this will not be necessary.

(over)

- 4.6 With a 7/16" nut driver, loosen the hex nut near the bottom of the damper lift rod about one half of a turn or until you can see a 1/64" to 1/32" gap between the red felt on the damper rail and the bottom of the damper levers. Try individual notes to be sure all are dampening properly.
- 4.7 If it was necessary to remove steel block in step 4.5, put block back in place with the flat head Phillips head screw.
- 4.8 Screw knurled sleeve on end of pedal cable on the damper lift rod until it tightens snugly against the hex nut you adjusted.
- 4.9 Clamp the cable back in place with the clamp and two screws into the steel block. Do not tighten screws yet.
- 4.10 The cable should be pulled down with the left hand until it starts to pull hard, then let it back up about 1/16" so there is still a gap between the damper rail felt and the damper levers. Tighten both screws evenly and as tight as possible.
- 4.101 Notes should all dampen properly now.
- 4.11 Recheck the regulating screws at the back of the damper levers for 1/32" clearance to the rubber grommets.
- 4.12 Install lower front panel, top and plug into AC outlet.