



# User Guide



InnovaSON  
ZC du Kenyah  
56400 Plougoumen  
France

**Sensoft 8.1 full  
Sensoft 9 installation**

**(Sensoft 9 Addendum updates  
sections 3 and 4 of this user guide)**

April 2005





Headquarters  
Zone du Kenyah  
F-56400 Plougoumelen  
FRANCE  
tel : +33 (0) 297 24.34.34  
fax : +33 (0) 297 24.34.30  
[www.innovason.com](http://www.innovason.com)

**Attention:** veuillez consulter le chapitre 10 avant toute manutention ou utilisation de la console.  
**Warning:** please read carefully section 10 before handling or using the console.  
**Achtung:** bitte lesen sie zuerst Kapitell 10 for jedem Verladen oder Verwendung des Pultes.

## Table of Contents

Section	Page	Section	Page
<b>1</b>	<b>Digital mixing in Live sound</b>	<b>4</b>	<b>Digital mixing in Live Sound</b>
<b>1.A</b>	<b>Sensoft 8.1 :a brief history</b>	<b>4.A</b>	<b>Basic principle of the control surface</b>
<b>1.B</b>	<b>Fader assignment</b>	4.A.1	Control surface layout
<b>1.C</b>	<b>The assignable functions</b>	4.A.2	Fader configuration : The Hardware Configuration window
<b>1.D</b>	<b>Spread zones</b>	<b>4.B</b>	<b>Audio inputs</b>
<b>2</b>	<b>THE Sy48 CONSOLE</b>	4.B.1	General characteristics
<b>2.A</b>	<b>Sy48 : Overview of the product</b>	4.B.2	Layout of physical inputs
<b>2.B</b>	<b>Personalization, options</b>	4.B.3	Universal analog inputs
2.B.1	L.E.M : Optional External Mix Box	4.B.4	Analog line inputs
<b>2.C</b>	<b>Description of the Sy48</b>	4.B.5	Distant inputs (Stage Box)
2.C.1	Dimensions and general information	<b>4.C</b>	<b>Input signal path</b>
2.C.2	The Quadfad module	4.C.1	XFAD : the principles
2.C.3	The CHANNEL CONTROL panel	4.C.2	Preamp to fader assignment grid (PATCH IN)
2.C.4	Screen and UTILITIES panel	4.C.3	Pre-amp settings (Gain, 48V)
2.C.5	On the front of the console	4.C.4	Delay
2.C.6	On the back of the console	4.C.5	Phase inversion and the high-pass filter
2.C.7	Control layout	4.C.6	Dynamics
<b>2.D</b>	<b>Precautionary measures, safety and warnings</b>	4.C.7	Equalizer
<b>2.E</b>	<b>Manipulation and transport</b>	4.C.8	Inserting an external device
<b>2.F</b>	<b>Power supplies and EC standards</b>	4.C.9	MUTE and CUE functions
<b>2.G</b>	<b>Connections</b>	<b>4.D</b>	<b>Mix busses</b>
2.G.1	Audio connections	4.D.1	DSP resources: some important points
2.G.2	Internal Screen, external Screen	4.D.2	Spreading the outputs
2.G.3	Connecting MIDI equipment	4.D.3	Assignment of mix busses to physical outputs (Patch OUT)
2.G.4	Connection of an external power supply	4.D.4	Basic principles of routing
2.G.5	Connecting an external PC	4.D.5	Definition 'pre/post fader' and Pan settings on busses
2.G.6	Connecting an optional Stage-Box	4.D.6	A special bus : the Matrix
2.G.7	Digital audio clock sync with external devices	4.D.7	The Monitor bus
2.G.8	Connecting headphones	4.D.8	Master busses
<b>2.H</b>	<b>Powering up</b>	4.D.9	Bus processing and inserts
2.H.1	Power up sequence	4.D.10	Hyperdrive outputs' processing control
2.H.2	First checks	4.D.11	Principles of fader functions, Fader Mode
<b>3</b>	<b>Sensoft 8.1</b>	4.D.12	MUTE and CUE functions
<b>3.A</b>	<b>Your first mix : a simple step-by step example</b>	<b>4.E</b>	<b>The MUXIPAIRE bus, the Direct I/O grid</b>
3.A.1	Console configuration	4.E.1	The Direct I/O grid
3.A.2	Patching..	<b>4.F</b>	<b>The VCA function</b>
3.A.3	Some routing	4.F.1	VCA function logic
3.A.4	Creating and using a subgroup	4.F.2	VCA Assignment
3.A.5	Spreading inouts	<b>4.G</b>	<b>Talk-Back</b>
3.A.6	Creating and using a VCA		
3.A.7	Spreading a Master		
3.A.8	Spreading an Aux		
3.A.9	Creating a matrix		

## 2 | TABLE OF CONTENTS

Section	Page		Page
<b>5</b>	<b>Structure of a performance</b>	5.1	7.B.2 The PATCH IN grid window 7.3
<b>5.A</b>	<b>General description</b>	5.1	7.B.3 The PATCH OUT grid window 7.5
<b>5.B</b>	<b>Files and pages management</b>	5.1	7.B.4 The DIRECT I/O and Insert Grid window 7.6
5.B.1	File edition	5.1	7.B.5 The LINK CHANNEL window 7.7
5.B.2	Changing a file	5.4	7.B.6 The LINK I/O window 7.8
5.B.3	Saving a file	5.4	7.B.7 The RELAX, FADER-START and MUTE MIDI MESSAGE windows 7.9
5.B.4	Exporting, Importing, deleting a file	5.5	7.B.8 The PAN window 7.10
<b>5.C</b>	<b>Pages management</b>	5.6	7.B.9 The PASTE and OVERRAM windows 7.11
5.C.1	Saving a page	5.6	7.B.10 The MUXI window 7.13
5.C.2	LOAD and GOTO a page	5.6	7.B.11 The main MIX window 7.14
5.C.3	Inserting a page	5.7	<b>7.C</b> <b>Summary of function access</b> 7.16
<b>5.D</b>	<b>Navigating in a file</b>	5.8	<b>8</b> <b>INSTALLING AND CONFIGURING SENSOFT 9</b> 8.1
<b>5.E</b>	<b>Automation (sequencing , calling up pages)</b>	5.9	<b>8.A</b> <b>Downloading and preparing the installation</b> 8.1
5.E.1	Generalities	5.9	<b>8.B</b> <b>Installing SENSOFT</b> 8.2
5.E.2	MIDI Program Change OUT	5.9	8.B.1 Re-installation, new version 8.2
5.E.3	MIDI Program Change IN	5.11	8.B.2 Updating, new 'release' 8.4
5.E.4	MIDI Time Code Automation	5.12	8.B.3 Installing the Windows XPE operating system 8.5
5.E.5	Cross-Fade	5.14	<b>8.C</b> <b>Configuration</b> 8.8
5.E.6	The Cross-Time Fader	5.16	<b>8.D</b> <b>Importing files created with earlier versions of Sensoft</b> 8.10
<b>6</b>	<b>Advanced Functions</b>	6.1	8.D.1 Grand Live files 8.10
<b>6.A</b>	<b>Generator and oscillator</b>	6.1	8.D.2 Sy40 files 8.10
<b>6.B</b>	<b>FLAT function for resetting parameters</b>	6.1	<b>8.E</b> <b>Firmware update for DSP Sy48 and DSP Sy80</b> 8.11
<b>6.C</b>	<b>Copy and Paste</b>	6.2	8.E.1 Launching the « DSP Loader » software 8.12
<b>6.D</b>	<b>OverRam - Updating pages in RAM</b>	6.3	<b>8.F</b> <b>Installing Sensoft on an external PC</b> 8.16
<b>6.E</b>	<b>Relax Mode - disconnecting parameters from the automation</b>	6.5	<b>9</b> <b>Design Features</b> 9.1
<b>6.F</b>	<b>Link I/O - Input/ Output parameter links</b>	6.6	<b>9.A</b> <b>Introduction</b> 9.1
6.F.1	What are I/O parameters ?	6.6	<b>9.B</b> <b>Audio rack and modules</b> 9.2
6.F.2	The link I/O grid	6.6	9.B.1 SI-8D Module 9.3
<b>6.G</b>	<b>Link Channel – channel parameter links</b>	6.7	9.B.2 SI-8D3 Module 9.4
6.G.1	What are the channel parameters ?	6.7	9.B.3 MO-8D3 Module 9.5
6.G.2	The channel link grid	6.8	9.B.4 XO-8D2 Module 9.6
<b>6.H</b>	<b>Temporary cancellation of a link</b>	6.9	9.B.5 DI-8S Module 9.7
<b>6.I</b>	<b>MUXI window – display and modification of outputs</b>	6.10	9.B.6 DI-8Src Module 9.8
<b>6.J</b>	<b>Off Line – disconnecting the console from the audio racks</b>	6.11	9.B.7 DO-8A Module 9.9
<b>6.K</b>	<b>Processing libraries</b>	6.12	9.B.8 DO-8X Module 9.10
6.K.1	The BANK Menu and general operation	6.12	9.B.8B DO-8XES Module 9.10B
6.K.2	Save and load shortcuts	6.13	9.B.9 DSP Sy80 Module 9.11
<b>6.L</b>	<b>Request Mode (RQST)</b>	6.13	9.B.10 DSP Sy40-8 Module 9.12
<b>6.M</b>	<b>The ADJ function – automatic adjustment of preamps</b>	6.15	9.B.11 DM-Mk9 Module 9.13
<b>6.N</b>	<b>Sending MIDI messages using the MUTE buttons</b>	6.16	9.B.12 MC-64 Module 9.14
<b>6.O</b>	<b>Sending Fader Start MIDI messages</b>	6.17	9.B.13 SC-64 Module 9.15
<b>6.P</b>	<b>LOCK – Password Protection for the console</b>	6.18	9.B.14 SC-643tx Module 9.16
<b>6.Q</b>	<b>The General Preferences window</b>	6.20	9.B.15 Sync-A Module 9.17
<b>7</b>	<b>Sensoft Offline</b>	7.1	<b>9.C</b> <b>System Configuration and installation</b> 9.18
<b>7.A</b>	<b>General operation of the mouse and keyboard</b>	7.1	9.C.1 Use of Stage Box general rule 9.18
<b>7.B</b>	<b>Detailed operation and access to the various windows</b>	7.2	9.C.2 Modules installation and racks configuration 9.20
7.B.1	The HARDWARE CONFIGURATION window	7.2	9.C.3 MASTER console definition 9.20
			9.C.4 Powering-up 9.21
			<b>9.D</b> <b>Transmission on coaxial cable</b> 9.22
			9.D.1 BNC connections 9.22
			9.D.2 Earth and perturbations 9.23
			9.D.3 Transmission defaults and adjustments 9.23

---

<b>9.E</b>	<b>Appendices</b>	<b>9.24</b>
9.E.1	Audio rack general Characteristics	9.24
9.E.2	Audio specifications	9.24
9.E.3	Signal path	9.26
9.E.4	EtherSound applications	9.27
<b>10</b>	<b>Sécurité . Safety . Wichtige.</b>	<b>10.1</b>
<b>10.A</b>	<b>Précautions, sécurité, avertissements. Important messages - Wichtige Hinweise.</b>	<b>10.1</b>
10.A.1	Symboles - Symbols - Symbole	10.1
10.A.2	Dangers - Warning - Achtung	10.2
10.A.3	Avvertissements - Cautions - Vorsicht	10.2
10.A.4	Remarques sur l'utilisation - Operating notes - Hinweise zum Betrieb	10.3

# 1 DIGITAL MIXING IN LIVE SOUND

## 1.A Sensoft 8.1: a brief history

Several years have passed since InnovaSON introduced the first digital system designed to meet the needs of LIVE SOUND production: artists on-stage, impatient producers (tight budgets), live sound quality identical to studio recordings, complex productions, etc.

**LIVE**, for InnovaSON, is a “keyword” reflected in the products; products that are reliable, sturdy, and capable of working without a problem, show after show. Thought was not only given to limit size and excess weight (as freight in a lorry, car or plane), but also to speed up the installation, and especially to “free the spirit of the sound engineer”, an essential condition in the creation of quality live performances.

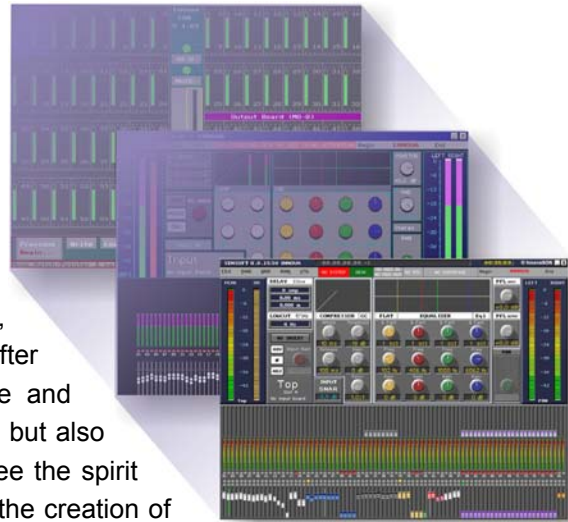

Thanks to the success of the **MUXIPAIRE** system, InnovaSON was in touch with numerous users, who all wished for a digital mixing desk that would, at last, satisfy all their requirements for live shows in the 21st century:

- Total memory of the functions necessary for complete audio signal processing
- Immediate reminder of the state of the whole console
- Simple to use in spite of sophisticated automation
- Sound quality without compromise
- All the advantages of a completely computerised digital system

These are the essentials that InnovaSON settled on throughout the design of its range of digital consoles.

Designed from standard elements in InnovaSON’s modular (or custom) digital audio systems, InnovaSON consoles now benefit from the field experience gained from those previous products.

All the team at InnovaSON sincerely thank all those who brought another small stone to the structure, by their suggestions, particular requirements, or sensible comments. Although completely digital, InnovaSON consoles will not upset a user brought up on classic analogue systems; on the contrary, their original three-part concept (mixing desk, local and distant audio system racks), brings more flexibility and quality, without compromise.

Our greatest satisfaction will be to learn that each user has found, in Live Sound, a work tool perfectly adapted to their needs.

## 1.B Fader assignment

Sensoft 8.1 brings something new to the world of Live Sound – you define the number and position of all the functions necessary for your mix.

Naturally this number is determined, on one hand, by the number of faders on your control surface and, on the other hand, by the available DSP resources in your system.

The figure below gives the maximum number of resources that Sensoft 8.1 can handle on various InnovaSON consoles.

**Resources available on InnovaSON consoles**

Console	Faders	DSP module	Mix busses	Input channels	Monitor circuits
<b>Sy40</b>	47+1	DSP Sy40-8	26	48	3
<b>Sensory Live (Upgrade Sy80)</b>	71+1	DSP Sy80	48 = 32+16	80	3
<b>Sy80</b>	80	DSP Sy80	48 = 32+16	80	3
<b>Sensory Live (for the record)</b>	71+1	DMMk-9	23	48	1

Console faders can handle inputs coming from distant and local audio racks, as well as controlling the busses necessary for the different mixes required for these inputs.



## 1.C The assignable functions

Each of the console faders can handle the following functions:

	<b>Input :</b>	Fader controlling an input or a group of inputs assigned to an XFAD
	<b>XFAD™ :</b>	Fader controlling an input and an element of a spread group
	<b>Group :</b>	Fader controlling a group or a subgroup
	<b>Aux :</b>	Fader controlling an Aux bus
	<b>Left :</b>	Left bus of a selected group or aux
	<b>Right :</b>	Right bus of a selected group or aux
	<b>Center :</b>	Center bus of a selected group or aux
	<b>Mono :</b>	Mono bus of a selected group or aux
	<b>Master :</b>	Fader controlling a Master bus
	<b>Left :</b>	Left bus of a selected
	<b>Right :</b>	Right bus of a selected
	<b>Center :</b>	Center bus of a selected
	<b>Mono :</b>	Mono bus of a selected
	<b>Matrix :</b>	Fader controlling a Matrix bus
	<b>VCA :</b>	Fader controlling a VCA
	<b>Monitoring :</b>	Control of monitor level
	<b>Crossfade :</b>	Speed control of a real-time crossfade

Each of the console faders can handle the following functions:

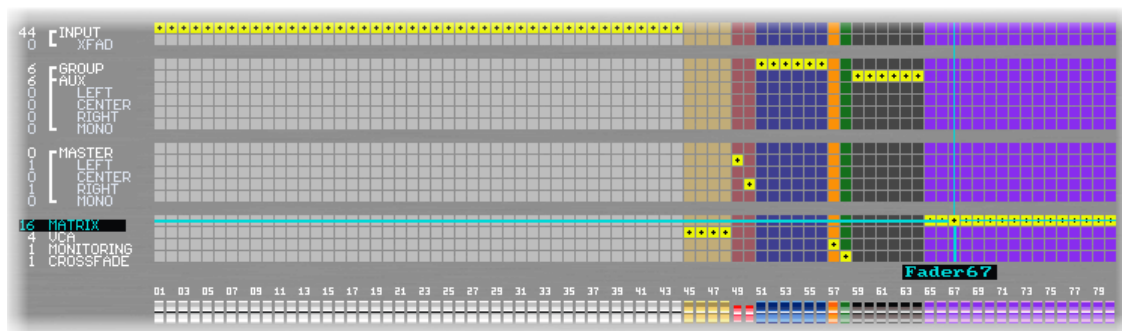

The number of faders available in this grid corresponds to that available on the console (shown here is the Sy80). The **Grid** functions in the same way for any console as long as it supports Sensoft 8.1. Later on in this manual we will show you how to access and use the configuration grid.



To give you the time to fully understand and master this feature, preset configurations allow you to quickly set the parameters of your console. Having first inserted the floppy disk “Examples”, use the **Import** function to load these standard configurations.

## 1.D Spread zones

Let’s take a few moments to consider the concept used by InnovaSON to exploit more physical inputs and mix busses than there are faders on the console, without having to resort to a system of layers. As you saw previously, InnovaSON designs consoles dedicated to, among other situations, live applications. It was therefore important to establish a design that took note of the following points:

- A console with a size and weight lower than its analogue counterpart
- Retention of the user-friendliness inherent in software previous to Sensoft 8.1
- To always have a global view of the general state of the console on the monitor screen
- To have to hand the maximum number of controls, for fast and effective user reaction

This last point made InnovaSON decide to implement the **XFAD** function in the development of Sensoft 8.1.

Whether for the management of inputs or the management of busses, the general principle is the same: a full channel can control a single physical I/O or of a set of physical I/O. In the latter case, the channel can be compared to a “fader bank”, because every time it is selected, it spreads out all the channels it controls, in a zone defined by the user.

The principle of spread channels



The channels associated with one, or a group of, physical inputs

The spread zone as defined by the user, made up from as many XFAD as necessary

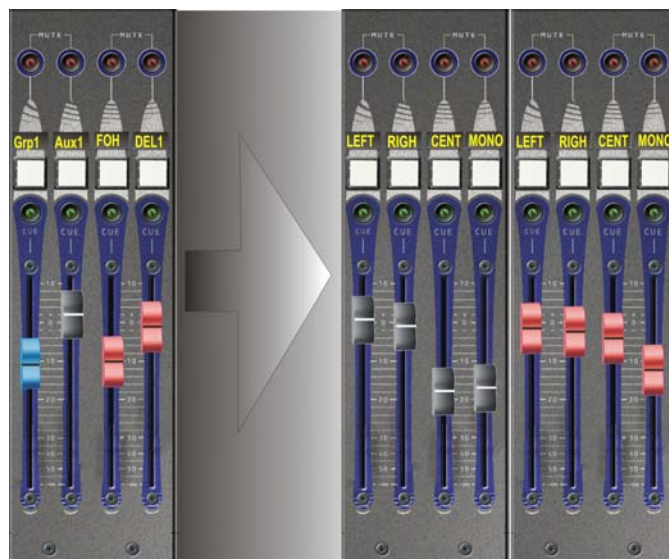

In the same way, Aux, Group or Master channels can spread their L, R, C and M busses if necessary, in this case you can compare them to "Bus Banks"

The figure above shows an example of 8 "banks", each spreading 16 XFAD inputs. A swift calculation shows that, in theory, you could control  $8 \times 16 = 128$  inputs with only  $8 + 16 = 24$  faders.....what a dream!

One of the major points of Sensoft 8.1 is that the number of "banks", and their arrangement as well as the number of channels spread by the "banks", is defined by the user. Each user can effectively "draw" the console according to their own needs.



## 2 THE Sy48 CONSOLE

### 2.A Sy48 : Overview of the product

The Sy48 console is a single block, 'all in one' system, with the local Mix Box and the control surface within the same frame. The Mix Box provides 6 slots for housing modules of 8 inputs or 8 outputs (analog, digital AES or Ethersound). Its modular structure lets you configure the inputs and outputs according to your needs. Hence, when used by itself, it can be equipped as shown below, with 32 mic/line inputs, 16 line inputs, 16 analog outputs with processing, and 16 line outputs.

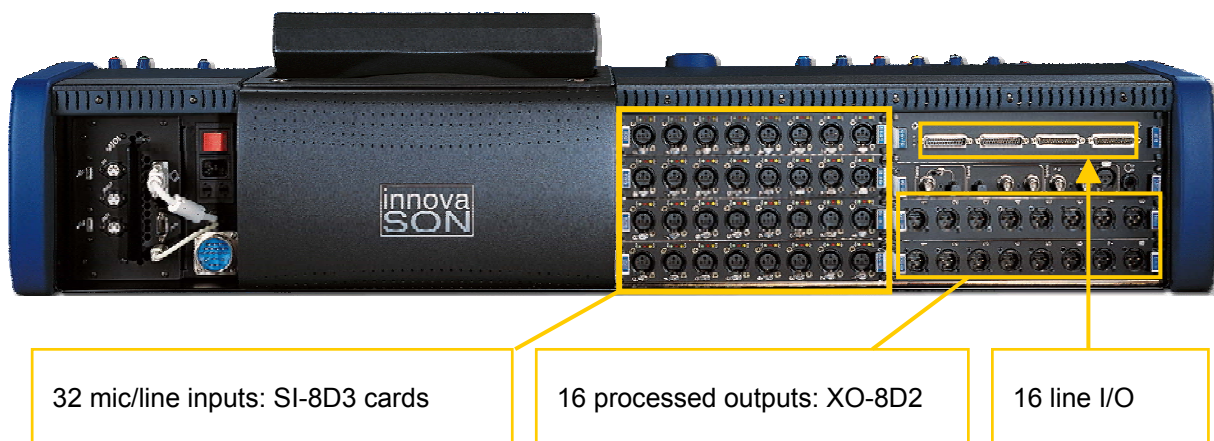

32 mic/line inputs: SI-8D3 cards

16 processed outputs: XO-8D2

16 line I/O

The platform features everything you expect from a digital mixing console in a particularly compact frame weighing less than 40 kg, including :

- 48 motorized and assignable faders with immediate access to the main parameters (selection, monitoring and mute)
- 48 LED bar-graphs for immediate metering of input or output signals
- A section for adjusting all the parameters of the current selected channel
- A section for managing memories
- A collapsible 12" screen for real time visualization of all the mix parameters
- An access panel to all the main functions (patches, monitoring, talkback circuit, ...)
- A PC computer handles everything in the system
- A keyboard/track-ball drawer for labeling and access to advanced functions
- Space reserved for the local audio rack, where the I/O modules, the MC-64 controller and the DSP Sy48 module can be found.

The digital aspect of the console is managed by the MC-Optical controller module, which generates the audio clocks, drives the bus, and handles communications with the console's integrated PC. This module is equipped with BNC and optical connectors dedicated for the connection of a Stage Box, which then allows the remote management of 48 Mic/line inputs and up to 32 mix busses. Therefore, the slots of the local Mix Box can be equipped with more output modules, which leads to a maximum of 6 analog or AES output modules, plus the 16 line outputs available on the SubD25 connector... that gives us a total of 64 local outputs.

Coaxial or optical cable transmission is not an option. Every InnovaSON platform is equipped with this transmission system. No need to invest in any format converter or other hardware to establish a connection between a Stage-Box and the Mix-Box. Just connect the MCOptical (card featured in the local rack) to the SCOptical (card featured in the remote rack) to immediately benefit from a digital transmission, where 64 channels can be exchanged between both audio racks..

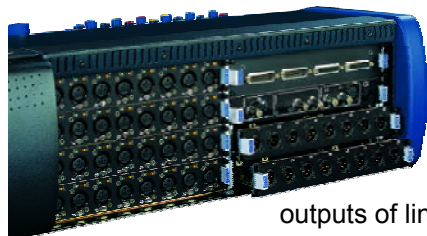

In the local audio rack, on top of the MCOPTICAL controller, one can find the DSP (digital signal processor) Sy48 module, which handles the digital processing of signals, and all the algorithms that the console functions may use. This module is equipped with 4 Sub-D 25 connectors which can manage 16 inputs and 16 outputs of line level signals, which therefore add up to the resources provided by the I/O cards of the rack. Four Sub-D / XLR adapter cables are provided with the console.



The firmware currently available in the DSP Sy48 card provides simultaneous mixing of 64 inputs (48 Muxi + 16 line inputs) to 34 mix busses (two of which are reserved for stereo monitoring). The mix busses have no predefined functionality. It's up to you to use them as groups, sub-groups, auxiliaries, masters, matrixes, ...



The inputs/outputs accessible via the SubD connectors can be used as line inputs or mix bus outputs, but also as Insert Send/Return pairs to insert external processors.

---

As with any InnovaSON console, once the input and output cables are connected to their designated devices, you no longer need to touch them. All patching operations are done electronically and are memorized – all of which is managed directly from the control surface.

The Control Surface is relatively easy to understand; even beginners will rapidly feel at ease with the digital mixing provided by the Sy48.

The various console channels are equipped with motorized faders which move into position rapidly, quietly, and even feature a “sensory point” that can be felt under your fingers. Therefore, you always have the last memorized position in mind.

The bar-graphs located just above the faders provide direct metering of various working levels, after processing (dynamics, EQ) or before processing (reflecting the output level of the pre-amps), depending on the option selected in the general preferences.

Last but not least, as soon as the console is switched on, the flat LCD screen displays the main mix window or, depending on preference settings, the other control windows of the platform. The internal computer drives the DSP in real time according to the actions taken by the user on the control surface. If necessary, the console's internal PC can be removed and replaced by the external PC connection kit. You can therefore control the platform from any PC on which Sensoft has been previously installed.



To make things easier in a given situation, provision has been made to replace the internal flat screen by another SVGA standard screen. The keyboard and mouse can also be relocated (or replaced) by removing them from their drawer.

## **2.B Personalization, options**

Each system, within certain limits, can be adapted to the latest performances and options of the InnovaSON range of products.

For this, please contact our authorized technical services for specific updates: DSP resources, Sensoft, advice, etc

### **2.B.1 L.E.M : optional External Mix Box**

In certain situations, it could be more practical to access the audio cards without having to go around to the back of the console. In these cases, The L.E.M. option (for Local External Mixbox) is the solution. You also benefit from 8 slots instead of the 6 inside the console.

The L.E.M. is equivalent to the Sy48's internal audio rack, except it is located outside of the console. All the modules that would normally be fitted in the console's internal rack are 100% compatible with the L.E.M.; no updating of the card is necessary to use the L.E.M.

The L.E.M. is the same local audio rack as the one used by the Sy80 platform. Therefore, you must follow the same rules concerning the location of the audio cards within the rack:

- Always start by the output cards (XO, MO, DO) and then finish by the input cards (SI, DI), if you are using any.
- The Stage-Box (is you are using one) will follow the inverse rule: first the input cards, then the output cards. Don't forget that the cards with the Hyperdrive option (XO-8D2, DO-8X, DO-8Xes) do not work in a Stage-Box. Only the MO and DO-8A are designed to work in a Stage-Box.

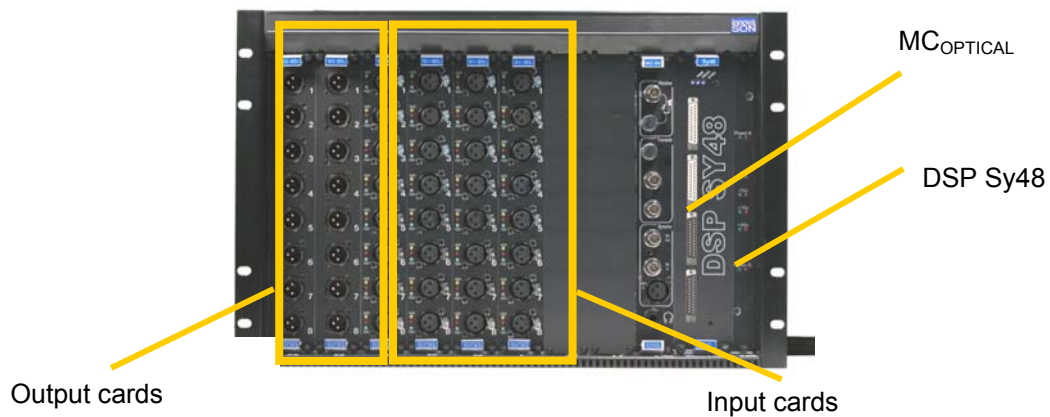

A standard SG3100 audio rack is equipped with two internal power supplies, with automatic switchover if a problem was to occur on one of them. For the automatic switchover to function properly, it is imperative that both power supplies of the rack be connected to the mains.

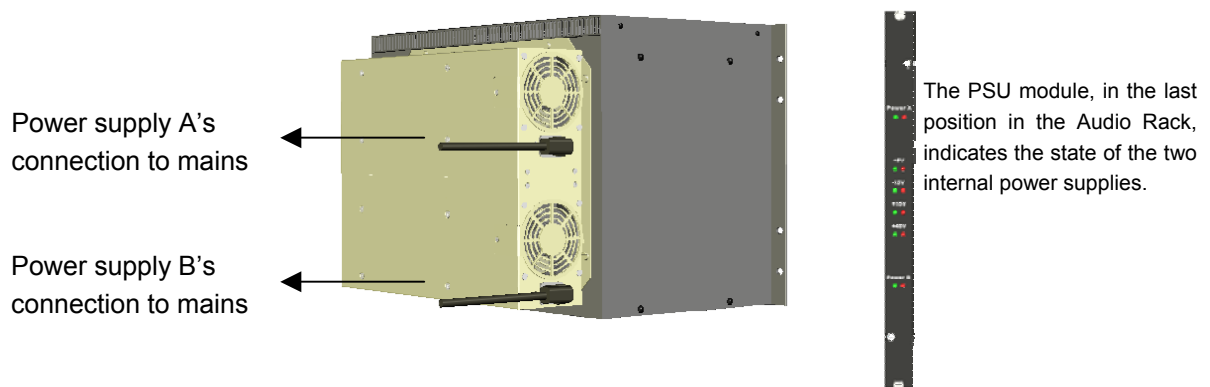

### Connection to the console

Blank face plates are used on the integrated audio rack on the back of the console. They are placed in the audio and MC cards position. One of these cards, the DSP Sy48, is replaced by the **SF2077** module, which is a Jeager adapter enabling the connection to the external Mix-Box.

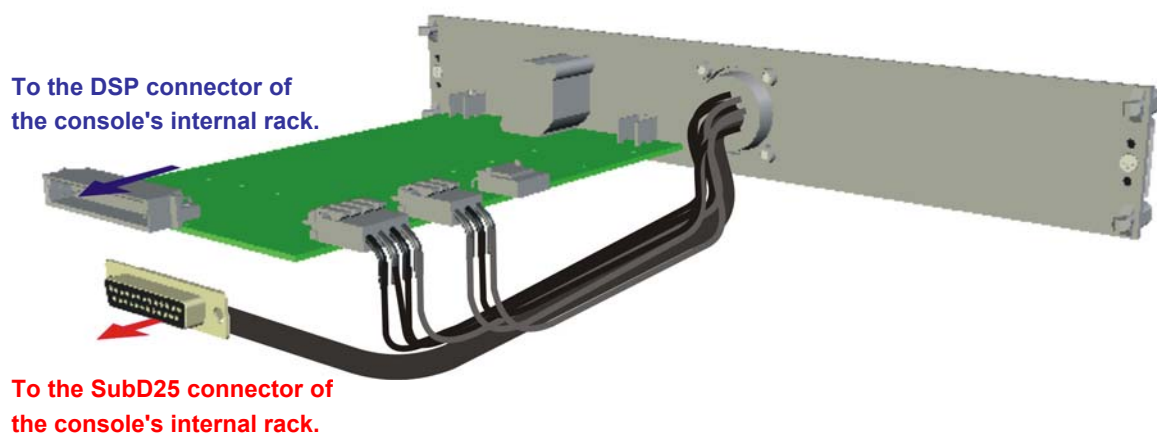



The SF2077 module is inserted in the DSP slot and a cable, linked to the module's Jaeger connector, must be plugged and secured with two screws on the SubD25 connector, at the base of the rack. Initially, this connector would receive the MC<sub>OPTICAL</sub>'s SubD25 connector.

**The SF2077 module (front view)...**

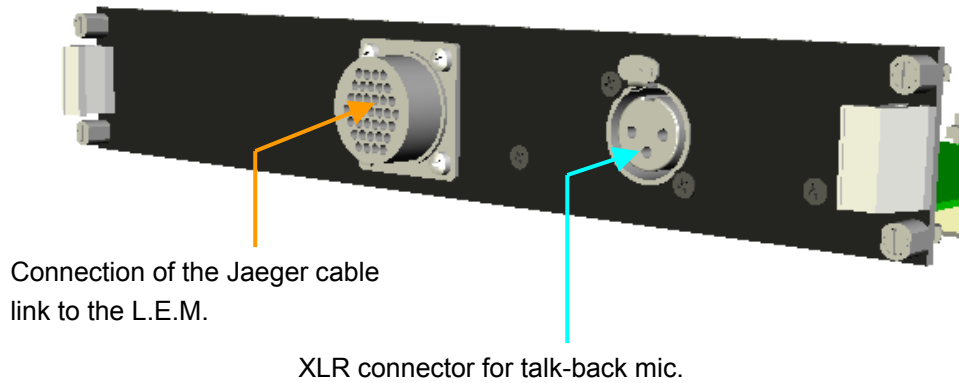

The L.E.M. is supplied with a 5 meter long Jaeger cable. Just connect the cable between the console and the audio rack before powering-up the system...



CONNECTION OF THE L.E.M. TO THE CONSOLE

## 2.C Description of the Sy48

### 2.C.1 Dimensions and general information

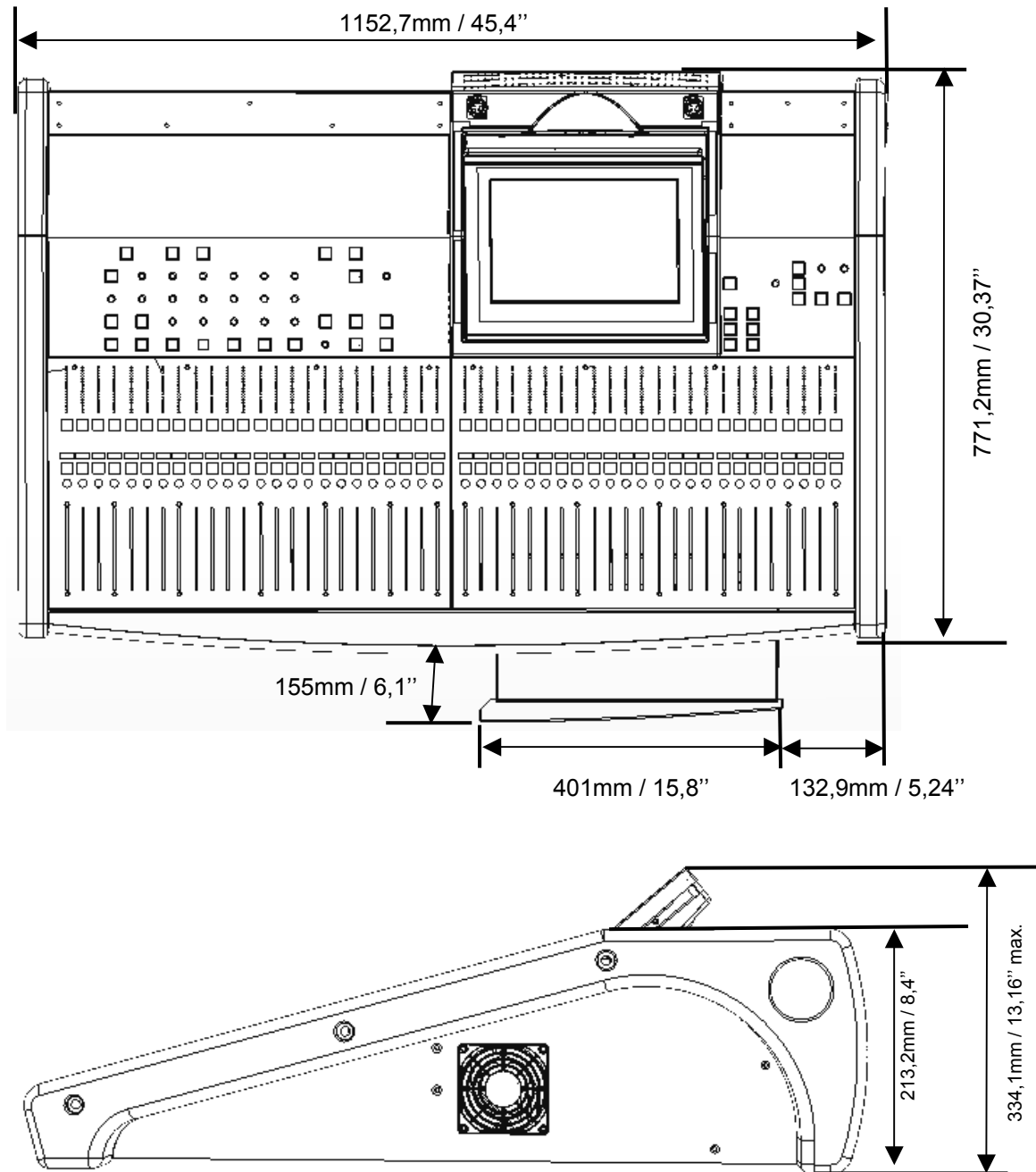

**Console :**

Length:	1152,7 mm / 45,4"
Width:	771,2 mm / 30,37"
Height:	213,2 mm (screen folded down), 334,1 mm maxi. / (8,4" / 13,16")
Weight:	40 kg by itself (88 Pounds)
Shipping crate:	1300 x 450 x 900 mm, 90 kg / 51,2" x 17,7" x 35,4", 198 Pounds.
Power supply:	90/253 Vac, 46 to 63 Hz
Power consumption:	300 VA max
Working temperature:	+10°C to +35°C (50 to 95 °F)
Faders:	48 motorized 100 mm ALPS faders
Labeling:	48 4 character LED Matrix
Control:	141 switches, Cue, Select and Mute per fader
Bar-graphs:	48 Vu-meters (16 LED)
Pots:	23 rotating encoders for audio parameters and console control
Switches:	34 switches for audio functions and global control
Internal computer:	PC Compatible, Pentium 1GHz, 128 Mb of RAM
Screen:	12" collapsible flat LCD screen
MIDI card:	InnovaSON
Keyboard:	CHERRY ML4100 QWERTY (keyboard + track ball)
Backup:	On any USB storage device (3 available ports) 3"1/2 USB)
Hard disk:	128/256 Mo Flash Memory

**Rack audio Stage-Box (optional) :**

Length:	482 mm (19")
Width :	325 mm (12,8")
Height:	312 mm (7U, 12,3")
Weight :	20 kg by itslef / 44 Pounds 75 kg with shipping crate / 165 Pounds
Basic modules:	1 SC <sub>OPTICAL</sub> controller module and 1 SI-8D3 module
Coaxial cable:	2x150m, 75 Ohms, 4 BNC, supplied on a drum
Shipping crate:	800 x 640 x 740 mm / 31,5" x 25,2" x 29"

**L.E.M. audio rack (optional) :**

Length :	482 mm (19")
Width :	325 mm (12,8")
Height:	312 mm (7U, 12,3")
Weight :	20 kg by itself / 44 Pounds 75 Kg with shipping crate / 165 Pounds
Basic modules:	1 MC <sub>OPTICAL</sub> controller module
Shipping crate:	800 x 640 x 740 mm / 31,5" x 25,2" x 29"

### 2.C.2 The Quadfad module

A Quadfad module features 4 motorized faders. Each fader has its own 4-character label. The 12 Quadfad modules of the console are identical. Sensoft lets you determine the purpose of each fader. Their presence is automatically detected by Sensoft.

The main characteristics of a Quadfad module are as follows :

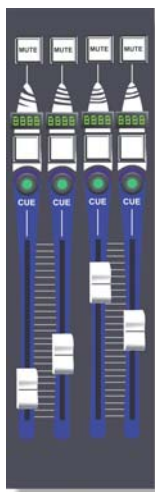

- ALPS 100 mm motorized fader
- 8 bit linear conversion for servo-control and fader positioning
- nominal positioning time: 100 ms
- Sensory memory of stored fader position
- Illuminated switch to indicate Channel selection
- Illuminated [CUE] switch (green) to indicate assignment to the Monitor bus
- Illuminated [MUTE] switch (red)
- 4-character Labeling display (adjustable highlighting / for when the channel is selected)

### 2.C.3 The CHANNEL CONTROL panel

Integrated within the console frame, and ideally positioned to be accessed rapidly, this panel centralizes all the channel's parameter controllers (gain, EQ, Dynamics section, etc...). Pan control, and amongst other things, access buttons to the various 'LIVE' functions such as **Copy**, **OverRam**, and the patch windows, are also found on that panel.



### 2.C.4 Screen and UTILITIES panel

Three sections complete the access to the console's functions with, from left to right, the page and show management panel, the central screen to visualize the current mix, and the patch grid, monitoring circuit management and talk-back mic panel.



On top of the screen, you will find three small holes that let you adjust brightness and other settings. A user manual for the screen is supplied with the console to guide you in the procedure. In any event, one of the configuration menus offers an automatic adjustment, which will optimize settings according to the video signal' characteristics.

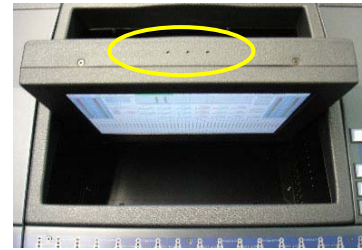

During the console's startup procedure, the image may be unstable. This is perfectly normal. As soon as Sensoft is launched, the image will be stable.

### 2.C.5 On the front of the console

Left of the keyboard drawer, you will find 3 connectors:

- A 1/4" headphone jack
- An XLR connector for a talk-back mic
- A USB connector for any storage device

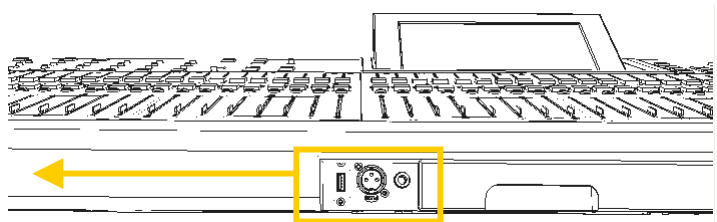

Volume of the headphone jack can be adjusted with the [Level] pot of the monitor section **when no other monitoring circuit is active.**

### 2.C.6 On the back of the console

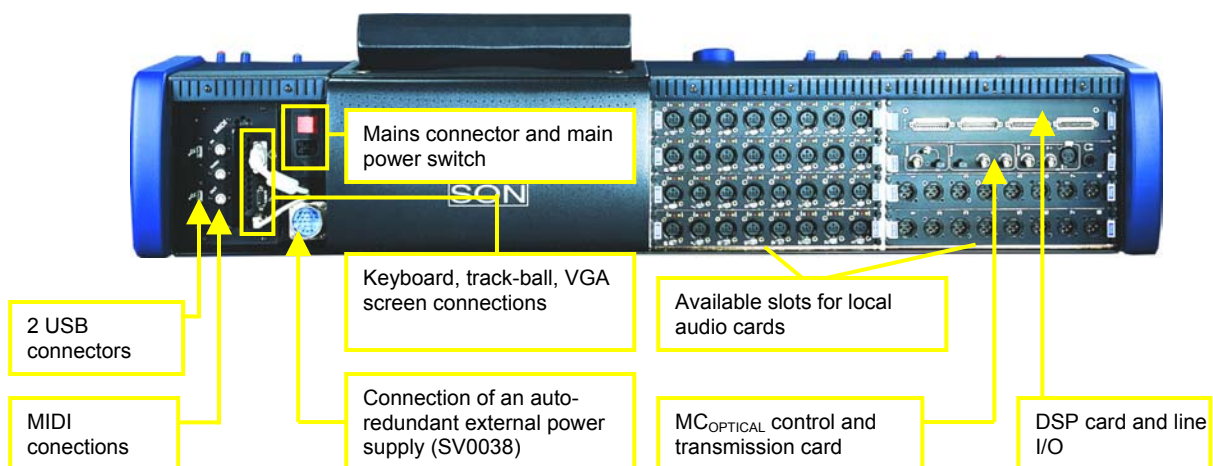

### 2.C.7 Control layout

Control surface layout

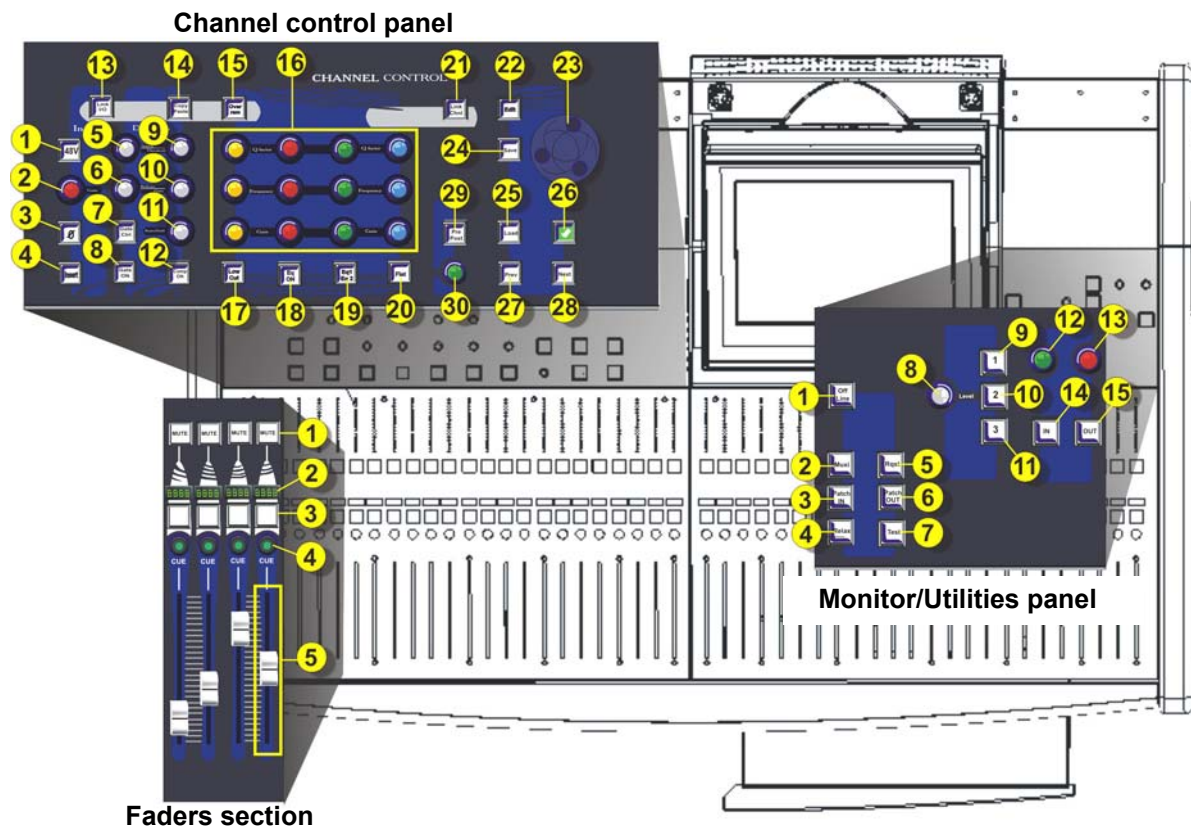

### The Channel Control panel

I N P U T	<ul style="list-style-type: none"> <li>1-Phantom power On/Off</li> <li>2-Mic pre-amp gain</li> <li>3-Phase inversion</li> <li>4-Insert return In/Out</li> </ul>
D Y N A M I C S	<ul style="list-style-type: none"> <li>5- Attack parameter control</li> <li>6- Release parameter control</li> <li>7- Gate / Compressor settings toggle</li> <li>8- Noise Gate On/Off</li> <li>9- Threshold parameter control</li> <li>10- Range parameter control</li> <li>11- Hold parameter control</li> <li>12- Compressor On/Off</li> </ul>
T O O L S	<ul style="list-style-type: none"> <li>13- I/O card parameter link</li> <li>14-Copies a channel's parameters</li> <li>15-Propagates the parameter values to the other pages in RAM</li> <li>20- Initialization of Eq, Dynamics, ...</li> <li>21-Mix parameter link</li> </ul>
E Q	<ul style="list-style-type: none"> <li>16- Digital EQ's parameter controls</li> <li>17-Low-cut filter On/Off</li> <li>18- EQ On/Off</li> <li>19-Toggles between the first 4 and last 4 EQ bands of the Hyperdrive cards (XO, ...)</li> </ul>
F I L E S / N A V I G	<ul style="list-style-type: none"> <li>22- File edit window</li> <li>23- Rotating encoders: lets you navigate through lists, grids, ...</li> <li>24- Saves the current page</li> <li>25- Loads a folder from the Hard disk to the RAM</li> <li>26- Confirmation: OK key</li> <li>27- Previous memory</li> <li>28- Next memory</li> </ul>
P A N	<ul style="list-style-type: none"> <li>29- Aux parameter window: Pre/Post, independent Pan, routing...</li> <li>30- Pan placement adjustment (Hyperdrive card output level in Muxi mode).</li> </ul>

### The Monitor/Utilities panel

U T I L I T I E S	<ul style="list-style-type: none"> <li>1- OffLine : Disconnects the console from the audio racks.</li> <li>2- Muxi : Visualization of the system's outputs.</li> <li>3- Input patch grid</li> <li>4- Switch to « manual » for selected parameters in selected channels</li> <li>5- Request : Visualization and rapid activation of Phantom power, LowCut, EQ, ...</li> <li>6- Output patch grid</li> <li>7- Test : settings and activation of the test oscillator.</li> </ul>
M O N I T O R I N G	<ul style="list-style-type: none"> <li>8- TB mic or active monitoring circuit level (depending on general pref.)</li> <li>9- TB 1 or Monitoring circuit 1 (depending on general pref.)</li> <li>10- TB 2 or Monitoring circuit 2 (depending on general pref.)</li> <li>11- TB 3 or Monitoring circuit 3 (depending on general pref.)</li> <li>12- Level control when monitoring inputs</li> <li>13- level control when monitoring mix busses</li> <li>14- IN : Toggles input monitoring between PFL and AFL</li> <li>15- OUT : Toggles mix bus monitoring between PFL, AFL and APL</li> </ul>

### The Faders section

C H A N N E L	<ul style="list-style-type: none"> <li>1- Channel mute</li> <li>2- Channel label</li> <li>3- Selects this channel's parameters</li> <li>4- CUE: sends the Channel to the monitoring bus.</li> <li>5- Channel fader</li> </ul>
---------------------------------	---

## 2.D Precautionary measures, safety and warnings

**Read this section carefully in order to use the control surface safely.**

**1.** Never connect a receiver (camera) that has its own phantom power activated: this would destroy the output to which it has been connected. Switch the phantom power off, or if this is not possible, go through an external device first (isolation transformer, intermediate pre-amp, etc...).

**2.** Only the swapping of presumably defective modules is advised, and made possible by the modular philosophy of the control surface.

ANY SWAPPING OF MODULES MUST BE DONE WITH THE CONSOLE SWITCHED OFF.

**3.** Do not store or use the console in extreme temperature conditions, or in an environment where it might be exposed to vibrations, dust or humidity.

**4.** Never use any liquid to clean the surface of the console (ideally, use a soft and dry cloth). Only use water or ethylic alcohol to clean the casing and silk-screen printed surfaces; other solvents could damage the paint or plastic parts.

**5.** Do not place the audio racks, local or remote, or the console itself, too close to strong electromagnetic radiation sources (video monitors, high-voltage cables, ...), as this might cause a degradation of audio quality via induced currents in the connections and frame.



## 2.E Manipulation and transport

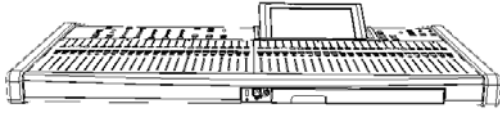

Before you move the console, make sure that everything is disconnected. Never put excessive pressure on the pots, switches and connectors.

The Sy48 console provides two grips under the plastic flanks on each side, for easy maneuvering.

## 2.F Power supplies and EC standards

The Sy48 console may be powered by any voltage ranging from 90 et 253 Volts AC / at 47-63 Hz.

The power supply *must* be earthed.

For optimal performance, it is essential that the earthing network be free of noise, since all signals are going to be referenced to it. A central point must therefore be determined as the main earthing connection, and all other earthing connections must originate from that point. It is recommended that you pull an extra earthing wire from each socket, wire that will be directly connected to the central earthing point: this is the best way to ground all the devices of your installation.

When the console is in use, do not block the cooling vents. Be especially careful of that if you are using the console while it remains in the lower half of its flight-case.

For electrical precautionary measures, please refer to chapter 10 - Appendices

## 2.G Connections

Connections to the control surface are reduced to a minimum for easy installation, and an increased reliability of the system. To use an external PC (desktop or laptop) you will need accessory SG9008, which will replace the internal PC, with connectors provided for hooking-up the external PC.

### 2.G.1 Audio connections

The Sy48's platform connections are all standard and were chosen to correspond with the most widespread in the professional live audio industry. No need to buy extra adapters or specific connectors when using the console in a normal environment. If, however, you have specific needs, feel free to contact InnovaSON's technical service. The contact information can be found on our web site and at the end of this manual.

Do not connect other audio devices which are switched on, before you power up the console. The Sy48 is a computerized platform which starts up in the last saved statuses, that you do not necessarily know. Unknown parameters relative to gain settings, or output levels, could damage various audio equipment (power amps, speakers,...), or even cause hearing damage to people too close to the speakers. Good practice would be to always shut down the console on a blank page, in which all the settings would be zeroed.

### 2.G.2 Internal screen, external screen

The standard screen housed in the console is a collapsible color LCD flat screen. The collapsed position is used during transportation. The screen can be tilted to suit your viewing position. A user manual for the screen is supplied with the console.

With a stylus, the holes on top of the screen's plastic casing give you access to the brightness, color and contrast settings.

Instead of the integrated screen, you can use any other standard SVGA monitor. Pay particular attention to the electromagnetic radiations that could appear when using a CRT (Cathode Ray tube) monitor.

The screen's connector is linked to the internal computer, on the rear of the console. If you are using an external computer, the screen (built-in LCD or other) can be quickly connected to the current working computer.



### 2.G.3 Connecting MIDI equipment

The Sy48's MIDI connectors are located on the internal PC, at the rear of the console: they will accept any MIDI compatible device. To make sure your connection will work, always use a cable that complies with MIDI specifications. Sensoft provides a utility tool for testing MIDI cables: refer to section 8.

### 2.G.4 Connection of an external power supply

An external power supply unit [SV0038](#) can be connected to the console to provide backup to the internal power supply in case it fails. It is even possible to connect two external power supplies, and control the power-up of the console remotely from them.

Contact our technical services for further information on that matter. The Jaeger connector dedicated to connecting an external power supply is equipped with a protection cap that MUST be in position when this function is not used. The cap keeps any short circuits from occurring between the Jaeger connector's pins.

### 2.G.5 Connecting an external PC

Any IBM-PC compatible computer, hosting a processor of at least 800MHz with 64Mb of RAM can be used to supervise the operation of the console instead of the internal unit. The SG9008 accessory is necessary for this type of operation. While on tour, we more than recommend that you purchase this accessory and keep a laptop PC ready, to "save the day".

The Windows **XP<sub>E</sub>** operating system installed in the console's internal PC is an XP core assembled by InnovaSON developers, in order to contain only the required elements necessary for managing the Sy48 platform. This is a mandatory condition to guarantee a stable, crash free, system. InnovaSON can not be liable for the instability of the operating system installed on your personal computer, connected to the platform. Our technical support is always ready to help you configure your computer for such a use.

### 2.G.6 Connecting an optional Stage-Box

The MC<sub>OPTICAL</sub> and SC<sub>OPTICAL</sub> cards, supplied as standard with the Mix-Box and Stage-Box, have their own coaxial and optical transmission system. It is very easy to initiate this transmission, as shown in the diagram below. The link may be uni or bi-directional. If it is uni-directional, only one TX of the Stage-Box will be linked to the RX of the MC. In this case, the console is in « Slave » status and cannot control the gain and PH48V of remote microphone input cards. We must insist on the need to use good quality cables or fibers and to take particularly good care of the connections used for this link.

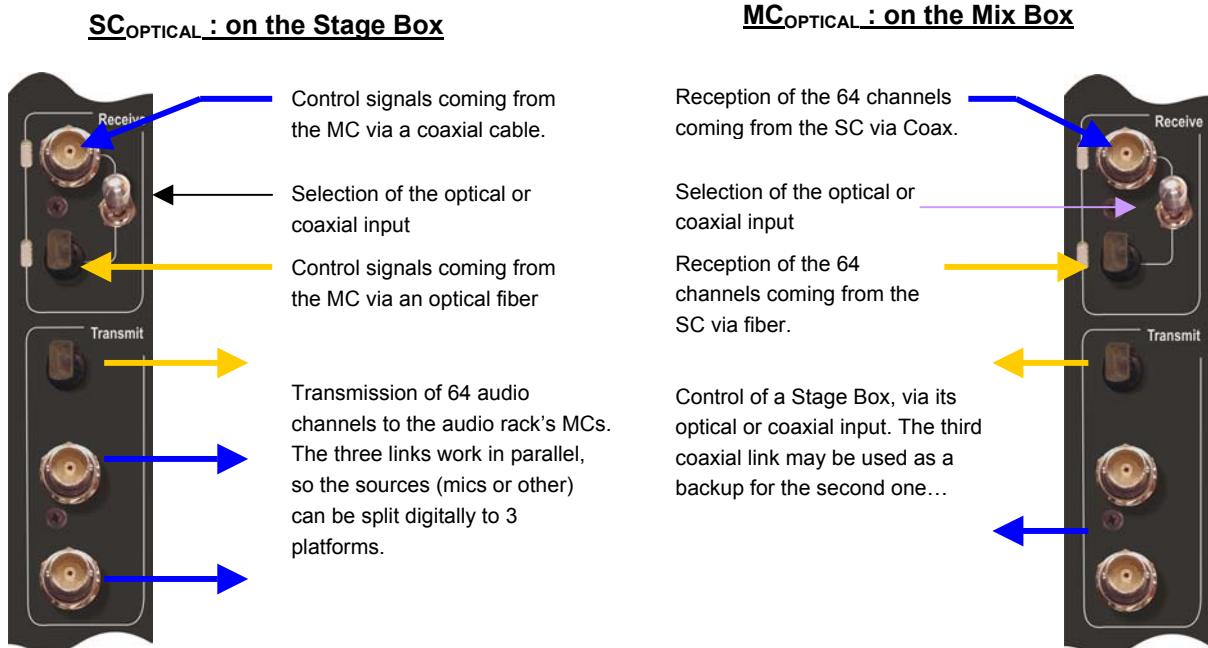

Several configurations are possible:





Nothing is easier than adapting the console to your needs, whether you are using it for monitoring, Front of House, theatre, opera, broadcast...

The only limitations are:

- No similar type cards (input/output) on the same remote and local slots (A, B, C,...).
  - Maximum simultaneous mixing of 48 Muxi inputs (inputs coming from SI and DI cards) plus the 16 line inputs of the DSP card (Sub-D). These 48 Muxi inputs can be selected, for each page of the show, amongst the 64 possible inputs.
  - Maximum transmission of 32 busses to the Stage-Box, patchable on 4 MO-8D3 or DO-8A cards. These cards must imperatively be installed in slots E, F, G or H of the Stage-Box.
  - Using remote output cards condemns the use of input cards installed on the same local slots.
- Please refer to the Sensoft 9.1 Addendum for further detail.

Example of a Stage Box and its optical fiber



Also refer to section 9 for the rules concerning the use of the Stage-Box.

### 2.G.7 Digital audio clock sync with external devices

There are several ways to sync the digital audio clocks of external devices with InnovaSON's platform clock. This can be done through SRC (Sample Rate Converter), on one or several digital audio inputs or via a Word-Clock or AES link, to synchronize the entire system to the same clock source.

#### Principle of the SRC (real-time sample rate conversion) :

This allows each equipment to keep its internal digital audio clock source. The digital inputs (AES or other) is immediately followed by a SRC algorithm allowing the synchronization of the incoming sample rate to the one used by the receiving system. The conversion has a range of about 10% around the sample rate of the receiving system. The **DI-8SRC** InnovaSON card is equipped with such an algorithm. Each one of the card's 4 AES inputs can receive an external digital audio signal with a sampling frequency between 32 and 50 KHz. The card output is itself synchronized to the global clock rate defined in the InnovaSON platform.

This feature has the advantage of letting you connect several digital audio sources to the console without having to worry about syncing the sources to one another. Be careful: the SRC creates an additional calculation latency, which leads to a non-negligible delay of up to 1.5ms in the « worst case » conversion... Moreover, again for calculation reasons, the original 24 bit resolution at the SRC's input will be « reduced » to 20 bits after conversion... Rest assured: the audio quality is still very good.

#### Using Word-Clock input and output :

When the console is meant to exchange a great number of digital input/outputs or is integrated in a digital audio environment where all the machines are synced to one another, it might be more useful to use the Word-Clock I/O of the platform. The console can be used as the « master clock source » or be synchronized to a reference clock. In the first case, just take the WC output of the MC and/or SC (if there's a Stage-Box) and distribute that signal to the WC inputs of the other devices. Note that the WC signal is available both on the local audio rack and on the optional Stage-Box. If, on the other hand, you wish to sync the console to a reference clock (48KHz), connect that clock signal to the MC's WC input. If you are also using a Stage-Box, then you **MUST** use the WC input of that Stage-Box's SC instead. The Stage-Box being the clock master for the platform, it must be the one receiving the external clock signal. If you are using a Stage-Box, the MC's WC input is ignored (the L.E.D normally showing synchronization stays off).



#### Using the AES input:

The MC and SC cards also feature an AES input. When a digital audio signal is connected to this input, the platform can extract the clocking information from the signal and sync to it. The same rule concerning the Stage-Box applies here : always sync the Stage-Box if you are using one, not the Mix-Box.

### **A few cases where no external synchronization is necessary :**

There are a few cases where it is not necessary to use any sync signal between the console and digital audio devices. Indeed, when the console feeds a digital audio signal to a device for processing purposes (effect, dynamic processor, digital recorder, ...) which is then returned to the console after processing, no need to use an SRC or a WC. Just configure the external device so it syncs on the incoming AES signal (fed by the console). The signal supplied by the device's output will also be synced by the incoming signal, and therefore, to the console's digital audio clock.

For signal exchange with digital outboard, it is therefore possible and even simpler to use DO-8 and DI-8A cards without worrying about syncing devices with one another. This will be done by configuring each outboard's digital clock source.

### **2.G.8 Connecting headphones**

There are no restrictions to the use of headphones on the console's headphone connector (refer to [section 2.C.5](#)). However, it is strongly advised not to use the MC card's headphone jack, which goes way back in InnovaSON's history of developments! This output was originally designed for monitoring functions of the Muxipaire, when no console was used. This output does not feature a volume control.



---

**CAUTION:** Do NOT connect headphones to the SC<sub>OPTICAL</sub>'s headphone jack. This jack is operational only when using a Muxipair and when the card is configured as an MC and not as an SC.

---

## 2.H Powering up



The Sy48's elements must be powered up following these specific instructions. Failure to do so might damage the equipment; some elements might end up being unusable.

### 2.H.1 Power up sequence

#### Mains connections

Connect the console's mains power cord, located on the back. The audio racks (L.E.M. and Stage-Box) require two power cords that must imperatively be connected to the mains for the power supply redundancy system to function properly.

Before powering-up them up, make sure that the audio inputs and outputs are not connected to any elements that might be easily damaged (amplifiers, headphones, ears, etc...).

If you are using a Stage-Box, you should switch it on first, *sera mis sous tension en premier*, for its configuration to be automatically recognized by the console. Bad recognition will not give you access to all the parameters, and will not allow active monitoring of the various working states of the system's elements.

There is no power switch on the audio racks: you simply plug the two mains cords of its power supplies to switch the rack on. No need to worry about any accidental shutdown.



**Caution: respect as much as possible the power-up sequence below:**

1. **Power-up the Stage-Box (if you are using one)**
2. **Power-up the L.E.M. (if you are using one)**
3. **Power-up the console**

When using a Stage-Box, you **MUST** connect the transmission cards with the provided coaxial or optical cable (see paragraph **2.G.6**).

The console, when used by itself, uses its internal clock source, and is « clock master ». With a Stage-Box, the system's clock is provided and distributed by that audio rack. This is why, when using a Stage-Box, only the WC and AES inputs of the SC<sub>OPTICAL</sub> are operational. The MC's and SC's WC output both generate the same clock rate than the one provided by the Stage-Box.

The power-up sequence is important because it lets the Stage Box send the clocking signal on the optical or coaxial cable first, so the connected MCs may sync to it as soon as they are switched on.

As soon as the rack is switched on, it is important to check that it is functioning properly.

The power supply card has 4 LEDs indicating the presence and conformity of the 4 secondary voltages.

The **MC<sub>OPTICAL</sub>** and **SC<sub>OPTICAL</sub>** modules feature, next to the RX connectors, a few LEDs. The input which has been selected with the switch should illuminate the corresponding LED in red, thus indicating that the rack and its transmission card are both functioning correctly. It will turn green as soon as the MC/SC communication is established. This should happen just a few seconds after Sensoft has been launched. If the MC is not connected to a Stage-Box, the RX LED will, of course, stay red.

In the console, two little cards indicate the state of the internal power supplies, LEDs slightly sticking out of the plastic covers will provide readings of these states :



On the left, the LEDs regarding the audio section  
red (+5V), green (+/-15V), yellow (+48V)

On the right, the PC and the control surface  
2 red (+5V) and 2 green (+/-12V)

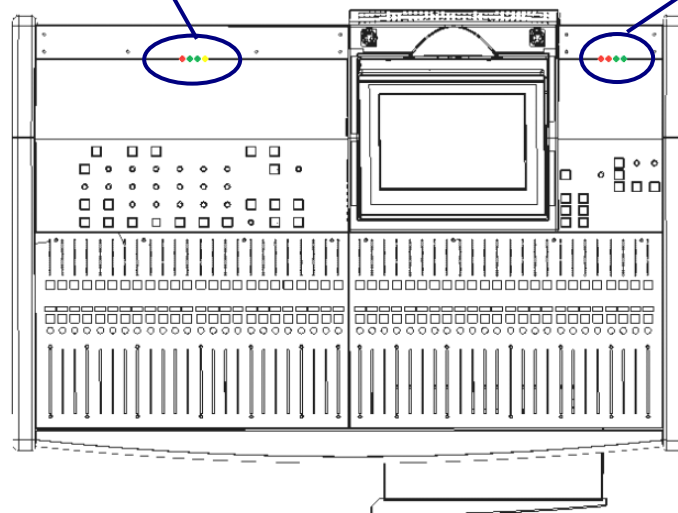

- The start-up procedure should last about 30 seconds, during which a few messages and images are displayed before Sensoft is finally loaded. If the startup fails, shut the power down, wait 20 to 30 seconds before switching the power back on. Even though the internal computer is very robust, a power shortage during a backup can make an important file unreadable, therefore disrupting the startup procedure. If this were to happen too often, back-up all your files and reinstall the System and Sensoft (see section 8). If, in spite of this, the startup still causes trouble, contact InnovaSON's technical service.

- The parameters that were last saved might be different from those necessary our required. Make sure that step after step, all the parameters comply to your needs and to the rest of the audio installation.

- The elements of the sound reinforcement system may now be connected and switched on.



**The console is now ready**

It will be in the mix mode that was last used before it was shut down (last recalled page). If you took care of shutting down the console on a blank, inert, page, the console will boot in this state. It is therefore recommended that your show contain an inert end page (or start page), recalled and saved prior to shutting down, which then means that powering up can be done safely.



When using the console for the first time, the default elements are the INNOVA folder containing the blank INNOVA page. A disk is provided with templates that you can import.

**2.H.2 First checks**

Before going further, it is important that you check some information with the screen :

**LOCAL**

The console is autonomous. No data is received from a Stage-Box. Communication with the local audio rack (or L.E.M.) is OK.

**SLAVE**

The console is receiving data from a Stage-Box, but the TX link has not been detected. Therefore, the console cannot control remote mic preamps

**MASTER**

Indicates that both links have been detected. The console is 'Master' of the system, and therefore controls remote mic preamps (gain and 48V) and the potential channels returning to the Stage-Box.

**NO SYSTEM**

Abnormal situation on a Sy48. The internal audio rack (or the L.E.M.) has not been detected by the console.



The screen displays the faders in their exact position, their colors reflecting their associated functions.

The screen displays the various fader positions as well as the state of the mix parameters, such as the [MUTE] and [CUE] switches activated on the console, which appear respectively in red and green above each fader. When a [SELECT] switch is pressed, this activates the corresponding channel, and lights the «Select» indicator, illuminating and making the text in the associated display (label) flash.



### 3 SENSOFT 8.1

#### 3.A Your First Mix: a simple step-by-step example

It is obvious that every engineer confronted for the first time with a new console has a single goal: “to mix”! This is only to be expected so, by means of a very simple example, we are going to guide your first steps through the exciting world of InnovaSON. Note: it was made clear at the beginning of this user manual that you should read its complete contents before you start to use the console.

The following paragraphs are not intended to be an exception to this rule – their purpose is to show how user-friendly your first contact will be, even if it turns out to be simple.

In spite of today’s Sensoft 8 offering a very important rang of new tools, the design philosophy used by InnovaSON has not changed for a long time.

It is based on 5 fundamental actions, as illustrated by the figure below :

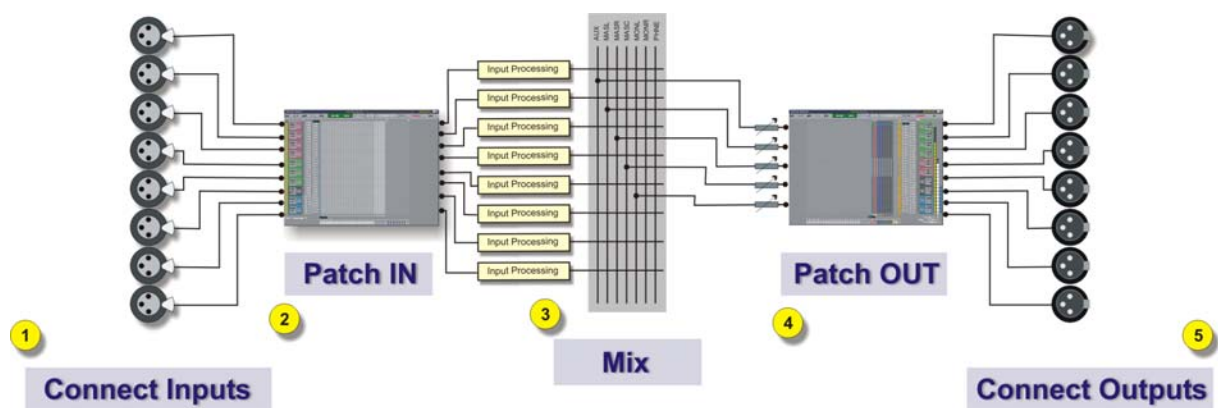

These 5 actions characterize what Sensoft has always provided for the user: simplicity, speed, and ease of access.

**Connect** a source to an input, **Patch** this input to a fader, **Route** the fader to a mix bus, **Patch** this bus to a physical output, and finally **Connect** this physical output to a PA system or external device – the chain is complete! Everything that Sensoft offers has a degree of sophistication stemming from the feedback of users who, since the beginning, understood the possibilities offered by InnovaSON platforms. Thanks to their insight and understanding, Sensoft 8 was born – a skillful combination of user-feedback and the magic touch of the InnovaSON designers. The result offers each user the possibility of DRAWING their own console, according to their needs at that time.

You only need to understand how the **Patch** and **Routing grids** function, in order to feel at ease with all the functions of Sensoft, as most of the **Grids** and **Signal allocations** use the same philosophy.

### 3.A.1 Console Configuration

Our example is very simple and consists of assigning an input, to which is connected an audio source, to a channel, and then to mix this input to various busses by having a go with, one step at a time, the Subgroups, VCAs, channel spreads, etc.

First of all, we will assign the faders of the console to the functions that we are going to use throughout this example.

The illustration below shows how to access the hardware configuration window. This window is used to provide every fader with an appropriate function, and also to check the configuration of the audio racks and the state of data transmission between the racks.

The Hardware Configuration window

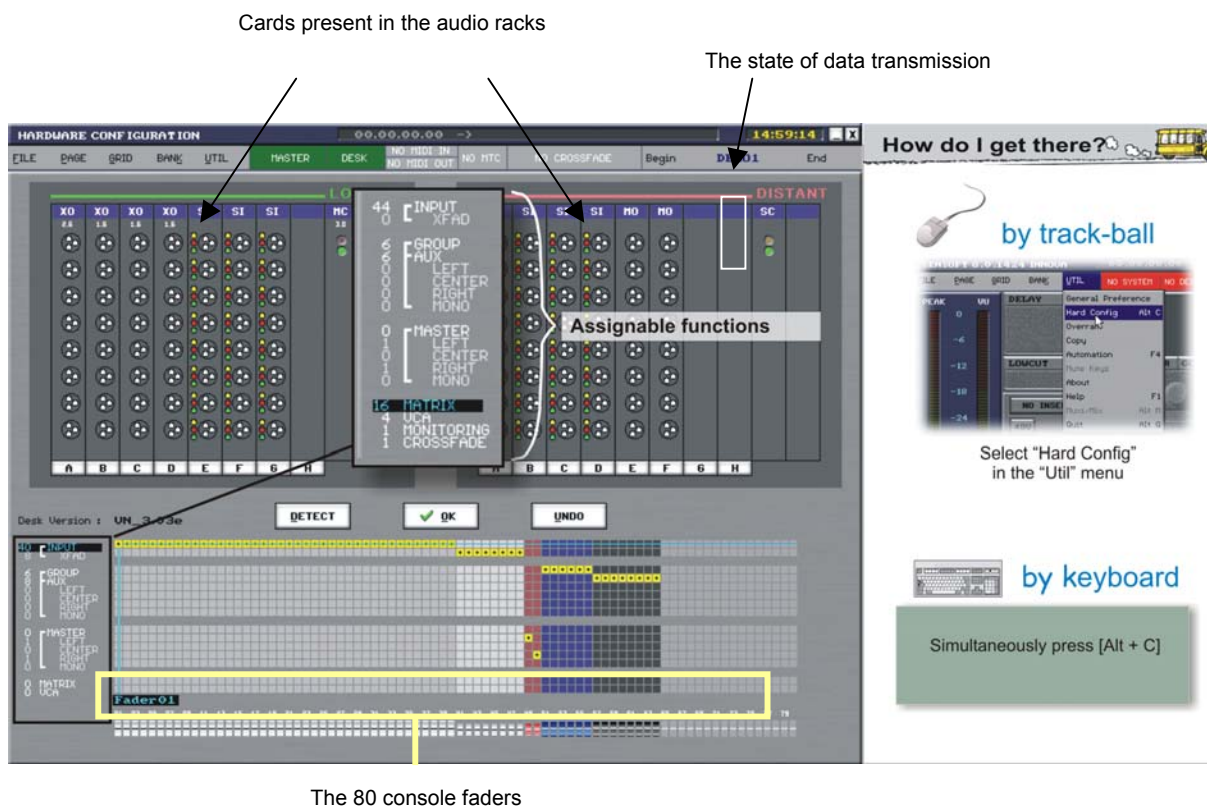

The cursor keys on the keyboard, or the track-ball on the console control surface, are used to move around the function **Assignment grid**. Functions are assigned to selected faders by pressing the [SPACE BAR] on the keyboard, or by means of buttons of the track-ball, the functions of which are explained below.

Using the track-ball in Sensoft grids – keyboard and mouse equivalents

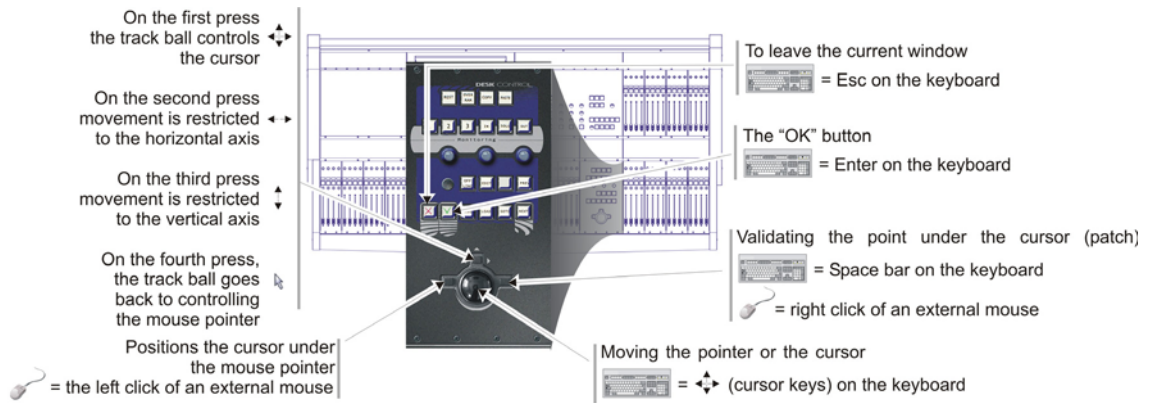

For our example, the console will be configured as follows:

- The first 40 faders will be inputs, so the **Input** function will be assigned to them.
- The next 8 faders will be "spread" inputs which we'll use towards the end of the example; the function **XFAD** will therefore be assigned to them.
- Two Master faders will be set up, assigned with the functions **Master "LEFT"** and **Master "RIGHT"**.
- There will be 6 mono Groups.
- Finally we'll configure 8 auxiliary sends; the remaining 16 faders will not be used at the moment.

Our starting configuration ...

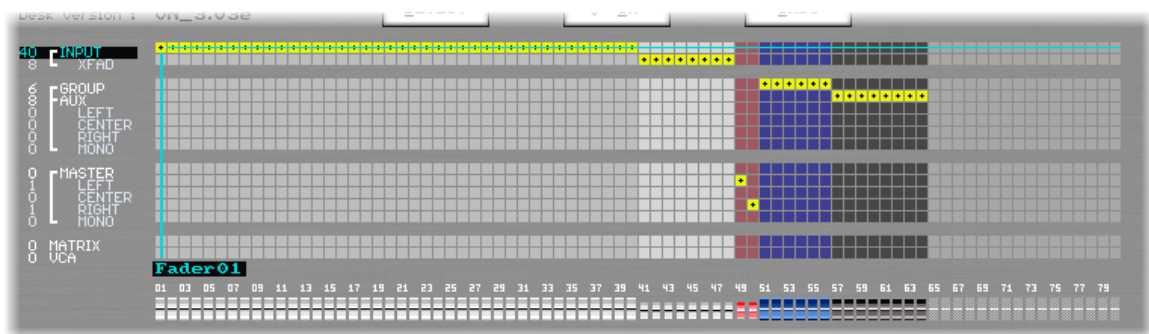

Press the [ESC] key to validate the new configuration. It will appear in the main mix window and you will be able to see the console just as you have "drawn" it.

... the resultant mix window



### 3.A.2 Patching...

We're now going to assign a physical input to one of the console's input faders, and two physical outputs to the Master faders.

First you must call up the PATCH IN window by pressing the button on the console with the same name. This window shows a grid on which the columns represent faders, and the lines represent all the available physical inputs. In a column on the left of the window, the cards currently available in the system carry a label, with different colors to show whether they are distant, local or line level cards.

The Patch IN window

This system comprises 4 Distant SI-8D cards (slots A to D of a Stage Box)

3 Local SI-8D cards in slots E, F and G of the Mix Box

And 16 line-level inputs accessible on the DSP card in the Mix Box. These inputs have their level meter only on the console, not on screen.

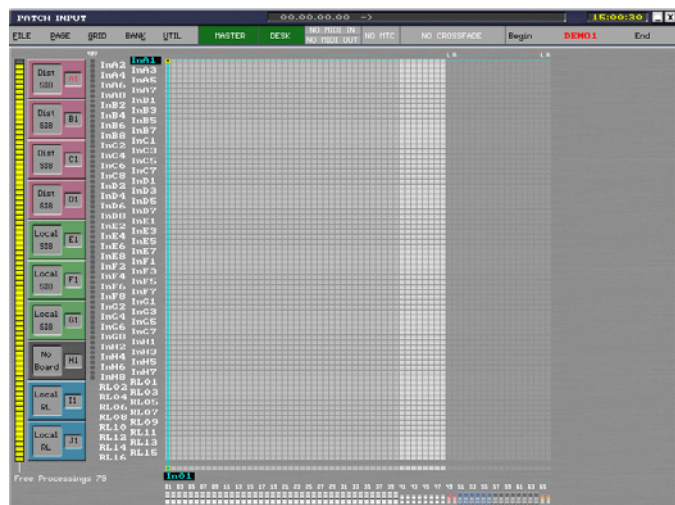

Having positioned the grid cursor in the column for Fader 1 (press the [SELECT] button on the fader to get there quicker) and on the line for input InA1 (input 1 of slot A), press the [SPACE BAR] on the keyboard, or the button on the right of the track-ball, to create the corresponding patch point. The label above the fader now shows the name of the patched input, ie. InA1. To give another name to this input, simply press [F3] while the cursor is positioned on the line concerned (InA1) and the following window will appear:

**Naming an input**

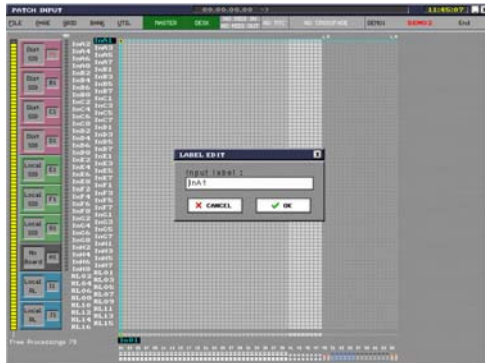

Just enter the name of the input with the keyboard

In the example, the input is called MIC1

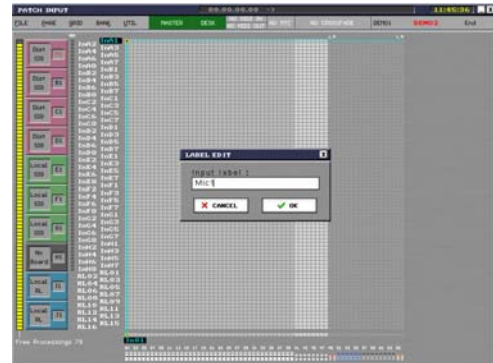

Naming the input MIC1 automatically places the name MIC1 in the fader label. This indicates that the name belongs to the physical input, and not to the fader. If you mult the input across several faders, these will also take the name MIC1 as and when you patch them to this input. From the mix window it is possible to rename an input by selecting the fader to which that input is patched, and by pressing the [F3] key to rename only this input, or by pressing [ALT] + [F3] to rename this input and the following ones. Now that input A1 is assigned to fader 1 we will, via the PATCH OUT window, assign two physical outputs to the Left and Right Master faders.



**The PATCH OUT window**

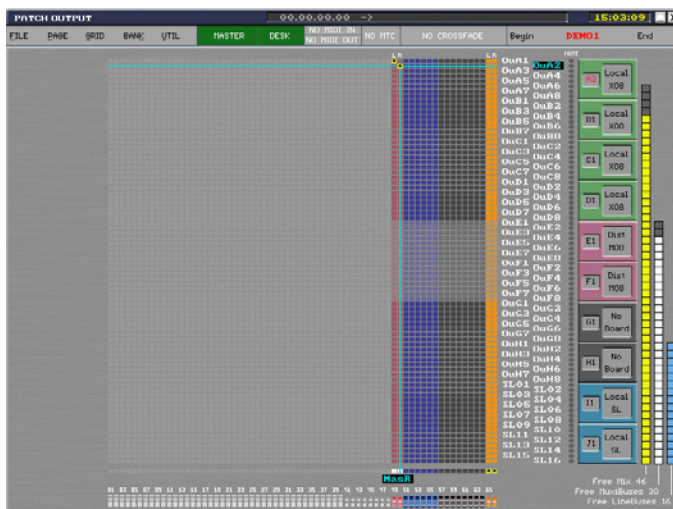

This system comprises 4 Local processed output cards

2 Distant MO-8D cards allowing non-processed outputs to the stage (cf 9.C.3)

and 16 line-level outputs accessible on the Mix Box DSP card. These outputs have their level meter only on the console, not on screen.

By the same method as used on the Patch In window, make faders 49 and 50, named MasL and MasR, correspond with outputs OuA1 and OuA2. For every patch point, the space bar, or the right button of the track-ball, allows a patch to be created or cancelled. As soon as the patch point is created, the fader labels which previously carried the names MasL and MasR will now show the names of the outputs they control, ie. OuA1 and OuA2. With the grid cursor on output OuA1, press [ALT] + [F3] and name the output "LEFT". Validate this by pressing [ENTER]; this has the effect of moving automatically to name the following output, OuA2. Name this output "RIGH" and validate it by pressing [ENTER]. As output OuA3 is not used, press [ESC] to quit the output naming mode. Press [ESC] a second time to leave the PATCH OUT window.

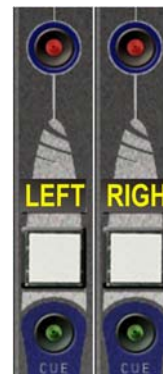

### 3.A.3 Some routing



Gain adjustment

Before routing input MIC1 to the Master busses, connect an audio source to distant input A1. This source must be sufficient to activate the console meter corresponding to channel 1, as well as the level meter in the Sensoft window. If this is not the case, select MIC1 (press the [SELECT] button on channel 1) and adjust the gain to provide a modulation level high enough to drive the meters.



The Sensoft level meters

This section shows the level of the selected input or bus, in this case the MIC1 input

This section always shows the level of the Master busses



Each channel has its own VU meter, for a general view



Sensoft always shows pre-processing levels, as they represents the preamps output level (for the inputs).



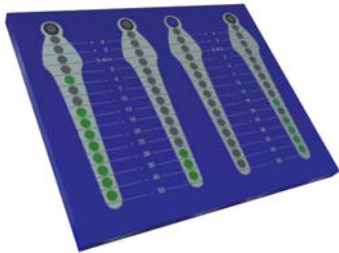

The control surface level meters can be configured to display pre or post-processing signals in the General Preferences window; by default they are post-processing.

Carry out the following procedure to route the input signal to Master busses



1- Hold down the **[SELECT]** button on the MIC1 channel

2- Press the **[SELECT]** button on one of the two channels designated as a Master; both will light up

3- Un-mute the input and the Master channels. Raise the faders to send the input signal to the Masters

If a PA system is connected to local outputs **A1 and A2**, the input signal will be distributed to this system. Select input MIC1 to try out some processing. For this exercise, activate the required processing section and adjust the controls to assess the efficiency of the algorithms programmed in the DSP Sy80 (or Sy40-8) card. Select one of the Master busses to try the output processing on the XO-8D cards.

The delay available on inputs (DSP Sy80 only) and outputs

The high-pass filter available on inputs

Comprehensive no-compromise dynamics section. Compressor, gate, expander and limiter are available for inputs and outputs

4-band parametric equaliser for inputs, and an 8-band parametric equaliser for outputs (EQ1/EQ2)

Read paragraph 2.A.7 of this manual if you need help in achieving the required settings.



Output processing is only available on cards equipped with DSP, such as the XO-8D and DO-8X. MO-8D and DO-8A cards, just as line-level outputs, have no access to these functions. Currently, internal busses such as Subgroups do not carry processing; they will in a future version of Sensoft.

---

### 3.A.4 Creating and using a Subgroup

Remove the MIC1 input from the Master busses by holding down its **[SELECT]** button and pressing the **[SELECT]** button of one of the Master busses (the LEFT and RIGHT **[SELECT]** button illumination will turn off to indicate that the routing has been removed).

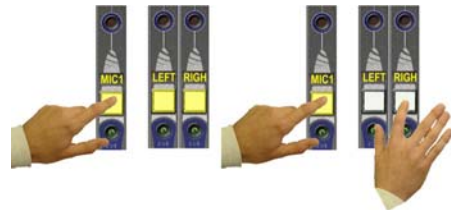

From now on, the signal present on input MIC1 of the console will no longer be distributed by the PA system. We are going to route this signal to a Subgroup which, in turn, will be injected onto the Master busses.

During the console configuration, faders **51 - 56** were set up as Groups, and their labels were automatically named **Gr51** to **Gr56**. Now we must assign to them, not a physical output, given that we will use them as Subgroups, but a processing resource so that the DSP creates the bus necessary for the functioning of a Subgroup. In the PATCH OUT window, the line at the bottom of the grid allows DSP resources to be patched to internal busses, thus not requiring processing to be directly patched on physical outputs. As shown in the following illustration, it is enough to “patch” DSP resources to the Groups to make them Subgroups.

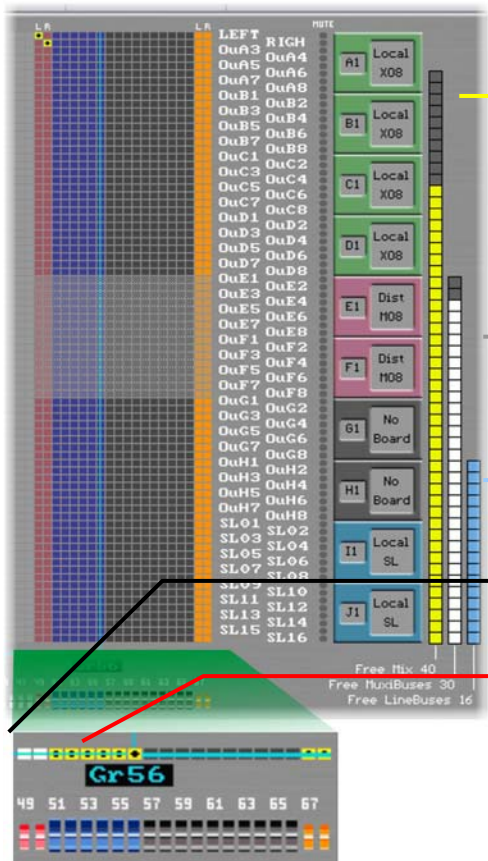

**Available DSP resource indicator**

In this example, 8 out of 48 resources are used:

- 2 for the stereo Master
- 6 for the Subgroups that we're going to create

**MUXIPAIRE bus indicator (audio rack output cards)**

In this example, 2 out of 32 Muxipaire resources are used:

- 2 for the stereo Master

**Bus Line indicator (Line Outputs)**

In this example, none of the 16 Line Output resources are used

A white point indicates that a DSP resource patched to Muxipaire resource is in use

A yellow and black point indicates that a DSP resource is in use. This resource allows internal busses, such as Subgroups, to be created

By the same principal, a blue point indicates that a DSP resource patched to a Line Output resource will be used

On this line, you will see yellow / black, white, blue or grey points:

- When no DSP resource is used on a fader, ie. the function of the fader has been created in the HARDWARE CONFIGURATION window but no bus has been assigned to this fader, the point remains grey.
- If the fader is patched to a Muxipaire output (card XO, MO or DO), the point is automatically shown in white.
- If the fader is patched to a line level output, the point is automatically shown in blue.
- Creating a patch point on this line for an internal bus makes a yellow / black point.

Having created 6 Subgroups, it only remains to route the MIC1 input to one of them, and to route the same Subgroup to the Master busses.

Route the MIC1 input to Subgroup 51



The yellow point indicates that the selected input is routed to this bus



Route Subgroup 51 to one of the Masters



Confirmation that the selected bus is routed to the Masters



If there is now an audio signal present on the MIC1 input, and if a PA system is connected to the “LEFT” and “RIGHT” outputs, opening the input fader while the Subgroup and Master faders are at 0dB, will feed that input signal to the PA system. Verify that the Subgroup fader really does control the MIC1 input.



Before going any further, repeat the steps you have just seen in this example by using line inputs and outputs (with the Sub-D/XLR cables supplied with the console). Try sending several audio sources to a Subgroup, while keeping an eye on the PATCH window, especially the resource indicators.

### 3.A.5 Spreading inputs

The ability to “spread” inputs will only be of interest when you are mixing several “families” of different audio sources; this function can be likened to the creation of fader “banks”. For our example, the stereo output of a CD player will be sufficient to test your interest in “spreads”.

First of all, on the main Mix window, in the console area, select fader 2. Press the [F3] key on the keyboard and name this bank “CD”.

Then, in the PATCH IN window, name **inputs A2** and **A3** respectively “CD L” and “CD R”; naming inputs first enables suitable labels to be created automatically on the faders at the time of the patch.

Without leaving the PATCH IN window, select the “CD” channel again (fader 2) and then select the first fader for the spread zone, fader 41. Patch the “CD L” input to this fader. Now select the second fader for the spread zone, fader 42, and patch the “CD R” input to it. The result should be identical to the screen shot below.

The two crosses indicate that the “CD” channel controls two physical inputs. These inputs are “CD L” and “CD R”.

The light area represents the XFAD, where the inputs are spread. For the “CD” channel you can see that faders 41 and 42 control the “CD L” and “CD R” inputs

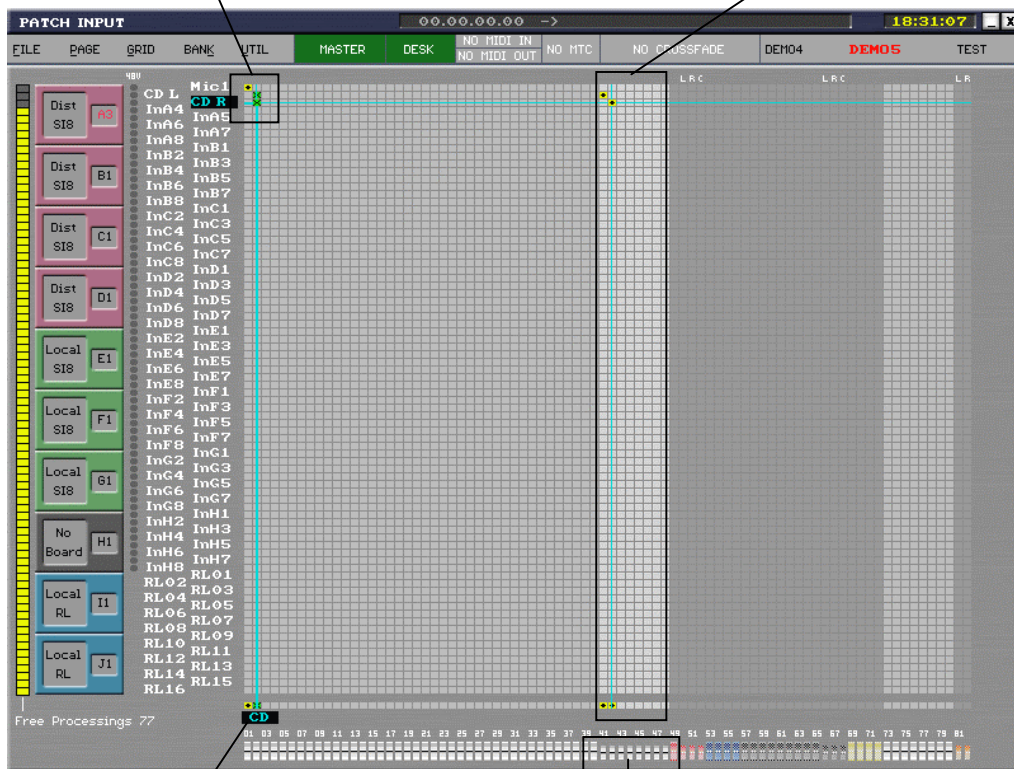

The name of the “bank” in production

The small XFAD faders

Return to the main Mix window (by pressing the [ESC] key on the keyboard, or by pressing the [PATCH IN] button on the console again) to route the “CD” channel to the Master busses.



Routing the “CD” channel to the Master bus automatically routes the (XFAD) channels “CD L” and “CD R” managed by this channel

As long as the CD player is outputting music, you will find that the “CD” channel (fader 2) acts as a VCA for both inputs “CD L” and “CD R”. In fact, looking beyond this channel, you can assimilate a bank of inputs, providing much more than simple VCA control. Note that it is always possible to adjust the balance of both “CD L” and “CD R” inputs by acting directly on their XFAD when the “CD” channel is spread.



Now let’s assign the “CD L” and “CD R” inputs to the left and right Master busses respectively, using the pan settings. Select XFAD “CD L” (if necessary, “spread” this by first selecting the “CD” channel) and, by means of the console’s rotary [PAN] control, pan the signal totally to the left. Repeat the operation for XFAD “CD R”, to pan it to the right.





Note that, when you operate the “CD” channel Pan, you are dealing with a non-destructive “composite” Pan, from which the initial balance of each of the individual inputs is obtained when the pan is placed in the center. The width of the yellow rectangle in the Pan window of the “CD” channel indicates the stereophonic space used by all the spread inputs to this channel.



Now try to create several “banks” of inputs, and mix them to various buses (Masters, Aux, Subgroup). Note how useful it is to organize the spreads differently, for example: a complete bank of drum kit elements, or several banks comprising kick mics, snare mics, cymbal mics, tom mics, etc.

### 3.A.6 Creating and using a VCA

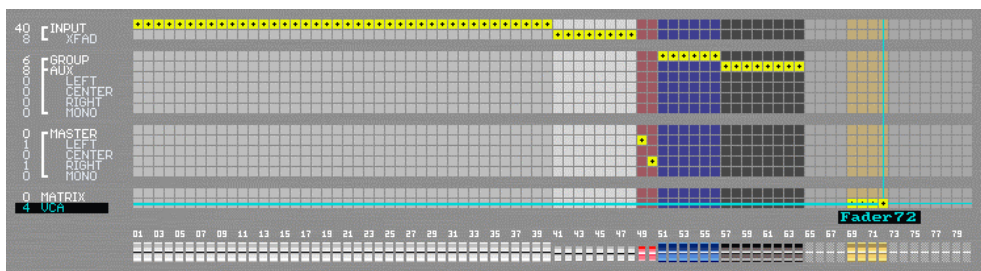

Before using a VCA, it must first be created in the Hardware Configuration window. Faders 65 - 80 have not be used up to now; four of these faders can therefore be used as VCAs. A brief visit to the HARDWARE CONFIGURATION window ([CTRL + C]) will allow you to configure faders 69 to 72 as VCAs. Having done this, press [ESC] to exit this window and save the new configuration.

The allocation of other channels (input and/or bus) to VCAs is made by a simple routing operation: press and hold the [SELECT] button of the VCA while you press the [SELECT] button on the channels that you want to slave to that VCA. The comments on the screen below describe the routing assignment on the “CD” channel as well as on the VCA controlling this channel.

Let's have a look at the current state of the main mix window

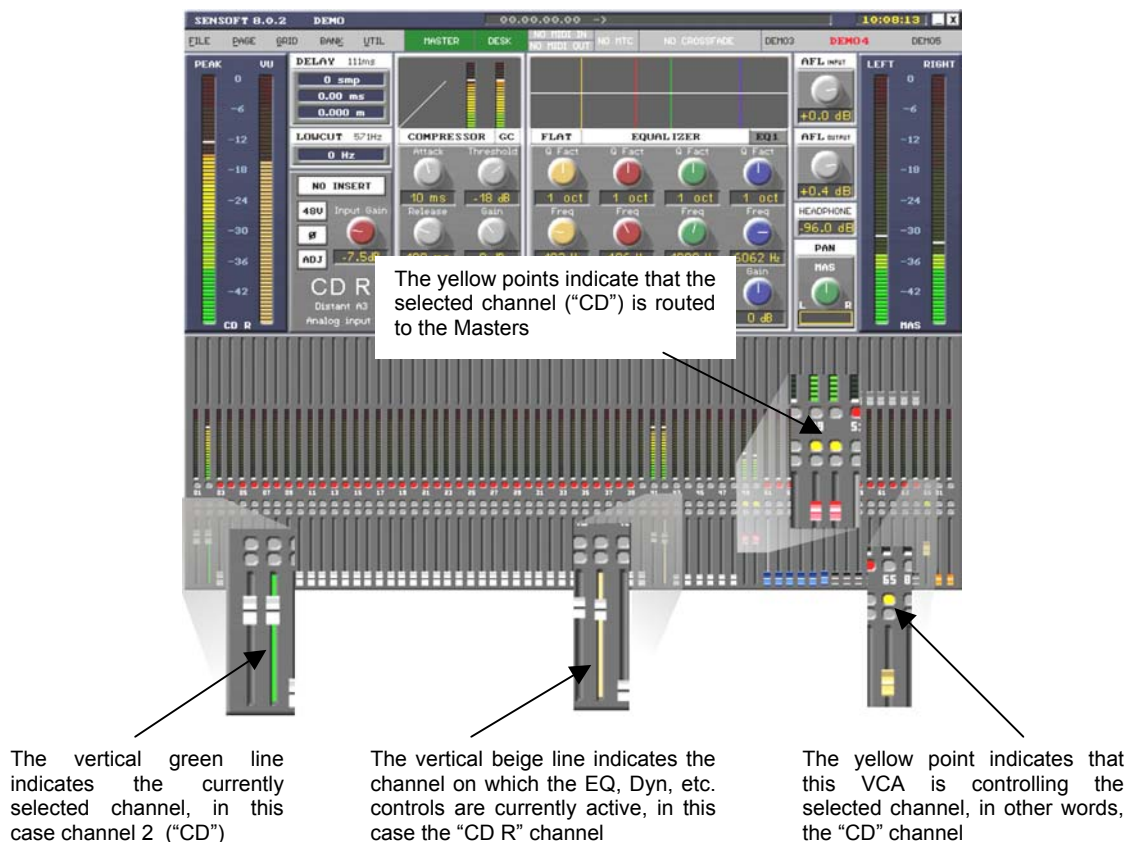

From now on, the VCA will control the "CD" channel. Allocate the VCA to other channels and note how fast and easy this is to do. A VCA can also, thanks to its own [MUTE] button, be used to create banks of mutes.

### 3.A.7 Spreading a Master

There are sometimes cases where it is practical to have access on the control surface to individual faders controlling the busses of a section Master, as it is equally sometimes practical to have only a single fader to control all the busses of a section Master. With the Sy80 there is no compromise. By spreading a Master (or an Aux, Group, etc.) you can have single finger-tip control of all the busses in the section and then, by simply pressing a [SELECT] button, all the busses in the section are available for individual control of their Left, Right, Center and Mono channel balance. Up until now, our Master consisted of two faders, one allocated to the Left bus and the other to the Right bus. We're going to abandon this Master and create a Left, Right and Center version which can be spread.



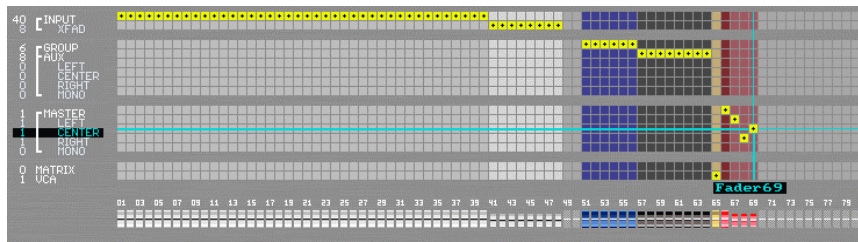

The Hardware Configuration window will allow you to delete the Master used up to now, and create a L, R, C section on faders 66, 67, 68 and 69. Select this window ([ALT] + [C]), and delete any function allocated to faders 49 and 50. Assign the functions MASTER, LEFT, RIGHT and CENTER (in that order) to faders 66, 67, 68 and 69. Press [ESC] to quit this window and save the new configuration.

In the main Mix window, select, on the console, fader 66; press [F3] on the keyboard and name this channel "MAST". As you will have figured out, this channel is going to serve as the overall fader for the Master section.

Then, in the PATCH OUT window, name the outputs **A1**, **A2** and **A3** respectively "LEFT", "RIGH", and "CENT", by positioning the cursor on the relevant output and pressing [F3] to rename it. Naming the outputs first enables useful labels to be created automatically on faders when the patch is made.

Without leaving the PATCH OUT window, select the channel "MAST" (fader 66) again, in order to select the first spread zone fader, fader 67. Patch this fader to the "LEFT" output. Now select the second spread zone fader, fader 68, and patch this to the "RIGH" output. Finally select the third spread zone fader, fader 69, and patch this to the "CENT" output. The result should be identical to the following screen shot.

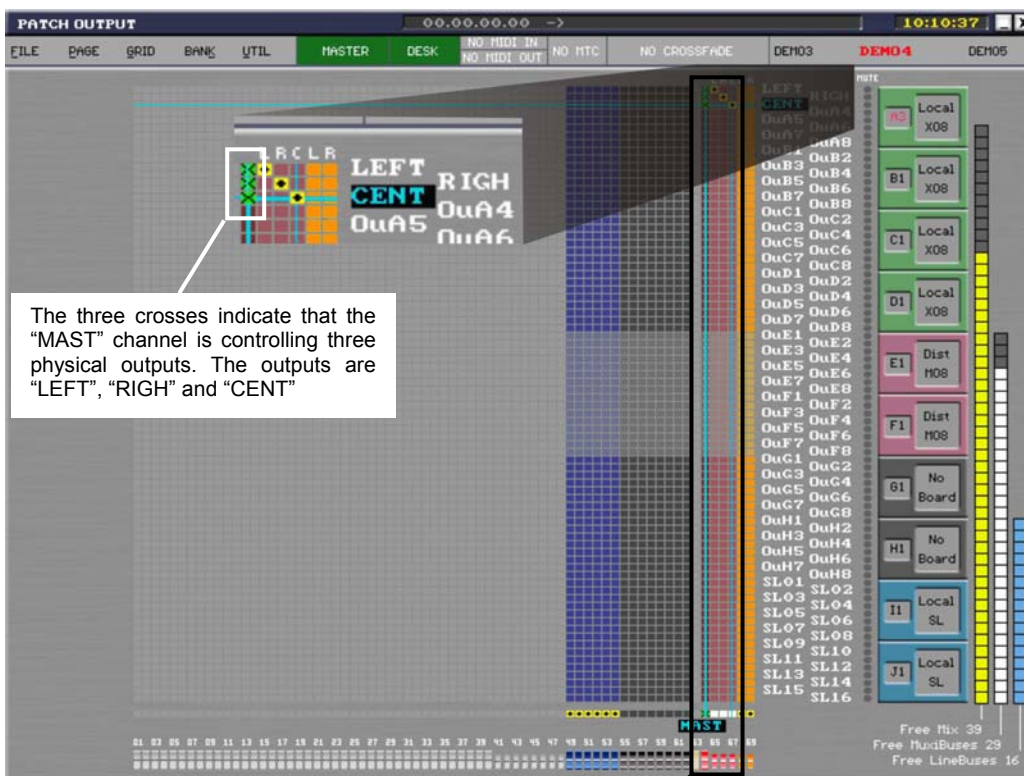

The patch zone for the section Master and it's associated faders



Quit the PATCH OUT window ([ESC]) in order to route the “CD” channel to your new section Master. To do this, hold down the [SELECT] button of the channel “MAST” (fader 66) and press the [SELECT] button of the channel “CD” (fader 2). This has the effect of automatically routing the XFAD of the “CD” channel to all the busses controlled by the “MAST” channel.

Adjust the “MAST” channel to note that this channel acts as a “VCA” on all three L, R, C busses. On the other hand, it is always possible to adjust the balance of individual busses when the Master is spread.



Using the same methods as we have just seen, try to create other Master sections, and notice that they share the same spread zone. Note that section Masters receive the same mix but keep their routing independent. Finally, try controlling inputs and outputs with several VCAs ...

### 3.A.8 Spreading an Aux

Spreading an Aux (or Group) allows it to be used in stereo. Up to four channels can be spread: Left, Right, Center and Mono. Naturally, you are not obliged to use four channels, a L, R only spread can be created. Whenever an Aux is directly patched to an output, it is mono. As soon as a spread zone is created, any Aux (or Group), wherever situated on the console, can use this zone to become multi-channel; it all depends on the way the channel is patched.

A quick preview of the screen shots below shows that the method used to create, patch, and route a spread Aux is identical to the method just used in the application of a spread Master.

Creation of an Aux and a spread zone

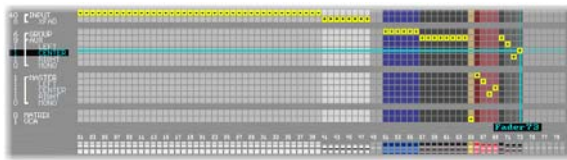

Patch using the same method as for a Master

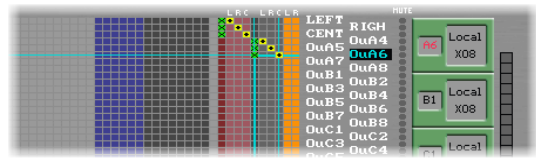

With the help of the screen shots above, create an “AUX” fader, a “LEFT” Aux, a “RIGHT” Aux and a “CENTER” Aux, using faders 70 to 73. Return to the main Mix window and route the “CD” (fader 2) channel to the “AUX” (fader 70) channel. This has the effect of sending, via the Aux Send level, the XFAD of the “CD” channel to the Aux busses that you have just created.

Select the “AUX” (fader 70) and set its fader and that of its busses (71,72 and 73) to 0dB. You have just adjusted the output level of the “AUX” busses (equivalent to the Aux master control on a traditional console). Now select the “CD” channel and, at this point, the “AUX” (fader 70) changes from an **Aux Master** to an **Aux Send** . Raising fader 70 injects the “CD” channel onto the Aux busses.

In a similar way, when a channel Aux is selected, the input channels all become **Aux Sends** so, in monitoring, this function allows every Aux to have a complete preview of the mix made for wedge or in-ear monitoring.



### 3.A.9 Creating a matrix

The Sy80 provides matrixes in which all the input-output resources can be remixed; they are mono and extremely easy to use, as you will now see...

You need to access the Hardware Configuration window to set up one or several faders to have the matrix function. Select this window ([CTRL + C]), and assign the Matrix function to fader 74. Quit this window [ESC], and save the new configuration. A matrix bus is the only bus to which one or several Masters can be sent. Therefore, routing and mixing in a matrix is made in a somewhat “secret” way, that is to say that it is necessary to hold down the **[SELECT]** button of the matrix to route **and** mix the required resources.

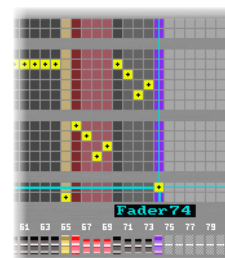

As soon as you release the matrix **[SELECT]** button, faders return at once to their previous states, and Masters regain their original function as Master busses. This method avoids the Master faders staying in their **Matrix Send** position, and therefore having no effect on the PA system in the case of an emergency.

Go to the PATCH OUT window and allocate a physical output to the matrix (fader 74). Quit the Patch OUT window to return to the main mix display.

Un-mute and raise the matrix fader to 0dB. Press and hold the matrix **[SELECT]** button. Press the **[SELECT]** button of channels you wish to send to the matrix, and raise their faders, which now have a **Matrix Send** function. Signals are sent at once to the matrix, according to the level of the **Matrix Send**, of course. You can see this by looking at the level meter associated with the matrix and/or by connecting a PA system to the output allocated to the matrix. Releasing the matrix **[SELECT]** button returns all the faders to their original levels and functions.



Test the fact that Auxes, Masters, Groups, and even Inputs can be remixed via matrixes. Note that, when patched to a Hyperdrive (XO-8D, DO-8X) output module, a matrix can benefit from its own processing and output delay.

Once you have mastered this example, you can be confident that you have taken a major step, and that further discoveries of the many other functions offered by this system will be made easily, and “by ear”!

The main mix window, as it should look by the end of our example





## 4 DIGITAL MIXING IN LIVE SOUND

### 4.A Basic principles of the control surface

All the elements of the console have been designed to cover all the needs of normal live mixing. It is just as easy to mix with an InnovaSON console as with an analog console. Only a few functions will differ from the interface you might be used to, and these are only there to speed up your use of the system; the numerous controls are intended to simplify console operations.

In this section, we'll follow the traditional signal path of a microphone which features in a main "Master" mix, and/or on one of the busses intended for effects, for stage monitoring or another distribution point. To help your understanding, note that feedback from the Sensoft graphic interface always reflects the state of the console; any action on the console is displayed immediately on the screen.

#### For example:

- Moving a fader instigates a corresponding movement on the screen.
- If you select channel 18, the screen immediately displays the relative state of this channel's parameters, while the corresponding on-screen fader image is highlighted.
- Press the **[EQ ON]** button in the "Channel Control" section of the console, making it light up, and the on-screen EQ box will flip from white to yellow, showing that channel 18's EQ is in circuit.

According to the selection made, the screen will display any variation in the different parameters of each channel, and immediately.

#### 4.A.1 Control surface layout

The console features 5 main sections:

- 80 configurable faders for control of inputs, busses, automation or remote control VCAs, according to needs and available I/O resources.
- The "Channel Control" section is dedicated to direct access of the channel parameters (preamp, dynamics, equalizer, panning, etc).
- The "Desk Control" section handles several functions, including access to advanced functions, automation functions and management of the monitor circuits.
- The keyboard and mouse allow access to special functions, but can also supplement controls available on the console.
- A floppy disk drive, fitted to the front of the console, enables file import/export, and software installation.



Although the console faders can display different mix positions for various busses, the mix of inputs to Masters is always displayed on the screen.



As soon as a channel (input or bus) is selected, all the information relating to that channel is immediately updated on the console and/or the screen. You can only activate a single channel or a set of channels (XFAD) at any one time, but all its parameters can be directly modified.

### 4.A.2 Fader configuration: the Hardware Configuration window

The following illustration shows a copy of the **HARDWARE CONFIGURATION** window. This is used to define the function of every fader.

The Hardware Configuration window

The screenshot shows the 'HARDWARE CONFIGURATION' window with a grid of assignable functions. A callout box lists the following functions: INPUT XFAD, GROUP AUX, LEFT CENTER RIGHT MONO, MASTER LEFT CENTER RIGHT MONO, and MATRIX. A mouse cursor is shown over the grid, and a keyboard shortcut [Alt + C] is highlighted. The window also shows a 'UTIL' menu with 'Hard Config' selected.

To assign a function to a fader, simply position the cursor on the column corresponding to this fader, and on the line corresponding to the required function; confirmation by pressing the [SPACE BAR] key, or a right click on the trackball, creates a yellow marker under the cursor and allocates that function to the fader.

Refer to paragraph 3.A.1 for more details on use of the trackball.



## 4.B Audio inputs

### 4.B.1 General Characteristics

InnovaSON consoles provide a new concept of audio input. In effect, and strictly speaking, the pre-amplification and conversion stages are separated from the signal processing stages (dynamics, equalization, mixing). A “distribution grid” is inserted between the preamp converters and the processing channels, allowing any preamp (physical input) to be assigned to any processing channel. This grid is accessed via the PATCH IN window.

All these input signals are then carried, via a digital connection, to one, two, or even three (option) consoles. The electronic input modules are housed in an audio rack, known as Stage Box when it is distant, and Mix Box when local.

Finally, all the input processing channels provide comprehensive facilities : preamplifier (gain, +48V control, phase inversion, high-pass filter), delay (Sy80 DSP only), noise gate/expander (5 parameters), compressor/limiter (5 parameters), 4-band parametric equalizer, independent pre/post fader, pre/post pan and pan-independent routing to the Aux busses. All these functions are pre-determined in the DSP module which allows for a totally inaudible fixed latency, whatever the degree of audio processing in use.



To ensure this low latency, an essential and very much appreciated feature of InnovaSON consoles, **the DSP resources used for a show must be identical on all the “pages” used for the show**. This avoids any latency due to channel reconfiguration at each page change (ie. snap-shot). Of course, it is always possible to load various configurations during a show by using different files of pages.

---

### 4.B.2 Layout of physical inputs

Each of the XLR inputs has its own identification, governed by a simple principle: it is designated according to its position in the audio racks.

#### Example

- The physical input “Local H4” is the input numbered “4” on the module installed in slot H of the Mix Box rack.
- The physical input “Distant D2” is the input numbered “2” on the module installed in slot D of the Stage Box rack, normally located on the stage.



The Stage Box audio rack is delivered with an **input module (SI-8D)**, which must be fitted in **slot A**. This card (or another input card) has to be in place in order for the Stage Box to function correctly; it represents the minimum resource necessary for a Stage Box.

---

Moreover, consoles supplied with the Sy80 DSP module are equipped with 16 analog line level inputs, the others have 8 line inputs. These inputs are available on two or one SUB-D 25-pin connectors respectively, fitted on the DSP module (see section 4.B.4).

### 4.B.3 Universal analog inputs

Each of the female XLR connectors (SI-8D modules) allows connection to an electronically balanced universal preamp, which accepts signals with levels between -51dBu and +26dBu. The phantom power may be turned on/off independently, channel by channel; a yellow LED indicates this next to the connector. The phantom power can be generated by the input module itself or from an external source (mic power supply, analog console, etc.). Take care in such cases **not** to turn on the 48V on the input module, as this could prove destructive. In all cases (internal or external phantom power supply) the yellow LED will indicate the presence of 48V on the relevant input.

The green LED and the red LED indicate signal presence and signal respectively. Every input cable should be wired as follows:

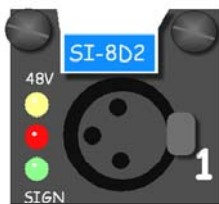

- Pin 1: analog ground
- Pin 2: audio hot
- Pin 3: audio cold

Each preamp can be controlled from the center section of the console, according to its “Patch IN” assignment (refer to section 4.C – Input Signal Path). The available gain range is from -27 to +63dB, in 1.5dB steps. The phantom power supply current is limited to 6mA. The output of the preamp feeds a 24-bit Delta-Sigma analog/digital converter.

### 4.B.4 Analog line inputs

16 line level inputs may be connected via two SUB-D 25-pin connectors, situated on the DSP module fitted in the Mix Box rack. Every input is electronically balanced and feeds a 24-bit Sigma-Delta A/D converter directly. The nominal input level is fixed at 4dBu and the full scale is at 22dBu. It is not possible to alter this. Cables equipped with a SUB-D25 connector at one end and XLR splits at the other are supplied with the system. The DSP Sy40-8 is equipped with 8 line level inputs (the SUB-D25 cabling is different), the nominal input level is fixed here at -6dBu and the full scale at 12dBu.



The line level inputs are accessed only by the DSP module itself and, from this, the signals vu-meters are not displayed on the screen but only on the console's bar-graphs.



For correct operation, all the input modules must follow one another (without gaps) in the Mix Box slots.

#### 4.B.5 Distant inputs (Stage Box)

The Stage Box can accommodate up to 64 inputs on stage. Depending on the situation, Stage Box must then be connected to Mix Box by one or two coaxial cables. The status of the console can be SLAVE (1 cable) or MASTER (2 cables) – see Section 9 for more details. Stage Box is supplied with 8 analog inputs in slot A; additional input modules can be added to the rack, according to requirements.

**When adding to the basic configuration, you must respect the following rules:**

- Stage Box has a banner printed with the letters A to H, indicating the positions of the audio modules. Slot A is reserved for an input module (analog or digital) only.
- All input modules must follow each other sequentially.
- Modules can be installed indiscriminately across two audio racks, following the principle that every slot carrying the same letter can house only one input module at the same time. So, if slot D of the Stage Box is equipped with an input module (SI-8D or DI-8S), slot D of the Mix Box can only house an output module, or remain empty. According to the first rule above, slot A of a Stage Box must contain an input module, so slot A of the Mix Box will necessarily house an output module.

As the procedure for installing new modules calls for particular attention, avoid doing this when the system is set up in its working environment. Take the time to isolate the audio rack in a quiet place, where you can be sure of what you are doing – keeping the system in good working order depends on it.....



Turn off all the system elements. At the required slot, undo each of the four screws by turning a quarter turn to the left, and remove the cover.

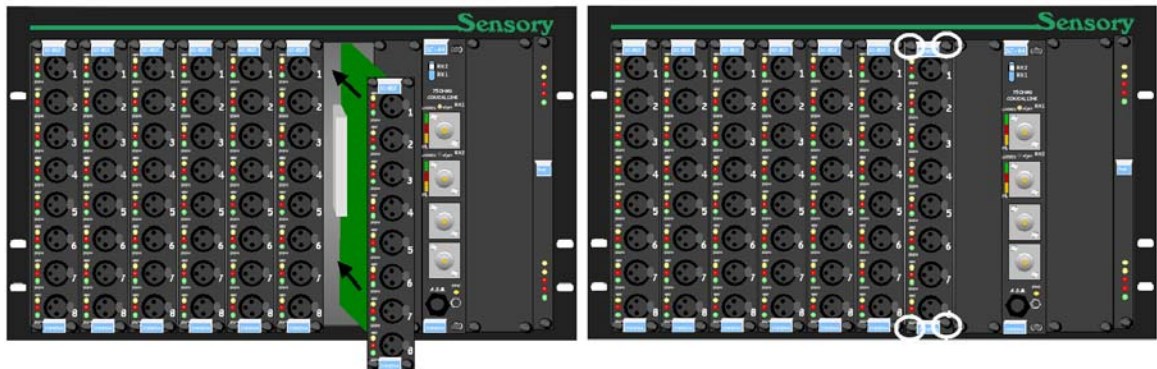

Slide the top and bottom edges of the module slowly into the rails provided in the rack slot. Push the module in until it is fully engaged. Lock the 4 screws to secure the module.

In the Sensoft HARDWARE CONFIGURATION window, selected by pressing the [ALT] + [C] keys on the keyboard, you will find the added board is now visible and identified. Information, such as the current software version of cards can also be seen, if required.



The number of distant inputs can be extended to 64. Contact your retailer to obtain additional SI-8D or DI-8S modules.

## 4.C Input signal path

For a better understanding of the features and different aspects of an InnovaSON console, as you read on, follow the path of a normal signal shown on the diagram in Section 9.E.3.

Having connected all the microphones to input modules, you must choose which microphone will be allocated to which fader, or to which bank of faders if you decide to exploit the possibilities offered by the **XFAD™** function. For this there is an matrix (grid), designed specifically for the assignment of preamps to faders, known as the “Patch IN” grid. Note that the order in which you plug up the mics is not important, as any physical input can be assigned to any fader.

### 4.C.1 XFAD : the principles

The spreading out of inputs in zones set up by the **XFAD** function allows the user to create compound “banks” of faders, consisting of as many XFAD as necessary, and positioned anywhere on the control surface.

To understand the basic principle of this function, take a look at the figure below. This shows an example based on 8 faders, 4 of which are allocated to the **Input Fader** function, in other words, the general control faders for our fader “banks”, and the other four are allocated to the famous **XFAD** function.

Schematic of eight faders used to spread inputs

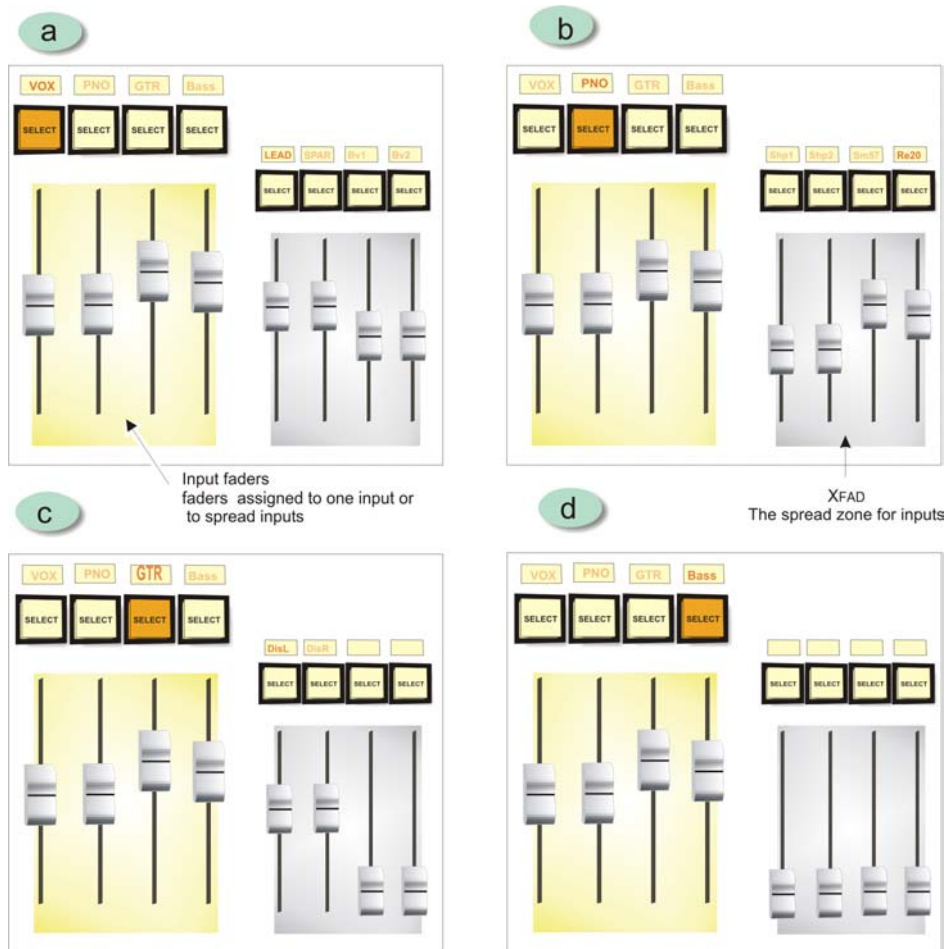

In this example, the 4 “large” faders are assigned to the control of a single input, or to inputs in the spread zone. The spread is made on the 4 “small” faders.



Note that the spread zone and the number of spread faders are only defined once for all the pages of the same work file.

**Figure (a)** above shows the behavior of faders when you select the first input fader. The label associated with this fader carries the entry “Vcls” for VOCALS, so this fader is controlling the mic inputs for the lead vocal and the (gospel) choir mics. When this fader is selected, its [SELECT] button lights and flashes, and the fader label lights up and flashes too. The 4 faders in the spread zone become, and control individually, the input channels of the vocal mics

When the “Vcls” fader is spread, you can see the spread faders are labeled “Lead”, “SPAR”, “Cho1” and “Cho2”. In figure (a) of the example, you can see that the “Lead” channel has its label highlighted; this indicates that the processing (EQ, Dynamics, etc.) will currently act on the “Lead” input channel. Successively pressing the [SELECT] button of the “Vcls” fader alternately selects the other spread inputs, to allow access to the processing on those channels.

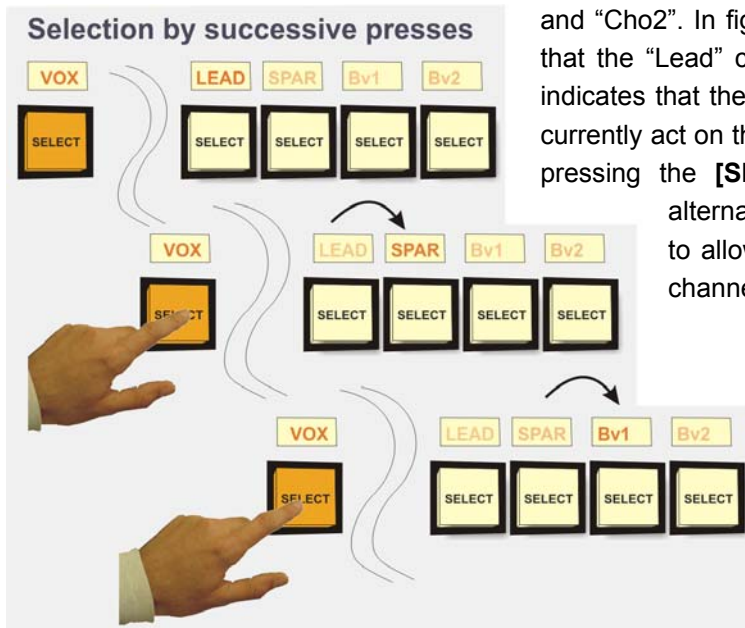

Another method of selecting the channel on which you want to adjust the processing is simply to use the [SELECT] button of the XFAD associated with this input, when the input is spread, of course. In that case, the [SELECT] button of this input, as well as its label, will begin flashing.



On the same principle, figure (b) shows that, by selecting the “Pian” channel, faders belonging to its spread zone immediately appear in the right position and allow access to the various mics used for the piano. The patch made for the “Guit” input, in figure (c), uses only 2 XFAD out of the 4 available, as the guitar is only being covered by two mics. As for the “Bass” input, figure (d) shows that no XFAD is necessary, as there is only one mic used on the bass. This mic is therefore directly accessible on the “Bass” channel; the associated XFAD have no labels and, without a patch, they are simply not used.

#### 4.C.1.1 INPUT channel Parameters and XFAD

The figure below shows the influence on XFAD channels when parameters on the Input channel are adjusted. Certain parameters act only on the active XFAD channel, while others, such as the routing, act on all the XFAD channels associated with the channel you are adjusting.

Influence on XFAD channels when adjusting Input channels

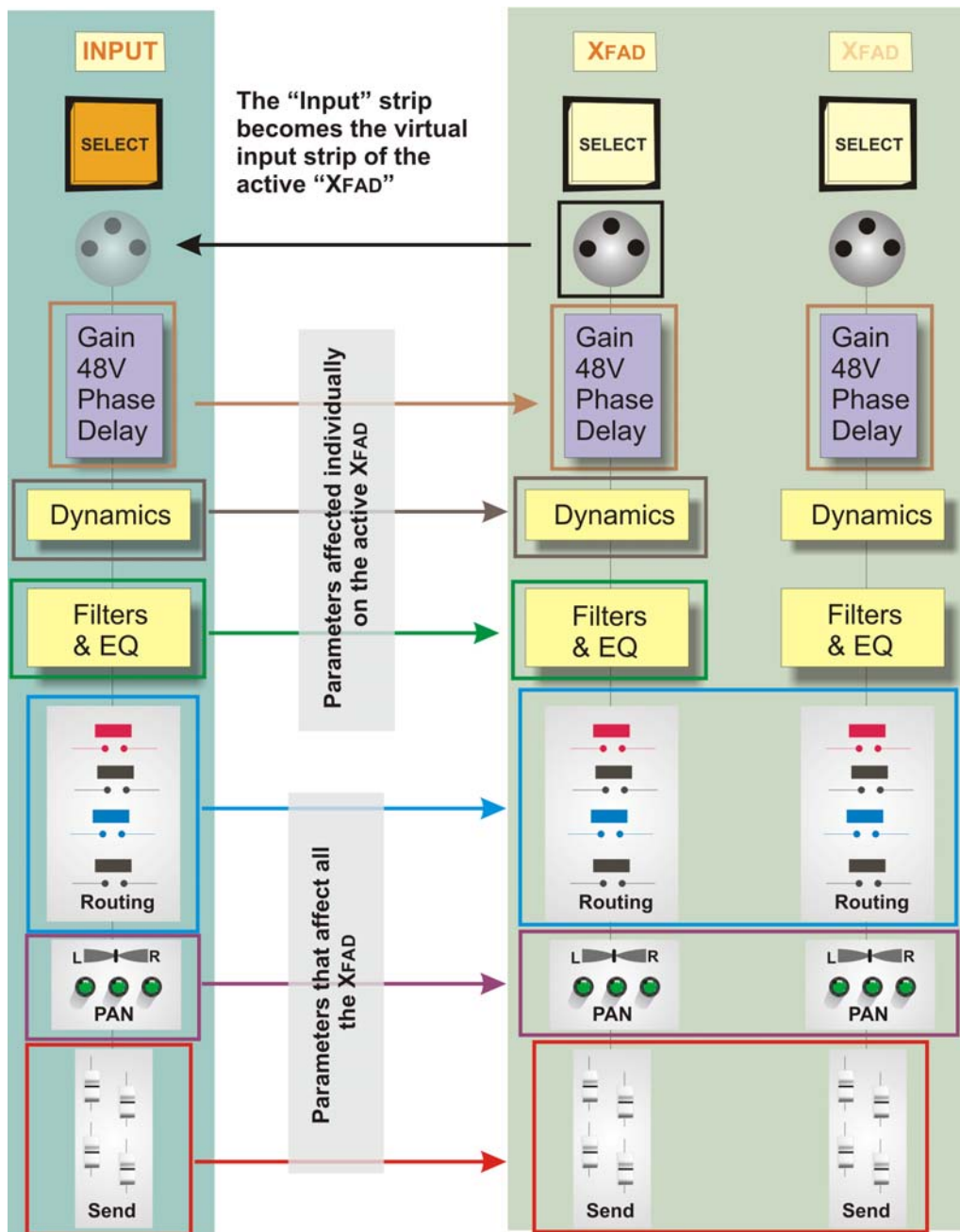

As you saw previously, every time you press the **[SELECT]** button of the Input channel, it changes the active XFAD channel, passing from one to another in succession. Adjustment of gain, phantom power, phase, dynamics, filtering and EQ, made on the currently selected Input channel, are directly echoed on the active XFAD channel. It's as though the Input channel becomes a "virtual" channel for the active XFAD channel.

Of course, you can always press the **[SELECT]** button of the spread XFAD channel to access all the parameters of **that** channel directly. In this case, parameters that are common to all the spread channels, such as routing, send busses, etc., become individual, and affect only the currently selected XFAD channel.

Parameters such as routing, and the pan or Aux send settings, when they are modified on an Input channel, affect all the XFAD channels in the spread zone. Throughout the description of functions provided by Sensoft 8, specific items relating to Input channel parameters will be made clear in the following sections.

When a channel is selected ([**SELECT**]), its label becomes brighter and flashes, as does its [**SELECT**] button.

### **4.C.2 Preamp to fader assignment grid (Patch IN)**

Each time you start a new file, the patch configuration is empty; there are no pre-programmed assignments.

#### **4.C.2.1 Access to the input distribution matrix:**

The figure below describes how to access three Sensoft 8 patch grids, which are:

- **Patch IN:** assignment of physical inputs to faders
- **Patch OUT:** assignment of physical outputs to faders
- **Direct I/O:** direct connection of physical inputs to physical outputs (local or distant).



Access to the patch grids

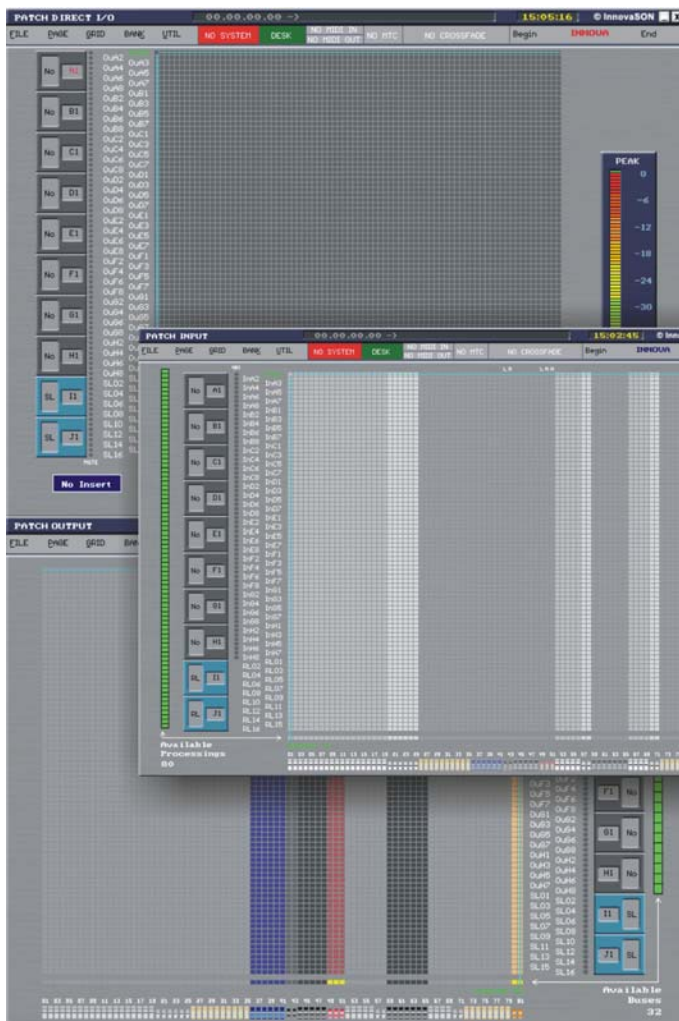

How do I get there?

by track-ball



Select the required grid in the Grid menu

by keyboard

Patch In :key [F11]  
Patch Out : key [F12]  
Direct I/O : key [F10]

On the console

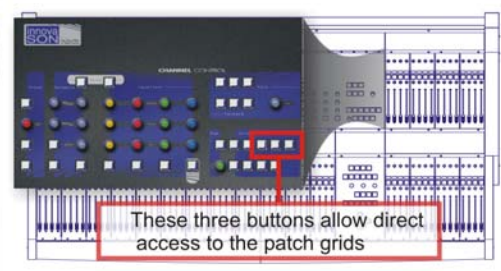

4.C.2.2 Item Selection (see paragraph 3.A.1 for details on trackball operation):

When selecting different console channels (whether directly from the console by pressing [SELECT] buttons, using the cursor keys on the keyboard, or with the trackball), on the screen you will see a vertical blue line in the corresponding position, while a horizontal blue line is available to scan a list of all the inputs on the left of the grid. As each input is selected, its “physical” position in the audio rack is highlighted in red in a small box, identified by 2 characters (eg. C3), based on the corresponding rack labels.

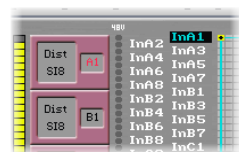

On the right-hand side of the grid is a representation of the 8-input modules present in the racks, as well as any Line Inputs.



Digital input modules work fine in a distant rack but they will be detected by Sensoft as SI-8D analog modules; this does not stop them functioning properly.

### 4.C.2.3 Patch Assignment

Use of the Patch IN grid will differ depending on whether you want to allocate a fader to a **single** input or to a **bank of inputs** (using the XFAD spread facility).

#### a) A fader assigned to a single input

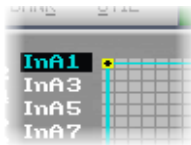

To create an assignment, all you need to do is choose a new point for the cursor intersection of a channel and an input, and then press the [SPACE BAR] of the keyboard (or the right button of the trackball). A yellow and black marker appears at the corresponding point, and the input signal is assigned immediately to the chosen channel. Pressing again on the [SPACE BAR] deactivates this connection.

The same mic preamp can be split over several channels of the console, allowing you to have different channel parameter settings for the same input signal. To quit the Patch IN window, press on the [PATCH IN] button again, or on the keyboard's [ESC] key.

When you are creating a new patch point, another marker, also yellow and black, appears on the line at the bottom of the grid, just above the fader that you have just patched. This marker indicates that a DSP resource has just been assigned to this fader. Note that, if you cancel your previous patch point, it does not cancel the DSP resource assigned to the fader.

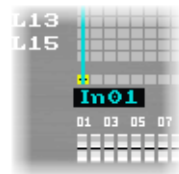

This is explained by the fact that, once assigned, a DSP resource is reserved for all the pages of the current work file. It is possible that, from one page to another, a fader designated as an input may, or may not, be patched to an input. But if, at least, a single page requires the fader to be patched then, to optimize latency time and DSP management, the resource is assigned to all of the pages.

The Sy80 DSP module can handle up to 80 input resources (48 for DSP Sy40-8). If, for any reason, you need to free up an input resource, simply position the cursor on the corresponding fader (in the bottom line) and cancel the patch point.

**Note:** this has the effect of removing the resource for all other pages in the current file..... you have been warned!

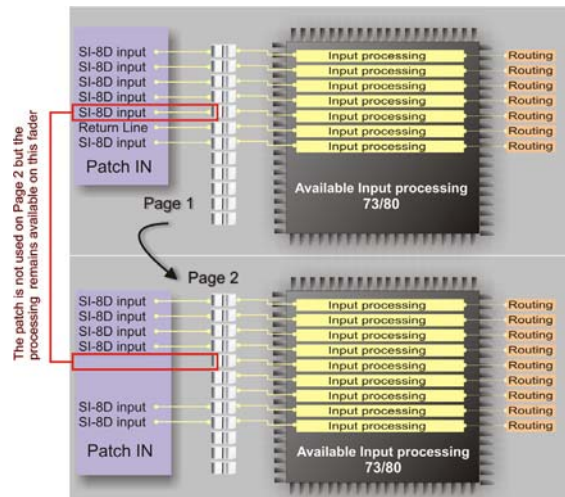

#### b) A fader assigned to control a bank of XFAD

Obviously you won't be able to patch spread inputs until several faders have been configured as Input faders, and some other faders as XFAD (see paragraph 4.A 2).

The following figure shows the necessary stages for smooth operation of the PATCH IN window when you are using the Sensoft 8 "spread inputs" function.

**a** Press the Input channel [SELECT] button to place the cursor in the corresponding column.

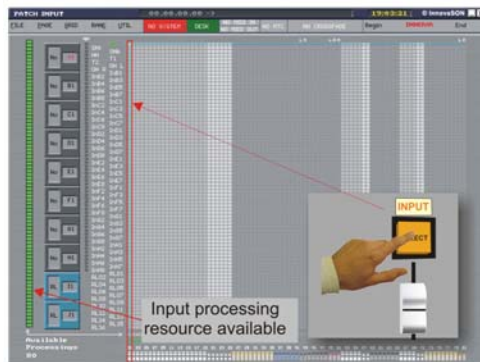

**b** Now press [SELECT] on the corresponding XFAD to patch the physical inputs



**c** One or more XFAD can be used in this way in the spread zone

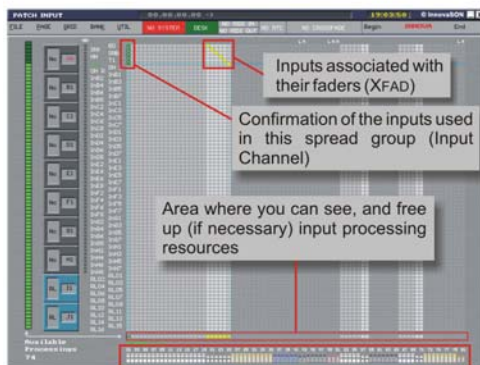

**d** Spread zones can be moved to different areas, for easier access.



Note that the fader configuration remains visible in both Patch IN and Patch OUT windows

As you will have noticed, the PATCH IN window is very rich in information, allowing you to figure out the exact state of the console and its associated DSP resources.

The small squares that make up the patch grid are all gray, but have 3 shades to distinguish their status:

- The darkest shade represents areas in which input patching is not possible (faders have been allocated to Groups, Auxes, Masters, etc.).
- The lightest shade represents areas where faders have been allocated to XFAD use.
- The medium shade represent those areas of faders that may be designated as input faders; they can be directly patched to an input or allocated to a set of XFAD.

The patch points also have a color code to aid their recognition:

- Patch point of a physical input and/or a DSP resource on a fader configured as an input or XFAD
- ✕ Assignment Point of a fader in a set of inputs controlled individually by XFAD

#### 4.C.2.4 Pre-amp label



Labels on the control surface take the name of the input to which the console channel is patched. Before a patch is made, labels are given a default name, that reflects the state of the console at the time of its “construction”. For example, as long as they have not been patched, **Input** channels are named “In01”, “In02” etc.; XFAD use “Idep” for their default name (short for “Input Deployment”).

Inputs can be named from the PATCH IN window, or from the main MIX window for those inputs already allocated to channels. Input channels assigned to the control of XFAD can only be named on the main MIX window.

#### 4.C.2.5 Naming Inputs from the Patch IN window

Position the horizontal cursor line on the relevant input and press [F3] on the keyboard to name this input, and only this input, using the keyboard (4 characters max.). To quickly name several inputs, press [ALT]+ [F3]; this makes the system pass automatically to the following input as soon as you have named the previous input. To quit this mode, just press the [ESC] key. Inputs already allocated to faders immediately transfer their names to the labels on the console.

#### 4.C.2.6 Naming Inputs from the main Mix window

To modify a label (having first selected the required channel) type [F3] on the keyboard, then four letters for the name, and confirm this new label by pressing the [ENTER] key. The name is transferred immediately to the label display of the relevant channel.

To modify several labels, type [ALT] + [F3] on the keyboard, then four letters for the name, and confirm it. The software passes automatically to the following label, etc. To quit this mode, simply press [ESC].

The figure below shows the essential stages in label modification procedure when Sensoft is displaying the main Mix window.

#### Modifying a label from the main Mix window

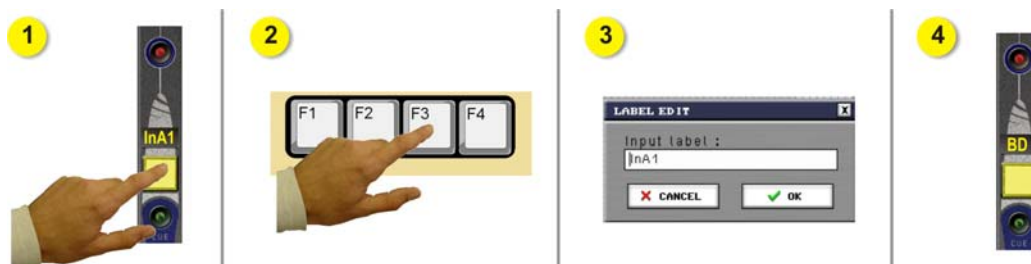



Name all the inputs from the PATCH IN window, then name all the outputs from the PATCH OUT window, and it will be a pleasure to see the labels displayed with their right names, in the right place, as soon as you make the patches.....

### 4.C.3 Preamp settings (Gain, 48V)

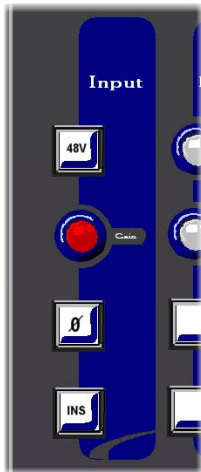

As any preamp can be assigned to a console channel, its configuration is carried out by Sensoft software. In the case of an input split over several channels, any modification of the settings on one of the channels will be reflected on the other channels, given that there is only one preamp at the outset. The 48V phantom power, the gain and the label are all in the preamp settings group.



The Gain and 48V parameters are specific to a single preamp (except for channels that have been intentionally linked). So, when an Input channel (bank of XFAD) is selected, the settings will be made on the preamp of the XFAD currently “under” the Input channel. Press the **[SELECT]** button of this Input channel to scroll through the XFAD one after the other, in order to decide which preamp will be adjusted by default when the Input channel is selected.

When you modify the preamp settings while an Input channel controlling a set of XFAD is selected, the changes are echoed on the active XFAD. Press the **[SELECT]** button of this **Input** channel repeatedly to change the active XFAD (see paragraph 4.C.1).

#### 4.C.3.1 Phantom power (48V)

To activate a preamp’s phantom power, simply select the channel to which you want it applied, then press the **[48V]** button in the Input section of the Channel Control panel. The key lights up, on the console as well as on the screen. The keyboard command for this is **[F7]**. To deactivate the phantom power, simply turn off the corresponding key by pressing it again. The phantom power supply voltage is 48V, and its current is limited to 6mA. Line Inputs are not equipped with phantom power.



The activation of phantom power by means of the **[F7]** key is also available on the DIRECT I/O PATCH window, to allow the control of inputs used to transfer signals from one audio rack to another, without these signals being assigned to one of the console faders (thus not benefiting from the console’s channel controls).

### 4.C.3.2 Gain

The default setting for all the preamps is 0dB. The analog gain range extends from -27 to +63dB, in 1.5dB steps. To adjust an input signal correctly, select the channel to which the preamp is assigned, then turn the gain pot in the Input section of the Channel Control panel. The new value will be visible on the screen, as shown beneath the “virtual” pot.

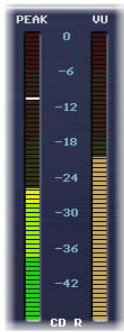

The keyboard commands are [F5] to decrease, [F6] to increase the gain. On the left of the Sensoft screen, two meters show the signal level of the selected preamp. The left bar is a Peak meter, the one on the right is a VU level meter. These two meters are always pre-processing, thus they represent the signal measured at the output of the preamp. It's the same for the Sensoft Peak meters, just above the on-screen representation of the faders. These meters should be observed when you adjust the gain of a preamp, whether it be local or distant. The gain should be adjusted to achieve maximum modulation on the VU meter scale, without lingering at the 0dBFS point on the Peak meter scale.



It is foolish to assume that, in digital technology, one can “under-modulate” without a problem, given the low background noise generated by the system. Don't forget that the preamp is analog and that, although it is of very high quality and very close to the source, it is still very important to optimize the signal-to-noise ratio at the input stage.



The control of gain by [F5] and [F6] is also available on the DIRECT I/O PATCH window, to allow the control of inputs used to transfer signals from one audio rack to another, without these signals being assigned to one of the console faders (thus not benefiting from the console's channel controls).

### 4.C.4 Delay

For consoles equipped with the Sy80 DSP module, every input assigned to a console channel has its own adjustable delay of 0 to 111ms. Use the console's **DELAY ON** button to activate or deactivate the delay.

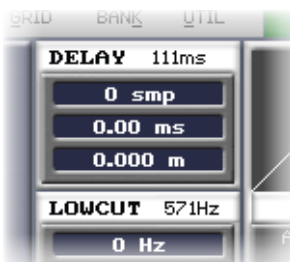

A window consisting of three fields indicates the delay in samples (smp), milliseconds (ms) and meters (m). All you need to do is point, using the trackball, at one of these fields and to use the left button (-) and the right button (+) to adjust the value. According to the chosen field, this will result in a more or less fine adjustment. The samples field allows very precise adjustment; the meters setting gives a coarser adjustment.

### 4.C.5 Phase Inversion and the High-Pass filter



These parameters are linked to every channel of the console and work in the digital domain. Unlike the 48V and Gain parameters, the parameters that we are now going to describe are controlled by the Mix Box DSP module, they are no longer simple remote controls sent to the I/O modules. We can therefore invert the phase or set the low-cut filter separately, on all the desired channels, whatever the input signal is (split or not).

Even then, any modification of one of these parameters while an **Input** channel is selected, will see the changes echoed only on the active XFAD and not on all the XFAD. Press the channel Input **[SELECT]** button several times to change the active XFAD (see paragraph 4.C.1).

#### 4.C.5.1 Phase Ø

To invert (180°) the phase of an input signal, select the channel concerned and press the **[PHASE]** or **[Ø]** button on the central Channel Control panel. The button lights, as does its on-screen representation. To return the phase to normal, deselect the **[PHASE]** button. You can also use the trackball and click the on-screen button to implement the phase invert function.

#### 4.C.5.2 The Low cut filter



The filter slope is 12 dB/octave. The roll-off frequency can be set between 30Hz and 571Hz, in 53 steps.



To activate the filter on an input signal, select the channel concerned, then press the console's **[LOW CUT]** button. The on-screen filter box lights turns yellow to indicate the filter has been selected.

As soon as the filter is activated, its console button lights up, and its influence is visible in the on-screen equalization curve. The value of the filter can be adjusted using the left and right buttons of the trackball when it is pointing at the FILTER window. The frequency curve for the main equalizer is updated by high-pass filter settings, even if the main equalizer is not switched in.

### 4.C.6 Dynamics

Every channel possesses its own set of processing (noise gate, compressor), the parameters of which are digitally processed. This allows several gates or compressors to be set differently on the same split input signal. The “Dynamics Processing” section has 3 buttons and 5 rotary controls, alternating between control of gate and compressor parameters. The on-screen representation follows the arrangement of the console controls, and any physical change on the console is echoed immediately on the screen. Note that the dynamics curve shown on the screen is the sum of all the effected dynamics processing (compression, gating, etc.).

By default, the 5 rotary controls in the dynamics section are allocated to control of the compressor. To switch to control of the gate, press the **[GATE CONTROL]** button, which will illuminate in red. On the screen, the values and the relative functions of the corresponding control are updated. Using the trackball, it is also possible to click on the “G/C” box, above the on-screen dynamics, to toggle between control of the gate and the compressor.



The dynamics section on the Sensoft screen



Dynamics section in Compressor mode (inactive).



Switch to Gate mode by pressing the **[GATE CONTROL]** button.



Activate the Gate by pressing the **[GATE ON]** button.

Any adjustment of one of the dynamics section parameters, while an Input channel is selected, will see the changes echoed only on the active XFAD, and not on all the XFAD. Press the Input channel's **[SELECT]** button several times to change the active XFAD (see paragraph 4.C.1).



#### 4.C.6.1 Noise-Gate / Expander

The **Gate/Expander** function allows a signal to pass as soon as it exceeds a certain threshold (noise gate), or to be attenuated by a specified amount as soon as it falls below this threshold (expander). The attack, hold and release times are used to control the sensitivity and efficiency of the processing, according to the nature of the signal. The default values are: 10ms for the attack time, -95dB for the threshold, -95dB for the attenuation (Range), 50ms for the hold time, and 550ms for the release time.

**The range of values is as follows:**

- Attack : 0.5 to 200 ms
- Threshold : -95 to +10 dB
- Range : -95 to +10 dB
- Hold : 0.5 ms to 10 s
- Release : 50 ms to 10 s

The on-screen representation follows the arrangement of the controls on the console, and any “physical” alteration is echoed at once. The corresponding software control is made using the left and right trackball buttons when the pointer is over the parameter to be adjusted. To activate the gate, press the [**GATE ON**] button, which lights up. The function is now active, and the corresponding on-screen area highlights in yellow. From now on you can adjust the gate parameters by means of the 5 rotary controls, obviously, on the condition that the [**GATE CONTROL**] function is activated (the button is lit in red).

To adjust any of the five parameters, turn the corresponding rotary control on the console, until you find the required value. The on-screen dynamics contour line is updated according to the settings of the threshold and attenuation parameters.

To return to the default values, press the [**FLAT**] button, then press the [**GATE**] button and confirm by pressing the  button, or click “FLAT” in the EQ window.

The state of a gate (opened or closed) is indicated by the illumination (= closed) of a blue (Sy80) LED at the top of the control surface VU meters.

#### 4.C.6.2 Compressor/Limiter

The compressor/limiter serves to reduce, at a chosen rate, the signal level as soon as it exceeds a certain threshold. Unlike a gate, this processing minimizes the dynamics of a signal, to adapt it for a PA system or recording. To control its sensitivity and efficiency, attack time, release time, threshold, ratio, and output gain (make-up gain) parameters are all provided. The default values are: 10ms for the attack time, 100ms for the release time, -18dB for the threshold, 1:1 for the ratio and 0dB for the output gain.

The range of values is as follows :

- Attack : 0.5 to 200 ms
- Release : 50 ms to 10 s
- Threshold : -95 to +10 dB
- Ratio : 1:1 to  $\infty$ :1 (Limiter)
- Output gain : -11 to +20 dB

Before setting the compressor parameters, make sure that the **[GATE CONTROL]** button is deselected. The corresponding on-screen area then flips to control of the compressor. The display follows the arrangement of the rotary controls on the console, and any “physical” adjustment is echoed immediately on the screen. The corresponding software control is made using the left and right trackball buttons when the pointer is over the parameter to be adjusted. To apply a compressor to an input signal, press the **[COMP ON]** button. It lights up and the compressor is enabled. The corresponding area of the screen is highlighted in yellow, and it is now possible to use the rotary controls. To adjust one of the five parameters, turn the rotary control on the console until you find the desired value.

To return to a “flat” compressor (default state), press the **[FLAT]** button, then the **[COMP]** button and validate by pressing the  button.

#### 4.C.6.3 Compression indicators

The on-screen graphic representation of the dynamics curve echoes modifications made to the threshold and ratio settings. Three small meters situated just above the compressor window indicate (from left to right): **1.** the input level, **2.** the rate of gain reduction (in green) and **3.** the level after compression.

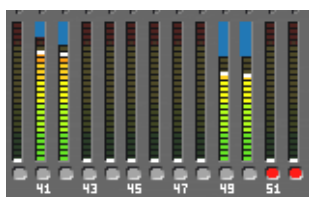
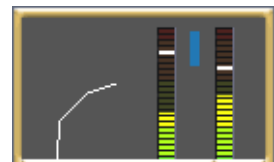

If you want an on-screen view of the gain reduction implemented by all the active compressors, simply type **[ALT] + [B]**. This produces blue bar-graphs above the peak-meters, indicating the rate of gain reduction for all channels on which a compressor is active.

### 4.C.7 Equalizer

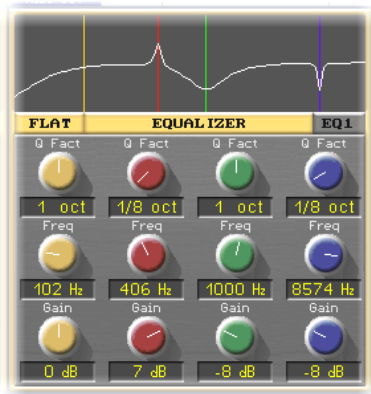

The equalizer section has 2 buttons and 12 rotary controls, each having a unique function. The layout of equalizer controls on the console can also be found on the screen, and every “physical” rotary control drives its “virtual” equivalent. The equalizer has four true parametric bands, with controls for frequency, gain, and bandwidth (“Q factor”), allowing it to accurately shape the audio spectrum of the input signal. Any modification to one of the equalizer parameters, while an Input channel is selected, will echo the changes only on the active XFAD and not on all XFAD. Press the **[SELECT]** button on the Input channel several times to change the active XFAD (see paragraph 4.C.1).

**The default equalization parameters are :**

- Band 1 : 102 Hz, 0 dB, 1 octave
- Band 2 : 406 Hz, 0 dB, 1 octave
- Band 3 : 1000 Hz, 0 dB, 1 octave
- Band 4 : 6062 Hz, 0 dB, 1 octave

**The range of values for every band is as follows :**

- Frequency : 27 à 19698 Hz (96 values)
- Gain :  $\pm 15$  dB (in steps of 1 dB) et 1 notch position (-50 dB)
- Q Factor : from 1/8 to 8 octaves (by the power of 2)

To apply an equalizer to an input signal, press the **[EQ ON]** button on the console. It lights up, the equalizer is enabled, and the associated on-screen box turns yellow. The corresponding software switch requires clicking on “EQUALIZER” at the top of this area. To modify any of the twelve parameters, simply turn the rotary control on the console until you find the desired setting. The same effect can be achieved, via software, by clicking with the mouse (to the left to decrease, to the right to increase a value) on any of the on-screen “virtual” controls. To return to “FLAT” equalization (default values), press the **[FLAT]** button, then the **[EQ]** button and confirm with

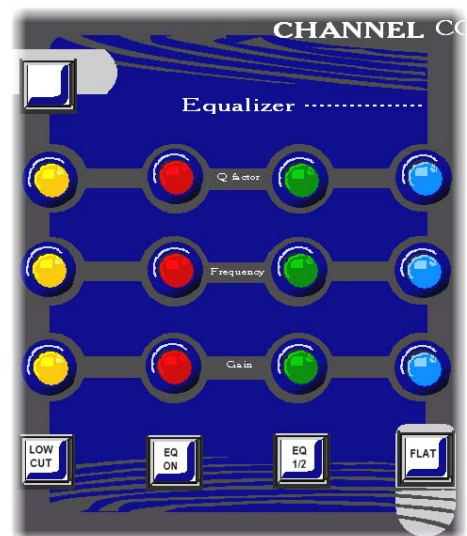

The graphic representation of the equalization curve echoes, according to the band in use, the slightest parameter modification; each band has its own colored line, the color being identical to that of the rotary controls for that band. Every band has access to the complete frequency spectrum.



The [EQ 1/2] button is not discussed here because it is used in conjunction with the processed outputs' equalizer, provided by XO-8D and DO-8X modules.

The EQ parameters are available on every channel of the console. Splitting the same input signal across several channels, allows you to set up the same number of independent parametric equalizers.

#### 4.C.8 Inserting an external device

It is possible to designate pairs of inputs and outputs as Insert Send and Insert Return points, allowing the addition of external processing in the input signal path.

Any action on one of the insert parameters, while an Input channel is selected, will see the changes echoed only on the active XFAD and not on all XFAD. Press the Input channel's [SELECT] button repeatedly to change the active XFAD (see paragraph 4.C.1).

##### 4.C.8.1 Setting up Insert Send / Insert Return points

To set up an input/output pair as an insert point, access the Direct I/O window (see paragraph 4.C.2.1), position the cursor on the intersection of the required IN/OUT and type the letter [ I ] ("I" for insert) on the keyboard, or press the [INS] button on the control surface.

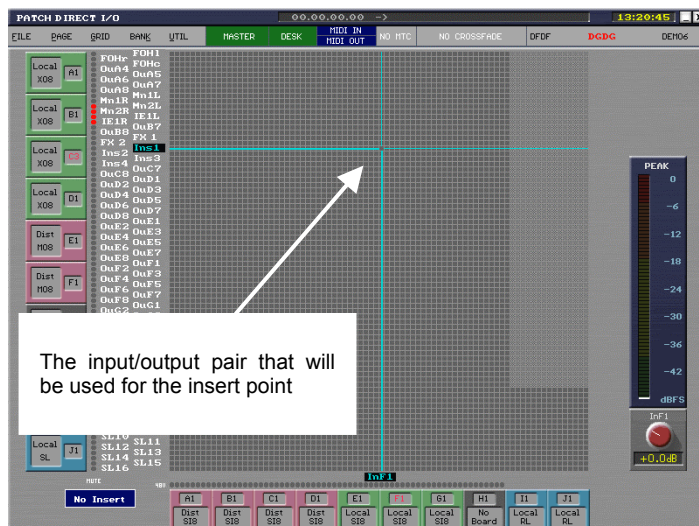

A window opens asking you to enter a name for the insert point. Give the insert the same name as the device that will be connected to it (Comp, Pre-amp, etc.).

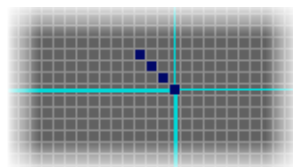

Once the name has been confirmed, the grid point turns blue, indicating that this input/output pair has been nominated as an Insert Send and Return.

All the inputs and outputs so defined as insert points will belong, from now on, to the current file; thus all the pages of this file will contain all the inserts that have been set up.

**4.C.8.2 Assignment to a channel**

Having created the insert points, it only remains to connect the devices to be inserted on the console channels. The inputs using these devices will be chosen in software, and can vary from one page to another. It's as though you can remember in a snapshot the physical patch points where insert cables have been connected to the console.

Select the channel on which you want to insert a device, by holding down the [SELECT] button of the Input in question and pressing the [INS] button on the console. A drop-down menu appears, presenting a list of inserts created previously. It is also possible to access this menu by pointing at the Sensoft [INSERT] button and clicking the right button of the trackball. Choose a previously defined insert, by means of the keyboard or trackball and confirm your choice by pressing:

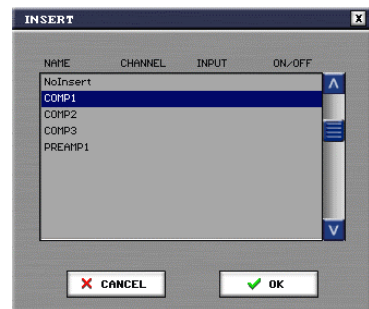

At this stage, the channel is directly linked to the input of the external device but its return will only be active if the [INS] button is lit. To do this, simply press the [INS] button, or point at the Sensoft [INSERT] button and click the right button of the trackball.

The Sensoft [INSERT] button turns yellow to indicate the Insert Return point is active.



The insert point selection list contains the following information for every available insert:

- **Name** : name given to the Insert Send/Return pair, created in the DIRECT I/O window, and generally the name of the device connected to this insert point.
- **Channel** : channel already using this insert point.
- **Input** : physical input of this channel.
- **ON/OFF** : state of the Insert Return.

The line named "No Insert" is used, in the menu, to remove an insert assignment for the channel in question.

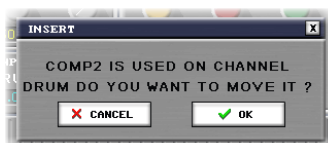

You cannot set up more than one insert per channel, and an insert can only be selected once per page. If, inadvertently, you choose an insert point that is already in use by another input, a message to this effect appears, allowing you to confirm your wish to use this insert for another input, or to cancel the current operation.

Used insert points are visible in the DIRECT I/O grid; the light blue squares allow you to pinpoint those inputs feeding external devices.

The Direct I/O grid

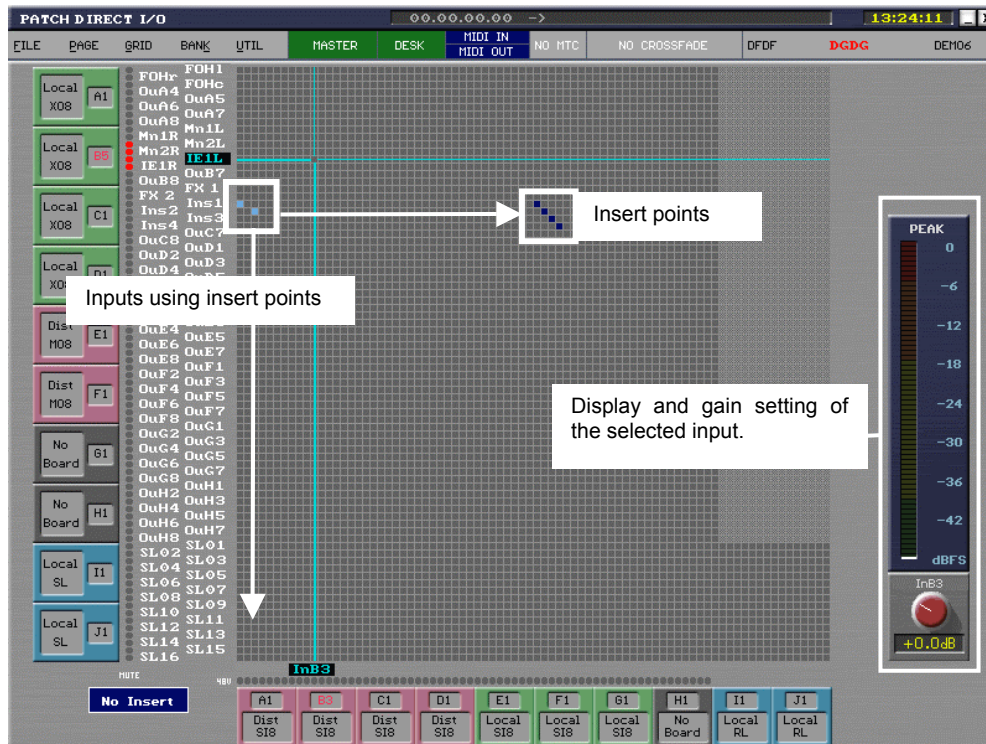

The dark blue squares indicate insert sends and returns. Those in light blue indicate the input channels of the console that use insert points for external processing. For example, on the grid shown above: distant input A1 uses the F1 (In) and C3 (Out) pair as insert points.

#### 4.C.8.3 Location of Insert Send and Return points

The illustration below shows, in the input signal path, where the signal intended for the external device is taken from, and where the signal processed by the same device will be re-injected in the input channel.

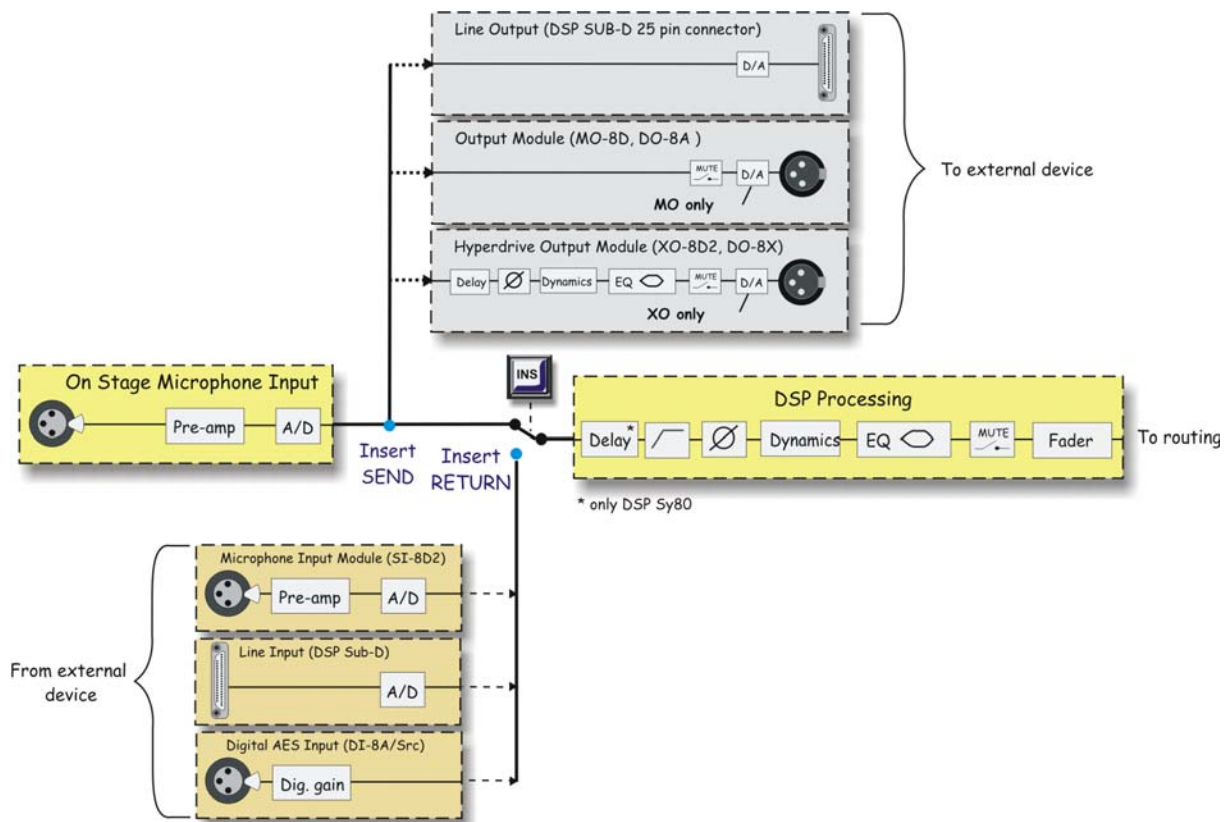

In the current version of Sensoft, it is not possible to change the position of an insert point. However, when used with a Hyperdrive-equipped module, an Insert Send benefits from its own processing. You then have the possibility of applying audio processing to the signal sent to the external device, as well as to the return signal processed by the device.



Even if the **Insert** function is active (indicator lit), the gain setting of the channel is always echoed on the mic input sent to the insert. If you need to modify the gain of the Insert Return (0dB by default), go to the DIRECT I/O grid and position the cursor on the input used for the creation of the Insert Return point. As long as you remain in this grid, adjustment of the gain setting (by rotary control or [F5] and [F6] on the keyboard), and phantom power [F7], are echoed on the input you are pointing to – see paragraph 4.C.8.2.

## 4.C.9 Mute and Cue functions

### 4.C.9.1 The Mute function

For channels patched directly to physical inputs, the **Mute** function acts in the usual way by preventing or enabling the signal present on the input bus to continue its routing path to the mix busses.

On the other hand, when channels are part of a spread set, the **Mute** function acts in the following way:



If all the XFAD **Mutes** are in the same state, the channel **Mute** will act as a remote control on all the XFAD it controls.

The individual **Mute** of each XFAD takes priority over the channel. The Input channel **Mute** acts on the XFAD that are not individually muted.

When the Input channel is muted, you can modify the state of the XFAD to prepare them to be opened when the Input channel is un-muted.

Generally speaking, when a channel is muted by a software command (Channel Input or VCA) and not by its own Mute function, the channel **Mute** button flashes.

#### 4.C.9.2 The Cue function

For channels patched directly to physical inputs, the **Cue** function sends or removes the Input bus signal to/from the Monitor busses.

On the other hand, when channels are a part of a spread set, the **Cue** function acts in the following way:



Selecting the Cue function on an Input channel, allows the XFAD, assuming their **Cue** function is active, to feed the Monitor bus

If nothing has been prepared at the XFAD level, the Input channel **Cue** will remote control the **Cue** of all the XFAD it controls



## 4.D MIX BUSESSES

Following the same procedure you have previously seen concerning the assignment of faders to inputs, we'll now find out how to allocate faders to mix busses. We will then look at the gateway that allows you to link inputs and outputs: *"The Routing"*.

### 4.D.1 DSP Resources : some important points

The mix busses are created in real time by the digital signal processing housed in the Mix Box DSP module. You will have seen on the previous pages of this section (paragraph 4.C.2.3) that when a fader nominated an as Input is patched to a physical input, it uses a DSP resource out of the 80 (or 48) initially available resources. Once this resource has been used, it remains there for all other pages of the current file, to optimize the latency when page changing. It's the same for the DSP resources concerned with the mix busses. You will see that, as with the PATCH IN grid, the PATCH OUT grid contains a DSP resource allocation line.

#### 4.D.1.1 Mix resources

The DSP Sy80 module is programmed to provide 48 mixing resources (DSP Sy40-8 provides 26). These resources give rise to busses, which are distributed to the various outputs channels of the local audio rack (Mix Box).

Mix Box can handle up to 96 audio channels. Each channel represents a stream of digital audio words, with 24-bit resolution and a 48KHz sampling frequency. **64** of these channels are used for the bi-directional exchange of information between Mix Box and Stage Box, via the coaxial cable. **32** channels are reserved for mix busses created by the DSP module. **These 32 channels are only available in Mix Box, because they are not transmitted on the coaxial cable.** Up to **32** resources of DSP mixing can thus feed the outputs of the modules present in Mix Box.

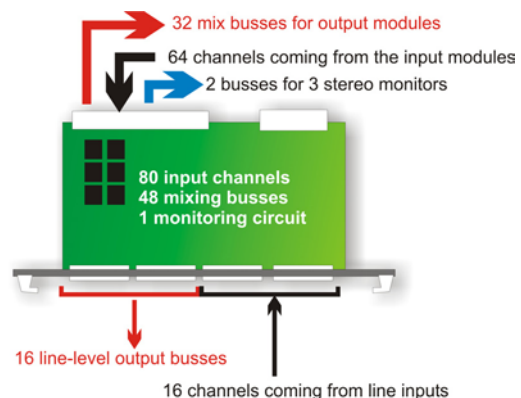

The **16** remaining resources can feed Line Outputs, available on the DSP Sy80 module's SUB-D25 connectors; these resources can be also used in local busses for the creation of Subgroups. These busses patched on line outputs are accessed by the DSP module only and the corresponding signals are not displayed on the screen but only on the console's bar-graphs.

Finally, **2** DSP resources, which in fact makes the total 50 for Sy80 (and 28 for Sy40) are dedicated to the function of stereo monitoring, and cannot therefore be used for anything else.

The schematic below shows the architecture used for the Sy80's DSP programming.

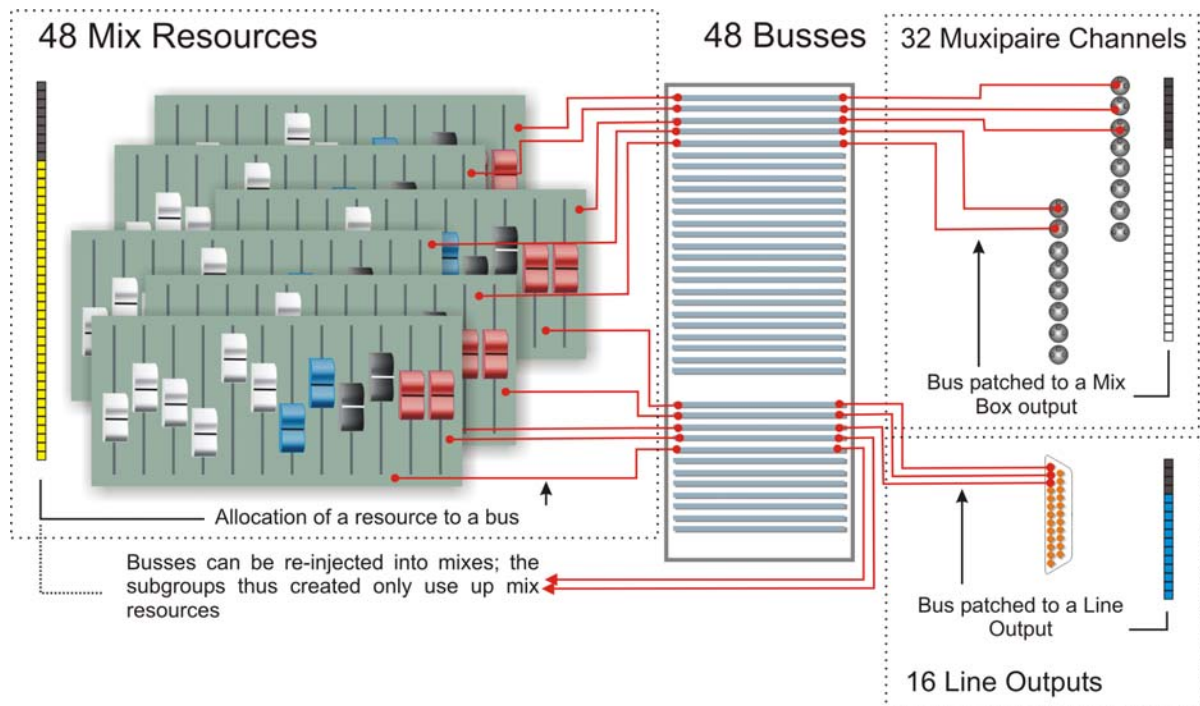

The mix resources are automatically allocated to a channel at the time of the patch. On the other hand, if you cancel a patch, it does not automatically free up the corresponding resource, because Sensoft assumes that this resource will be used in another page of the same file. You'll soon see that, if necessary, you can manually remove this resource in the **PATCH OUT** window, bearing in mind that it will be removed from the other pages of the file. Similarly, you will see how allocating a mix resource to a channel, without patching an output on the same channel, can be used to create a subgroup.



So, Sensoft reveals all: the **PATCH OUT** window, necessary for the allocation of mix resources and physical outputs, is equipped with indicators allowing you constantly to view where and how the DSP resources have been distributed.

#### 4.D.2 Spreading the outputs

Using the same principle as inputs spread to XFAD, the control of busses can be facilitated by spreading them. So, a single fader can control 2 busses – LR, 3 busses – LRC, 4 busses – LRCL (or even, in a future version of Sensoft, 6 busses for 5.1 or 8 busses for 7.1). Furthermore, the function that allows you to assign several physical outputs to each bus, present in all InnovaSON systems, is also in Sensoft 8, and allows the control of a very large number of outputs.

The busses, which can be multi-channel and therefore benefit from spreading, are:

- Masters
- Groups and Subgroups
- Auxes

Schematic showing how to spread busses

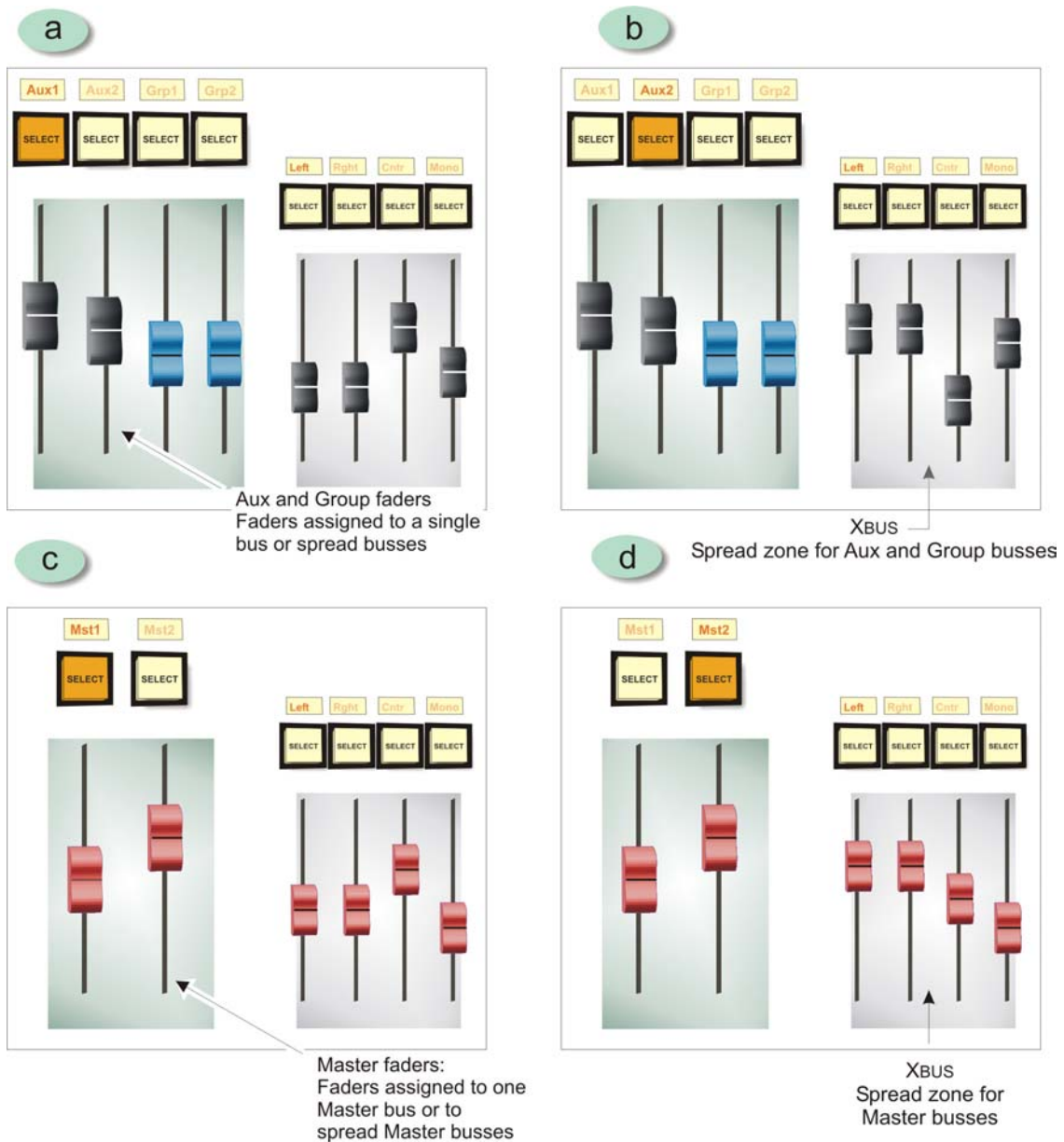

By analogy with the **XFAD** function, let's go a little wild and call the spread busses XBUS(es), even if this term is never employed in Sensoft! It will make the coming explanations easier to understand. Figures a to d (above) show how busses are spread when an Aux, Group (or Subgroup) or Master is selected. Note that the spread zone for Auxes and Groups (and naturally Subgroups) is **common**; also, if several Master faders are used, they will spread their busses in the same zone.

Obviously, it's not compulsory to use and patch all the busses to the spread zone. In fact, if you need to have an LRC Aux send spread, and Subgroups spread only in LR, simply do not patch the C Bus of the Subgroups. In this way, the mix and bus resources are not used up, and remain available for other sends. The fader managing the C bus will simply be unused, and will not carry a label in the spread.

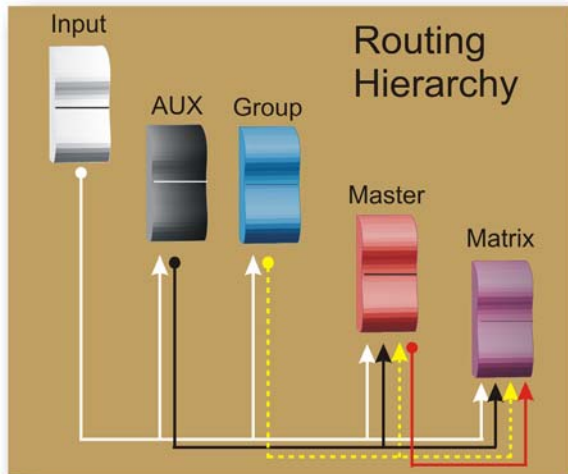

Groups and Auxes have a common spread zone. Indeed, the hierarchy used, as seen in the figure opposite, shows that it is useless to spread an Aux and a Group at the same time, given that neither of them can be routed to each other.

But before seeing how to set up and place these spread zones, let's first see how parameter adjustments on a channel Aux, Group or Master are echoed on channels belonging to the spread zone, in other words, the XBUS.

#### 4.D.2.1 Channel Aux, Group (Subgroup) and Master parameters

The schematic below shows the influence on XBUS channels of parameter adjustment on an Aux channel. Certain parameters act only on the active XBUS channel while others, such as the Pan, act on all XBUS channels associated with the Aux.

**The behavior of Master, Groups and Subgroup busses is identical to that of the Aux shown in this example.**

Influence on Xbus parameters from changes on an Aux channel

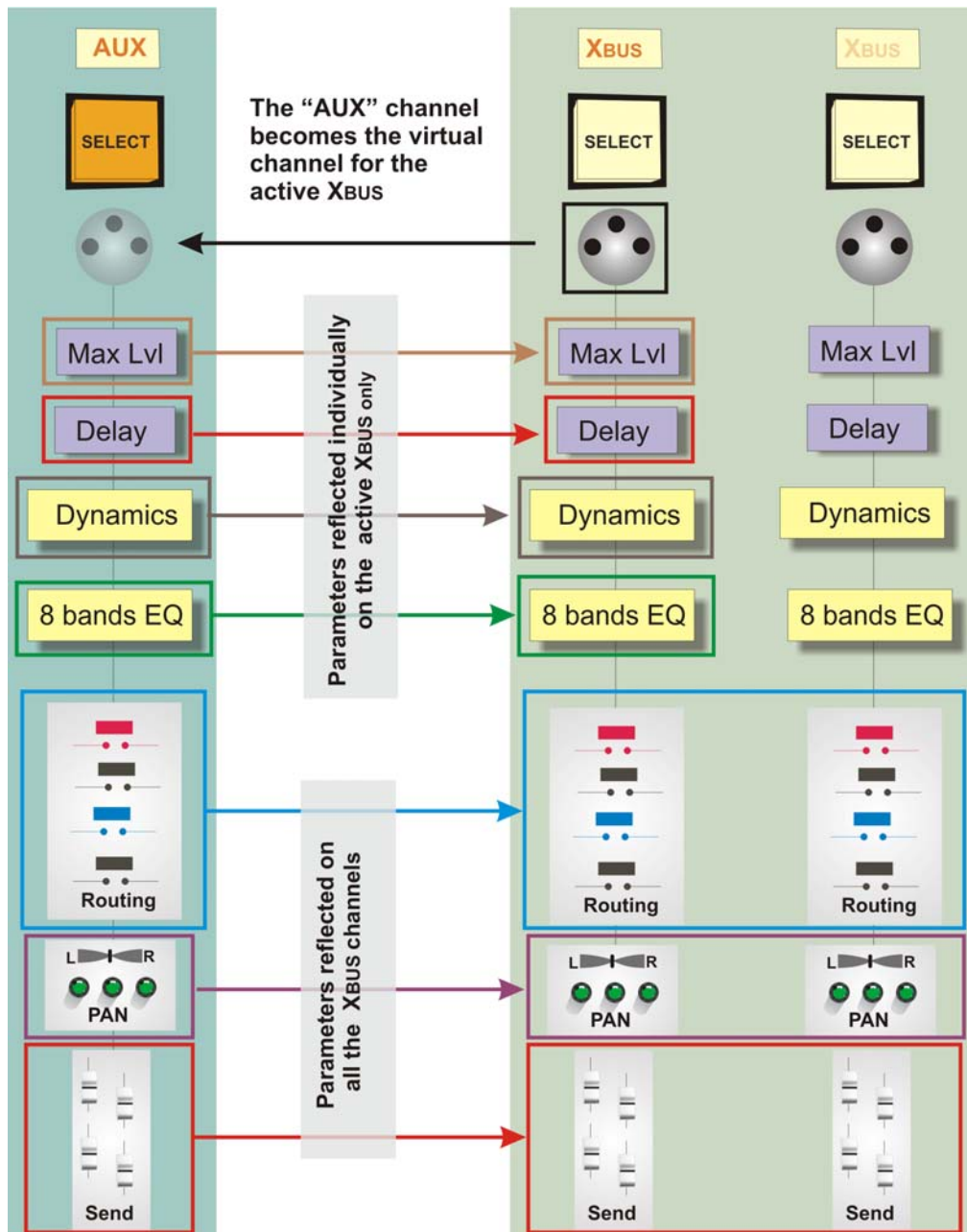

As with spread inputs, each press of the Aux channel [**SELECT**] button changes the Xbus on which the individual parameter changes are reflected.

Parameters such as routing or pan settings, when modified on an Aux channel, have an effect on all the XBUS channels in the spread zone, while the modification of a delay will act only on the active XBUS. Successive presses on the Aux [**SELECT**] button allow you to switch from one XBUS to another.

Throughout the description of functions offered by Sensoft 8, specific information concerning Aux, Group, Subgroup, and Master channel parameters and the spread function, will be clarified in the following paragraphs.

### 4.D.3 Assignment of mix busses to physical outputs (Patch OUT)

#### 4.D.3.1 Description

An internal matrix (the "PATCH OUT" grid) allows mix busses be assigned to "Muxipaire" module physical outputs, such as the XO-8D, MO-8D or DO-8A modules, or to the line-level outputs available on the Sub-D25 connectors of the Sy80 DSP module. The same mix bus can feed one and/or be split across several physical outputs, ie. distribution with variations (the same mix, but with different processing settings, delay, equalization, etc.), feeds to dressing rooms, backup recording, a video control room, radio, etc. Finally, the PATCH OUT grid will allow you to assign mix resources to Groups so they become Subgroups.

Refer to paragraph 4.C.2 to see how to access the PATCH OUT grid.

The PATCH OUT grid.

The screenshot displays the "PATCH OUTPUT" grid interface. The grid is a matrix where rows represent mix busses (labeled OuA1 through SL16) and columns represent physical outputs (labeled OuA1 through SL16). The interface includes a menu bar at the top with options like FILE, PAGE, GRID, BANK, UTIL, MASTER, and DESK. A status bar at the top right shows the time 15:03:09. On the right side, there is a list of outputs with their respective status indicators (e.g., Local X08, Dist M08, No Board, Local SL). Annotations with callouts point to specific areas of the grid:

- "Zone in which faders can be patched to outputs." points to the top-left area of the grid.
- "Patch zone for 3 monitor circuits." points to a yellow highlighted area in the middle of the grid.
- "Distant outputs (Stage Box) do not have access to the mix busses; they are not transmitted via the coax connection (cf 9.C.3)" points to a light blue highlighted area on the right side of the grid.
- "Mix resource (DSP) assignment / de-assignment line." points to a vertical line at the bottom of the grid.

At the bottom of the grid, there is a "MAsR" indicator and a row of small colored squares representing DSP resources. The bottom right corner shows "Free Mix 46", "Free MuxiBuses 30", and "Free LineBuses 16".

All the mix busses appear on the horizontal axis of the grid. They can be identified by the color of their fader, at the bottom of the grid. Refer to Section 1.C for the connection between fader color and function. A small black box on the bottom line indicates the currently selected mix bus, along with relevant information such as “MASR” for **Master Right**.

The vertical axis groups together all the physical outputs. Output #A1 is on the top line of the grid. The outputs are grouped in blocks of 8, corresponding to the physical modules present in the audio racks.

**The outputs are represented on the right-hand side of the grid using the following information:**

The type of module present in the rack for each slot

- Local MO8 : standard analog output module in the local rack (Mix Box)
- Local DO8 : digital output module in the local rack.
- Local XO8 : analog (or digital DO8X) module with processing (Hyperdrive) in the local rack
- Distant MO8 : module (analog or digital) present in the stage rack (Stage Box).



1-Modules equipped with Hyperdrive processing (XO-8D and DO-8X) will not function if they are installed in the distant rack (Stage Box).

2-Digital modules work fine in the distant rack but will be detected by Sensoft as MO-8D analog modules; this does not stop them functioning properly.

Modules are identified by a color code that provides a degree of information:

- Green cells represent outputs available in the local audio rack, Mix Box
- Mauve cells represent outputs available in the stage rack, Stage Box
- Gray cells indicate that no physical output is available. Therefore, although a patch is possible in the grayed out zone of the grid, and will be registered, it cannot be made physically.
- Blue cells represent the Line Outputs available on the SUB-D25 connectors on the front of the Sy80 DSP module.

Remote output modules, although represented on the grid, have no access to the mix busses created by the DSP module; that's why the patch zone opposite them is grayed out.

#### 4.D.3.2 Creating and output patch

##### a) For a fader assigned to a single bus (no spread)

Naturally, as shown in the configuration below, given that we do not wish to spread busses, the **Master** (as in the example), **Aux** and **Group** functions are not allocated to faders.

Fader configuration in the **HARDWARE CONFIGURATION** window

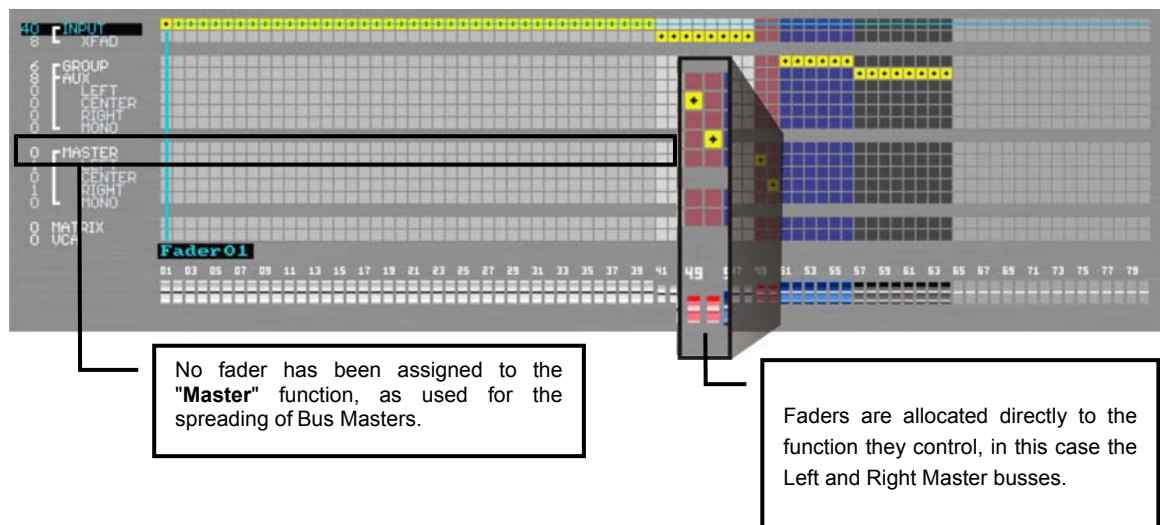

Let's now return to the **PATCH OUT** window to create a patch between faders and physical outputs. This operation comprises moving the cursor across the grid, and validating or invalidating the patch point when the cursor position corresponds to the required fader and to a valid physical output.

The **PATCH OUT** window

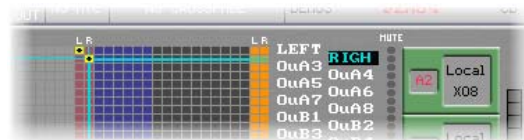

Use the keyboard [SPACE BAR], or the right button of the track ball, to create or remove a patch point. As soon as a patch point is created, any signal present on the bus is sent immediately to the physical output, so be careful when the outputs are connected to PA systems.

Several physical outputs can be patched to the same bus. They will all receive the same signal present on the bus, but the parameters appropriate for each physical output (Mute, Hyperdrive, etc.) remain independent. Several successive presses on the [SELECT] button of the channel, or use of the **MUXI** window (see paragraph 6.1 in the section on Advanced Functions) will allow you to access the required output and adjust its Hyperdrive parameters (Level, EQ, Delay).

##### b) For a fader assigned to the control of several XBUS channels

This type of patch is obviously only possible if, in the **HARDWARE CONFIGURATION** window, an XBUS control fader has been created. This is as shown in the illustration below, by taking a spread Master as the example.



Faders configuration in the HARDWARE CONFIGURATION window

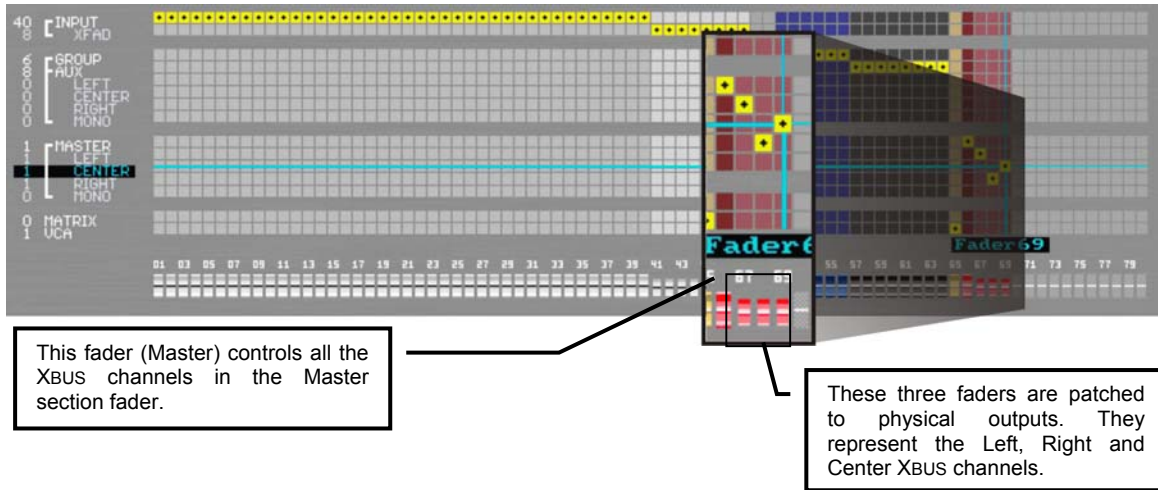

The figures below show the sequence of events required to make an output patch:

- a Press the [SELECT] button of the Master to place the cursor in the corresponding column
- b Then press the [SELECT] button of the corresponding XBUS channels to patch the physical outputs

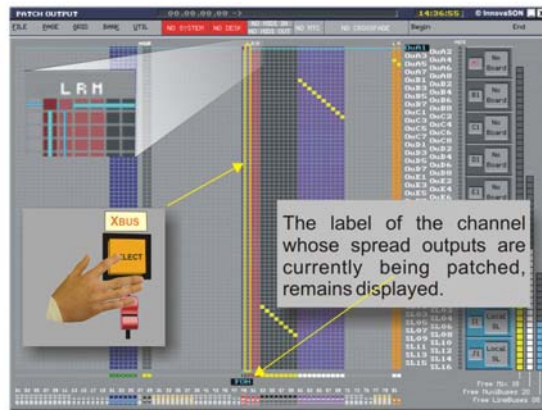
- c As you make the patches, the resource indicators update.
- d The window offers a global view of the resources available, the outputs used, and the allocation of busses.

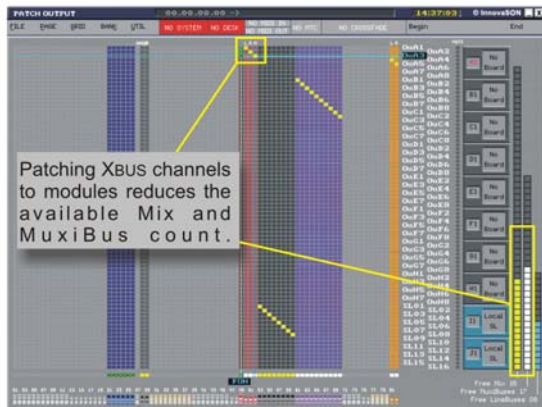

During the creation of a patch point, another point, able to take on several colors or purposes, appears on the line at the bottom of the grid, just above the fader that you have just patched. This point indicates that one or several resources have just been assigned to this channel. Note that, if you cancel your previous patch point, it does not have the effect of canceling the resource assigned to the fader. This is explained by the fact that, once assigned, a resource remains available to all the pages making up the current file. It's possible that, from one page to another, the nominated fader "Aux Left" is, or is not, patched to an output. But, if at least, a single page requires that it is patched, then, to optimize latency and DSP management, the resource is assigned on all the pages. Furthermore, it is possible to allocate a resource to a Group on the same line, to make a Subgroup.

The figure below explains the meaning of the patch point and resource allocation point symbols and colors:

**✕** this symbol indicates that the fader is controlling a set of XBUS, three in this case.

**●** this symbol indicates that these XBUS are patched to outputs, A1 to A3 in this example.

The resource allocation line

**□** these three white squares indicate that each XBUS is using one Mix resource, necessary for the creation of the Bus, and one Muxipaire resource for the patch to the card in slot A.

**●** these four squares indicate that Mix resources have been allocated to these Groups in order to use them as Subgroups. No outputs are patched to these busses because they are using an internal bus.

**■** when a square is blue it indicates that the bus or XBUS uses a Mix resource and a Line resource, because the patch has been made to a Line Output (SUB-D25 on the DSP card).

To quit the PATCH OUT window, press the [PATCH OUT] button again, press the keyboard [Esc] key, or click with the mouse on the "close" icon at the top right of the window .

**4.D.3.3 Modifying output labels**



The labels of the physical outputs take on, by default, an name corresponding to the type of module (Ou), the slot of the module (A) and the number of the output (1), in this case “OuA1”. These labels can be personalized, within the limits of the four characters available.



As with the naming of input preamps, output labels can be modified as follows:

- Press the [F3] key to name the selected output (in the main Mix window) or the output pointed to (in the Patch OUT window), and only this output.
- Press the [ALT] + [F3] keys to name the selected output, or pointed to output, passing automatically to the following output after every confirmation (quick-fire modification).

Label modification of channels associated with the control of XBUS can only be made from the main Mix window.

**4.D.4 Basic Principles of Routing**

All the input channels can be individually routed to any or all of the Master, Group, Aux and Matrix mix busses.

**4.D.4.1 Routing to Busses**

The routing of an input to a bus is sufficient to send this input to all the busses in a spread group; so it is not possible, for example, to route a microphone only to the left bus of a Stereo Aux. On the other hand, a microphone can be panned completely to the left in a group of busses, or panned left only on the Aux in question, when the input has been set up to have an independent pan on this Aux.

The diagram below shows the steps required to route an input to, for example, the Master busses:

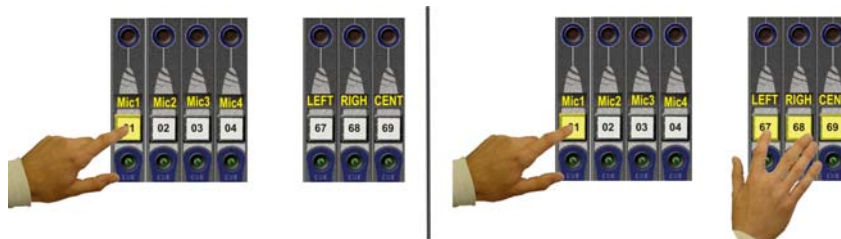

Press and hold the [SELECT] button on the input you wish to route.

Press on one of the [SELECT] buttons of the Master busses, or on the Master channel controlling the XBUS.

Note that, as soon as you make the route, the [SELECT] buttons of all the Master busses light up, to indicate that the input is routed to all the busses of the Master.

The following diagram indicates how to **quickly route** a range of inputs to, for example, Master busses:



Press and hold the **[SELECT]** button of one of the Master busses (or on the Master channel controlling XBUS channels).

Press and hold the **[SELECT]** button of the first input in the range.

Release **[SELECT]** on the Master and press the **[SELECT]** button on the last input in the range.

The function is completely reciprocal, and everything depends on the first channel you select (and hold). So, you can either select an Aux to route several inputs to or, vice versa, select an input to route to a number of Auxes or to other busses.

These methods of routing are the same for all of the busses, whether they are spread or not. When a channel is selected, all the busses to which this channel is routed have their **[SELECT]** buttons illuminated. Similarly, when a bus is selected, all the inputs or the other busses that are routed to it have their **[SELECT]** buttons illuminated. On the Sensoft screen, a yellow indicator on the routing line above the faders indicates that inputs or busses have been routed to the selected bus. When an input is selected, the yellow indicator shows the busses to which this input is routed.

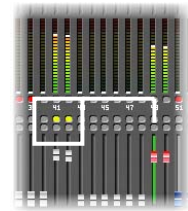

#### 4.D.4.2 Routing of busses to busses

The **Routing Hierarchy** drawing, seen in paragraph 4.D.2, shows that busses can be routed to other busses. It is the case that Auxes and Groups can be routed to Masters, and Masters, above all other resources of the console (even inputs), can be routed to Matrixes.

The way to route busses is exactly the same as that used to route inputs. Select and hold the channel to route, press the **[SELECT]** button of the channel you are routing to. The method used to route several channels quickly, described above for the routing of inputs, is also valid for the routing of busses.

When you route one XBUS of a multi-channel bus, all the XBUS channels are routed to the destination bus. If the same bus is also multi-channel, busses are routed one to the other, with respect to the function of each bus.

The drawing below explains all:

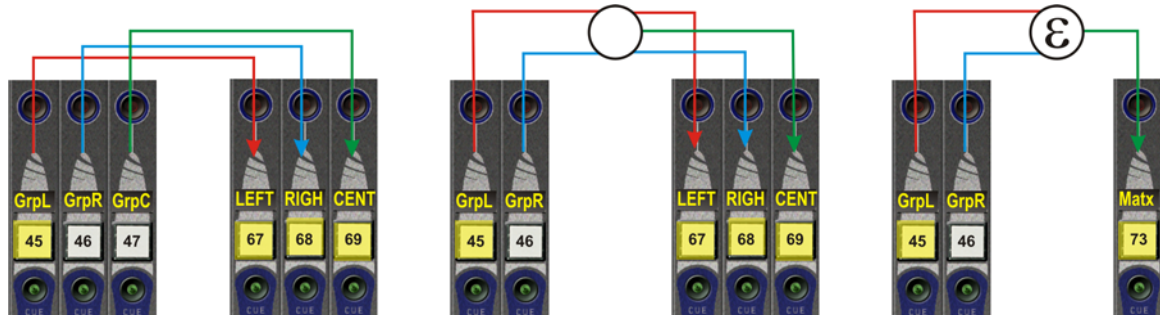

Busses are routed to one another according to their coherent pan settings. Each bus or XBus has its own pan for possible adjustment of the balance.



When stereo busses are created, in view of their eventual routing, the pans are preset according to the function of the busses. **The internal busses of the console are not processed**, output processing is available when you patch to a Hyperdrive output.

#### 4.D.4.3 Bus send levels

Unlike Masters and Groups, Auxes and Matrixes are equipped with a supplementary level control – the send level – which allows them to have a totally independent mix. These level controls are more commonly known as Aux Sends and Mat Sends.

The console faders can therefore be in one of two modes:

1. Controlling the level of a bus, or the general level of an input
2. Controlling the send level of Auxes or Matrixes.

The fader mode depends on the selected channel. The selection of an Aux transforms the Input faders into Aux Sends, the selection of an Input transforms the Aux faders into Aux Sends, etc...

The table below allows you to track down the fader mode of each channel according to the function of the channel selected.

Fader function Selected channel	Input	Group	Aux	Master	Matrix
Input	General level	General level	Aux Send	General level	General level
Group	General level	General level	General level	General level	General level
Aux	Aux Send	General level	General level	General level	General level
Master	General level	General level	General level	General level	General level
Matrix	Mat Send*	Mat Send*	Mat Send*	Mat Send*	General level

\* The last line of the table shows that, as soon as a Matrix is selected, all the console resources become Mat Sends. In addition, as you will see later, Matrixes have a specific way of working.

#### Channels controlling XBUS and XFAD :

- When an input is selected, the Aux channel fader (XBUS control fader) becomes an Aux Send for all the Aux busses. The XBUS faders continue provide general level control for each of the busses.
- When an Aux is selected, the channel Input fader (XFAD control fader) becomes a “VCA” for the Aux Sends of all the XFAD which, in turn, have become individual Aux Sends for each of the inputs that they control.

**Not clear? Let’s try an example:** The Aux is feeding a reverb. Rev1 is selected, while four Xfad channels of a choir are spread and routed to this Aux. Each of the individual XFAD channels now represents the send to Rev1 of the choir channel that it manages, while the channel Input “Chrs” (Choirs) controls the overall level of all the XFAD Aux Sends, effectively acting as a VCA. It is therefore possible to adjust the overall level of choir channels feeding Rev1, without destroying their individual Aux Send balance, by adjusting the “Chrs” fader.

This example is illustrated in the following diagram:

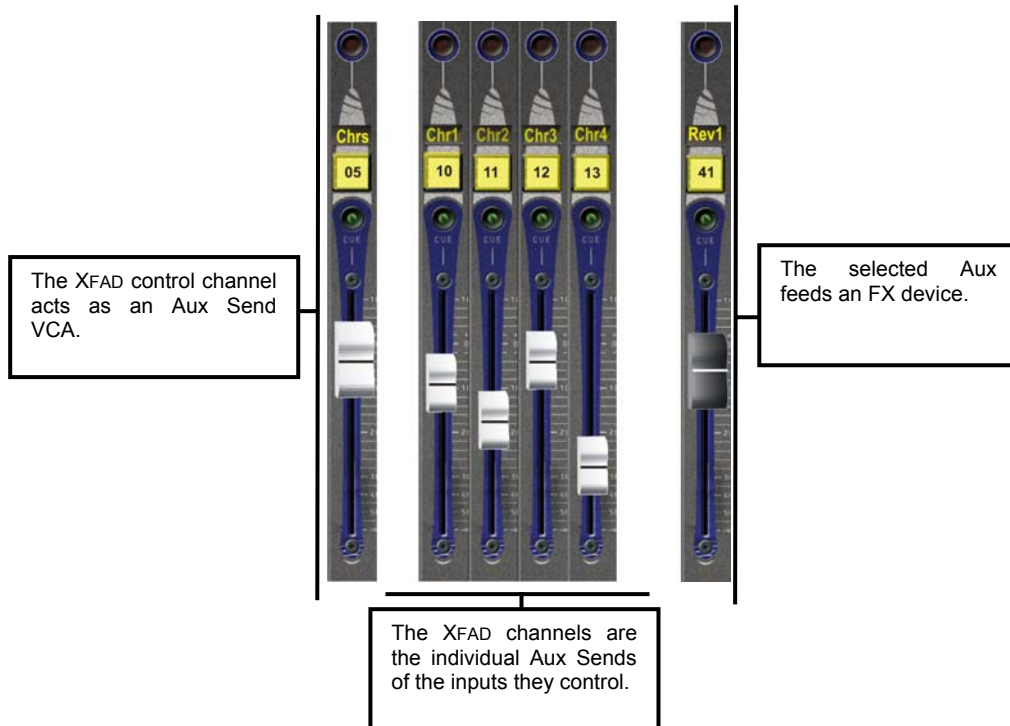

### 4.D.5 Definition of “pre/post fader” and Pan settings on busses

#### 4.D.5.1 Definitions

The function “pre/post fader” takes into account the level of input channel signals fed to the Master busses. Only Auxes and Matrixes can be designated “pre/post fader”. Every input channel can be individually set up to provide a “pre/post fader” feed for each individual Aux send. The pre/post condition is individual for each input and for each Aux; it is global for Matrixes, as you will see later.

The function “independent pan” relates to the possibility for an input to have a stereo position in the Aux or Group busses which is not the same, nor dependent on, its panned position on the Master busses.

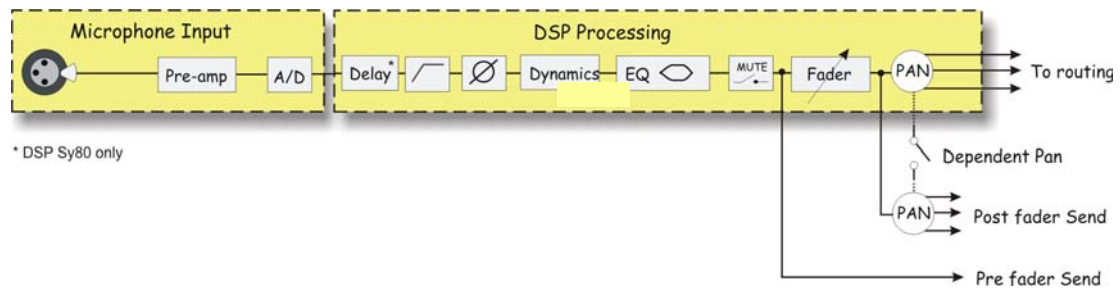

### Pre/Post points and the Independent Pan function

By default, all the input channels are selected to “post fader” and “dependent pan” mode for all the Aux and Group busses. What this means is :

- Any assignment of an input channel to an Aux bus sends this channel to the bus with a identical level to that of the channel fader to Master busses.
- Any modification of input channel level to Master busses thus has an influence on the send levels to Aux busses to which the channels are routed.
- Any modification of the panning of input channels to Master busses is echoed on the Aux busses and stereo Groups.



The notion of Pre/Post really only concerns Auxes, given that Groups have no need for particular send levels; they receive inputs at the Master level (equivalent to Post-Fader).

#### 4.D.5.2 The PRE/POST CONFIGURATION window

The illustration below represents the CONFIGURATION window for Aux Sends and Pans. Depending on whether you access this window when an Aux (or Group) is selected, or when an Input is selected, you will not get the same display of information.



Configuration window for Aux Send and dependent Pan

In this window, inputs can be **Routed**, set up **Pre** or **Post** fader, and declared **Independent** or **Dependent** with regard to the Pan feeding the Master busses. To configure several channels quickly at the same time, there is a useful sequence. This is shown in the drawing below, taking the “Independent Pan” parameter as an example :



One press on the first letter of a parameter turns its name green. In this example, one press on the letter “I” has selected the “INDEPENDENT” parameter.

Press and hold the [SELECT] button of the Aux (or Group) on which you want to adjust the parameter.

Now you can toggle the relevant parameter by pressing successively on an input’s [SELECT] button, or select a “block” as in routing.

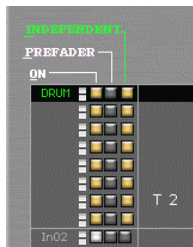

The state of the input **[SELECT]** buttons (lit or not) indicates if the chosen parameter (in green on the screen) is ON or OFF. It is also possible to adjust parameters simply by pointing at the corresponding small square, opposite the input, and clicking to turn the function on or off.

The Aux Send and Pan configuration window has a slightly different display if activated it while an input is selected :

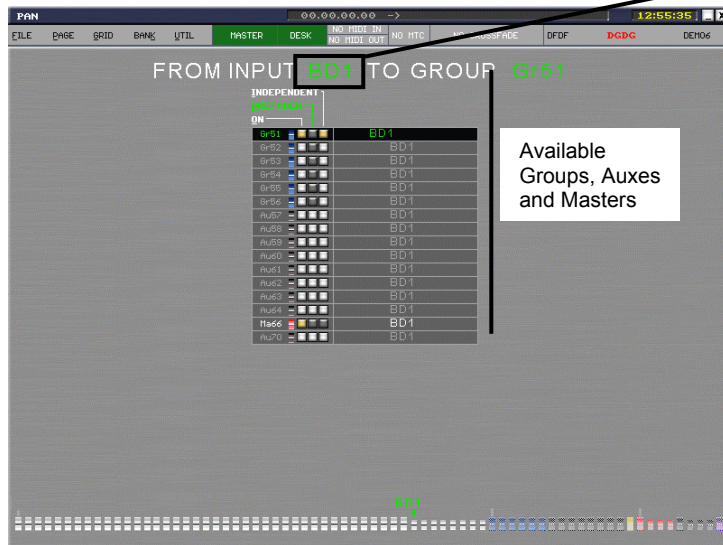

Input **BD1** was selected at the time the window was activated. This window shows the configuration of **BD1** in relation to all the Groups, Auxes and Masters. Simply use the **[SELECT]** button on inputs and outputs to change the item to be edited.

#### 4.D.5.3 Pan settings - general function

By default, every time an XFAD or an Input channel is selected, its Pan setting acts on the Master busses. If the same input is sent to a stereo Aux bus, and set to “dependent” mode, the Pan setting with regard to this Aux will be identical to that made on the Master busses. If you select the “Independent” parameter to “ON”, the input can have a different Pan position from that made on the Master busses. The rotary control used for the Pan positioning is the same for all the busses, so it is therefore possible to change the setting of this control to modify the Pan position for an input to modify an Aux, or a Group, and then return to setting the position for Master busses, etc....



The rotary Pan control

#### Rapid Pan setting for various busses :



The Pan control represented in the Sensoft window (see left) displays the label of the XBUS control channel on which the Pan is being adjusted. This allows you to know exactly which bus, and even the device, for which you are positioning an input. If, for example, an XBUS Aux control channel is feeding the L, R inputs of a reverberation device called REV1, when you adjust the Pan of an input to the reverb, the name REV1 is displayed over the rotary control (on the Sensoft screen, of course).

The figure below shows the sequence allowing you to quickly change Pan control assignments:



Press and hold the **[SELECT]** button on the Input channel you want to adjust.

Press the **[CUE]** button for the bus on which you want to adjust the Pan. The name of the bus appears on-screen, above the rotary control.

Repeat the operation for each bus on which you wish to adjust the Pan. This function is invaluable for stage monitoring...

This short-cut works reciprocally also from a bus SELECT to a channel CUE.

*The 'general preferences' window has 3 options to configure panning in the buses :*

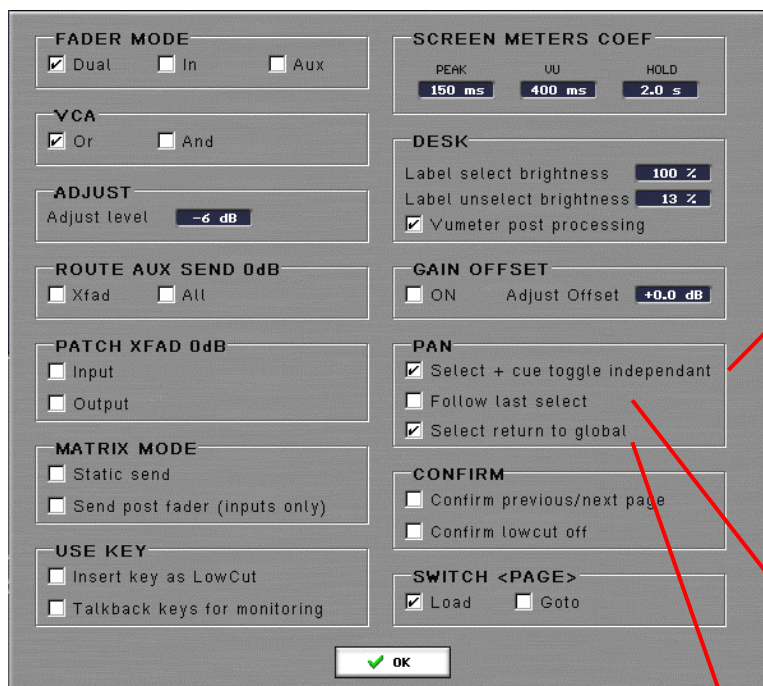

This option enables the short-cut toggle action. When a **[SELECT]** is held, the **[CUE]** action on a bus displays the corresponding Pan mode and value and gives access to it. Another touch on the **[CUE]** toggles the pan mode, and so on. The labels and pan window colors displays the status :

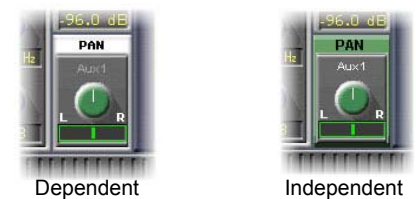

This function locks the PAN adjustment on the last selected bus. Changing channels with SELECT is possible and panning is active for the current bus.

Selecting another bus or a master unlocks this panning mode.

With this function, touching any channel's **[SELECT]** will place the PAN on its global adjustment (equivalent on master buses). Very useful when a temporary PAN is required for a particular bus but with a quick access back to the global pan.

**4.D.5.4 Precise Pan settings for an Aux, Group or Master :**

The Aux Send and Pan configuration window, which we looked at earlier, is a very interesting tool to use, and has a precise display of the stereo position of inputs in relation to the various mix busses. The window allows you to not only configure the Aux Send “independence” and routing parameters, but also allows the positioning of each source on Aux, Group and Master busses.

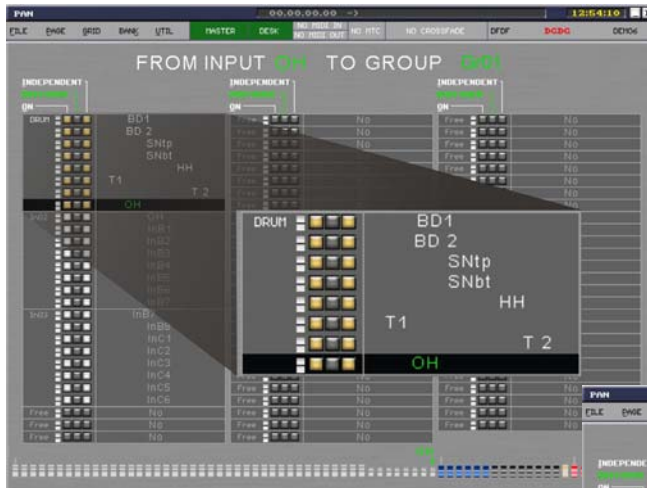

In the window opposite, you can see that every XFAD in the “DRUM” channel has its Pan set to “independent” with regard to the Master bus. The stereo position of sources that you are looking at concerns the Group named “Gr01”. When you [SELECT] an input, the Pan control will act on Gr01 if it is “independent”, and on all the busses if it is “dependent”.

If you select the Master bus, you will now see in the window opposite that the positions of the elements in the “DRUM” channel differ to those for Gr01. Note that input labels are used to show the position of instruments in the stereo spread.



#### 4.D.5.5 XFAD and XBUS: a non-destructive composite Pan

This somewhat severe title simply describes the behavior of a Pan when acting on a channel Input that is assigned to an XFAD, or on an Aux or Group assigned to several XBUS channels. For these channels, the Pan acts on the complete XFAD or XBUS, without destroying any individual balance that has been made.

The diagram below shows the stereo space occupied by all the XFAD channels under its control, indicated by a yellow rectangle in the input channel PAN window. If you modify the Pan setting for one of the XFAD elements, the result is directly echoed by this yellow rectangle.

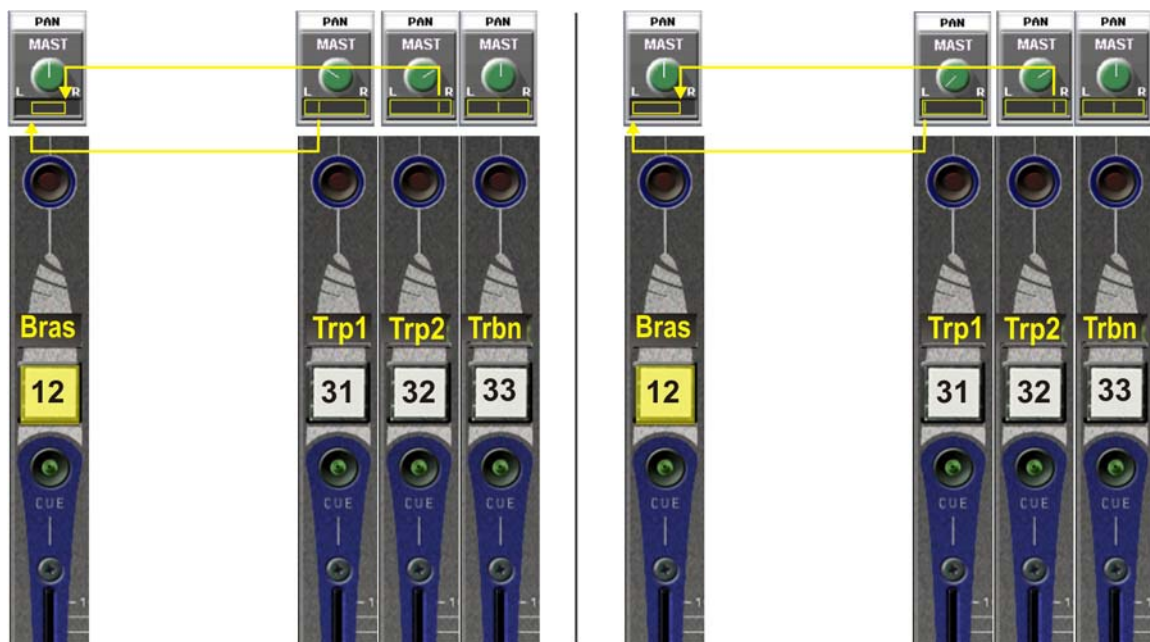

When you adjust the Input channel Pan, in this example the “Bras” channel, you activate a non-destructive, composite setting whose initial state is the center position. At extreme positions of the Pan, any initial stereo image will be destroyed (see right) because every XFAD will be sent fully to the left or right. With the Pan in the center, the original image is completely restored, and corresponds to the individual Pan setting made on each XFAD. This composite Pan is applicable to **Aux**, **Group** and **Subgroup** channels; the global action that the Pan has on associated XBUS channels is composite and non-destructive.

Finally, the behavior of a Subgroup Pan on all the inputs routed to its busses will be the same, that is, it will modify the position of inputs feeding the Master busses in a composite and non-destructive manner. The example below shows the influence of a Subgroup Pan on all the signals routed to it.



**The composite pan (general for XFAD and XBUS) is always independent. Even if each XFAD/BUS has a common adjustment for all the mix buses (dependent), the action on the channel’s composite pan will be individual for each mix bus.**



Individual Subgroup Pans

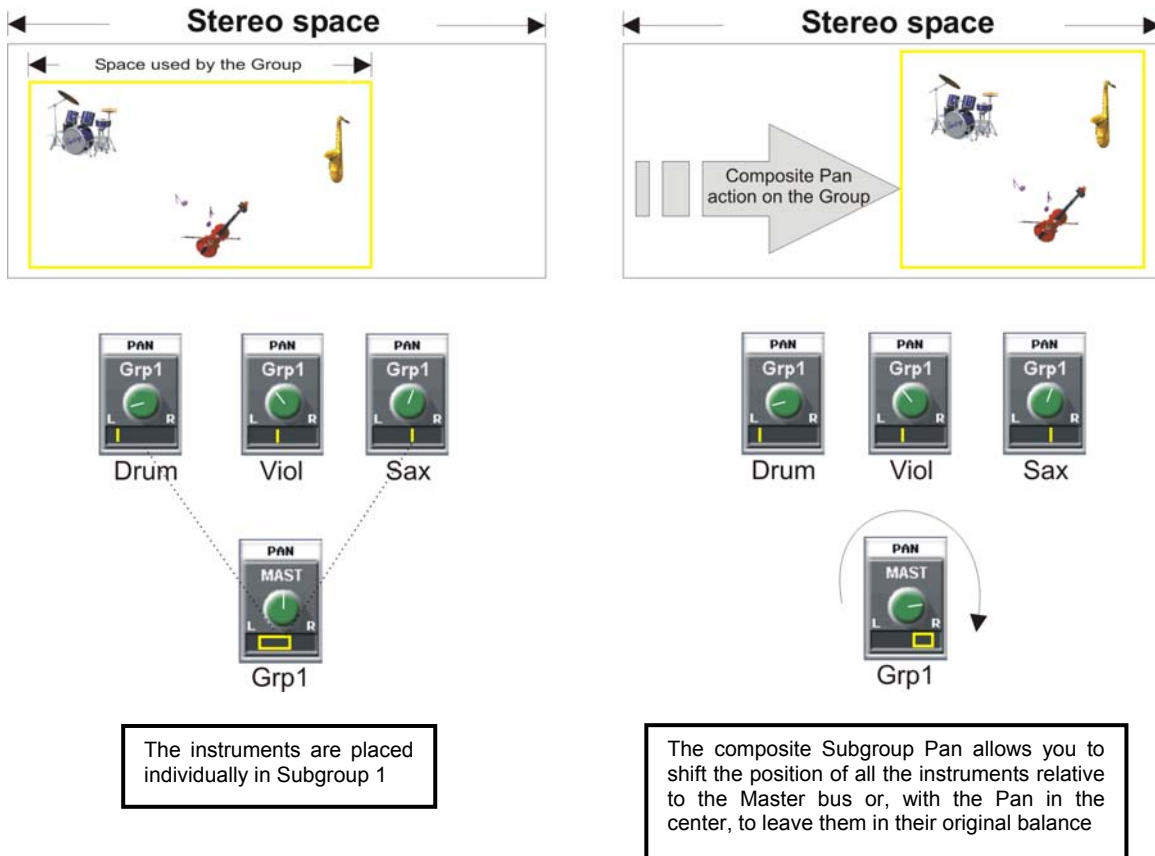

**4.D.6 A special bus: the Matrix**

Sensoft's Matrixes allow you to create busses to which all the console's channels can be routed and mixed. The Matrix busses are mono and have their own routing and send level control. They are the only busses that you can send Master busses to, that is why there are two function modes for the level control of a Matrix Send.

**4.D.6.1 Eligible channels**

In addition to the traditional channels such as Auxes and Masters, Sensoft 8 allows you to route any channel to the Matrix busses, **even the input channels**. Thus it's possible to create busses to which you remix every single resource on the console!

The following diagrams show the point where, on input channels and various busses, the signal sent to a Matrix bus is taken from. Note that inputs can feed a Matrix pre or post fader (generally speaking).

**Input channel send to a Matrix bus**

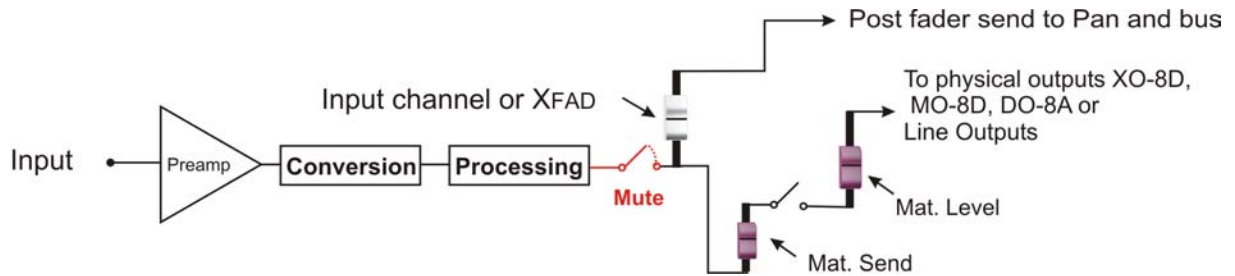

A Matrix bus is not processed itself, but can feed one or several processed outputs, when patched to XO-8D or DO-8X output modules.

**Sending a Bus to a Matrix**

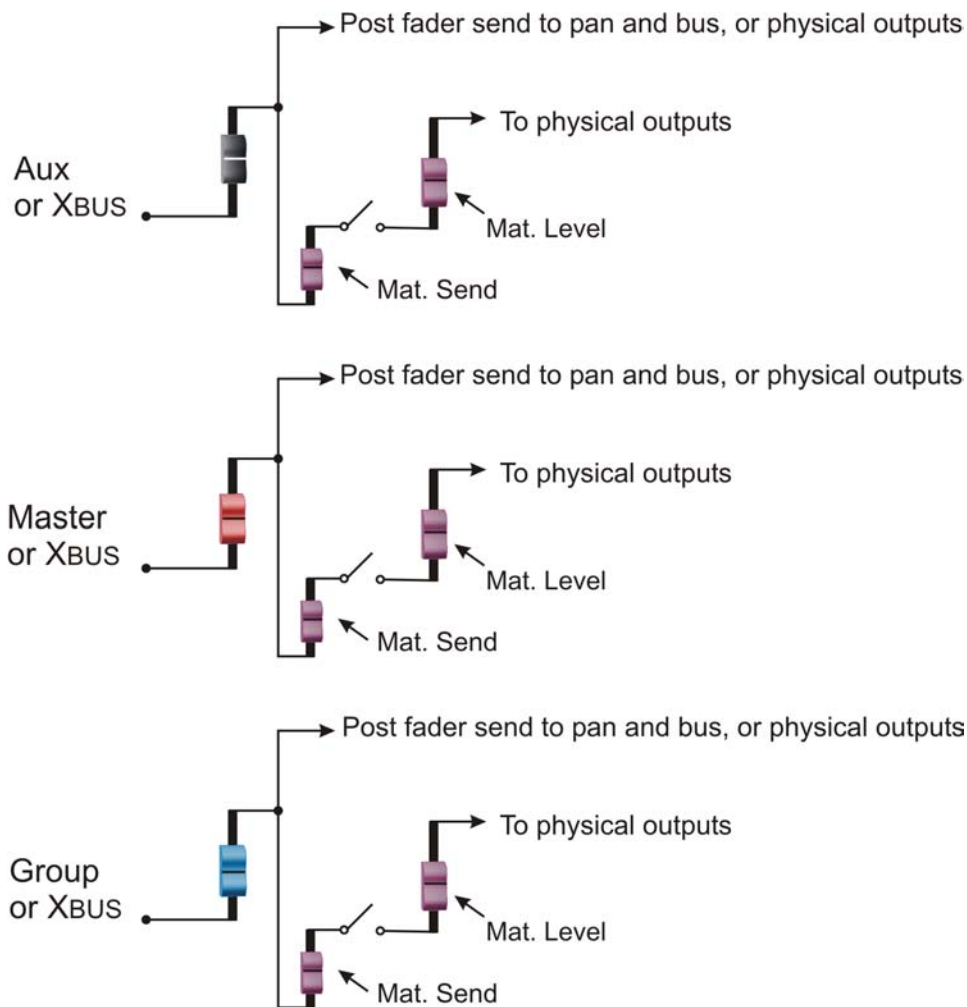



#### 4.D.6.2 Matrix Send function modes

As mentioned earlier, there are two function modes for Matrix Sends.

The first function, known as “**Active Select**”, is characterized by the following behavior :

- The channel send level to the Matrix is only visible and adjustable while the [SELECT] button of the Matrix in question is pressed and held down.
- When the Matrix [SELECT] button is released, all the channels return to their place in the console’s master mix.

The second function, known as “**Static**”, behaves as follows:

- Selecting (press and release) the [SELECT] button of a Matrix positions, and retains in position, according to their routing and send levels, all the channels feeding this Matrix.
- Select another bus or Input channel to make the console reposition all its faders to their normal mix levels, and no longer display the send levels to the Matrix (similar to Aux Send behavior).



**Attention :** The matrix static mode modifies importantly the faders working modes described in section 4.D.11. In fact, a matrix fader selection will place all the faders, inputs and busses, in their respective Mat-Send positions. The input and bus faders won’t be accessible until a new selection will place them again in the current mode. See 4.D.11.

The choice of Matrix Send function mode is made in Sensoft’s *General Preferences* menu (see right). Choose Static mode by checking the “**Static matrix**” box, or Active Select when this box is not checked. Another check box allows you to choose whether Input signals are taken pre or post fader before they feed the Matrix Send level adjustment.

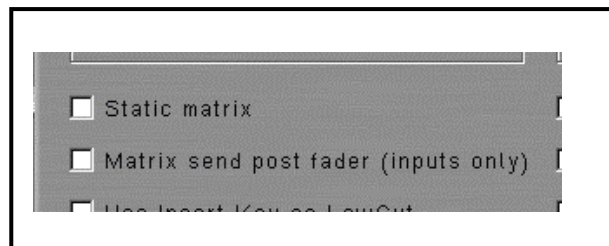

#### 4.D.7 The Monitor bus

The consoles’ monitor bus is stereo; it can be distributed to three separate circuits, so up to three pairs of monitor outputs, Muxipaire or Line Output, can be used.

The benefit of having three circuits is that you can distribute the monitor bus to various destinations, according to the type of signal you want to monitor. Sensoft 8 goes even further because, as you'll see, it's possible to have automatic selection of the monitor output, according to the channel sent to the monitor bus. Patching for the three monitor circuits is made in the PATCH OUT grid, the choice of circuit in use is made on the console, and you'll see that there are also some configurable options in the Sensoft *UTIL* menu.

**4.D.7.1 Monitor circuit selection, level and patching**

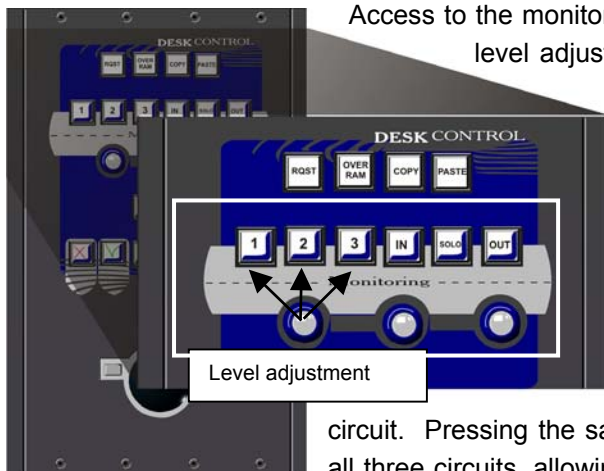

Access to the monitor circuits, selection of the listening point, as well as level adjustment for each circuit, are made from the console.

On the DESK CONTROL panel, the Sy80 "Monitoring" section contains 6 switches and 3 rotary controls. This function is shared by the Talk-Back section on Sy40 and Sensory Live consoles, see General Preferences in 6.Q.

The buttons engraved "1", "2" and "3" allow you to choose one of the three circuits; the selected button remains switched on to indicate the active

circuit. Pressing the same button again will deactivate all three circuits, allowing you to turn off the monitoring completely. When a circuit is active, the left-hand rotary control allows you to set the output level of this circuit, each circuit having its own separate adjustable level. When you change circuit, the level set for the previous circuit is remembered, to be recalled when that circuit is next selected. Orange faders at the end of the console, on the Sensoft screen display, represent the level of the current circuit.

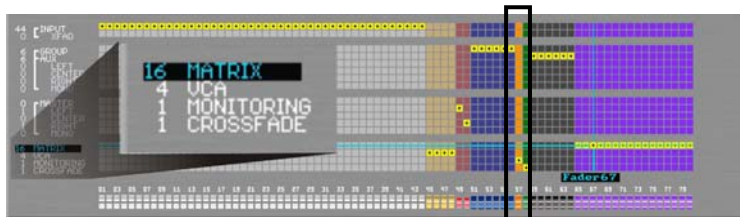
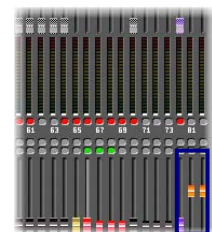

Level adjustment for the active circuit can be made with the help of a console fader. All you have to do is nominate one of the faders to monitor control in the HARDWARE CONFIGURATION window (see left).

Once this fader exists, it will permanently control the level of the active monitor circuit, and both orange-colored faders on the Sensoft screen slave to it. When this fader is selected, it's also possible to adjust the Hyperdrive parameters of the outputs to which the current circuit is patched. Each press on the [SELECT] button of the monitor fader allows you to toggle between the left and right outputs of the circuit. The rotary control on the control surface, which had been used for monitor level settings before the creation of this fader is, from now on, assigned to control of the active headphone circuit.

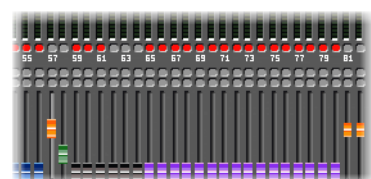

On the Sy80, two level meters to the right-hand side of the power supply status panel (above the DESK CONTROL panel), show the signal present on the Left and Right monitor busses. . These level meters are pre fader, in other words, they will not show the level of the active monitor circuit, they permanently indicate the level of the monitor busses.

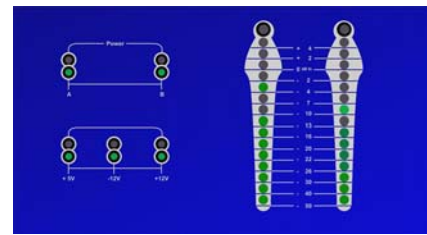

They are located on the right of a Sensory Live console. The Sy40 doesn't have such vu-meters but only the screen ones (AFL).

In the PATCH OUT grid, the last two orange-colored columns are reserved for patching the three monitor circuits. They represent the patch column of the Left monitor bus and the patch column of the Right monitor bus. It is imperative that the relevant monitor circuit is active (the appropriate button on the console must be switched on) before attempting to patch it. The diagrams below explain the steps necessary to patch three circuits to three pairs of physical outputs :

**The PATCH OUT window : patching Monitor circuits**

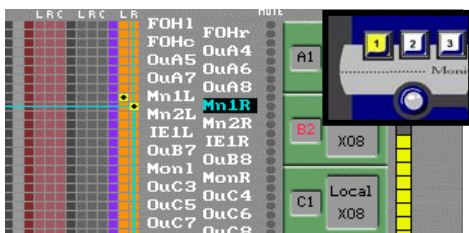

When circuit No. 1 is active on the console, patch the two outputs chosen for this Monitor circuit.

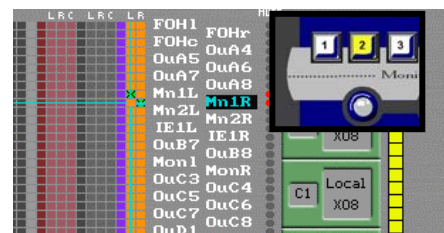

Patch the two chosen outputs for circuit No. 2. The outputs can be Muxipaire or Line Outputs.

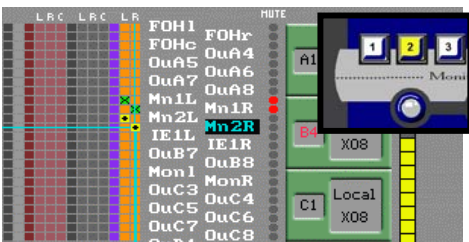

On the console, activate circuit No. 2. This automatically mutes the outputs assigned to circuit No 1.

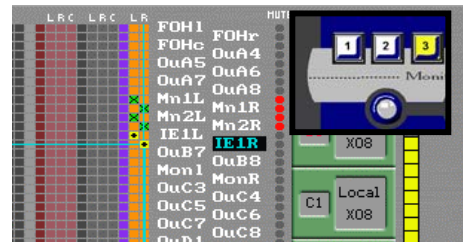

Activate circuit No. 3, this mutes the others, and patch the two outputs chosen for this circuit.

Two mix resources (out of an initial 50 / 28) are permanently allocated to the Left and Right monitor busses. To these resources, you'll add two Muxipaire resources (MuxiBuses) if you patch at least one circuit to a pair of Muxipaire outputs, and two Line resources (LineBuses) if you patch at least one circuit to a pair of Line Outputs. Note that, even if three circuits are patched to Muxipaire outputs, only two MuxiBus resources are used. This is because only one circuit can be active at the same time, the others being automatically muted, so a single stereo bus is sufficient to feed the Muxipaire outputs.

The schematic below explains the path taken by signals sent to the Monitor busses.

**Monitoring : signal flow**

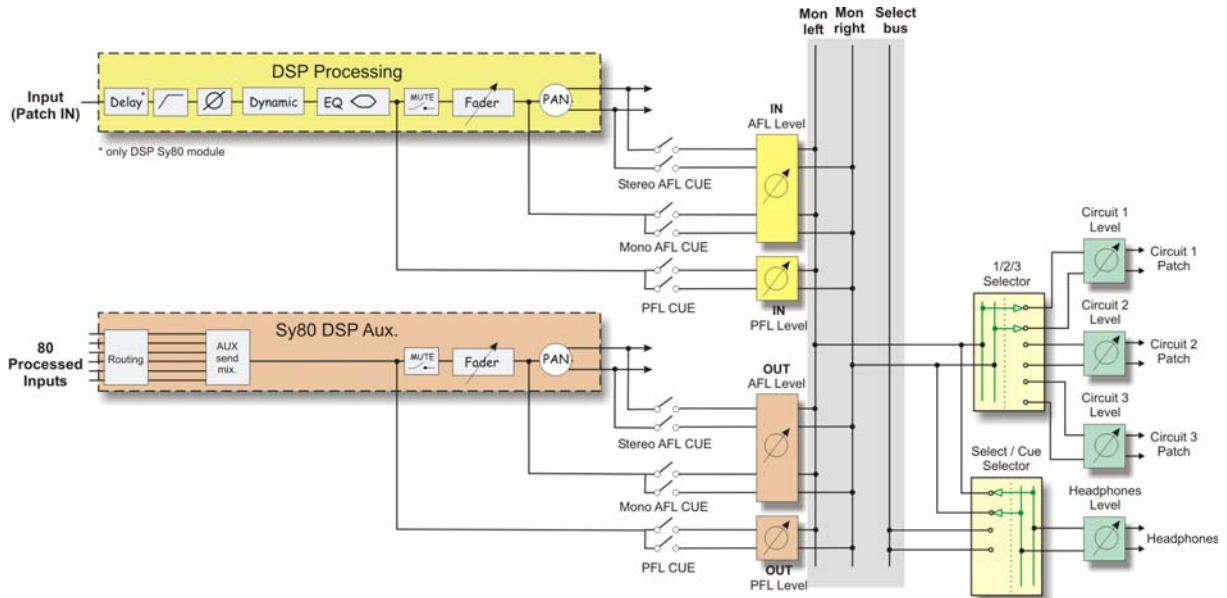

This signal flow diagram demonstrates the various listen level controls offered by the Monitoring section of an Sy80. The traditional “dimmer” is replaced here by the possibility of adjusting the level of AFL inputs, PFL inputs, AFL busses and PFL busses. According to the chosen listen mode (AFL or PFL), the “IN” and “OUT” levels are automatically remembered, and recalled when there is a change of mode. So, in “PFL Input” mode, the “IN” level will be adjusted, while another level can be set up, using the same rotary control, for “AFL Input” mode. Switching between “PFL Input” mode and “AFL Input” automatically recalls the preset levels. The circuit selector provides a choice of three available circuits. Each circuit has its own level control, allowing it to match the output signal to the speakers connected to that circuit.

The various controls, as shown on the illustration below, are available on the Sy80’s DESK CONTROL panel. These controls are separated in two sections on Sy40 and Sensory Live, see section 2.C.7

**Monitor controls**

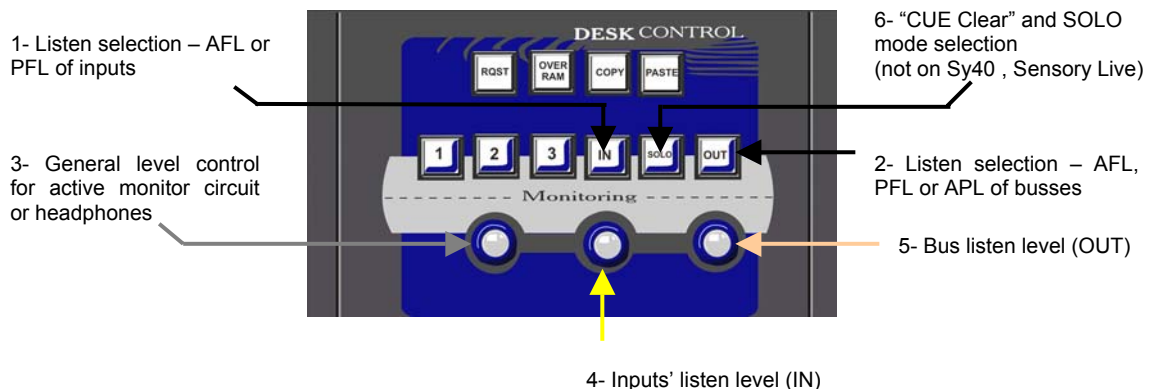

**4.D.7.2 Control operation**

1. Each press on the **[IN]** button toggles the inputs' listen mode between AFL and PFL.
2. Each press on the **[OUT]** button toggles the bus listen mode between PFL, AFL and APL (After Processing Level). Switching to APL requires the monitoring to be reinitialized, and amounts to a "CUE Clear". A message appears (see right) to warn you of the impending "CUE Clear".
3. General level adjustment for the active monitor circuit and headphones, independent of the listen mode selected.
4. General listen level adjustment for AFL or PFL of inputs (depending on the mode chosen).
5. General listen level adjustment for AFL or PFL of busses (depending on the mode chosen)
6. A light press on the **[SOLO]** button instigates a "CUE Clear", that is, all the IN and OUT channels in listen mode are removed from the Monitor bus. Pressing and holding the **[SOLO]** button switches the monitoring globally to SOLO mode. In this mode, only one channel can be listened to at a time. Each selection of a new channel cancels the previous channel – SOLO is an exclusive mode.

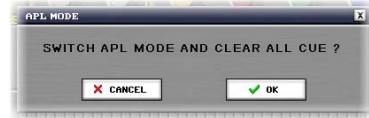

The selected mode, for inputs and busses, as well as the listen level for the current mode, are all displayed on the Sensoft screen:

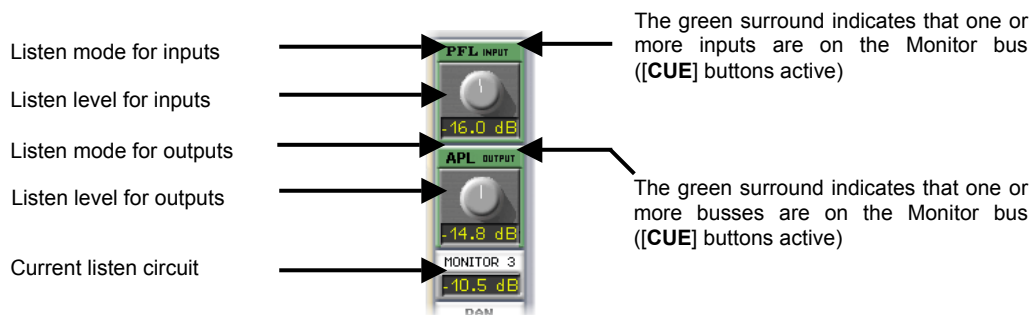

**4.D.7.3 The APL listening function for busses**

When busses (Auxes Groups, Matrixes or Masters) are patched to outputs that benefit from Hyperdrive processing, it can be very useful to be able to control the output with all its processing potential. For example, when you adjust the equalizer on an Aux output feeding a musician's wedge, wouldn't it be nice to listen to the adjustments you make, but on your own control wedge.

There are two conditions essential for this mode to work:

1. The chosen Monitor circuit must be patched to a pair of Hyperdrive outputs
2. APL listen mode must be selected on the outputs

If you take a look at the drawing below, you will see that the APL listen function is in fact a copy on your own listen output of the Hyperdrive parameters on the “monitored” output. That is why it is imperative that the output patched to the Monitor bus has processing (Hyperdrive) so that it can be “processed” with the same settings as the listen output.

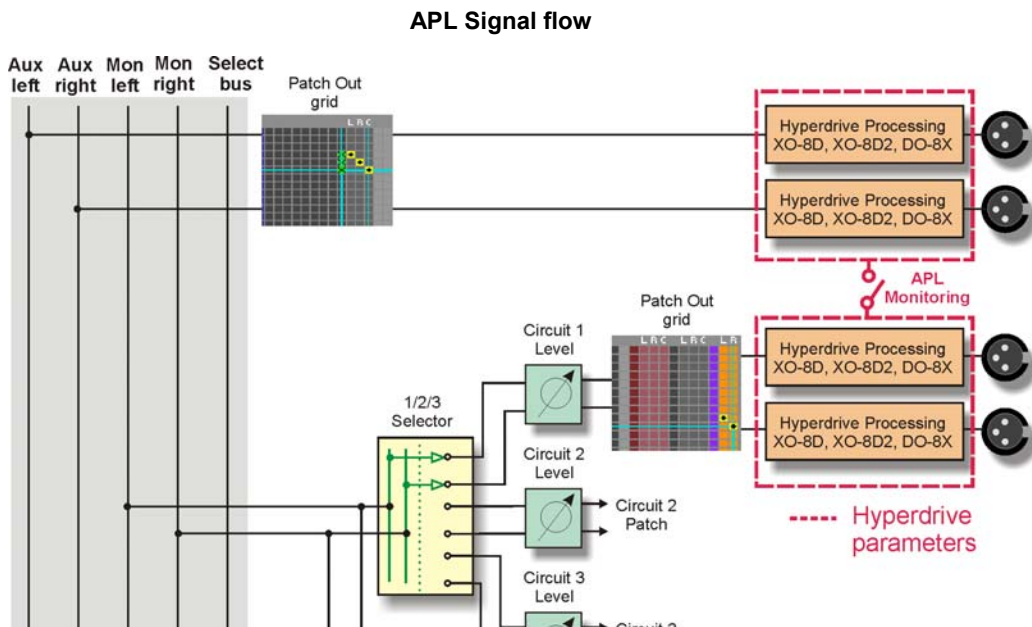

Given that the Hyperdrive processing in the monitoring is used for the copy of the “monitored” busses, it is not possible, in APL mode, to manually adjust the Hyperdrive parameters from the MUXI window (see Section 6 – Advanced Functions, for details on the MUXI window).

#### 4.D.7.4 Automatic Monitor circuit selection

Sensoft 8 provides a very nice feature when more than one listen destination is used by the monitoring. This function allows, when listening to a channel, to automatically switch the monitor circuit so that the selected channel can be sent to the required listen feed. For example, if some musicians use wedge monitors, while others use in-ear monitors, it is possible to send the listen signal automatically to one or the other. The illustration below describes the steps that allow you to link channels with a listen circuit :

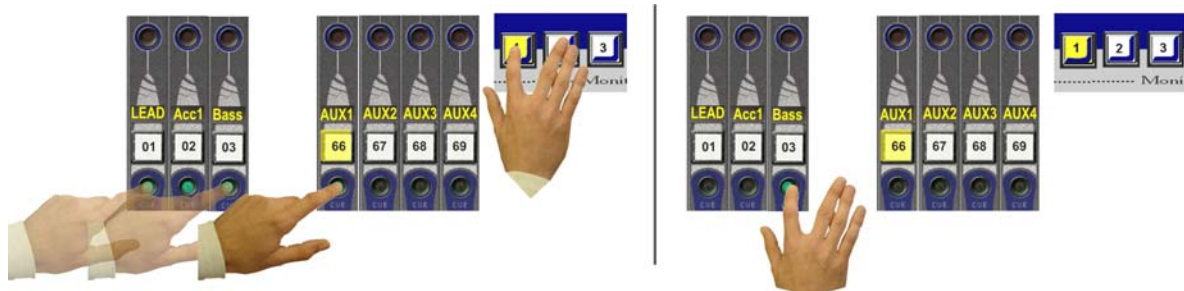

Press and hold the select button for **Circuit 1** while you press [**CUE**] on the channels you wish to assign to this circuit. The **CUE** LEDs stay lit to indicate the assigned channels. Re-press a [**CUE**] to remove that channel from the circuit.

The act of sending one of the previously memorized channels to the Monitor bus (by pressing [**CUE**] on that channel), automatically activates the circuit dedicated to that channel, here **Circuit 1**.



The same sequence has been repeated for **Circuits 2** and **3**; in the illustration, three channels are assigned to **Circuit 2**.

Finally, pressing the **[CUE]** of one of these channels automatically activates **Circuit 2**, assigned to the channel beforehand.

#### 4.D.7.5 The console's headphone circuit

Section 2.C.5 shows where the console's headphone connectors are situated. On Sy80, these connectors are wired in parallel, to avoid connecting two pairs of low impedance headphones which would give the headphone amplifier in the DSP module a hard time, and would lower the general level of the headphone circuit.

As shown in the illustration below, the headphone circuit can be fed from the Monitor bus or from the special "Select" Bus. In fact this bus contains nothing more than the selected bus signal (input or output) whose **[SELECT]** button is active. This enables you, for example, to keep an eye on an input to the headphones while listening to an output bus on the monitors.

The "Select" Bus is mono, and is selected in the MONITORING CONFIGURATION window.

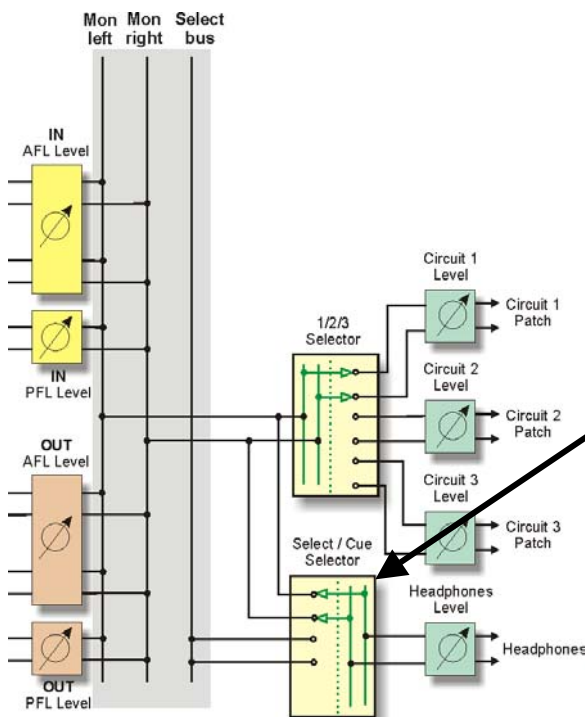

There is no function on the control surface that allows the headphone circuit's Select/Cue mode to be selected.

The output level setting of the headphone circuit is accessible via the rotary monitor level control when no monitor circuit is active (ie. [1], [2] and [3] are switched off). At this time, Sensoft indicates on-screen that any level adjustment corresponds to the headphone output.

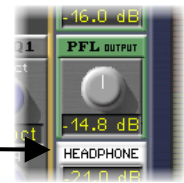

As already discussed, if a fader has been nominated for the control of monitor level, the rotary monitor control defaults to control of the headphone level, dependent on which circuit is active.

**APL** mode is not available for the headphone output; in this mode the headphone output monitor will be in AFL.

#### 4.D.7.6 Solo in Place mode

This mode of operation, selectable via the Monitoring configuration window, allows you to listen to a channel on its own, on the Master busses, by muting all the other channels. This enables you to check the tone and the positioning of a particular channel on the main PA system. As with any respectable Solo In Place function, it is possible to select channels to “Solo Safe” mode, so that they cannot be cut from the Master bus when another channel is selected to Solo In Place. These channels are likely to be, for example, the FX returns, needed to judge the sound of a channel and its FX on the PA system.

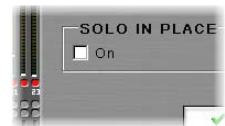

When Solo In Place mode is activated, the **[CUE]** function only works on inputs, you cannot AFL/PFL mix busses. The mode is displayed in red in the Sensoft monitor section (see left). To deactivate Solo In Place you must return to the MONITORING CONFIGURATION window.

To select one or more inputs to “Solo Safe”, simply press and hold their **[CUE]** buttons for at least 300ms. The **[CUE]** button(s) will start to flash to indicate that the input is in “Solo Safe”. Any normal action on a **[CUE]** button will have the effect of removing all other channels from the main mix, except those whose **[CUE]** button is flashing, indicating they are in “Solo Safe” mode.

#### 4.D.7.7 Automatic monitoring of machines return (MTRs etc..)

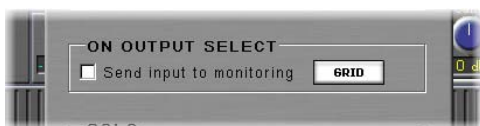

This function, when busses are used to feed the tracks of a multi-track recorder, enables you to listen automatically to the track return corresponding to a selected bus. The function is accessible and customizable via the Monitoring configuration window. A grid (click on **[GRID]**) allows you to choose which bus will relate to the monitoring of which input (coming from the MTR return) when it is selected.



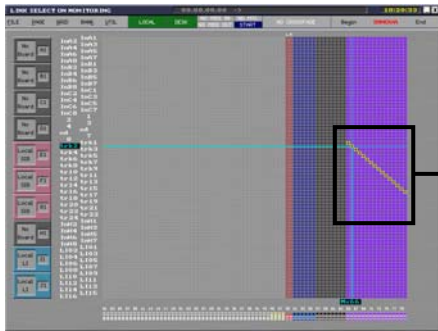

The 16 Matrix buses feed 16 tracks of a recorder. When you select one of these buses, the input corresponding to the patch point on this grid will be automatically soloed on the Monitor bus. In this way, it's possible to monitor track returns (or other return signals) without having to patch the corresponding inputs to console faders.

#### 4.D.7.8 The Monitoring Preferences window

The illustration below describes the various functions of the the MONITORING CONFIGURATION window, and how to access it.

**Input PRIORITY** : In Solo mode, the inputs listen function takes priority over outputs listen.

**Output PRIORITY** : In Solo mode, the outputs listen function takes priority over inputs listen.

**Master if no Cue** : If no bus is feeding the monitoring (all the [CUE] buttons are off), the Master has priority and feeds the monitor bus.

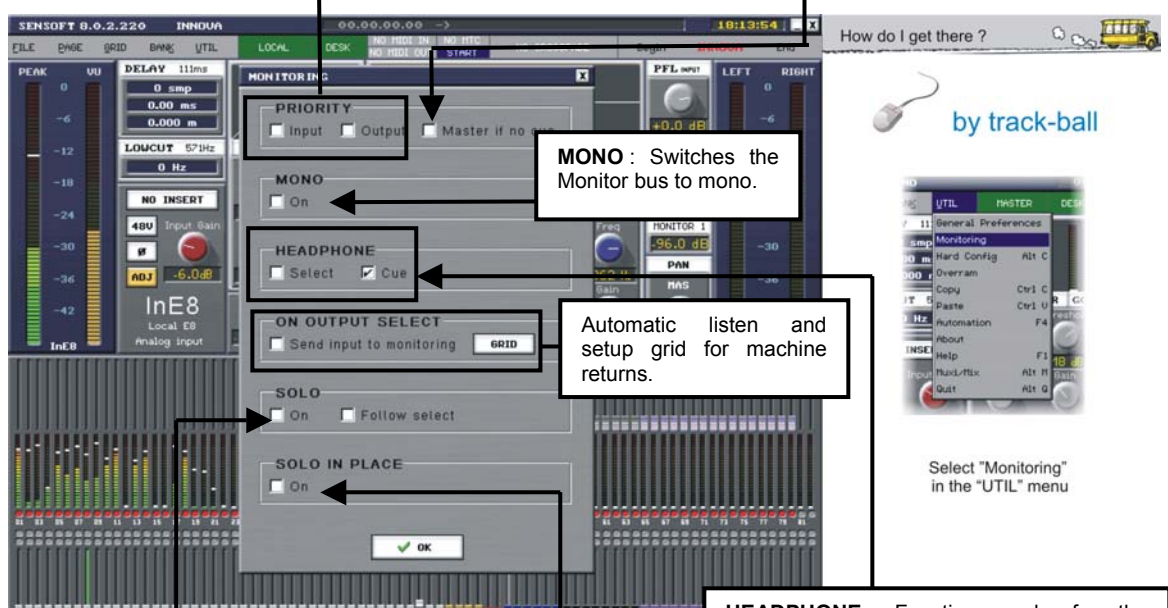

**MONO** : Switches the Monitor bus to mono.

**HEADPHONE** : Function mode for the headphone circuit – listen to the Monitor bus (Cue) or the Select bus.

**ON OUTPUT SELECT** : Automatic listen and setup grid for machine returns.

**SOLO** : Software switch for Solo mode. Equivalent to a long press on the Sy80 console's SOLO button.

**Follow select** : Each press on a channel [SELECT] button sends the latter to the Monitor bus.

**SOLO IN PLACE** : Activates Solo In Place mode.

by track-ball



Select "Monitoring" in the "UTIL" menu

#### 4.D.8 Master busses

Sensoft 8 allows several Masters to be set up or, to be more precise, as many Masters as the DSP module resources allow. As shown in the diagram below, all the Masters receive, as you'd expect, the same mix from Inputs and Subgroups, but each has its own routing, mute, patch and output level.

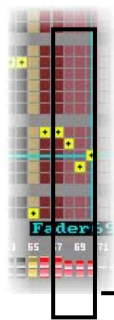
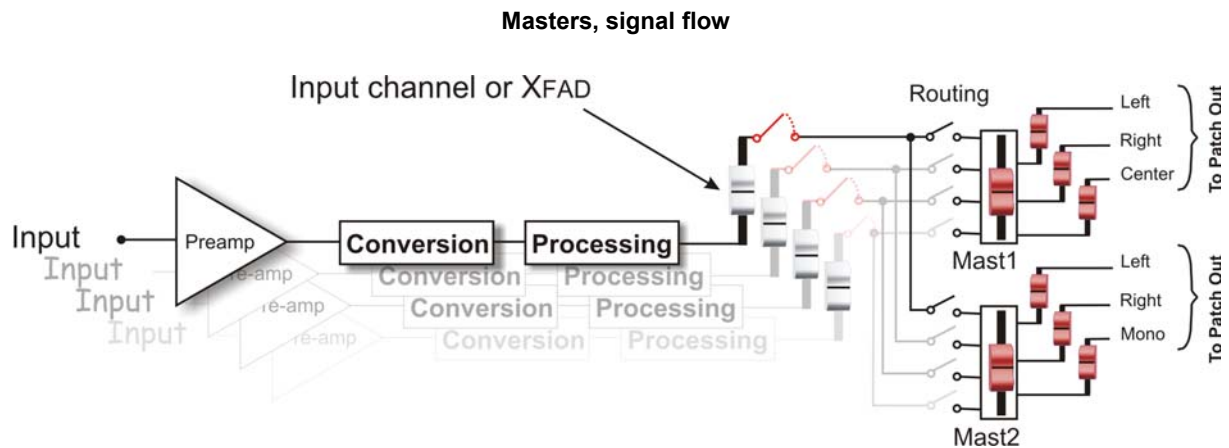

When several Masters are set up in the HARDWARE CONFIGURATION window, they share, as with Auxes and Groups, the same spread zone. When Masters are patched to Hyperdrive outputs, each bus has its own processing, so several Masters can be used in this way, when there is more than one PA system to be catered for.

#### 4.D.9 Bus processing and inserts

- The current version of Sensoft 8 does not allow processing on local busses. Busses can only be processed on a Muxipaire output when they are patched to Hyperdrive modules such as the XO-8D and DO-8X; the Line Outputs also do not benefit from output processing.
- The insertion of external devices on busses is not available.

#### 4.D.10 Hyperdrive outputs' processing control

When a bus (Aux, Group, Master or Matrix) is selected, that has been patched to a Hyperdrive output, the console controls, as well as the Sensoft display of dynamics, equalizer, phase, delay and gain processing, can be used on the output to which the bus is patched. If the bus is split over several outputs, every press on the **[SELECT]** button of this bus changes the output affected by these adjustments.

In this way, if, for example, output A1 feeds the left main PA and output A3 feeds delayed cabinets on the left, both outputs can be patched to the same bus, ie. the left Master. Every time you press the left Master's **[SELECT]** button, it toggles access to the adjustments for output A1, A3, A1, etc. Simply stay on output A3 and adjust its delay to put the left cabinets in phase with the left main system. If you had previously set up a link (Link I/O) between the left cabinet output and the right cabinet output, then the complete system will now be in phase.

##### 4.D.10.1 Specific displays

The console's VU meters, as well as Sensoft's bargraphs, are modulated according to signals derived from data put out by the various I/O modules on the Muxipaire digital bus. The Sy80's DSP module provides this bus with digital data relative to all the mix busses created by the user. The VU meters and bargraphs display these mix bus modulation levels before they feed the DSP responsible for the Hyperdrive module output processing. In order for the VU meters and bargraphs to take Hyperdrive processing into account, the output module would have to put the signal data on the digital bus after the Hyperdrive processing, as illustrated in the figure below :

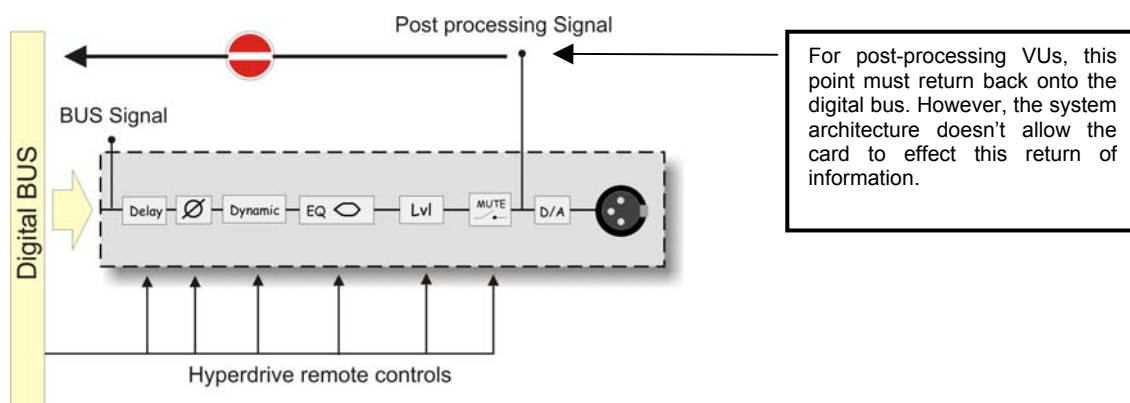

So, don't be amazed not to see the VU meters and bar-graphs echo the maximum level readings for Hyperdrive outputs, compressor gain, etc. Similarly, in the dynamics processing window, the meter indicating the post compression signal will not modulate because, for the same reasons, this signal is not returned by the Hyperdrive module. Finally, the blue LED on the VU meters, indicating the state of the gate opening and closing, will not be available.

#### 4.D.10.2 Specific adjustments

The adjustment of Hyperdrive parameters is generally made in the same way and with the same controls as for input channel processing. However, the output module differs somewhat with regard to the following parameters :

- The Hyperdrive output's parametric equalizer has eight bands, whereas the input channels have four. To switch from adjustment of the first four bands to the second four bands, use the **[EQ 1/2]** button, in the EQ section of the console
- The rotary gain control now sets the maximum output level when the bus signal modulates to 0dBfs. On XO-8D modules this can be adjusted from +10.5dB to +22dB. The 0dBfs value for the system input corresponds to +12dBu; the maximum output level, equivalent to unity gain, is therefore +12dB.



#### 4.D.11 Principles of fader functions – Fader Mode

All the faders on the control surface are motorized, and none of them carry the audio signal directly. Their “interpreted” position, combined with the current selection, allows them to be assigned to one or other of the possible mix busses in the console, according to the channel or bus that you wish to modify. Thanks to this, we were able to replace the traditional column of auxiliary pots on the input channels with fader “states”, that allow much faster access to, and easier “reading” of, the current levels.

You need to remember the following important points :

- Pressing the **[SELECT]** button of an Aux automatically transforms all the input faders into Aux Sends to that Aux. So, for every Aux you can immediately see its balance with the help of the input faders – immensely practical in sound reinforcement for stage monitoring
- Conversely, pressing the **[SELECT]** button on an input automatically transforms the Aux faders into Aux Sends, for the selected input only, of course.

***These very powerful functions have no analog equivalent !***

Sensoft uses a patented sensory location process for the “remembered” position of faders. As you manipulate the faders, a “hard point”, referenced to the memorized position, allows you to manually reposition faders to this point.



The individual levels of inputs to the main mix, as well as the general levels of mix busses, are always displayed on the Sensoft screen.

The FADER MODE options (found in the *General Preferences* menu) offer three choices concerning the behavior of faders when an Input or Aux is selected :



**Attention.** The two In and Aux modes are overlapped by the 'Static Matrix' mode when a matrix is selected. See section 4 .D.6.2 as well.

- **In** : In this mode, input faders always have the function of level control to Masters. Masters, whatever fader is currently selected, never become Aux Sends for the inputs that they are responsible for.
- **Aux** : This mode, particularly appropriate for stage monitoring, locks Aux faders to the function of Aux Master. There should then be no confusion between Aux Masters and Aux Sends.
- **Dual** : This is the default mode. When an Aux is selected, the Aux faders behave as Aux Masters while the input faders act as Aux Sends. Conversely, when an input is selected, the input fader controls the "master" level of the input, while the Aux faders control individual Aux Send levels for the currently selected input.

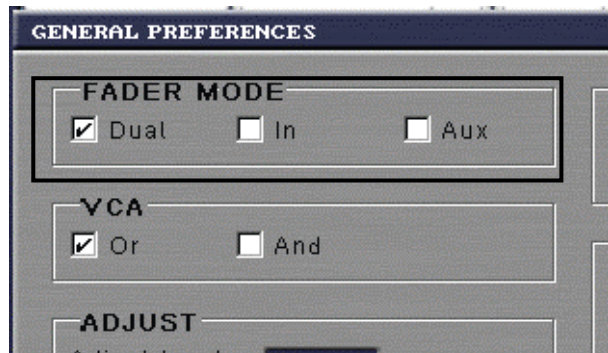

### En example in DUAL mode

The selection of input channel 25 causes an immediate update on the console of all output faders. These output faders now represent the respective levels of channel 25 to each of the mix busses, and it becomes possible to make individual modifications. If Bus (Aux) 4 is, say, in the -20 position, by modifying this level and returning to this value, you will be able to feel the memorized sensory point.

The selection of Aux 4 causes an immediate update on the console of all the input faders. These input faders now represent the respective levels of each of the inputs to Bus 4. As in the previous example, if channel 25's fader is in the -20 position, it will also have a memorized sensory point. You can modify the level of channel 25's Aux Send contribution to Aux 4 in the following ways :

- by selecting channel 25 and adjusting the Aux 4 fader
- by selecting Aux 4 and adjusting input fader 25.

Got it ?

## 4.D.12 Mute and Cue functions

### 4.D.12.1 The Mute function

For channels patched directly to physical outputs, the **Mute** function acts in the usual way by preventing or enabling a signal reaching the mix busses.

On the other hand, when channels are part of a spread, a **Mute** acts as in the example of an Aux bus given below :



If all the XFAD **Mutes** are in the same state, the channel **[MUTE]** will act as a remote control on all the XFAD it controls.

The individual **Mute** of each XFAD takes priority over the channel. The Input channel **[MUTE]** acts on the XFAD that are not individually muted.

When the Input channel is muted, you can modify the state of the XFAD to prepare them to be opened when the Input channel is un-muted.

Generally speaking, when a channel is muted by an “external” control (Aux, Group, or VCA) and not by its own mute function, its **[MUTE]** button will flash.

### 4.D.12.2 The Cue function

For channels patched directly to physical outputs, the **Cue** function sends the bus signal to, or removes it from, the Monitor bus.

On the other hand, when channels are a part of a spread, the **Cue** function acts as in the example of an Aux bus, given below :



Selecting the **[CUE]** function on an Aux channel, allows the XBus, assuming their **[CUE]** function is active, to feed the Monitor bus.

If nothing has been prepared at the XBus level, the Aux channel **[CUE]** will remote control the **[CUE]** of all the XBus it controls.

## 4.E The MUXIPAIRE Bus and the Direct I/O grid

The coaxial cable connecting Mix Box to Stage Box is the equivalent of a 64-channel virtual bus, known as the MUXIPAIRE bus. 64 signals from the input modules are present on this bus, and are available at the same time to both audio racks. The output modules can be programmed, via Sensoft, to intercept one of the input channels and make it available on an XLR connector. When a MO-8D3 type analog output is programmed to pick up the signal coming from input **D5** (slot **D** input **No. 5**), it waits until the signal corresponding to this input is present on the digital bus, in order to capture the data originating from this signal, and to convert it to analog. The signal entering the system on **D5** is now available on one of the MO-8D module's XLRs. The input module can be in the distant rack (Stage Box) **or** the local rack (Mix Box). You cannot obviously have two input modules in the same local and distant slot – this would create significant conflicts. Thus, the signal can come from the local or distant **D5** input – it's not important to the output module which, anyway, simply waits for the signal corresponding to the D5 address.

Exploded view of the local and distant audio racks

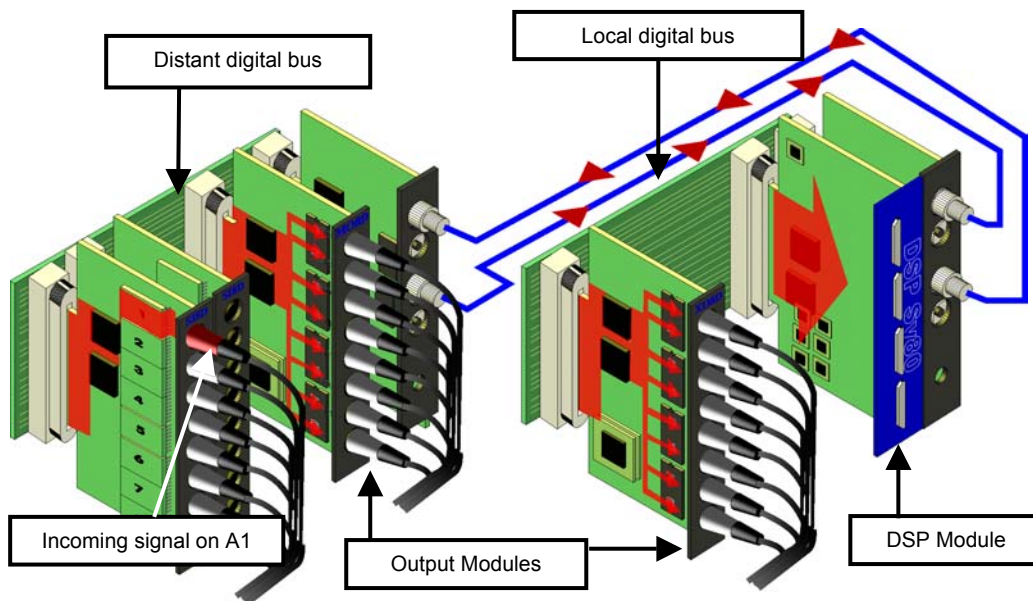

The incoming signal on A1 is available to all the output modules present in the local and distant audio racks. This signal is also available to the DSP module so that it can be mixed on the various mix busses.

**Note:** For the Compact Sy40, although the audio rack is integrated in the back of the console, and the modules are arranged horizontally, the functional principle is just the same.

### 4.E.1 The DIRECT I/O grid

In addition to the nomination of insert points, this grid allows you to program local and distant output modules as direct outputs for selected inputs. Thus it's possible to exchange signals between control room and stage, to feed out of the same audio rack one of the signals entering it, or even to split the incoming signals. Paragraph 4.C.2 explains how to access the various patch grids. The DIRECT I/O grid looks like, and functions as described in the illustration below :

The screenshot shows the 'PATCH DIRECT I/O' window. On the left is a list of input resources (A1-J1) and output resources (S18, S19, S20, S21, S22, S23, S24, S25, S26, S27, S28, S29, S30, S31, S32, S33, S34, S35, S36, S37, S38, S39, S40, S41, S42, S43, S44, S45, S46, S47, S48, S49, S50, S51, S52, S53, S54, S55, S56, S57, S58, S59, S60, S61, S62, S63, S64, S65, S66, S67, S68, S69, S70, S71, S72, S73, S74, S75, S76, S77, S78, S79, S80, S81, S82, S83, S84, S85, S86, S87, S88, S89, S90, S91, S92, S93, S94, S95, S96, S97, S98, S99, S100). The main area is a grid where a patch point is being created between input 'I1' and output 'S18'. A callout points to this grid: 'Point at the required Input/Output pair and create a patch point.' Another callout points to the left sidebar: 'All the Muxipaire output resources with control and display of Mute.' A third callout points to the top right: 'An input can be split over several outputs.' A fourth callout points to a gain control knob on the right: 'Gain setting and display of the signal present at the selected preamp.' A fifth callout points to the bottom sidebar: 'All the Muxipaire input resources with control and display of 48V phantom power.' A sixth callout points to the bottom right: 'Line Inputs can only access Line Outputs'. The interface also shows a 'PEAK' meter and a '+0.0dB' gain setting.

From this grid it's possible, for any preamp that you point at, to adjust the gain ([F5] and [F6]), to activate or deactivate the phantom power supply ([F7]) and to see the input level on the meter to the right of the grid. It is also possible to mute an output, by pointing at it and using the command [F8]. Think of this grid as the place where you can adjust preamps not allocated directly to the console faders, as in insert returns for example, or to check the level of preamps which have not yet been patched, etc..



The DIRECT I/O patch has priority over the PATCH OUT window. If an output is used in the DIRECT I/O grid when it is already patched to a mix bus, the patch point to this mix bus will be canceled.



### 4.F The VCA function

In addition to the Input, Aux, Group and Master faders, which act like a VCA on the channels they control when spread, the console is also equipped with “VCAs” with which it is possible to control various channels. These VCAs allow the “remote control” of the fader level, as well as the Mute, of channels to which they are assigned.

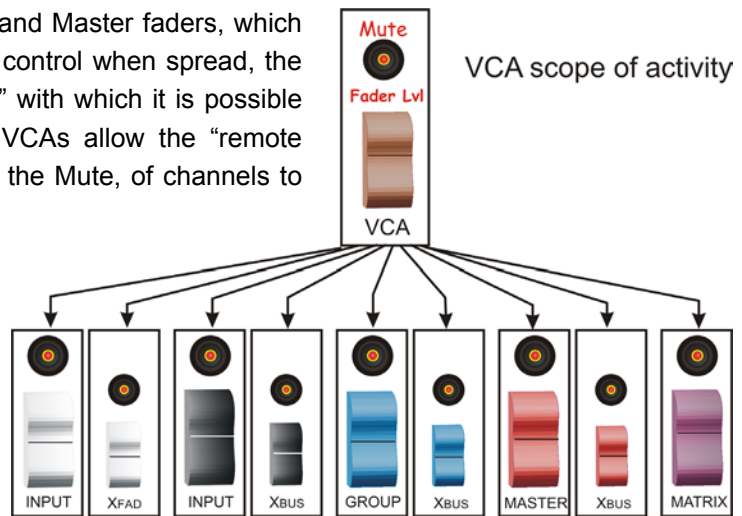

#### 4.F.1 VCA function logic

As with any self-respecting **VCA** function, it is possible to assign the same channel to several VCA faders. For even greater flexibility, we offer two logic modes:

- Additional logic (AND): the actions of different VCAs on the same input are added.
- Priority logic (OR): the VCA having the highest value imposes this value on the inputs assigned to it.

Example of three VCAs applied to a Guitar input

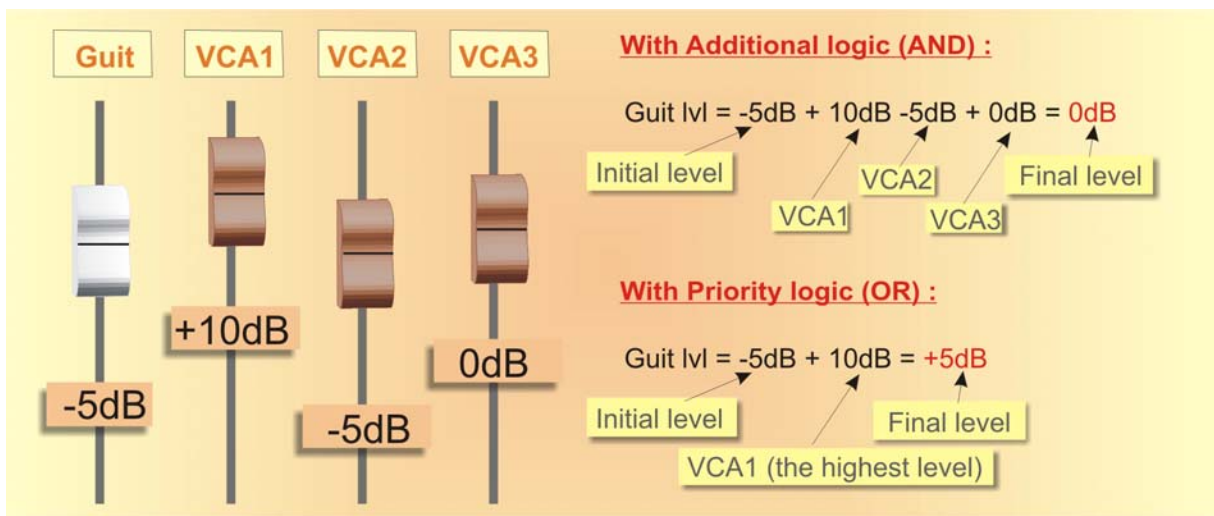

The figure above shows the action of several VCAs on the same channel, according to the chosen logic. Which logic will you choose? It obviously depends on your needs, and each logic setting has its advantages. However, the main characteristics are :

- ◆ **In additional logic (AND)** every VCA always has an influence on the controlled input. With this logic, a VCA moved to  $-\infty$  has the power to cut the input that it controls.
- ◆ **In priority logic (OR)** only, the VCA having the highest level has an influence on the controlled input. No VCA has the power to cut an input which it controls (except by means of the mute).

The choice of **VCA** function logic is made in Sensoft's *General Preferences* menu, as shown below :

#### Choice of VCA function logic in the General Preferences menu

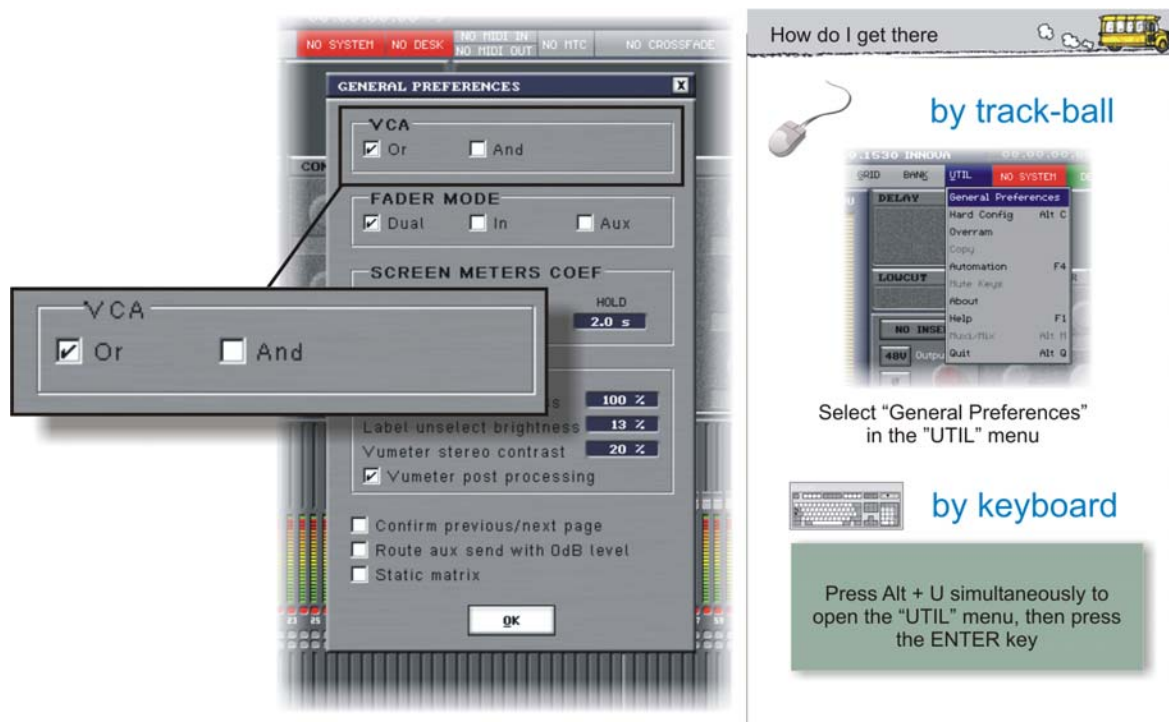

### 4.F.2 VCA Assignments

VCAs can control any console fader. The assignment of a channel to a VCA is made in the same way as traditional routing (press and hold the **[SELECT]** button of the chosen VCA fader and press the **[SELECT]** button of the fader you want to assign to the VCA). XFAD are the only spread channels that can be individually assigned to a VCA; XBUS channels cannot be individually assigned; for an Aux, Group or Master, all or none of the spread busses will be assigned to a chosen VCA.

### 4.G Talk-back

The Sy80 console is fitted with two microphone inputs, one at either end of the front of the console (see paragraph 2.A.5), that can be used to connect a talkback mic. This can then be assigned to any output bus.

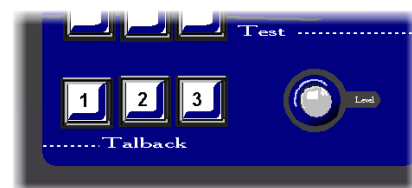

Sy40 and Sensory Live have only one Talk-Back mic input and share the talk-back controls with monitoring circuit according to *General Preferences* options. See sections 2.C.7 and 6.Q.

Three buttons on the console are used to define and remember three different routing configurations, which can be recalled by a simple press on one of the buttons. For example, button **1** could be configured to talk to the stage, button **2** to backstage, and button **3** for announcements on the main PA (via a Master).

If you press and hold any one of these three buttons, the following window appears :

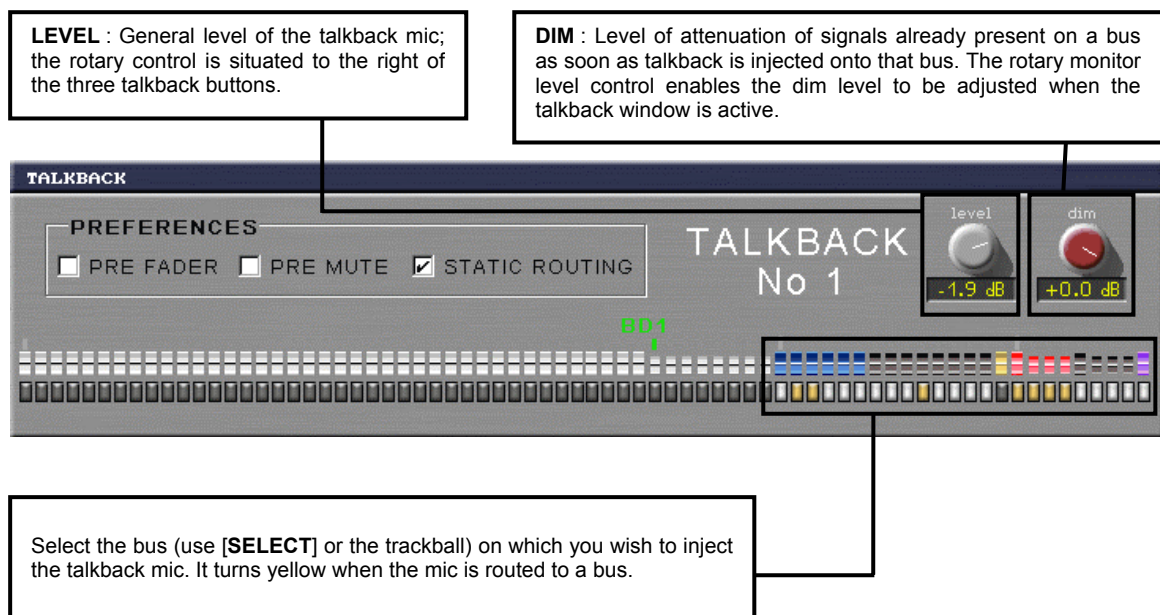

The TALKBACK window contains three preference check boxes, which activate or deactivate the following functions:

- **PRE FADER**: Selecting talkback to pre-fader allows you to talk to busses even if one or several level control faders of these busses are at  $-\infty$ . For example, an audience announcement would still be possible even if the Master faders are lowered.
- **PRE MUTE**: In pre-mute mode, the talkback mic can address busses which are muted. You could, for example, mute an Aux feeding a wedge on stage, and continue to talk to the musician using this wedge.
- **STATIC ROUTING**: By default, this option is activated so that any busses selected for the talkback (1, 2 or 3) are remembered. So, each time the corresponding button is pressed, the talkback routing configuration is recalled and immediately effective. Uncheck this item to have a blank routing configuration each time you press a talkback button.



The talkback mic is an invaluable tool for “line checking” the console circuits. In PRE FADER and PRE MUTE mode, the mic can be used to test all the busses, irrespective of their mute settings and fader levels.



## 5 STRUCTURE OF A LIVE PERFORMANCE

### 5.A General Description

InnovaSON consoles present some unusual features when compared to traditional live consoles, and Sensoft is organized in such way that it adapts itself as the pro-audio operation (show, TV shoot, audio recording, event, etc.) progresses.

Everything is designed to offer speed of access and maximum security.

Console operations are managed by means of a FILE, into which you insert one or several PAGES. These pages contain the various immediate phases of the job, that you want, or need, to remember.

Each FILE can contain up to 1000 pages, and also remembers all the user-configurable setup information (Relax Grid, General Preferences and Audio Rack Config, etc.).

Every page is a “snapshot” of all the parameter settings for the entire console, in a moment of time – we’re talking “Total Recall” here baby!

The only limitation concerns the configuration of functions assigned to faders. This, in order to keep latency time and risks to a minimum, must be identical for all the pages in the same file. If you find it necessary to have different fader configurations during the same event, simply create a file per configuration, and the problem is solved!

### 5.B Management of files and pages

#### 5.B.1 Editing a file

The [EDIT] button opens the working file management window (the button lights up). You can also call up this window using the trackball, or by clicking on "Edit" in the *FILE* menu. The file edit screen allows the creation of a file and its modification, from the current pages on hard disk and in RAM. This window shows all the files, and all the pages stored on hard disk, as well as a list of pages in use.

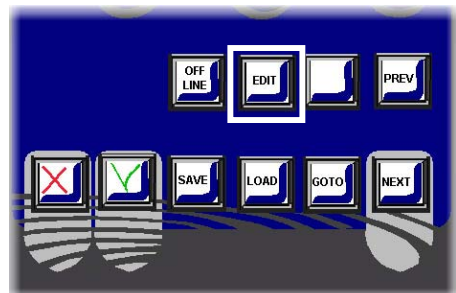

**RAM and Hard Disk, some important points ...**

The illustration below shows, in a broad view, the organization used for the management of files and pages:

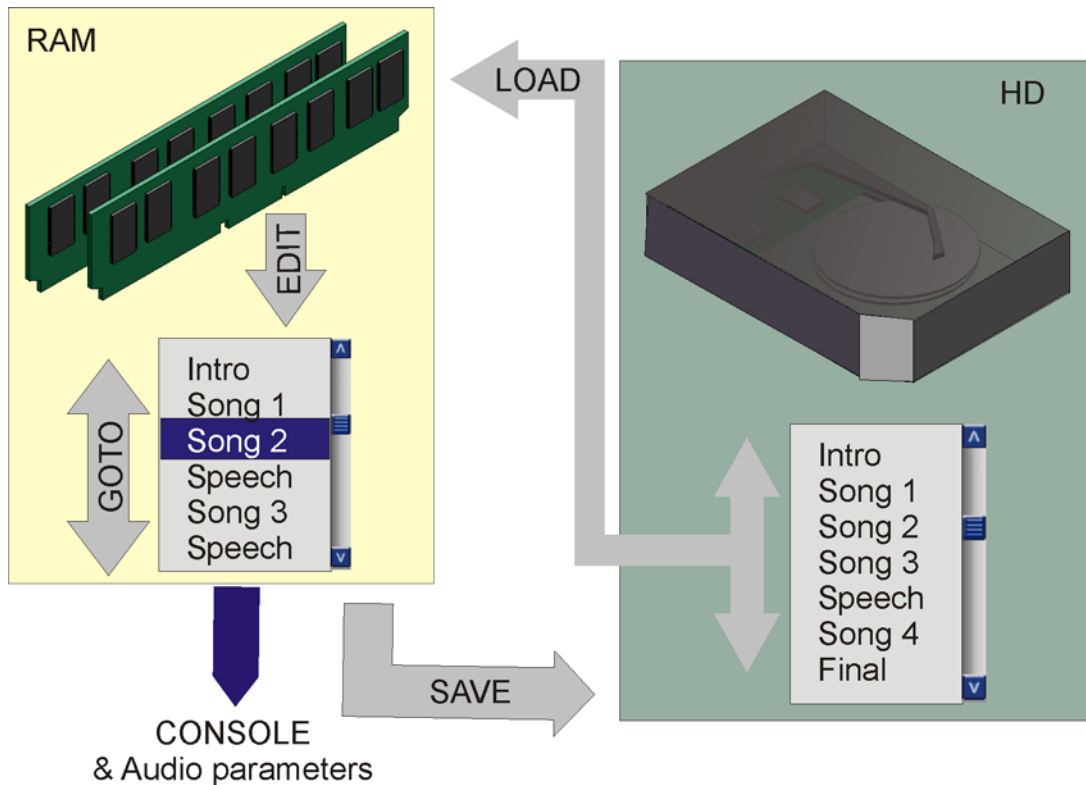

All the pages stored on the Flash Hard Disk (HD) are classified in files carrying, preferably, the name of the event concerned with its pages. The console, as well as the audio parameters, are automatically updated according to the data present in the computer's RAM. Similarly, any action on the control surface results in an update of the data in the current page of the computer's RAM. So, activating the **Goto** function, which allows pages contained in RAM to be recalled, recalls these pages with the last modifications that were made since their last transfer to RAM. Modifications made in "real time" on pages are thus preserved up to the time you load another file, or the console is turned off. Of course, if you wish to keep these modifications, you can, at any time, transfer the RAM data to the HD for definitive storage. Activating "**LOAD**" transfers a selected page from the HD to the RAM, then updates the console parameters, and audio, according to the data on this page. This data has nothing to do with the last changes made in real time, because the page that is loaded into memory is just as it was when last saved (using **SAVE**) to the HD.

The EDIT window allows you to decide on the structure of the event by modifying or establishing the list of pages in RAM, based on pages stored on the HD. The window looks like the figure below:

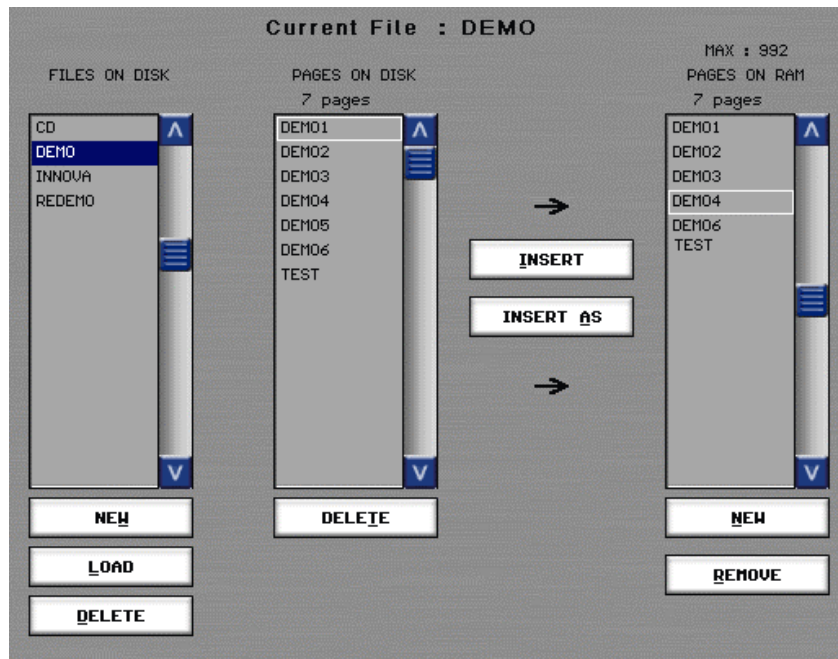

Three indexed columns contain the data, according to the job in hand, necessary for the structure of the event.

Let's examine these columns in detail:

**FILES ON DISK.** This column contains a list of all the files saved on the hard disk of the PC (HD). The selected file (in blue) opens a list in the following column, of the pages which it contains. The **[NEW]** button allows you to create a new, empty, file. As soon as you create a new file, you will be asked for a "name of the file" and a "name of the first page" to be contained in this file. The **[LOAD]** button loads, into RAM, the structure of the event stemming from the selected file (in blue). The function of the **[DELETE]** button is to delete a file, and the pages contained in it, from the HD.

**PAGES ON DISK.** This column contains a list of all the pages contained in the file that has been selected in the previous column. The **[DELETE]** button allows you to remove a selected page from a file, and therefore from the HD.

**PAGES ON RAM.** This column contains a list of pages, stemming from the previous column, selected for the event currently being edited. This column can have more or less pages in it than in the middle column, because the same page can be used several times during an event, whereas pages stored on the HD cannot be used in this way. The **[NEW]** button enables you to insert a blank page in the list, below the selected page. The **[REMOVE]** button clears a selected page from RAM but, be assured, does not remove it from the HD. A "removed" page can therefore be replaced in the event structure at any time.

**On the left of this column are two more buttons:**

The **[INSERT]** button allows you to take a selected page from the middle column, and insert it in the RAM column, below the selected page in that list. The page will be inserted with the same name as it has on the HD.

The **[INSERT AS]** button behaves just as the **[INSERT]** button, but with the possibility of renaming the page before it is inserted. When the file is saved, the newly inserted page will be included in the list of pages present in this file. This function is useful when building a file from reference pages, or when duplicating a page under different name so you can make changes without modifying the original page.

At the top of the window is the wording “**Current File : xxxx**” indicating the current file in use for the structure of the current event. Since it is not possible to use pages that have a different fader configuration, only pages held in the current file may be edited from this window.

### 5.B.2 Changing Files

Loading a file instigates three operations:

- Pages contained in the file are made available for editing the structure in RAM.
- The current structure in RAM is updated according to the structure created when the file was last saved.
- Any new page created will be saved, as a backup, in this file.

This operation can be carried out from the Edit window, by using the **[LOAD]** button under the **FILES ON DISK** column, or from the main Mix window by selecting **[Load]** in the *FILE* menu.

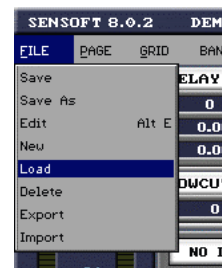

The **[NEW]** command, available in the same window and menu, allows you to load a blank file. A “FILE NAME” dialog box appears on the screen, asking for a name for this file, and then a name for the first page. If the name already exists, a dialog box asks you to confirm its replacement.



Take care, any change of file risks bringing about a change of console configuration, so avoid testing files “blind” while a PA rig is connected to the system.

### 5.B.3 Saving a File

Saving a file is carried out by selecting **[Save]** in the *FILE* menu. This will save the current state of all the pages in this file.

A “FILE SAVING : PLEASE WAIT” message appears, and the **[SAVE]** button on the console lights up for a few moments, according to the size of the file.

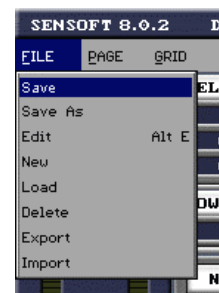



It is possible to duplicate the current file under another name, using the [**Save As**] function in the *FILE* menu. A “FILE SAVE AS: Enter the new name” dialog invites you to enter a new name for the file. This file then becomes the current file, and all future modifications will be made within it. If the new file name already exists, a dialog box will ask you to confirm the replacement.

### 5.B.4 Exporting, Importing and Deleting Files

An **Export** function is provided so you can copy the current file in RAM to a floppy disk. The export is made via the [**Export**] command in the *FILE* menu. A “EXPORT FILE : PLEASE WAIT” window appears for a few moments, depending on the size of the file.

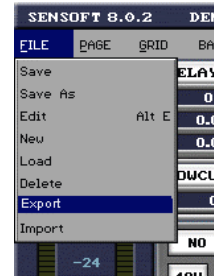

In cases where the file you are copying has the same name as a file already on the floppy disk, a dialog box asks if you want to replace this latter file: “Overwrite xxxx?”. If you choose “YES”, the file and all its pages will be deleted. If “NO”, the operation is canceled.

**If there is a problem with the floppy disk, a dialog box to this effect will appear:**

- **NO FLOPPY DISK**
- **DISK WRITE PROTECTED**
- **DISK HAS CHANGED** = The floppy disk was changed since the last attempt to read/write
- **BAD DISK SECTOR** = A sector is damaged
- **UNFORMAT DISK** = The floppy disk is not formatted
- **WRITE ERROR, DISK FORMAT ERROR** = The format of the floppy disk is not compatible
- **WRITE ERROR, FLOPPY DISK FULL** = The floppy disk is full!
- **FLOPPY DISK ERROR** = An unlisted error occurred

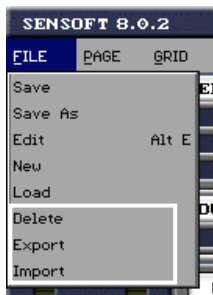

The **Import** function is provided to copy a file, and all its pages, from a floppy disk to the hard disk and the RAM. File import is carried out by selecting the [**Import**] command in the *FILE* menu. A list then presents all the files available on the floppy disk, and a dialog box informs you about the state of the floppy disk, if there is a problem.



Any deletion of a file leads to the permanent deletion of all the pages contained in that file.

## 5.C Page Management

### 5.C.1 Saving a page



A page is saved using the **[Save]** command in the *PAGE* menu, accessible from the keyboard using the **[ALT] + [W]** keys, or by pressing the **[SAVE]** button on the console. The page is saved on the HD just as it appears in RAM (a single snapshot of the console parameters). This function replaces the page carrying the same name in the current file, with the page in RAM.



A “PAGE SAVING : PLEASE WAIT” dialog appears, and the **[SAVE]** button on the console lights up while the save takes place.

You can duplicate the page under a different name, by means of the **[Save As]** function in the *PAGE* menu. A “PAGE SAVE AS : Enter the new name” dialog box invites you to enter the new name. If the chosen name already exists, a dialog box requests confirmation. The page saved to hard disk now becomes the current page, and replaces the former page in the “PAGES ON RAM” list. However, the former page will always be present in the file on the hard disk, and can be reloaded into RAM later, as required.



The name of the current page, such as one just saved to hard disk, appears in blue in the on-screen information bar. If modifications take place to the current page, its name changes to red to indicate that the page is no longer in the same state as the page with the same name stored on the HD.



### 5.C.2 LOAD and GOTO

The **[Load]** function opens a window containing a list of pages in RAM. Once a page in the list is selected and confirmed with **[OK]**, the page on the HD carrying the same name is read in, and replaces the page currently in RAM. The page read from the HD will be the latest saved under that name. The page in RAM, and the console, are updated with the new parameters. If modifications have been made in RAM and have not been saved (with **[SAVE]**) before selecting the **[LOAD]** function, they will be lost.



Cette fenêtre est accessible par le bouton **[LOAD]** de la console. On peut également ouvrir cette fenêtre en appuyant sur les touches **[ALT] + [L]** du clavier ou via la fonction **[Load]** du menu *PAGE*. La touche **[LOAD]** de la console s'allume.

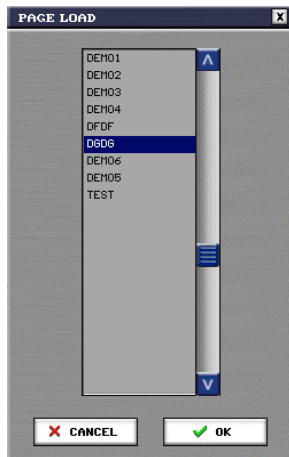

The choice of page to load can be made in several ways:

- Use the console track-ball, and confirm with a left click
- Use the Up/Down cursor keys on the keyboard, and confirm with [Enter]
- Select the required page with the track-ball, and confirm by clicking on [OK].

You can cancel the load process by pressing either the [LOAD] button on the console, or the [Esc] key on the keyboard, or even by clicking on [Cancel] with the track-ball.

Warning: bear in mind that the loaded page may be different from that with the same name currently stored in RAM, if a save has not been made previously. Be careful when you use the **Load** function. Do not assume that [Load] *inserts* a page into RAM, it is a simple transfer to RAM of parameters loaded from the HD.



The **Goto** function opens a window containing a list of pages in RAM, allows you to select a specific page in RAM, and then update the console with the selected page. The window is accessible by pressing the [GOTO] button on the console; the button lights up. The [Goto] function in the **PAGE** menu also opens this window.

The choice of page can be made in different ways:

- Use the console track-ball, and confirm with a left click
- Use the [Up]/[Down] cursor keys on the keyboard, and confirm with [Enter]
- Select the required page with the track-ball, and confirm by clicking on [OK].

You can cancel the Goto process by pressing either the [GOTO] button on the console, or the [Esc] key on the keyboard, or even by clicking on [Cancel] with the track-ball.

The page you select and confirm will update the console but take into account any possible modifications made “live” during the most recent use of this page (as long as no new file load or console restart has been made previously).

### 5.C.3 Inserting a page

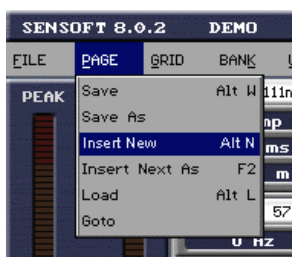

The **PAGE** menu provides two types of page insertion, the insertion of a blank page between the current page and the following page, instigated by the [Insert New] command, or an insertion between the current page and the following page of a page identical to the current page, but for which a new name must be given, instigated by the [Insert Next As] command. If that last sentence confused you, try reading it again!

The **Insert New** function is also accessible via a [ALT] + [N] shortcut, the **Insert Next As** function via the shortcut [F2].

The **Insert Next As** function, developed by InnovaSON from considerable experience in the field, allows you to duplicate a carefully designed page, very quickly and safely, as the basis for a new one. Simply by pressing [F2], the current page is saved, then duplicated and becomes the current page with the new name you have just provided; you are now ready for the next line check. Putting it another way, **Insert Next As** saves the current page to hard disk, duplicates it under another name, and places the copy in RAM, in one single step.

## 5.D Navigating files: NEXT, PREV, LOAD and GOTO

The use of these four functions activates:

- The sending of MIDI program changes (OUT)
- The sending of remote controls to the audio racks (Mix Box and Stage Box)
- A refresh of the console and its display
- Furthermore, the [NEXT] button turns on the automation (see section 5. E).

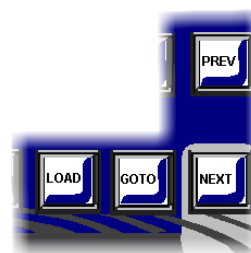

**NEXT.** The [NEXT] button on the console allows you to select the next page in the sequence of pages in RAM. If the “Confirm previous/next page” check box is ticked in the General Preferences menu, you will be asked for confirmation. This request for confirmation is not provided if the page change is called from the keyboard with the [PAGE UP] key; in this case the change is immediate.

**PREV.** The [PREV] button on the console allows you to select the preceding page in the sequence of pages in RAM. If the “Confirm previous/next page” check box is ticked in the General Preferences menu, you will be asked for confirmation. This request for confirmation is not provided if the page change is called from the keyboard with the [PAGE DOWN] key; in this case the change is immediate.

**LOAD.** The [LOAD] button allows you to immediately find the page you need, among all the pages stored on the HD, without having to scroll through any intermediate pages. The page loaded from the HD will be in exactly the same state as it was at its most recent save. Any “live” modifications made during the last use of this page will be lost. See section 5.C.2.

**GOTO.** The [GOTO] button allows you to immediately reach the page you need, among all the pages stored in RAM, without having to scroll through any intermediate pages. It will contain all the possible modifications made “live” during the use of this page. See section 5.C.2.

### Example :

The artist suddenly decides to change the running order, and jump from song 3 (page 3) to song 7 (page 7). If you used the **Next** function, you would pass successively to page 4, then 5, then 6 and finally arrive at 7! A tedious and potentially noisy procedure! In this particular case, the **Goto** function can be used to flip directly from 3 to 7 without any surprises. Just press the [GOTO] button, select page 7 and confirm with [OK].

## 5.E Automation (calling up and chaining pages)



The Sy80 provides a function to call up pages from MIDI Program Changes (IN), and can be programmed to send MIDI Program Changes (OUT). Furthermore, Sensoft has a facility to program a chain of pages with, between every page, the possibility of programming the transition time (CROSSFADE) and links to the following pages.

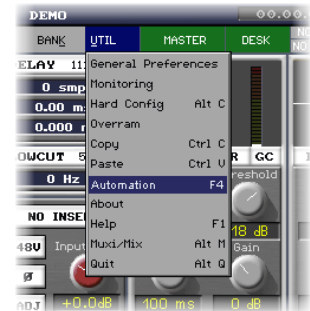

All these functions are handled by a single AUTOMATION window, which is accessible via the **[AUTO]** button on the console, **[F4]** on the keyboard, or via the **[Automation]** entry in the *UTIL* menu.

### 5.E.1 General points

In this window, all selections are made using the keyboard and/or the trackball. As soon as you select a cell to type in, a cursor appears inside it. To cancel a data entry, press the **[Esc]** key. All data entries must be confirmed by the keyboard **[Enter]** key.

### 5.E.2 Sending MIDI Program Changes

When a page is changed, it's possible to send a MIDI Program Change, so that MIDI devices connected to the console may have their program number automatically updated, according to the current Sensoft page. This is the very first action that the console takes when you change a page, even before it modifies its parameter settings.

Managing the sending of Program Changes is carried out on the internal grid of the AUTOMATION window. This presents, in columns, sixteen MIDI channels numbered from 1 to 16. These can be labeled (4 characters each) so you can identify a device by its name rather than by its channel number. Page names are displayed in a scrolling list to the left, and the selected page is highlighted with a blue band.

The AUTOMATION window

The screenshot shows the AUTOMATION window with several key sections:

- MIDI TIME CODE:** Includes checkboxes for Play and Record, and an OFFSET field.
- MIDI PROGRAM CHANGE:** Divided into IN and OUT sections, each with an **Enable** checkbox.
- CROSSFADE:** A vertical column on the right for programming crossfade times.
- Grid:** A large grid with columns for Channels (ch01 to ch16) and rows for console pages (DEMO1 to TEST). It contains numerical values like 12, 23, 1, 10, 22, and 23.

Callouts provide the following descriptions:

- Section for programming automation indexed to MIDI TIME CODE** (points to the MIDI TIME CODE section).
- Activation of MIDI transmit and receive data (IN and OUT)** (points to the Enable checkboxes).
- Programming of crossfade times between pages and automatic chaining** (points to the CROSSFADE column).
- Area for programming the relationship between console pages and MIDI program changes, transmitted by the console on each channel** (points to the grid).
- Area for programming the relationship between console pages and MIDI program changes coming from an external device, in order to drive the console** (points to the grid).

To define Program Changes transmitted by the console, proceed as follows:

- Select the page that will send the program changes, by using the track-ball or the cursor keys on the keyboard
- Left-click in the column of the desired channel, and type in the value of the program change (from 0 to 127)
- Confirm with the [Enter] key on the keyboard. If a value is erroneous, a dialog box will warn you.



Don't forget to activate MIDI "OUT" by checking the corresponding **[Enable]** box at the top of the AUTOMATION window, or by typing [ALT] + [Y] in the main Mix window.

**To label a channel:**

- Click on the cell of the desired channel (below the channel numbering)
- Type in the required label (4 characters)
- Confirm the data entry with the [Enter] key on the keyboard.

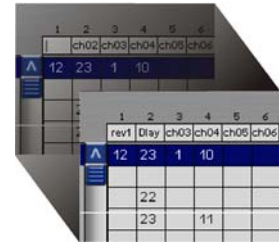
**5.E.3 Receiving MIDI Program Changes**

PGM	CH	
		DEMO1
1	2	DEMO2
2	2	DEMO3
3	2	DEMO4
4	2	D6DF
		D6D6
		DEMO6

In the same way as the console can control external devices, external devices can also control console page changes. Yes, you can activate a page change by specifying a MIDI Program Change in Sensoft's AUTOMATION window.

**To define Program Changes associated to page changes, proceed as follows:**

- Select the page that you intend to be loaded by a command issued from the external device, by using the track-ball or the cursor keys on the keyboard
- Click in the associated cell, to select the Program Change number (from 0 to 127) that will command this page change, and enter the value from the keyboard
- Press the [TAB] key on the keyboard to confirm the data entry, and pass to the choice of channel. If the Program Change number value is erroneous, a dialog will appear
- Enter the correct MIDI channel by typing its value (from 1 to 16) on the keyboard. Confirm with [Enter].
- It's done! When the device sends this Program Change on the specified channel, the complete InnovaSON system will update according to the parameters of the corresponding page.

**Calling up a page by MIDI Program Change is the same as:**

- Pressing the [NEXT] button if the selected page is immediately after the current page, in which case any possible programmed transition time (Crossfade) will be taken into account
- Or otherwise a [GOTO].

In other words, in the first case ([NEXT]), the change will activate the automation ("Crossfade") while in the second, the console will go directly to the page without any transition time.



Do not forget to activate MIDI "IN" by checking the corresponding [Enable] box at the top of the AUTOMATION window, or by typing [ALT] + [X] in the main Mix window.

### 5.E.4 Automation synchronized to MIDI Time Code

When a device generating MTC (MIDI Time Code) is connected to the console, it's possible to synchronize page changes to different MTC addresses.

A permanent MTC display is provided in the bar at the top of all Sensoft windows. As soon as MTC data appears at the console's MIDI IN connector, it is decoded and displayed.

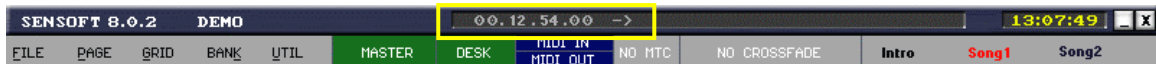

There are three modes of operation for MTC:

- **No option:** the MTC reading is shown in gray but has no influence on the console. Useful when you just want to monitor MTC, directly on the screen.
- **PLAY:** the MTC is shown in yellow, and activates page changes to recorded events; this is the mode to use for a synchronized spectacle.
- **RECORD:** the MTC is shown in red. This is the mode for use during rehearsals, when you are setting up for the event. It allows MTC events to be saved on the fly, during the run through.



#### Setting the MTC offset

There are two parameters relating to the MTC offset:

- Its sign +/-
- Its value. This is the absolute difference between the MTC value entering the console (generated by an external device) and the value displayed and taken into account by Sensoft.

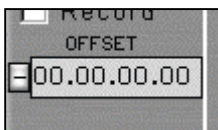

These two parameters live in the AUTOMATION window. The +/- sign changes by clicking on it; the offset value must be typed in from the keyboard (with respect to the format indicated below), once you have clicked in the cell.

Timecode entries must be made in the form HH:MM:SS:FF

- HH = hours, ranging from 00 to 23
- MM = minutes, ranging from 00 to 59
- SS = seconds, ranging from 00 to 59
- FF = frames, ranging from 00 to 29



**Programming:**

There are two possible ways you can program a change of page by MTC. The first way requires you type in timecode values manually. It's possible that you know the exact values, in which case you can simply enter them directly into the grid or, if you don't know them exactly, enter them roughly (on the fly), then tidy them up in a second pass.

HH:MM:SS.FF	PGM	CH
00.00.00.00		INTRO
		Song1
HH:MM:SS.FF	PGM	CH
06.23.00.00		INTRO
06.26.45.00		Song1
06.30.12.00		Dance
06.34.10.00		PB1

**Here is the procedure for manual timecode entry:**

- Access the AUTOMATION grid via the [F4] key or the *UTIL* menu
- Select the first page (in chronological order) using the keyboard cursor keys or the track-ball
- Click on the MTC cell and enter the MTC value
- Confirm with the keyboard's [Enter] key
- Repeat for each of the pages to be programmed.

**Here is the procedure for timecode entry "on the fly":**

- Make all the necessary connections, and verify that you are receiving valid MTC by starting the MTC generator, and verifying that the MTC value displayed by Sensoft is identical to that on the MTC generator. If the values are different, check to see if there is an offset in place. If the values are identical, everything is OK. Stop the generator – now you can start the timecode capture procedure...
- Select the page preceding the first automatic change, ie. page 1.
- From the main Mix window, activate "RECORD" mode by pressing [ALT] + [J] on the keyboard; the MTC display reading turns red.
- Start the MTC generator – the run through begins!
- Press the [NEXT] button on the console when the change of page has to take place; you will now be on page 2. Let the MTC run and repeat the operation (press [NEXT]) for the subsequent pages.
- If one or several pages have to be manually changed during the show, it's pointless pressing on [NEXT] for them, as this would capture an unwanted timecode that you have to erase later. To change the page in this case, use the [GOTO] function to jump to the next page for which you again want to capture a timecode value.
- Let the MTC run, and continue to use [NEXT] to capture timecodes for the following pages.
- Quit "RECORD" mode by pressing [ALT] + [J] again. This will cancel the [NEXT] function and the timecode capture mode.

Now that you have a good basis to work from, you can put the finishing touches to the timecode values by following the manual timecode entry procedure, described previously.



The MTC for a page must have a higher value than that of the MTC for the previous page, and a lower value than the MTC for the following page. Any newly created page will have, by default, its MTC set to OFF.

**In use:**



Once timecodes have been entered on the “Automation” grid, just select “PLAY” mode and feed the MTC to the console. The pages will flip at the programmed times.

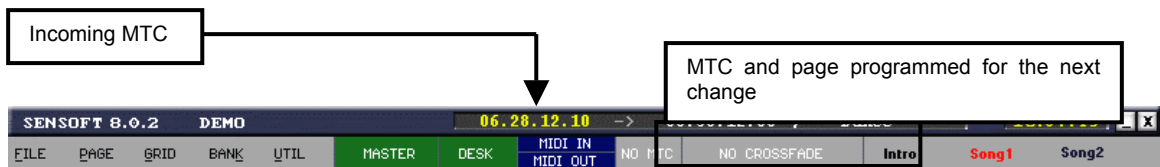

**5.E.5 Crossfade**

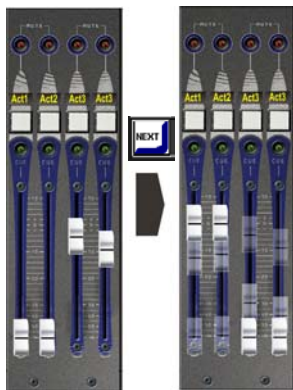

As you saw previously, Sensoft pages are in a sense “snapshots” of **ALL** the console parameters. So if you want to compose a “movement in sound”, you must first define an initial state (the start page) and then a final state (the end page). Of course, you can create as many intermediate pages as you want, to introduce various stages during the movement. Finally, an important parameter that remains to be defined for your movement is the transition time between every page.

Thus Sensoft allows you (from the AUTOMATION grid) to define automatically chained pages, with the essential possibility of defining the “morphing” time between each page in the chain.

The window below will help you understand the ease with which it is possible to program different chains:

The screenshot shows the 'MIDI PROGRAM CHANGE OUT' window. It features a table with columns for channels (ch01 to ch16) and rows for pages (Intro, Act1, Video, Song1, Act2, Video, Plane, Act3, End). The 'Intro' page is selected, showing MIDI Program Change values: ch01:12, ch02:23, ch03:1, ch04:10. To the right is the 'CROSSFADE' control panel, which includes an 'Enable' checkbox, a 'TIME' column with values (005.0, 003.0, 010.0, 001.0, 007.0, 015.0), and a 'CHAIN' column with buttons labeled 'CHAIN' and 'STOP'. Two callout boxes provide additional information: one points to the 'CROSSFADE' section stating 'Transition time between pages in seconds. You can enter a value between 0.1 and 999 seconds', and another points to the 'CHAIN' buttons stating 'Action after the transition : CHAIN : the following transition is automatically started STOP: the automation is stopped until the next [NEXT]'.

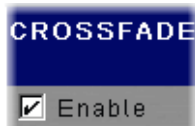

So that the chained pages take crossfades into account, do not forget to activate the **Crossfade** function by checking the corresponding **Enable** box in the “Automation” window, or by typing [ALT]+ [D] in the main Mix window. So when you are on the first page, pressing the **[NEXT]** button on the console will activate a fade of all the parameters of the first page to the second page, over the defined time. Having arrived on the second page, the fade from this page to the third will begin at the next defined time. This way you achieve your “movement in sound” thanks to the progressive “morphing” that is made between the chained pages.

The start of a crossfade is made by one press of the **[NEXT]** button on the console, the **[UP PAGE]** key on the keyboard, the calling of a page by a MIDI Program Change entry, or the arrival of a valid MTC value when synchronized programming has been launched.

**The sequence thus activated is as follows:**

- Programmed MIDI Program Changes are transmitted by the console
- Audio remote control data is sent to the audio racks throughout the programmed sequence, and the changes are displayed in real time on the main Mix window.
- At the end of the sequence, the console’s motorized faders are updated according to the parameters of the final page.

### 5.E.6 The Cross Time fader



This very special fader enables manual intervention on the previously programmed fade times (your crossfades). The fader has no effect on crossfades when it's at its halfway mark (default position). By raising the fader, the fade time will grow shorter until it reaches a point where there is almost a direct switch to the following page (as in [NEXT]). On the other hand, by pulling the fader below the default position, the programmed time will be extended until (at the bottom of the fader) "the film" stops, on the last current frame (page).

This exclusive InnovaSON feature allows you to manually control the previously programmed fades, and adapt them to the demands of live sound!

#### What happens on the screen?



First of all, note that this fader is not represented on the screen. On the other hand, a small area is dedicated to it in the center of the information bar; when deactivated this displays **NO CROSSFADE**.

If the crossfade is active, this zone becomes blue and shows two values:

- Speed n.nn: this is governed by the physical position of the "Cross Time Fader", and is expressed in a coefficient going from 0 (at the top) to infinity (at the bottom), and passing through 1 (the half way default position where speed = 1.00, ie. the value that adheres to the programmed fade time).
- Time n.n: the automatically calculated transition time in seconds, taking into account the programmed value and the position of the "Cross Time Fader".

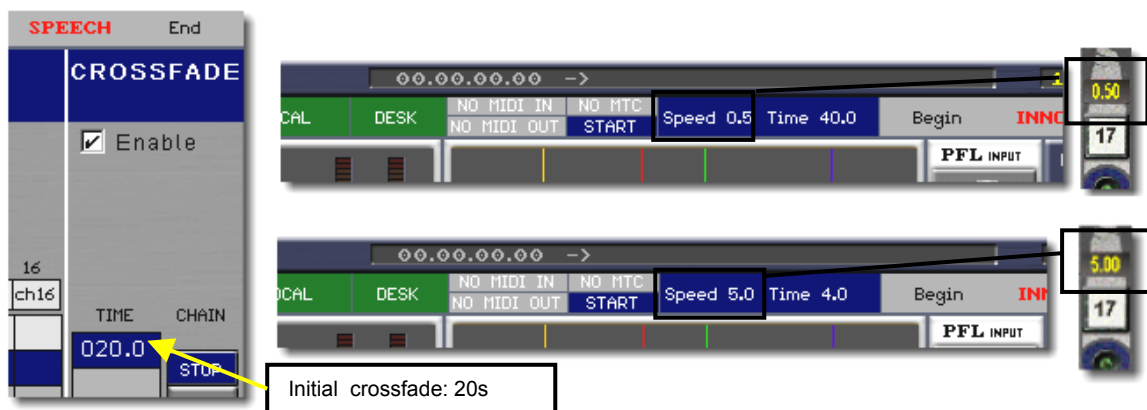

The example above shows that, for an initial crossfade time of 20 seconds, programmed on the "Automation" grid, the position of the **Cross Time Fader**, at a value of **0.50**, will extend this time to 40s (initial time ÷ value of the Cross Time Fader, or 20s ÷ 0.5 = 40s). Similarly, for a position value of **5.00**, the programmed time will be reduced to 20 ÷ 5 = 4s, ie. the time is 5 times faster.

When the fader is at the bottom of its travel, the display will show “+INF”, which corresponds to a “full stop” pause. As for the console parameters, the actual crossfade is displayed in real time. When the crossfade area of the screen flashes, it means that a crossfade is currently being executed. All the changes will be visible on the screen, but the control surface faders do not move. They keep their latest position before the start of the crossfade, and will only update at the end of the process, priority being given to the audio changes.

**How do I create a Cross Time Fader?**

The assignment of the “Cross Time” function to one of the console faders is, not surprisingly, made in the Hardware Configuration window, selected by typing [ALT] + [C]. Simply select the chosen fader and validate a patch point on the assignment line named **Crossfade**, as shown in the illustration below:

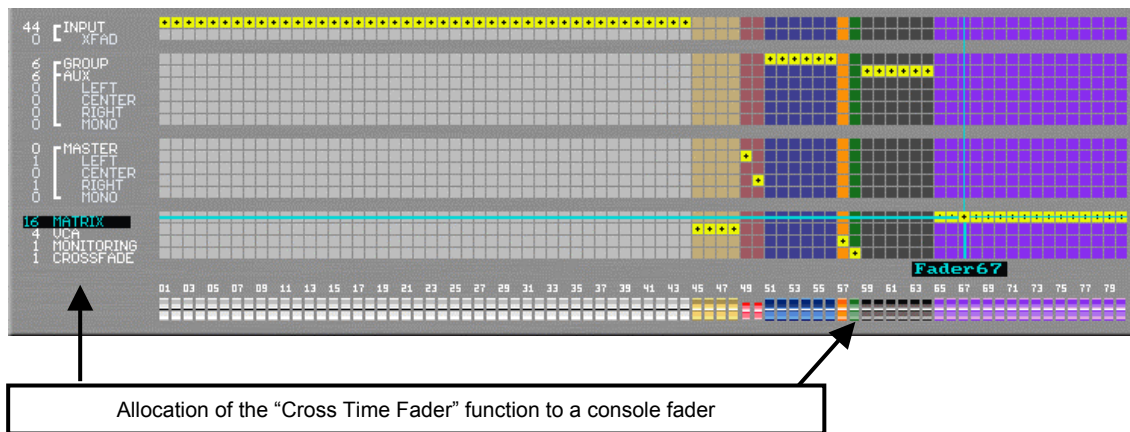



## 6 ADVANCED FUNCTIONS

### 6.A Generator and oscillator

The console is equipped with a white and pink noise generator, as well as a variable frequency oscillator. When assigned to an input channel the generator takes the place of any signal that was previously allocated to this channel.

To use this function, select the channel to which the generator will be assigned, and press the **[TEST]** key on the console – which illuminates, or the [o] key on the keyboard. A window (see right) allows you to configure the signal generator, and turn it on.





When the channel is selected, the on-screen section indicating the channel label and patch (signal source) now shows “OSCILLATOR” in red text, and the console’s **[TEST]** button is illuminated. The oscillator level is -8 dBfs, and its frequency is adjustable from 16Hz to 16kHz, in steps of 1/20 octave. Press **[TEST]** or [o] again to deactivate the generator.

### 6.B The Flat Function for resetting parameters



The **Flat** function allows you to reset channel parameters (Gate, Compressor, EQ) to their default values:

- Select the channel to be reset.
- Press the **[FLAT]** button on the console, which lights up. The FLAT window appears (see above).
- Select the parameters that you wish to reset on the channel by using the console buttons, or the on-screen checkboxes and the trackball.
- Press the  key to confirm the reset or  to cancel.

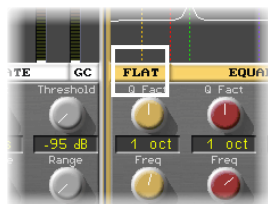

The **Flat** function can also be enabled by the mouse, by clicking on FLAT in the “EQ” frame of the main Mix window.



Resetting the processing by means of the **Flat** function is immediate and irreversible, unless you reload the page.

### 6.C COPY and PASTE

These functions allows you to copy ([COPY]) the settings of one channel, and then apply them to another ([PASTE]). Simply select a channel ([SELECT]) and press the [COPY] button on the console to copy all the channel parameters into a temporary area of the Sensoft memory. A window appears indicating that the copy has been made successfully.



To apply the channel settings, press the [PASTE] button; this displays a window where you can choose one or several destination channels, as well as the parameters to be applied:

The parameters in memory (from the last COPY action) are those from the spread input named BD1

This area allows you to choose which parameters will be updated on the selected channels

These two buttons allow you to select or deselect all the parameters with one click

The destination channels are indicated in yellow ; in this case it's two inputs spread from Input 02

The screenshot shows a window titled "Paste deployment BD1" with a "Preferences" section containing various checkboxes. The "SELECT ALL" and "UNSELECT ALL" buttons are located below the preferences. At the bottom, there are "CANCEL" and "PASTE" buttons. A trackball is visible at the bottom of the window, and a callout points to it with the text "The destination channels are indicated in yellow ; in this case it's two inputs spread from Input 02".

Select the destination channels by means of the trackball, or directly, by using the channel [SELECT] buttons on the console. If required, you can first select an Input channel to spread it, then select one or more of its XFAD channels. The same is true for XBUS channels. Once you have set up your chosen parameters in this window, press the key to confirm them or to cancel. Note that, once carried out, the **Paste** function is irreversible in RAM.



## 6.D OverRam – Updating pages in RAM



**OverRam** has been, from the beginning, a key feature of InnovaSON consoles. This function allows you, when a parameter needs to be adjusted during an event, to update that parameter for all the pages to come in the current event.

If, for example, at the beginning of a show, you realize that an instrument is too low in the mix, you simply raise the level of the fader for this instrument. But, at the next change of page, the fader of the instrument in question will be repositioned at the lower value, as it was for the start of the show. This is where the **OverRam** function comes into play. When the instrument fader is adjusted, **OverRam** updates all the pages in RAM with this new fader position, for the rest of the show.



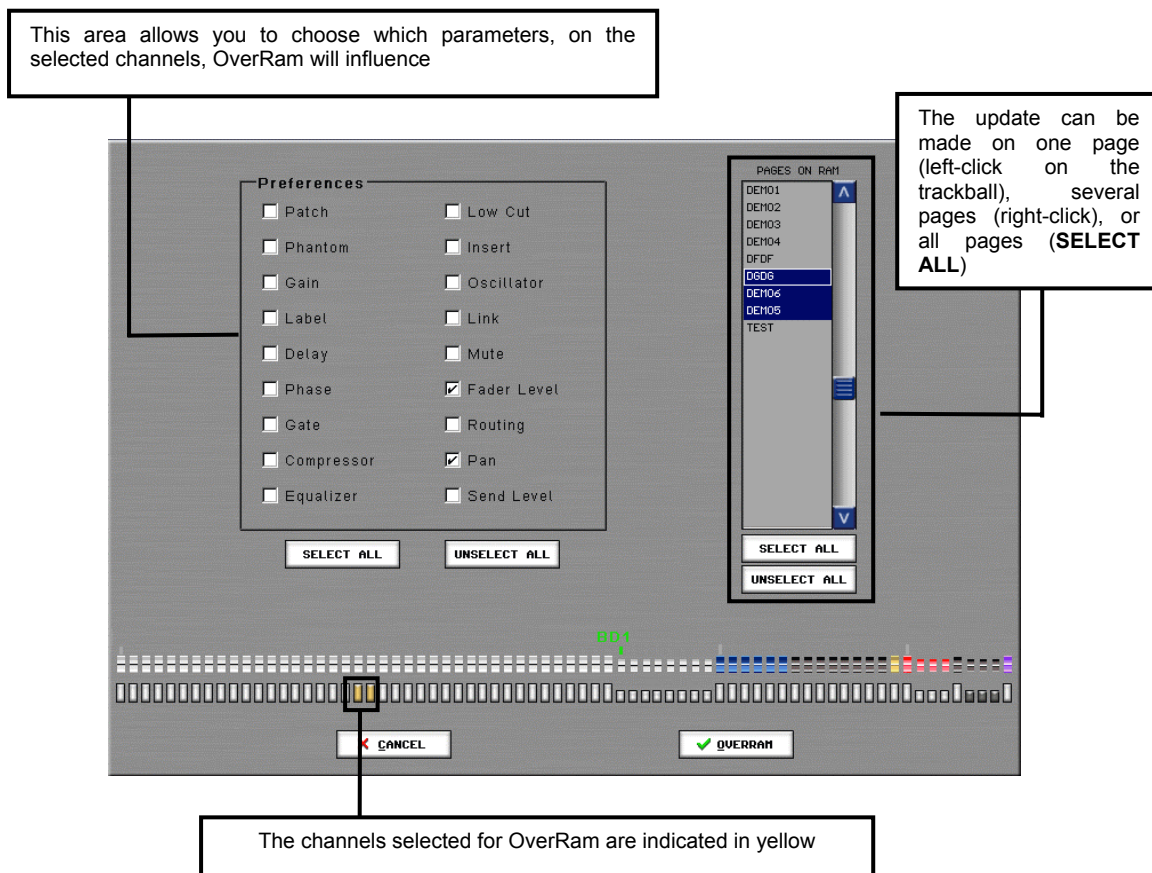

**Parameters are updated according to their absolute values**

When you press the [**OVER RAM**] button on the console, the following window appears:



Select channels for the **OverRam** function by means of the trackball, or directly, by pressing the channel [**SELECT**] buttons on the console. If required, you can first select an Input channel to spread it, then select one or more of its XFAD channels. The same is true for XBUS channels.

Once you have set up the required parameters in this window, press the  key to confirm or  to cancel. Note that, once carried out, the OverRam function is irreversible.



As its name implies, **OverRam** only updates the parameters of pages in RAM. So, if you call up a page with the **Load** function, that page will be loaded without taking into account any possible change of parameters generated by various **OverRam** actions since the beginning of the show..... Unless you make a **File/Save** after every **OverRam**.

## 6.E Relax Mode – disconnecting parameters from the automation



Once again, here is a key Sensoft feature that has, from the beginning, forged the strength of InnovaSON consoles.

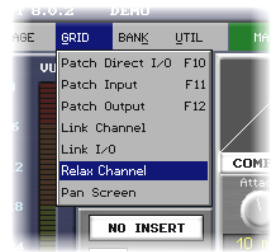

This function allows you to “disconnect” the parameters, of one or several channels, from the automation; the parameters of channels thus “relaxed” become manual. From now on, whenever you change a page, by any command, it has no effect on the “relaxed” parameters.

An assignment grid for channels and parameters is accessible by pressing the **[RELAX]** button on the console, or by selecting the **Relax Channel** function in the *GRID* menu; the **[RELAX]** button on the console will light up.

The assignment grid in RELAX mode looks just like a patch grid and, as expected with this type of grid, all you need to do is make a channel correspond with a parameter, then create a “patch” point ([SPACE BAR], right-click, etc.) to assign the desired function.

List of parameters that can, for each channel, be “Relaxed”. A “patch” on the ALL line “Relaxes” all the channel parameters with one click

On channel 3, the I/O parameters (Gain et 48V), as well as the fader level, are “Relaxed”

Select the channels you want to “Relax” by using the channel **[SELECT]** buttons on the console. If required, you can first select an Input channel to spread it, then select one or more of its XFAD channels. The same is true for XBUS.

Once the parameters are set, press [ESC] on the keyboard, or the **[RELAX]** button on the console, to quit the window. The **[RELAX]** button lights up as soon as a channel with “Relaxed” parameters is selected.



Settings on the “Relaxed parameter” assignment grid are valid for the complete file.

## 6.F Link I/O – Input/Output parameter links

### 6.F.1 What are I/O parameters?

The I/O (Input/Output) parameters are those relating to the modules fitted in the console's audio racks. They are in contrast to the channel parameters which emanate from calculations in the DSP module, and depend on the assignment of signals to console channels.



For input modules, these parameters are:

- Gain
- Phantom power (not applicable to digital modules).

For output modules equipped with the Hyperdrive option (XO-8D, DO-8X), these parameters are:

- Gain (maximum output level)
- Delay
- Noise gate
- Compressor
- 8-band parametric equalizer
- Mute

For output modules without the Hyperdrive option (MO-8D), the sole parameter is:

- Mute



**Note:** I/O links are relative. That is to say, a gain change from 0dB to +3dB will have the effect, not to place the linked gains at +3dB, but to add 3dB to the value that the gains had before the change.

### 6.F.2 The Link I/O grid

The [Link I/O] button on the console, or the **Link I/O** function in the **GRID** menu, calls up the grid where you can set up I/O links. It appears as follows:

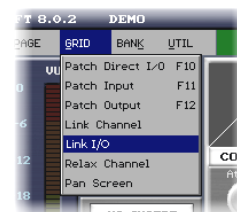

Link zone for inputs. The columns allow you to link inputs to each other. For example, InC1 is linked to InC2

Link zone for outputs

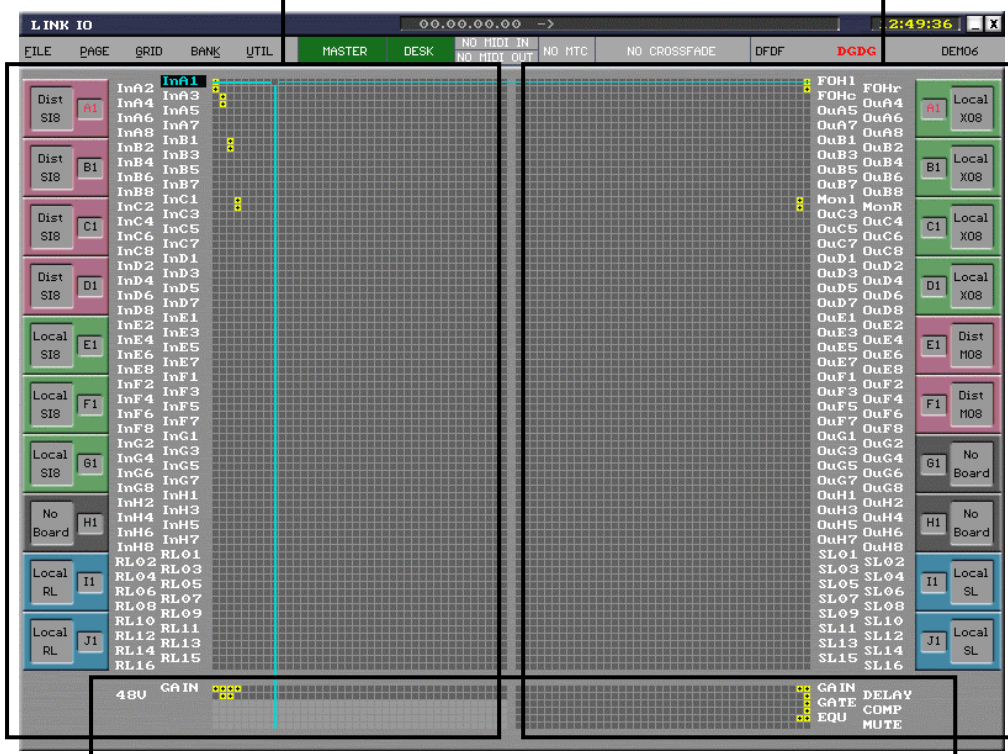

This area allows, for each Link level, the linked parameters to be defined

The **Link I/O** grid looks just like a patch grid and, as in all grids of this style, all you need to do is make a line correspond with a column, then create a “patch” point ([SPACE BAR], right-click, etc.) to assign the desired function. The columns of the grid represent the link levels; I/Os “patched” on the same level are thus linked together.

## 6.G Link Channel – channel parameter links

### 6.G.1 What are the channel parameters?

The channel parameters are the values given to the DSP module, via Sensoft, for the calculation of processing for filtering, equalization, dynamics, levels to busses, etc. They are in contrast to the I/O parameters, which are not calculated by the DSP module, but by the input/output module.

When Sensoft and the Sy80 DSP module, in the next software version, will be able to process busses, the parameters associated with these busses will be channel parameters. So it will be possible to equalize an Aux, via the Sy80 DSP module, and to patch it to a MO-8D module (which has no Hyperdrive option).

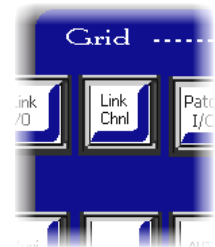

Currently this operation is only possible by assigning the Aux bus to an XO-8D output, which has its own DSP (Hyperdrive), and therefore its own I/O parameters. The drawing below shows the parameters relating to I/O modules (I/O parameters), and those managed by the DSP module (channels parameters).

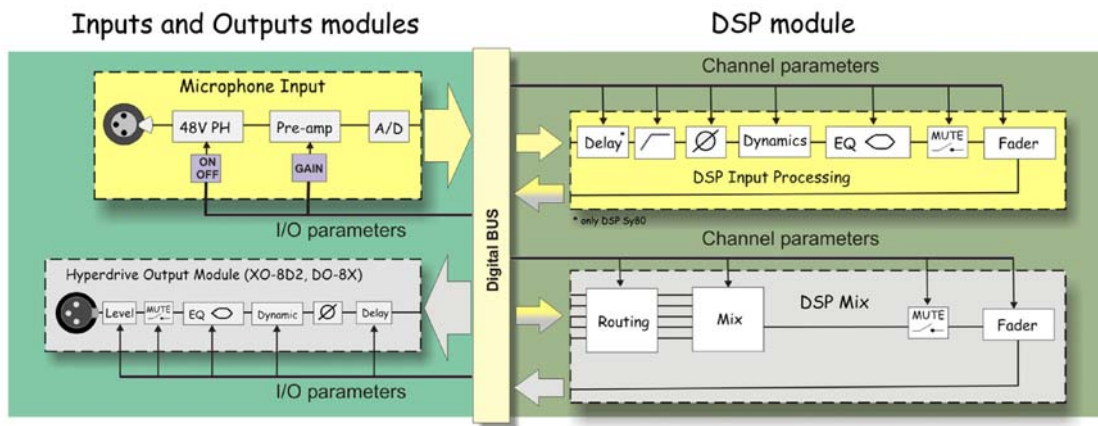

### 6.G.2 The Channel link grid

The [Link Chnl] button on the console, or the **Link Channel** function in the **GRID** menu calls up the grid allowing you to link channel parameters. The grid will look similar to this:

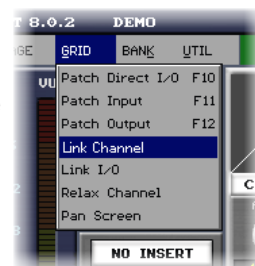

This area allows you, for each Link level, to define the DSP parameters to be linked

Different link levels can be set up in the same spread zone

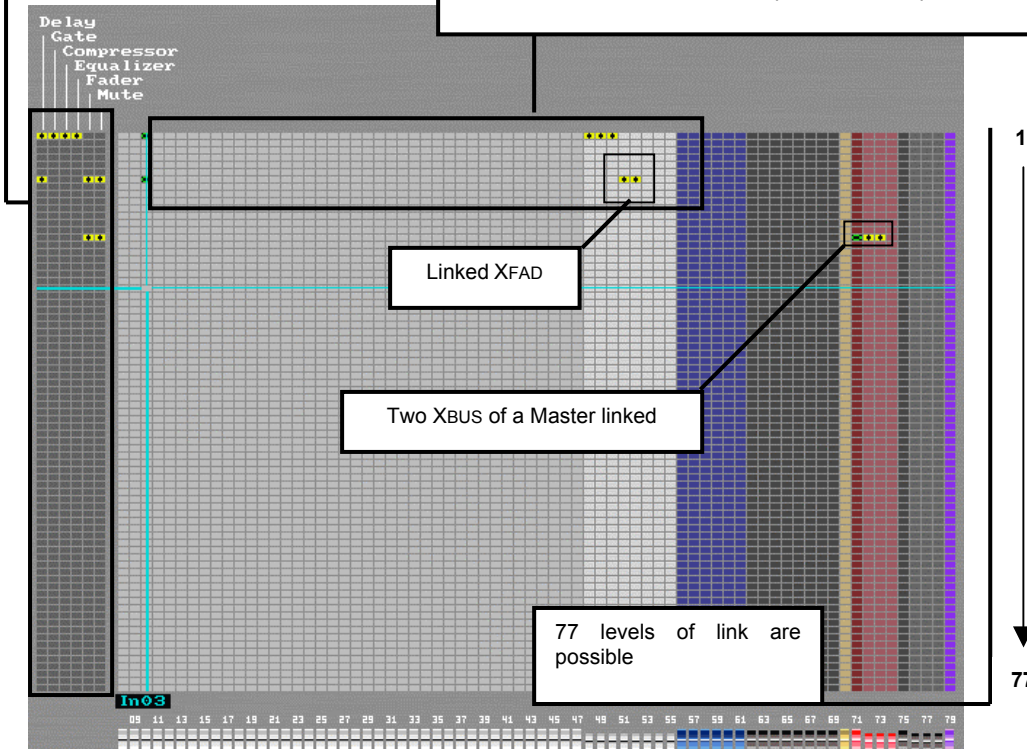

The XFAD or XBUS control channels may only have their faders and mutes linked together. To link XFAD or XBUS processing, you must first select the master channel concerned to spread it, and you'll then have access to the XFAD or XBUS channels individually.

The **Link Channel** grid looks just like a patch grid and, as with all grids of this style, all you need to do is make a line correspond with a column, then create a "patch" point ([SPACE BAR], right-click, etc.) to assign the desired function.



**Note:** the links between channels are relative. For example, a change of EQ level from -8 to -4 dB will have the effect, not to set the linked EQs to -4 dB, but to add 4 dB to the value they had before the change.

## 6.H Fast and temporary cancellation of a link

Although channel and/or I/O parameters may be linked, it can be useful to act occasionally on a parameter in the balance, without modifying any other channels. Of course, you could go to one or other of the link grids to cancel the link, but that would be tedious if you only wanted to increase the gain of an EQ band by 4dB.

There is, therefore, a procedure allowing you to modify a parameter without adjusting the same parameter on the other linked channels, provided that the channel in question is allocated to a channel on the console. This procedure, illustrated in the following figure, consists simply of pressing and holding the **[SELECT]** button of the channel that you want to disconnect from the link, while you adjust the now individual parameter. Neat huh?

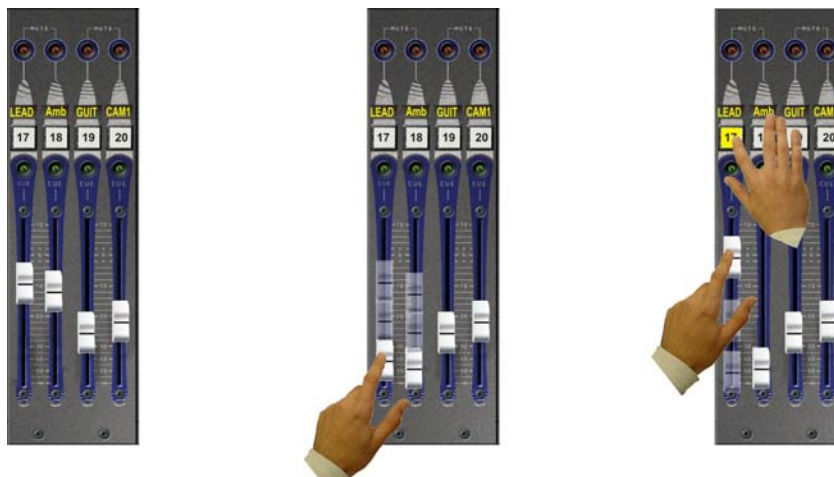

Assuming that channels 17 and 18 have been "linked":  
Fader, mute, gain, ...

Moving fader 17 is immediately reflected on fader 18

On the other hand, if you hold down the **[SELECT]** button on 17, the link is broken, and fader 18 is no longer a slave

The example above is valid for all the parameters in a link. So to modify the equalizer of a linked channel, simply press and hold the **[SELECT]** button on this channel while you modify its equalizer. No other channel will be modified by the actions made on this one.

## 6.1 The MUXI Window – display and modification of outputs

The **MUXI** window allows you see quickly, and in one view, the state of all the Muxipaire physical outputs (ie. all the audio racks). This window, which is full of information, also allows you to adjust the Hyperdrive parameters and Mute of outputs that are not patched to console channels. It is, for example, thanks to this window, that you can adjust the equalizer or delay for the monitoring, when it's patched to a Hyperdrive output. Also in this window you can mute one of the outputs patched to the same bus (ie. a bus split over several outputs). Finally, when a DIRECT I/O patch point or an Insert Send needs to be modified, the MUXI window allow you to access the Mute and Hyperdrive parameters at this point.

As shown in the illustration below, Muxipaire information only takes up the lower half of the screen. You exit this window by same method used to access it. Trackball and keyboard cursor keys allow you to select the output to be modified.

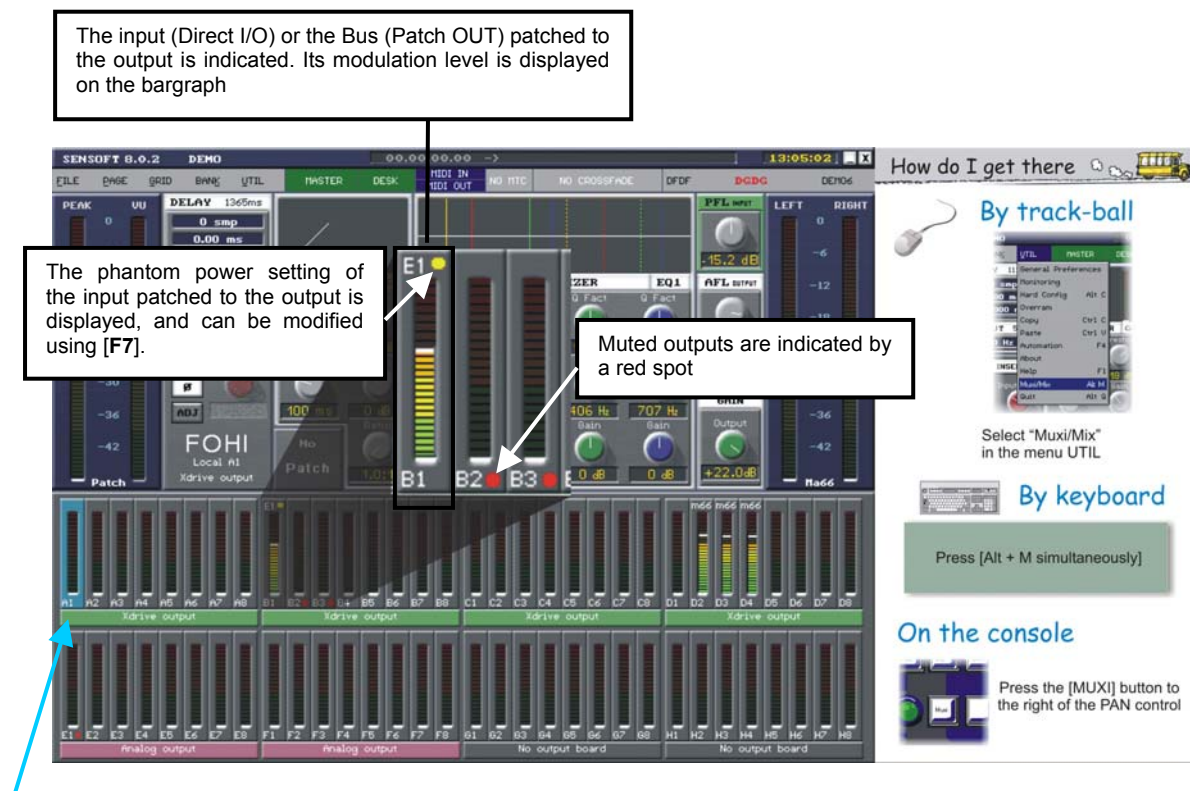

When an output is selected (framed in blue), the Hyperdrive processing settings become automatically available for this output in the upper half of the screen. The rotary gain control acts on a potential input patched to this output, the rotary **PAN** control allows you to adjust the maximum level of an output when it is equipped with Hyperdrive. [F8] allows you to mute or un-mute an output, [F7] controls the phantom power on an input patched directly to this output. When outputs are linked (Link I/O), any parameter modification in this window is echoed on the parameters of the other linked outputs.

It's possible to enter labels by pressing the [F3] key on the keyboard. If an output is patched directly to an input (Direct I/O), you will be asked to first label the input, then the output. In cases where an output is patched to a mix bus, it is only possible to modify the label of the output (4 characters maximum). [ALT] + [F3], for sequential labeling, are just as useful in this window.



## 6.J Off Line – disconnecting the console from the audio racks

This mode allows you to work on, or correct, a page of the current file, without affecting the current parameters. It is accessible by pressing the [OFF LINE] button on the console, or via the [ALT] + [O] keys on the keyboard.



Once active, a red **OFF LINE** alert appears at the top of the screen, and the [OFF LINE] button on the console lights up. You can now verify, modify, save, load, OverRam, copy, etc. any page in the current file without your actions affecting the audio.

**OFF LINE** mode instigates some display modifications:

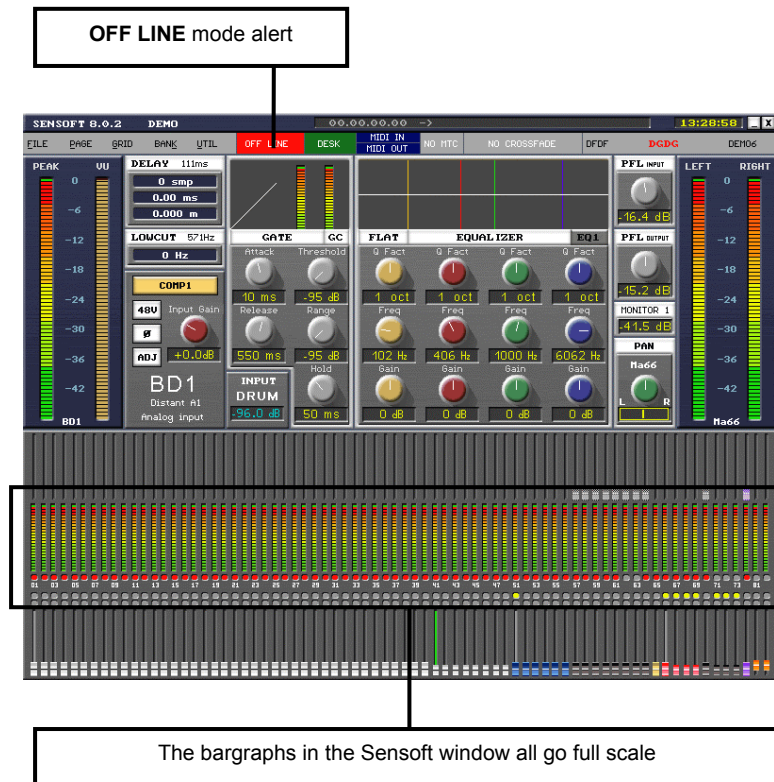

This mode is equivalent to disconnecting the computer from the audio racks. For this reason, the computer no longer exchanges information with the racks.

Exiting **OFF LINE** mode (press the [OFF LINE] button, or [ALT] + [O]) returns all the console parameters immediately to the same state they were in before entering this mode. The console is “reconnected”, and commands are once again sent in real time to the audio racks.

If the current page underwent modification in **OFF LINE** mode, the changes are taken into account when you exit the mode.

## 6.K Processing libraries

Having positioned a microphone X in front of the kick drum Y, you begin to compress, to equalize, in short, to adjust all the channel parameters. All of a sudden, you're bowled over by a "killer sound" – the kick of your dreams.....finally, you've found it! Joking aside, the processing library allows you to record the processing settings made on Hyperdrive inputs or outputs. These settings can then be recalled at any time on inputs, outputs, or the channels of your choice. It's even possible to export a processing library onto floppy disk, so you can importing it on another InnovaSON console.

### 6.K.1 The BANK Menu and general operation

The *BANK* menu provides access to all the library functions. You can **Save**, **Load**, **Delete**, and **Export** processing settings to a floppy disk, and **Import** them from floppy disk. See also section 8.C.

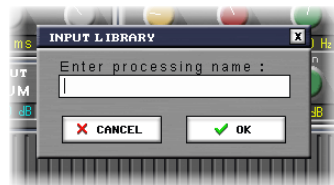

When a channel is selected, saving its processing settings ([**Save**]) opens a window inviting you to enter a name, for example "Kill BD" for these settings. All the processing settings on this channel will be saved under this name.

To apply the saved settings to another channel, select this channel and load the desired processing by selecting **Load**. The following window appears:

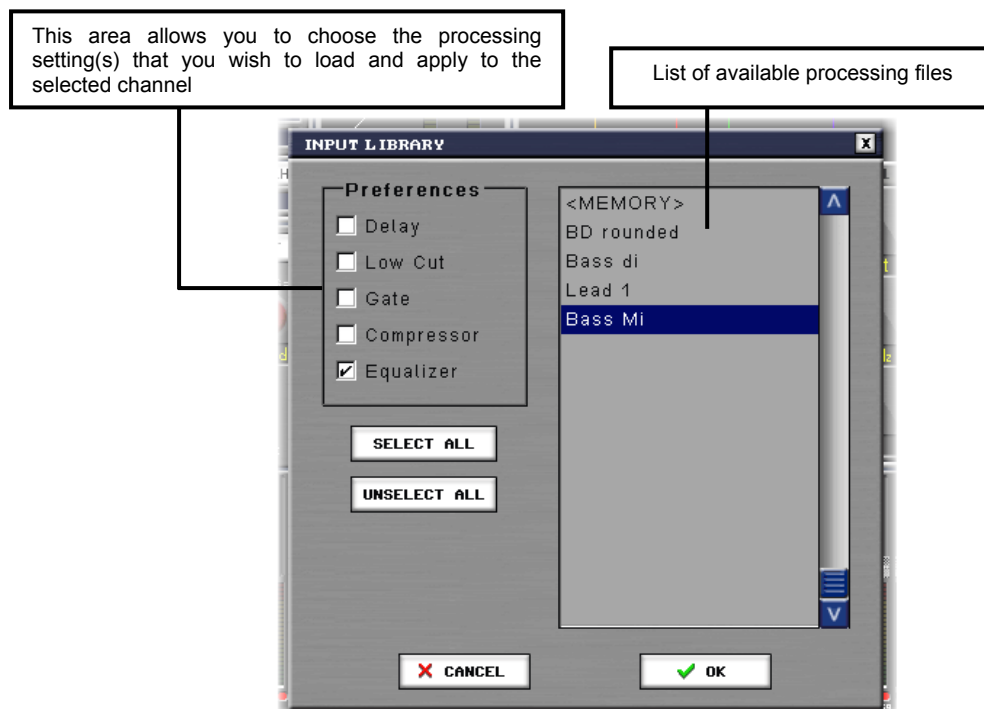

Using this window, you can easily choose to apply the "BASS Mi" equalizer settings to the currently selected channel.

### 6.K.2 Save and Load Shortcuts

Shortcuts, described in the figures below, allow you to quickly access the [Save] and [Load] functions from the *BANK* menu.



Holding down the [SELECT] button on the relevant channel, and pressing [SAVE] on the console's **DESK CONTROL** panel is equivalent to selecting **Save** in the **BANK** menu

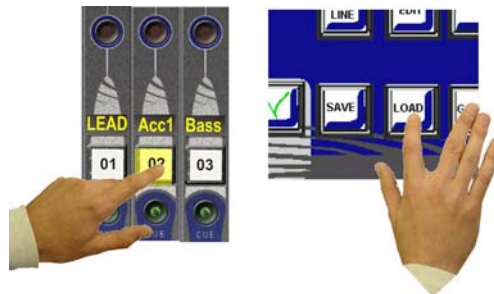







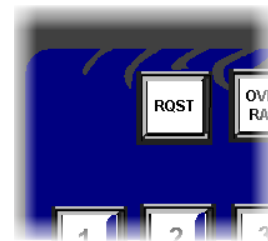

Holding down the [SELECT] button on the relevant channel, and pressing [LOAD] on the console's **DESK CONTROL** panel is equivalent to selecting **Load** in the **BANK** menu

### 6.L Request Mode (RQST)

**REQUEST** mode provides not only a quick display of the state of console functions, but also the ability to act on them. Pressing the [RQST] button produces a dialog box indicating the name of the function in hand. Press the button corresponding to the function you wish to control. According to whether the channel [SELECT] buttons on the console are lit or unlit, you can see if the displayed function is activated on that channel or not. You can activate or deactivate a function by pressing the channel [SELECT] button. The available functions are:



- ◆ +48 V (On/Off) \_\_\_\_\_ 
- ◆ Phase (On/Off) \_\_\_\_\_ 
- ◆ Low-pass Filter (On/Selection of frequency/Off) \_\_\_\_\_ 
- ◆ Gate (On/Off) \_\_\_\_\_ 
- ◆ Compressor (On/Off) \_\_\_\_\_ 
- ◆ Equalizer (On/Off) \_\_\_\_\_ 
- ◆ Oscillator (On/Off) \_\_\_\_\_ 
- ◆ LINK CHNL (On/Link level), press the button several times to change level \_\_\_\_\_ 

For example, when you select the 48V function (phantom power), the [SELECT] buttons on those channels on which the phantom power is active will be illuminated. Simply press the [SELECT] button of the channels on which you wish to activate/deactivate the phantom power.

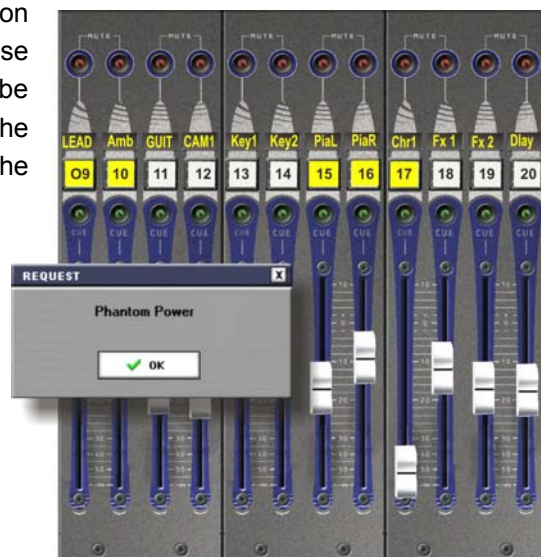

The **Low Cut** function can be interrogated in two steps:

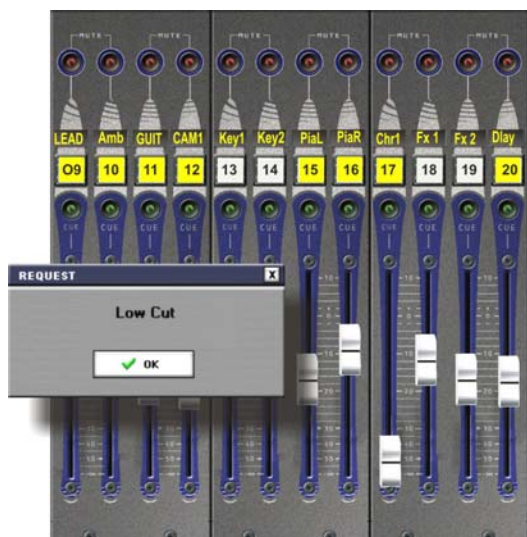

On the first press of [Low Cut], illuminated [SELECT] buttons indicate those channels whose Low Cut function is active

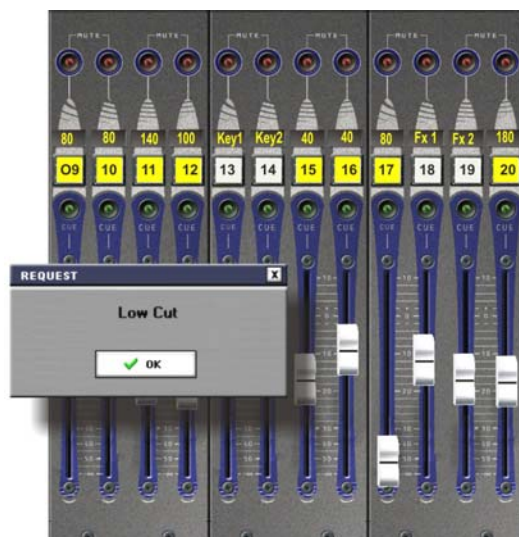

On the second press of [Low Cut], the labels of the channels on which Low Cut is active display the filter frequency. Successively pressing the [SELECT] button on those channels toggles the various possible filter frequencies

You can quit the **REQUEST** window by pressing the [RQST] button a second time, by clicking on , pressing [Esc] on the keyboard, or even by clicking on the cross in the top right hand corner of the window.

## 6.M The ADJ function – automatic adjustment of preamps



When started up, the audio racks reset their analog input module preamps to a gain value of 0dB. If the current Sensoft page is a blank new page, on which no patch or adjustments have been made, then there will be no remote control to update this gain value.

During this time, it's possible you may be on stage, setting up for the show, and beginning the physical patching of microphones and instruments to the distant rack. If, at the same time, the band are playing, it's possible that the preamps may start to overload, some of them may even be presented with a dangerously high signal, and need to have their gain decreased as quickly as possible.

It is here that the **ADJ** function comes into play. This automatically adjusts the gain of all the preamps so that the signal at each preamp output has a maximum value equal to that defined in the [**General Preferences**] menu. When the preamp gain is decreased, following an overshoot of this threshold value, the gain will never be increased again, whatever the level of the input signal. Indeed, for absolute safety, this function can decrease gains but never increase them.

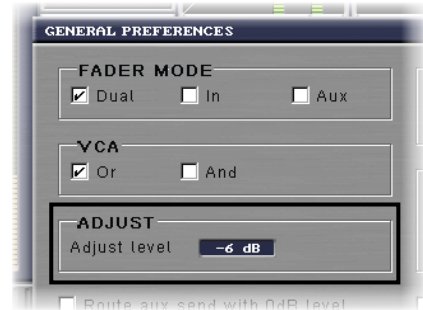

**Note:** activating the **ADJ** function on an input enables this function on all inputs. The **ADJ** function is global and cannot be selected for only one or several inputs.

## 6.N Sending MIDI messages using the [MUTE] buttons

Sensoft 8 allows to you to send **MIDI Control Change** messages by means of the **[MUTE]** buttons. Similarly, receiving the same Control Change information, via the MIDI IN connector on the console, will act on the **MUTE** of the channel corresponding to the MIDI control number programmed on the grid shown in the following screenshot.



MIDI Control Change to [MUTE] assignment grid

Selection of MIDI transmit and receive, and choice of MIDI channels

CONTROL CHANGE	Send channel	Receive channel
01	00	02
03	04	06
05	08	10
07	12	14
09	16	18
11	20	24
13	24	28
15	28	32
17	32	36
19	36	40
21	40	44
23	44	48
25	48	52
27	52	56
29	56	60
31	60	64
33	64	68
35	68	72
37	72	76
39	76	80
41	80	84
43	84	88
45	88	92
47	92	96
49	96	100
51	100	104
53	104	108
55	108	112
57	112	116
59	116	120
61	120	124
63	124	128
65	128	132
67	132	136
69	136	140
71	140	144
73	144	148
75	148	152
77	152	156
79	156	160

By track-ball

Select "Mute Midi Message" in the GRID menu

Control Change numbers

Channels ([MUTE] buttons)

The MUTE MIDI MESSAGE grid looks just like a patch grid and, as with all grids of this style, all you need to do is make a line correspond with a column, then create a "patch" point ([SPACE BAR], right-click, etc.) to assign the desired function.

Having set up the grid, every press on a **[MUTE]** button will have the effect of sending the value "0" when the **MUTE** is deselected and "127" when selected, for the corresponding controller number and MIDI channel chosen in the grid. When an external device sends the values "0" or "127" on the same controller number and MIDI channel as is programmed on the grid, it will act as the **Mute** function (On/Off) for the corresponding channel. Naturally, MIDI transmit/receive will only be active if the **Send** and **Receive** channel functions on the grid have their **Enable** boxes checked.

## 6.0 Sending Fader Start MIDI messages

This function allows **MIDI Note ON** and **Note OFF** messages to be sent when faders leave or regain their  $-\infty$  position. This allows, for example, a MIDI relay box to control the start/pause of CD players, VTRs, DATs, etc., from one or several console faders. InnovaSON recommend the 8-channel relay box manufactured by MIDI Solutions; if necessary, eight boxes can be linked together to control up to 64 relays. Contact our technical service department if you require further information on the MIDI Solutions unit.

The grid below allows you to assign MIDI note numbers to the required console faders:

The Fader Start Channel grid

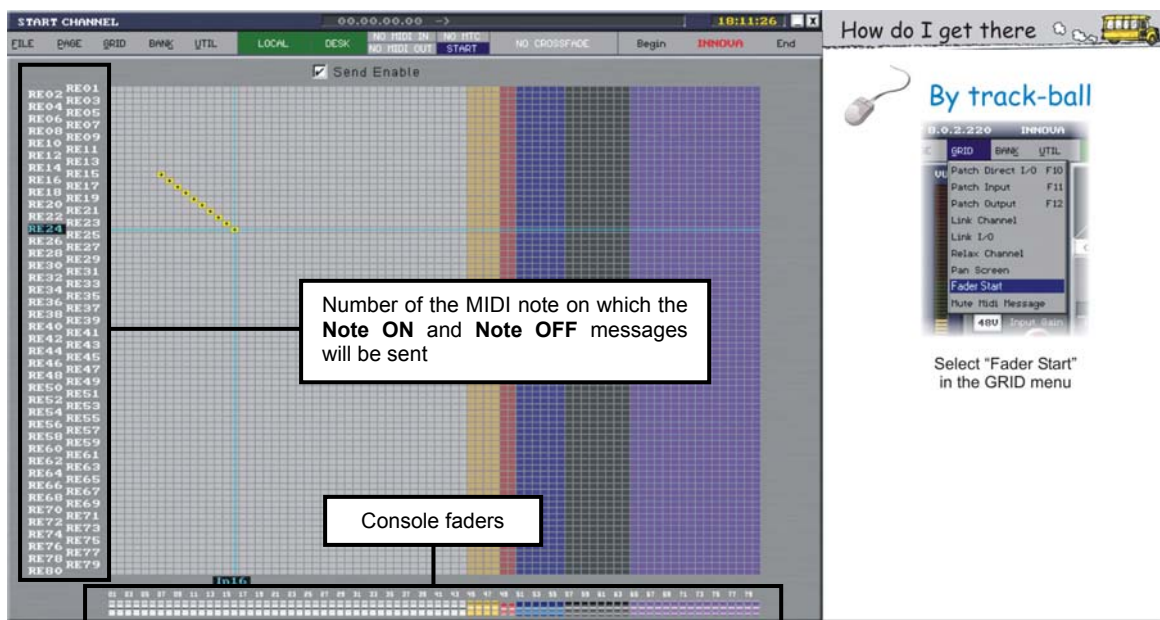

The FADER START CHANNEL grid looks just like a patch grid and, as with all grids of this style, all you need to do is make a line correspond with a column, then create a “patch” point ([SPACE BAR], right-click, etc.) to assign the desired function.

Having set up the grid, every time you move a fader off its  $-\infty$  position will have the effect of sending a “**Note ON**”, while moving a fader back to this position will send a “**Note OFF**” value to the corresponding note number and MIDI channel chosen on the grid.

This function is, of course, only active if the **Send Enable** box is checked on the grid.

### 6.P LOCK – Password Protection for the console

It is possible to protect the current work file from rewriting or deletion, and/or to protect the output processing against any accidental or voluntary modification. These two levels of protection are extremely useful when the console is being used at a festival, or in a situation where you are showing people around the console, or training them.



Implementation and parameter settings for the password protection are only accessible by selecting [Lock] in the *UTIL* menu; you cannot access this function via a shortcut or console button.

A dialog box similar to that described below appears, allowing you to select the required options:

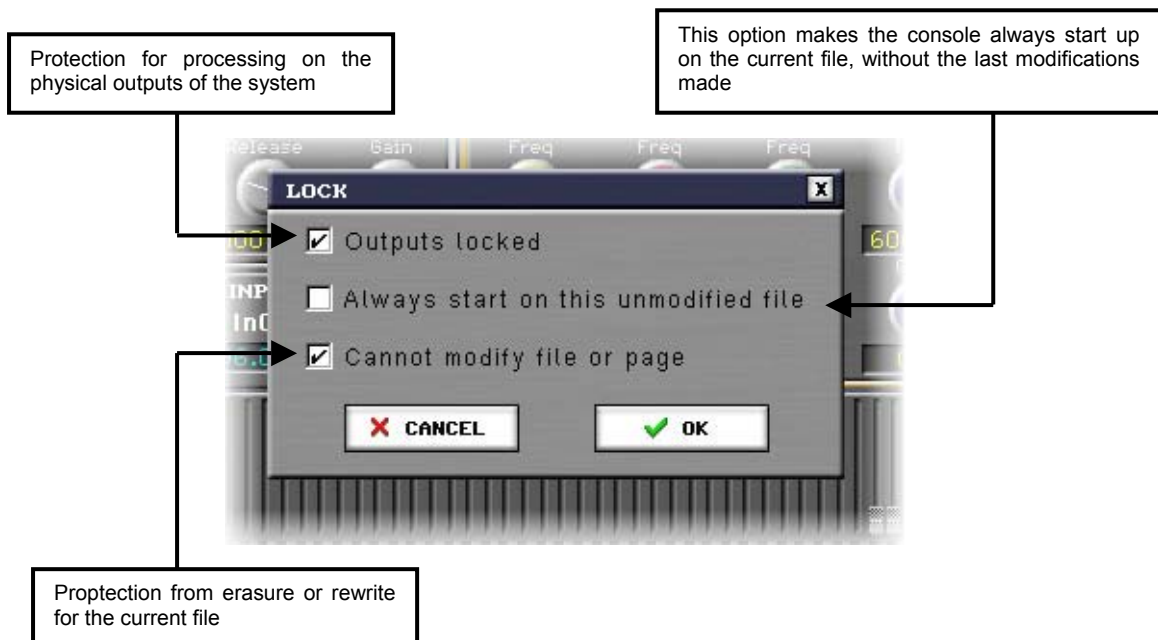



As soon as you confirm the **LOCK** options, another dialog box immediately appears, asking you to enter a password which will later allow you to lift the protection:

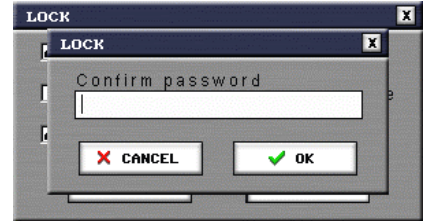
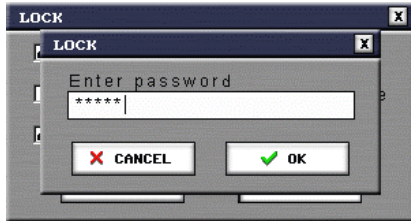

You are asked to enter the password, and then confirm it, to avoid any confusion from typing errors.

If modification of a protected function is attempted, a “**NOT AVAILABLE !**” message box appears, to warn the perpetrator of the impossibility of their action.

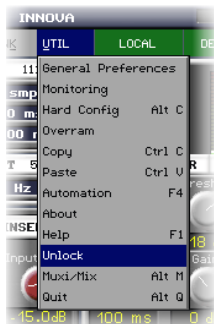
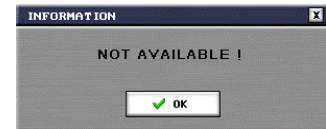

You can remove the protection by selecting the [**Unlock**] command in the *UTIL* menu. Obviously, this command only exists when protection is active.

You are then asked to enter your password in the following dialog box, in order to lift the protection:

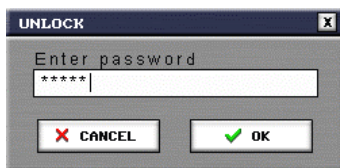

## 6.Q The General Preferences window

Although the majority of functions in the GENERAL PREFERENCES window are explained throughout this user manual, some of them have not been covered yet. This section describes, or refers you back to the section that has a full description of, every option in this window.

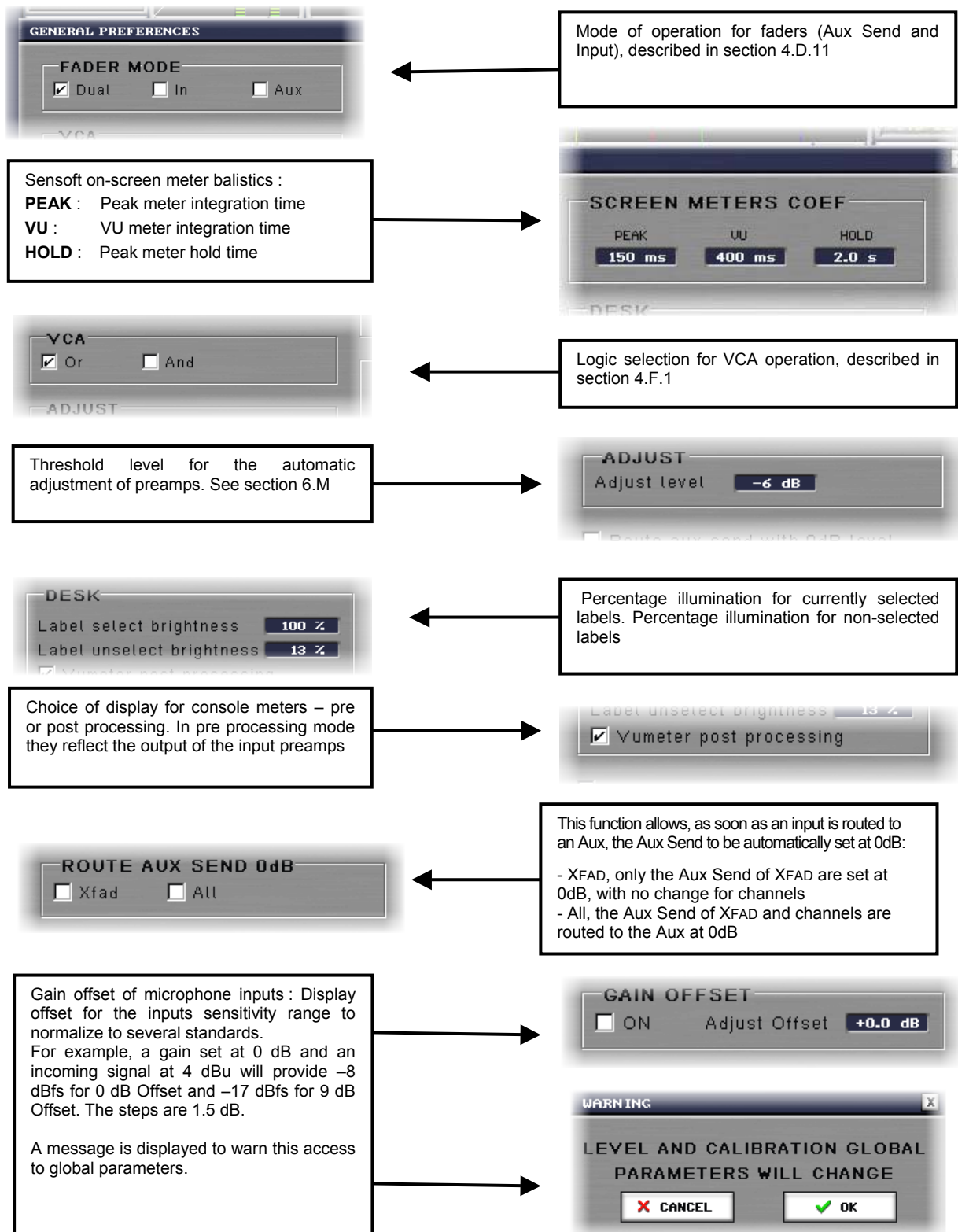

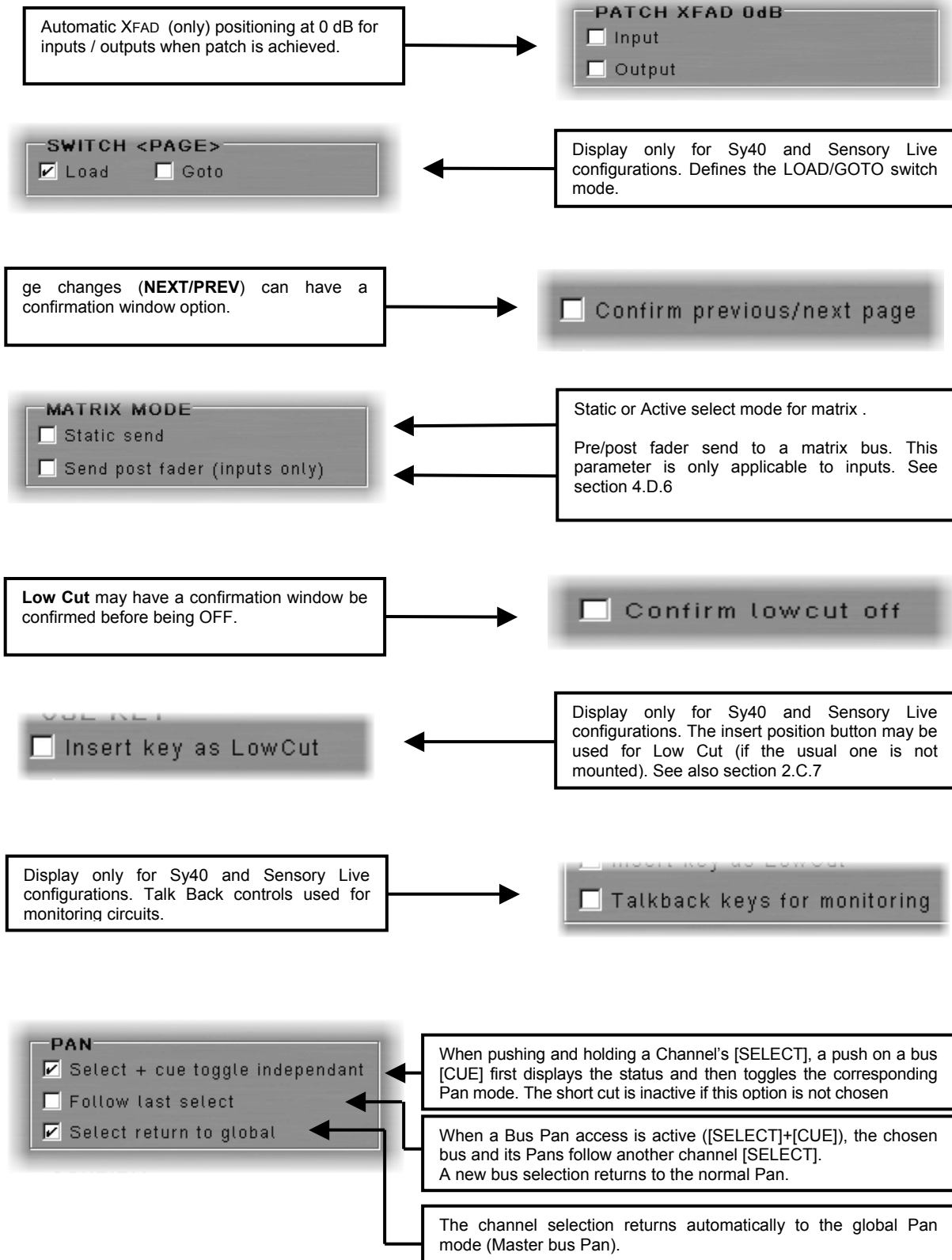

## General Preferences – typical windows

### Sy80 Configuration

<b>FADER MODE</b> <input checked="" type="checkbox"/> Dual <input type="checkbox"/> In <input type="checkbox"/> Aux	<b>SCREEN METERS COEF</b> PEAK    UU    HOLD <b>150 ms</b> <b>400 ms</b> <b>2.0 s</b>
<b>VCA</b> <input checked="" type="checkbox"/> Or <input type="checkbox"/> And	<b>DESK</b> Label select brightness <b>100 %</b> Label unselect brightness <b>13 %</b> <input checked="" type="checkbox"/> Vumeter post processing
<b>ADJUST</b> Adjust level <b>-6 dB</b>	<b>GAIN OFFSET</b> <input type="checkbox"/> ON    Adjust Offset <b>+0.0 dB</b>
<b>ROUTE AUX SEND 0dB</b> <input type="checkbox"/> Xfad <input type="checkbox"/> All	<b>PAN</b> <input checked="" type="checkbox"/> Select + cue toggle independant <input type="checkbox"/> Follow last select <input checked="" type="checkbox"/> Select return to global
<b>PATCH XFAD 0dB</b> <input type="checkbox"/> Input <input type="checkbox"/> Output	<b>CONFIRM</b> <input type="checkbox"/> Confirm previous/next page <input type="checkbox"/> Confirm lowcut off
<b>MATRIX MODE</b> <input type="checkbox"/> Static send <input type="checkbox"/> Send post fader (inputs only)	
<input checked="" type="checkbox"/> OK	

### Sy40 or Essential Live Configuration

<b>FADER MODE</b> <input checked="" type="checkbox"/> Dual <input type="checkbox"/> In <input type="checkbox"/> Aux	<b>SCREEN METERS COEF</b> PEAK    UU    HOLD <b>150 ms</b> <b>400 ms</b> <b>2.0 s</b>
<b>VCA</b> <input checked="" type="checkbox"/> Or <input type="checkbox"/> And	<b>DESK</b> Label select brightness <b>100 %</b> Label unselect brightness <b>13 %</b> <input checked="" type="checkbox"/> Vumeter post processing
<b>ADJUST</b> Adjust level <b>-6 dB</b>	<b>GAIN OFFSET</b> <input type="checkbox"/> ON    Adjust Offset <b>+0.0 dB</b>
<b>ROUTE AUX SEND 0dB</b> <input type="checkbox"/> Xfad <input type="checkbox"/> All	<b>PAN</b> <input checked="" type="checkbox"/> Select + cue toggle independant <input type="checkbox"/> Follow last select <input checked="" type="checkbox"/> Select return to global
<b>PATCH XFAD 0dB</b> <input type="checkbox"/> Input <input type="checkbox"/> Output	<b>CONFIRM</b> <input type="checkbox"/> Confirm previous/next page <input type="checkbox"/> Confirm lowcut off
<b>MATRIX MODE</b> <input type="checkbox"/> Static send <input type="checkbox"/> Send post fader (inputs only)	
<b>USE KEY</b> <input type="checkbox"/> Insert key as LowCut <input type="checkbox"/> Talkback keys for monitoring	<b>SWITCH &lt;PAGE&gt;</b> <input checked="" type="checkbox"/> Load <input type="checkbox"/> Goto
<input checked="" type="checkbox"/> OK	



## 7 SENSOFT OFFLINE

The purpose of this section is to describe the various methods of accessing the main functions of Sensoft, using the keyboard and mouse. These latter devices can be those of the console, or belong to an external computer (laptop or desktop) in cases where you want to work “offline” (without any connection to the console), in order to prepare in advance for an event.

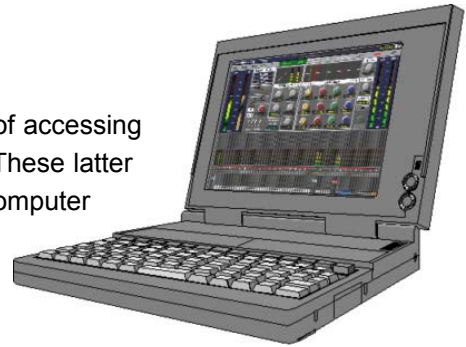

### 7.A General operation of the mouse and keyboard

A mouse or pen/tablet combination, connected to an external PC, may have two or three command buttons. Some are even fitted with a scroll wheel, an element not taken into account by Sensoft. However, in the majority of cases, the scroll wheel also acts as a third button (press down on the wheel), and Sensoft *can* exploit this feature.

The figure below describes the general operation of the mouse, as well as the equivalent keyboard keys, used in Sensoft’s patch grids and configuration windows :

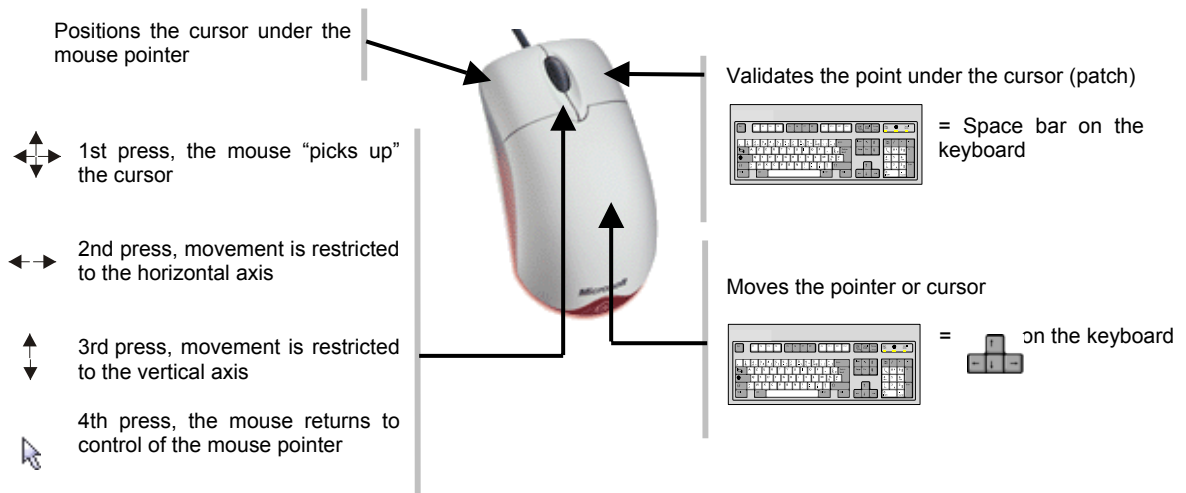

The modification of a configuration parameter is, in most cases, accompanied by a request to confirm [OK] or cancel [CANCEL]. Simply point at the corresponding button with the mouse, and click the left mouse button to make your choice. The following figure shows the keyboard equivalents for these functions :

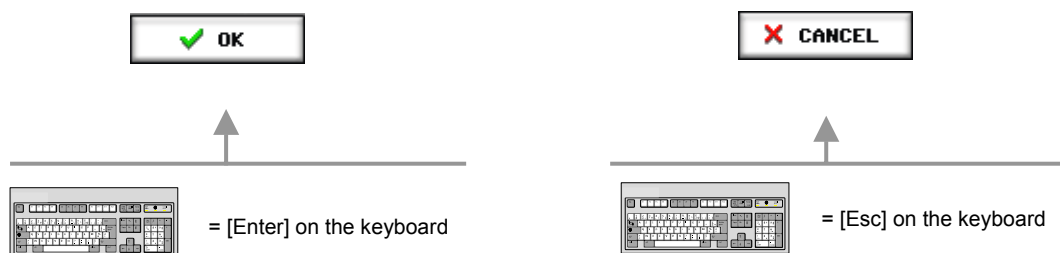

You can open Sensoft menus by **pressing the [ALT] key** plus the key corresponding to the underlined letter in the required menu entry (ex: **FILE, PAGE, BANK). So [ALT] + [K] will open the **BANK** menu. You can then use the keyboard's [UP] and [DOWN] cursor keys (arrows) to select the required function, and confirm your choice with [Enter].**

Finally, bear in mind that the various Sensoft windows are full of information, allowing you at any time to get to the heart of the “virtual” machine you are configuring :

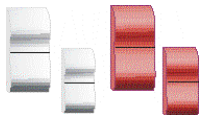

The faders controlling XFAD or XBUS channels are represented larger in the windows.

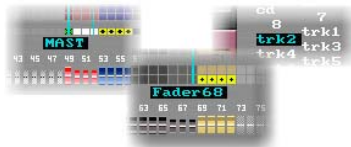

The patch grids provide labels to indicate the currently selected I/O and faders.

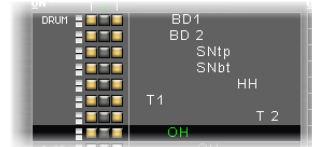

Input names are used to display stereo placement in the Pan window.

## 7.B Detailed operation and access to the various windows

### 7.B.1 The HARDWARE CONFIGURATION window

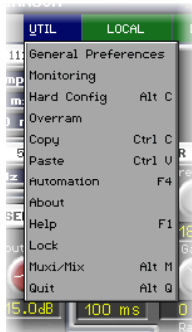

How do I get there



With the mouse: select **Hard Config** in the *UTIL* menu



With the keyboard: press the [ALT] + [C] keys

This window consists of two distinct parts :

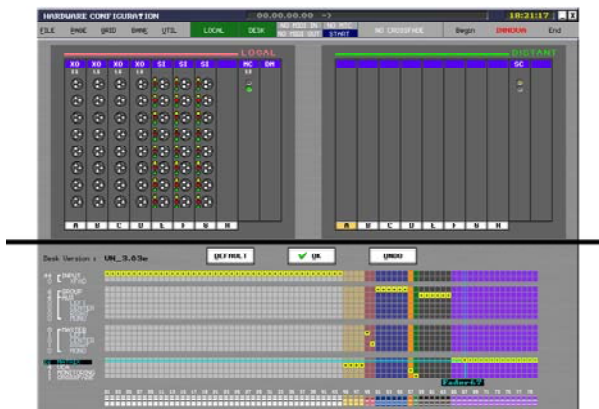

The top half represents the configuration of the audio racks. This configuration can be established automatically when a PC is connected to a working system, or manually when you work “offline”. It's then possible to configure the audio racks themselves by deciding which I/O modules will be used in each slot.

The procedure to create this configuration is as follows :

Point, by means of the mouse, at the slot that you wish to configure (its label turns yellow), use the keyboard's [+] and [-] keys to scroll through the various possible modules, and stop on the desired module. Repeat this operation for each slot.

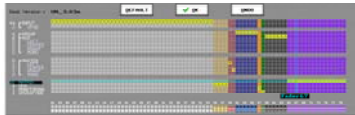

The bottom half of the window represents a function assignment grid for the console faders. The operation of this grid is identical to all Sensoft grids, and the mouse and keyboard function as described in section 7.A.

If any modifications are made, when you quit the window you will be asked to confirm or cancel the changes.

### 7.B.2 The PATCH IN GRID window



#### How do I get there



With the mouse: select **Patch Input** in the *GRID* menu



With the keyboard: press the [F11] key



Creating a patch point is relatively easy, simply position the cursor in the right place (left click of the mouse or keyboard cursor keys) and validate the point under the cursor (right click of the mouse or keyboard [SPACE BAR] ). The following sequence shows the procedure used to patch spread inputs, which requires two selections :

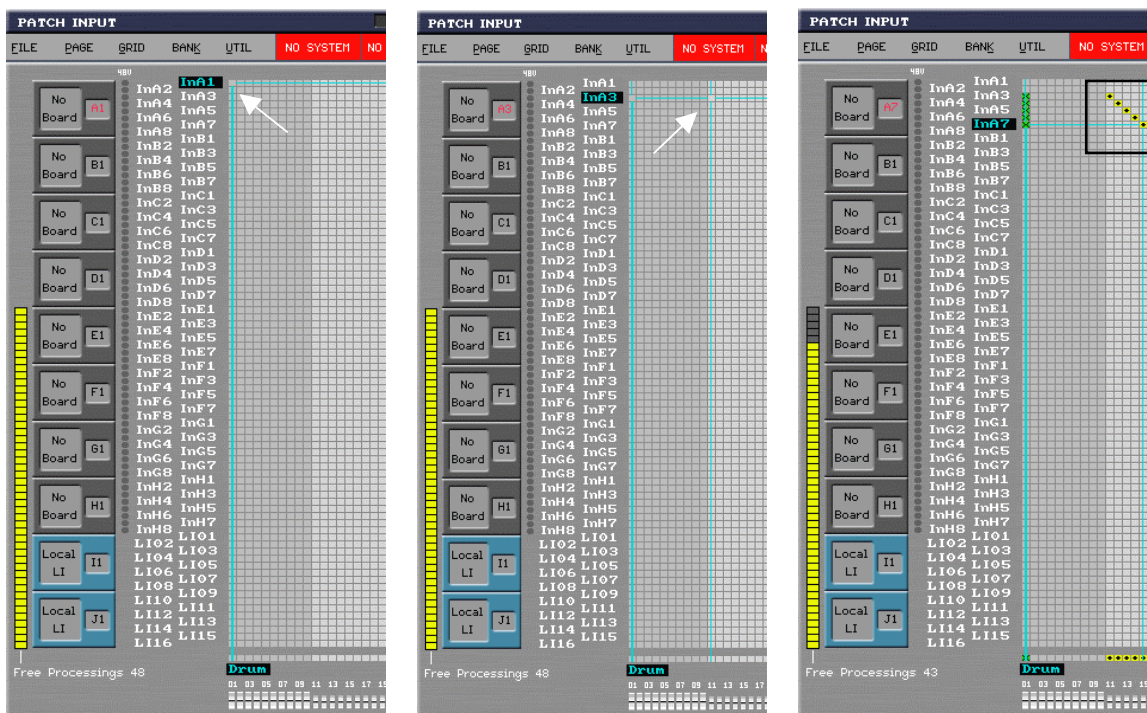

1- Place the cursor in the dark gray zone, with the aid of the left-click on the mouse, in the column corresponding to the Input Channel. The channel name appears above the faders – **Drum** in this example

2- Place the cursor in the light gray zone, on the line of the input you want to patch to the XFAD. To do this, place the mouse pointer in the light gray zone, and use its left-click to pull the cursor into this zone.

3- Once in the patch zone, it's possible to use the keyboard cursor keys and space bar, or simply continue patching with the aid of the mouse. Note that the channel currently being patched is always indicated above the faders.

What you should remember from the example above is that you *must* use the mouse to change zones, that is, to cross from the **Input Channel** zone to the **XFAD** zone. This allows you to make a direct zone change, without modifying the selection made in the previous zone.

Once you are in the chosen zone, it is then possible to use the keyboard cursor keys to point to lines and columns, and the [SPACE BAR] to create a patch point.

It is also possible, from this window, to create or change the name of a pointed at physical input by pressing the keyboard's [F3] key. [ALT] + [F3] allows you to name several inputs; confirming the first automatically moves you on to editing the following one, etc., until you press [Esc].



To quit the PATCH IN window, click the close button in the top right corner of the window, or press the keyboard's [Esc] key.

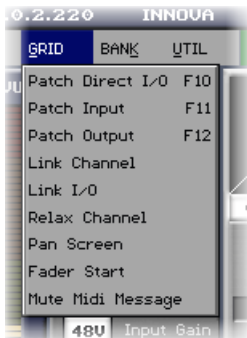

### 7.B.3 The PATCH OUT GRID window



#### How do I get there

	<p><u>With the mouse:</u> select <b>Patch Output</b> in the <i>GRID</i> menu</p>
	<p><u>With the keyboard:</u> press the [F12] key</p>

As with the PATCH IN window, creating a patch point in the PATCH OUT window is relatively easy, simply position the cursor in the right place (left click of the mouse or keyboard cursor keys) and validate the point under the cursor (right click of the mouse or keyboard [SPACE BAR]).

The following sequence shows the procedure used to patch spread outputs (in this case an Aux) which, here also, requires two selections :

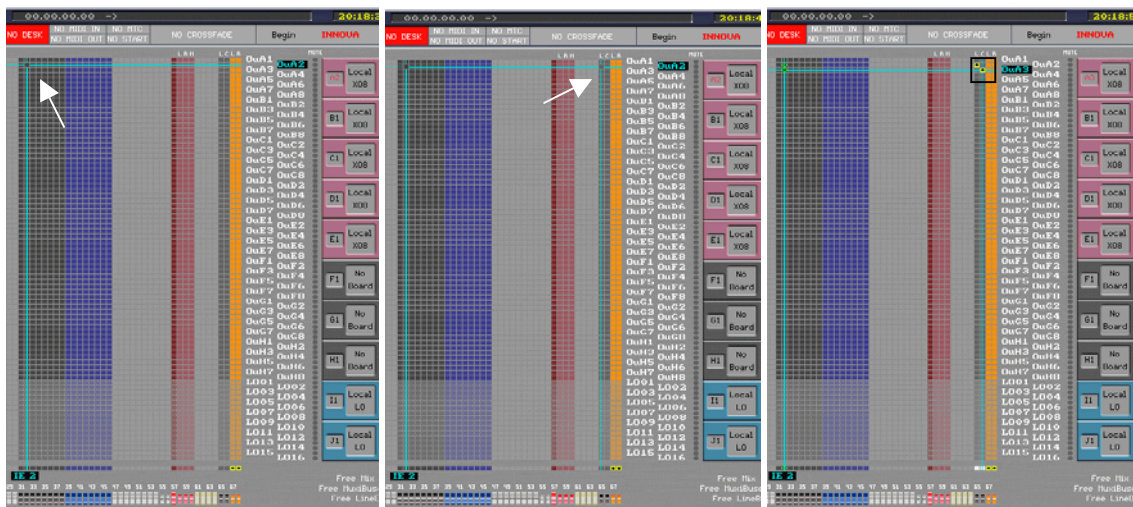

1- With the aid of the left-click on the mouse, place the cursor in the Aux channel column, in the zone where the Aux faders are located. The name of the channel appears above the faders, **IE2** in this example.

2- Place the cursor in the zone corresponding to the LR spread of the Aux. For this, just place the mouse pointer on either one of the Aux's LR columns, and use the left-click to pull the cursor into this zone.

3- Once in the patch zone, it's possible to use the keyboard cursor keys and space bar, or simply continue patching with the aid of the mouse. Note that the channel currently being patched is always indicated above the faders (**IE2**)

You must use the mouse to change zones, that is, to pass from the **Bus Channel** zone to that of the spread **XBUS**. This allows you to make a direct zone change, without modifying the selection made in the previous zone.



Once you are in the chosen zone, it is then possible to use the keyboard cursor keys to point to lines and columns, and the [SPACE BAR] to create a patch point.

It is also possible, from the PATCH OUT window, to create or change the name of a pointed at physical output by pressing the keyboard's [F3] key. [ALT] + [F3] allows you to name several outputs; confirming the first automatically moves you on to editing the following one, etc., until you press [Esc]. To quit the PATCH OUT window, click the close button in the top right corner of the window, or press the keyboard's [Esc] key.

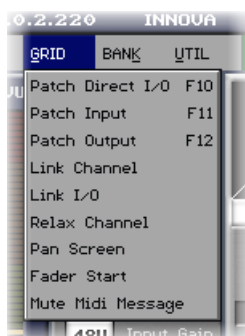
### 7.B.4 The DIRECT I/O and INSERT GRID window



**How do I get there**

	<u>With the mouse:</u> select <b>Patch Direct I/O</b> in the <i>GRID</i> menu
	<u>With the keyboard:</u> press the [F10] key

Since this window contains only one zone, you simply need to position the cursor on the desired input/output pair, and create the patch point using the mouse or keyboard.

However, in fact, two types of patch point can be created in this window: a **Direct I/O** point which has just been described, and an **Insert** point which can only be created using the keyboard's [i] (for "insert") key. The creation of an insert point instigates a request for the name of the insert, and creates a dark blue square on the intersection of the **Insert Send** and **Insert Return** points.





It is also possible, from this window, to adjust the gain of a selected input by positioning the mouse cursor on the red rotary control to the right of the window, and using the left-click and right-click to decrement or increment the gain. This action is also possible using keys on the keyboard; a reminder of the keys that operate in this window is shown in the table below :

**Keyboard functions in the Direct I/O window**

Function	Keyboard key
Increases the gain of the selected input	[F6]
Decrements the gain of the selected input	[F5]
48V On/Off for the selected input	[F7]
Mute/un-Mute the selected output	[F8]

Red spots (opposite the outputs) and yellow spots (above the inputs), on this grid, show the state of output mutes, and phantom power on inputs' microphones.

### 7.B.5 The LINK CHANNEL window

0.2.220 INNOVA		How do I get there	
GRID	BANK	UTIL	
Patch Direct I/O	F10		 <p><u>With the mouse:</u> select <b>Link Channel</b> in the <i>GRID</i> menu</p>
Patch Input	F11		
Patch Output	F12		 <p><u>With the keyboard:</u> no direct shortcut</p>
Link Channel			
Link I/O			
Relax Channel			
Pan Screen			
Fader Start			
Mute Midi Message			
48U	Input Gain		

Links between Aux, Group and Input channels are simply made with the mouse or keyboard, using the commands described in section 7.A. On the other hand, links between inputs within a spread zone must be made in two steps. First you must select the fader that you want to spread by moving the cursor to the column corresponding to this fader (the name of the channel appears above the selected fader) and then go to the spread zone to make the links between the XFAD.

Once in the zone, if you wish, points can be selected and created using the keyboard keys.

You must use the mouse to change zones, that is, to pass from the **Channel** (Aux, Group, Input) zone to that of the spread **XFAD** OR **XBUS**. This allows you to make a direct zone change, without modifying the selection made in the previous zone.

The assignment of linked processing is made, using the mouse or keyboard, on the left hand side of the grid window.

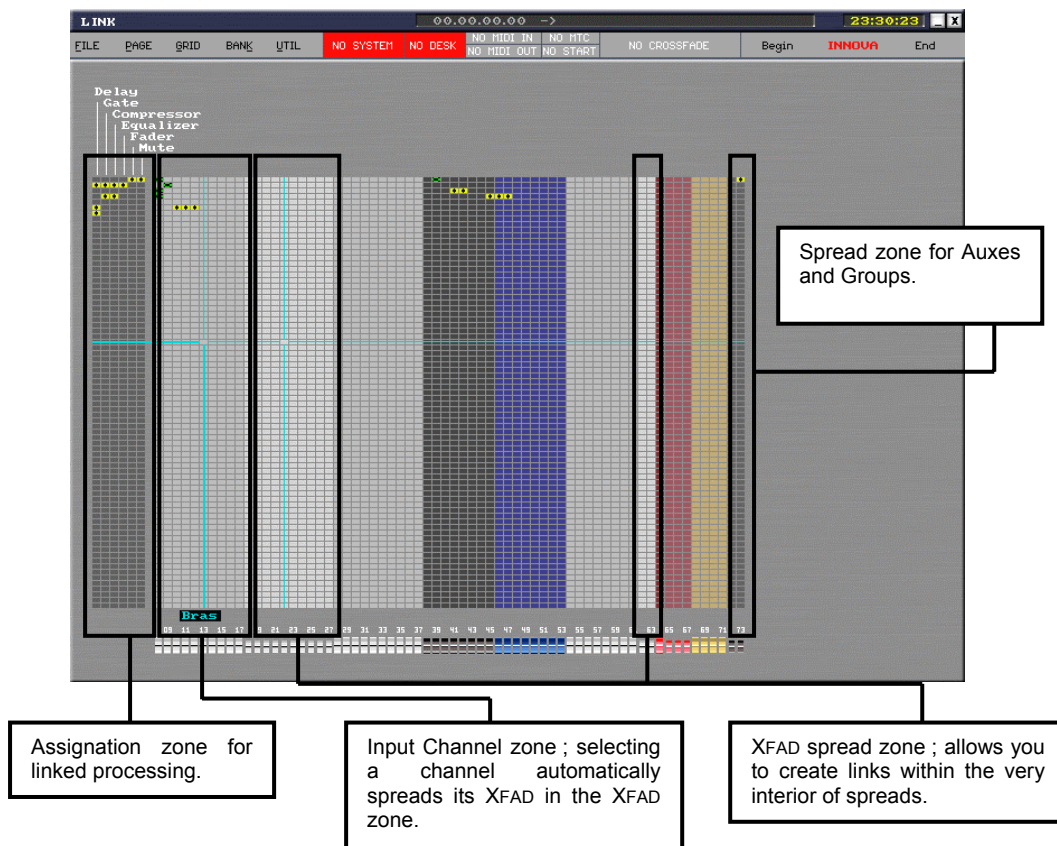

**The Link Channel grid**

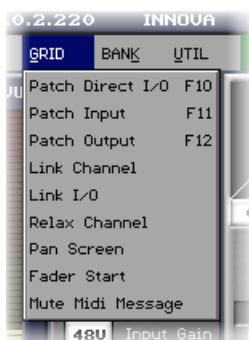

**7.B.6 The LINK I/O window**



**How do I get there**

	<p><u>With the mouse:</u> select <b>Link I/O</b> in the <i>GRID</i> menu</p>
	<p><u>With the keyboard:</u> no direct shortcut</p>

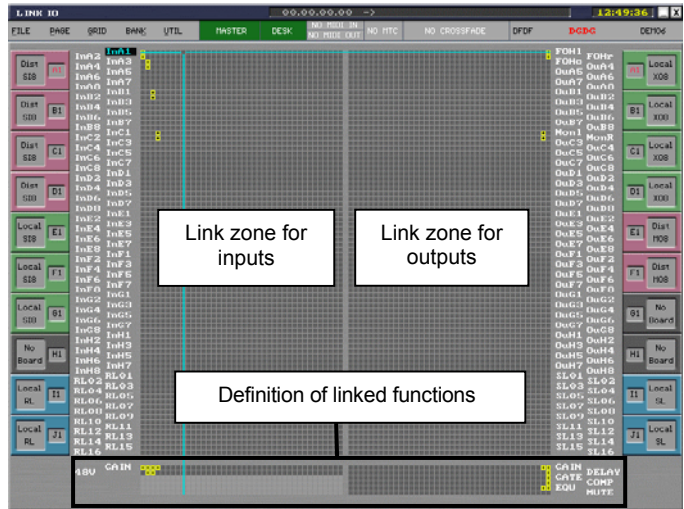

The physical inputs and outputs of the audio racks can be linked together, by using the mouse or keyboard to create a patch point. All the inputs and outputs with a patch point will be linked to those also having a patch point on the same “link” level (column). Simply use the instructions in section 7.A to create the patch points. Don’t forget, for every link level, to assign the linked functions (GAIN, GATE, etc.), using the grids at the bottom of the display.

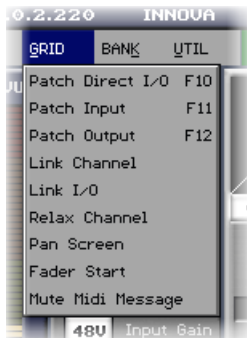

**7.B.7 The RELAX, FADER START and MUTE MIDI MESSAGE windows**



How do I get there

	<u>With the mouse:</u> select the required function in the <i>GRID</i> menu
	<u>With the keyboard:</u> no direct shortcuts for these windows

These three windows allow you to set up various configurations, and are all controlled in the same way, as described in section 7.A, using either the mouse, or directly from the keyboard.

### 7.B.8 The PAN window

0.2.220 INNOVA

**GRID** BANK UTIL

Patch Direct I/O F10

Patch Input F11

Patch Output F12

Link Channel

Link I/O

Relax Channel



Pan Screen

Fader Start

Mute Midi Message

48U Input Gain

**How do I get there**

	With the mouse: select <b>Pan Screen</b> in the <i>GRID</i> menu
	With the keyboard: no direct shortcut

As you probably know, this window is presented in a slightly different way, depending on whether it is accessed from an input or an output. Let's see how both these windows can be set up offline.

#### Access to the window when an input is selected

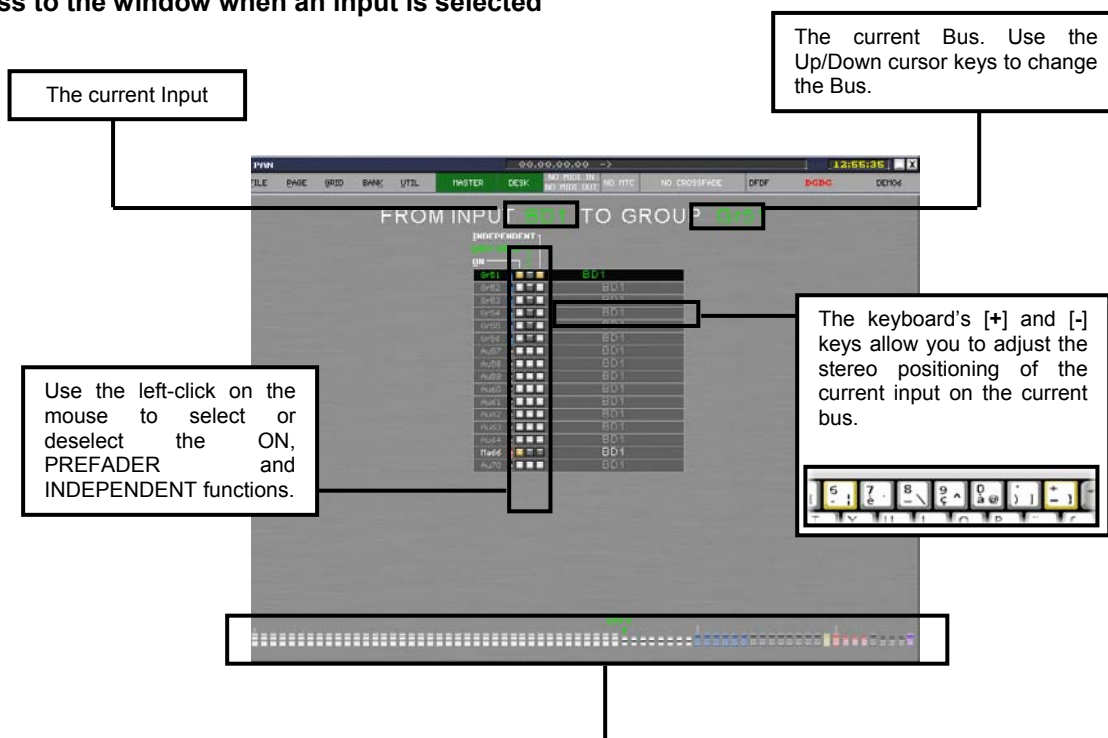

The current Input

The current Bus. Use the Up/Down cursor keys to change the Bus.

Use the left-click on the mouse to select or deselect the ON, PREFADER and INDEPENDENT functions.

The keyboard's [+] and [-] keys allow you to adjust the stereo positioning of the current input on the current bus.

To change the current input, simply point at the required fader and use the left-click on the mouse. To spread a bank of XFAD involves two steps: first point at the Channel Input so it spreads the XFAD that it manages, and then point at the required channel in the XFAD zone. You can also click as often as is necessary on the Channel Input, to scroll through the XFAD that it manages.

The keyboard's [LEFT] and [RIGHT] cursor keys can be used to move from fader to fader :



**Access to the window when a bus is selected**

This window has the advantage of showing all the spread inputs; there is no need for a two-step operation

The current Input. Use the [UP]/[DOWN] cursor keys to change the Input.



The current Bus.

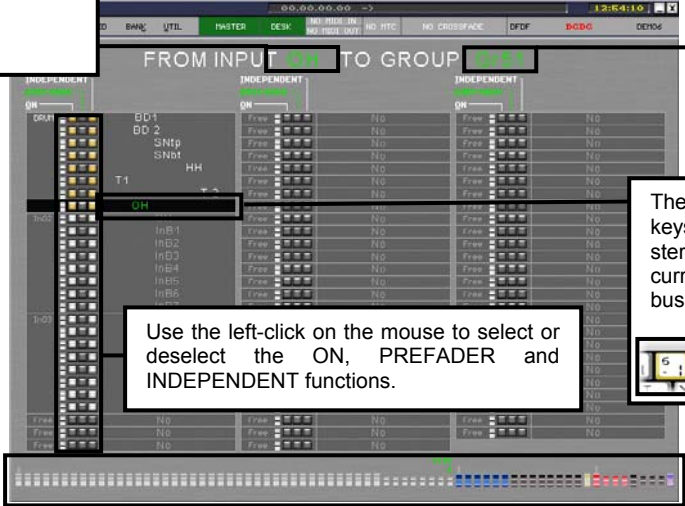

Change the current bus using left-click with the mouse on the corresponding fader.



The keyboard's [LEFT] and [RIGHT] cursor keys can be used to move from fader to fader :

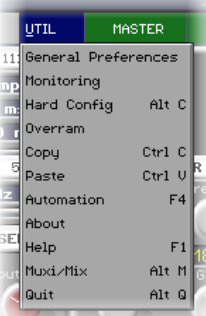

**7.B.9 The PASTE and OVERRAM windows**



**How do I get there**

	<p><u>With the mouse:</u> select <b>Paste</b> or <b>Overram</b> in the <i>UTIL</i> menu</p>
	<p><u>With the keyboard:</u> [CTRL + V] for Paste; no direct shortcut for OverRam</p>



Since these windows have the possibility of acting on a spread **XFAD** or **XBUS**, they deserve a little more time being spent on their operation, which requires, you guessed it, two-step selection when dealing with spread channels.

### The PASTE window

A left-click on a Channel Fader (Input, Aux, etc.) spreads the XFAD or XBUS controlled by this channel.

A left-click on a Channel (Input, Aux, etc.) selects or deselects all the XFAD or XBUS controlled by this channel.

The XFAD or XBUS have smaller validation boxes in order to make them more easily identifiable.

As you will have realized, a yellow validation box indicates the channel that will be affected by the **Paste** action.





### The OVERRAM window

The right-click button on the mouse allows you to individually select pages for the OverRam.

The selection of spread channels is made according to the same method as described above, regarding the **PASTE** window.

**7.B.10 The MUXI window**

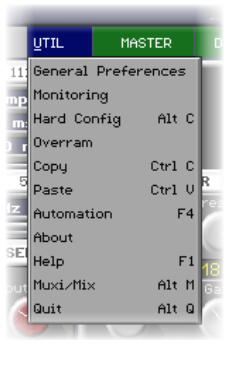
How do I get there (and leave it)

	<p><u>With the mouse:</u></p> <ul style="list-style-type: none"> <li>• select <b>Muxi/Mix</b> in the <i>UTIL</i> menu</li> <li>• click the close button in the top right corner of the window</li> </ul> 
	<p><u>With the keyboard:</u> press the [ALT] + [M] keys</p>

All the functions in the top half of this window are accessible by the mouse (the keyboard can be used for some) and can be set according to the instructions given in section 7.B.11 – “The main MIX window”.

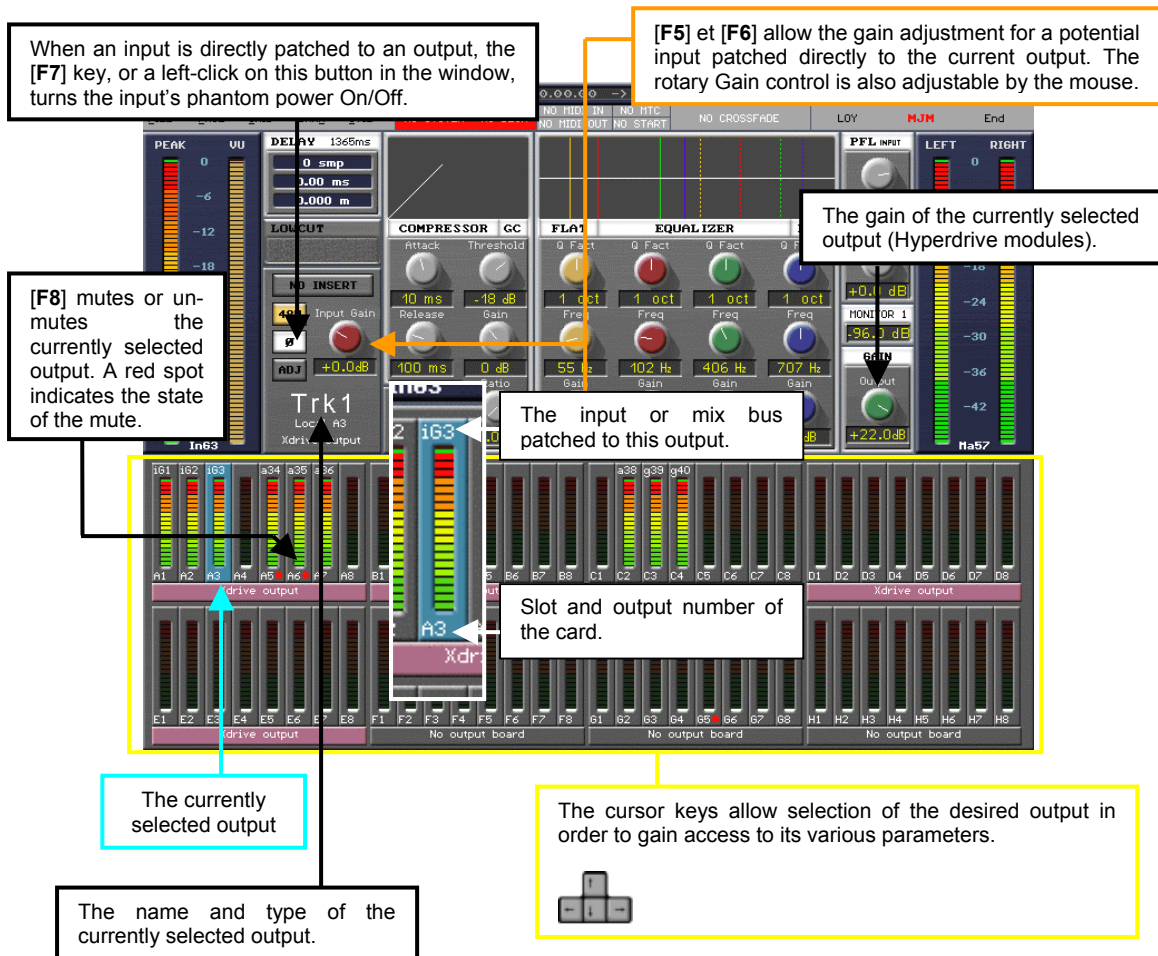

When an input is directly patched to an output, the [F7] key, or a left-click on this button in the window, turns the input's phantom power On/Off.

[F5] et [F6] allow the gain adjustment for a potential input patched directly to the current output. The rotary Gain control is also adjustable by the mouse.

[F8] mutes or unmutes the currently selected output. A red spot indicates the state of the mute.

The gain of the currently selected output (Hyperdrive modules).

The input or mix bus patched to this output.

Slot and output number of the card.

The currently selected output

The name and type of the currently selected output.

The cursor keys allow selection of the desired output in order to gain access to its various parameters.

## 7.B.11 The main MIX window

### 7.B.11.1 Switches and rotary controls



To adjust the settings of rotary controls, simply point at the control in question and use the right-click and left-click on the mouse to increment or decrement its value.

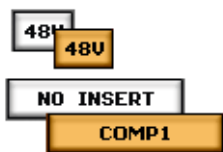

To select or deselect a switch (button), point at it and use the left-click of the mouse as an ON/OFF control.

Naturally, some of the rotary controls and buttons also have keyboard shortcuts, for example [F7] turns the phantom power on/off, and [F5] / [F6] control the input gain. See section 7.C for a full list of these shortcuts.

### 7.B.11.2 Digital values

These parameters, for the time being, only concern adjustments for **Delay** and the **LowCut** (high-pass) filter frequency.

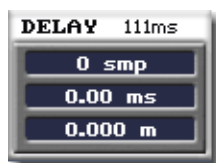

To increment or decrement the values contained in these windows, point at them and use the left-click and right-click buttons on the mouse. The mouse also allows you to activate and deactivate these functions; see point 4 of this section to find out where and how various functions can be activated in the Main Mix window.

### 7.B.11.3 Faders



To select a fader in order to access the settings on the channel that it controls, you must point at the fader and use the left-click of the mouse. The fader “slot” turns green to indicate the currently selected fader.

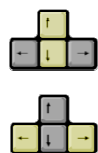

The keyboard's [LEFT]/[RIGHT] cursor keys can be used to access the following or preceding fader. To modify the level of a fader, point at it with the mouse and hold down the right-click button while you drag the fader in the required direction. The keyboard's [UP]/[DOWN] cursor keys allow an exact fader position to be set.

7.B.11.4 The Mix window in detail

When it is available, a left-click in this area activates/deactivates the Delay.

A left-click in this area activates/deactivates the current Dynamics section.

A left-click in this area switches between Gate and Compressor.

Un clic gauche dans cette zone active/désactive le Low Cut.

A right-click accesses a list of external insert devices. A left-click activates the insert return..

A left-click of the mouse allows access to the functions in these three areas.

Click in these areas to modify the monitor bus settings for inputs and outputs, and select the monitor circuit.

Aux Sends of the currently selected input \*

A left-click on these spots (red) controls the channel mute/unmute.

A left-click on these spots (green) allows you to send the bus to the monitoring (CUE).

A left-click on these spots (yellow) allows you to route (or de-route) the current input to the mix busses.

The green line indicates the currently selected channel. All the parameters displayed in the upper half of the window are concerned with this channel.

The beige line indicates the currently selected channel in a spread zone. The parameters displayed in the upper half of the window will be concerned with this channel.

The gray lines indicate the spread faders of channels that are not currently selected. Spread XFAD or XBUS belong therefore to these channels.

\* Conversely, if an Aux is selected, this accesses the Aux Send settings of all the input channels, in this zone.

**7.C Summary of function access**

<b>Function</b>	<b>Keyboard</b>	<b>Mouse</b>	<b>Console</b>
Label an I/O	[F3] or [ALT+ F3]		
Input gain	[F5/F6] or [ALT+ F5/F6] ignores <b>link</b>	L/R on Gain control	<b>GAIN</b> control
+48 V	[F7]	L on 48 V button	<b>48 V</b> button
Mute	[F8]		<b>MUTE</b> button
Off line	[ALT] + [O]		<b>OFF LINE</b> button
Cue	[C]		<b>CUE</b> button
Oscillator	[O]		<b>TEST</b> button
Next	[Page Up]		<b>NEXT</b> button
Previous	[Page Down]		<b>PREV</b> button
Delay		L on Delay button +/-	
EQ ON/OFF		L on EQ button	<b>EQ</b> button
Réglage Eq.		L/R on EQ button	<b>EQ</b> controls
Gate ON/OFF		L on GATE button	<b>GATE</b> button
Gate settings		L/R on GATE controls	<b>GATE</b> controls
Comp ON/OFF		L COMP button	<b>COMP</b> button
Compressor settings		L/R on COMP controls	<b>COMP</b> controls
Low-cut		L on LOWCUT button	<b>LOWCUT</b> button
Select channel	Cursor keys	L on channel	<b>SELECT</b> button
Niveau Tranche	Cursor keys	R on channel	Fader
Routing		R on yellow	<b>SELECT</b> buttons
Unlink In			<b>SELECT</b> button
Unlink Out			<b>SELECT</b> button
Alpha/ Decimal	[ALT] + [A]		
Compressor meters	[ALT] + [B]		
Hardware Configuration	[ALT] + [C]		

<b>Function</b>	<b>Keyboard</b>	<b>Mouse</b>	<b>Console</b>
File menu	[ALT] + [F]		
Grid menu	[ALT] + [G]		
Page menu	[ALT] + [P]		
Util menu	[ALT] + [U]		
Edit	[ALT] + [E]	Menu <i>FILE</i> + <i>Edit</i> menu	<b>EDIT</b> button
Save Page	[ALT] + [W]	<i>PAGE</i> + <i>Save</i> menu	<b>SAVE</b> button
Load Page	[ALT] + [L]	<i>PAGE</i> + <i>Load</i> menu	<b>LOAD</b> button
Insert Blank page vierge	[ALT] + [N]	<i>PAGE</i> + <i>Insert new</i> menu	
Insert Identical page	[F2]	<i>PAGE</i> + <i>Insert next As</i> menu	
Patch In	[F11]	<i>GRID</i> + <i>Patch In</i> menu	<b>PATCH IN</b> button
Patch Out	[F12]	<i>GRID</i> + <i>Patch Out</i> menu	<b>PATCH OUT</b> button
Link Channel		<i>GRID</i> + <i>Link channel</i> menu	<b>LINK CHNL</b> button
Link I/O		<i>GRID</i> + <i>Link I/O</i> menu	<b>LINK I/O</b> button
PAN window		<i>GRID</i> + <i>Pan Screen</i> menu	<b>PAN</b> button
OverRam		<i>UTIL</i> + <i>OverRam</i> menu	<b>OVERRAM</b> button
Copy	[CTRL]+[C]	<i>UTIL</i> + <i>Copy</i> menu	<b>COPY</b> button
Paste	[CTRL]+[V]	<i>UTIL</i> + <i>Paste</i> menu	<b>PASTE</b> button
Automation	[ALT] + [F4]		
Help	[ALT] + [F1]	<i>UTIL</i> + <i>Help</i> menu	
Muxi/ Mix screen	[ALT] + [M]	Button minimize window	<b>MUXI</b> button
Midi IN ON/OFF	[ALT] + [X]	Check box in <b>AUTO</b> window	
Midi OUT ON/OFF	[ALT] + [Y]	Check box in <b>AUTO</b> window	
MTC play ON/OFF	[ALT] + [Z]	Check box in <b>AUTO</b> window	
MTC Rec. ON/OFF	[ALT] + [J]	Check box in <b>AUTO</b> window	
Crossfade ON/OFF	[ALT] + [D]	Check box in <b>AUTO</b> window	

All these shortcuts are shown on a list in Sensoft. Use the [F1] key, or the *UTIL/Help* menu, to access the list.



## 8 INSTALLING AND CONFIGURING SENSOFT 9

### 8.A Downloading and preparing the installation

Innovason consoles are delivered with the latest approved version of Sensoft. The Sensoft version is displayed in the blue strip on top of the screen. The Sensoft software can be downloaded free of charge on our web site (<http://www.innovason.com>) to provide updates and bring new functions. The downloadable file is compressed in the ZIP format – start by downloading that file in a folder of your hard disk.



Sensoft 9.0.1  
Installation.zip

Double-clicking on that file will launch the WinZIP program, which lets you visualize the content of the file. Note that you must have such a program capable of reading and decompressing ZIP files, which are quite usual nowadays. Freeware versions are available for free on the net.

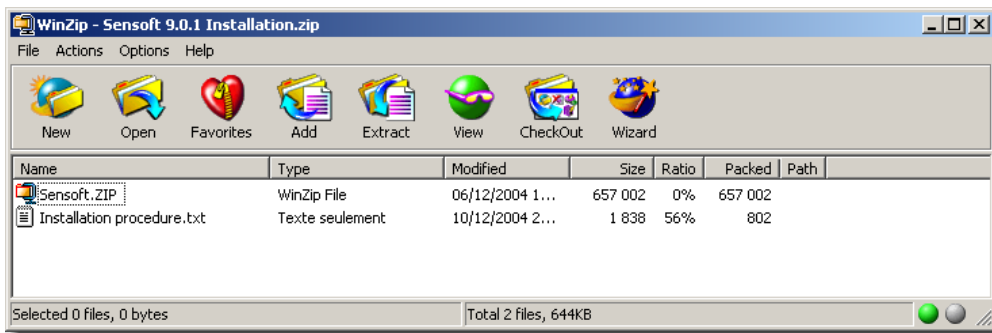

The compressed folder contains two files:

- **Sensoft.ZIP**: itself, a compressed folder containing all the necessary files for installing Sensoft.
- **Installation procedure.txt**: a quick help file for installing Sensoft on a platform or a PC.

The USB key provided with your console is « bootable », configured to be used as a startup system for your console. It is important that you never format this key and that you save it for updates and re-installations of your console's system.

The window below describes the content of the USB key provided with the console:

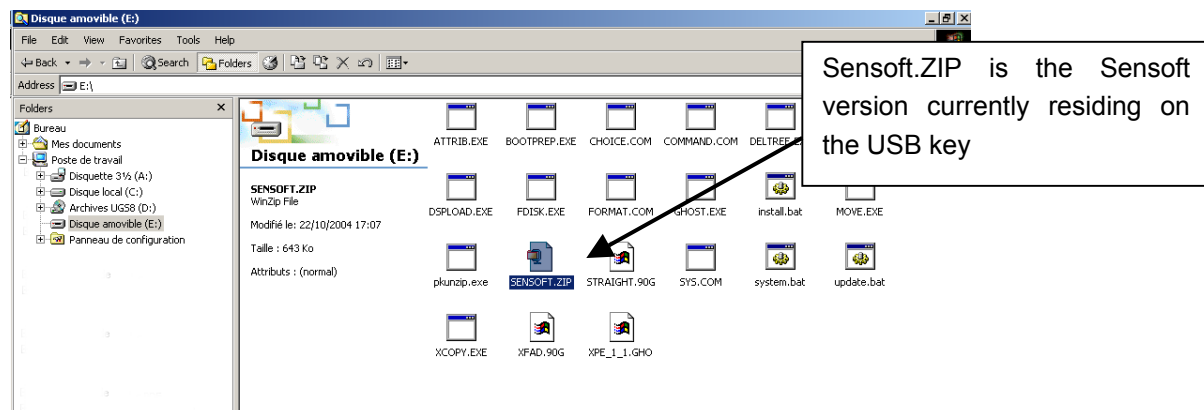



Before you use the USB key to install a new version of Sensoft it is therefore essential that you first copy the new version on that USB key. For that, you just need to replace the **Sensoft.ZIP** file currently on the key by the newer **Sensoft.ZIP** file that you downloaded from our site.

If you wish to be able to switch back to the previous Sensoft version, you need to make a copy of the **Sensoft.ZIP** file on the USB key before you replace it. Just copy it in a directory of your hard disk and give that directory the name of the file version.

Your key is now updated and ready for installing or updating your console...

### 8.B Installing SENSOFT

#### 8.B.1 Re-installation, new version

A re-installation is necessary when the Sensoft version's first digit changes, for example, when changing from version 8 to version 9. It is also necessary if you reinstall your Windows XP<sub>E</sub> operating system.

The previous version will be irremediably replaced and the pages created with that version will be erased. Generally, a new version can re-interpret the pages of the previous version (wholly or partially: new functions = new parameters). Sensoft 9.1 can re-interpret the pages created with Sensoft 8.1.

First, save the folders on your console to a USB memory device with the *FILE* menu's [Export] command.

Switch your console off and follow the step by step procedure below to install Sensoft :

**1** Insert your USB key in one of the console's available ports. Launch the console and immediately press [**F8**] or [**F11**] to access the startup menu.

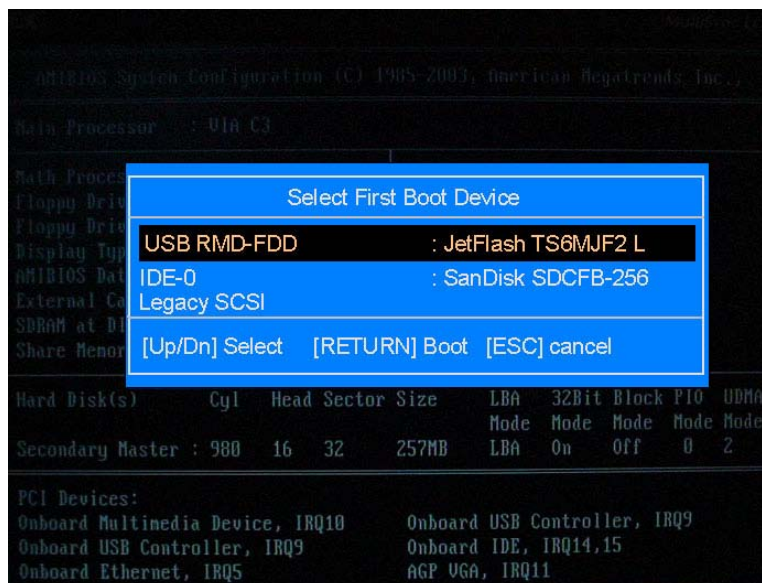

**2** As above, select the USB port. Validate with [**ENTER**].

**3** At the root of the temporary Win98 boot, type “install c:” and validate with [ENTER]

```
Sedarching for Boot Record from USB RMD-FDD..OK
D  marrage de Windows 98...
Microsoft(R)Windows 98
(C)Copyright Microsoft Corp 1981-1999.

A:\>install c:_
```

This command installs the Sensoft version currently on the USB key. Once the installation is finished and “a:\>” is displayed on screen, you can reboot your console to immediately start using your new version of Sensoft 9.

When you first launch Sensoft, you are automatically invited to configure the software in order to adapt it to the platform on which it has been installed. Section 8.2 explains this configuration window thoroughly.

**8.B.2 Updating, new 'release'**

An update lets you keep your Sensoft folders. It is possible only if you already have version 9.x of Sensoft installed on the hard disk. For versions 8.x and earlier, a complete installation is necessary: see section 8.1.1.

Switch your console off and follow the step by step procedure below to install Sensoft :

- 1-** Insert your USB key in one of the console's available ports. Launch the console and immediately press [F8] or [F11] to access the startup menu.

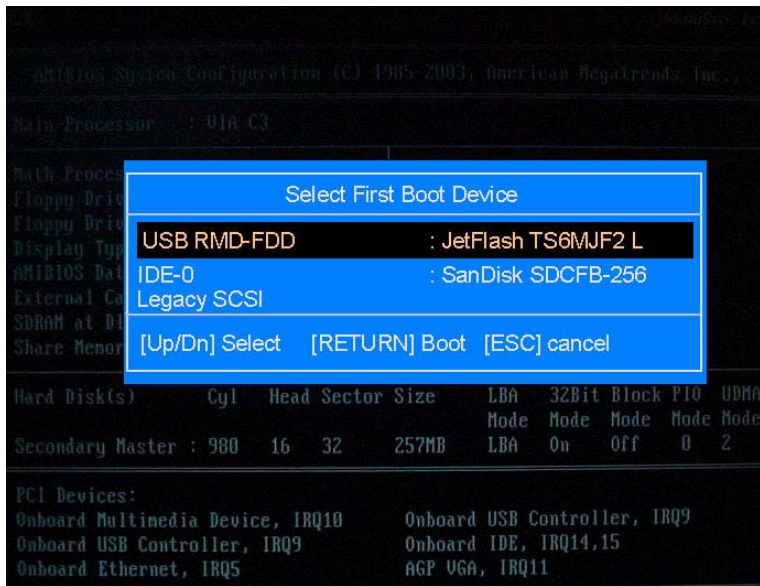

- 2-** As above, select the USB port. Validate with [ENTER].

- 3-** At the root of the temporary Win98 boot, type "update c:" and validate with [ENTER]



This command replaces the Sensoft version installed on your console by the one residing on the USB key. Once the installation is finished and "a:\>" is displayed on screen, you can reboot your console to immediately start using your new version of Sensoft 9.

An update keeps and uses all the parameters and all the files residing on the console. Configuring is therefore unnecessary and, when launched, Sensoft will return to the last page used and all its parameters.

### 8.B.3 Installing the Windows XP<sub>E</sub> operating system

Be it because of an upgrade, a PC failure or a Flash Memory exchange, you might have to re-install the operating system of the console.

All the files created afterwards will be lost. If it is still possible, do not forget to export your files...

The USB key provided with the console contains all the necessary elements for installing WinXP<sub>E</sub>. Start by switching the console off, and follow the step by step procedure below.

**1** Insert your USB key in one of the PC's ports, or in the port available on the console's front. Launch the console and immediately press **[F8]** or **[F11]** to access the startup menu.

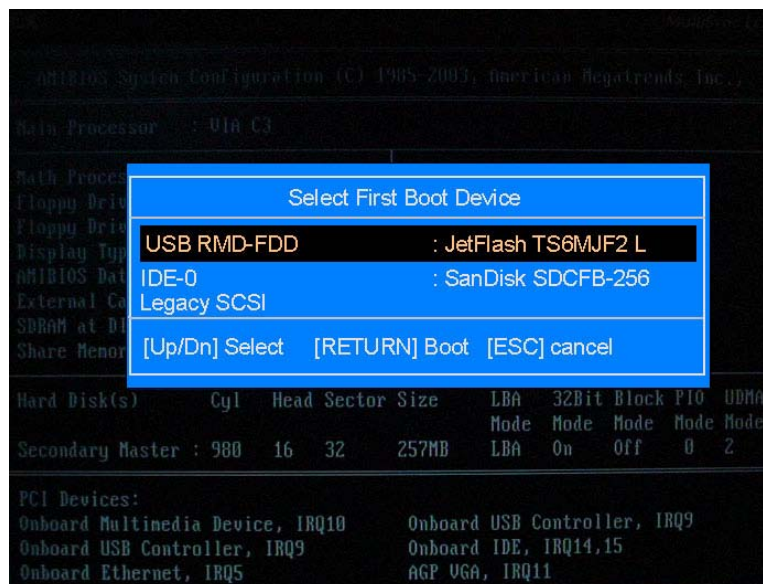

As above, select the USB port. Validate with **[ENTER]**.

**2** At the root of the temporary Win98 boot, type “**system c:**” and validate with [ENTER]

```
Searching for Boot Record from USB RMD-FDD..OK
Démarrage de Windows 98...

Microsoft(R) Windows 98
(C)Copyright Microsoft Corp 1981-1999.

A:\>system c:_
```

Type [y] in answer to the alert window...

```
System Install ...
WARNING: ALL DATA ON DRIVE C WILL BE DESTROYED, CONTINUE Y/N ?
```

**3-** If you are installing XPE on this PC for the first time, you should see this screen:

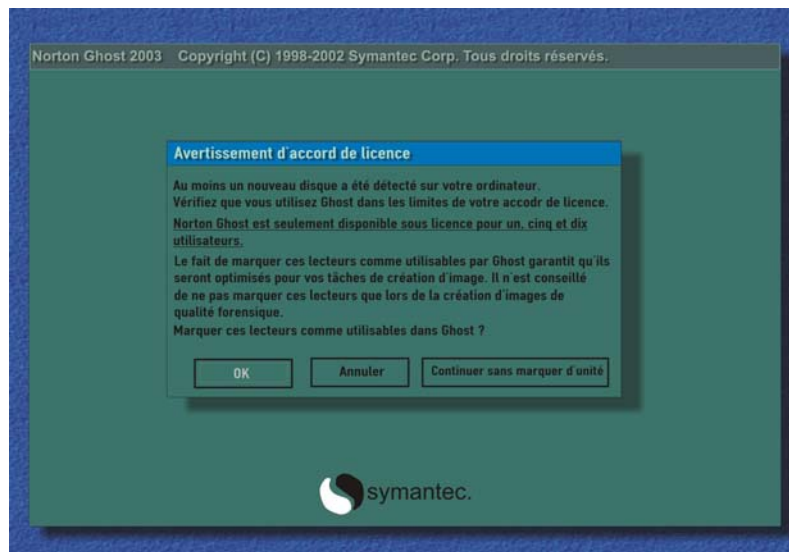

**Validate with OK.**

**4-** the necessary files for the installation of XPE are then transferred to the PC's Flash Memory. The screen below indicates the progress of that transfer:

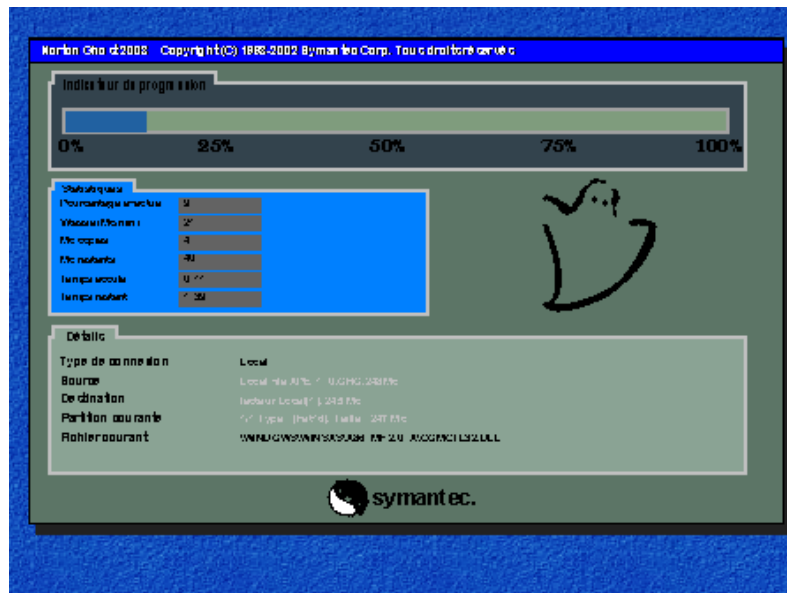

Once the process is finished, the Windows XP<sub>E</sub> operating system is installed on your machine.

**You now have to install Sensoft : refer to section 8.2**

## 8.C Configuration

After a new installation, Sensoft displays the screen below so you can configure the system. You can also access it at any time by typing (nothing will show on screen) the password “**innova**” while in the *UTIL* menu’s ABOUT window.



This screen’s purpose is to configure the console’s elements for data exchange between PC, Mix Box rack and control surface. The parameters on this screen are important for your console and Sensoft software to function properly. Therefore, you must respect the indications that are given below. The consoles are delivered from the factory with optimized settings, and it is wise to keep them as they are. Our customer service might ask you to change these.

Use the up and down arrow keys to select the parameters (highlighted in yellow), and the left and right keys to change the selected parameter’s value.

### Console :

**Sy80**, management of the Sy80 control surface, remote audio controller compatible with DSP Sy80 cards.

**GRAND LIVE**, management of the GL control surface, remote audio controller compatible with DSP Sy80 cards.

**Sy48**, management of the Sy48 control surface, remote audio controller compatible with DSP Sy48 cards.

**Serial Port Number :** **Disable** for use on an Off-line PC, or without the console.

**1** Grand Live, equipped with a 233MHz PC PIA671

**2** for a Sy80, Sy48 and GL equipped with a 800MHz or 1GHz PC ISA800.

**3** and **4** reserved for specific usage

When the chosen port detects the control surface, a yellow RESET DESK window is displayed and its 'channel control' panel buttons blink twice. On the system status line, on top of the screen, the red background **NO DESK** message, turns to a green background **DESK** message. If the serial port is not adequate, the red background **NO DESK** status will remain. When controlling the console with an external PC, try all the port numbers until the console is detected.

**DigMix :**

**YES** (default) for normal use of the console, with DSP module

**NO** to use the audio racks as MUXIPAIRE, with no DSP module. Only the Muxi mode ([ALT]+[M]) and the direct I/O grid is then necessary to manage the audio racks.

**New Design :**

**NO** (default), normal use

**YES** reserved application

**MIDI CABLE TEST:**

**NO** inactive, normal status

**OK** or **BAD CONNECTION** when testing a MIDI cable connected between the IN and OUT ports of the console...

**MIDI SETUP :**

**NO** inactive, normal status

**WAIT.** Loading the **SENSOFT\FILES80X\MIDI.CFG** text file.

Transfer of a MIDI SYSEX file to initialize a Midi-Solutions R8 rack, giving you access to 8 'fader-start' relays compatible with the data sent by Sensoft. The characteristics of this equipment is available on the [www.midisolutions.com](http://www.midisolutions.com) web site. Also see section 6.0 for information on fader-starts.



## 8.D Importing files created with earlier versions of Sensoft

The « Import » command opens a window in which you can determine the version of the file that you wish to import.

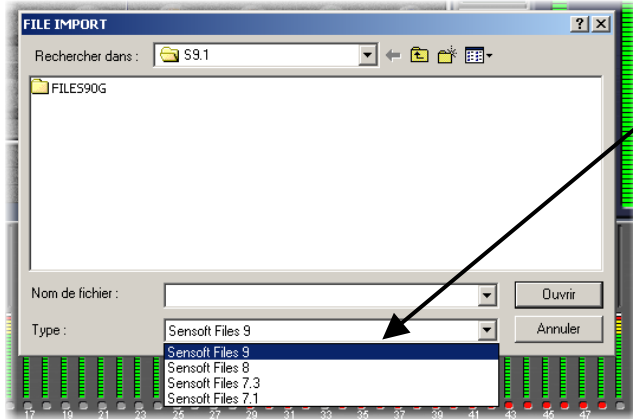

A scrolling list, at the bottom of the window, shows you the versions that you can import.

### 8.D.1 Grand Live files

A file created with Sensoft 7.1.x when working with a Grand Live console can be read and interpreted by Sensoft 9. When imported, the fader configuration will be that of a Grand Live, i.e. 48 mono inputs, non-deployed LRM masters, and 20 mono aux busses. Fader links are kept, but not the other types of links.

### 8.D.2 Sy40 files

A file created with Sensoft 7.3.x when working with a Sy40 console can be read and interpreted by Sensoft 9. When imported, the fader configuration will be that of a Sy40, i.e. 24 mono inputs, 8 inputs deployed in stereo, 3 non-deployed LRM masters and 12 aux busses deployed in stereo. Fader links are kept, but not the other types of links. Pans on stereo busses routed to the masters are interpreted, but not their balance. Faders are created in the « virtual » fader area (in other words, faders other than the physical ones present on the Sy40/48 control surface), so you can deploy L and R of the stereo busses.

## 8.E Firmware update for DSP Sy48 and DSP Sy80

Sensoft is designed around the architecture of DSP Sy48 and Sy80 modules.

A new version of Sensoft is often accompanied by a new Firmware version that you must transfer to the DSP card of the console.

Two files residing on your USB key are necessary for this transfer: **DSPLOAD.EXE** and **DSPxxx.LDn**. DSPxxx.LDN represents the Firmware you need to transfer. It is therefore essential that you first replace that file by the newer version before you initialize the transfer.

### Content of the installation USB key

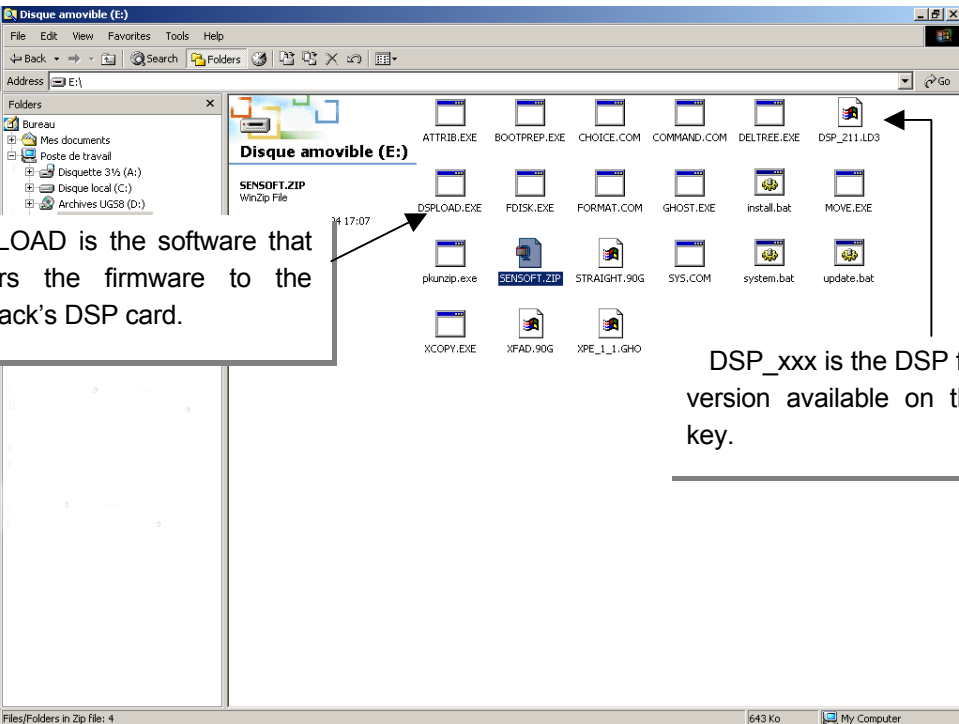

DSPLOAD is the software that transfers the firmware to the audio rack's DSP card.

DSP\_xxx is the DSP firmware version available on the USB key.



DSPxxx.LDn: that is the file you need to transfer to the DSP card.

- xxx: represents the version. Ex: 211 for version 2.11
- n: represents the transfer software version you must use

Your USB key does not necessarily contain the latest firmware version. We advise you to consult our website regularly, and to update these two files of your USB key before initializing the transfer procedure.

### 8.E.1 Launching the « DSP Loader » software

Switch your console off and follow the step by step procedure below to transfer the firmware to the DSP card:

1. Insert your USB key in one of the console's available ports. Launch the console and immediately press **[F8]** or **[F11]** to access the startup menu.

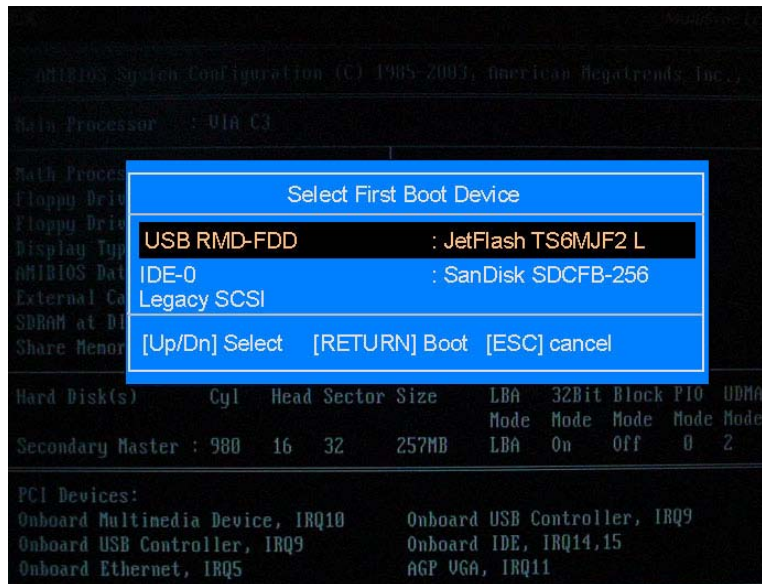

2. As above, select the USB port. Validate with **[ENTER]**.

3. At the root of the temporary Win98 boot, type **“dspload”** and validate with **[ENTER]**



This command takes you to the first window of “DSP Loader”. You are now ready to transfer the firmware version residing on your USAB key to the DSP card installed in your audio rack.

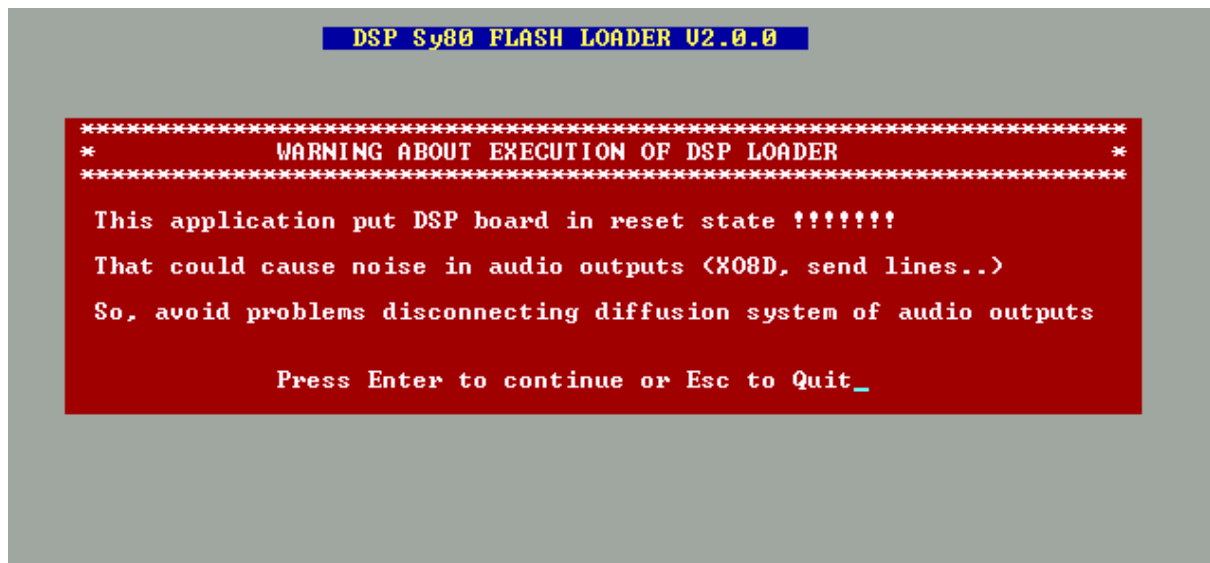

4 Make sure you have no working audio devices connected to the various outputs of your audio racks and press **[ENTER]** to continue.



If no audio system is detected by the software, therefore no DSP card (could be a problem on the serial port, or your audio rack is switched off), the window below is displayed:

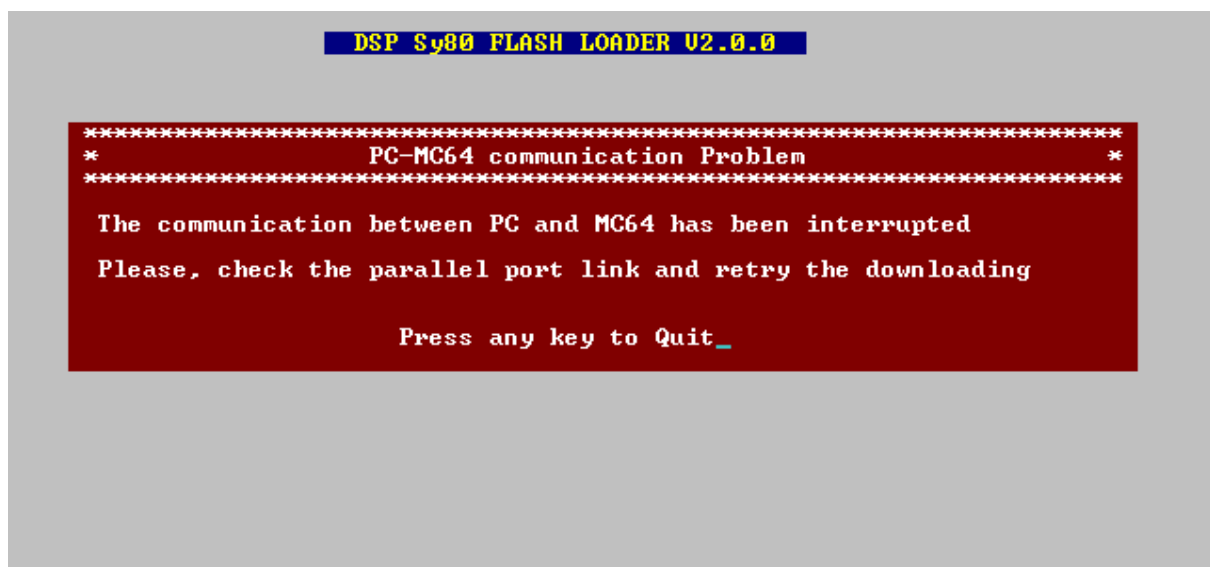

You are now taken to the DSP Loader's main window.

The illustration below explains its various sections:

Your Mix Box is automatically detected and the version of the main elements composing it is displayed. In this example, we can see that the DSP card is already programmed with firmware 1.26.

The firmware version residing in your USB key.

The screenshot shows the DSP Sy80 FLASH LOADER V3.0.0 interface. At the top, a blue bar displays the title. Below it, a gray box contains 'Present versions in your system' with the following text: Version MC64 : 3.2, Download Target : DSPSy80, Sy80 DSP Version : 1.26, Sy80 FPGA Version : 1. To the right, a blue box shows 'Chosen DSP Version : 2.11'. Below these, a cyan box displays 'Sequence Results' with a list: 1. DSP Reset : OK, 2. New version : OK, 3. Flash erasing: No, 4. Downloading : No. To the right of this is a red box with a warning message: '\*\*\*\*\* WARNING \*\*\*\*\*' and 'Replace V1.26 by V2.11'. At the bottom of the red box, it says 'Continue <Enter> or choose an other file <Esc>'. Two callout boxes with lines pointing to the cyan and red boxes contain the text: 'The various programming steps of the process can be followed here.' and 'The main messages are displayed in this area in real time.'

**5.** Press [ENTER] to initiate the programming sequence...

As shown in the illustration below, the first step of the programming consists in erasing the DSP card. This takes a few seconds.

The screenshot shows the DSP Sy80 FLASH LOADER V3.0.0 interface at a later stage. The 'Present versions in your system' and 'Chosen DSP Version : 2.11' sections remain the same. In the 'Sequence Results' cyan box, the status for step 3 has changed to '3. Flash erasing: In progress'. The red warning box now displays '\*\*\*\*\* FLASH ERASING \*\*\*\*\*'.

**6-** Once erased, the file on the USB key is automatically transferred to the DSP card's flash memory. This will take a few minutes (typically 10mn).  
 If, for whatever reason, the system is shut down before the programming process has ended, start again from step one.

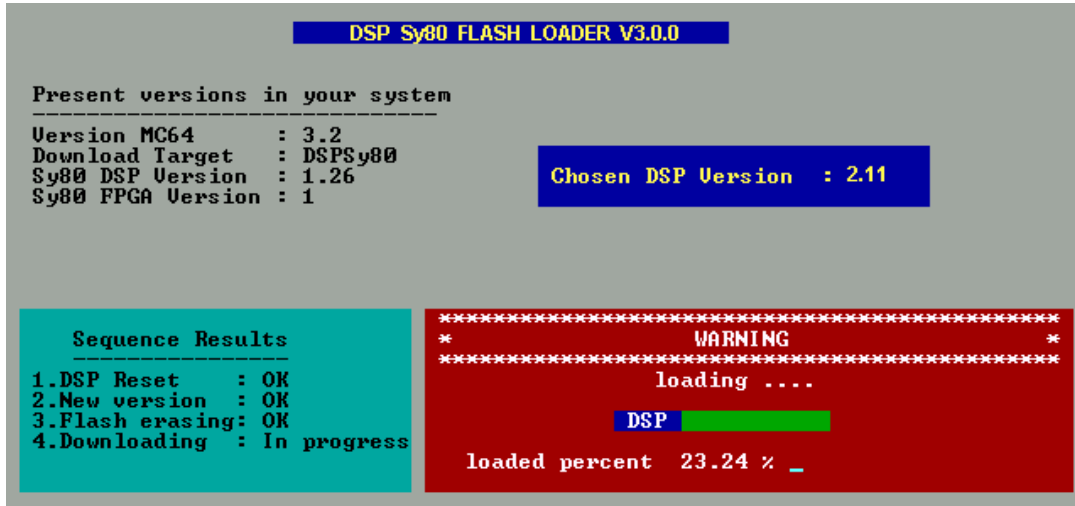

**Do not operate the console if the DSP card has not properly been programmed. This could damage your audio equipment.**

**7-** When the “Successful download” message is displayed, the firmware has been successfully transferred. You can press [ENTER] to quit the « DSP Loader » software and launch Sensoft.

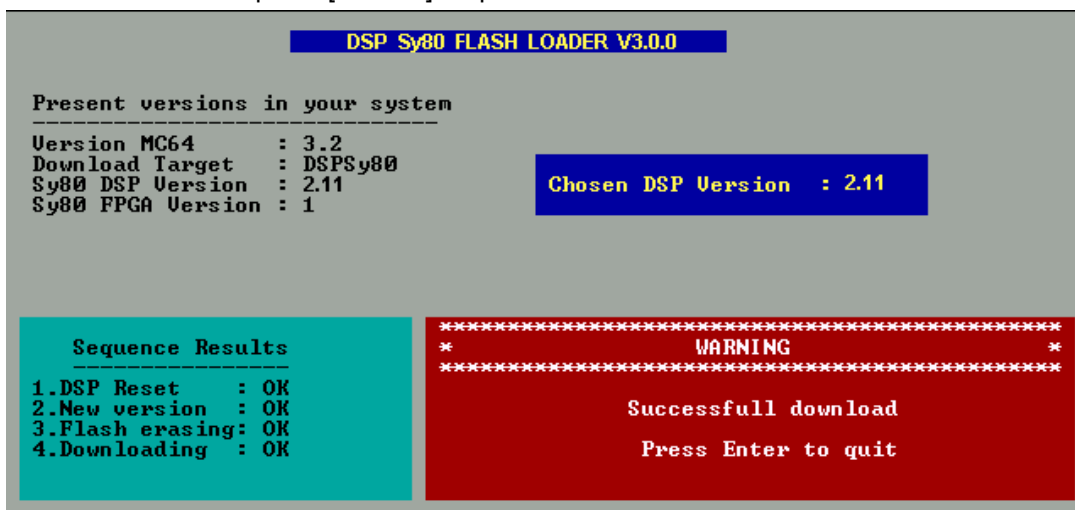

As long as Sensoft hasn't finished initializing the DSP card, a message scrolls on the console's meters. This message indicates the version of the firmware residing in the DSP card's flash memory.

**Reboot your system, the transfer is complete.**

## 8.F Installing Sensoft on an external PC

To install Sensoft on an external PC, to prepare your show for instance, all you need to do is decompress **SENSOFT.ZIP** (downloaded from our web site or taken from the USB key...) in a folder on your hard disk. Once decompressed, the folder should contain about 4 files, one of which is an executable named Sensoft.exe. Once this is done, launch SENSOFT.EXE from within that folder. Depending on your system configuration, you might have to launch Sensoft twice before it runs properly (due to errors in Windows recognizing the software, that occur during the first run)...

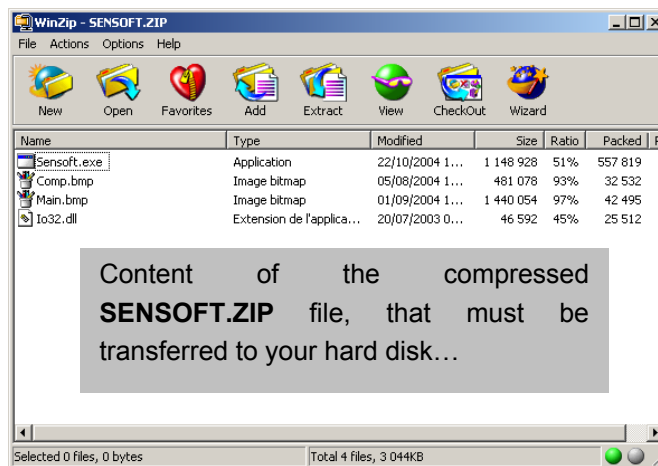

The Windows **XP<sub>E</sub>** operating system installed in the console's internal PC is an XP core assembled by InnovaSON developers, in order to contain only the required elements necessary for managing the Sy48/Sy80 platforms. This is a mandatory condition to guarantee a stable, crash free, system. InnovaSON can not be liable for the instability of the operating system installed on your personal computer, connected to the platform. Our technical support is always ready to help you configure your computer for such a use.

## 9 DESIGN FEATURES OF RACKS AND MODULES

### 9.A INTRODUCTION

InnovaSON products are based on a modular structure which allows the user to easily adapt the configuration of his or her system to the project or event in hand.

In this way, from the audio racks, the input and output modules, and the processing available, a console can interconnect more effectively with other devices in the installation. Analog mic/line inputs, synchronous or sample rate converted AES digital inputs, analog line outputs and simple or processed AES digital outputs, allow the sound engineer or whoever is responsible for the installation to adjust the system according to their needs.

Used in **LOCAL** mode, the console will have its inputs/outputs close to (or within) the control surface, with a "traditional" connection to the classic multi-pairs.

With the **STAGE BOX** option, stage inputs (64 maximum), can be placed close to the sensitive mic sources, converted, and carried in multiplexed digital data blocks on a simple coaxial cable over several hundreds of meters without degradation. The outputs and some inputs, defined as **local**, will be installed in the console's mix rack, to link with effects, inserts, recorders and other equipment which is usually found in a control room.

In this **MASTER** mode, remote inputs and outputs are defined as **distant**, and their parameters (gain, phantom power, patching, etc.) are remotely controlled by the console's software, Sensoft. This remote control is transmitted by a second coaxial cable which also allows the transmission of return channels from the console to the Stage Box.

Signal distribution is also carried out in the digital domain within the Stage Box, and front of house / stage monitoring, sound reinforcement / recording, or sound reinforcement / live TV / radio installation can all benefit from this light, effective and intelligent coaxial cabling system that simplifies the installation and guarantees signal integrity. In all these situations one of the consoles will be **MASTER** (using two coaxial cables) while one, (or possibly two), will be the **SLAVE(s)**, receiving signals from the Stage Box but without having the return signal path that allows remote control.

Each console on this network is autonomous as far as its own mix parameters are concerned, only the parameters of stage inputs and outputs are common, and controlled solely by the **MASTER** console. Of course the consoles can be different InnovaSON models, as their protocols are compatible; but the rules governing input module placement will always apply.



## 9.B Audio Rack and modules

Built to a standard format – 19 inches wide (482 mm), 7U high (312 mm) – the frame is 325 mm (13 inches) deep (see section 2.A). It is designed to house the various modules that make up the required configuration.

The same mechanical rack is used for a Stage Box or a Mix Box, only the DSP and control modules differentiate their use. The audio rack for an Sy40 console is integrated into the rear of the control surface. It is electronically compatible, but mechanically different, see section 2 for details.

Whatever the type of installation, it is essential that the ventilation slots at the front and rear of the unit are kept clear at all times. Similarly, never tamper with the back-plane.

The audio racks have a redundant power supply (2 power supplies per rack) which are changed over manually for CBA96R model and automatically for the newer type, SG3100. To change power supply, make sure that two mains cords, one per power supply, are connected. For a CBA96R, extract, revolve and return the **CHOIX-ALIM** module. The SG3100 however is fully automatic, and LEDs indicate the status of each power supply (green or red).



**Warning : this unit has more than one power connection. Disconnect the two power cords for a complete insulation.**

Two back-planes busses, in the heart of the rack, interconnect to all the modules. 11 connectors (41612 type) on the main bus carry power, control signals and digital audio data. 2 connectors on the auxiliary bus (BUS-2) handle the connection of Mix Box to the control surface, via the 37-pin Jaeger connector fitted on the rear of the rack.

*The CBA96R rack is fitted with a Jaeger rear connector when it's a Mix Box*

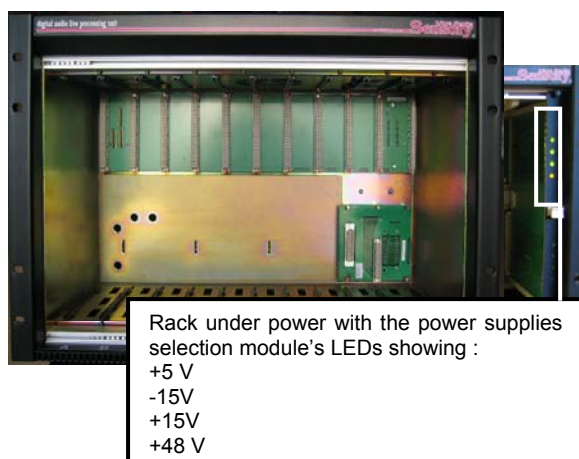

*The new audio rack SG3100 is always fitted with a rear Jaeger connector to be used as a Mix or a Stage Box*

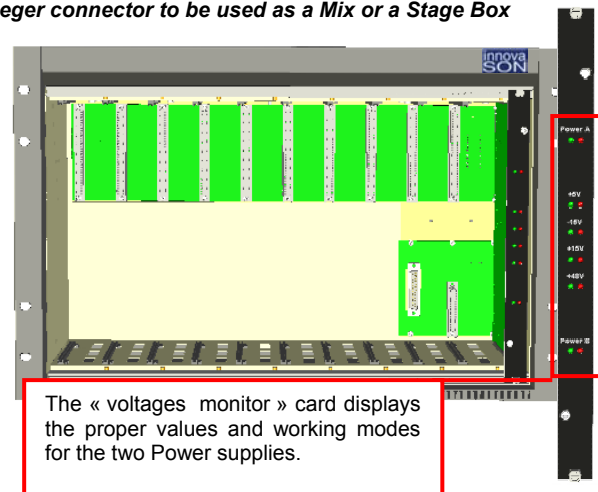

A rack has 3 reserved slots :

- PWR for the Power Supply choice module or monitor card (see above)
- PROCESSING for the processing module of a Mix Box (not used in a Stage Box)
- CTRL for the control module (MC-64 for a Mix Box, SC-64 for a Stage Box).

And 8 slots designated A to H for the audio input output modules.

### 9.B.1 SI-8D module (8 mic/line analogue input)

This module converts incoming signals in digital. The front panel has :

- Eight XLR female connectors, numbered 1 to 8
- Close to each connector, a green led for signal presence, a red led for clipping and a yellow led for Phantom Power. The RED one is important as it indicates an analogue pre-amp clipping, before the digital conversion. If it lit on, the pre-amp gain must be reduced, in extreme cases a 10 dB passive attenuator may be used.

This module may receive 8 analogue signals with following characteristics :

- Nominal sensitivity 12 dBu (gain at 0dB)
- Programmable gain ( 3 dB steps) from -27 to + 63 dB, sensitivity from -51 to + 26 dBu
- Balanced inputs, phantom power supply (+ 48V) switchable
- Analogue to digital conversion : 20 bits, 48 kHz, Delta-sigma (64 over-sampling).

#### Installation

The SI-8D module may be installed in any of the slots A to H in either audio rack, Stage Box or Mix Box. Attention, a system with SI-8D and SI-8D3 together has phase drifts because of conversion delays different between modules. (See specifications in section 9.E.2).

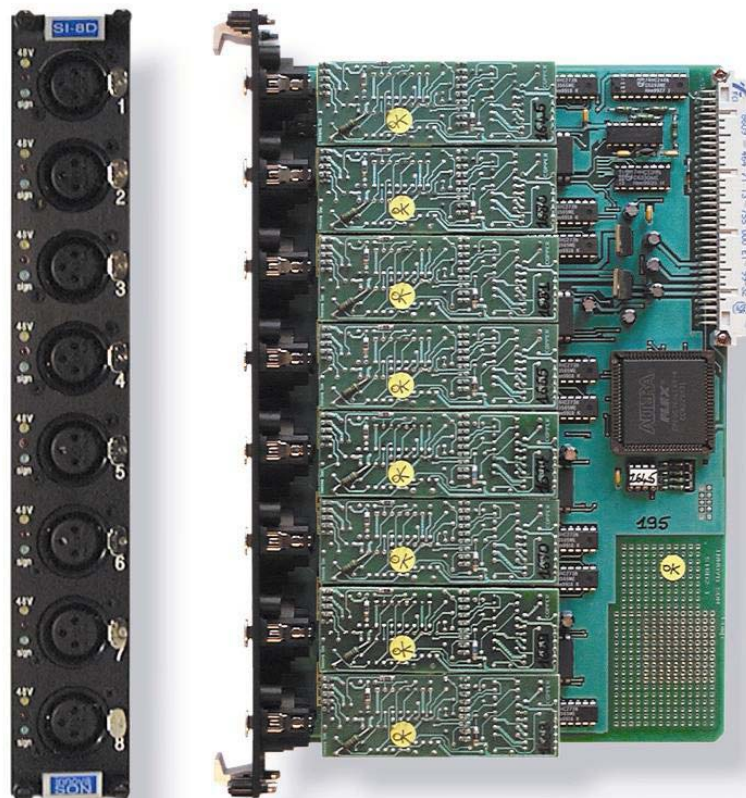

### 9.B.2 SI-8D3 module (8 mic/line analogue inputs)

This module converts incoming signals in digital. The front panel has :

- Eight XLR female connectors, numbered 1 to 8
- Close to each connector, a green led for signal presence, a red led for clipping and a yellow led for Phantom Power. The RED one is important as it indicates an analogue pre-amp clipping, before the digital conversion. If it lit on, the pre-amp gain must be reduced, in extreme cases a 10 dB passive attenuator may be used.

This module may receive 8 analogue signals with following characteristics :

- Nominal sensitivity 12 dBu (gain at 0dB)
- Programmable gain (1.5 dB steps) from -27 to + 64.5 dB, sensitivity from -52.5 to + 26 dBu
- Balanced inputs, phantom power supply (+ 48V) switchable
- Analogue to digital conversion : 24 bits, 48 kHz, Delta-sigma (128 over-sampling).

#### Installation

The SI-8D3 module may be installed in any of the slots A to H in either audio rack, Stage Box or Mix Box. Attention, a system with SI-8D and SI-8D3 together has phase drifts because of conversion delays different between modules. (See specifications in section 9.E.2).

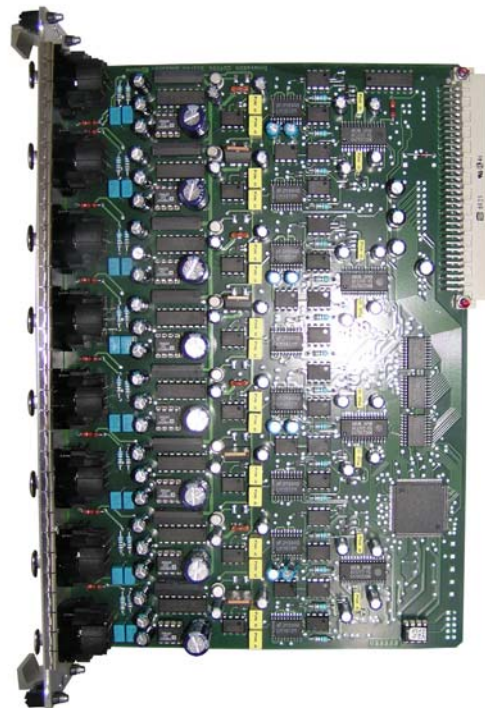

### 9.B.3 MO-8D3 module (8 analogue outputs)

This module converts digital signals from the system to analogue.

On the front of the module there are eight XLR male connectors, numbered 1 to 8.

The module distributes eight analogue outputs :

- Balanced outputs, adjustable levels by « jumper » +11.5, +18, +22 dBu (default) for 0 dBFS
- Programmable mute on each output
- Programmable patch with Sensoft software
- Digital /analogue conversion: 24 bits, 48 kHz, Delta-sigma (128 over-sampling).

#### Installation

The MO-8D3 module may be installed in any of the slots A to H in either audio rack, Stage Box or Mix Box.

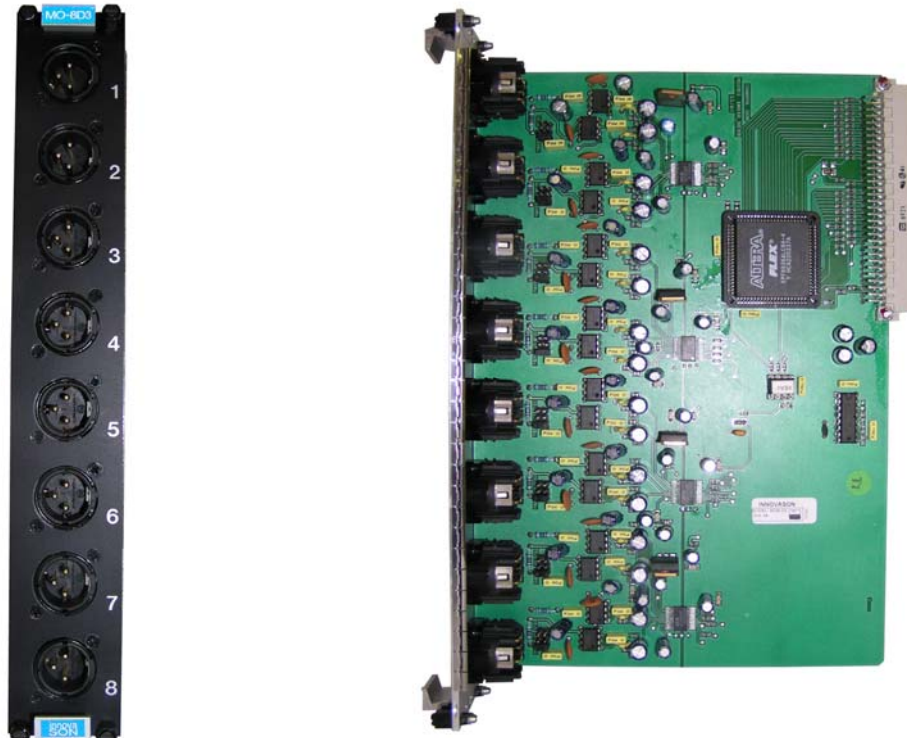

### 9.B.4 XO-8D2 module (8 analogue outputs with Hyperdrive)

The XO-8D2 card is a module of 8 analogue balanced outputs with processing for each output :

- Maximum output level adjustable with Sensoft from 10.5 to 22 dBu ( 0.5 dB steps)
- Digital to analogue conversion : 24 bits, 48kHz, Delta-sigma (128 over-sampling)
- 8 full bands parametric equalizer
- A compressor and a gate independent for each output
- 1300 ms of delay for each output adjustable with one sample steps
- Digital signal processing are acheived with two DSP
- Programmable Mute for each output.

#### Installation

Works only in Mix Box in slots lettered 'A' to 'H'.

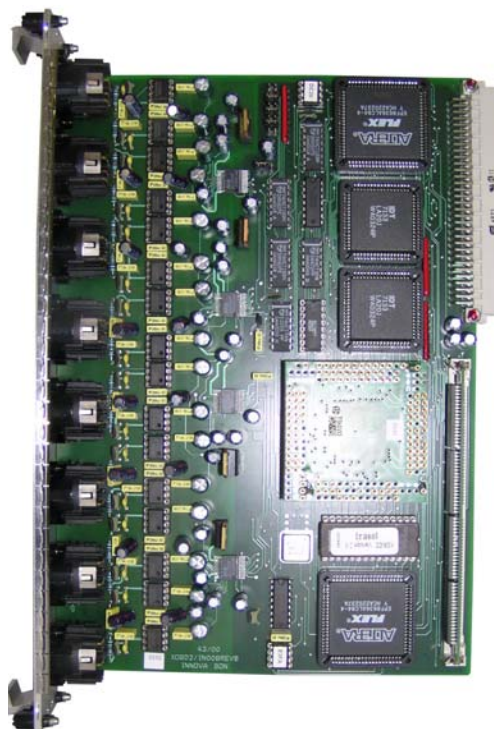

### 9.B.5 DI-8S module (8 synchronous AES digital inputs)

This module converts AES digital incoming signals. On the front of the module there are four female XLR connectors numbered from 1/2 to 7/8 :

This receives 4 AES frames (or eight different audio signals) :

- Programmable sensitivity from +6 to -6 dB with 0.1 dB steps
- Balanced inputs 110  $\Omega$ , sensitivity and levels according to AES standard
- Sampling synchronous according to internal or external system sampling frequency.
- Programmable delay from 0 to 5 ms (one sample step)

**Remark :** When DI-8S cards are installed in a Stage Box, they are recognized as SI-8D cards by Sensoft.. Gain is fixed at 0 dB and delay is fixed a 0.

**Installation :** The DI-8S module may be installed in any of the slots A to H of the Stage Box or the Mix Box according to the switch position located on the card.

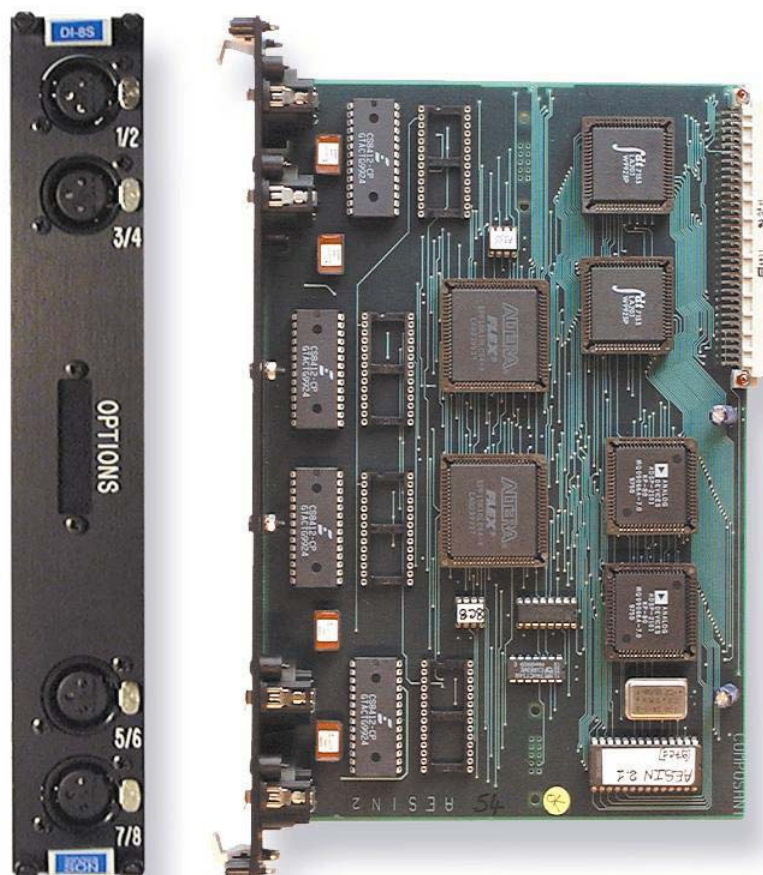

### 9.B.6 DI-8Src module (8 asynchronous AES digital inputs)

This module converts asynchronous AES digital incoming signals. On the front of the module there are four female XLR connectors numbered from 1/2 to 7/8 :

This receives 4 AES frames (or eight different audio signals) :

- Programmable sensitivity from +6 to -6 dB with 0.1 dB steps
- Balanced inputs 110  $\Omega$ , sensitivity and levels according to AES standard
- Sampling asynchronous and independent of system sampling frequency.
- Programmable delay from 0 to 5 ms (one sample step)

**Remark** : When DI-8S cards are installed in a Stage Box, they are recognized as SI-8D cards by Sensoft. Gain is fixed at 0 dB and delay is fixed a 0.

**Installation** : The DI-8Src module may be installed in any of the slots A to H of the Stage Box or the Mix Box according to the switch position located on the card.



### 9.B.7 DO-8A module (8 synchronous digital AES outputs)

This module converts digital audio signals leaving the system to the AES format. On the front there are four male XLR connectors numbered from 1/2 to 7/8.

This module distributes 4 AES frames (or eight audio signals) :

- Balanced outputs 110  $\Omega$ , levels compliant to AES standard
- Synchronous with system general sampling frequency
- Programmable output patch
- Programmable output Mute

**Remark :** When DO-8A cards are installed in a Stage Box, they are recognized as MO-8D cards by Sensoft.

**Installation :** The DO-8A module may be installed in any of the slots A to H of the Stage Box or the Mix Box according to the switch position located on the card.

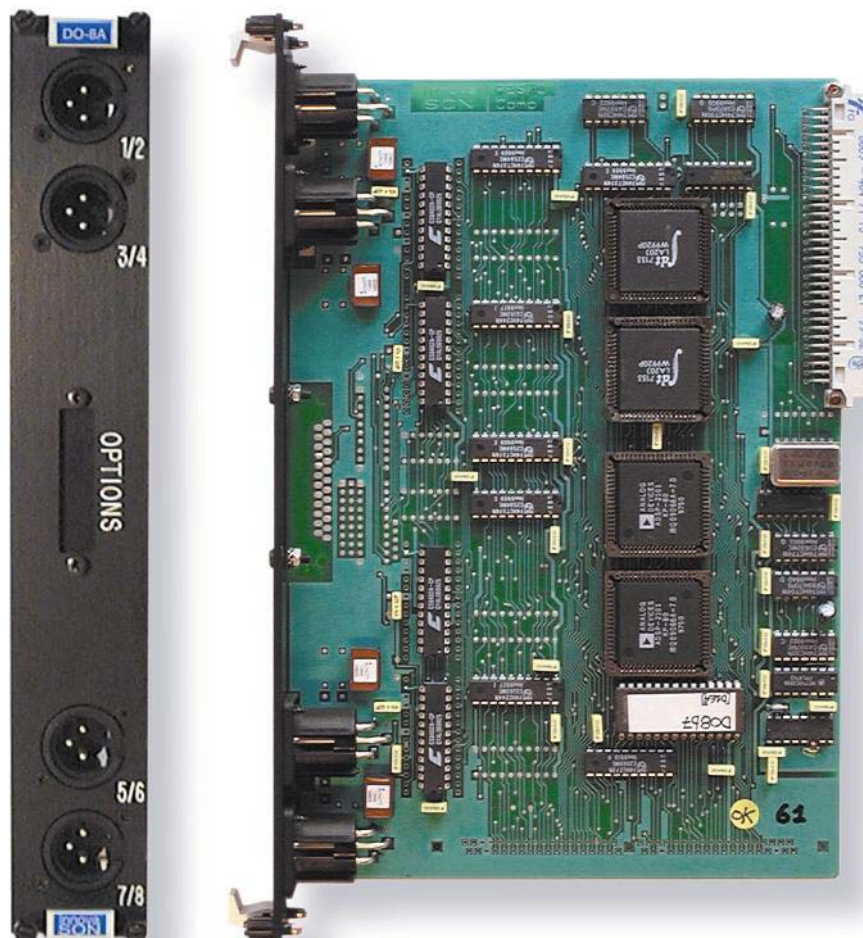



### 9.B.8 DO-8X module (8 synchronous digital AES outputs with hyperdrive)

The DO-8X module has 4 digital AES output with signal processing for each of the 8 channels. On the front there are 4 male XLR connectors numbered from 1/2 to 7/8.

- Balanced outputs 110  $\Omega$ , levels compliant with AES standard
- Output level attenuator from 0 to -11.5 dB with 0.5 dB steps
- Sampling synchronous with system sampling frequency
- 8 Full bands parametric equalizer.
- Compressor and gate independent for each channel
- 1300 ms of delay for each channel adjustable with one sample steps
- Digital signal processing is achieved with two DSP chips
- Programmable Patch and Mute for each channel

**Installation** : Works only in Mix Box in slots lettered 'A' to 'H'. DO-8X modules are recognized by Sensoft as XO-8D.



### 9.B.8B DO-8XES module (8 AES channels and EtherSound network)

The DO-8XES module simultaneously outputs 8 processed audio channels to 4 pairs of AES digital outputs (via 4 XLR) and the EtherSound Network via the RJ45 'EtherCon'<sup>™</sup> front panel connectors. Each of the eight channels has the following features:

- Balanced outputs 110  $\Omega$ , AES standard levels, synchronous with the EtherSound network.
- Sampling frequency asynchronous from the system general clock and synchronous with the EtherSound general sampling frequency (integrated Sample Rate Converter)
- Output attenuation from 0 to -11.5 dB with 0.5 dB steps
- Parametric equalizer - 8 fully independent bands
- An independent compressor and gate for each output
- A 1.3 s delay per output, one sample adjustable
- Patch and mute programmable for each output
- The EtherSound network access is achieved with an integrated MSX88 module from Digigram

The **DO-8XES** modules are designed to work in slots 'A' to 'H' of the Mix Box. DO-8XES modules are detected and controlled by Sensoft in the same way as XO-8D cards.

If the FROM connector has no signal or an ES Control frame, the DO-8XES module is '**Primary Master**' and the Network Clock is internal from the rack. If an EtherSound frame is received, the module is '**Master**', locks on the network clock and daisy-chains with it.

A coding wheel is used to configure the module and define the 8 EtherSound channels used on the network.

Hardware positions 0 to 7, assign the 8 EtherSound consecutive channels to be driven by the module as follows:	
Position	Module EtherSound channels
0	1 2 3 4 5 6 7 8
1	9 10 11 12 13 14 15 16
2	17 18 19 20 21 22 23 24
3	25 26 27 28 29 30 31 32
4	33 34 35 36 37 38 39 40
5	41 42 43 44 45 46 47 48
6	49 50 51 52 53 54 55 56
7	57 58 59 60 61 62 63 64
8 or 9	EtherSound channels assigned by ES-Control software

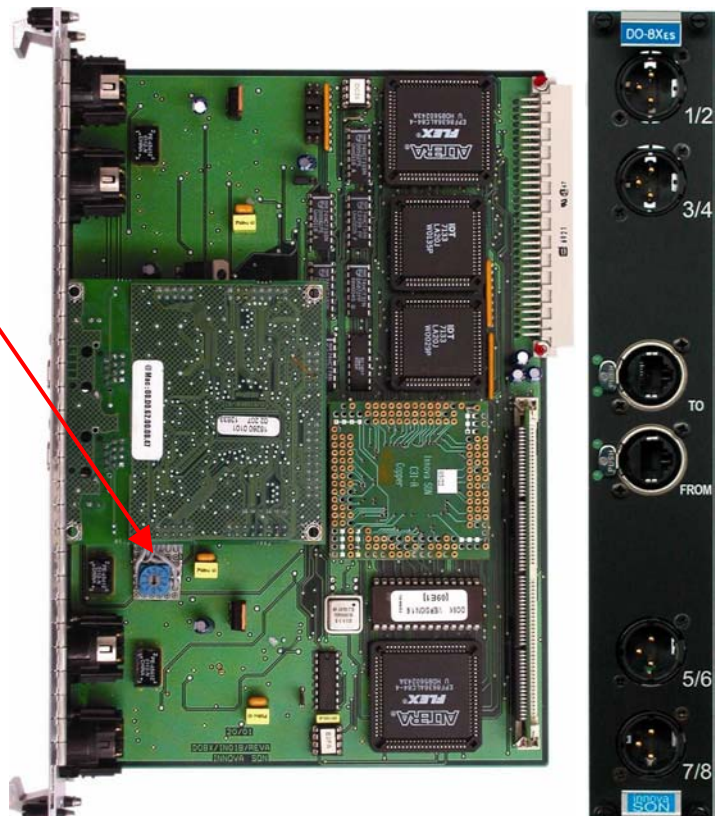

See section 9.E.4, [www.digigram.com](http://www.digigram.com) and the EtherSound user's manuals for network set-up and complementary instructions.



### 9.B.9 DSP Sy80 module (signal processor for Sy80 console and Sensoft 8.1)

This module is the heart of an Sy80 console. Its mission is to run and manage the following audio processing :

- 80 inputs (patch, delay, phase, low-cut, noise-gate, compressor, 4 bands parametric equalizer)
- 48 mix busses
- Stereo bus and converter for the monitor circuit available on both 1/4" jacks on the console
- Test signal generation ( sine oscillator or white/ pink noise)
- Management of 82 meters on the control surface (73 for Sensory Essential)
- Talk Back input, available on the 2 XLR3 connectors on the console's front.
- Converters for 16 line inputs and 16 line outputs.

The digital signal processing is floating decimal point, 32/40 bits. The internal processing software is re-programmable and stored in flash memory. A specific procedure is required to update this software.

On the front of the module are 3 red/green LEDs indicating the status of the module, and 4 Sub-D25 connectors, 2 male connectors for 16 line level outputs (SL), and 2 female connectors for 16 line level inputs (RL).

Four XLR interface cables are supplied with the console, the pin-outs for these connectors are detailed below :

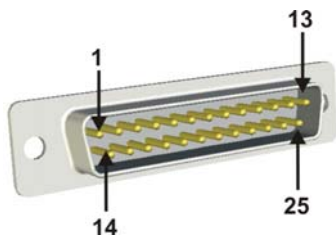

- Pin 1 : Output 8 +
- Pin 2 : Output 8 gnd
- Pin 3 : Output 7 -
- Pin 4 : Output 6 +
- Pin 5 : Output 6 gnd
- Pin 6 : Output 5 -
- Pin 7 : Output 4 +
- Pin 8 : Output 4 gnd
- Pin 9 : Output 3 -
- Pin 10 : Output 2 +
- Pin 11 : Output 2 gnd
- Pin 12 : Output 1 -
- Pin 13 : NC

- Pin 14 : Output 8 -
- Pin 15 : Output 7 +
- Pin 16 : Output 7 gnd
- Pin 17 : Output 6 -
- Pin 18 : Output 5 +
- Pin 19 : Output 5 gnd
- Pin 20 : Output 4 -
- Pin 21 : Output 3 +
- Pin 22 : Output 3 gnd
- Pin 23 : Output 2 -
- Pin 24 : Output 1 +
- Pin 25 : Output 1 gnd

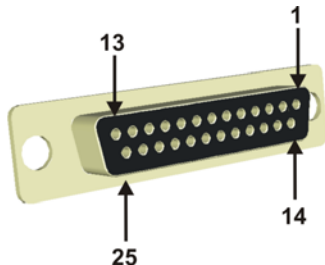

- Pin 3 : Input 7 -
- Pin 4 : Input 6 +
- Pin 5 : Input 6 gnd
- Pin 6 : Input 5 -
- Pin 7 : Input 4 +
- Pin 8 : Input 4 gnd
- Pin 9 : Input 3 -
- Pin 10 : Input 2 +
- Pin 11 : Input 2 gnd
- Pin 12 : Input 1 -
- Pin 13 : NC

- Pin 16 : Input 7 gnd
- Pin 17 : Input 6 -
- Pin 18 : Input 5 +
- Pin 19 : Input 5 gnd
- Pin 20 : Input 4 -
- Pin 21 : Input 3 +
- Pin 22 : Input 3 gnd
- Pin 23 : Input 2 -
- Pin 24 : Input 1 +
- Pin 25 : Input 1 gnd



**Installation :** It is imperative that the DSP Sy80 module is installed in the PROCESSING slot of a Mix Box.

### 9.B.10 DSP Sy40-8 module (signal processing for Sy40 console and Sensoft 8.1)

This module is the heart of an Sy40 console. Its mission is to run and manage the following audio processing :

- 48 inputs(patch, phase, low-cut, noise-gate, compressor, 4 bands parametric equalizer)
- 26 mix busses
- Stereo monitoring bus
- Test signal generation (sine oscillator or white/ pink noise)
- Management of 47 meters on the control surface
- Talk Back input pre-amp and converter, XLR3 only present on the front of this module
- Converters for 8 line inputs.

The digital signal processing is floating decimal point, 32/40 bits. The internal processing software is stored in EEPROM memory. A security circuit (watchdog) can be customized by jumpers..

On the front of the module is a red LED indicating the module's reset, 1 female XLR3 connector for the talkback input, and 1 Sub-D25 female connector for 8 line inputs (RL).

An XLR interface cable is supplied with the console, the connector pin-outs are detailed below :

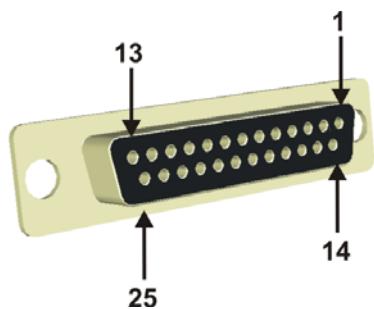

Pin 1 : Input 1 +  
 Pin 2 : Input 2 +  
 Pin 3 : Input 3 +  
 Pin 4 : Input 4 +  
 Pin 5 : Input 5 +  
 Pin 6 : Input 6 +  
 Pin 7 : Input Common gnd  
 Pin 8 : Input 7 +  
 Pin 9 : Input 8 +  
 Pin 10 : NC  
 Pin 11 : NC  
 Pin 12 : NC  
 Pin 13 : NC

Pin 14 : Input 1 -  
 Pin 15 : Input 2 -  
 Pin 16 : Input 3 -  
 Pin 17 : Input 4 -  
 Pin 18 : Input 5 -  
 Pin 19 : Input 6 -  
 Pin 20 : Input 7 -  
 Pin 21 : Input 8 -  
 Pin 22 : Input NC  
 Pin 23 : Input NC  
 Pin 24 : Input NC  
 Pin 25 : Input NC



**Installation :** The Sy40-8 module must be installed in its reserved slot, named DSP, in a Sy40 console.

**9.B.11 DM-Mk9 module (Sensory Live, Sensoft 7 signal processing )**

This module is the processing core of the Sensory Live console, it executes and manages the following audio processing :

- 48 inputs (patch, phase, low-cut, noise-gate, compressor, 4 bands parametric equalizer)
- 23 mixing busses (LRM, 20 auxiliaries)
- The stereo monitor bus
- The test signal generation (Sine oscillator)
- Control surface's 73 bar-graphs
- The Talk Back input on the console's front XLR3
- The 8 analogue to digital line inout converters.

The digital signals are processed in floating point precision 32/40 bits. The internal processing software is stored on an EEPROM chip. A security circuit (watch-dog) is jumper programmable.

On the front of the module, there are 1 red LED which indicates module's reset, 1 XLR female Talk Back microphone connector and 1Sub-D25 female connector for 8 line inputs (R.L.).

The XLR interface cable is delivered with the console, cabling is as follows :

Audio XLR	Connector Sub-D25		Audio XLR
NC	P13	P25	NC
NC	P12	P24	NC
NC	P11	P23	NC
NC	P10	P22	NC
RL8 +	P09	P21	RL8 -
RL7 +	P08	P20	RL7 -
Common GND	P07		
RL6 +	P06	P19	RL6 -
RL5 +	P05	P18	RL5 -
RL4 +	P04	P17	RL4 -
RL3 +	P03	P16	RL3 -
RL2 +	P02	P15	RL2 -
RL1 +	P01	P14	RL1 -

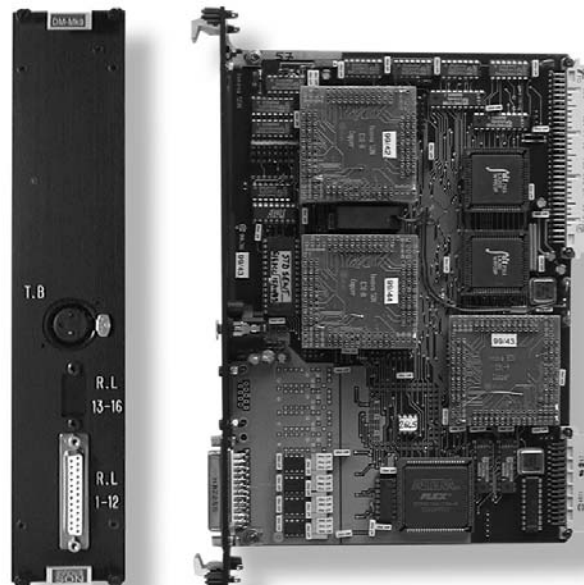

**Installation :** The DM-Mk9 module must be installed in the reserved slot named PROCESSING of the Mix Box.

### 9.B.12 MCSC Optical (Mix Box and Stage Box controller)

This module provides control of the other modules, and data transmission between them. Effectively it is the relay station between Sensoft and modules in the Mix Box, and a Stage Box when connected. This module undertakes numerous functions:

- Stage box inputs digital frames reception.
- Local inputs transmission to the Stage Box.
- Remote controls transmission to the Stage Box cards.
- Remote controls distribution for the local cards in the Mix Box.

Optical fibre interface characteristics	Coaxial interface characteristics	Synchro and global characteristics
Connectors: ST	Connectors: Cable – BNC Neutrik Push-Pull Socket – BNC jack filter converter	WC I/O: 75Ohm adapted and isolated by transformer BNC input and output TTL standard (0/5V)
Fibre: Multimode Ø50/120µm Lambda= 1300nm		
Latency: 0.5µs / 100m + 1.2µs	Latency: 0.43µs / 100m + 1.2µs	AES: Standard 110 Ohm AES Input isolated for clock extraction and synchronisation
Max length: 400m in Master mode 2000 in Slave mode	Max length: 500m in Master and Slave mode	
Option: 1U 19" unit equipped with SC to EBC lens connector converter	Signal: 125MHz - 100 Mb/s Magnitude 1.6 Vcc RX and TX stages are isolated and protected by transformer Auto equalizing system, no adjustments to do	SPLIT: 3-way digital split when SC function (2 coax and 1 optical simultaneously) Off-Line programming on PC

**Installation :** The MCSC Optical module must be installed in its reserved place, the CTRL slot in a Mix Box or a Stage Box. The 41612-type connector provides access to the audio bus, the SUB-D25 connects to BUS-2.

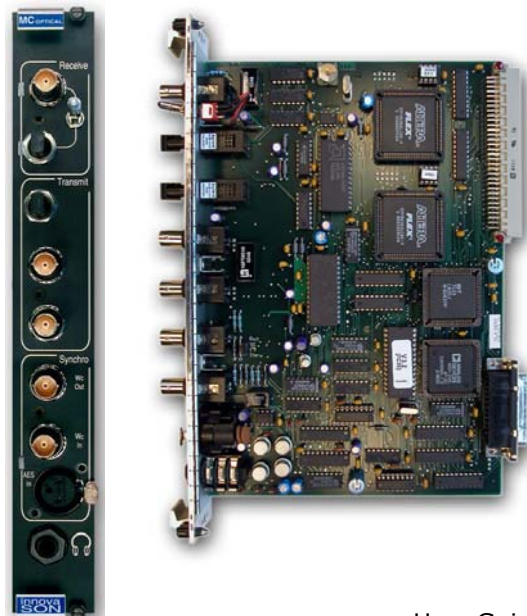

The SC or MC behavior of the module is given by a switch position and the SC or MC Eprom installed on the module.

### 9.B.12B MC-64 module (Mix Box controller)

This module is in charge of the other modules remote control and the transmission. It is the relay between Sensoft and the cards of the Mix Box or the Stage box. It manages several functions:

- Stage box inputs digital frames reception
- Local inputs transmission to the Stage Box
- Remote controls transmission to the Stage Box cards
- Remote controls distribution for the local cards in the Mix Box.

The front panels connectors are :

**BNC connectors** : Transmission and reception of the digital frames between the boxes 2 RX and 2 TX. A switch located above the RX BNC gives the selection for the active reception input. RX1 is adjustable (see section 9.D) for various cable lengths and qualities, RX2 is optimized for the 150 m standard cable delivered with a Stage Box. Each of these RX BNC connectors has 3 leds :

**Led :**

- Green led: Normal case, transmission without errors
- Red led : Transmission errors
- Yellow led (HL) : increased sensitivity for long distance transmission (>300 m), configuration by switch located behind the front panel on the copper side of the module.

**3.5 mm jack** : Synchronisation input for the rack with TTL word clock format from 44 to 49 kHz (option for AES format). The SYNC led, close to the jack, indicates a valid and operational synchronisation signal.

**1/4 inch jack** : Headphone output (not used on Sy80, available on the Sy40 front).

**Installation** : The MC-64 module must be installed in the reserved slot, named CTRL of a Mix Box. The DIN 41612 connector gives access to the audio bus, the Sub-D25 connects to the BUS-2.

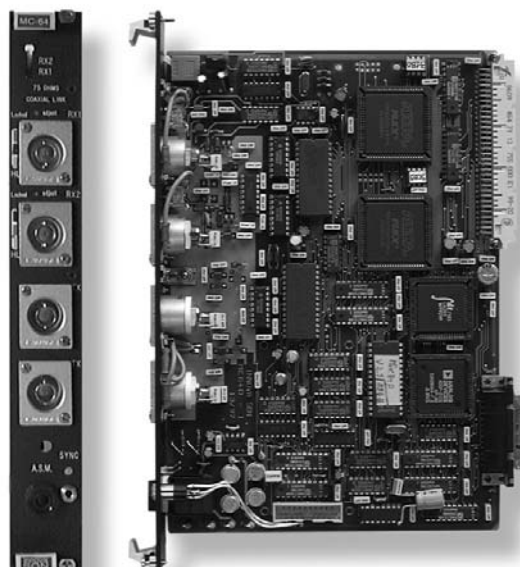





### 9.B.13 SC-64 module (Stage Box controller)

This module is in charge of the Stage Box control and transmission splitting on 2 directions. It has the following functions :

- Transmission and distribution of the digital frames from the Stage Box input modules
- Reception of the digital frames coming from the Master Mix Box which is connected
- Reception and acknowledgement of the remote control data received from the Mix Box
- remote controls distribution to the Stage Box modules.

The front panels has several connectors with following functions :

**BNC connectors** : Transmission and splitting distribution of the digital frames on TX1 and TX2. Reception of the digital frames from the Master Mix Box on RX1 or RX2. A switch above the two BNC RX connectors selects the active reception BNC. RX1 is adjustable (see section 9.D) for variable cable lengths and specifications. RX2 is fixed and optimised for the 150 m delivered with the Stage Box. Each of these RX BNC connectors has 3 leds :

**Leds :**

- Green led: Normal case, transmission without errors
- Red led : Transmission errors
- Yellow led (HL) : increased sensitivity for long distance transmission (>300 m), configuration by switch located behind the front panel on the copper side of the module.

**3.5 mm jack** : Synchronisation input for the rack with TTL word clock format from 44 to 49 kHz (option for AES format). The SYNC led, close to the jack, indicates a valid and operational synchronisation signal. The Stage Box distributes the synchronisation signal to all the Mix Boxes connected (Master or Slave) and it receives the external synchronisation signal for the whole system.

**1/4 inch jack** : Headphone output not used.

**Installation** : The SC-64 module must be installed in the slot named CTRL of a Stage Box. The DIN 41612 connector gives access to the audio bus, the Sub-D25 connects to the BUS-2 (not used).

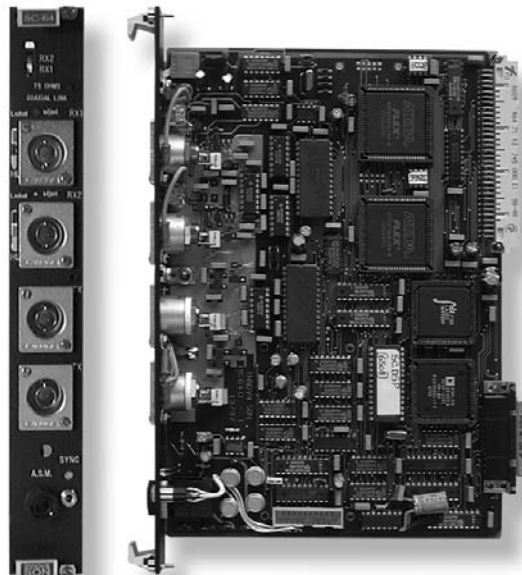

### 9.B.14 SC-64 3tx module (Stage Box controller 3 splits)

This module is in charge of the Stage Box control and transmission splitting on 3 directions. It has the following functions :

- Transmission and distribution of the digital frames from the Stage Box input modules
- Reception of the digital frames coming from the Master Mix Box which is connected
- Reception and acknowledge of the remote control data received from the Mix Box
- Remote controls distribution to the Stage Box modules.

The front panels has several connectors with following functions :

**BNC connectors** : Transmission and splitting distribution of the digital frames on TX1, TX2 and TX3. Reception of the digital frames from the Master Mix Box on RX1 or RX2. A switch above the two BNC RX connectors selects the active reception BNC. RX1 is adjustable (see section 9.D) for variable cable lengths and specifications. RX2 is fixed and optimised for the 150 m delivered with the Stage Box. Each of these RX BNC connectors has 3 leds :

#### Leds :

- Green led: Normal case, transmission without errors
- Red led : Transmission errors
- Yellow led (HL) : increased sensitivity for long distance transmission (>300 m), configuration by switch located behind the front panel on the copper side of the module.

**3.5mm jack** : Synchronisation input for the rack with Word Clock TTL format from 44 to 49 kHz (option for AES format). The SYNC led, close to the jack, indicates a valid and operational synchronisation signal. The Stage Box distributes the synchronisation signal to all the Mix Boxes connected (Master or Slave) and it receives the external synchronisation signal for the whole system.

**Installation** : The SC-64 module must be installed in the slot named CTRL of a Stage Box. The DIN 41612 connector gives access to the audio bus, the Sub-D25 connects to the BUS-2 (not used).

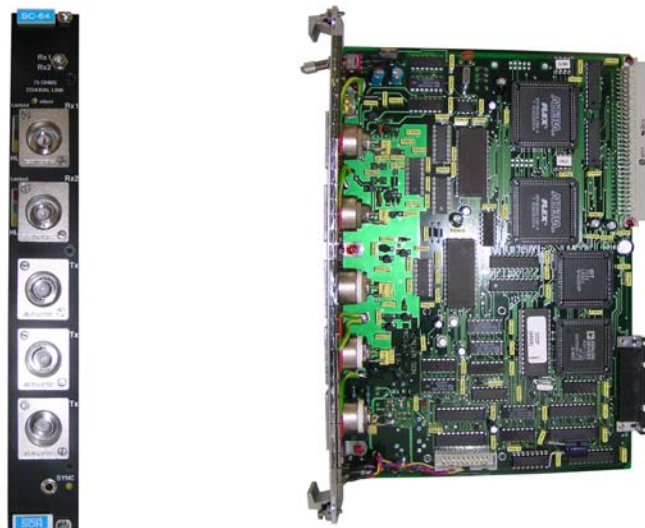

**9.B.15 Sync-A module (AES synchronisation option)**

This daughter board is installed on a MC-64, SC-64 or SC-64-3 module to receive and convert an AES format synchronisation signal added to the Word-Clock TTL format that is accepted by these controllers board as standard.

The 3 pins of the SYNC connector are used to connect the incoming AES signal (balanced with ground) used to synchronise the system. The Word Clock TTL use is still possible, using the hot and the ground pins of this connector.

If a valid incoming AES signal is detected, the system locks on it and the SYNC led lit on. This AES signal has priority on the TTL word Clock that would be applied simultaneously.

When a Stage Box is used, it generates and distributes the synchronisation to the whole system and the optional Sync-A module must be placed on the Stage Box controller, SC-64. In this case, the SYNC input (Word Clock or AES) of the Mix Box(es) is not valid and their corresponding led(s) are off.

The following cabling is recommended between the 3.5 mm Jack and a male XLR (usual AES connector).

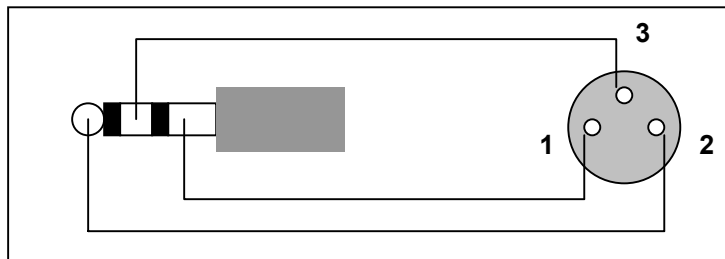

**Installation :** The daughter board Sync-A must be installed by an approved and authorized technician or, preferably, during the system manufacturing. This card is installed on a MC-64, SC-64 or SC-64-3 on the reserved place as the following photo shows :

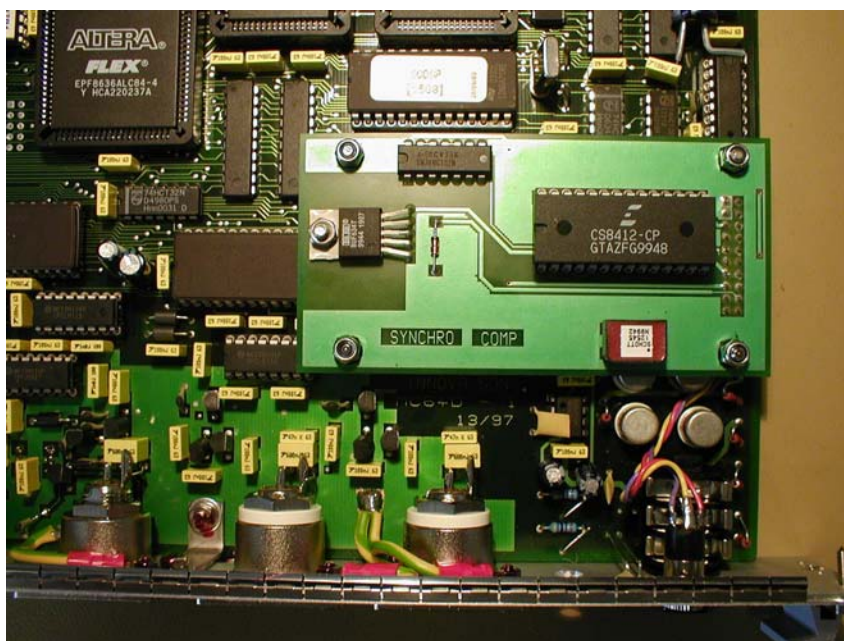

## 9.C System configuration and installation

An InnovaSON console is delivered with the following basis modules : a controller, MC-64 for the Mix Box and a mixing and processing module DSP: Sy80, Sy40-8 or DM-Mk9. The audio rack, totally modular, is configured according to the needs of the user and the application with inputs and outputs, analogue or digital, to be defined in the mix position.

For a **local** use (without digital Stage Box transmission) the Mix Box will be preferably fitted with output modules from slots A to x and input modules from x+1 to H. This will facilitate a possible Stage Box connection without too much changing to stay compatible.

With a Stage Box, you must define :

- How many inputs and outputs are used on stage
- How many mix positions share the Stage Box (FOH, Monitors, Recording..)
- Which console is MASTER of the Stage Box (and has return audio channels to it).

### 9.C.1 General rule for using the Stage Box

The total amount of inputs between the Stage Box and each Mix Box is 64, if 48 inputs are installed in the Stage Box, 16 inputs maximum will be possible in each Mix Box. And the Stage Box, connected to one or several Mix Box(es) must be configured as follows :

The input modules (SI-8D, DI-8S, DI-8Src) must be placed contiguously from the slot A to the next used slot (for example slot F for 48 stage inputs).

The Stage Box transmits only the contiguous input modules detected from slot A and the data stream stops when an empty slot or an output module is detected.

So an empty slot or an output module is strictly forbidden in the middle of input modules.

The Stage Box next free slots (G and H) are used for output modules (MO-8D3, DO-8A), or blank panels according to the use.

Each Mix Box (or Sy40) connected to this Stage Box may be equipped with input modules (SI-8D, DI-8S, DI-8Src) in the slots that are different of the Stage Box ones fitted with inputs (G and H in this example).

Sensoft will display a configuration error if a local input module is detected "in front" of a Stage one. Of course, these slots are usable for output modules (MO-8D, XO-8D2, DO-8A, DO8-X) or blank panels.

In the following example, illustrated below, the Stage Box, fitted with 48 inputs and 16 outputs, may be used and connected to Mix Box(es) with their slots A to H empty or equipped with output modules.

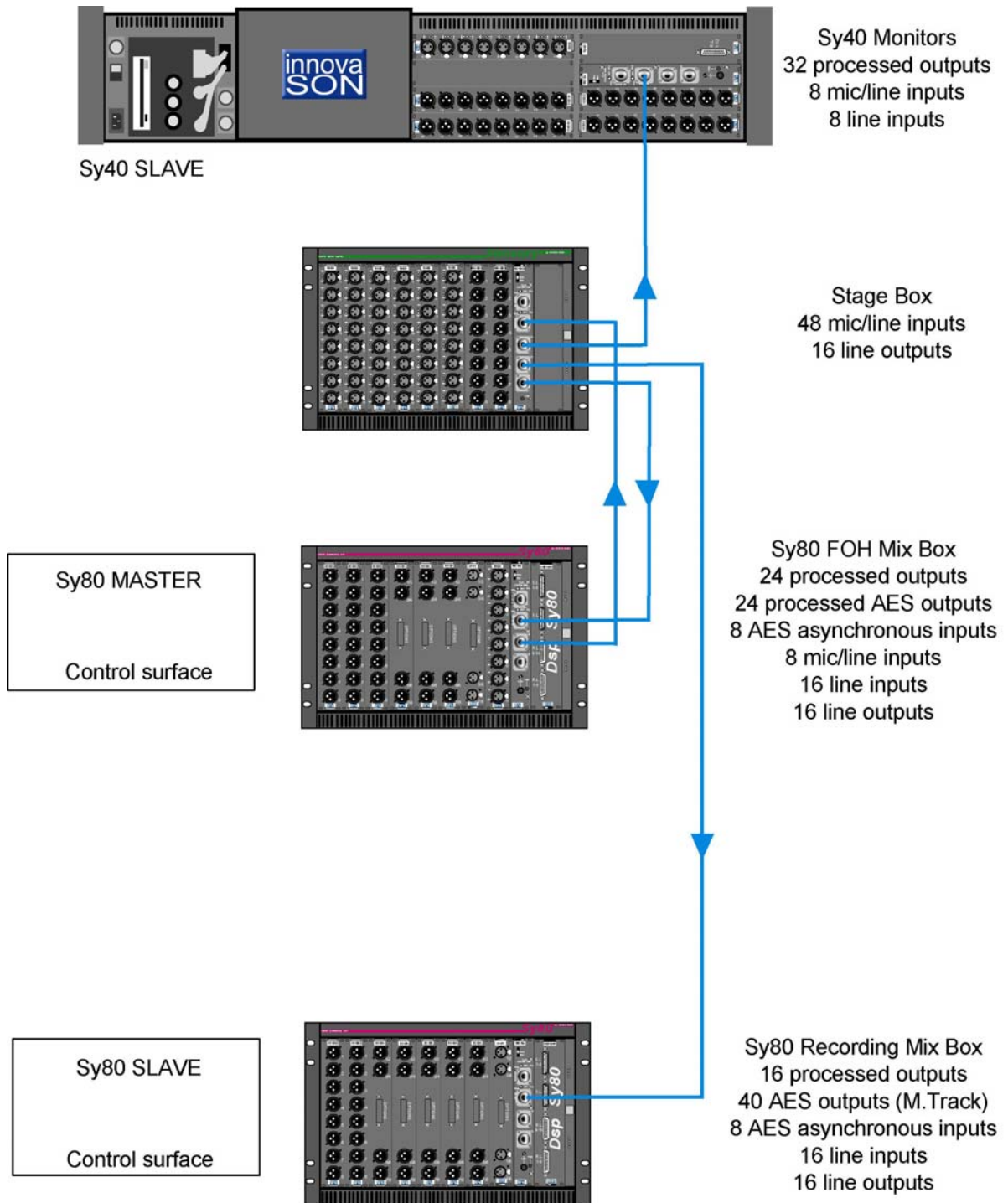

### 9.C.2 Racks configuration and modules installation

This operation is as follows :

- Powering the system off and disconnect all the power cords
- Taking the module with its handles on the front panel
- Bring the rear of the module, slightly tilted, to the appropriate slot
- Engage the lower edge of the printed circuit in the lower guide
- Straighten the module and gently engage the top edge against the upper guide
- Slide the module gently until it's almost totally inserted in the rack (don't force)
- Connect the module to the back plane, pushing a little more firmly
- Make sure the module is securely held and lock it on the front panel.

Having installed the modules according to this procedure, connect the coax cables and choose which console will be the MASTER for the Stage Box.

### 9.C.3 MASTER console definition

The Mix Box which has its TX connected to the Stage Box (SC-64) RX is the MASTER. It has the return transmission and can remote controls the Stage Box modules. The other consoles or Mix Boxes splitted from this Stage Box are SLAVE.

The MASTER console, which TX is connected to the Stage Box RX, has return audio channels from its Mix Box to the Stage Box outputs. So mixing busses, or other sources at this position, can be transmitted to the stage outputs indirectly. A Direct I/O, a Patch OUT and an external cable are the 3 steps necessary and illustrated below using the previous page configuration :

1-Patch a Direct I/O between local inputs (G3/G4) and the Stage Box outputs (G3/ G4).

2- For a stereo bus, patch it (Patch OUT) to local outputs of the Mix Box (D1/ D2)

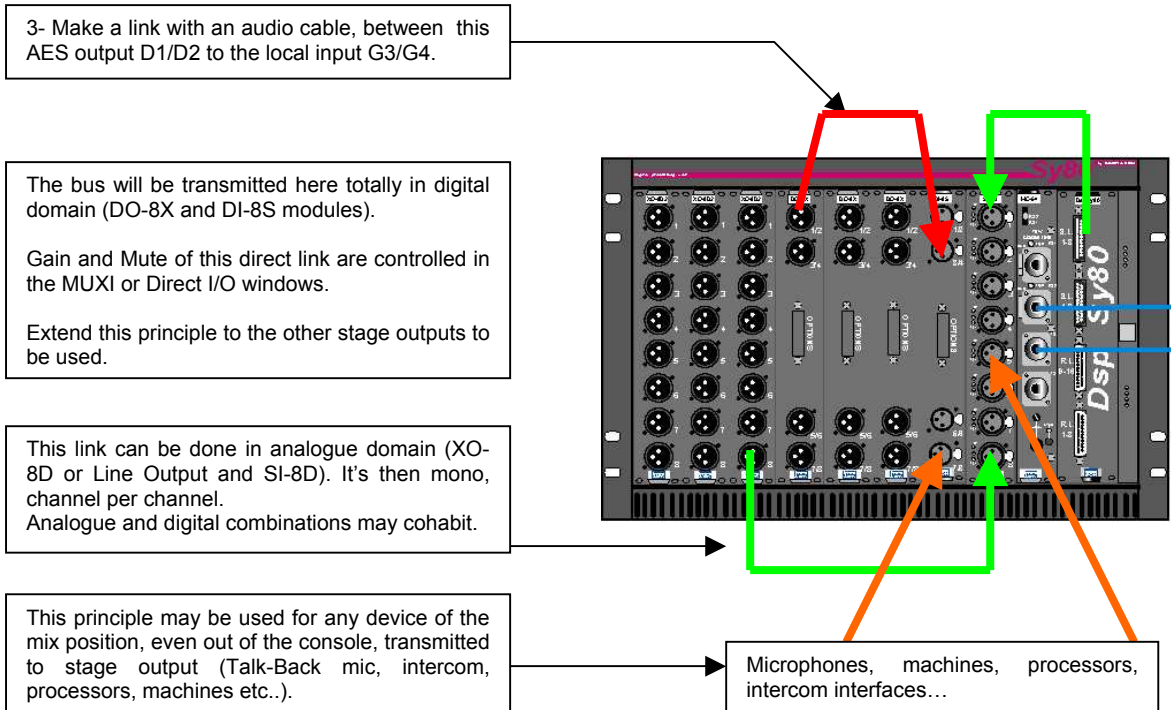

### 9.C.4 Powering up

The power-up procedure is described for each product in section 2, see this one also.

As a summary, the power-up must respect the following order :

- 1- Disconnect or switch off any power device (amplifiers, Loud Speakers..) to avoid any risk.
- 2- Power-up the Stage Box and check its 4 voltage leds.
- 3- Power-up a Sy80 Mix Box (or Essential Live), the 4 voltage leds must lit on.
- 4- For a Sy40, the whole console is powered up and its 8 leds must be on.
- 5- If a Stage Box is connected with a coax cable, the Mix Box valid RX leds must go from red to green. But the Stage Box valid RX must stay red even if there is a coax cable connected.
- 6- Power-up the control surface, check the power supply leds and that all the **[SELECT]**, **[MUTE]** and **[CUE]** buttons blink twice. Then on the screen, the starting step for the internal PC.
- 7- When Sensoft starts, the console upper panels' switches blink twice too. If the Stage Box is used, its RX led goes from red to green (MASTER return transmission works only when the master console has started and updated all the parameters).
- 8- The system is now ready and the other devices of the installation can be connected (powered).



## 9.D Transmission on coaxial cable

The digital links between the Stage Box et the Mix Box(es) are high rate bit streams and 120 millions bits are transmitted each second through the coax cables. The quality for these links provides the global system quality and reliability and great care must be taken on this point.

With the delivered coax cables and in major cases, the audio racks will lock immediately and provide a stable transmission. Although, to achieve best conditions, check the following points :

-The characteristic impedance must be 75 Ohm.

-The total attenuation must be less than 25 dB at 100MHz (example 200 m of KX6 or 300 m of VCB75)

The possible length usable between 2 racks is depending of the characteristics of the cable in use. And if the total attenuation is more than 20 dB, the HL (High Length) mode will be used on the MC-6'4and SC-64 modules (see modules descriptions).

Any intermediate connector adds around 6 dB of attenuation, intermediate and i-BNC connectors are not recommended.

Cable type	KX-6	VCB-75 *	KX-8	VCB-100	1505A
Manufacturer	Alcatel	S2CEB	Alcatel	S2CEB	Belden
100m @ 100MHz	12dB	7dB	5dB	4.8dB	5dB
Size	6mm	6mm	10mm	7mm	6mm
Maximum length	150m	300m	500m	500m	500m

\* VCB75 is the model delivered with InnovaSON standard products.

### 9.D.1 BNC connections

The coax cable drum delivered by InnovaSON is fitted with NBNC75PLS9 (Neutrick) BNC connectors.

The other BNC connectors compliant are : VB10-2031 (Vitelec) or BCP-C4F / BCP-C7F (Canare)

It is strictly forbidden to use T-BNC (impedance loss) and all other exotic connection combinations or craft solution. Don't hesitate to check scrupulously the BNC connectors and to change them if necessary using compliant tools (crimping pliers).

### 9.D.2 Earth and perturbations

A perfect grounding for the several devices of the system is fundamental and only such conditions will provide secure and reliable working conditions. Don't place the console close to electromagnetic sources as motors, light power blocs, cell phones or any device that are not compliant with CE rules.

The SC-64 and MC-64 RX leds advise ahead of reception troubles, a short red flash will occur before any clic in audio channels or erratic vu-meters will be observed. At last, software instabilities, flashing screen and MASTER/ SLAVE/ LOCAL status changing advise you about transmission defaults.

### 9.D.3 Adjustment and transmission errors

If RX leds on SC-64 or MC-64 modules stay permanently red or blink with the green ones, check the following :

- The good and reliable shape of the cables and the BNC connectors.
- Each coax cable is connected between a TX and a valid RX.
- Synchronisation cabling and stability may have influence here too.

If despite of this, the transmission is not correctly established, a failure may be possible.

To use a different coax cable than the one delivered by InnovaSON (VCB75 - 150 m), you may apply the following procedure :

- The cable specs must be compliant with the table in section 9.C.
- Switch to RX1 on the MC-64 / SC-64 module
- Use a small screw driver for the variable cap behind the "adjust" hole
- Turn the screw clockwise (cw). The leds must go red
- Turn slowly (cw) until the leds are going green. Memorize this position (A)
- Continue turn slowly (cw) until the leds are going back to red (position B)
- Turn back (ccw) to get the adjustment in the middle of A and B positions.

The transmission is now optimised and reliable.

This is similar to a radio station tuning, just before or just after, the signal is lost, in the middle it's tuned.

## 9.E Appendix

Continuously improving the products performances, InnovaSON reserve its right to modify the following specifications without notice.

### 9.E.1 Audio rack general Characteristics

Dimensions (LxHxD) :	483 x 311(7U) x 325 mm
Weight :	20 kg (maximum configuration)
Power supply :	90 to 253 Vac, 47/63 Hz (automatic switching)
Redundancy :	standard, manual with PWR module
Consumption :	300 VA maximum each
Temperature range :	+10°C to +35°C
Transport case :	Wood 760 x 580 x 640 mm – 50 kg

### 9.E.2 Audio Characteristics

General consoles characteristics (local configuration : SI-8D2 - DSP - XO-8D2 ) typical values :

Internal sampling frequency	48 kHz	
External sampling frequency	44 to 49 kHz	Word Clock TTL - AES option
Internal computation and processing	32 - 40 bits	Floating point, 760 dB dynamic range
Digital audio signal path	24 bits	Fixed point, 144 dB dynamic range
Analogue Delay DSP Sy80	1,3 ms	SI8D2-DSP-XO8D2 nominal signal path
Analogue Delay DSP Sy40-8	1,1 ms	SI8D2-DSP-XO8D2 nominal signal path
Analogue bandwidth	15 Hz to 20kHz	Input mic gain at -3 dB
Mic/line input range	-63 to 27 dB	Gain 32 steps of 3 dB or 64 steps of 1.5 dB
Dynamic range	105 dB	Input gain at 6 dB, output at +22 dBu
Total harmonic distortion + noise	-90 dB	Input gain at 6 dB, output at +22 dBu
Equivalent input noise	-127 dB	Gain 60 dB
Noise levels	-95 dBu	Noise floor
	-95 dBu	One output fader at 0 dB
	-79 dBu	One output fader and one input fader at 0 dB, gain 60dB
maximum voltage gain	+73 dB	Input at 63 dB, faders at 0dB, output at +22 dBu

Analogue modules characteristics (Delays are indicated between module Input/Output and rack bus)

	SI-8D2	SI-8D3	MO-8D3	XO-8D2	Sy80 line input	Sy80 line output	Headphone Sy80	Sy40 line input	Headphone Sy40
Conv. Bits	20 ΔΣ 64	24 ΔΣ 128	24 ΔΣ 128	24ΔΣ 128	24ΔΣ128	24ΔΣ128	24ΔΣ 128	18ΔΣ 64	18ΔΣ 64
Bandwidth (Hz)	15-20k	15-20k	5-22k	5-22k	5-20k	5-20k	0-22k	15-20k	0-15k
Dynamic	105 dB	110 dB	115 dB	113 dB	105 dB	105 dB	104 dB	85 dB	85 dB
Sens. (-18dBfs)	21/ -57dBu	21/ -57dBu	-8/-1/4 dBu	-8 to 4dBu	4 dBu	4 dBu		-6 dBu	- 4 dBu
THD-1dBfs)	-90 dB	- 95 dB	-95 dB	- 93 dB	- 98 dB	- 92 dB	-70 dB (-6dBfs)	-75 dB	-75 dB
Z in/out (Ω)	> 1,7 k	> 1,7 k	< 200	< 200	> 10k	< 200	<16	> 10k	< 16
Connector	XLR3 F	XLR3 F	XLR3 M	XLR3 M	DB25 F	DB25 M	Jack 6.35	DB25 F	Jack 6.35
Leds	Si, Pk, 48V	Si, Pk, 48V	-	-	-	-	-	-	-
Delay kHz)	0.396 ms	0.827 ms	0.604 ms	0.687 ms	0.499 ms	0.499 ms	0.499 ms	0.417 ms	0.375 ms
Full Scale	12 dBu (0dB)	12 dBu (0dB)	11/17/22	11 à 22 dBu	22 dBu	22 dBu	0 dBu	12 dBu	14 dBu

Digital modules characteristics (Delays are indicated between module Input/ Output and rack bus)

	SC64/MC64	DI-8S	DI-8Src	DO-8A	DO-8X	DSP Sy40-8	DSP Sy80	DM-Mk9
Bits	20/ 24	24	24	24	24	24/32/40	24/32/40	24/32/40
Bandwidth (Hz)	0-22k	0-22k	0-22k	0-22k	0-22k	5-22k	5-22k	5-22k
Dynamic	120/144 dB	144 dB	144 dB	144 dB	144 dB	144-700 dB	144-700 dB	144-700 dB
Range (dBfs)		-6 /+6 dB	-6/+6 dB	0 dB	-12/0 dB			
Distortion	-	-138 dB	-122 dB	- 138 dB	-138 dB	- 155 dB	-155 dB	- 155 dB
Z in/out (Ω)	Sync 10k/ 110	110	110	110	110	-	-	-
Connectors	BNC / Jack 3,5	XLR3 F	XLR3 F	XLR3 M	XLR3 M	-	-	-
Leds	RX	-	-	-	-	Reset	Ok, Rst, ST	Reset
Delay (48 kHz)	< 0.005 ms	0.062ms	0.8....0.979 ms	0.062 ms	0.146 ms	0.104 ms	0.374 ms	0.104 ms

Note :DI-8Src module delay depends on sampling frequencies differences

Detailed specifications for processing signal modules (DSP and Hyperdrive)

	Patch	Phase	Delay	LowCut	Gate Att.	Gate Rel.	Gate Thre.	Gate Range	Gate Hold
DSP Sy80	80 inputs	Yes	0 to 110 ms 1 to 5,300 smp	0 to 500 Hz 52 step	0,5 to 200 ms 32 step	50ms to 10s 32 step	-96 to 10 dB 32 step 3 dB	-96 to 10 dB 32 step 3dB	0,5 ms to 10s 32 step
DSP Sy40-8	48 inputs	Yes	-	0 to 440 Hz 13 step	0,5 to 200 ms 32 step	50ms to 10s 32 step	-96 to 10 dB 32 step 3 dB	-96 to 10 dB 32 step 3dB	0,5 ms to 10s 32 step
XO-8D DO-8X	8 outputs	Yes	0 to 1360 ms 1 to 65,536 smp	-	0,5 to 200 ms 32 step	50ms to 10s 32 step	-96 to 10 dB 32 step 3 dB	-96 to 10 dB 32 step 3dB	0,5 ms to 10s 32 step

	Comp Attack	Comp Release	Comp Threshold	Comp Gain	Comp Ratio	Eq Frequencies	Eq level	Eq Q Factor	Bus	Mixing
DSP Sy80	0,5 to 20ms 32 step	50ms to 10s 32 step	-96 to +10dB 32 step 3dB	-11 to 20dB 32 step 1dB	1 :1 to ∞:1 32 step	4x27 to 19kHz 96 1/10 oct	+/-15dB+N 32 step 1dB	1/8, 1/4, 1/2, 1, 2, 4, 8 oct.	48=32+16 + 2 mon.	∞ to +30dB step 0,5dB
DSP Sy40-8	0,5 to 20ms 32 step	50ms to 10s 32 step	-96 to +10dB 32 step 3dB	-11 to 20dB 32 step 1dB	1 :1 to ∞:1 32 step	4x27 to 19kHz 96 1/10 oct	+/-15dB+N 32 step 1dB	1/8, 1/4, 1/2, 1, 2, 4, 8 oct.	26 +2 mon.	∞ to +30dB step 0,5dB
XO-8D DO-8X	0,5 to 20ms 32 step	50ms to 10s 32 step	-96 to +10dB 32 step 3dB	-11 to 20dB 32 step 1dB	1 :1 to ∞:1 32 step	8x27 to 19kHz 96 1/10 oct	+/-15dB+N 32 step 1dB	1/8,1/4, 1/2, 1, 2, 4, 8 oct.	-	-

Processing order for DSP Sy80 and DSP Sy40-8 modules is :

Patch In > Delay > Low-Cut> Phase > Gate > Compressor > Equalizer > Mixing > Rack bus

Processing order for Hyperdrive modules( XO-8D et DO-8X) is :

Patch Out > Delay > Phase > Equalizer > Compressor > Gate > Output gain

Processing, algorithm parameters and mixing architecture are managed by Sensoft.

### 9.E.4 EtherSound applications and DO-8XES module

The DO-8XES module simultaneously outputs 8 processed audio channels to 4 pairs of AES digital outputs (via 4 XLR) and the EtherSound Network via the RJ45 'EtherCon'<sup>TM</sup> front panel connectors. Each of the eight channels has the following features:

- Balanced outputs 110 Ω, AES standard levels, synchronous with the EtherSound network.
- Sampling frequency asynchronous from the system general clock and synchronous with the EtherSound general sampling frequency (integrated Sample Rate Converter)
- Output attenuation from 0 to -11.5 dB with 0.5 dB steps
- Parametric equalizer - 8 fully independent bands
- An independent compressor and gate for each output
- A 1.3 s delay per output, one sample adjustable
- Patch and mute programmable for each output
- The EtherSound network access is achieved with an integrated MSX88 module from Digigram

The **DO-8XES** modules are designed to work in slots 'A' to 'H' of the Mix Box. DO-8XES modules are detected and controlled by Sensoft in the same way as XO-8D cards.

If the FROM connector has no signal or an ES Control frame, the DO-8XES module is '**Primary Master**' and the Network Clock is internal from the rack. If an EtherSound frame is received, the module is '**Master**', locks on the network clock and daisy-chains with it.

A coding wheel is used to configure the module and define the 8 EtherSound channels used on the network.

Hardware positions 0 to 7, assign the 8 EtherSound consecutive channels to be driven by the module as follows:	
Position	Module EtherSound channels
0	1 2 3 4 5 6 7 8
1	9 10 11 12 13 14 15 16
2	17 18 19 20 21 22 23 24
3	25 26 27 28 29 30 31 32
4	33 34 35 36 37 38 39 40
5	41 42 43 44 45 46 47 48
6	49 50 51 52 53 54 55 56
7	57 58 59 60 61 62 63 64
8 or 9	EtherSound channels assigned by ES-Control software

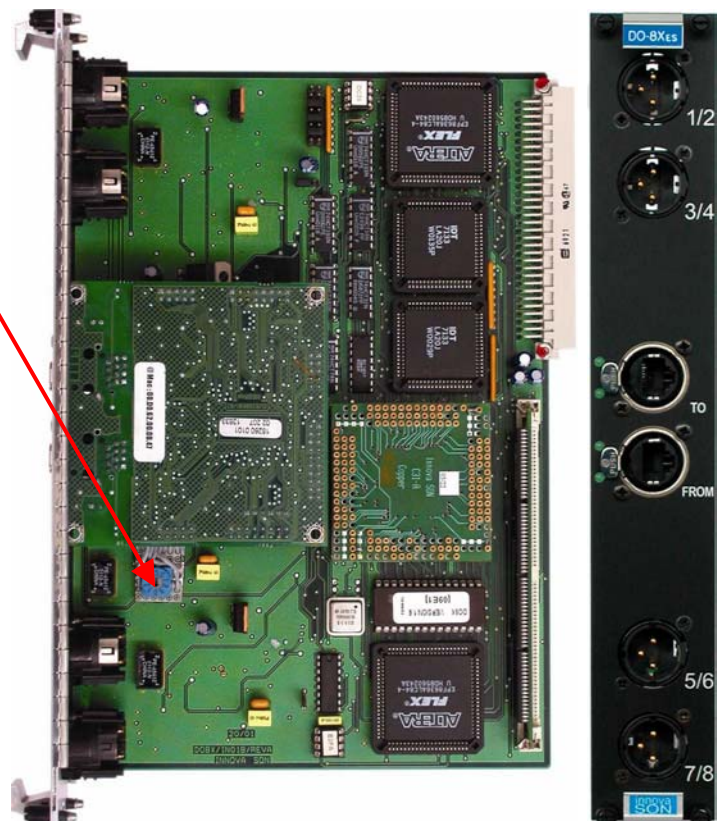

See [www.digigram.com](http://www.digigram.com) and the EtherSound user's manuals for network set-up and complementary instructions.

### 9.E.4.1 DO-8A, DO-8X and DO-8XES module technical characteristics.

	DO-8A	DO-8X	DO-8XES EtherSound outputs	DO-8XES AES outputs
Bits	24	24	24	24
Bandwidth Hz	0-22k	0-22k	0-22k	0-22k
Dynamic range	144 dB	144 dB	128 dB typ.	128 dB typ.
Sens. (dBfs)	0 dB	-11.5 / 0 dB	-11.5 / 0 dB	-11.5 / 0 dB
Distortion	-138 dB	-138 dB	-117 dB Bus - ES / -138 dB ES - ES	-117 dB Bus – AES
Z in/out (Ω)	110	110	Ethernet compatible	110
Connectors	XLR3 M.	XLR3 M.	2 RJ45 'EtherCon' FROM and TO	4 XLR3 Male
LEDs	-	-	EtherSound network activity on 4 LEDs	-
Delay (48 kHz)	0,062 ms	0,146 ms	1.9 - - 2.0 ms Bus – ES * / 2 μs ES - ES	1.9 - - 2.0 ms *

\* Note: DO-8XES module's delay depends on sampling frequencies differences (48 rack frames + 46 ES frames).

#### DO-8XES module signal processing characteristics

Patch	Phase	Delay	Gate Attack	Gate Release	Gate Threshold	Gate Range	Gate Hold
8 AES and EtherSound	Yes	0 to 1 360 ms 1 to 65 536 samp.	0,5 to 200 ms 32 steps	50 ms to 10s 32 steps	-96 to 10 dB 32 steps 3 dB	-96 to 10 dB 32 steps 3dB	0,5 ms to 10 s 32 steps
Comp. Attack	Comp. Release	Comp. Threshold	Comp. Gain	Comp. Ratio	Eq. Frequency	Eq. Levels	Eq. Q Factor
0,5 to 20 ms 32 steps	50 ms to 10 s 32 steps	-96 to +10 dB 32 steps 3 dB	-11 to 20 dB 32 steps 1 dB	1 :1 to ∞ :1 32 steps	8 x27 to 19 kHz 96 1/10 oct.	+/-15 dB+N 32 steps 1dB	1/8, 1/4, 1/2, 1, 2, 4, 8 oct.

The processing order for a DO-8XES module is:

Patch Out > Delay > Phase > Equalizer > Compressor > Gate > Output gain  
Processing, algorithm parameters are managed by Sensoft.

### 9.E.4.2 Typical applications.

System configuration, DO-8XES modules and EtherSound (**ES**) network set-up.

For a simple set-up, the **ES** channels to be used are physically defined with the coding wheels. The first module is set to position 0 to drive **ES** channels 1 to 8. The second module is configured on 1 for **ES** channels 9 to 16, and so on. Patch OUT assigns mix buses to **ES** channels corresponding to the 8 outputs of each DO-8XES module.

An output breakout box has a coding wheel to define its outputs to **ES** channel assignments, directly or with ES-Control software (see breakout box specifications). The **ES** channels transmit the mix buses which are distributed to the outputs. This is already a dual levels patch and the easiest is to configure the **ES** network as 'diagonal' and to use Patch OUT to start.

For a sophisticated and more powerful use, the coding wheels are placed on positions 8 (or 9) on the DO-8XES modules. The **ES** channels are assigned by ES-Control software or equivalent and each DO-8XES output to each **ES** channel assignment is programmable. The distribution flexibility is increased but the patch has now three levels (Patch OUT, **ES** channels assignment and **ES** outputs) which is more complex to configure, and monitor, but totally programmable.

The network configuration is saved in each **ES** module.

The rules for installing modules in the Mix Box are the same for DO-8XES as for XO-8D2 or DO-8X modules and depend also of course on the audio set up required.

**Example 1:** Sy40 console fitted with 16 **ES** channels.

This Sy40, equipped with 2 DO-8XES modules, has 16 processed outputs, 16 mic/line inputs and 8 line inputs. The DO-8XES modules in slots E and F, configured respectively to 0 and 1, use the **ES** channels 1 to 16.

Patch OUT, programmed as below, assigns the 8 matrices to **ES** channels 1 to 8.

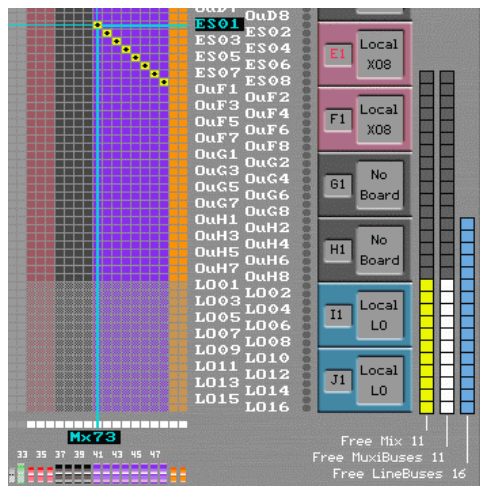

The ES8Out breakout box is 'patched' in 1 and converts **ES** channels 1 to 8 to analogue signals that are available on its XLR outputs as soon as the CAT5 cable is connected.

Second **ES** network

**Attention :** the ES8out configuration mode is different from the DO-8XES module.



This first example shows only the 8 **ES** channels coming from the module positioned in slot E. A second equivalent network may be set up using, independently, the module in F to transport 8 other **ES** channels (8 other mix buses) to another destination (another ES8Out box or equivalent). These two networks are then independent.

A network of 16 channels is set-up when the F 'TO' connector is linked with the 'FROM' of the E module. This 'daisy chain' adds the F module's channels 9 to 16 to the E module's **ES** frame. The resulting network audio coming from the E DO-8XES module transports 16 channels (mix buses). Each output box can be configured to output 2 to 8 of these 16 **ES** channels (depends of the model). Therefore, the output boxes can be 'daisy-chained' to simplify the wiring or extend the distribution.

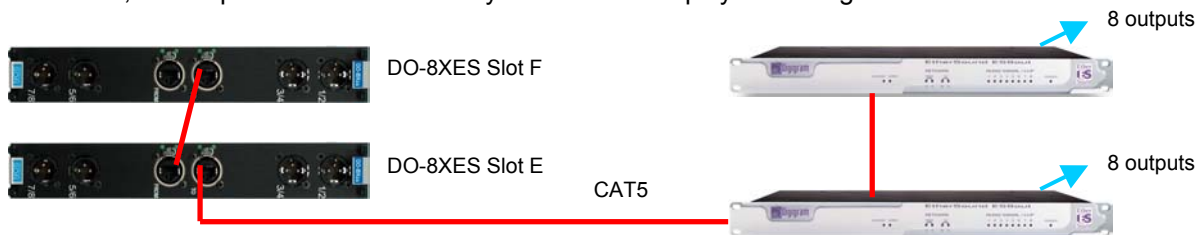

**Example 2:** Sy80 used in a Front of House mix position with 24 **ES** channels.

The configuration below shows an Sy80 console's Mix Box fitted with 24 analogue outputs and 24 **ES** channels. The line inputs and outputs of the DSP Sy80 module and the analogue and digital input modules complete the audio resources that would probably be used with a Stage Box.

The 3 DO-8XES modules are placed in D, E and F and addressed respectively to 0, 1 and 2 with their coding wheels. Module D uses **ES** channels 1 to 8; E uses 9 to 16, and F channels 17 to 24.

Patch OUT is used to assign the Sy80 mix buses to the **ES** channels with, for example:

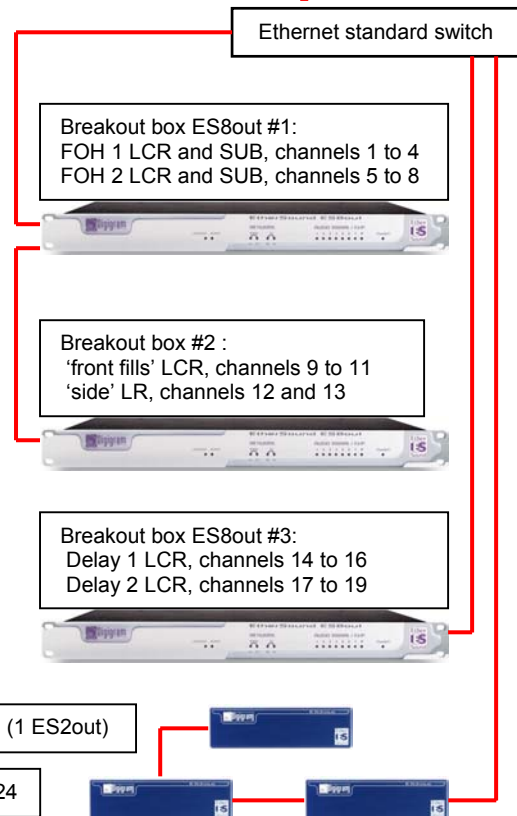
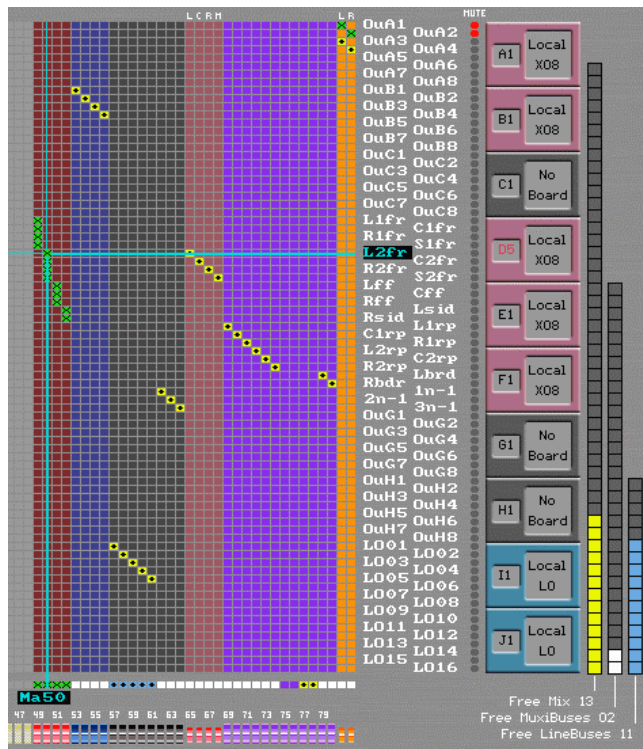
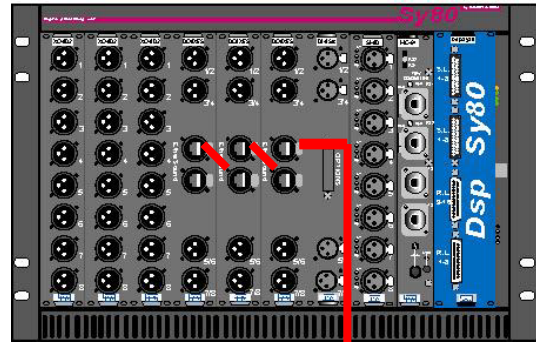

The **ES** breakout boxes are configured to output the corresponding channels.



A star network, here adapted to the geographic needs of the location, is achieved with an Ethernet switch (see Digigram recommended models). The ES8out modules 1 and 2 are 'daisy chained', as are the 3 ES2out boxes. The network may have other topologies depending on the requirements of the installation. Channel assignments stay independent of the network cabling.

In this example the analogue outputs can be used for monitoring, effect sends, extra loudspeakers etc where an **ES** network is not possible. Alternatively AES outputs could be taken from the DO-8XES modules. This type of configuration is extremely flexible.









## 10 ANNEXES - APPENDICES - ANHANGE



### 10.A Précautions, sécurité et avertissements - Important messages - Wichtige Hinweise

		
Attention	Warning	Achtung
Des blessures graves, des dommages matériels ou un incendie peuvent résulter d'une mauvaise connexion de la console.	Serious injury, or fire hazard could result from improper connection of this equipment.	Fehlerhaftes Anschließen dieses Geräts kann zu Beschädigungen, Verletzungen und/oder Bränden führen.
Familiarisez-vous avec les définitions des messages et symboles suivants avant de lire le texte et les instructions fournies.  Veuillez lire et comprendre ce manuel avant de connecter cet équipement	Read and understand this manual before connecting this equipment.	Fehlerhaftes Anschließen dieses Geräts kann zu Beschädigungen, Verletzungen und/oder Bränden führen.  Lesen Sie dieses Handbuch gründlich, bevor Sie dieses Gerät anschließen
Veuillez suivre toutes les instructions décrites dans ce manuel pour utiliser cet équipement.	Follow all installation and operating instructions while using this equipment.	Befolgen Sie bei der Verwendung des Geräts sämtliche mitgelieferten Betriebs- und Installationsanweisungen sorgfältig.
Les connexions de cet équipement doivent être réalisées en conformité avec l'International Electrical Code (IEC 60950) ainsi qu'avec toute consigne de sécurité supplémentaire applicable à votre installation.	Connection of this equipment must be performed in compliance with the International Electrical Code (IEC 60950) and any additional safety requirements applicable to your installation.	Der Anschluss dieses Geräts muss in Übereinstimmung mit IEC 60950 und eventuellen weiteren Anforderungen, die für Ihre Installation zutreffen, erfolgen.
Les porte fusible de la console Sy48 ne sont pas utilisés.	On Sy48 desk, FUSES not connected	Bei dem Sy48 Mischpult sind die Netzsicherungen nicht angeschlossen.

**10.A.1 Symboles - Symbols - Symbole**

			
	<b>DANGER:</b> Indique une situation dangereuse pouvant entraîner des blessures graves, voire mortelles en cas de non respect des instructions	<b>WARNING:</b> The exclamation point within an equilateral triangle is intended to alert the user to the presence of important operating and maintenance (servicing) instructions in the literature accompanying the product.	<b>ACHTUNG:</b> Das Ausrufezeichen in einem gleichschenkligen Dreieck soll den Benutzer auf wichtige Betriebs- und Wartungshinweise in der Dokumentation des Produkts hinweisen.
	<b>DANGER:</b> Indique une zone présentant un danger de chocs électriques	<b>WARNING:</b> The lightning flash with arrowhead symbol within an equilateral triangle is intended to alert the user to the presence of uninsulated «dangerous voltage» within the product's enclosure that may be of sufficient magnitude to constitute a risk of electric shock to persons.	<b>ACHTUNG:</b> Der Blitz mit Pfeil in einem gleichschenkligen Dreieck soll den Benutzer auf nicht isolierte Teile mit gefährlichen Spannungen hinweisen, die zu gefährlichen Stromschlägen führen können.
	<b>AVERTISSEMENT:</b> Indique une interdiction	<b>CAUTION:</b> this symbol is intended to alert the user that action concerned is forbidden (otherwise, malfunction may occur.)	<b>VORSICHT:</b> Dieses Symbol soll den Benutzer darauf hinweisen, dass die betreffende Aktion unzulässig ist und zu einer Fehlfunktion führen kann.
	<b>AVERTISSEMENT:</b> Indique une opération à effectuer impérativement	<b>CAUTION:</b> this symbol is intended to alert the user has to conform to this operation	<b>VORSICHT:</b> Dieses Symbol soll den Benutzer darauf hinweisen, dass die betreffende Aktion ausgeführt werden muss.

## 10.A.2 Dangers - Warning - Achtung

		
N'insérez jamais d'objet métallique dans l'appareil afin d'éviter tout risque de choc électrique, d'incendie, ou de court-circuit.	Do not allow liquid or any foreign object or metallic object to enter the desk or allow the desk to become wet. Fire or electrical shock may result.	Flüssigkeiten und (besonders metallene) Gegenstände dürfen nicht in das Innere des Gerätes gelangen. Außerdem darf das Gerät nicht feucht oder nass werden. In allen derartigen Fällen kann es zu Stromschlägen oder Bränden kommen.
N'exposez jamais la console à la pluie, ne la placez pas dans un lieu où la console pourrait recevoir des projections d'eau, ne posez jamais de récipient contenant un liquide quelconque, qui risquerait de se répandre dans les parties internes. Vous vous exposeriez à des risques de décharge électrique, de court-circuit, d'incendie ou de blessure corporelle.	The desk is equipped with a dedicated ground connection to prevent electrical shock. Before connecting the power plug to an AC socket, be sure to ground the desk. If the power cord has a three-pin plug, it will provide sufficient grounding so long as the AC socket is grounded correctly.	Das Gerät verfügt über eine spezielle Erdung, um Stromschläge zu verhindern. Bevor der Stecker mit einer Wechselstromsteckdose verbunden wird, muss das Gerät geerdet werden. Wenn das Netzkabel über einen Stecker mit drei Anschlüssen verfügt, ist die Erdung ausreichend, sofern die Wechselstromsteckdose ordnungsgemäß geerdet ist.
La console est équipée d'un raccordement à la terre afin de prévenir les chocs électriques. Avant de raccorder la console au secteur, il est important de vérifier que le raccordement à la terre est fonctionnel. Tant que les câbles d'alimentation utilisés comporteront trois broches électriques, et tant que les prises électriques AC utilisées seront également raccordées à la terre, le raccordement à la terre sera fonctionnel.	Do not remove the power supply. You could receive an electrical shock. If you think internal inspection, maintenance, or repair is necessary, contact your nearest InnovaSON dealer.	Entfernen Sie das Netzteil nicht, da dies zu Stromschlägen oder Bränden führen kann. Wenn Sie denken, dass eine Untersuchung, Wartung oder Reparatur erforderlich ist, wenden Sie sich an Ihren InnovaSON-Händler.
Ne pas enlever l'alimentation. Vous pourriez recevoir un choc électrique. Si vous estimez qu'un contrôle, qu'une maintenance ou qu'une réparation est nécessaire, contactez le distributeur InnovaSON le plus proche. La liste des distributeurs est disponible sur le site Internet d'InnovaSON: ( <a href="http://www.innovason.com">www.innovason.com</a> ).	Do not modify the desk. Doing so is a fire and electrical shock hazard. Consult your dealer for upgrade or modification.	Nehmen Sie keine Änderungen am Gerät vor, da dies zu Stromschlägen oder Bränden führen kann. Wenn Sie eine Änderung oder Aufrüstung des Geräts wünschen, wenden Sie sich an Ihren InnovaSON-Händler.

		
<p>Ne pas modifier la console. Une telle manipulation pourrait entraîner un incendie ou un choc électrique. Pour toute modification ou mise à jour, veuillez consulter votre distributeur InnovaSON.</p>	<p>If lightning begins, turn off the power switch of the desk as soon as possible, and unplug the power cable plug from the electrical socket.</p>	<p>Schalten Sie bei einem Gewitter das Gerät umgehend über den Netzschalter aus und ziehen Sie das Netzkabel aus der Wechselstromsteckdose.</p>
<p>Si vous apercevez un flash ou n'importe quelle anomalie, comme de la fumée, une odeur, ou du bruit, ou si un corps étranger, du liquide a pénétré à l'intérieur de la console, éteignez la console immédiatement en appuyant sur le bouton POWER. Puis débrancher les câbles d'alimentation de leurs prises électriques. Consultez ensuite votre vendeur pour une réparation car l'utilisation de la console pourrait, dans de telles conditions, entraîner un incendie ou un choc électrique.</p>	<p>If you notice any abnormality, such as smoke, odor, or noise, or if a foreign object or liquid gets inside the desk, turn it off immediately. Remove the power cord from the AC socket. Consult your dealer for repair. Using the desk in this condition is a fire and electrical shock hazard.</p>	<p>Wenn Sie etwas Ungewöhnliches wie Rauch, Geruch oder Geräusche bemerken oder wenn ein Gegenstand oder Flüssigkeit in der Gerät gelangt, schalten Sie dieses sofort aus. Ziehen Sie das Netzkabel aus der Wechselstromsteckdose. Wenden Sie sich wegen einer Reparatur an Ihren InnovaSON-Händler. Das Gerät muss untersucht werden, da es ansonsten zu Stromschlägen oder Bränden kommen kann.</p>
<p>Si la console venait à tomber ou si son châssis devait être endommagé, veuillez l'éteindre immédiatement en appuyant sur le bouton POWER, puis débranchez les câbles d'alimentation des prises secteurs AC. Ensuite veuillez contacter votre distributeur InnovaSON. Continuer à utiliser ainsi la console sans tenir compte de ces instructions pourrait provoquer un incendie ou des chocs électriques.</p>	<p>Should this desk be dropped or the cabinet be damaged, turn the power switch off, remove the power plug from the AC socket, and contact your dealer. If you continue using the desk without heeding this instruction, fire or electrical shock may result.</p>	<p>Wenn der Sy48 fallen gelassen und/oder das Gehäuse beschädigt wird, schalten Sie das Gerät am Netzschalter aus, ziehen Sie das Netzkabel aus der Wechselstromsteckdose und wenden Sie sich an Ihren InnovaSON-Händler. Das Gerät muss untersucht werden, da es ansonsten zu Stromschlägen oder Bränden kommen kann.</p>
<p>Ne pas changer un module tant que la console est allumée car cela pourrait causer d'importants dommages aux équipements.</p>	<p>Do not change a module while the desk is powered up, as it carries a risk of serious damage to the equipment.</p>	<p>Ändern/wechseln Sie kein Modul, während die Konsole eingeschaltet ist, da es hierdurch zu Beschädigungen kommen kann.</p>

## 10.A.3



## Avertissements - Cautions - Vorsicht

		
<p>Eviter :</p> <ul style="list-style-type: none"> <li>-Les lieux exposés aux projections de liquide et à la vapeur.</li> <li>-Les lieux exposés à une chaleur excessive.</li> <li>-Les lieux sujets à une humidité excessive ou à une accumulation de poussière.</li> </ul>	<p>Avoid :</p> <ul style="list-style-type: none"> <li>-Locations exposed to oil splashes or steam.</li> <li>-Locations exposed to excessive heat.</li> <li>-Locations subject to excessive humidity or dust accumulation.</li> </ul>	<p>Vermeiden Sie den Betrieb :</p> <ul style="list-style-type: none"> <li>-an Orten mit Ölspritzern oder Dampf.</li> <li>-an sehr heißen Orten.</li> <li>-an sehr feuchten oder staubigen Orten.</li> </ul>
<p>La console dispose de trous de ventilation pour prévenir toute élévation de la température interne. Ces trous ne doivent pas être obstrués. Une obstruction de ces trous de ventilation pourrait entraîner un incendie. De plus, n'utilisez pas la console si elle est placée sur le côté, à l'envers, ou si elle est recouverte par sa housse.</p>	<p>This desk has ventilation holes, to prevent the internal temperature from rising too high. Do not block them. Blocked ventilation holes are a fire hazard. In particular, do not operate the desk while it's on its side, is upside down, or while it's covered with a cover.</p>	<p>Dieses Gerät verfügt über Ventilationsöffnungen, damit die interne Temperatur nicht zu hoch wird. Diese Öffnungen dürfen nicht blockiert werden, das dies zu Bränden führen kann. Insbesondere ist der Betrieb des Geräts, während es auf die Seite gelegt, mit der Oberseite nach unten aufgestellt oder durch etwas bedeckt ist, verboten.</p>
<p>Afin de prévenir tout accident, la console ainsi que le rack audio doivent être posées et utilisées sur des supports stable et suffisamment solide.</p>	<p>To prevent injury, desk and audio rack must be reliably installed on its support.</p>	<p>Um Verletzungen und Beschädigungen zu vermeiden, muss das Gerät fest auf seiner Unterlage stehen.</p>
<p>Pour transporter ou déplacer correctement la console, un minimum de deux personnes est requis.</p>	<p>The desk needs two people at least to be handled and carried properly.</p>	<p>Zum ordnungsgemäßen Handhaben und Transportieren des Geräts sind mindestens zwei Personen erforderlich.</p>
<p>Le cordon d'alimentation de la console fait office de dispositif de sectionnement. La prise électrique dans laquelle le cordon d'alimentation est inséré doit être installé à proximité du matériel et doit être aisément accessible.</p>	<p>The plug of the power supply is used as the disconnect device.</p> <p>The socket-outlet shall be installed near the desk and shall be easily accessible.</p>	<p>Die Steckdose muss sich in der Nähe des Geräts befinden und leicht zugänglich sein.</p> <p>Der Stecker des Netzkabels kann zum Unterbrechen der Stromversorgung verwendet werden.</p>
<p>Chaque cordons d'alimentation des racks audio est utilisés comme dispositif de sectionnement.</p> <p>Veuillez débrancher les 2 cordons pour éviter les chocs électrique.</p>	<p>Each Audio racks power cable is used as main voltage switch.</p> <p>Unplug the 2 power cords to avoid electric shocks.</p>	<p>Die Audio Racks sind ohne Netzschalter ausgeführt. Durch das Anschließen der beiden Netzkabel sind die Audio Racks betriebsbereit.</p> <p>Entfernen Sie beide Netzkabel um einen Elektroschock zu vermeiden.</p>

### 10.A.4 Remarques sur l'utilisation - Operating notes - Hinweise zum Betrieb

		
<p>Les performances des composants mécanique tels que les boutons, les faders et les connecteurs se déprécient avec le temps. veuillez consulter votre distributeur InnovaSON à propos du remplacement des composants défectueux.</p>	<p>The performance of components with moving contacts, such switches, knobs, faders, and connectors, deteriorates over time. Consult your dealer about replacing defective components.</p>	<p>Die Leistung von Teilen mit beweglichen Kontakten wie Schalter, Drehknöpfe, Überblendregler und Stecker lässt mit der Zeit nach. Wenn Teile erneuert werden müssen, wenden Sie sich an Ihren Händler.</p>
<p>L'utilisation d'un téléphone cellulaire près d'une console peut engendrer du bruit. Si une telle situation se présente, éloignez le téléphone de la console.</p>	<p>Using a mobile telephone near the desk may induce noise. If noise occurs, use the telephone away .from the desk.</p>	<p>Bei Betrieb von Mobiltelefonen neben dem Gerät kann es zu Störungen kommen. In diesem Fall muss der Abstand zwischen Telefon und Gerät vergrößert werden</p>
<p>La console et le rack audio peuvent être nettoyés avec un chiffon doux légèrement humidifié. Ne pas utiliser de solvant</p>	<p>The desk and the audio rack can be clean with a lightly wet cloth. Do not use solvent</p>	<p>Reinigen Sie dasMischpult mit einem feuchten Lappen. Verwenden Sie keine scharfen Reinigungsmittel.</p>
<p>Les filtres à air des alimentations du rack audio, après démontage, doivent régulièrement être nettoyés par immersion dans l'eau et séchés sans torsion.</p>	<p>The power supply audio rack filters, must be cleaned by immersion in water. Do not fold the filter to dry it.</p>	<p>Um die Lüftungfilter der Audio Racks zu reinigen, tauchen Sie die Filter in Wasser.  Bitte Filter nicht auswringen.</p>



Headquarters  
Zone du Kenyah  
F-56400 Plougoumelen  
FRANCE  
tel : +33 (0) 297 24.34.34  
fax : +33 (0) 297 24.34.30  
[www.innovason.com](http://www.innovason.com)

**9.E.3 Sensoft 8 Signal Path for Sy40, Sensory & Sy80**

