

**JBL PROFESSIONAL**

**FULL LINE CATALOG 2003**





# JBL Professional

## FULL LINE CATALOG 2003

*JBL continually engages in research related to product improvement. New materials, production methods and design refinements are introduced into existing products without notice as a routine expression of that philosophy. For this reason, any current JBL product may differ in some respect from its published description but will always equal or exceed the original design specifications unless otherwise stated.*

### **INSTALLATION PRODUCTS . . . . . 2**

- Control® Contractor Series
- Soundzone® Business Music Systems
- Control® Series and Accessories
- Marquis Series
- Sound Power Series
- EVO™
- AE Series
- PD Series
- JBL Custom Shop

### **TOUR SOUND PRODUCTS . . . . . 18**

- VERTec™
- Array™ Series

### **PORTABLE PRODUCTS . . . . . 24**

- SoundFactor
- MPro Series
- EON® Series
- EON® G2 Series
- E-Systems
- SR-X® Series

### **LOUDSPEAKER COMPONENTS . . 37**

- Low-Frequency Transducers
- Midrange/ Low-Frequency Transducers
- Coaxial Transducers
- Compression Drivers
- Horns

### **CINEMA PRODUCTS . . . . . 41**

- ScreenArray®
- 3000 Series
- 4000 Series
- 5000 Series
- Cinema Surround Systems
- Cinema Subwoofer Systems

### **STUDIO MONITORS . . . . . 48**

- LSR Series
- 4200 Series
- 4400 Series

### **ELECTRONICS/SOFTWARE . . . . . 52**

- Digital Signal Processing
- EASE V 4.0

### **INDEX . . . . . 53**

# INSTALLATION PRODUCTS

PacBell Park: San Francisco, California

No matter where you go in this world, you'll find JBL Installed Sound Speaker Systems at many of the most notable venues.

With that kind of global perspective, JBL has come to respect the one indisputable truth of business: every customer is unique. A speaker system that is perfectly right for one job might be perfectly wrong for another. That's why JBL Installed Sound products offer a range of options without equal. From the extraordinary value of the Control Contractor Series to the ultimate precision of the JBL Custom Shop, there's a JBL Installed Sound product with a solid business solution based on equally solid business savvy.

For more than 50 years, JBL has been the professional speaker of choice wherever sound matters. We'd like to believe it should be your choice, too.



Sydney Opera House: Sydney, Australia



Safeco Field: Seattle, Washington

- ▶ ALL-IN-ONE CONVENIENCE FOR FAST INSTALLATION AND EASY STOCKING
- ▶ AGENCY APPROVED FOR USE IN AIR HANDLING SPACES
- ▶ PREMIUM PERFORMANCE
- ▶ SONICGUARD™ OVERLOAD PROTECTION

# Control® Contractor Ceiling Speakers

JBL Control Ceiling Speakers deliver high power handling, overload protection and exceptional sound level capability and are packaged as complete assemblies, including integral backcan, front grille and tile bridge support hardware. Innovative design features (such as titanium-coated tweeters and JBL's unique diffraction-horn loading) provide broad, even coverage throughout the listening area.

Installation is quick and easy and can be accomplished without requiring access above the ceiling. Bracketry for suspended ceilings is included. The speaker is held securely in place via mounting ears which rotate into position and lock into place. Inputs are attached to a removable locking connector (included) which can be prewired before installing for ultra-fast snap-on installation. All models (except 26-DT) contain formed steel backcans and are suitable for use in air handling spaces per UL1480. Control 24CT Micro, 24CT MicroPlus, 24CT, 26CT and 19CST feature top quality transformers pre-installed inside the speaker assembly for use on 70V/100V distributed lines. Tap selection is conveniently located on the front of the speaker (except micro).

## CONTROL 24C/CT MICRO AND CONTROL 24CT MICROPLUS

The Control 24C/CT Micro and Control 24CT MicroPlus are compact in-ceiling speakers, providing full, high quality sound for background music and music-plus-paging systems. Installation of the Control 24C/CT Micro and 24CT MicroPlus is quick and easy. The Control 24CT Micro and Control 24CT MicroPlus both include multi-tap transformers.



24C/CT MICRO  
24CT MICROPLUS

## CONTROL 24C/CT AND CONTROL 26C/CT

The Control 24C contains a coaxially mounted 4" woofer and 3/4" titanium-coated tweeter, providing high-fidelity sound over a wide coverage area. The Control 26C is a powerhouse ceiling speaker containing a coaxially mounted 6 1/2" woofer and 3/4" titanium-coated tweeter, able to deliver maximum sound level over a defined area.

## CONTROL 26-DT

The Control 26-DT is designed for sound systems requiring a higher fidelity sound and easy installation into standard backcans. A high quality, low insertion-loss transformer is supplied for use on 70V/100V distributed lines.

## CONTROL 19CS/CST

The unique Nested-Chamber design and Linear Dynamic™ port of the JBL Control 19CS subwoofer allows powerful low-frequency reinforcement from a compact in-ceiling enclosure. The Control 19CS is an ideal addition to any system, resulting in full-fidelity, high level sound. The optional Control 19CST has a special subwoofer-band transformer for use on 70V or 100V line distribution systems.

## ACCESSORIES

**Optional Pre-Installation Brackets:** Useful for installation in new construction installations. New Construction Bracket: **MTC-xxNC** Plaster Ring Bracket: **MTC-xxMR**

**Trim Rings:** Allow for installation into existing ceiling speaker cutouts that are larger than the speaker's normal cutout size. **MTC-xxTR.**

*Note: Secondary backcans for pre-piped installations available from third party. Contact JBL for information.*



26-DT

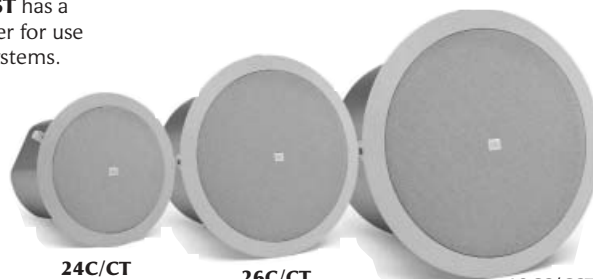

24C/CT

26C/CT

19CS/CST

## [SPECIFICATIONS]

	24C/CT MICRO 24CT MICROPLUS	24C/CT	26C/CT	26-DT	19CS/CST
FREQUENCY RANGE	85 Hz - 25 kHz (-10 dB) <sup>1</sup>	80 Hz - 20 kHz (-10 dB) <sup>1</sup>	75 Hz - 20 kHz (-10 dB) <sup>1</sup>	70 Hz - 20 kHz (-10 dB) <sup>1</sup>	42 Hz - 200 Hz (-10 dB) <sup>2</sup>
POWER CAPACITY: PROGRAM <sup>3</sup> PINK <sup>4</sup>	30 W 15 W	80 W 40 W	150 W 75 W		200 W 100 W
NOMINAL DISPERSION	150° conical	130° conical	110° conical	90°	Omnidirectional
NOMINAL SENSITIVITY: 1 W, 1 m	86 dB	86 dB	89 dB	89 dB (60 W tap)	95 dB (ceiling, near corner) 89 dB (center of ceiling)
NOMINAL IMPEDANCE	8 ohms (24C Micro)	16 ohms (24C)	16 ohms (26C)		8 ohms (19CS)
TRANSFORMER TAPS: 100V 70.7 V	8, 4, 2, 1 W (24CT Micro) 25, 12 W (24 CT MicroPlus) 8, 4, 2, 1, .5 W (24CT Micro) 25, 12, 6 W (24CT MicroPlus)	30, 15, 7.5 W (24CT)	60, 30, 15 W (26CT)	60, 30, 15 W	60, 30, 15 W (19CST)
COMPONENTS: LOW FREQ. HIGH FREQ.	4 1/2" (115 mm) 1/2" (12 mm)	4" (100 mm) 3/4" (19 mm)	6 1/2" (165 mm) 3/4" (19 mm)	6 1/2" (165 mm) 3/4" (19 mm)	8" (200 mm)
ENCLOSURE	Formed steel backcan	Formed steel backcan	Formed steel backcan		Formed steel backcan
DIMENSIONS (H x DIA.)	106 x 195 mm 4.2 x 7.7 in	200 x 195 mm 7.9 x 7.7 in	210 x 252 mm 8.3 x 9.9 in	120 x 200 mm 4.72 x 7.87 in	345 x 345 mm 13.6 x 13.6 in
NET WEIGHT (each)	24C Micro: 1.6 kg (3.6 lbs) 24CT Micro: 2.0 kg (4.4 lbs) 24CT MicroPlus: 2.5 kg (5.5 lbs)	24C: 2.7 kg (6 lbs) 24CT: 3.5 kg (8 lbs)	26C: 3.4 kg (7.5 lbs) 26CT: 4.2 kg (10 lbs)	1.9 kg (4.2 lbs)	19CS: 5.5 kg (12 lbs) 19CST: 6.3 kg (14 lbs)

<sup>1</sup> Half-space (flush mounted in ceiling).

<sup>2</sup> Mounted in ceiling near corner (π/2 loading).

<sup>3</sup> See 2 page 5 for a complete description.

<sup>4</sup> Rated in Continuous Pink Noise for 100 hours.

The JBL CCS6000 System consists of four Control 23 speakers and one Control SB-2 subwoofer.



# Control® Contractor Surface-Mount Speakers

The Control Contractor Surface speakers are compact systems with rugged, molded high impact polystyrene shells. Designed for wide-ranging indoor and outdoor (except SB-2) applications, the Control Contractor Series offers versatility, ease-of-installation and paintability. JBL's Invisiball® mounting technology revolutionizes ease-of-installation with built-in hardware easily secured with a standard hex wrench from a front channel. Mounting hardware is included.

## CONTROL 23/CONTROL 23T

The most compact of the JBL Control Contractor Series speakers, the **Control 23**, has a 3 1/2" woofer and horn-loaded titanium-coated tweeter ideal for mid/high operation in limited space environments. This system delivers crisp, articulate sonic quality. The optional **Control 23T** has a pre-installed transformer for line distribution systems. Augmenting the bass with a JBL subwoofer results in an extremely full-fidelity system.

## CONTROL 25/CONTROL 25T

The **Control 25** incorporates a 5 1/4" low frequency loudspeaker with a horn-loaded 3/4" titanium-coated tweeter. Its full-range frequency response makes it an excellent choice for moderately large venues, providing superior dynamic performance and a smooth roll-off down to 80 Hz. The optional **Control 25T** includes a multitap transformer for line distribution systems.

## CONTROL 25AV

The **Control 25AV** is an especially wide bandwidth, smooth response speaker. It is magnetically shielded for use in close proximity to video monitors. It features a top-quality 60 W multitap transformer for 70V/100V line distribution systems. The transformer may be bypassed allowing the Control 25AV to be used as an 8 ohm impedance speaker. Stainless steel grille and MTC-PC2 panel cover included for excellent weather resistance.

## CONTROL 28/CONTROL 28T-60

The **Control 28** offers high power, performance, bandwidth and sensitivity in a compact, full-range speaker. Incorporating an 8" low-frequency woofer and 1" titanium-coated tweeter, the Control 28 provides vivid sound reproduction for large-space applications. The optional **Control 28T-60** contains a multitap transformer for 70V/100V line distribution systems.

## CONTROL 29AV

The **Control 29AV** utilizes high power components, computer optimized horn and cabinet design, and complex network to achieve smooth high fidelity performance, extended bandwidth and well-controlled defined coverage from a compact loudspeaker. A rotatable 110° x 85° high-frequency horn allows use of the speaker in either vertical or horizontal orientation. Smooth frequency response and even coverage ensures excellent sound character throughout the listening area. Contains 10 inserts for suspending. Optional MTC-29UB U-bracket available.

## CONTROL 30

The **Control 30** is a three-way high output speaker designed for multiple uses. Weather resistance has been maximized, making the Control 30 suitable for outdoor applications. It features a top-quality 150 W multitap transformer for 70V/100V line distribution systems with a bypass for use as an 8 ohm speaker.

## CONTROL SB210

The **Control SB210** subwoofer contains two high power 10" woofers suitable for a variety of applications both indoors and out. Its compact size, durable enclosure, insert points, and stacking options make it one of the most versatile subwoofers in the installation market.

## CONTROL SB-2

The **SB-2** features a hybrid load-baffle/bandpass design for musical clarity. This single speaker functions as the subwoofer section of left/right music systems, preserving the stereo separation. The dual voice coil 10" bass transducer has been optimized to complement the Control 23 as a satellite speaker. (Not outdoor capable.)

## ACCESSORIES

**MTC-PC2:** The MTC-PC2 Panel Cover provides sealed entrance protection for input terminals and strain relief for incoming speaker wire.

**MTC-xxSSG and MTC-xxWMG:** SSG stainless steel retrofit grilles for Control 23, 25, and 28. WMG WeatherMax™ grilles add a foam and tight-weave backing to break up driving rain.

## MOUNTING BRACKETS

### MTC-xxUB:

U-brackets for installing Control 29AV, 30 and SB210. Available in black or white.

### MTC-xxH\* Horizontal Array Brackets:

Allows horizontal arraying of two Control 23, 25 or 28 speakers with splay angles of 60°. MTC-H brackets can be interconnected to form a suspended ring for mounting 6 speakers or 3 speakers in a 360° cluster module.

### MTC-xxV\* Vertical Array Brackets:

Allows vertical end-to-end arraying of up to three Control 23, 25, or 28 speakers in a tight attractive column.

### MTC-xxCM\* Ceiling Brackets:

The curved arm allows installation of Control 23, 25, 28, 29AV or 30 speakers down from a ceiling instead of out from a wall.

### SB-2 Installation Brackets:

The MTC-SB2W wall/corner bracket allows mounting of the subwoofer onto a wall surface or into a corner. The MTC-SB2C ceiling bracket enables suspension of the SB-2 from above, projecting downward into the listening area.

Various adaptors for installing via threaded pipe or rod available from third party. Contact JBL for information.

\* These models are available in different sizes. Specify speaker model when ordering.



CONTROL SB-2

CONTROL SB210

- INVISIBALL® MOUNTING TECHNOLOGY
- WEATHEREDGE™ FOR MOISTURE PROTECTION
- OPTIONAL FACTORY INSTALLED TRANSFORMERS
- READY-TO-PAINT TEXTURED HIPS ENCLOSURES
- SELECTION OF VERSATILE MOUNTING HARDWARE

CONTROL 30-WH

All models available in black or white (-WH).



CONTROL 29AV

CONTROL 28/28T-60

CONTROL 25/25T

CONTROL 25AV

CONTROL 23/23T

MOUNTING BRACKETS



MTC-xxUB U-BRACKET



MTC-xxV\* VERTICAL ARRAY BRACKETS



MTC-xxCM\* CEILING BRACKETS



3) MTC-xxH\* AS CLUSTER MODULE BRACKET

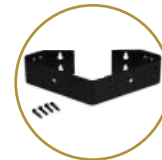

MTC-xxH\* HORIZONTAL ARRAY BRACKETS



SB-2 BRACKETS

<sup>1</sup> Half-space (on wall).

<sup>2</sup> Continuous Program Power, which is a conservative expression of the system's ability to handle normal speech and music program material and is defined as 3 dB above the Continuous Pink Noise rating (IEC-shaped pink noise with a 6 dB crest factor, for 100 hours continuously).

<sup>3</sup> Continuous Pink Noise for 100 hours.

[SPECIFICATIONS]

	CONTROL 23/23T	CONTROL 25/25T	CONTROL 25AV
<b>FREQUENCY RANGE (-10 dB)<sup>1</sup></b>	85 Hz - 22 kHz (23) 100 Hz - 21 kHz (23T)	80 Hz - 16 kHz (25) 80 Hz - 15 kHz (25T)	70 Hz - 23 kHz
<b>POWER CAPACITY: PROGRAM<sup>2</sup> PINK<sup>3</sup></b>	50 W (23) 25 W	150 W (25) 75 W	200 W 100 W
<b>NOMINAL COVERAGE</b>	90° x 90°	90° x 90°	100° x 100°
<b>SENSITIVITY: 1 W, 1 m</b>	86 dB SPL (23)	88 dB SPL (25)	87 dB SPL
<b>NOMINAL IMPEDANCE</b>	8 ohms (70V/100V 23T)	8 ohms (70V/100V 25T)	8 ohms
<b>COMPONENTS: LOW FREQ. HIGH FREQ.</b>	3 1/2" (88 mm) 1/2" (13 mm)	5 1/4" (135 mm) 3/4" (19 mm)	5 1/4" (130 mm) 3/4" (20 mm)
<b>TRANSFORMER TAPS: 100V 70.7V</b>	10 W (23T) 5 W (23T)	30, 15, 7.5 W (25T) 30, 15, 7.5, 3.7 W (25T)	60, 30, 15 W 60, 30, 15, 7.5 W
<b>ENCLOSURE</b>	HIPS (High Impact Polystyrene)	HIPS (High Impact Polystyrene)	HIPS (High Impact Polystyrene)
<b>FINISH</b>	Black or white (-WH)	Black or white (-WH)	Black or white (-WH)
<b>DIMENSIONS (H x W x D)</b>	193 x 140 x 111 mm 7.6 x 5.5 x 4.4 in	236 x 188 x 149 mm 9.3 x 7.4 x 5.8 in	236 x 186 x 159 mm 9.3 x 7.4 x 6.3 in
<b>NET WEIGHT (each)</b>	1.8 kg (4 lbs) (23 & 23T)	2.3 kg (5 lbs) (25) 3.6 kg (8 lbs) (25T)	4.0 kg (9 lbs)

	CONTROL 28/28T-60	CONTROL 29AV	CONTROL 30	CONTROL SB210	CONTROL SB-2
<b>FREQUENCY RANGE (-10 dB)<sup>1</sup></b>	60 Hz - 16 kHz (28) 55 Hz - 15 kHz (28T-60)	40 Hz - 19 kHz	38 Hz - 17 kHz	42 Hz - 200 Hz	38 Hz - 160 Hz
<b>POWER CAPACITY: PROGRAM<sup>2</sup> PINK<sup>3</sup></b>	175 W (28) 87 W	300 W 150 W	500 W 250 W	800 W 400 W	340 W (both inputs) 170 W (both inputs)
<b>NOMINAL COVERAGE</b>	90° x 90°	110° x 85° (rotatable)	120° x 110°	N/A	N/A
<b>SENSITIVITY: 1 W, 1 m</b>	92 dB SPL (28)	92 dB SPL	93 dB SPL	96 dB SPL (near corner) 102 dB SPL (on wall)	100 dB SPL (near corner) 94 dB SPL (on wall)
<b>NOMINAL IMPEDANCE</b>	8 ohms (70V/100V 28T)	8 ohms	8 ohms	8 ohms	8 ohms per input
<b>COMPONENTS: LOW FREQ. MID FREQ. HIGH FREQ.</b>	8" (200 mm)	8" (200 mm)	10" (250 mm) 5" (125 mm)	2 x 10" (250 mm)	10" (250 mm) long-throw with dual voice coils
<b>TRANSFORMER TAPS: 100V 70.7V</b>	60, 30, 15 W (28T-60) 60, 30, 15, 7.5 W (28T-60)	110, 55, 28 W 110, 55, 28, 14 W	150, 75, 38 W 150, 75, 38, 19 W		
<b>ENCLOSURE</b>	HIPS (High Impact Polystyrene)	HIPS (High Impact Polystyrene)	HIPS (High Impact Polystyrene)	HIPS (High Impact Polystyrene)	Particle Board
<b>FINISH</b>	Black or white (-WH)	Black or white (-WH)	Black or white (-WH)	Black or white (-WH)	Black
<b>DIMENSIONS (H x W x D)</b>	380 x 280 x 220 mm 15.0 x 11.0 x 8.6 in	520 x 306 x 277 mm 20.5 x 12.0 x 10.9 in	593 x 372 x 345 mm 23.3 x 14.6 x 13.5 in	335 x 590 x 570 mm 14 x 23.3 x 22.5 in	394 x 585 x 343 mm 15.5 x 23.0 x 13.5 in
<b>NET WEIGHT (each)</b>	5.5 kg (12 lbs) (28) 6.3 kg (14 lbs) (28T-60)	12.2 kg (27 lbs)	18.9 kg (42 lbs)	17.1 kg (38 lbs)	19.1 kg (42 lbs)

# Soundzone® Business Music Controllers

Business patrons are becoming accustomed to hearing great music quality in their homes, in their cars and in movie theaters. They now expect the same high quality sound in business environments. JBL Professional's Soundzone Business Music Systems make it easier than ever to get premium performance in business environments, while at the same time being very easy for end-users to operate.

The JBL Z21S and Z32S Soundzone Controllers are specifically designed for flexible control of multiple audio sources. With unparalleled ease of use, the user simply selects the music source, its volume and the mic paging volume. Sophisticated functions such as AutoWarmth® and LevelGuard™ operate automatically without requiring technical knowledge on the part of end-users. The SMS1 Soundzone Music System is a fully self-contained complete business music system for use in areas up to 2500 square feet.

## Z21S & Z32S SOUNDZONE CONTROLLERS

**Ease of Use and Installation:** Soundzone controls are intuitive; the user simply selects the music source and volume for each zone. What's more, many functions are automatic, so no involvement or special training is required by the end-user. For the installer, Soundzone is easy to setup. Back panel LED's guide in setting key functions.

**Output Zone Capabilities:** The inclusion of built-in subwoofer crossovers on the zone outputs makes it easier to include a subwoofer in the sound system or to more easily add a subwoofer at a later date. Stereo-capable zones add spaciousness to business environments. Zones can also be used in mono.

## MICROPHONES

**PAGING MICROPHONES:** The Z-M1 is specifically designed for use with SMS1 System or Z21S controller. This large, easy to see microphone features a push-to-talk switch, weighted base and a 3-section gooseneck for easy aiming. The Z-M2 has a 2-zone selector switch for use with Z32S Soundzone Controller in 2-zone systems.

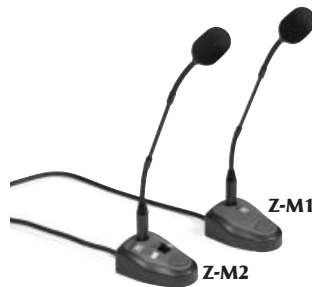

## ACCESSORIES

**WALL PLATES:** The ZR-V Wall Plate has a control to adjust the volume of the music. It operates as attenuate-only from the volume setting on the Soundzone Controller or SMS1 control panel. The ZR-V connects via a common Category 5 cable. Multiple ZR-Vs are required for systems with multiple SMS1 systems, each controlling one SMS1.

**ZR-2SV and ZR-3SV Wall Plates** allow remote selection of source and volume for Z21S or Z32S controllers. Note: These wall plates are standard U.S. size.

## Z21S AND Z32S SOUNDZONE CONTROLLERS



## [SPECIFICATIONS]

	Z32S	Z21S
INPUT SOURCES	3 (stereo or mono)	2 (stereo or mono)
OUTPUT ZONES	2 (stereo or mono) + Aux out	1 (stereo or mono)
INPUTS: LINE	Unbalanced, RCA connector X 2, per source	
MIC	Balanced, Euroblock connector	
INPUT NOISE: LINE	<0.06%, 20 Hz - 20 kHz (0 gain)	
MIC	-118 dBu EIN	
ZONE OUTPUTS:	Balanced, Euroblock connector	
SUBWOOFER	Low-passed 100 Hz, 24 dB/octave Linkwitz-Riley	
HPF	High-pass, 100 Hz, 24 dB/octave Linkwitz-Riley	
FREQUENCY RESPONSE:	Line Inputs: 30 Hz - 20 kHz ± 1 dB	
	Mic Inputs: Band limited to 250 Hz - 8 kHz ± 1 dB	
EQUALIZATION	Bass: ± 8 dB @ 50 Hz; Treble: ± 8 dB @ 10 kHz, non-symmetrical	
DIMENSIONS (H x W x D)	46 x 482 x 178 mm	
NET WEIGHT (each)	2.2 kg (5 lbs)	

- Easily assigned pages between Output Zones using a simple remote selector switch or hardwire configuration
- Adjustable Ducking
- A VCA Accessory port provides for future growth of sophisticated functions
- Easy expansion: Multiple controllers can be linked for sharing of sources or main busses for additional zones
- Advanced all-call and override functions
- Remote wall plates for remote source selection and/or volume adjustment
- Separate transformer isolated mono auxiliary output for a music-on-hold system or separate mono output zone
- Variable Priority Hold control



- EASY INSTALLATION, EASY TAMPER-PROOF USE
- AUTOWARMTH® TO ENSURE HIGHEST FIDELITY OVER A FULL RANGE OF VOLUMES
- LEVELGUARD™ TO KEEP THE MUSIC LEVEL EVEN WITH A RANGE OF SOURCES
- FLEXIBLE OUTPUT ZONE CAPABILITIES

[INSTALLATION PRODUCTS]

# Soundzone® Business Music Systems

The SMS1 Soundzone Music System is a complete business music system, ideal for background or foreground music applications such as retail stores, restaurants and other businesses. Fully self-contained powered system with four satellite speakers, the SMS1 is a quick-install, easy to use system for businesses with up to 2500 square feet. Even with its small size, the SMS1 Soundzone Music System delivers full fidelity music and clear paging with audio quality that customers expect from JBL.

## SMS1 SOUNDZONE MUSIC SYSTEM

The SMS1 Soundzone Music System includes the SMS1-SUB subwoofer and four satellite speakers.

The SMS1-Sub contains power amplification for all speakers, a controller for one music source and for one announcing microphone.

**SMS1 Satellite speakers:** Four unobtrusive satellite speakers complete the SMS1 system.

The SMS1-Sat speakers are installed easily using JBL's patented Invisiball mounting system, which allows for a wide range of adjustment in a unique theft-resistant design.



## SMS1 CONTROLLER

The controller built into the SMS1-Sub features:

**AutoWarmth:** A patent-pending signal processing system adds fullness at lower levels and reduces boominess at higher volumes, providing optimum sound at all volume levels.

**LevelGuard:** Automatically keeps the music level in check, despite any excessive level changes from the music source.

**Page Ducking:** Lowers the music audio when the microphone is in use and smoothly ramps the music back after the page is complete.



The SMS1 Soundzone Music System is easy to use. Available in both grey and white.



**SMS1 INPUT PANEL:** The SMS1 System accommodates one music source—such as programmed music, CD player, tuner, or tape player—and one paging microphone. A wide variety of input levels and types are allowed including: balanced line level, speaker level, or unbalanced (RCA) line level.

## [SPECIFICATIONS]

	SMS1-SUB	SMS1-SAT
<b>POWER CAPACITY</b>	80 W	10 W each
<b>SPL (1 m): LONG TERM PEAK</b>	105 dB 111 dB	93 dB (4 speakers) 99 dB (4 speakers)
<b>FINISH</b>	Grey or white (-WH)	Grey or white (-WH)
<b>DIMENSIONS (H x W x D)</b>	458 x 546 x 280 mm 18 x 21.5 x 11 in	135 x 84 x 94 mm 5.3 x 3.3 x 3.7 in
<b>NET WEIGHT (each)</b>	21.6 kg (48 lbs)	1.8 kg (4 lbs)



# [KEY FEATURES]

Control® Series

- MOLDED ENCLOSURES WITH SHIELDED MAGNETIC STRUCTURES
- HIGH SENSITIVITY AND POWER HANDLING CAPABILITY
- FULL COMPLEMENT OF MTC MOUNTING HARDWARE

## Control® Series

The JBL Control Series speakers offer high performance in a variety of applications. Well balanced sound and exceptional power handling make these speakers ideal for any installation requiring professional control monitor performance from a compact source.

### CONTROL 1™

The Control 1 is a high-performance personal monitor loudspeaker incorporating a 135 mm (5¼ in) low-frequency loudspeaker, 19 mm (¾ in) polycarbonate dome tweeter and high-performance dividing network. Compact and durable, the Control 1 performs equally well in recording studios, mobile audio-video control rooms and broadcast studios. It is also highly suitable for foreground and background music use in restaurants, discotheques and audio-visual applications.

### CONTROL 5™

The Control 5 is a high-performance, wide range control monitor suitable for use as the primary sound source in a variety of applications. The 165 mm (6½ in) low-frequency driver and 25 mm (1 in) pure titanium dome tweeter are magnetically shielded for use in close proximity to video monitors.

### CONTROL SERIES MOUNTING ACCESSORIES

Control Series enclosures are designed for applications in which minimal space, tight corners and tough angles are all too common. Specialized mounting systems allow positioning of enclosures in exactly the right space for optimum performance.



CONTROL 5



CONTROL 1



CONTROL 1

## [SPECIFICATIONS]

	CONTROL 1	CONTROL 5
FREQUENCY RESPONSE	120 Hz - 20 kHz (± 3 dB)	75 Hz - 20 kHz (± 3 dB)
POWER CAPACITY <sup>1</sup>	150 W	175 W
SENSITIVITY: 1 W, 1 m	87 dB SPL	89 dB SPL
NOMINAL IMPEDANCE	4 ohms	4 ohms
COMPONENTS: LF	135 mm (5¼ in)	165 mm (6½ in)
HF	19 mm (¾ in)	25 mm (1 in)
ENCLOSURE	Polypropylene structural foam	Polypropylene structural foam
FINISH	Black or white (-WH)	Black or white (-WH)
DIMENSIONS (H x W x D)	235 x 159 x 143 mm 9.25 x 6.25 x 5.6 in	387 x 251 x 229 mm 15.25 x 9.8 x 9 in
NET WEIGHT (each)	1.8 kg (4 lbs)	4.5 kg (10 lbs)

### MOUNTING ACCESSORIES



MTC-1A

MTC-8



MTC-51

MTC-52

<sup>1</sup> IEC filtered random noise (50 Hz - 5 kHz) with a crest factor (peak to average ratio) of 6 dB.

# Marquis Series Sound Power Series

The Marquis Series and Sound Power Series are designed for use in fixed installation applications. This series has been value engineered to provide systems with the highest performance vs. cost available.

The full range enclosures are pre-fitted with M10 threaded inserts and are supplied with an eyebolt kit. The MS26 and MS28 are equipped with “yoke mount” brackets and hardware. The cabinets suspend easily—both horizontally and vertically—offering a greater degree of versatility.

## MS26

The MS26 is a full-range, low profile system with 100° x 70° dispersion. This system features two 6” LF transducers and a 1” exit titanium composite tweeter integrated to a newly designed elliptical wave guide. The MS26 is ideal for close ceiling mounting or under-balcony applications.

## MS28

The MS28 is a full-range, low profile system with 85° x 85° dispersion. This system features two 8” LF transducers and a 1” compression driver on an Optimized Aperture Symmetrical Radiator. The MS28 is ideal for close ceiling mounting or under-balcony applications where higher power is needed.

## MS125S

The MS125S is a compact direct radiator subwoofer featuring two 15” low-frequency transducers. An internal passive low pass network can in some cases eliminate the need for an external electronic crossover.

## SP222

The SP222 is a true full-range system featuring two VGC 2206H LF transducers and a 2447J large format compression driver coupled to an Optimized Aperture Bi-Radial horn. The asymmetrical slant-back design allows for close-to-ceiling installation.

## SP225-6 AND SP225-9

The SP225-6 and SP225-9 are true full-range systems available with a nominal 60° (SP225-6) or 90° (SP225-9) coverage pattern. These systems feature two VGC 2226H 15” LF transducers, a 2447J large format compression driver on an Optimized Aperture Bi-Radial horn and trapezoidal enclosures.

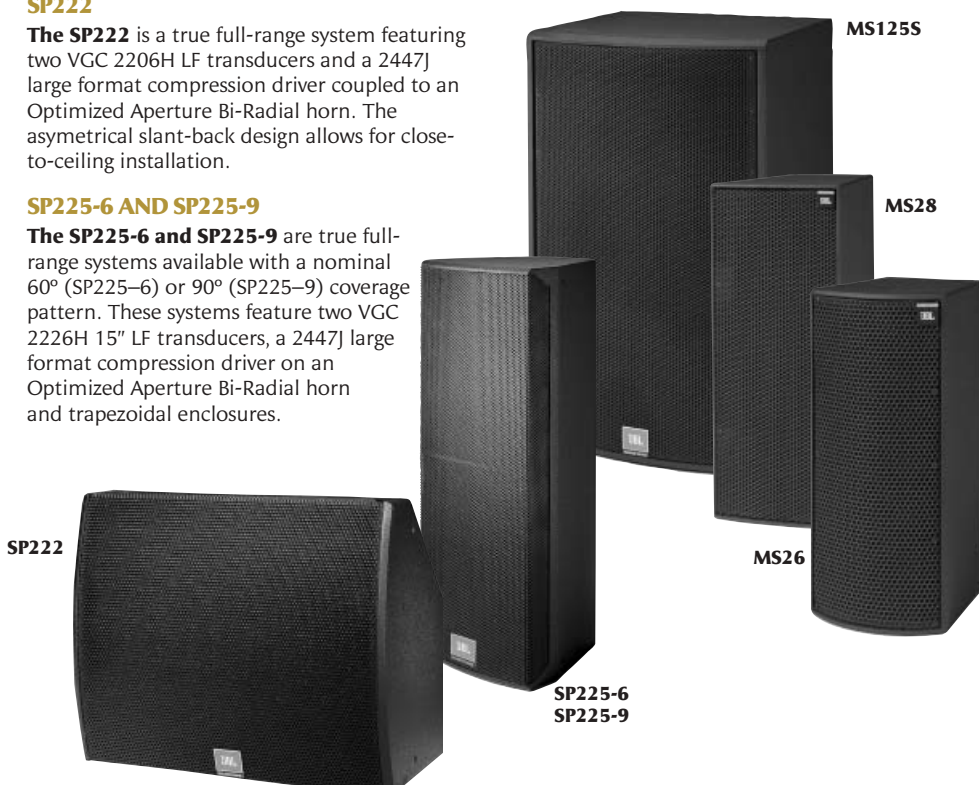

## [SPECIFICATIONS]

	MS26	MS28	MS125S	SP222	SP225-6	SP225-9
SYSTEM TYPE	Two-way Full-range	Two-way Full-range	Low Frequency	Two-way Full-range	Two-way Full-range 60°	Two-way Full-range 90°
FREQ. RANGE (-10 dB)	45 Hz - 20 kHz	40 Hz - 20 kHz	35 Hz - 250 Hz	32 Hz - 20 kHz	33 Hz - 20 kHz	33 Hz - 20 kHz
FREQ. RESPONSE (-3 dB)	65 Hz - 19 kHz	60 Hz - 19 kHz	40 Hz - 175 Hz	42 Hz - 18 kHz	42 Hz - 18 kHz	42 Hz - 18 kHz
NOMINAL COVERAGE	100° x 70°	85° x 85°		100° x 50°	60° x 50°	60° x 50°
POWER CAPACITY <sup>1</sup>	150 W	200 W	700 W	1200 W	1200 W	1200 W
SENSITIVITY: 1 W, 1 m	91 dB	93 dB	100 dB	98 dB	100 dB	100 dB
NOMINAL IMPEDANCE	16 ohms	16 ohms	4 ohms	4 ohms	4 ohms	4 ohms
COMPONENTS: LF	2 x 152 mm (6 in)	2 x 203 mm (8 in)	2 x 380 mm (15 in)	2 x 2206H (12 in)	2 x 2226H (15 in)	2 x 2226H (15 in)
HF	25 mm (1 in)	25 mm (1 in)		2447J	2447J	2447J
ENCLOSURE	Low profile	Low profile	Rectangular	Asymmetrical	Trapezoidal	Trapezoidal
FINISH	Black DuraFlex	Black DuraFlex	Black DuraFlex	Black DuraFlex	Black DuraFlex	Black DuraFlex
INPUT CONNECTORS	2 x NL4 Neutrik Speakon®	2 x NL4 Neutrik Speakon	2 x NL4 Neutrik Speakon	2 x NL4 Neutrik Speakon	2 x NL4 Neutrik Speakon	2 x NL4 Neutrik Speakon
DIMENSIONS (H x W x D)	599 x 217 x 241 mm 23.6 x 8.55 x 9.5 in	676 x 291 x 321 mm 26.6 x 11.45 x 12.65 in	923 x 570 x 572 mm 36.35 x 22.45 x 22.5 in	577 x 707 x 476 mm 22.73 x 27.85 x 18.75 in	923 x 570 x 572 mm 36.35 x 22.45 x 22.5 in	923 x 570 x 572 mm 36.35 x 22.45 x 22.5 in
NET WEIGHT (each)	8.2 kg (18 lbs)	12.7 kg (28 lbs)	45.5 kg (100 lbs)	49.9 kg (110 lbs)	45.5 kg (100 lbs)	45.5 kg (100 lbs)

<sup>1</sup> IEC filtered random noise (50 Hz - 5 kHz) with a crest factor (peak to average ratio) of 6 dB

# EVO™

With the introduction of EVO, professional sound reinforcement enters a whole new era: The Intelligent Era. Utilizing JBL's Distributed Intelligence™ process, EVO is the first and only loudspeaker system fully capable of adapting itself to its environment. It's actually self-aware. EVO adjusts its frequency response to compensate for the effect of its environment and sets its own delay with knowledge of where its partner speakers are located.

What's more, EVO intuitively recognizes how hard it's being driven and how hot the transducer coils are getting. It then adjusts discrete transducer levels accordingly and compensates for power compression to keep your audio consistent. EVO's intelligence discerns program signal from feedback. It finds feedback and eliminates it. It monitors its own operation and reports its condition. The result: EVO sounds its best no matter how hard it's working.

## EVOi.324



EVOi.324 is a Filtered Array Technology (FAT™) design with three discrete pass bands that provides a constant 80° x 80° horizontal and vertical coverage pattern.

Each 14", LF and LF/Mid NDD™ carbon fiber cone transducer, is driven by its own 600 watt Class-D (digital) amplifier. The 2430 Neodymium large format compression driver coupled to an all aluminum waveguide is powered by a 100 watt linear amplifier. A switch mode power supply delivers the voltage necessary to drive 1300 watts of power amplification.

Synchronized on-board Digital Signal Processing (DSP) controls the speaker system parameters, crossovers, parametric EQs, limiting and FAT tapering functions.

EVO's 'brain' is found in the EVOi.324. All transducer controls and complex computational system functions take place on the digital electronics circuit board within the aluminum housing.

These functions include: the Auto-EQ software routine in which the EVOi.324 automatically equalizes its frequency response to the room, the automated delay setting of the EVOi.324, feedback suppression and thermal management, part of the Enhanced Total Thermal Management System. The ETTMS adapts the performance of the EVOi.324 maintaining tonal balance and preventing thermal overdrive.

## EVOi.net

EVOi.net, in a standard 19" rack mount configuration, supplied with dedicated JBL measurement microphone and 100 ft (30.5 m) XLR signal cable is all that's needed to access the total functionality of EVOi.324.

Apart from the XLR signal cable to hook-up the EVOi.324 to EVOi.net, no other cables are required. A BiDAT™ (Bi-directional Data-over-Audio Transceiver) communication system ensures that instructions are sent and messages received.

Connecting the measurement microphone and pressing the Auto-EQ button initializes the Set-Up sequence. A short time later the entire system is set to its specific acoustic environment. Similarly, pressing the Delay Set button instructs each EVOi.324 to set its delay in accordance with other EVOi.324s in the system ensuring maximum intelligibility.

Once set-up, the operator can then adjust the whole system, whether optimizing it for speech intelligibility, live or pre-recorded music. The operator can monitor the status of each EVOi.324 as they report their condition.

## EVO DCI v1.0

EVO DCI v1.0 is a simple software application that allows a user to communicate directly with an EVO Intelligent Loudspeaker. Designed for the Windows operating system, EVO DCI permits additional control of EVOi.324 loudspeakers via computer. The results and performance of many functions can be viewed, adjusted and stored for later use. This software program is intended for EVO installers who wish to use EVO in applications that fall outside the standard EVO applications or where fine tuning may provide optimum results.

EVOi.net is the communications hub of an EVO system that allows up to four EVO speakers to be networked together through it. The computer is connected to EVOi.net utilizing the RS232 port on the front panel. A RS232 serial cable (female DB9-Mini Din 8 male, similar to a 'BSS Soundweb' cable) is required.

## EVOi.sys

EVOi.sys is a fully designed sound reinforcement system, with all the necessary components integrated into single enclosures. The EVOi.324s are installed with standard hardware, and the hook-up is limited to only two major connections from the EVOi.net.

EVO combines ease of use with reliable and consistent results. It's as easy as: 1. Positioning the matched measurement microphone, 2. connecting it to EVOi.net and 3. pushing the Auto-EQ button initiating the EVO set-up routine. A few minutes later, EVO has adapted to its acoustic environment ensuring maximum performance. The settings can then be locked-in ensuring the sonic performance won't change.

With EVO, the operator can choose whether the system is optimized for a speech program, live or recorded music. With the push of a button, the operator can make the choice of whether the assistance of Anti Feedback Control is needed. EVO will let the operator know everything is working and totally optimized for their venue and performance.

## With EVOi.sys, everything is included:

- |   |                                      |
|---|--------------------------------------|
| 2) EVOi.324                               | 1) Integrated rack*                  |
| 1) EVOi.net, with Measurement microphone* | 4) Microphone stands                 |
| 1) 16 channel mixer, with Lexicon reverb* | 3) 100 ft (30.5 m) XLR signal cables |
| 2) UHF wireless mic systems*              | 6) 50 ft (15.25 m) XLR signal cables |
| 6) Dynamic supercardioid microphones      | 4) 2 ft (0.6 m) XLR signal cables    |
|   | 1) Dust Cover                        |

\*Integrated in same enclosure

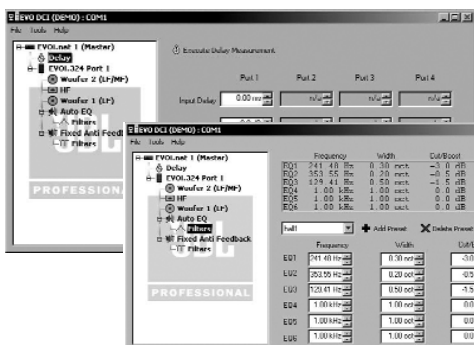



St. John's Church; Napa, California



EVOi.324

# [KEY FEATURES]

- AUTOMATIC ACOUSTIC SET-UP, AUTO-EQ AND DELAY-SET\*
- AUTOMATED FEEDBACK SUPPRESSION, ANTI-FEEDBACK CONTROL\*
- AUTOMATIC SELF DIAGNOSTICS, SPEAKER STATUS REPORTING\*
- ENHANCED TOTAL THERMAL MANAGEMENT SYSTEM (ETTMS)
- PRE-SET EQs FOR SELECTABLE SYSTEM RESPONSE
- 3-WAY TRI-AMP FILTERED ARRAY TECHNOLOGY™ (FAT) DESIGN
- STD M10 EYEBOLT FIXTURES, 6 CONNECTION POINTS, 3 EYEBOLT KIT

\*These functions are accessible through the use of EVOi.net

## EVO MOUNTING HARDWARE



EVO WM300



EVO HS-1

The **EVO WM300** Adaptor Kit includes all necessary hardware to use EVOi.324 with Omnimount 120 Series compatible brackets.

The **EVO HS-1 Kit** includes 2) steel pick-up plates, an eyebolt and all nuts and washers for horizontal suspension of an EVOi.324.



# [SPECIFICATIONS]

## EVOi.324

SYSTEM TYPE	Three-way Full-range
FREQUENCY RANGE	40 Hz - 18 kHz (-10 dB)
FREQUENCY RESPONSE	48 Hz - 16 kHz (-3 dB)
COVERAGE	80° x 80° (500 Hz - 16 kHz avg.)
SENSITIVITY: 1 W, 1 m	101 dB (-15 dBu @ 1 meter)
MAX. OUTPUT: LF	330 W (with Limiters) Continuous, 600 W Burst
MF	330 W (with Limiters) Continuous, 600 W Burst
HF	50 W (with Limiters) Continuous, 100 W Burst
TRANSDUCERS: LF	14" NDD, Carbon Fiber Cone, Dual 2" Voice Coils
MF	14" NDD, Carbon Fiber Cone, Dual 2" Voice Coils
HF	2430, Large Format, 1½" Exit Compression Driver
ENCLOSURE	2nd Order geometric SMC
SUSPENSION	6 inserts (Std M10), 3 eyebolts included
FINISH	White or black (paintable)
INPUT CONNECTORS	Balanced XLR
DIMENSIONS (H x W x D)	1067 x 353 x 386.2 mm 42 x 13.9 x 15.2 in
NET WEIGHT (each)	29.48 kg (65 lbs)



EVOi.net

## EVOi.net

DESCRIPTION	Intelligent Speaker System Controller
INPUTS	2 channels, Max. level +20 dB (7.5 Vrms), 8k Ohms impedance, Electronically Balanced, XLR connectors, pin 2+, 1 Dedicated JBL Measurement Microphone, XLR.
OUTPUTS	4 Channels, Dedicated EVO Intelligent Speaker outputs, Electronically Balanced, XLR connectors, pin 2+. Outputs 3 & 4 dedicated Auxiliary System Outputs, with "Delay Set" option and Mono Sum capability.
SIGNAL-TO-NOISE	>110 dB, 22 Hz - 22 kHz
THD	<0.01%, 20 Hz - 20 kHz @ +10 dBu
FREQUENCY RESPONSE	20 Hz - 20 kHz <± 0.5 dB
DIMENSIONS (H x W x D)	44.4 x 483 x 171 mm 1.75 x 19 x 6.73 in
NET WEIGHT (each)	2.6 kg (5.7 lbs)

The AE Application Engineered Series was designed with one goal in mind, to deliver the performance and features contractors and consultants need and that listeners demand. Incorporating the latest loudspeaker technology, a wide selection of models, high performance features, reliability and a systems approach, AE Series has a loudspeaker for just about any challenge you might come across.

Whatever your need—whether performance-maximized or compact profile; tri-amp; bi-amp or passive crossover; higher power or lower cost; vertical or horizontal installation—

**AE Series has the right  
loudspeaker for the job!**

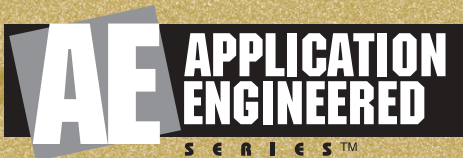



- SCALED SYSTEM APPROACH WITH VERSATILE OPTIONS
- VGC™ DRIVERS AND NDD™ NEODYMIUM DIFFERENTIAL DRIVE® CONE TRANSDUCERS
- PT™ PROGRESSIVE TRANSITION WAVEGUIDES FOR PATTERN CONTROL

[INSTALLATION PRODUCTS]

# Application Engineered Series™

AE Series loudspeakers are ideal for a wide variety of fixed installation applications including performing arts facilities, theatrical sound design, auditoriums, houses of worship, live music clubs, dance-clubs/discotheques, sports facilities and themed entertainment venues. The special mid-high frequency models can be used without LF reinforcement in voice-only PA and delay-fill applications. The smaller models are ideal in lecture halls and corporate learning centers as well as in delay-fill locations of larger systems.

## Scaled System Design Approach

AE Series models provide a wide variety of building blocks for your system design, stair-stepped to give you just the right solution for your installation.

**6000 SERIES**  
**4000 SERIES**  
**2000 SERIES**

**6000-Series** models are the highest power speakers in the AE Series. **4000-Series** models are medium power and **2000-Series** are at lower power points for applications not requiring high power capability.

## Waveguide Scaling

Sometimes you need maximum pattern control. Other times the speaker needs to be as compact as possible. [AM] models are performance-maximized for the greatest pattern control. [AC] models are compact speakers that fit in areas where a smaller frontal profile is required.

## Sophisticated Crossover Networks

AE Series models incorporate sophisticated crossover designs for outstanding sound quality and consistent coverage. To minimize overlap between adjacent frequency bands, steep slopes are utilized in passive crossovers — most are 4th order (24 dB/octave). This reduces off-axis lobing, providing consistent coverage throughout the crossover region. Conjugate networks are added in some models to fine tune the frequency response for optimum sound quality.

## Rotatable Waveguides

The space often dictates how a speaker needs to be oriented. All [AM] two-way and three-way models include a rotatable waveguide, allowing the speaker to be installed in either vertical or horizontal orientation.

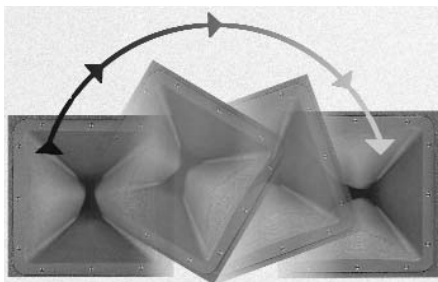

## Selectable Crossover Mode

Many AE Series speakers offer selectable crossover modes: tri-amp/bi-amp or bi-amp/passive switchable.

## Versatile Model Options

All AE Series speakers are available in several versions for matching décor or for outdoor use. Any model can be finished in white (-WH) or left unfinished and ready to paint (-UF). Additionally, two degrees of weather resistance are available. For many environments the basic weather resistance option (-WRC) is suitable. An extra thick DuraFlex coating, multilayer grille and component treatments provide excellent environmental protection. For extreme environments, with high humidity and/or rapid temperature cycling, a maximum weather treatment (-WRX) adds a full fiberglass covering of the cabinet.

## Legendary JBL Transducers

AE Series incorporates the legendary reliability of JBL's VGC™ drivers, augmented by today's new generation of JBL compression drivers and NDD™ Neodymium Differential Drive® cone transducers. Where reliability is important, JBL transducers are known as the best, most reliable drivers in the business.

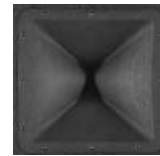

## PT™ Progressive Transition Waveguides

JBL's new patent pending Progressive Transition Waveguides represent the latest in horn technology. In addition to providing smooth, low distortion sound, PT waveguides deliver uniform off-axis frequency response to every point within the intended coverage area — not just in the horizontal and vertical planes — resulting in superior array-ability of multiple loudspeaker systems. PT Waveguides combine outstanding pattern control with undistorted sound for natural music and intelligible speech.

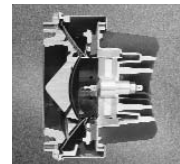

## CMCD™ Cone Midrange Compression Drivers

Incorporated into all cone midrange models — patent pending CMCD technology is more than a simple displacement plug. In addition to providing increased output and lower distortion, this cone-based true compression driver design extends operational bandwidth (both up and down in frequency) to cover the entire vocal range seamlessly, allows for better waveguide pattern control, and improves phase coherency of the midrange signal for clearer, more intelligible audio quality.

## MODEL NUMBERING KEY

**EXAMPLE: AM6340/95**

- M** = Performance Maximized
- C** = Compact
- LF** = Low Frequency
- SB** = Subwoofer
- SH** = Subwoofer Horn-Loaded

- 6000** = Highest Power
- 4000** = Medium Power
- 2000** = Lower Power

- 3** = 3-Way
- 2** = 2-Way
- 1** = 1-Band

- The Number of LF Drivers**
- 4** = 4 LF Drivers
- 2** = 2 LF Drivers
- 1** = 1 LF Driver
- 0** = 0 Mid-Hi or HF System

- Woofer Size**
- 8** = 18" (For smaller future models, # may refer to the under-10" diameter)
- 5** = 15"
- 2** = 12"
- 0** = 10"

- Coverage Pattern**
- Horizontal**
- 0** = 100°
- 9** = 90°
- 6** = 60°
- Vertical**
- 0** = 100°
- 5** = 50°
- 4** = 40°

[AM] Rotatable  
[AC] NOT Rotatable  
(Contact JBL about additional patterns)

# [SPECIFICATIONS]

[INSTALLATION PRODUCTS]

## [AM] MAXIMIZED 3-WAY



AM6340/xx

AM6315/xx

AM6200/xx

AM4315/xx

AM4200/xx

	AM6340/95 AM6340/64	AM6315/95 AM6315/64	AM6200/95 AM6200/64	AM4315/95 AM4315/64	AM4200/95 AM4200/64
SYSTEM TYPE	High-power Three-way	High-power Three-way	High-power Mid-high	Medium-power Three-way	Medium-power Mid-high
FREQUENCY RANGE	50 Hz - 19 kHz (-10 dB)	38 Hz - 19 kHz (-10 dB)	200 Hz - 19 kHz (-10 dB)	40 Hz - 23 kHz (-10 dB)	350 Hz - 23 kHz (-10 dB)
FREQUENCY RESPONSE	55 Hz - 17 kHz ( $\pm 3$ dB)	45 Hz - 17 kHz ( $\pm 3$ dB)	250 Hz - 17 kHz ( $\pm 3$ dB)	50 Hz - 20 kHz ( $\pm 3$ dB)	400 Hz - 20 kHz ( $\pm 3$ dB)
NOMINAL COVERAGE	AM6340/95: 90° x 50° AM6340/64: 60° x 40°	AM6315/95: 90° x 50° AM6315/64: 60° x 40°	AM6200/95: 90° x 50° AM6200/64: 60° x 40°	AM4315/95: 90° x 50° AM4315/64: 60° x 40°	AM4200/95: 90° x 50° AM4200/64: 60° x 40°
TRANSDUCER	LF	LF	LF	MF/HF	MF/HF
POWER RATING(AES)	1200 W (4800 W peak) 350 W (1400 W peak) 75 W (300 W peak)	1000 W (4000 W peak) 350 W (1400 W peak) 75 W (300 W peak)	350 W (1400 W peak) 75 W (300 W peak)	500 W (2000 W peak)	125 W (500 W peak) 35 W (120 W peak)
LONG-TERM POWER RATING(IEC): MF/HF	1000 W (4000 W peak) 350 W (1400 W peak)	600 W (2400 W peak) 350 W (1400 W peak)	350 W (1400 W peak)	350 W (1400 W peak) (Passive mode)	125 W (500 W peak)
MAXIMUM SPL <sup>1</sup> : LF	130 dB	125 dB		124 dB	
MF	133 dB	133 dB	133 dB		127 dB
HF	134 dB	134 dB	134 dB		129 dB
BI-AMP MODE: MF/HF	133 dB	133 dB	133 dB	127 dB	127 dB
SELECTABLE CROSSOVER MODES	Bi-amp Tri-amp	Bi-amp Tri-amp	Bi-amp Passive	Bi-amp Passive	Bi-amp Passive
SUSPENSION	13 points	13 points	13 points	13 points	13 points
DIMENSIONS (H x W x D)	1094 x 561 x 657 mm 43.1 x 22.1 x 25.9 in	967 x 561 x 657 mm 38.1 x 22.1 x 25.9 in	548 x 561 x 657 mm 21.6 x 22.1 x 25.9 in	967 x 561 x 657 mm 38.1 x 22.1 x 25.9 in	548 x 561 x 657 mm 21.6 x 22.1 x 25.9 in
NET WEIGHT (each)	56.7 kg (125 lbs)	48.3 kg (107 lbs)	29.0 kg (64 lbs)	46.7 kg (103 lbs)	28.1 kg (62 lbs)

## [AM] MAXIMIZED 2-WAY



AM6215/xx

AM6212/xx

AM4215/xx

AM4212/xx

	AM6215/95 AM6215/64	AM6212/95 AM6212/64 AM6212/00	AM4215/95 AM4215/64	AM4212/95 AM4212/64 AM4212/00
SYSTEM TYPE	High-power Two-way	High-power Two-way	Medium-power Two-way	Medium-power Two-way
FREQUENCY RANGE	35 Hz - 19 kHz (-10 dB)	40 Hz - 19 kHz (-10 dB)	40 Hz - 20 kHz (-10 dB)	55 Hz - 20 kHz (-10 dB)
FREQUENCY RESPONSE	45 Hz - 17 kHz ( $\pm 3$ dB)	60 Hz - 17 kHz ( $\pm 3$ dB)	45 Hz - 18 kHz ( $\pm 3$ dB)	70 Hz - 18 kHz ( $\pm 3$ dB)
NOMINAL COVERAGE	AM6215/95: 90° x 50° AM6215/64: 60° x 40°	AM6212/95: 90° x 50° AM6212/64: 60° x 40° AM6212/00: 100° x 100°	AM4215/95: 90° x 50° AM4215/64: 60° x 40°	AM4212/95: 90° x 50° AM4212/64: 60° x 40° AM4212/00: 100° x 100°
TRANSDUCER	LF	LF	LF	LF
POWER RATING(AES): HF	1000 W (4000 W peak) 75 W (300 W peak)	800 W (3200 W peak) 75 W (300 W peak)	500 W (2000 W peak) 35 W (140 W peak)	400 W (2000 W peak) 35 W (140 W peak)
LONG-TERM POWER RATING(IEC): PASSIVE MODE:	600 W (2400 W peak)	600 W (2400 W peak)	350 W (2400 W peak)	350 W (2400 W peak)
MAXIMUM SPL <sup>1</sup> : LF/HF	LF: 127 dB; HF: 133 dB	LF: 124 dB; HF: 139 dB	LF: 124 dB; HF: 128 dB	LF: 120 dB; HF: 125 dB
PASSIVE MODE:	127 dB	124 dB	124 dB	120 dB
SELECTABLE CROSSOVER MODES	Bi-amp Passive	Bi-amp Passive	Bi-amp Passive	Bi-amp Passive
SUSPENSION	15 points	15 points	15 points	15 points
DIMENSIONS (H x W x D)	783 x 422 x 504 mm 30.8 x 16.6 x 19.9 in	713 x 371 x 460 mm 28.1 x 14.6 x 18.1 in	783 x 422 x 504 mm 30.8 x 16.6 x 19.9 in	713 x 371 x 460 mm 28.1 x 14.6 x 18.1 in
NET WEIGHT (each)	29.9 kg (66 lbs)	26.3 kg (58 lbs)	29.0 kg (64 lbs)	25.4 kg (56 lbs)



**[AC]**  
COMPACT 2-WAY



	AC2215/95 AC2215/64 AC2215/00	AC2212/95 AC2212/64 AC2212/00
SYSTEM TYPE	Lower-power Two-way	Lower-power Two-way
FREQUENCY RANGE	42 Hz - 19 kHz (-10 dB)	50 Hz - 19 kHz (-10 dB)
FREQUENCY RESPONSE	50 Hz - 17 kHz (± 3 dB)	55 Hz - 17 kHz (± 3 dB)
NOMINAL COVERAGE	AC2215/95: 90° x 50° AC2215/64: 60° x 40° AC2215/00: 100° x 100°	AC2212/95: 90° x 50° AC2212/64: 60° x 40° AC2212/00: 100° x 100°
TRANSDUCER LF POWER RATING(AES): HF	275 W (1100 W peak) 30 W (120 W peak)	300 W (1100 W peak) 30 W (120 W peak)
LONG-TERM POWER RATING(IEC) :	250 W (1000 W peak)	250 W (1000 W peak)
MAXIMUM SPL <sup>1</sup> : LF HF PASSIVE MODE:	121 dB 127 dB 121 dB	120 dB 129 dB 120 dB
SELECTABLE CROSSOVER MODES	Bi-amp Passive	Bi-amp Passive
SUSPENSION	15 points	15 points
DIMENSIONS (H x W x D)	637 x 422 x 504 mm	548 x 355 x 352 mm
NET WEIGHT (each)	23.6 kg (52 lbs)	18.1 kg (40 lbs)

AL6125



**[AL]**  
LOW FREQUENCY

	AL6115	AL6125
SYSTEM TYPE	High-power Low Freq.	High-power Low Freq.
FREQUENCY RANGE	40 Hz - 2.5 kHz (-10 dB)	40 Hz - 2.5 kHz (-10 dB)
FREQUENCY RESPONSE	47 Hz - 2.1 kHz (± 3 dB)	42 Hz - 2.1 kHz (± 3 dB)
TRANSDUCER POWER RATING(AES)	1000 W (4000 W peak) (2 hrs)	2000 W (8000 W peak) (2 hrs)
LONG-TERM SYSTEM POWER RATING	600 W (2400 W peak) 100 hrs	1200 W (2400 W peak) 100 hrs
MAXIMUM SPL <sup>1</sup>	50 Hz -125 Hz: 129 dB 125 Hz - 800 Hz: 127 dB	50 Hz -125 Hz: 130 dB 125 Hz - 800 Hz: 129 dB
SELECTABLE CROSSOVER MODES	Discrete	Parallel Discrete
ENCLOSURE SUSPENSION	Trapezoidal, 15° side angles 13 points	Rectangular 12 points
DIMENSIONS (H x W x D)	548 x 561 x 657 mm 21.6 x 22.1 x 25.9 in	967 x 422 x 504 mm 38.1 x 16.6 x 19.9 in
NET WEIGHT (each)	29.0 kg (64 lbs)	44.5 kg (98 lbs)

<sup>1</sup> Maximum long-term average SPL. Peak SPL is 6 dB higher. Figure is for highest Q version.

**[ASB]**  
SUBWOOFERS



	ASB6118	ASB6128	ASB4128	ASB6128V	ASH6118
SYSTEM TYPE	High-power Subwoofer	High-power Subwoofer	Medium-Power Subwoofer	Extended Response Sub	Horn-loaded Subwoofer*
FREQUENCY RANGE	28 Hz - 1 kHz (-10 dB)	30 Hz - 1 kHz (-10 dB)	30 Hz - 1 kHz (-10 dB)	21 Hz - 300 Hz (-10 dB)	25 Hz - 250 Hz (-10 dB)*
FREQUENCY RESPONSE	35 Hz - 1 kHz (± 3 dB)	38 Hz - 1 kHz (± 3 dB)	40 Hz - 1 kHz (± 3 dB)	25 Hz - 300 Hz (± 3 dB)	30 Hz - 200 Hz (± 3 dB)
TRANSDUCER POWER RATING(AES)	1200 W (4800 W peak) (2 hrs)	2400 W (9600 W peak) (2 hrs)	1000 W (4000 W peak) (2 hrs)	2400 W (9600 W peak) (2 hrs)	1200 W (4800 W peak) (2 hrs)
LONG-TERM SYSTEM POWER RATING	800 W (3200 W peak) 100 hrs	1600 W (6400 W peak) 100 hrs	600 W (2400 W peak) 100 hrs	1600 W (6400 W peak) 100 hrs	800 W (3200 W peak) 100 hrs
MAXIMUM SPL <sup>1</sup>	30 Hz -100 Hz: 129 dB 100 Hz - 500 Hz: 129 dB	30 Hz -100 Hz: 136 dB 100 Hz - 500 Hz: 136 dB	30 Hz -100 Hz: 133 dB 100 Hz - 500 Hz: 133 dB	30 Hz -100 Hz: 134 dB 100 Hz - 500 Hz: 135 dB	30 Hz -140 Hz: 133 dB
SELECTABLE CROSSOVER MODES	Discrete	Parallel Discrete	Parallel Discrete	Parallel Discrete	Discrete
ENCLOSURE SUSPENSION	Rectangular 14 points	Rectangular 12 points	Rectangular 14 points	Rectangular 13 points	Rectangular None
DIMENSIONS (H x W x D)	548 x 561 x 816 mm 21.6 x 22.1 x 32.2 in	1094 x 561 x 816 mm 43.1 x 22.1 x 32.2 in	1094 x 561 x 816 mm 43.1 x 22.1 x 32.2 in	967 x 561 x 1215 mm 38.1 x 22.1 x 47.85 in	564 x 1530 x 1288 mm 22.3 x 56.4 x 50.7 in
NET WEIGHT (each)	44.5 kg (98 lbs)	73.0 kg (161 lbs)	19.5 kg (43 lbs)	89.8 kg (198 lbs)	159.3 kg (351 lbs)

**[ASH]**

\* Designed to be used in multiples (2 minimum, 4 optimum) with proximity placement or with proper boundary surface loading. Specifications shown are for one cabinet.

[INSTALLATION PRODUCTS]

# [KEY FEATURES]

Precision Directivity™

- FSA™ FORWARD STEERED ARRAY ENCLOSURE CONFIGURATIONS
- AVAILABLE SUSPENSION TRUSS COMPONENTS FOR EASY AND COST EFFECTIVE ARRAY BUILDING

# Precision Directivity™

One of the challenges in large arenas, stadiums, houses of worship and performance spaces is to provide quality sound to every seat with the volume and clarity demanded by today's concert, sporting and special events. JBL Professional's new Precision Directivity™ (PD) line of speakers uses a full range, full bandwidth total system approach that allows contractors and consultants to design a fully integrated sound system solving the audio challenges inherent to these types of large installations.

## PD743 (40° x 30°) AND PD764 (60° x 40°)

The PD743 and PD764 mid-high loudspeaker systems provide high-impact sound reinforcement at throw distances that are beyond the reach of traditional single-driver designs. A single module produces greater than 104 dB SPL (continuous) at distances of 65 m (215 ft) with a 40° by 30° coverage pattern (PD743) or a 60° by 40° coverage pattern (PD764). These systems may be used in arrays with other PD Series modules or singly as part of a distributed system.

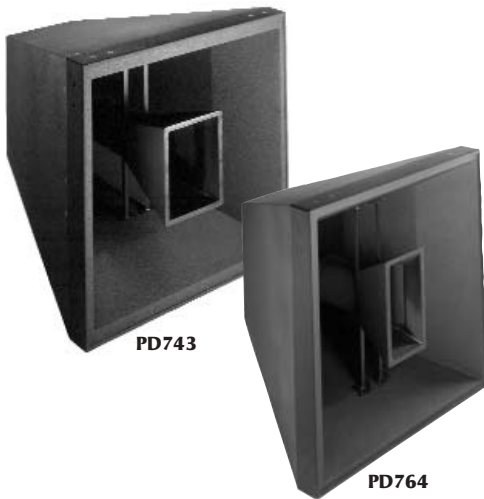

PD743

PD764

## PD100 Low Frequency Modules

PD100 loudspeakers are modules utilized in multiples to create FSA Forward Steered Arrays™, which provide excellent pattern control of low frequencies, ensuring even coverage of the audience area and high off-axis attenuation, which substantially increases sound quality by maximizing the ratio of direct-to-reflected low frequency sound. The PD100 Calculator, available from JBL Professional, helps the system designer decide the model to use, the quantity of cabinets, how to configure them, and the DSP settings to utilize for the required coverage.

## PD125

The PD125 is a high power low frequency module designed for use in arrays and in conjunction with other PD Series systems to construct fullrange systems. Each PD125 module uses two 2226H 15" transducers, mounted "magnets out" for maximum heat transfer, assuring long term reliability at high power levels. Each transducer is mounted in a separate vented subchamber.



PD125

## PD128

The PD128 is a high power subwoofer module designed for use in arrays and in conjunction with other PD Series systems to construct full-range systems.

## PD162

The PD162 mid bass module consists of three models: PD162, PD162L4 and PD162U4. The PD162U4 and PD162L4 are specialized beam-steering modules with four transducers each. PD162 is the standard, fully configured version featuring a full complement of six transducers.



PD162  
PD162L4  
PD162U4

All three models share common enclosure dimensions and features. This allows for construction of compact, simple to rig, densely packed arrays using simple, cost effective truss components.



PD128

# [SPECIFICATIONS]

	PD743	PD764	PD125	PD128	PD162
<b>SYSTEM TYPE</b>	Mid High Loudspeaker Sys.	Mid High Loudspeaker Sys.	LF Array Module	Subwoofer Array Module	Mid Bass Array Module
<b>FREQUENCY RANGE</b>	150 Hz - 17 kHz (-10 dB)	150 Hz - 17 kHz (-10 dB)	38 Hz - 1.7 kHz (-10 dB)	26 Hz - 2.3 kHz (-10 dB)	60 Hz - 1.7 kHz (-10 dB)
<b>FREQUENCY RESPONSE</b>	200 Hz - 15 kHz (± 3 dB)	200 Hz - 15 kHz (± 3 dB)	45 Hz - 900 Hz (± 3 dB)	34 Hz - 1.4 Hz (± 3 dB)	78 Hz - 900 Hz (± 3 dB)
<b>NOMINAL COVERAGE</b>	40° x 30° (H x V)	60° x 40° (H x V)			
<b>SENSITIVITY ( 1 W, 1 m)</b>	MF:111 dB, HF: 118 dB	MF:109 dB, HF: 116 dB	100 dB	99 dB	102 dB
<b>NOMINAL IMPEDANCE</b>	MF:8 ohms, HF: 16 ohms	MF:8 ohms, HF: 16 ohms	4 ohms	4 ohms	3 x 4 ohms
<b>INPUT POWER RATING</b>	MF:700 W, AES; 2800 W peak HF:150 W, AES; 600 W peak	MF:700 W, AES; 2800 W peak HF:150 W, AES; 600 W peak	1200 W, AES; 4800 W peak	1600 W, AES; 6400 W peak	3600 W, AES; 14,400 W peak
<b>TRANSDUCERS:</b>	2 x 2250J (203 mm/8 in) 2 x 2430H (75 mm/3 in)	2 x 2250J (203 mm/8 in) 2 x 2430H (75 mm/3 in)	2 x 2226H (380 mm/15 in)	2 x 2242H (460 mm/18 in)	6 x 2206H (300 mm/12 in)
<b>ENCLOSURE</b>	Dual Trapezoidal 25° V, 35° H	Dual Trapezoidal 35° V, 55° H	Rectangular	Vertically Trapezoidal 30° angle	Rectangular
<b>FINISH</b>	Black DuraFlex	Black DuraFlex	Black DuraFlex	Black DuraFlex	Black DuraFlex
<b>INPUT CONNECTORS</b>	1 x NL4 Neutrik Speakon	1 x NL4 Neutrik Speakon	2 x NL4 Neutrik Speakon	2 x NL4 Neutrik Speakon	2 x NL8 Neutrik Speakon
<b>DIMENSIONS (H x W x D)</b>	991 x 991 x 1146 mm 39 x 39 x 45.1 in	991 x 991 x 883 mm 39 x 39 x 34.75 in	889 x 432 x 724 mm 35 x 17 x 28.5 in	551 x 1676 x 864 mm 21.7 x 66 x 34 in	991 x 622 x 381 mm 39 x 24.5 x 15 in
<b>NET WEIGHT (each)</b>	111.4 kg (245 lbs)	97.7 kg (215 lbs)	57 kg (125.5 lbs)	104.2 kg (229 lbs)	86.1 kg (189.5 lbs)

- ◆ UNSURPASSED JBL ENGINEERING
- ◆ RENOWNED JBL TRANSDUCERS
- ◆ WORLD-CLASS MANUFACTURING

# JBL Custom Shop



**JBL Professional manufacturers the world's most advanced off-the-shelf loudspeaker systems, a very broad selection of standard product lines and models -- from PD Precision Directivity for large venues to Control Contractor's wide range of smaller loudspeakers. And within each product line, a wide assortment of models provides the right selection for virtually any application. The AE Application Engineered Series offers models in a variety of power levels, in white, in two standard levels of weather resistance, in a range of sizes and with a selection of coverage patterns.**

**Despite this broad lineup of models, there may be situations where a project calls for a unique approach. For applications requiring specialized loudspeakers, we offer the services of the JBL Professional Custom Shop.**

**The Custom Shop** designs and builds speakers to meet unique requirements such as multi-angle cabinets for maximizing sight lines in sports facilities, specific-dimension cabinets to fit particular spaces, high transducer density systems to meet very high SPL requirements, compound cabinets to achieve non-standard coverage, loudspeakers that meet distinctive architectural requirements and other unique challenges.

Custom loudspeakers are designed by our very experienced custom engineering team, ensuring unsurpassed performance. All custom speakers are built in a true world-class factory featuring ISO9002 certification, guaranteeing the most rigorous attention to manufacturing excellence. Custom designs incorporate legendary high-performance JBL transducers. You may also consider custom speakers that have already been designed and built for previous jobs.

JBL's CSPELS (Custom Shop Pre-Engineered Loudspeaker Systems) are posted at: [jblpro.com/pages/pre\\_engineered1\\_main.htm](http://jblpro.com/pages/pre_engineered1_main.htm). This list is frequently expanded and updated.

**JBL Professional offers a very broad line of off-the-shelf loudspeakers. However, when you need a specialized speaker that does not appear in this catalog, the JBL Professional Custom Shop provides solutions incorporating unparalleled technology, quality, experience, and manufacturing excellence.**

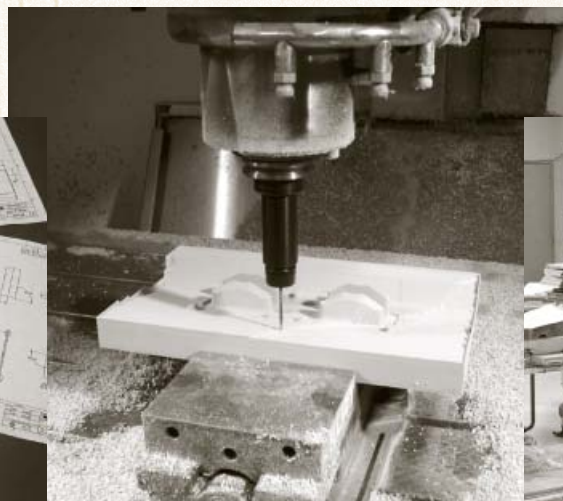
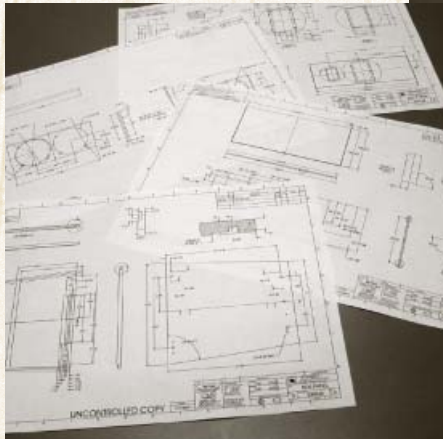

# TOUR SOUND PRODUCTS

[TOUR SOUND PRODUCTS]

Perhaps more than any other single company in the professional sound industry, JBL Professional, under the the guiding wisdom of founder James B. Lansing, has shaped large scale forms of public entertainment we now take for granted. Through Mr. Lansing's development of revolutionary transducers and the resulting sound reinforcement technologies, concerts and special events of all types can now enjoy exceptional sound quality.

JBL has continued this tradition of revolutionary technology with the introduction of VERTEC™ – a flexible, high performance product line with compact, midsize and full-size line array elements and companion subwoofers. It's the ideal solution to a broad range of sound reinforcement challenges for both portable rental inventories, and fixed performance-venues.

2002 Academy Awards Ceremony; Kodak Theatre, Los Angeles  
(Left/center/right temporary array design using VT4889 full-size line array elements)  
Sound system provider: ATK/Audiotek, Inc.

# VERTEC™ Series

JBL's early research into column-type line arrays over 25 years ago provides a solid foundation to VERTEC – Line arrays with lineage. Combining JBL's latest generation of high-powered lightweight transducers with proven line array theory, precisely-adjustable array elements and an accurate predictive software application, this industry-leading product line enables tour sound system operators, rental companies and performance venues to achieve predictable, consistent results. And for maximum flexibility, models VT4881, VT4888 and VT4887 are "Power-Ready": pre-engineered to accept upcoming optional self-powered amplifier modules with integral signal processing.



## VT4889

The **VT4889** is a rugged, lightweight enclosure housing two 15" woofers, four 8" midrange radiators, and three high frequency compression drivers. These advanced components provide the highest power-to-weight ratio of any speaker in the full-size line array element category.

## VT4888

The **VT4888** is a rugged, lightweight line array element housing two 12" woofers, four 5½" midrange radiators, and two high frequency compression drivers. It is designed for use in stand-alone arrays or in combination with other VERTEC system products.

## VT4887

The **VT4887** is a compact, lightweight line array element housing two 8" woofers, four 4" midrange radiators, and two high frequency compression drivers. Offering high output for its size, it can be used in stand-alone arrays or in combination with other VERTEC system products.

## VT4881

The **VT4881** is a compact, lightweight, vented subwoofer enclosure housing a dual voice coil 15" woofer. This advanced component has a compliance capable of a 3" (76 mm) peak-to-peak cone excursion for true very low frequency performance to 18 Hz.

## VT4880

The **VT4880** is a rugged, lightweight centrally vented subwoofer enclosure housing two 18" woofers. These advanced components, each fitted with dual voice coils, provide high output capabilities for an arrayable enclosure fully compatible with VT4889 suspension hardware.



## [SPECIFICATIONS]

	VT4889	VT4888	VT4887	VT4881	VT4880
<b>SYSTEM TYPE</b>	Three-way	Midsized Three-way	Compact Bi-amped Three-way	Compact 15" Subwoofer	Arrayable 18" Subwoofer
<b>FREQUENCY RESPONSE</b>	45 Hz - 16 kHz (± 3 dB)	60 Hz - 16 kHz (± 3 dB)	80 Hz - 20 kHz (± 3 dB)	22 Hz - 125 Hz (± 3 dB)	28 Hz - 75 Hz (± 3 dB)
<b>COVERAGE (H) -6 dB</b>	90° nominal	90° nominal	100° nominal		
<b>250 Hz - 16 kHz</b>			(500 Hz - 16 kHz)		
<b>SENSITIVITY: 1 W, 1 m</b>	LF: 99 dB, MF: 102 dB, HF: 116 dB	LF: 98 dB, MF: 102 dB, HF: 114 dB	LF: 97 dB, MF/HF: 101 dB	LF: 90 dB (2.83v/1m)	LF: 98 dB (2.83v/1m)
<b>NOMINAL IMPEDANCE</b>	LF: 2 x 8 ohms, MF: 8 ohms, HF: 16 ohms	LF: 2 x 8 ohms, MF: 8 ohms, HF: 16 ohms	LF: 8 ohms, MF/HF: 8 ohms	LF: 8 ohms (Each coil independently wired)	LF: 2 x 8 ohms
<b>INPUT POWER RATING<sup>1</sup>: LF</b>	2000 W	2000 W	1000 W	1000 W	2000 W
<b>MF</b>	1400 W	600 W	225 W (MF/HF)		
<b>HF</b>	225 W	150 W			
<b>TRANSDUCERS: LF</b>	2 x 2255H (15 in)	2 x 2262H (12 in)	2 x 2168J (8 in)	1 x 2256GP (15 in) (Dual-Coil)	2 x 2258H (18 in)
<b>MF</b>	4 x 2250H (8 in)	4 x 2106H (5½ in)	4 x 2104H (4 in)		
<b>HF</b>	3 x 2435H	3 x 2431H	2 x 2407H		
<b>ENCLOSURE FINISH</b>	Wedge Frustrum DuraFlex	Wedge Frustrum DuraFlex	Wedge Frustrum DuraFlex	Rectangular parallelepiped DuraFlex	Wedge Frustrum DuraFlex
<b>INPUT CONNECTORS</b>	NL8, 2 each	NL8, 2 each	NL8, 2 each	NL8, 2 each	NL4, 2 each
<b>DIMENSIONS (H x W x D)</b>	489 x 1213 x 546 mm 19.25 x 47.75 x 21 in	355 x 991 x 508 mm 14 x 39 x 20 in	279 x 787 x 406 mm 11 x 31 x 16 in	559 x 787 x 686 mm 22 x 31 x 27 in	493 x 1229 x 860 mm 19.42 x 48.38 x 33.85 in
<b>NET WEIGHT (each)</b>	72 kg (159 lbs)	49 kg (108 lbs)	28 kg (62 lbs)	55 kg (120 lbs)	59.9 kg (132 lbs)

<sup>1</sup> AES standard, one decade pink noise with 6 dB crest factor within device's operational band, free air. Standard AES 2 hour rating plus long term 100 hour rating are specified for cone transducers.

- ❶ VT4888 Line Array System
- ❷ VT4881 Subwoofer Line Array
- ❸ VT4887 Line Array System

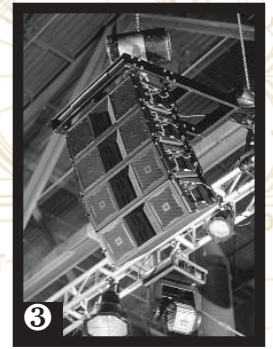
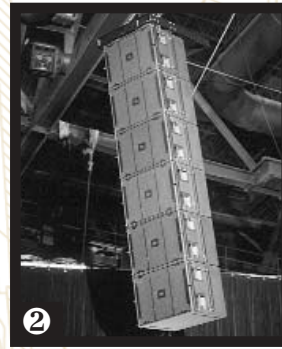

# VERTEC™: Flexible Line Array Solutions

All models in the VERTEC product line are engineered to offer sound reinforcement professionals solutions to meet nearly any challenge. Each model is compatible with others in the line, both mechanically and acoustically. With built-in advantages like lightweight construction, high output, and integral rigging hardware, each VERTEC model is designed to deliver premium-quality audio for a wide range of applications including concert touring, corporate A/V system support, and fixed systems in performance venues.

## HIGH-PERFORMANCE FEATURES

Each model in the VERTEC system family includes a suite of high performance technologies, engineered to work together to maximize utility and audio performance. Newly-developed component transducers offer maximum acoustical performance.

**PlyMax™ enclosure technology** is used for constructing the VT4880, VT4888, VT4887 and VT4881 systems. A wood-based laminated panel material, PlyMax offers rigid enclosure characteristics along with dramatic weight savings. The flagship model VT4889 features an advanced composite shell, providing the highest output power-to-weight ratio of any full-size line array system available in its class.

**Advanced Transducers** give each VERTEC system its performance edge. Like the full-size VT4889 and VT4880 subwoofer, each compact and midsize model features loudspeaker components with neodymium magnets, and dual voice-coil woofers. This combination enables the exceptionally high output characteristics the VERTEC line is legendary for, while ensuring pristine, low-distortion audio reproduction of any type of speech or music.

High frequency output in all models is handled by compact, powerful compression drivers with neodymium magnets. The VT4889 features three 2435 compression drivers (patents pending), each with a 3" beryllium diaphragm and a 1½" throat exit. The midsize VT4888 is fitted with two 2431 compression drivers, also featuring a 1½" throat exit. The compact VT4887 features a pair of very compact model 2407 high frequency drivers with a 1" throat exit.

**Precision waveguides** are coupled to the advanced-technology drivers to create an uninterrupted vertical 'ribbon' of high frequency energy. Located in the center of each axially-symmetrical enclosure, these vertical slot apertures form the heart of VERTEC line array elements.

A **powerful midrange section** in each system is handled by four cone transducers, each capable of providing significant output. The model 2250H 8" unit featured in the flagship VT4889 full-size line array element, arguably the world's most powerful midrange speaker, is fitted with dual voice coils, neodymium magnets and massive heatsinks to deliver performance in this critical region.

**Radiation Boundary Integrators™** in the midrange section of each system serves a dual purpose. The RBI (patents applied for) reduces diffraction effects and smooths high frequency coverage, while ensuring optimum radiation characteristics of the midrange cones.

**Robust low frequency components** are a hallmark of the entire line. All woofers rely on dual voice coil technology for unparalleled output capabilities. The 2255H 15" Differential Drive™ loudspeaker with its neodymium magnet packs more low-end punch than competitive products, while providing solid presence and a rich, full sound that makes subwoofers optional for many applications. The 12" 2262H in the VT4888 and the 8" 2168J are the first examples of JBL's new-generation NDD™ (Neodymium Differential Drive™) component line.

## TOUR-READY SYSTEMS

Each model in the VERTEC line is intended to support the type of rugged use encountered when professional-quality loudspeaker systems are transported from venue to venue, supplying audio support services for a broad range of musical programs and special events. Care has been given to system design ergonomics, making VERTEC arrays among the simplest and fastest to setup and takedown.

All enclosures feature JBL Professional's rugged DuraFlex™ exterior finish. Each system features loudspeaker components with weather-resistant cone treatment. Metalwork is protected, with zinc pre-plating used on steel suspension parts. Important coupling and connective parts are premium-grade, including cadmium-plated center hinge pins and stainless steel where necessary.

## SUSPENSION HARDWARE

All models in the VERTEC line are fitted with integral end-mounted rigging frames. These load-rated, heat-treated, premium-grade tubular frames couple together using quick-release pins and hinge bars to create arrays that are rigid for maximum strength, yet flexible in design and application.

Each trapezoidal speaker enclosure, regardless of model, relies on hinge bars of two types: short units for front-of-box use and longer units for back-of-box use. Angles between adjacent enclosures are set in a range from zero to ten degrees using precision-located holes to accept the pins, which are secured with stainless steel restraining lanyards. Refer to individual product specification sheets for load ratings and individual system capabilities, which vary by model.

## ARRAY FRAME OPTIONS

The VERTEC suspension system includes several frame options for hanging arrays of various sizes. "AF" (Array Frames) and "SF" (Short Frames) are available in each size for use with compact, midsize and full-size line array elements. Crafted of 6061 T-6 heat-treated aluminum, each Array Frame can be used for array suspension from one or two hanging points as specified. The Short Frames can also be used as an 'anchor' array at the bottom of large arrays, if a separate pickup point is required to suspend or tilt the array at a radical angle. These frames are also suitable for ground-stacking up to 6 enclosures (AF models) or 4 enclosures (SF models).

## LINE ARRAY CALCULATOR SOFTWARE

Available to system owners on Part # CD VTUSER-1202, this MSExcel file provides a wealth of technical information about VERTEC line array system designs and their performance expectations in various audience seating areas.

**VERTEC SYSTEM FEATURES**



**PRECISION WAVEGUIDES**

**RBI™: RADIATION BOUNDARY INTEGRATOR**

**INPUT PANEL WITH PARALLEL CONNECTORS**

**VT4889 SYSTEM COMPONENTS**



**2255H 15" DIFFERENTIAL DRIVE LOUDSPEAKER**

**2250H 8" MIDRANGE CONE TRANSDUCER**

**2435H HIGH PERFORMANCE COMPRESSION DRIVER**

**These accessories ship with the VT4889 and are also available as replacement items.**

- VT4889-DOLLY Dolly; doubles as protective front cover 11.4 kg, 25 lbs
- VT4889-COVER Ballistic nylon and aluminum-reinforced 3.6 kg, 8 lbs
- VT4889-RIG Set of (4) Hinge bars, includes (2) long/rear (set of four) and (2) short/front, including slider knobs for each short (front) hinge bar. 4.2 kg, 9.3 lbs

**These accessories are also available for the VT4889 and VT4880.**

- VT4889-MSP (Mechanical Spares Kit, hardware parts). Order 1 for each 12 VT4889s used in portable/tour conditions.
- VT4889-ASP (Acoustical Spares Kit, transducers). Order 1 for each 12 VT4889s used in portable/tour conditions.
- VT4880-ACC Accessory Kit for subwoofer, with wheelboard/dolly plate, cover bag, hinge bars.
- VT4889-AF Array Frame for supporting up to 16 VT4889 enclosures or for ground stacking up to six VT4889 enclosures.
- VT4889-SF Short Frame for use on the bottom of larger VT4889 arrays, suspending special purpose arrays, or for ground stacking up to four VT4889 enclosures.

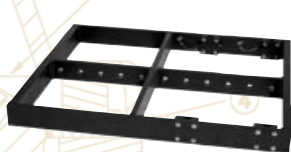

**VT4889-AF (Array Frame)**



**VT4889-SF (Short Frame)**

**Necessary accessories; must order separately for VT4888, VT4887, VT4881.**

- VT4888-ACC Dolly/wheelboard front plate and padded protective cover bag for one VT4888
- VT4887-ACC Dolly/wheelboard front plate and padded protective cover bag for one VT4887
- VT4881-ACC Dolly/wheelboard front plate and padded protective cover bag for one VT4881

- **ADVANCED TECHNOLOGY COMPONENTS**
- **INDUSTRY'S SMALLEST, LIGHTEST, MOST POWERFUL HIGH FREQUENCY COMPRESSION DRIVERS**
- **PRECISION WAVEGUIDES COUPLE TO CREATE HF VERTICAL SLOT APERTURE**
- **RADIATION BOUNDARY INTEGRATOR TECHNOLOGY INTEGRATES OUTPUT OF INDIVIDUAL BANDPASS ELEMENTS**
- **EXCEPTIONALLY RIGID, LIGHTWEIGHT ENCLOSURE CONSTRUCTION**
- **RUGGED DURAFLEX™ EXTERIOR FINISH AND WEATHERIZED COMPONENTS**
- **INTEGRATED S.A.F.E.™ SUSPENSION SYSTEM**

**VERTEC line array elements are available with dolly wheelboards that double as a protective front plate, and reinforced, padded cover bags for maximum protection during handling and transport. Shown here on end, a VT4888 line array element with dolly and cover.**



**Available accessories to support models VT4888, VT4887, VT4881**

- VT4888-MSP (Mechanical Spares Kit, hardware parts). Order 1 for each 12 VT4888s used in portable/tour conditions.
- VT4888-ASP (Acoustical Spares Kit, transducers). Order 1 for each 12 VT4888s used in portable/tour conditions.
- VT4887-MSP (Mechanical Spares Kit, hardware parts). Order 1 for each 12 VT4887s used in portable/tour conditions.
- VT4887-ASP (Acoustical Spares Kit, transducers). Order 1 for each 12 VT4887s used in portable/tour conditions.
- VT4888-AF Array Frame for supporting up to 16 VT4888 enclosures or for ground stacking up to six enclosures.
- VT4888-SF Short Frame for use on bottom of larger VT4888 arrays, suspending special purpose arrays, or for ground stacking up to four enclosures.
- VT4887-AF Array Frame for supporting up to 16 VT4887 enclosures or 12 VT4881 subwoofers for ground stacking up to six enclosures.
- VT4887-SF Short Frame for use on bottom of larger VT4887 arrays, suspending special purpose arrays, or for ground stacking up to four enclosures.
- VT4800-CA Compact Adaptor, use to suspend VT4888s or VT4881s from VT4888s
- VT4800-DA Downfill Adaptor, use to suspend up to 4 VT4887s from VT4889s or VT4880s
- VT4800-UA Universal Adaptor Frame. Use to suspend midsize or compact models from either the VT4889 full-size arrays or VT4880 subwoofer arrays.

# Array™ Series

JBL's commitment to provide audio professionals the best tools for their work is evident with the Array Series. These systems provide the ultimate performance for compact touring and fixed installation systems. The Array Series systems combine ease of transport with the flexibility to fly or install quickly and safely. Integration of advanced design high power transducers, precision-coverage horns and digital control electronics provide clearly superior performance. "A" version enclosures are now finished with DuraFlex™.

**ARRAY™ SERIES**

**4890A**



This two-way stage monitor has a horizontal format for minimal height to allow unobtrusive presence on stage. 45° cabinet angles and a 60° x 40° horn that rotates provide optimum coverage for any monitoring application. Linear power response, even at high output levels, satisfies the most demanding users.

**4892A & 4892A-90**

These compact packages exhibit outstanding full-range output and are capable of very high sound pressure levels. Both deliver impressive performance, the **4892A** as a dedicated array component and the **4892A-90** for single system applications. A 35 mm (1 3/8 in) pole mount adapter is standard.

**ARRAY™ SERIES**

**4894A & 4894A-90**



In situations where greater low-frequency energy is required, the **4894A** and **4894A-90** deliver. They are the ideal system choice for both indoor and outdoor venue applications where maximum sound pressure level is required without compromising fidelity. The 4894A can be used as an array element and for side fill applications. The 4894A-90 provides wider coverage from a single enclosure.

**4893A**

The **4893A** delivers sub-bass support for the Array Series full-range systems. Its compact, solidly constructed enclosure houses two advanced VGC™ low-frequency transducers for tight, solid and dynamic bass. The 4892A, 4893A and 4894A can be arrayed together, making it possible to custom tailor clusters for virtually any desired coverage.

**S.A.F.E. FLYING HARDWARE**

An important aspect of the Array Series is the ability to assemble loudspeaker clusters quickly and safely. **S.A.F.E.** suspension hardware is designed, engineered and certified to meet and exceed the most stringent safety requirements for sound system rigging, worldwide. A complete line of hardware is available to allow array construction for applications.

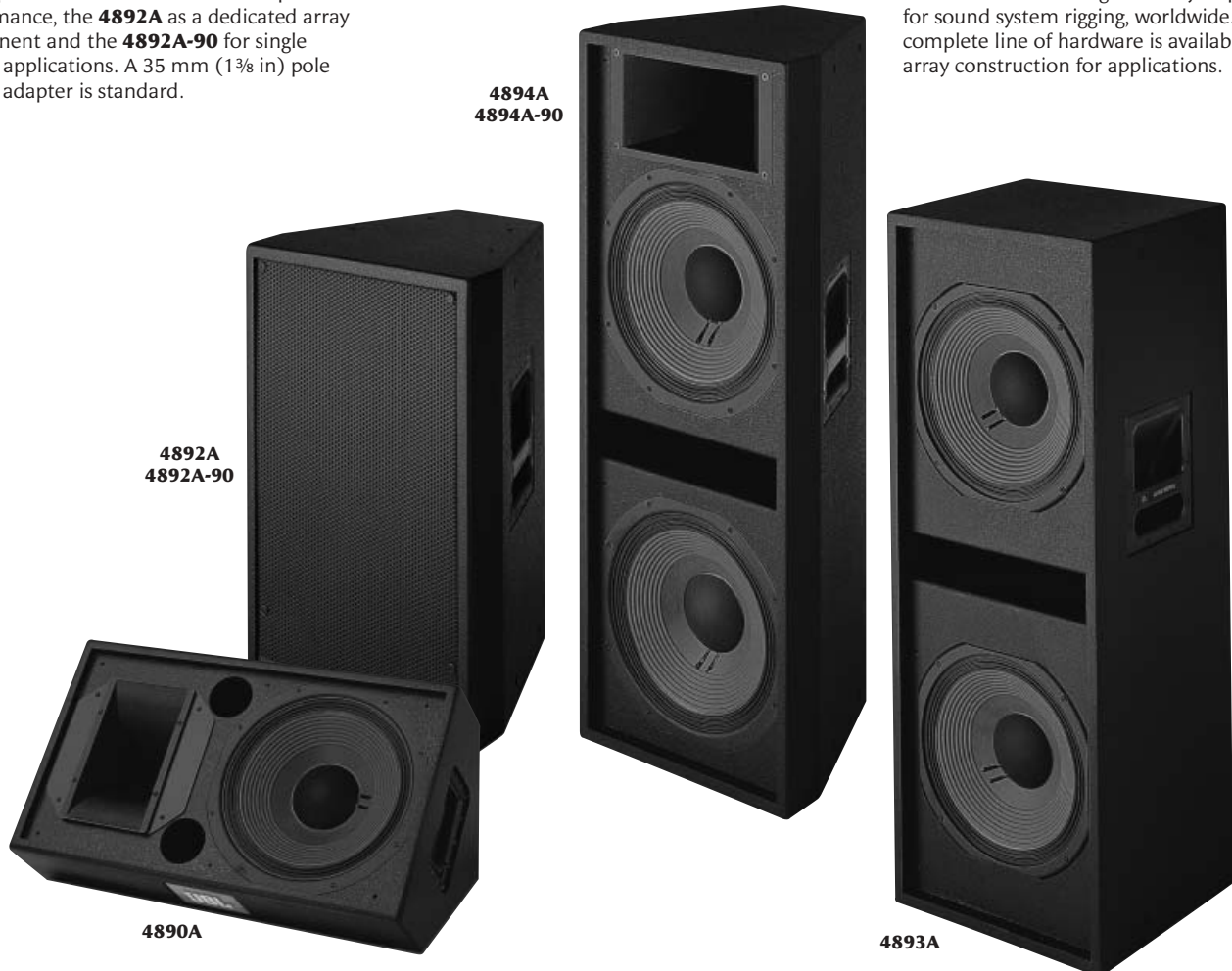

**4892A  
4892A-90**

**4894A  
4894A-90**

**4890A**

**4893A**



- COMPACT, MODULAR, INTEGRATED PRODUCT LINE
- HIGH TECHNOLOGY TRANSDUCERS
- OPTIMIZED ARRAY-MODULE DESIGN
- SECURE ARRAY FLYING ERGONOMICS - S.A.F.E.™
- DURABLE & VERSATILE CONSTRUCTION



S.A.F.E. FLYING HARDWARE



[SPECIFICATIONS]

	4890A	4892A & 4892A-90	4894A & 4894A-90	4893A
<b>SYSTEM TYPE</b>	Two-way Stage Monitor	Two-way Speaker System	Two-way Speaker System	Subwoofer System
<b>FREQUENCY RESPONSE</b>	70 Hz - 18 kHz (± 3 dB)	50 Hz - 18 kHz (± 3 dB)	46 Hz - 18 kHz (± 3 dB)	38 Hz - 400 Hz (± 3 dB)
<b>SENSITIVITY: 1 W, 1 m</b>	98 dB	98 dB	100 dB	98 dB
<b>MAXIMUM SPL @ 1 m</b>	132 dB	132 dB	137 dB	135 dB
<b>NOMINAL COVERAGE</b>	60° x 40° or 40° x 60°	45° x 35° (4892A) 90° x 40° (4892A-90)	45° x 35° (4894A) 90° x 40° (4894A-90)	Array dependent
<b>NOMINAL IMPEDANCE</b>	8 ohms	8 ohms	8 ohms	8 ohms each
<b>POWER CAPACITY (AES)</b>	600 Watts	600 Watts	1200 Watts	1200 Watts
<b>TRANSDUCERS: LF</b>	1400 PRO (355 mm/14 in)	1400 PRO (355 mm/14 in)	2 x 1400 PRO (355 mm/14 in)	2 x 2214H (355 mm/14 in)
<b>HF</b>	2450SL (38 mm/1 1/2 in)	2450SL (38 mm/1 1/2 in)	2450SL (38 mm/1 1/2 in)	
<b>HF HORN</b>	Optimized Aperture Flat-Front Bi-Radial®	Optimized Aperture Flat-Front Bi-Radial	Optimized Aperture Flat-Front Bi-Radial	
<b>ENCLOSURE</b>	45° cabinet angle 13 ply hardwood	Trapezoidal, 45° 13 ply hardwood	Trapezoidal, 45° 13 ply hardwood	Rectangular 13 ply hardwood
<b>FINISH</b>	Black textured DuraFlex™	Black textured DuraFlex	Black textured DuraFlex	Black textured DuraFlex
<b>GRILLE</b>	16 ga. perforated steel, foam backed	16 ga. perforated steel, foam backed	16 ga. perforated steel, foam backed	16 ga. perforated steel, foam backed
<b>INPUT CONNECTORS</b>	NL8, 2 each	NL8, 2 each	NL8, 2 each	NL8, 2 each
<b>DIMENSIONS (H x W x D)</b>	376 x 686 x 376 mm 14.8 x 27 x 14.8 in	628 x 394 x 362 mm 24.75 x 15.5 x 14.25 in	1066 x 394 x 362 mm 42 x 15.5 x 14.25 in	1066 x 394 x 362 mm 42 x 15.5 x 14.25 in
<b>NET WEIGHT (each)</b>	34 kg (75 lbs)	34 kg (75 lbs)	47.3 kg (104 lbs)	45.5 kg (100 lbs)

**SoundFactor. MPro Series.  
EON®. EON G2 Series.  
SR-X Series.**

An unbeatable line-up of portable sound reinforcement products from JBL Professional. Years of experience went into making these products. They're loaded with features brought over from JBL's high-end concert touring and live performance systems— features you won't find anywhere else.

MPro includes the first mid-priced subwoofers to offer VGC™ technology, the first speaker systems offering JBL's Laminar Flow Baffle™ technology and the first speaker system with built in Crown® power.

The JBL EON system is firmly entrenched as the industry leader in powered portable speaker systems. The EON G2 Series is the second generation of this most successful and influential professional speaker system. JBL Pro is making a great product even better with these new features: Expanded on-board mixing capability, more power, better sound and more resilient materials.

The SR-X Series features eighteen different configurations. It's the state-of-the-art in portable sound reinforcement loudspeakers. With all the choices and high performance, you can configure a loudspeaker system that is perfect for the most demanding portable sound reinforcement applications.

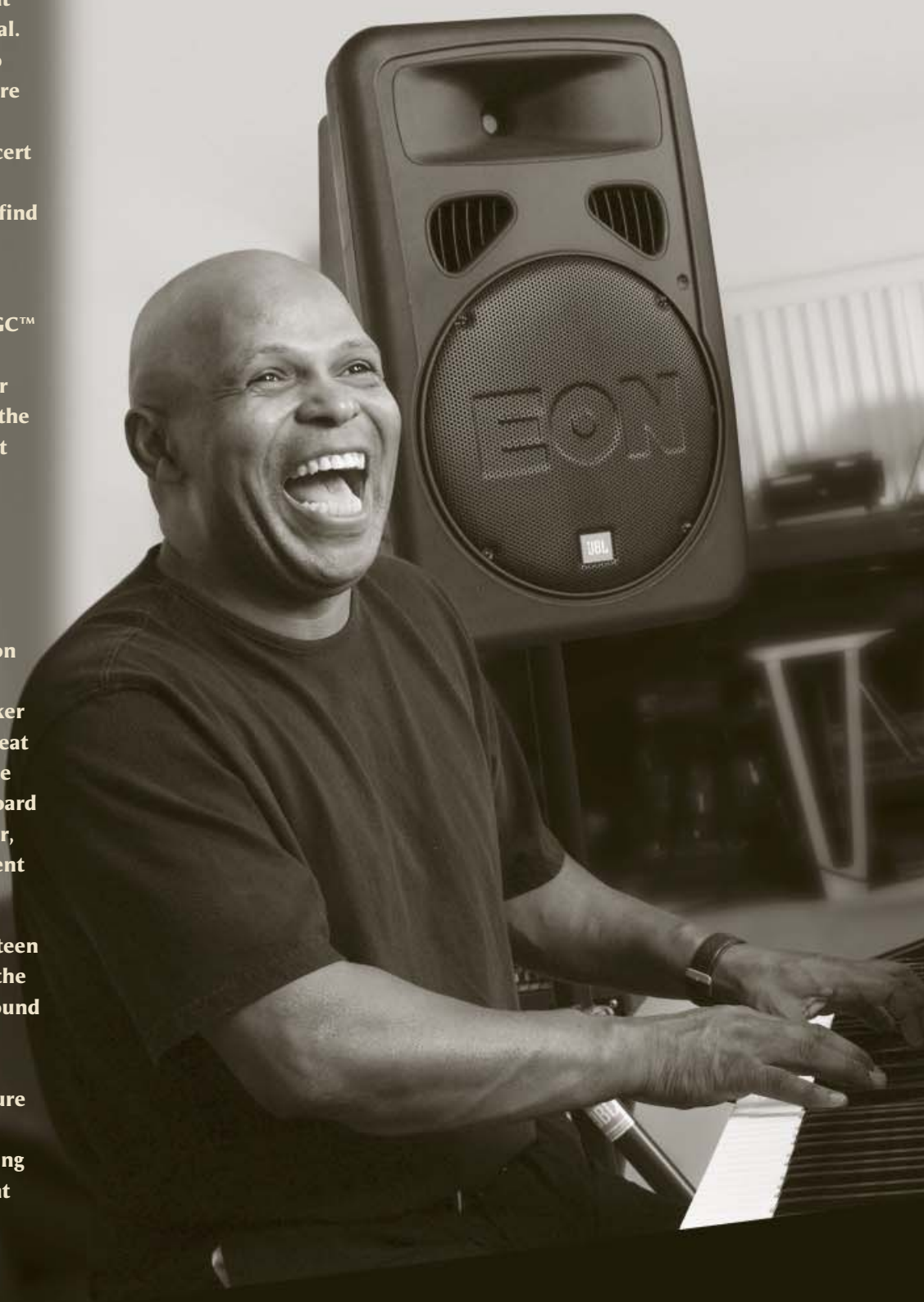

- SONICGUARD™ PROTECTION CIRCUITRY
- PROGRESSIVE TRANSITION™ WAVEGUIDE
- NEUTRIK® SPEAKON® and 1/4" CONNECTORS
- AFFORDABLE PRICEPOINT

# SoundFactor™

Accessibility and empowerment—that's what SoundFactor brings to the party. Accessibility, because SoundFactor delivers the performance and prestige JBL is known for, but now, at an affordable price point. Empowerment comes from performing with speakers designed and built by JBL, the world's leading supplier of professional sound reinforcement products.

To meet these conflicting design goals, we looked at every element of the speaker system design. We kept everything that makes a speaker perform and sound its best and we eliminated things that don't. With performance, value and popular price points, we are going to be building a lot of SoundFactor speakers. This means we can apply efficient, high-volume production methods and purchase materials at the lowest cost. That's how SoundFactor delivers unprecedented value.

## SF12M

The **SF12M** is designed to be compact and low-profile so it won't take up too much stage space or block audience sight-lines. With its high-sensitivity (99 dB SPL), it will crank out plenty of sound even with a moderately powerful amplifier. For compatibility, it's equipped with Neutrik® Speakon® and 1/4" input connectors. Continuous power capacity is 250 watts and Peak power capacity is 1000 watts.

## SF15

The **SF15** is a trapezoidal, 15" speaker system at home in live sound, dance music, and speech reinforcement. The SF15 is equipped with low and high-frequency drivers built in our Northridge, California factory. Features include a cast metal 35 mm pole mount socket as well as Neutrik Speakon and 1/4" input connectors. Continuous power capacity is 250 watts and Peak power capacity is 1000 watts.

## SF25

When the application calls for extra power and low-end combined with the simplicity of a single-box system, the **SF25** is the choice. For compatibility, it's equipped with Neutrik Speakon and 1/4" input connectors. Continuous power capacity is 500 watts and Peak power capacity is 2000 watts.

## SF22SP

With 500 watts peak power and a unique dual 12" band-pass design, the **SF22SP** is ready to add low-frequency power and performance to your system. The SF22SP features a range of input options that let you easily use it with any existing mid/high speaker system—powered or non-powered. Onboard crossovers and a limiter provide all the signal processing needed to deliver optimum performance. For additional convenience, four detachable casters and a 35 mm steel pole for the satellite speakers are included.

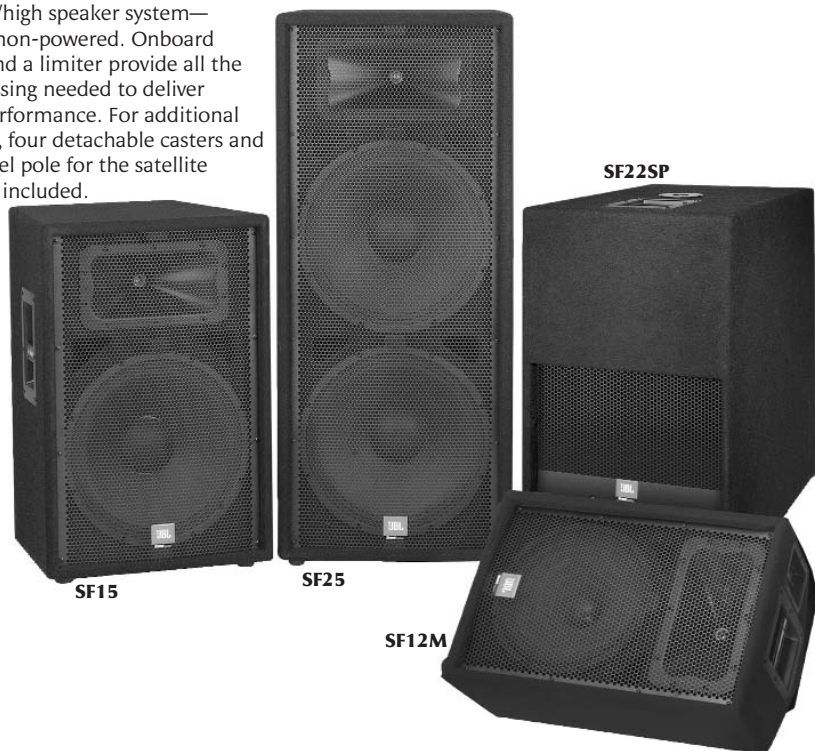

## [SPECIFICATIONS]

	SF12M	SF15	SF25	SF22SP
SYSTEM TYPE	12" Two-way Stage Monitor	15" Two-way Speaker System	Dual 15" Two-way Speaker System	Powered Dual 12" Subwoofer
FREQUENCY RANGE <sup>1</sup>	60 Hz - 16 kHz (-10 dB)	38 Hz - 16 kHz (-10 dB)	35 Hz - 16 kHz (-10 dB)	33 Hz - 125 Hz (-10 dB)
POWER CAPACITY <sup>2</sup>	1000 W (peak) 250 W (continuous)	1000 W (peak) 250 W (continuous)	2000 W (peak) 500 W (continuous)	Amplifier: 500 W (peak) 300 W < 0.2% THD (continuous)
NOMINAL IMPEDANCE	8 ohms	8 ohms	4 ohms	
SENSITIVITY: 1 W, 1 m	99 dB	98 dB	100 dB	
NOMINAL DISPERSION	90° H x 50° V	90° H x 50° V	90° H x 50° V	
TRANSDUCERS: LF HF	1 x M112-8 1 x 2412	1 x M115-8A 1 x 2412	2 x M115-8A 1 x 2412	2 x M212-8
DIMENSIONS (H x W x D)	584.2 x 393.7 x 317.5 mm 23.0 x 15.5 x 12.5 in	698.5 x 459.9 x 431.8 mm 27.5 x 18.11 x 17 in	1092.2 x 463.6 x 431.8 mm 43.0 x 18.25 x 17 in	810.3 x 463.6 x 850.1 mm 31.9 x 18.3 x 33.47 in
NET WEIGHT (each)	19.5 kg (43.0 lbs)	27.4 kg (60.5 lbs)	42.6 kg (94.0 lbs)	57.1 kg (126 lbs) (including casters)

<sup>1</sup> "Frequency Range" is based on half-space response.

<sup>2</sup> "Power Capacity" and "Peak Power Capacity" ratings are based on the average and peak power handling capacity of product samples subjected to a 100 hour power test of the system design using IEC filtered random noise with a crest factor of 6 dB.

# MPro Series



The MPro Series features the MP418SP; a compact, easy-to-use, powered subwoofer system—the first product with built-in Crown® Power.

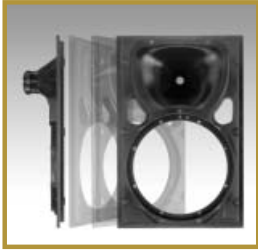

The MPro Line offers a unique, professional appearance, superb acoustical performance, cutting edge configurations and the buyer confidence that goes with the JBL brand.

MPro includes the first mid-priced subwoofers to offer VGC™ (Vented Gap Cooling) technology and the first speaker systems offering JBL's Laminar Flow Baffle™ technology. The JBL Laminar Flow Baffle incorporates smooth, contoured surfaces that greatly reduce distortion caused by turbulence and diffraction. Constructed of Sheet Molding Compound (a super tough, cross-linked, polymer also used for automotive body panels), this one-piece baffle integrates horn, ports and woofer-mounting into a single part. This permits features to be tightly spaced, allowing a large horn-mouth (for improved mid-range and directivity performance) without making the cabinet too large.

**The MPro 200 Series** features premium-grade carpet covered 18 mm plywood enclosures. The edges of the premium grade carpet are captured by the joint detail to prevent visible seams or peeling. The large-mouth horn design of the MP212, MP215 and MP225 delivers smooth, natural reproduction — especially in the critical mid-range. A 16 gauge, steel grille protects the JBL woofers.

## MP212

**The MP212** is a compact, portable, twelve-inch, two-way speaker system in a multi-angle enclosure that's equally at home in main PA or stage monitor applications. Designed for portable applications in live performance, music playback, and reinforcement of speech, the MP212 will deliver excellent performance by itself or as a satellite over the MP255S subwoofer.

## MP215

**The MP215** is a portable, fifteen-inch, two-way speaker system designed for live performance, music playback and speech reinforcement.

## MP225

**The MP225** is a portable, dual fifteen-inch, two-way speaker system designed for applications in live performance, music playback, and reinforcement of speech. The crossover network employs separate low-pass filters for each woofer. The lower woofer is rolled off at a lower frequency than is the upper woofer. This reduces mid-range phase anomalies while retaining the strong low-frequency performance that is the primary appeal of the dual 15" configuration.

## MP255S

**The MP255S** is among the most affordable subwoofers in its class. With a bandpass design, the MP255S uses two tuned chambers to shift its energy down into the low-frequency region. It also has a low-pass filter to get rid of the remaining mid-range output. Includes a 24", 35 mm pole for use with satellite speakers.

**The MPro 400 Series** features JBL's DuraFlex™ coated enclosures and a unique new powered product—the first speaker system with built in Crown power. The MP412 and MP415 feature the unique, ARD™ (Annular Ring Diaphragm) compression driver delivering extraordinary high-frequency extension.

## MP410

**The MP410** is a compact, portable, ten-inch, two-way speaker system using JBL components in a professional quality enclosure that looks and sounds like the high-end, specialty speaker systems top audio pros rely on. The MP410 is priced to be affordable to working music professionals. It has the convenience of a compact speaker system combined with uncompromised audio quality.

## MP412

**The MP412** is a compact, portable, twelve-inch, two-way speaker system in a multi-angle enclosure that supports main PA or stage monitor applications. The high-frequency performance makes the MP412 an outstanding choice for high-level music playback, especially when combined with subwoofers. Designed for portable applications in live performance, music playback, and reinforcement of speech, the MP412 will deliver excellent performance by itself or as a satellite over subwoofers such as the MP418S and MP418SP.

## MP415

**The MP415** is a portable, fifteen-inch, two-way speaker system in a multi-angle enclosure that supports main PA or stage monitor applications. The high-frequency performance makes the MP415 an outstanding choice for high-level music playback, especially when combined with subwoofers. Designed for portable applications in live performance, music playback, and reinforcement of speech, the MP415 will deliver outstanding performance by itself or as a satellite over subwoofers such as the MP418S and MP418SP.

## MP418S

**The MP418S** is a compact, single eighteen-inch subwoofer in a bass reflex enclosure designed to supplement and extend the low-frequency output of full-range systems in a variety of portable and permanent applications. Achieving the power and performance characteristics of the MP418S while maintaining an extremely compact enclosure size requires the use of a woofer with very high motor strength — the JBL 2241.

This woofer uses VGC™ (Vented Gap Cooling), an exclusive JBL technology that greatly reduces the loss of output resulting from power compression. The MP418S is the most affordable subwoofer ever offering this proven transducer technology.

Subwoofer plus satellite systems (systems in which a smaller, two-way speaker is mounted over a subwoofer) have grown in popularity. To support such applications, the MP418S includes a specially designed, top-mounted, 35 mm pole mount receptacle. Optional SS3-BK pole is available separately.

The MP418S may also be used as a "slave" to the powered MP418SP. When used in this manner, the result is a dual eighteen-inch, powered subwoofer system with 1,320 watts total power.

## MP418SP

**The MP418SP** is a compact, powered, single eighteen-inch, bass-reflex subwoofer system with the perfect formula for great sound—just power the best speakers with the best amplifiers. The MP418SP represents a collaboration between JBL and Crown Audio that does just that. The dual channel internal amplifier is rated at 660 watts @ 4 ohms; 400 watts @ 8 ohms with 0.5% or less true THD. One channel is dedicated to the internal 18" woofer. The other can drive your choice of an MP418S passive sub or MPro two-way satellite.

The MP418SP uses the same driver and enclosure tuning as the non-powered MP418S. It is designed for portable applications and includes heavy-duty, 3 inch casters and ergonomically positioned steel carry handles for transport.

**M**PRO  
200 SERIES

- ▶ AFFORDABLE, ADVANCED DESIGNS
- ▶ VGC™ (VENTED GAP COOLING) TECHNOLOGY
- ▶ LAMINAR FLOW BAFFLE™ TECHNOLOGY
- ▶ PREMIUM-GRADE CARPET COVER WITH JOINT DETAIL
- ▶ THE MOST AFFORDABLE SUBWOOFER IN ITS CLASS - MP255S

MPro 400 Series

- ▶ DURAFLEX™-COATED ENCLOSURES
- ▶ ARD™ (ANNULAR RING DIAPHRAGM) COMPRESSION DRIVER
- ▶ THE FIRST PRODUCT WITH BUILT-IN CROWN® POWER - THE MP418SP
- ▶ LAMINAR FLOW BAFFLE TECHNOLOGY



[PORTABLE PRODUCTS]

[SPECIFICATIONS]

	MP212	MP215	MP225	MP255S
SYSTEM TYPE	12" Two-way Bass-reflex	15" Two-way Bass-reflex	Dual 15" Two-way Bass-reflex	Dual 15", Band-pass Subwoofer
FREQUENCY RANGE <sup>1</sup>	50 Hz - 16 kHz (-10 dB)	45 Hz - 16 kHz (-10 dB)	32 Hz - 12.5 kHz (-10 dB)	32 Hz - 180 Hz (-10 dB)
FREQUENCY RESPONSE <sup>1</sup>	64 Hz - 16 kHz (± 3 dB)	50 Hz - 12.5 kHz (± 3 dB)	42 Hz - 11 kHz (± 3 dB)	38 Hz - 160 Hz (± 3 dB)
SENSITIVITY: 1 W, 1 m	99 dB SPL	99 dB SPL	101 dB SPL	102 dB SPL
NOMINAL IMPEDANCE	8 ohms	8 ohms	4 ohms	4 ohms
MAXIMUM SPL @ 1 m <sup>2</sup>	129 dB	129 dB	134 dB	135 dB
POWER CAPACITY <sup>3</sup>	250 W	250 W	500 W	500 W
PEAK POWER CAPACITY <sup>3</sup>	1,000 W	1,000 W	2,000 W	2,000 W
NOMINAL DISPERSION	70° x 70°	70° x 70°	70° x 70°	
TRANSDUCERS: LF	1 x JBL M112-8	1 x JBL M115-8A	2 x JBL M115-8A	2 x JBL M115-8A
HF	1 x JBL 2412H	1 x JBL 2412H	1 x JBL 2412H	
ENCLOSURE	18 mm plywood	18 mm plywood	18 mm plywood	18 mm plywood
FINISH	Gray carpet	Gray carpet	Gray carpet	Gray carpet
INPUT CONNECTORS	1 x Neutrik Speakon® NL-4, ¼" phone jack, parallel	1 x Neutrik Speakon NL-4, ¼" phone jack, parallel	1 x Neutrik Speakon NL-4, ¼" phone jack, parallel	2 x Neutrik Speakon NL-4
DIMENSIONS (H x W x D)	610 x 404 x 348 mm 24.0 x 15.9 x 13.7 in	709.4 x 466.3 x 347.1 mm 28.46 x 18.36 x 13.67 in	1163 x 465 x 513 mm 45.8 x 18.3 x 20.2 in	950.2 x 527.1 x 940.2 mm 37.4 x 20.75 x 37 in
NET WEIGHT (each)	20.2 kg (44.5 lbs)	22.2 kg (49 lbs)	45.1 kg (99.5 lbs)	52.2 kg (115 lbs)

<sup>1</sup> Frequency Range and Response specifications based on half space (2π) performance

<sup>2</sup> Calculated based on Peak Power Capacity and Sensitivity

<sup>3</sup> "Power Capacity" and "Peak Power Capacity" ratings are based on the average and peak power handling capacity of product samples subjected to a 100 hour power test using IEC filtered pink noise with a crest factor of 6 dB

**MP418SP: OPERATION OF DUAL-CHANNEL CROWN® AMPLIFIER**

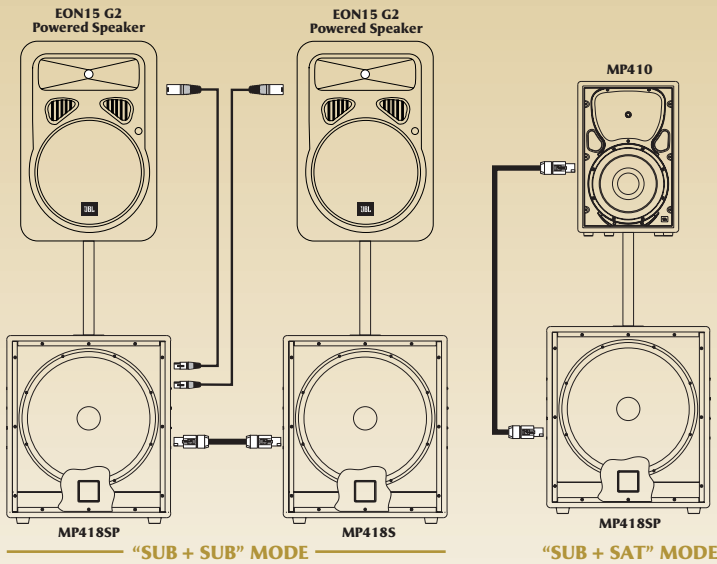

**A dual-channel Crown amplifier is incorporated into the MP418SP.**

While one amplifier channel—the “Internal” channel—is dedicated to powering the internal 18” VGC woofer, the “External” channel may be used in one of two ways:

**In the “Sub + Sub” mode**, the external amplifier channel is used to drive the MP418S (a passive version of the MP418SP). Stereo, high-passed line-outputs are provided to drive powered satellite speakers or an external amplifier/speaker system. **In the “Sub + Sat” mode**, an MP418SP may be used with a full-range, passive speaker for a single channel, two piece system. The external amplifier channel powers the satellite.



[SPECIFICATIONS]

	MP410	MP412	MP415	MP418S	MP418SP
<b>SYSTEM TYPE</b>	10" Two-way Bass-reflex	12" Two-way Bass-reflex	15" Two-way Bass-reflex	18" Bass-reflex Subwoofer	Powered 18" Bass-reflex Subwoofer
<b>FREQUENCY RANGE<sup>1</sup></b>	50 Hz - 20 kHz (-10 dB)	50 Hz - 20 kHz (-10 dB)	44 Hz - 20 kHz (-10 dB)	36 Hz - 300 Hz (-10 dB)	36 Hz - 150 Hz (-10 dB)
<b>FREQUENCY RESPONSE<sup>1</sup></b>	62 Hz - 14 kHz (± 3 dB)	67 Hz - 20 kHz (± 3 dB)	57 Hz - 20 kHz (± 3 dB)	40 Hz - 300 Hz (± 3 dB)	40 Hz - 120 Hz (± 3 dB)
<b>SENSITIVITY: 1 W, 1 m</b>	94 dB SPL	99 dB SPL	99 dB SPL	101 dB SPL	
<b>NOMINAL IMPEDANCE</b>	8 ohms	8 ohms	8 ohms	4 ohms	4 ohms
<b>MAXIMUM SPL @ 1 m<sup>2</sup></b>	125 dB	130 dB	130 dB	135 dB peak	132 dB SPL (peak @ 1 meter)
<b>POWER CAPACITY<sup>3</sup></b>	300 W	350 W	350 W	600 W	
<b>PEAK POWER CAPACITY<sup>3</sup></b>	1,200 W	1,400 W	1,400 W	2,400 W	
<b>NOMINAL DISPERSION</b>	70° x 70°	70° x 70°	70° x 70°		
<b>TRANSDUCERS: LF</b>	1 x JBL 127H-4	1 x JBL 2023H	1 x JBL 2033H	1 x JBL 2241G	1 x JBL 2241G
<b>HF</b>	1 x JBL 2412H	1 x JBL 2406H	1 x JBL 2406H		
<b>ENCLOSURE</b>	18 mm plywood	18 mm plywood	18 mm plywood	18 mm plywood	18 mm plywood
<b>FINISH</b>	DuraFlex™	DuraFlex	DuraFlex	DuraFlex	DuraFlex
<b>INPUT CONNECTORS</b>	2 x Neutrik Speakon® NL-4, parallel	2 x Neutrik Speakon NL-4, parallel	2 x Neutrik Speakon NL-4, parallel	2 x Neutrik Speakon NL-4	2 x XLR/F, ¼" phone (TS) combi connector
<b>DIMENSIONS (H x W x D)</b>	508 x 338.4 x 299.7 mm	605 x 396 x 344 mm	719 x 461 x 383 mm	617.9 x 538.1 x 598.4 mm	617.9 x 538.1 x 776.6 mm
<b>NET WEIGHT (each)</b>	15.4 kg (34 lbs)	21.4 kg (47 lbs)	26.8 kg (59 lbs)	29 kg (64 lbs)	54 kg (119 lbs)

<sup>1</sup> Based on half space (2π) performance

<sup>2</sup> Calculated based on Peak Power Capacity and Sensitivity

<sup>3</sup> "Power Capacity" and "Peak Power Capacity" ratings are based on the average and peak power handling capacity of product samples subjected to a 100 hour power test using IEC filtered pink noise with a crest factor of 6 dB

- PURE TITANIUM DIAPHRAGM COMPRESSION DRIVERS
- THERMOMASTER® TOTAL THERMAL MANAGEMENT SYSTEM®
- PROPRIETARY DIFFERENTIAL DRIVE® LOW FREQUENCY TRANSDUCERS
- ATTACHMENT POINTS FOR FIXED-ANGLE AND ADJUSTABLE MOUNTING BRACKETS
- RUGGED, LIGHT WEIGHT POLYPROPYLENE ENCLOSURE
- INTEGRAL 35 MM POLE MOUNT RECEPTACLE
- ERGONOMICALLY DESIGNED HANDLES

# EON® Series

THE EON® SERIES



The EON System is unlike any other system we've ever created. As a made-to-match system, all EON components are designed to give you hassle-free, professional sound quality and performance.

EON is the first professional sound system made to be truly portable. The secret behind EON's feather weight is a rare earth material called neodymium with 10 times the magnetic strength of ceramic magnets, enabling a few ounces of neodymium to replace nearly 20 pounds of conventional magnetic materials.

For flexibility, the EON speakers are built to work as both upright speakers and wedge monitors. With ergonomic handles and light weight, they're remarkably easy to carry. Simple to set up. And a pleasure to use.

### EON 15P-1

The EON 15P-1 is a two-way powered speaker system which incorporates a discrete 130 watt power amplifier for low frequencies and a 50 watt power amplifier for the high frequency driver in a light weight rugged enclosure. Designed for multi-purpose usage, the EON 15P-1 may be driven from a mixer or single microphone.

### EON 1500

The EON 1500 features the same combination of light weight, portability and great sound as the other EON speakers, but is designed for use with a powered mixer or external amplifier. EON 1500 features proven JBL components like our liquid cooled compression driver and SonicGuard™ protection. EON 1500's unique design allows you to use them as a main speaker, tripod mounted or a floor monitor. The EON 1500 accepts a ¼" phone jack or Speak-On input connection wired in parallel for ease of hookups.

EON speakers feature a die cast aluminum baffle for superior heat dissipation and component integration



EON 15P-1



EON 1500

## [SPECIFICATIONS]

	EON 15P-1	EON 1500
SYSTEM TYPE	Powered Two-way System	Two-way Speaker System
FREQUENCY RANGE	47 Hz - 18 kHz (-10 dB)	55 Hz - 16 kHz (-10 dB)
FREQUENCY RESPONSE	60 Hz - 17 kHz (-6 dB)	70 Hz - 16 kHz (-6 dB)
MAXIMUM SPL @ 1 m	127 dB, 1 m	128 dB, 1 m
POWER CAPACITY	50/130 W (Internal)	225 W
NOMINAL IMPEDANCE	(Internally bi-amped)	8 ohms
SENSITIVITY: 1 W, 1 m	(Internally bi-amped)	98 dB SPL
TRANSDUCERS: LF	380 mm (15 in)	380 mm (15 in)
HF	44 mm (1¾ in)	44 mm (1¾ in)
DISPERSION ANGLE	90° H x 60° V	90° H x 60° V
POWER AMP: LF	130 W, 0.1% THD	N/A
HF	50 W, 0.1% THD	N/A
DIMENSIONS (H x W x D)	686 x 430 x 444 mm	686 x 430 x 444 mm
NET WEIGHT (each)	21 kg (47 lbs)	17.24 kg (38 lbs)



# EON<sup>®</sup> G2 Series

With more than 300,000 systems already being used in applications from live sound reinforcement, speech and vocals to music playback in entertainment, A/V and institutional environments, the JBL EON system is firmly entrenched as the industry leader in powered portable speaker systems. The EON G2 Series is the second generation of this most successful and influential professional speaker system. JBL Pro is making a great product even better. Look for these new features: Expanded on-board mixing capability • More power • Better sound • More resilient materials

Suspension kits are available for EON 10 and EON 15 speakers.

## EON10 G2

The EON10 G2 compact powered speaker features a 10" woofer, increased power and a three channel mini-mixer. The EON10 G2 is ideal for AV applications, smaller musical and spoken word performances and, when combined with the EONSUB G2 powered subwoofer, provides a full range sound system for small and medium sized events.

The first generation EON10 was very popular, not only with musicians, but with hotels, meeting planners, AV companies and just about any application where portable compact sound reinforcement was needed. Its successor, EON10 G2 offers more power, more flexibility and a refined appearance that will make it even more appropriate for its many types of users.

The EON10 G2 has 125 watts for low frequencies and 50 watts for the highs. The 10" Differential Drive<sup>®</sup> low-frequency driver uses a neodymium magnet for light weight and reduced distortion. The one-inch JBL 2412 compression driver for the high frequencies includes a titanium diaphragm and ferro-fluid cooling.

With its versatile cabinet design, the EON10 G2 can be used in several different ways. As a front of house speaker, the EON10 G2 can sit on a flat horizontal surface or be raised in the air using standard tripod speaker stands. In addition, the angled back of the speaker allows its use as a vocal or instrument monitor on stage.

## EON15 G2

The EON15 G2 is the flagship of the series, delivering 300 watts of power to a 15" Neodymium Differential Drive LF driver. The driver boasts a dual neodymium magnet and dual voice coil motor that efficiently delivers high output from a lightweight woofer. Meanwhile, the HF amplifier delivers 100 watts of power to a 1¾" titanium diaphragm compression driver with ferro-fluid cooling.

Features include: the Loop/Mix output which allows you to daisy-chain any number of EON speakers or send the EON's mixed signal directly to a main PA. Also, two ¼" line level inputs for electronic keyboards, pre-amplified guitars and basses, drum machines, CD players or an input from a mixer.

EON G2 delivers more real power to the speakers. The EON15 G2 has 300 watts for low frequencies and 100 watts for the highs. That's actual power to the drivers

The EON15 G2 shares the same appearance improvements with its smaller companion EON10 G2, including new black exterior material and a mini-mixer with three inputs. An additional XLR output allows EON Speakers to be daisy-chained together. As with other EON G2 speakers, the EON15 G2 is kept cool, not by heatsinks or fans, but by JBL's Thermomaster<sup>®</sup> Total Thermal Management System<sup>®</sup>.

## EONSUB G2

The EONSUB G2 offers powerful low frequencies in a compact, durable enclosure and a new low price. When you combine the EONSUB G2 with the EON10 G2, you have a full range sound system whose clarity, volume and low end are truly amazing, considering their small size. Because the power amp and crossover are internal to all EON speakers, set up time and onboard equipment are minimized. Just plug in and play.

The EONSUB G2 powered subwoofer is consistent in design with other EON G2 models. With 250 watts of low-end power and a frequency range of 40 to 200 Hz, EONSUB G2 is also an ideal companion for any sound system needing additional low end. JBL's patented Neodymium Differential Drive woofer generates maximum efficiency with minimum weight.

The Thermomaster cooling system allows the power amplifier and 15" woofer to stay cool, even under the most challenging circumstances, without the need for noisy fans or protruding external heatsinks. The SUB's cabinet was specifically designed to securely hold the EON10 G2 using receptacles built into the top of the cabinet. The EONSUB G2 has a new scratch-forgiving black covering and embossed grille cover for added rigidity.

## EON G2 ACCESSORIES

- ESK15: Suspension kit for EON 15 models (Not for use with EON 1500)
- ESK10: Suspension kit for EON 10 models
- EON BRK1: Mounting bracket (fixed angle) for EON 15" models
- EON BRK2: Mounting bracket (fixed angle) for EON 10" models
- EONBRK10: Adapts EON 10" models to Omnimount<sup>®</sup> 60 Series brackets
- EONBRK15: Adapts EON 15" models to Omnimount 120 Series brackets
- SS2-BK: Black anodized aluminum tripod speaker stand
- EON10 Bag-1: Zippered, plush-lined speaker bag for all EON 10" models
- EON15 Bag-1: Zippered, plush-lined speaker bag for all EON 15" models
- EON15 Bag/W-1: Wheeled, plush-lined speaker bag for all EON 15" models



EON Systems are remarkably easy to use in a variety of installations. With over 300,000 systems in use, the JBL EON System is the industry leader in powered portable speaker systems.



# EON<sup>G2</sup>

GENERATION 2

## [KEY FEATURES]

EON G2 Series

- JBL'S PATENTED NEODYMIUM DIFFERENTIAL DRIVE<sup>®</sup> LF TRANSDUCERS
- PURE TITANIUM COMPRESSION DRIVERS
- SUBSTANTIAL INCREASES IN POWER
- A LOOP/MIX OUTPUT FOR DAISY-CHAINING MULTIPLE SPEAKERS OR SENDING SIGNAL TO A MAIN PA
- ENCLOSURE ANGLES FOR MULTI-APPLICATION USE
- THERMOMASTER<sup>®</sup> TOTAL THERMAL MANAGEMENT SYSTEM<sup>®</sup>
- ATTACHMENT POINTS FOR FIXED-ANGLE AND ADJUSTABLE MOUNTING BRACKETS

The cabinet of the EON10 G2 has been designed to fit securely atop the EONSUB G2 for added volume and extended bandwidth.



EONSUB G2



A variety of zippered, plush-lined speaker bags are available for EON Products.



The BRK10 and BRK15 adapt EON10 and EON15 models to the Omnimount<sup>®</sup> Series 60 and 120 Brackets.

EON10 G2  
(Monitor Position)



EON15 G2



## [SPECIFICATIONS]

	EON10 G2	EON15 G2	EONSUB G2
SYSTEM TYPE	10" Two-way Speaker System	15" Two-way Speaker System	Powered Subwoofer
FREQUENCY RANGE	65 Hz - 18 kHz (-10 dB)	39 Hz - 18 kHz (-10 dB)	40 Hz - 200 Hz (-10 dB)
FREQUENCY RESPONSE	90 Hz - 16 kHz (± 3 dB)	42 Hz - 17 kHz (± 3 dB)	42 Hz - 150 Hz (± 3 dB)
RATED MAXIMUM SPL	117 dB @ 1 m	129 dB @ 1m	117 dB @ 1 m
TRANSDUCERS: LF	254 mm (10 in)	380 mm (15 in)	380 mm (15 in)
HF	JBL 2412 (1 in)	JBL 2418 (1 in)	
DISPERSION ANGLE	90° H x 60° V	90° H x 60° V	
LF POWER AMP	125 W @ driver impedance	300 W @ driver impedance	250 W @ driver impedance
HF POWER AMP	50 W @ driver impedance	100 W @ driver impedance	
DIMENSIONS (H x W x D)	493 x 356 x 307 mm	686 x 430 x 444 mm	686 x 430 x 444 mm
	19.4 x 14.0 x 12.1 in	27 x 17 x 17.5 in	27 x 17 x 17.5 in
NET WEIGHT (each)	10.4 kg (23 lbs)	21 kg (46 lbs)	19.5 kg (43 lbs)

# E-Systems

**Pre-packaged, complete sound reinforcement systems featuring JBL EON powered speakers, Soundcraft E-Series mixing consoles, and AKG microphones. A complete sound reinforcement system so good that no one company could build it all.**

## E-System 15

**E-System 15** starts with the second generation of the speaker that started the powered-speaker revolution – the JBL EON15 G2 featuring 400 watts of bi-amplified power (300 watts for low frequencies and 100 watts for high frequencies). The EON15 G2 is at home as a main PA speaker or as a vocal or instrument monitor.

Then add a Soundcraft E-8 mixer with that great British sound and these features:

- **8 mono input channels plus two stereo inputs**
- **2 aux sends, each globally switchable pre or post fader**
- **100 mm faders**
- **Internal power supply**
- **Simple rack mounting options**
- **3-band EQ with swept mid band**
- **Precision, ultra-linear mic pre-amps**
- **True, professional +48V phantom power**
- **Individual channel mutes**

To complete the system, a pair of AKG D2000S microphones is included. These handheld, dynamic, hypercardioid microphones are at home in a variety of sound reinforcement applications for speech, vocals and instruments. Rounding out the system are four 25' XLR cables to hook it all together.



## [MIC SPECS]

### AKG D2000S

<b>TYPE</b>	Dynamic Microphone
<b>FREQUENCY RANGE</b>	70 - 20,000 Hz
<b>POLAR PATTERN</b>	Hypercardioid
<b>SENSITIVITY @ 1000 Hz</b>	2.0 mV/Pa (-54 dBV re 1V/Pa)
<b>EQUIVALENT NOISE LEVEL</b>	20 dB(A) to DIN 45412
<b>MAXIMUM SPL</b>	FOR 1% THD: 140 dB SPL FOR 3% THD: 150 dB SPL
<b>ELECTRICAL IMPEDANCE</b>	<500 ohms
<b>RECOMMENDED LOAD IMPEDANCE</b>	>1200 ohms
<b>CONNECTOR</b>	3-pin male XLR
<b>FINISH</b>	matte black enamel
<b>SIZE: LENGTH</b>	181 mm (7.13 in)
<b>Ø</b>	50 mm (1.97 in)
<b>WEIGHT</b>	230 g (8.1 oz)

## E-System 10

The JBL EON10 G2 weighs in at only 10.4 kg (23 lbs) but proves that you don't need size and weight to get quality. With 175 watts of bi-amplified power (125 watts for low frequencies and 50 watts for high frequencies) the EON10 G2 is the choice for moderate-level performance.

Add a Soundcraft E-6 mixer:

- **6 mono input channels plus two stereo inputs**
- **2 aux sends, each globally switchable pre or post fader**
- **100 mm faders**
- **Internal power supply**
- **Simple rack mounting options**
- **3-band EQ with swept mid band**
- **Precision, ultra-linear mic pre-amps**
- **True, professional +48V phantom power**
- **Individual channel mutes**

To complete the system, a pair of AKG D2000S microphones is included. These handheld, dynamic, hypercardioid microphones are at home in a variety of sound reinforcement applications for speech, vocals and instruments. Rounding out the system are four 25' XLR cables to hook it all together.



SOUNDSCRAFT E-8 MIXER

## [MIXER SPECS]

### Soundcraft E-Series Mixing Console

<b>INPUT CHANNELS</b>	MIC/LINE, MONO: 6 (E-6); 8 (E-8) Line, Stereo: 2
<b>AUXILIARY SENDS</b>	2, globally selectable, pre/post
<b>NOISE (22 Hz-22 kHz): MIC EIN MIX</b>	128 dBu (max gain, 150 ohms source impedance) <-85 dBu (@ max, faders down)
<b>CROSSTALK</b>	>96 dB (Channel mute ) >96 dB (Fader cut-off [rel +10 mark]) >86 dB Aux send pot offness
<b>FREQUENCY RESPONSE</b>	20 Hz – 20 kHz (+/- 0.5 dB) (Mic/Line input to any output)
<b>THD+ NOISE</b>	<0.007% (Mic gain 30 dB, -30 dBu input Mix out, fader max @ 1kHz)
<b>INPUT &amp; OUTPUT IMPEDANCES</b>	Mic input: 2.5 kohms Line input: 11 kohms Stereo input: 100 kohms Outputs: 75 ohms
<b>INPUT AND OUTPUT LEVELS</b>	Mic input max level: +17 dBu Line input max level: +30 dBu Stereo input max level: +30 dBu Mix output max level: +20 dBu Headphones (@ 200 ohms): 300 mW
<b>EQ (MONO INPUTS)</b>	Lo: 80 Hz shelving +/- 15 dB Mid (swept): 140 Hz – 3 kHz +/- 15 dB High: 12 k +/- 15 dB
<b>EQ (STEREO INPUTS)</b>	Lo: 80 Hz shelving +/- 15 dB High: 12 k +/- 15 dB
<b>WEIGHT</b>	E6: 5.75 kg (12.68 lbs) E8: 6.75 kg (14.88 lbs)
<b>DIMENSIONS: WIDTH</b>	E6: 375.6 mm (14.79 in) E8: 426.44 mm (16.79 in)
<b>HEIGHT</b>	E6 & E8: 95.11 mm (3.74 in)
<b>DEPTH</b>	E6 & E8: 451.43 mm (17.77 in)
<b>RACK MOUNTING</b>	E6: Requires Soundcraft Part # P-S20000D-01 E8: Requires Soundcraft Part # P-S20001D-01

- COMPLETE, TURN-KEY SYSTEMS WITH COMPLEMENTARY COMPONENTS
- WIDE RANGE OF APPLICATIONS
- VERSATILE ENCLOSURE ANGLES
- FEATURE-PACKED SOUNDCRAFT MIXERS

[SYSTEM SUMMARY]

	F-System 15	F-System 10
<b>SPEAKERS</b>	2 x EON15 G2	2 x EON10 G2
<b>MIXER</b>	Soundcraft E-8	Soundcraft E-6
<b>MICROPHONES</b>	2 x AKG D2000S	2 x AKG D2000S
<b>CABLES</b>	4 x 25' XLR CABLES	4 x 25' XLR CABLES



**E-SYSTEM 10**

[PORTABLE PRODUCTS]



**E-SYSTEM 15**

# SR-X<sup>®</sup> Series

The SR-X Series was designed for the most discerning users, with 11 models that embody the superior engineering, unsurpassed tour sound performance, legendary reliability and value inherent in the JBL name.

While each SR-X speaker has a personality all its own; the line as a whole delivers a remarkable range of options. In fact, SR-X is the most complete line of high-performance speakers available today, with a model for virtually every application. You can be assured that the JBL SR-X systems are more than just the most prestigious speakers in their class. . . They also boast massive amounts of true JBL technology, quality and substance. Selected SR-X speaker models are available with flying hardware installed. A flexible, 6-point rigging system accommodates “flyclip” fittings (not included) for portable applications as well as 10 mm eyebolts (not included) for fixed installation.

## STAGE MONITOR: MODEL SR4702X

The **SR4702X** 12” two-way stage monitor features 600 watts of power capacity and 95 dB sensitivity. It delivers high output with a compact footprint and low profile.

## TWO-WAY SYSTEMS: MODELS SR4722X, SR4725X, SR4726X

The **SR4722X** 12” two-way speaker is the choice for applications where compact size, ease of transport and speaker stand mounting are needed. With extended low frequencies in a transportable enclosure, the **SR4725X** 15” two-way compact speaker is the favorite for most general music and speech applications. The **SR4726X** 15” two-way high output speaker provides very high acoustic output and extended low-frequency performance combined with the convenience of a one-box system.

## DUAL LF: MODELS SR4731X, SR4733X

The **SR4731X** dual 12” two-way system features the combined power of two LF voice-coil/magnet assemblies and the cone area of dual 12” speakers. The SR4731X produces incredible mid-range power combined with tight, punchy bass. The **SR4733X** dual 15” two-way combines high-power and extended low frequency with the simplicity of a single-box system. At home in the most demanding live sound and playback environments, the SR4733X delivers the performance usually associated with subwoofer equipped systems.

## THREE-WAY SYSTEMS: MODELS SR4732X, SR4735X

The **SR4732X** dual 12” three-way is the ultimate speaker system for very high level music playback. The system features a JBL 2404 UHF driver added to the incredible SR4731X two-way. The SR4732X in combination with the SR4719X subwoofer is an unbeatable system

for mobile DJ and club applications. The **SR4735X** system is bound to become a classic. This unique three-way design uses a high-power, 8” cone driver mounted to a specially designed waveguide for the critical mid-frequencies. You get the warmth of a cone mid-range driver combined with the clarity and throw of a horn.

## SUBWOOFERS: MODELS SR4715X-1, SR4718X, SR4719X

The **SR4715X-1** dual 15” subwoofer is the choice when the tight, punchy bass of a 15” sub is a requirement. The **SR4718X** single 18” produces pounding bass down to 30 Hz. Combine it with one of the SR-X full-range systems or add it to your existing mid/high speakers. The **SR4719X** dual 18” is capable of delivering wall-shaking acoustical output up to 138 dB with a frequency range extending to 30 Hz. This is the choice for large rooms, outdoor performance, high-level sound reinforcement or music playback.



- DUAL MODE CROSSOVERS
- ADVANCED TECHNOLOGY DIVIDING NETWORKS
- VGC™ WOOFERS (VENTED GAP COOLING)
- 13-PLY BIRCH CABINETS
- TITANIUM DIAPHRAGM COMPRESSION DRIVERS
- OPTIMIZED APERTURE™ HORNS
- DURAFLEX™ FINISH
- 18 GAUGE PERFORATED METAL GRILLE

## Fitted Covers Protect Your SR-X Investment

Give your SR-X speakers the protection they deserve with these heavy-duty speaker covers.

<b>SR02COVER</b>	Protective speaker cover for SR4702X
<b>SR22COVER</b>	Protective speaker cover for SR4722X, SR4722X/F
<b>SR25COVER</b>	Protective speaker cover for SR4725X SR4725X/F
<b>SR26COVER</b>	Protective speaker cover for SR4726X, SR4726X/F
<b>SR32COVER</b>	Protective speaker cover for SR4731X/SR4732X and SR4731X/F/SR4732X/F
<b>SR33COVER</b>	Protective speaker cover for SR4733X, SR4733X/F
<b>SR35COVER</b>	Protective speaker cover for SR4735X, SR4735X/F
<b>SR15COVER</b>	Protective speaker cover for SR4715X-1
<b>SR18COVER</b>	Protective speaker cover for SR4718X
<b>SR19COVER</b>	Protective speaker cover for SR4719X



### SR4702X

#### 12" two-way stage monitor in a dual angle (30° and 60°) enclosure

LF: 2206 12" VGC™ transducer

HF: 2426 1" exit compression driver on an OASR™ conical horn

#### Applications:

- Stage floor foldback vocal monitor
- Front of house (with tripod stand)
- Mid/high pack with additional subwoofer (with pole or tripod stand)

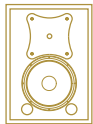

### SR4722X (F\*)

#### 12" two-way in a trapezoidal enclosure

LF: 2206 12" VGC transducer

HF: 2417 1" exit compression driver on an OASR conical horn

#### Applications:

- Front of house (pole mount stand or floor)
- Mid/high pack with additional subwoofer

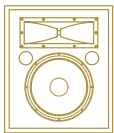

### SR4725X (F\*)

#### 15" two-way in a trapezoidal enclosure

LF: 2226 15" VGC transducer

HF: 2426 1" exit compression driver on a 2370 horn

#### Applications:

- Front of house or floor
- Mid/high pack with additional subwoofer
- Full-range instrument stage monitor

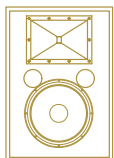

### SR4726X (F\*)

#### High output 15" two-way in a trapezoidal enclosure

LF: 2226 15" VGC transducer

HF: 2447 2" exit compression driver on a 2381 horn

#### Applications:

- Front of house
- Full-range instrument stage monitor
- Drum stage monitor

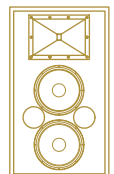

### SR4731X (F\*)

#### Dual 12" two-way in a trapezoidal enclosure

LF: Two 2206 12" VGC transducers

HF: 2447 2" exit compression driver on a 2381 horn

#### Applications:

- Front of house
- Mid/high pack with additional subwoofer
- Side fill monitor

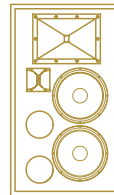

### SR4732X (F\*)

#### Dual 12" three-way in a trapezoidal enclosure

LF: Two 2206 12" VGC transducers

MF: 2447 2" exit compression driver on a 2381 horn

HF: 2404 UHF driver and Bi-Radial® horn

#### Applications:

- Front of house (short-throw applications)
- Mid/high pack with subwoofer for high output music playback
- Side fill monitor

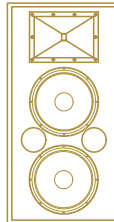

### SR4733X (F\*)

#### Dual 15" two-way in a trapezoidal enclosure

LF: Two 2226 15" VGC transducers

HF: 2447 2" exit compression driver on 2381 horn

#### Applications:

- Front of house
- High output full-range music playback
- Side fill monitor



### SR4735X (F\*)

#### 15" three-way in a trapezoidal enclosure

LF: 2226 15" VGC transducer

MF: M-209-8A 8" cone transducer

HF: 2426 1" exit compression driver on an MH1 Mid-High waveguide

#### Applications:

- Mid/high pack with additional subwoofer for music playback (long-throw)
- Side fill monitor (rotatable, for vertical or horizontal use)

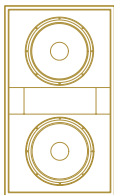

### SR4715X-1

#### Dual 15" Subwoofer system in a rectangular enclosure

LF: Two 2226 15" VGC transducers

#### Application:

- Subwoofer



### SR4718X

#### 18" Subwoofer system in a rectangular enclosure

LF: 2241 18" VGC transducer

#### Application:

- Subwoofer

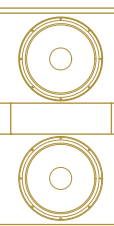

### SR4719X

#### Dual 18" Subwoofer system in a rectangular enclosure

LF: Two 2241 18" VGC transducers

#### Application:

- Subwoofer

\* Flying versions available with ATM Flytrack™.

# SR-X<sup>®</sup> Series

## [SPECIFICATIONS]

	SR4702X	SR4722X SR4722X/F	SR4725X SR4725X/F
SYSTEM TYPE	12" Two-way Monitor	12" Two-way Compact	15" Two-way Compact
FREQUENCY RANGE	42 Hz - 20 kHz (-10 dB)	42 Hz - 18 kHz (-10 dB)	35 Hz - 18 kHz (-10 dB)
FREQUENCY RESPONSE	60 Hz - 18 kHz (± 3 dB)	60 Hz - 18 kHz (± 3 dB)	42 Hz - 18 kHz (± 3 dB)
SENSITIVITY: 1 W, 1 m	95 dB	95 dB	98 dB
NOMINAL COVERAGE	85° x 85°	85° x 85°	90° x 40°
POWER HANDLING <sup>1</sup>	600 W	600 W	600 W
MAXIMUM SPL <sup>2</sup>	129 dB	129 dB	132 dB
NOMINAL IMPEDANCE	8 ohms	8 ohms	8 ohms
TRANSDUCERS: LF	2206H	2206H	2226H
M/HF	2426H	2417H	2426H
UHF			
HORN	OASR	OASR	2370
FINISH	Black DuraFlex	Black DuraFlex	Black DuraFlex
DIMENSIONS <sup>3</sup> (H x W x D)	647.7 x 403.2 x 355.6 mm 25.5 x 15.9 x 14 in	685.8 x 485.8 x 333.4 mm 27 x 19.1 x 13.1 in	717.6 x 616 x 435 mm 28.3 x 24.3 x 17.1 in
NET WEIGHT (each) (Excludes shipping carton)	29.0 kg (64 lbs)	27.2 kg (60 lbs) SR4722X 31.3 kg (69 lbs) SR4722X/F	37.2 kg (82 lbs) SR4725X 43.1 kg (95 lbs) SR4725X/F

	SR4726X SR4726X/F	SR4731X SR4731X/F	SR4732X SR4732X/F	SR4733X SR4733X/F
SYSTEM TYPE	15" Two-way High-power	Dual 12" Two-way	Dual 12" Three-way	Dual 15" Two-way
FREQUENCY RANGE	35 Hz - 20 kHz (-10 dB)	39 Hz - 20 kHz (-10 dB)	39 Hz - 21 kHz (-10 dB)	37 Hz - 20 kHz (-10 dB)
FREQUENCY RESPONSE	42 Hz - 18 kHz (± 3 dB)	45 Hz - 18 kHz (± 3 dB)	45 Hz - 20 kHz (± 3 dB)	42 Hz - 18 kHz (± 3 dB)
SENSITIVITY: 1 W, 1 m	97 dB	98 dB	98 dB	100 dB
NOMINAL COVERAGE	90° x 50°, 60° x 50° (F)	90° x 50°, 60° x 50° (F)	90° x 50°	90° x 50°, 60° x 50° (F)
POWER HANDLING <sup>1</sup>	600 W	1200 W	1200 W	1200 W
MAXIMUM SPL <sup>2</sup>	131 dB	135 dB	135 dB	137 dB
NOMINAL IMPEDANCE	8 ohms	4 ohms	4 ohms	4 ohms
TRANSDUCERS: LF	2226H	2206H x 2	2206H x 2	2226H x 2
M/HF	2447J	2447J	2447J	2447J
UHF			2404H	
HORN	2381 2383 (SR4726X/F)	2381 2383 (SR4731X/F)	2381	2381 2383 (SR4733X/F)
FINISH	Black DuraFlex	Black DuraFlex	Black DuraFlex	Black DuraFlex
DIMENSIONS <sup>3</sup> (H x W x D)	882.7 x 616 x 435 mm 34.8 x 24.3 x 17.1 in	1066.8 x 616 x 435 mm 42 x 24.3 x 17.1 in	1066.8 x 616 x 435 mm 42 x 24.3 x 17.1 in	1219.2 x 616 x 435 mm 48 x 24.3 x 17.1 in
NET WEIGHT (each) (Excludes shipping carton)	48.5 kg (107 lbs) SR4726X 54.4 kg (120 lbs) SR4726X/F	59.9 kg (132 lbs) SR4731X 65.8 kg (145 lbs) SR4731X/F	62.1 kg (137 lbs) SR4732X 68 kg (150 lbs) SR4732X/F	65.8 kg (145 lbs) SR4733X 71.7 kg (158 lbs) SR4733X/F

	SR4735X SR4735X/F	SR4715X-1	SR4718X	SR4719X
SYSTEM TYPE	15" Three-way Cone MF	Dual 15" Subwoofer	18" Subwoofer	Dual 18" Subwoofer
FREQUENCY RANGE	36 Hz - 20 kHz (-10 dB)	35 - 300 Hz (-10 dB)	38 - 300 Hz (-10 dB)	30 - 300 Hz (-10 dB)
FREQUENCY RESPONSE	42 Hz - 18 kHz (± 3 dB)	40 - 300 Hz (± 3 dB)	42 - 300 Hz (± 3 dB)	35 - 300 Hz (± 3 dB)
SENSITIVITY: 1 W, 1 m	97 dB	100 dB	98 dB	101 dB
NOMINAL COVERAGE	70° x 50°			
POWER HANDLING <sup>1</sup>	600 W	1200 W	600 W	1200 W
MAXIMUM SPL <sup>2</sup>	131 dB	137 dB	132 dB	138 dB
NOMINAL IMPEDANCE	8 ohms	4 ohms	4 ohms	4 ohms
TRANSDUCERS: LF	2226H	2226H X 2	2241G	2241H X 2
M/HF	M209-8A			
UHF	2426H			
HORN	MH1			
FINISH	Black DuraFlex	Black DuraFlex	Black DuraFlex	Black DuraFlex
DIMENSIONS <sup>3</sup> (H x W x D)	946.2 x 616 x 479.4 mm 37.3 x 24.3 x 18.9 in	1066.8 x 584 x 653 mm 42 x 23 x 25.7 in	616 x 612.8 x 609.6 mm 24.3 x 24.1 x 24 in	765.2 x 1219.2 x 616 mm 30.1 x 48 x 24.3 in
NET WEIGHT (each) (Excludes shipping carton)	50.8 kg (112 lbs) SR4735X 56.7 kg (125 lbs) SR4735X/F	54 kg (118 lbs)	39.9 kg (88 lbs)	85.3 kg (188 lbs)

[LOUDSPEAKER COMPONENTS]

# Cone Transducers

## VGC™ SERIES

**MODELS: 2206H, 2226H/J, 2241H**

These low-frequency transducers represent the results of JBL's engineering research in high power transducer design. They signify a major advance in speaker design by incorporating JBL's patented Vented Gap Cooling technology in an improved Symmetrical Field Geometry (SFG) magnet structure.

Through the use of new computer-aided magnet optimization and analysis techniques, JBL engineers optimized both magnet weight, flux density and field saturation resulting in a reduction of overall driver weight and a significant reduction in harmonic distortion. This magnet structure offers much of the weight advantage of rare earth magnet structures without their prohibitive cost.

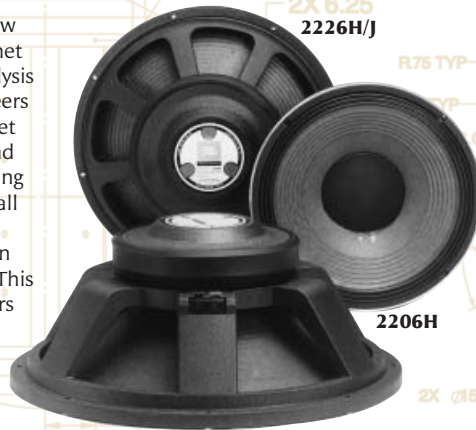

## SVG™ SERIES

**LOW-FREQUENCY  
MAXIMUM OUTPUT TRANSDUCERS**

**MODEL: 2242H**

The 2242H low-frequency transducer incorporates JBL's patented Super Vented Gap™ technology for improvement in power handling capability while minimizing power compression.



2242H

**MIDRANGE/LOW FREQUENCY  
MAXIMUM OUTPUT TRANSDUCERS**

**MODELS: 2012H, 2020H**

These transducers provide low distortion, high efficiency performance with flat power response output for a wide variety of midrange and low-frequency sound reinforcement applications.



2020H

2012H

## COAXIAL TRANSDUCERS

**MODELS: 2142H, 2152H**

The JBL coaxial transducers combine specially designed cones and HF elements to provide smooth system response. The 2152H utilizes Bi-Radial® horn architecture and the JBL 2416H high frequency compression driver to achieve high acoustical power output while maintaining smooth response. The HF dispersion angle is 90° nominal.

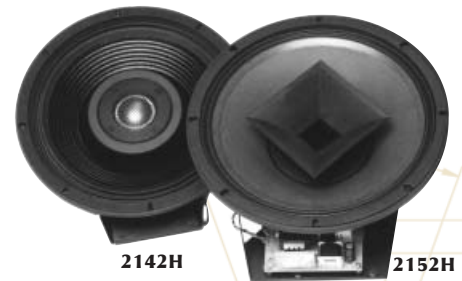

2142H

2152H

## [SPECIFICATIONS]

	2206H	2226H/J	2241H
<b>NOMINAL DIAMETER</b>	300 mm (12 in)	380 mm (15 in)	460 mm (18 in)
<b>RATED IMPEDANCE</b>	8 ohms	8 ohms (H) 16 ohms (J)	8 ohms
<b>POWER CAPACITY</b>	600 W <sup>1</sup>	600 W <sup>1</sup>	600 W <sup>1</sup>
<b>SENSITIVITY: 1 W, 1 m</b>	95 dB SPL <sup>2</sup>	97 dB SPL <sup>2</sup>	98 dB SPL <sup>2</sup>
<b>FREQUENCY RANGE (-10 dB)</b>	45 Hz - 3.5 kHz	30 Hz - 2.5 kHz	30 Hz - 3 kHz
<b>HIGHEST Crossover</b>	1500 Hz	1200 Hz	800 Hz
<b>VOICE COIL DIAMETER</b>	100 mm (4 in)	100 mm (4 in)	100 mm (4 in)
<b>VOICE COIL MATERIAL</b>	Edgewound aluminum ribbon	Edgewound aluminum ribbon	Edgewound aluminum ribbon
<b>HALF SPACE REFERENCE EFFICIENCY</b>	2.5%	3.3%	2.9%
<b>NET WEIGHT (each)</b>	7.8 kg (17.1 lbs)	8.7 kg (19.25 lbs)	10.7 kg (23.5 lbs)

	2242H	2012H	2020H	2142H	2152H
<b>NOMINAL DIAMETER</b>	460 mm (18 in)	250 mm (10 in)	300 mm (12 in)	300 mm (12 in)	300 mm (12 in)
<b>RATED IMPEDANCE</b>	8 ohms	8 ohms	8 ohms	8 ohms	8 ohms
<b>POWER CAPACITY</b>	800 W <sup>1</sup>	300 W <sup>1</sup>	300 W <sup>1</sup>	90 W <sup>3</sup>	150 W <sup>3</sup>
<b>SENSITIVITY: 1 W, 1 m</b>	99 dB SPL <sup>2</sup>	100 dB SPL <sup>4</sup>	103 dB SPL <sup>4</sup>	97 dB SPL <sup>4</sup>	102 dB SPL <sup>4</sup>
<b>FREQUENCY RANGE (-10 dB)</b>	25 Hz - 1.6 kHz	70 Hz - 8 kHz	100 Hz - 6 kHz	60 Hz - 22 kHz	70 Hz - 17 kHz
<b>HIGHEST Crossover</b>	1.0 kHz	6 kHz	5 kHz	2.7 kHz	1.5 kHz
<b>VOICE COIL DIAMETER</b>	100 mm (4 in)	76 mm (3 in)	76 mm (3 in)	51 mm (2 in)	76 mm (3 in)
<b>VOICE COIL MATERIAL</b>	Edgewound aluminum ribbon	Edgewound aluminum ribbon	Edgewound aluminum ribbon	2 Layer Round- Wound Copper	Edgewound aluminum ribbon
<b>HALF SPACE REFERENCE EFFICIENCY</b>	4%	3.5%	5.4%	1.82%	5.1%
<b>NET WEIGHT (each)</b>	13.2 kg (29 lbs)	9.1 kg (20 lbs)	8.6 kg (19 lbs)	5.5 kg (12 lbs)	9.5 kg (21 lbs)

<sup>1</sup> AES standard (50 - 500 Hz)

<sup>2</sup> Based on a swept 100 to 500 Hz signal.  
1 W is 2.83 V @ 8 ohms, 4.0V @ 16 ohms.

<sup>3</sup> Based on standard IEC 268-1

<sup>4</sup> Based on a swept 500 Hz to 2.5 kHz signal.

# Compression Drivers

### ULTRA-HIGH FREQUENCY TRANSDUCERS (44 mm - 1 3/4" Diaphragm)

#### MODELS: 2402H, 2404H, 2405H

The JBL Ultra-High Frequency Transducers are designed to provide high acoustic output and controlled dispersion. The **2402H** is ideal for applications requiring directivity, penetration and wide bandwidth. Its dispersion pattern is 40° conical at 10 kHz. The **2404H** is equipped with a unique Bi-Radial® horn, maintaining precise control of the horn's wide 100° x 100° coverage angle. The **2405H** provides smooth response and exceptionally wide dispersion even at extremely high frequencies.

### 25 mm - 1" EXIT COMPRESSION DRIVER (44 mm - 1 3/4" Diaphragm)

#### MODEL: 2426H/J

The **JBL 2426H/J** is a professional quality high frequency compression driver which incorporates JBL's titanium diamond diaphragm for ruggedness and outstanding frequency response. The H version is 8 ohms impedance and the J version is 16 ohms.



2402H



2404H



2405H

### 38 mm - 1 1/2" EXIT COMPRESSION DRIVERS (100 mm - 4" Diaphragm)

#### MODELS: 2447H/J, 2451H/J

The 38 mm exits on the **2447H/J** and **2451H/J** compression drivers allow the Coherent Wave™ phasing plug to directly couple with Optimized Aperture™ Bi-Radial® horns for lower distortion and better coverage control than previous versions. The large format 100 mm (4 in) diaphragm design includes JBL's exclusive three dimensional diamond pattern. This design combined with the Coherent Wave phasing plug increases the drivers' output in the 5 kHz to 20 kHz range. The H version is 8 ohms impedance and the J version is 16 ohms.



2426H/J



2447H/J



2451H/J

### 49 mm - 2" EXIT COMPRESSION DRIVERS (100 mm - 4" Diaphragm)

#### MODELS: 2446H/J, 2450H/J

With the optimized configuration of the Coherent Wave phasing plug design, these large format JBL compression drivers offer coherent summation of acoustical power up to much higher frequencies than previous designs. The **2450H/J** incorporates a neodymium rare-earth magnet assembly that provides the equivalent electromechanical conversion efficiency at two-thirds the size and one-third the weight required by previous large format compression driver designs. The H version is 8 ohms impedance and the J version is 16 ohms.



2446H/J



2450H/J



Cluster Detail:  
American Airlines Center,  
Dallas, Texas

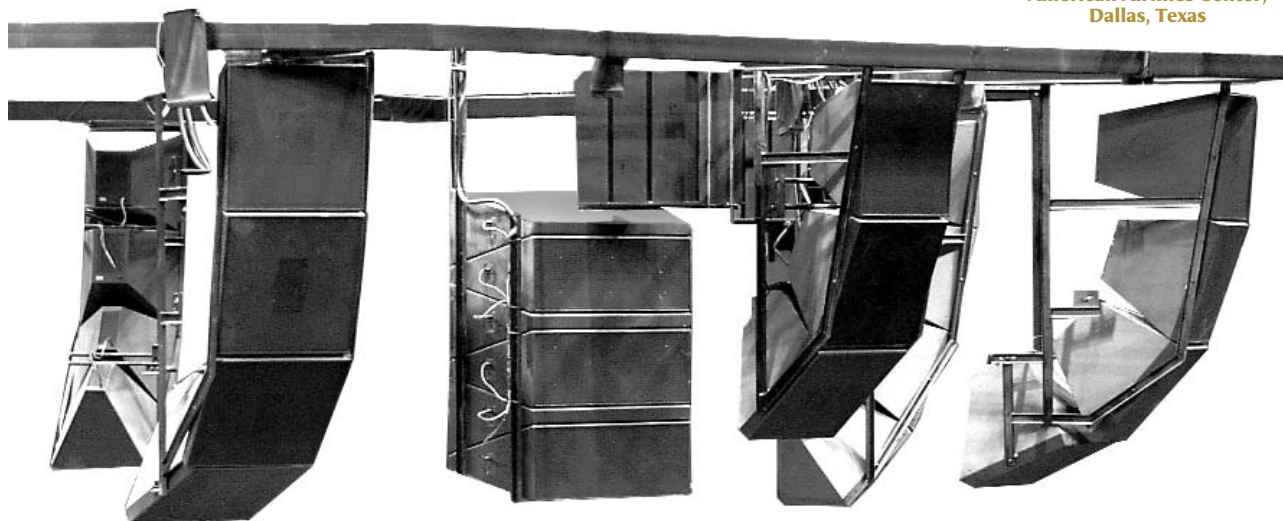

## [SPECIFICATIONS]

	2402H	2404H	2405H	2426H/J
NOMINAL IMPEDANCE	8 ohms	8 ohms	8 ohms	8 ohms (H) 16 ohms (J)
POWER CAPACITY <sup>1</sup>	40 W	40 W	40 W above 6 kHz	70 W above 800 Hz 100 W above 1.2 kHz
SENSITIVITY, 1 W, 1 m (Averaged)	110 dB (5 kHz - 20 kHz)	105 dB (3 kHz - 20 kHz)	105 dB (7 kHz - 20 kHz)	110 dB <sup>2</sup> (1 kHz - 4 kHz)
FREQUENCY RANGE (-10 dB)	2.5 kHz - 15 kHz	3 kHz - 21.5 kHz	6.5 kHz - 21.5 kHz	500 Hz - 20 kHz
DISPERSION	40° conical @ 10 kHz	100° x 100°	90° x 25° @ 16 kHz	
RECOMMENDED CROSSOVER	2.5 kHz	3 kHz or higher	7 kHz or higher	800 Hz or higher
DIAPHRAGM: SIZE	44 mm (1 3/4 in)	44 mm (1 3/4 in)	44 mm (1 3/4 in)	44 mm (1 3/4 in)
MATERIAL	Aluminum alloy	Aluminum alloy	Aluminum alloy	Pure titanium
VOICE COIL MATERIAL	Aluminum ribbon	Aluminum ribbon	Aluminum ribbon	Aluminum ribbon
FLUX DENSITY	1.75 T (17,500 gauss)	1.75 T (17,500 gauss)	1.75 T (17,500 gauss)	1.8 T (18,000 gauss)
DIMENSIONS: DIAMETER	121 mm (4.75 in)	130 mm (5.12 in)	121 mm (4.75 in)	149 mm (5.875 in)
DEPTH	98 mm (3.875 in)	130 mm (5.12 in)	95 mm (3.75 in)	104 mm (4.125 in)
NET WEIGHT (each)	2.3 kg (5 lbs)	2.27 kg (5 lbs)	2.3 kg (5 lbs)	4.3 kg (9.5 lbs)

	2447H/J	2451H/J	2446H/J	2450H/J
NOMINAL IMPEDANCE	8 ohms (H) 16 ohms (J)	8 ohms (H) 16 ohms (J)	8 ohms (H) 16 ohms (J)	8 ohms (H) 16 ohms (J)
POWER CAPACITY <sup>1</sup>	100 W above 500 Hz 150 W above 1 kHz	100 W above 500 Hz 150 W above 1 kHz	100 W above 500 Hz 150 W above 1 kHz	100 W above 500 Hz 150 W above 1 kHz
SENSITIVITY, 1 W, 1 m (Averaged)	111 dB <sup>2</sup> (1 kHz - 4 kHz)	111 dB <sup>2</sup> (500 Hz - 2.5 kHz)	111 dB <sup>2</sup> (2 kHz octave band)	111 dB <sup>2</sup> (2 kHz octave band)
FREQUENCY RANGE (-10 dB)	500 Hz - 20 kHz	500 Hz - 20 kHz	500 Hz - 20 kHz	500 Hz - 20 kHz
RECOMMENDED CROSSOVER	500 Hz or higher	500 Hz or higher	500 Hz or higher	500 Hz or higher
DIAPHRAGM: SIZE	100 mm (4 in)	100 mm (4 in)	100 mm (4 in)	100 mm (4 in)
MATERIAL	Pure titanium	Pure titanium	Pure titanium	Pure titanium
VOICE COIL MATERIAL	Aluminum ribbon	Aluminum ribbon	Aluminum ribbon	Aluminum ribbon
FLUX DENSITY	1.85 T (18,500 gauss)	1.9 T (19,000 gauss)	1.9 T (19,000 gauss)	1.9 T (19,000 gauss)
DIMENSIONS: DIAMETER	235 mm (9.25 in)	167 mm (6.6 in)	235 mm (9.25 in)	167 mm (6.6 in)
DEPTH	100 mm (4 in)	76 mm (3 in)	131 mm (5.2 in)	139 mm (5.5 in)
NET WEIGHT (each)	10.7 kg (23.5 lbs)	4.5 kg (10 lbs)	13.8 kg (30.5 lbs)	4.8 kg (10.5 lbs)

<sup>1</sup> Continuous program power is defined as 3 dB greater than continuous pink noise and is a conservative expression of the transducer's ability to handle typical speech and music program material.

<sup>2</sup> Sensitivity measured on a horn with a Q of 6.3.

# Horns

## OPTIMIZED APERTURE™ MID-SIZE BI-RADIAL® HORNS MODELS: 2352, 2353, 2354

The Optimized Aperture Mid-Size Bi-Radial Horns are designed to provide high sound pressure level at low distortion over the bandwidth of 630 Hz to beyond 18 kHz with very uniform horizontal and vertical coverage from an optimum size horn. Extensive modeling was used to optimize the coverage pattern, reducing both distortion and size.

Constant horizontal and vertical coverage patterns provide easily predictable performance at any frequency or orientation. Cluster design is simplified and typical problems such as lobing and size are greatly reduced.



2370A



2382A



2509A

## FLAT-FRONT BI-RADIAL® HORNS MODELS: 2370A, 2380A, 2382A, 2385A, 2386A

The Flat-Front Bi-Radial Horns are designed for flush cabinet mounting or compact cluster applications. The horns provide uniform on and off axis frequency response at the rated frequencies.

The horn's small vertical mouth dimension (just slightly larger than the compression driver used to drive the horn) allows very compact single and multiple horn/driver systems to be put together. Should vertical pattern control be required below 2 kHz, two or more horns may be stacked vertically to restore full Bi-Radial™ performance.

## HORN/DRIVER MOUNTING SYSTEM MODELS: 2509A

The 2509 Professional Mounting Bracket is designed to facilitate easy installations and quick adjustability in a variety of applications. It is manufactured of rugged 1/8" steel and finished in black matte. The **2509** Professional Mounting Bracket is not intended for suspension applications.

The **2509A** is a two piece system that allows aiming and rotation in three planes—vertical, horizontal and rotation around axis. The width of the mounting slots and an included adaptor gasket allow use with the **2350** Series and the **2380** Series.

## [SPECIFICATIONS]

	2352	2353	2354
THROAT SIZE	38 mm (1 1/2 in)	38 mm (1 1/2 in)	38 mm (1 1/2 in)
ACCEPTS JBL DRIVERS	2447H/J, 2451H/J	2447H/J, 2451H/J	2447H/J, 2451H/J
NOMINAL DISPERSION	90° H x 40° V	60° H x 40° V	40° H x 30° V
DIRECTIVITY FACTOR (Q) (Averaged)	13 (630 Hz - 20 kHz)	16 (630 Hz - 20 kHz)	30 (800 Hz - 20 kHz)
DIRECTIVITY INDEX (DI) (Averaged)	11 (630 Hz - 20 kHz)	12 (630 Hz - 20 kHz)	15 (800 Hz - 20 kHz)
USABLE LOW FREQ. LIMIT	500 Hz	500 Hz	500 Hz
MIN. RECOMMENDED CROSSOVER	500 Hz @ 18 dB/oct min.	500 Hz @ 18 dB/oct min.	500 Hz @ 18 dB/oct min.
AXIAL PRESSURE SENSITIVITY <sup>1</sup>	112 dB	114 dB	115 dB
CONSTRUCTION	Fiberglass reinforced plastic	Fiberglass reinforced plastic	Fiberglass reinforced plastic
MOUTH: HEIGHT	457 mm (18 in)	457 mm (18 in)	457 mm (18 in)
WIDTH	559 mm (22 in)	559 mm (22 in)	559 mm (22 in)
LENGTH	254 mm (10 in)	305 mm (12 in)	432 mm (17 in)
NET WEIGHT (each)	2.2 kg (6 lbs)	3.6 kg (8 lbs)	4.0 kg (9 lbs)



2352, 2353 & 2354

	2370A	2380A	2382A	2385A	2386A
THROAT SIZE	25 mm (1 in)	49 mm (2 in)	49 mm (2 in)	49 mm (2 in)	49 mm (2 in)
ACCEPTS JBL DRIVERS	2426H/J	2446H/J, 2450H/J, 2485J	2446H/J, 2450H/J, 2485J	2446H/J, 2450H/J, 2485J	2446H/J, 2450H/J, 2485J
NOMINAL DISPERSION	90° H x 40° V	90° H x 40° V	120° H x 40° V	60° H x 40° V	40° H x 20° V
DIRECTIVITY FACTOR (Q) (Averaged)	12.2 (1 kHz - 16 kHz)	10.7 (1 kHz - 16 kHz)	9 (630 Hz - 20 kHz)	19 (1 kHz - 16 kHz)	44.9 (2 kHz - 16 kHz)
DIRECTIVITY INDEX (DI) (Averaged)	10.9 (1 kHz - 16 kHz)	10.3 (1 kHz - 16 kHz)	7.9 (500 Hz - 16 kHz)	12.8 (1 kHz - 16 kHz)	16.5 (2 kHz - 16 kHz)
USABLE LOW FREQ. LIMIT	500 Hz	400 Hz	400 Hz	400 Hz	350 Hz
MIN. RECOM. CROSSOVER	630 Hz	500 Hz	500 Hz	500 Hz	400 Hz
AXIAL PRESSURE SENSITIVITY <sup>1</sup>	110 dB	112 dB	110 dB	114 dB	116 dB
CONSTRUCTION	High density solid polyurethane	Molded structural foam	Molded structural foam	Molded structural foam	High density solid polyurethane
MOUTH: HEIGHT	173 mm (6.81 in)	279 mm (11 in)	279 mm (11 in)	279 mm (11 in)	279 mm (11 in)
WIDTH	445 mm (17.5 in)	445 mm (17.5 in)	445 mm (17.5 in)	445 mm (17.5 in)	445 mm (17.5 in)
LENGTH	174 mm (6.84 in)	236 mm (9.28 in)	236 mm (9.28 in)	236 mm (9.28 in)	359 mm (14.4 in)
NET WEIGHT (each)	1.4 kg (3 lbs)	2.2 kg (6 lbs)	1.62 kg (3.5 lbs)	2.2 kg (6 lbs)	5.5 kg (12 lbs)

<sup>1</sup> Measured on axis in the far field with 1 watt input and referred to 1 meter distance calculated by inverse square law. Listed sound pressure level represents an average from 1 kHz to 4 kHz.

# CINEMA LOUDSPEAKER SYSTEMS

[CINEMA LOUDSPEAKER SYSTEMS]

The history of JBL Cinema Speakers is the history of cinema itself. When a company has a legacy nearly eight decades long, there's little doubt that its ear is planted firmly to the ground. For most of the 20th Century, JBL has been the most trusted name in Cinema sound. In fact, its namesake and founder James B. Lansing began his company building the world's first cinema speakers. That commitment to the core components of cinema speaker design is why, today, JBL Cinema speakers are found in 6 out of 10 movie theaters around the world.

Ever since James B. Lansing developed cinema speakers at the very beginning of talking movies, JBL has consistently set the bar on just how good the movies can sound. That's why the majority of Dolby® equipped cinemas worldwide use JBL loudspeakers. It's also why Lucasfilm engineers chose JBL speakers as the standard with which the first THX® licensed commercial theaters were developed. Unparalleled in experience, technical leadership and customer support: a few reasons why, today, JBL speakers also grace the stages of the most coveted theatrical venues, such as The Academy of Motion Picture Arts and Sciences Samuel Goldwyn Theater, The Directors Guild of America and The Academy of Television Arts and Sciences.

Academy of Television Arts and Sciences: North Hollywood, California

[CINEMA LOUDSPEAKER SYSTEMS]

# ScreenArray® Series

Today's Cinema patron demands perfect coverage in every seat of the auditorium, wide dynamic range and extended bandwidth, as well as inaudible levels of distortion. This dictates the need for a new standard of loudspeaker performance for today's premier cinemas.

The ScreenArray Series represents the embodiment of JBL's continued commitment to the movie cinema industry. As such all models incorporate the latest advances in JBL's research into high performance transducer, waveguide, and crossover designs. Incorporating the performance benefits of JBL's patented Screen Spreading Compensation™ (SSC) and Focused Coverage Technology™, this speaker series provides smooth and uniform timbral balance consistent with current industry listening standards.

Since their introduction, JBL ScreenArray Systems have rewritten the rules for designing premium Cinema loudspeakers. Perhaps that's why you'll find them behind such prestigious screens as the Academy of Television Arts and Sciences Leonard H. Goldenson Theatre, and at the Mann Grauman's Chinese Theatre in Hollywood.

JBL offers three ScreenArray systems to meet the challenges posed by lower cost installations. All three products provide ultra smooth and accurate sound reproduction in a compact and highly cost effective system. The 3622N Passive system, the 4622N Passive system and the 4622 Bi-amplified system feature the ultra-low distortion ScreenArray high frequency horn with SSC and dual 15" low-frequency sections.

## 3622N

The 3622N ScreenArray provides smooth and accurate reproduction of cinema soundtracks in a compact and very cost effective passive system.

The system is comprised of two parts: the 3622N-HF high-frequency pack and the 3639 low-frequency system.

The ScreenArray horn features a patent pending design that compensates for high frequency spreading caused by perforated screens for greatly improved audience coverage. Together, these elements provide clear, accurate reproduction of the mid/high frequency information. All of these components come pre-assembled to reduce field assembly time thus reducing installation costs.

## 4622/4622N

The 4622 and 4622N provide smooth and accurate reproduction of cinema soundtracks in a compact and very cost effective system.

The system is comprised of two parts: the 4622-HF high-frequency pack and the 4639 low-frequency system. The 4622N passive system utilizes a sophisticated crossover network. Developed using computer optimization technology, it provides seamless transition resulting in excellent power response and controlled directivity.

## [SPECIFICATIONS]

	3622N	4622/4622N
FREQUENCY RANGE	30 Hz - 20 kHz	30 Hz - 20 kHz
FREQUENCY RESPONSE	40 Hz - 16 kHz	40 Hz - 16 kHz
COVERAGE ANGLES	90° horizontal, -30°, +20° vertical	90° horizontal, -30°, +20° vertical
RATED MAXIMUM SPL:	127 dB, @ 1 m 133 dB peak	127 dB, @ 1 m 133 dB peak
CROSSOVER FREQUENCIES:	1300 Hz	4622: 630 Hz 4622N: 750 Hz
SENSITIVITY: 2.83V @ 1 m	101 dB	101 dB
NOMINAL IMPEDANCE:	4 ohms	4622: 4 ohms 4622N: HF 8 ohms 4622N: LF 4 ohms
DRIVERS: LF	2 x M115-8A	2 x 2035H-1
HF	2418H-1	2430H
SYSTEM ELEMENTS: LF	3639	4639
MF/HF	3622N-HF	4622-HF [4622N-HF]
DIMENSIONS (H x W x D)	1289 x 762 x 450 mm 50.75 x 30 x 17.75 in	1289 x 762 x 450 mm 50.75 x 30 x 17.75 in
NET WEIGHT	65 kg (143 lbs)	73 kg (160 lbs)



- DESIGNED FOR MAXIMUM OUTPUT, OPTIMAL COVERAGE, AND MINIMUM DISTORTION
- THX® APPROVED (4632T AND 3632T)
- SHIPS FULLY ASSEMBLED
- ULTRA-LOW DISTORTION AND EXTREMELY UNIFORM FREQUENCY RESPONSE
- FLAT-FRONT DESIGN FOR EASY BAFFLEWALL INSTALLATION
- SHALLOW PROFILE FOR MINIMUM DEPTH BEHIND SCREEN (17¾")



Academy of Motion Picture Arts and Sciences Samuel Goldwyn Theater: Hollywood, California

**3632**

**The 3632 ScreenArray**

features true three-way system design enhanced by advanced engineering. JBL Professional's best technical innovations are integrated in a system design that provides superior coverage, maximum power handling, and uniform acoustic power output, along with extremely low distortion. The ScreenArray design provides ideal power response and directivity control with seamless transitions between acoustic sections. The 3632 is available for bi-amplified or tri-amplified operation (3632T).

3632T



4632T

**4632**

**The 4632 ScreenArray**

features true three-way system design enhanced by advanced engineering. JBL Professional's best technical innovations are integrated in a system design that provides superior coverage, maximum power handling, and uniform acoustic power output, along with extremely low distortion. The ScreenArray design provides ideal power response and directivity control with seamless transitions between acoustic sections. The 4632 is available for bi-amplified or tri-amplified operation (4632T).



4632

3632



[CINEMA LOUDSPEAKER SYSTEMS]

[SPECIFICATIONS]

	3632 [T]	4632 [T]
<b>FREQUENCY RANGE</b>	30 Hz - 20 kHz	30 Hz - 20 kHz
<b>FREQ RESPONSE (± 3 dB)</b>	40 Hz - 16 kHz	40 Hz - 16 kHz
<b>COVERAGE ANGLES</b>	90° x 20° up, 30° down	90° x 20° up, 30° down
<b>DIRECTIVITY FACTOR (Q)</b>	10.0	10.0
<b>DIRECTIVITY INDEX (DI)</b>	10 dB	10 dB
<b>MAXIMUM PEAK OUTPUT:</b>	126 dB @ 1 m	129 dB @ 1 m
<b>CROSSOVER FREQUENCIES:</b>	350 Hz [1.2 kHz]	250 Hz [1.2 kHz]
<b>SENSITIVITY: 2.83V @ 1 m</b>	104 dB	106 dB
<b>NOMINAL IMPEDANCE:</b>	4 ohms	4 ohms
<b>DRIVERS: LF</b>	2 x M115H-1	2 x 2035H-1
<b>MF</b>	2 x 165H	4 x 165H
<b>HF</b>	2418H	2425HS
<b>SYSTEM ELEMENTS: LF</b>	3639 [3632T: 4639]	4639
<b>MF/HF</b>	3632-M/HF [3632-M/HF-T]	4632-M/HF [4639-M/HF-T]
<b>DIMENSIONS (H x W x D)</b>	1937 x 762 x 450 mm	2427 x 762 x 450 mm
	76.3 x 30 x 17.75 in	95.6 x 30 x 17.75 in
<b>NET WEIGHT (EACH)</b>	97.7 kg (215 lbs)	120.4 kg (265 lbs)

- THX® APPROVED
- PROVEN HIGH PERFORMANCE AND RELIABILITY
- ADVANCED THREE-WAY DESIGN FOR THE MOST PRESTIGIOUS CINEMAS IN THE WORLD



# Large Format Three-Way Systems

## 5671

Now, smaller auditoriums as well as post-production and dubbing stage environments can each have the benefits of true, JBL three-way performance. **The 5671** features one JBL 2226H 380 mm (15 in) low-frequency transducer in a 5641 LF System and one 5671-M/HF System. (Assembly required.)

## 5672

Auditoriums up to 500 seats, film studios and exhibition venues now have a premium JBL three-way that's a perfect match for them. **The 5672** features a three-way design highlighted by two JBL 2226H 380 mm (15 in) low-frequency transducers as a vertical over-under array in a 4648A LF System, and one 5674-M/HF System, ensuring outstanding performance. Designed for tri-amplification, the bi-amplified 5672-BI is also available.

## 5674

When the world's most prestigious cinemas want the very best, they specify the JBL 5674. **The 5674** is today's most advanced three-way design, featuring an unmatched blend of high performance and unrivaled reliability.

The 5674 features four JBL 2226H 380 mm (15 in) low-frequency transducers in a unique DiamondQuad™ array. This array orientation allows the four drivers to create maximum output, while minimizing destructive interference effects caused by the use of multiple drivers operating in the same bandpass region.

The 5674 requires tri-amplification and includes one 5644 Quad LF System and one 5674-M/HF System. The 5674 has earned THX Approval and is the same system used in The Academy of Motion Picture Arts and Sciences Samuel Goldwyn Theater and The Directors Guild Theater in Los Angeles. The JBL 5674, truly the world's finest three-way loudspeaker.

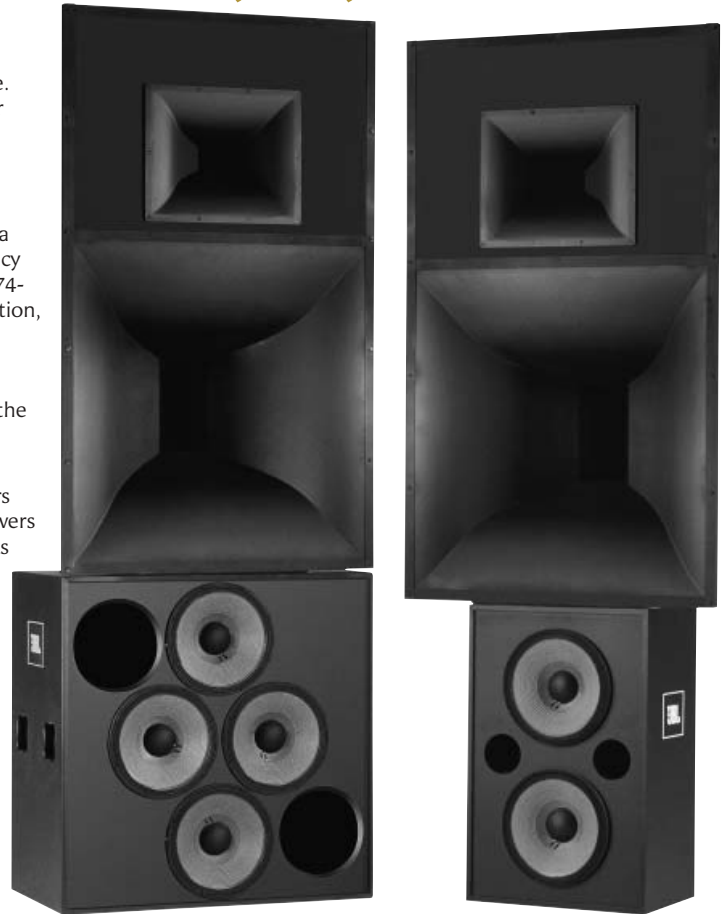

5674

5672

## [SPECIFICATIONS]

	5671	5672	5674
FREQUENCY RANGE	40 Hz - 16 kHz (-10 dB)	35 Hz - 16 kHz (-10 dB)	35 Hz - 16 kHz (-10 dB)
FREQUENCY RESPONSE	50 Hz - 12.5 kHz (± 3 dB)	45 Hz - 12.5 kHz (± 3 dB)	45 Hz - 12.5 kHz (± 3 dB)
COVERAGE ANGLES (H x V)	80° x 50° (300 Hz - 16 kHz)	80° x 45° (300 Hz - 16 kHz)	80° x 45° (300 Hz - 16 kHz)
DIRECTIVITY FACTOR (Q)	10.4	10.4	10.4
DIRECTIVITY INDEX (DI)	11	11	11
MAX. PEAK OUTPUT: (LF/MF/HF)	131/140/137 dB @ 1 m	137/140/137 dB @ 1 m	143/140/137 dB @ 1 m
CROSSOVER FREQ.: LF/MF MF/HF	320 Hz 2.3 kHz	297 Hz 2.5 kHz	297 Hz 2.5 kHz
SENSITIVITY: 1 W, 1 m (LF/MF/HF)	97/114/112 dB	100/114/112 dB	103/114/112 dB
NOMINAL IMPEDANCE: (LF/MF/HF)	8/8/8 ohms	4/8/8 ohms	4 (per driver pair) /8/8 ohms
LF DRIVER(S)	2226H	2 x 2226H	4 x 2226H (2 pair in parallel)
MF DRIVER/MF HORN	2490H/2392-1	2490H/2392	2490H/2392
HF DRIVER/HF HORN	2451H/2332	2451H/2352	2451H/2352
SYSTEM ELEMENTS: LF MF/HF	5641 5671-M/HF	4648A 5674-M/HF	5644 5674-M/HF
DIMENSIONS (H x W x D)	1483 x 774.7 x 736.6 mm 58.375 x 30.5 x 29 in	2768.8 x 1118 x 863.6 mm 109 x 44 x 34 in	2895.6 x 1118 x 863.6 mm 114 x 44 x 34 in
NET WEIGHT (EACH)	80.2 kg (177 lbs)	87.3 kg (192.5 lbs)	171.69 kg (378.5 lbs)



5671

- MAXIMUM VALUE
- MINIMAL SET-UP AND INSTALLATION
- SMOOTH, EVEN COVERAGE
- 3678, 4675C-8LF APPROVED FOR THX® INSTALLATIONS

# Two-Way Systems

## 3677

Combine classic JBL performance with a natural sound quality for both music and dialog and you've just described the **3677**. For extraordinary convenience, the all-in-one enclosure requires no field assembly, simplifying set-up and reducing cost of installation.

## 3678

THX Approved design in the bi-amplified mode. JBL's patented Vented Gap Cooling™ keeps the 2226H low frequency working optimally while the JBL 2342 Bi-Radial® horn and 2426 pure titanium compression driver ensure smooth, even coverage, natural sound and unsurpassed reliability. The **3678** has a 11½" shallow profile.



## 4670D

The **4670D** is a wide bandwidth system with remarkable dynamic range and consistent coverage. In fact, the performance of the 4670D is the foundation for true big-screen commercial cinema sound.

## 4675C & 4675C-4(8)LF

These are the speakers chosen when nothing but the very best in full-range two way systems will suffice. The series delivers uniform frequency response throughout the listening area with high sound pressure levels. The **4675C-4LF** (4 ohms) and **4675C-8LF** (8 ohms) are designed for bi-amplified applications where an external electronic crossover or cinema processor is used in conjunction with separate amplifiers for the high and low-frequency sections.



The **4675C** consists of: one 4638TH System, one 4675C-HFA Kit and built-in passive crossover network. The **4675C-4LF** consists of: one 4648A (LF) System and one 4675C-HFA Kit. The **4675C-8LF** is THX Approved and consists of: one 4648A-8 (LF) System and one 4675C-HFA Kit.



## [SPECIFICATIONS]

	3677	3678	4670D	4675C	4675C-4LF/4675C-8LF
FREQUENCY RANGE	40 Hz - 20 kHz (-10 dB)	30 Hz - 20 kHz (-10 dB)	35 Hz - 20 kHz (-10 dB)	35 Hz - 20 kHz (-10 dB)	35 Hz - 20 kHz (-10 dB)
FREQUENCY RESPONSE	45 Hz - 12 kHz (± 3 dB)	45 Hz - 12 kHz (± 3 dB)	40 Hz - 16 kHz (± 3 dB)	40 Hz - 16 kHz (± 3 dB)	40 Hz - 16 kHz (± 3 dB)
POWER CAPACITY <sup>1</sup>	250 W	300 W	600 W	600 W	1200 W (LF) 100 W (HF)
COVERAGE ANGLES (H x V)	90° x 40°	90° x 90°	90° x 40°	90° x 40°	90° x 40°
CROSSOVER FREQUENCY <sup>2</sup>	1.2 kHz	1 kHz	500 Hz	500 Hz	500 Hz
SENSITIVITY: 1 W, 1 m	99 dB SPL	98 dB SPL	100 dB SPL	100 dB SPL	100 dB SPL (LF)
NOMINAL IMPEDANCE	8 ohms	8 ohms	4 ohms	4 ohms	LF: 4 ohms (4LF)/ 8 ohms (8LF)
LF DRIVER(S)	2035H	2226H	2 x 2035H	2 x 2035H	2 x 2226H (J)
HF DRIVER	2416-1	2425HS	2446H	2446H	2446H
HORN	2373	2342	2380A	2360B W/2506C	2360B W/2506C
SYSTEM ELEMENTS: LF HF	(All-in-one enclosure)	3678-LF 3678-HF	4638TH 4670D-HF	4638TH 4675C-HFA	4648A/4648A-8 (8LF) 4675C-HFA
DIMENSIONS (H x W x D)	765 x 651 x 292 mm 30.125 x 25.625 x 11.5 in	1019 x 651 x 292 mm 40.125 x 25.625 x 11.5 in	1289 x 673 x 438 mm 50.75 x 26.5 x 17.25 in	1797 x 770 x 949 mm 70.75 x 30.312 x 37.375 in	1797 x 770 x 949 mm 70.75 x 30.312 x 37.375 in
NET WEIGHT (EACH)	39 kg (85 lbs)	41 kg (90 lbs)	92 kg (203 lbs)	98 kg (215 lbs)	98 kg (215 lbs)

<sup>1</sup> IEC filtered random noise (50 Hz - 5 kHz) with a crest factor (peak to average ratio) of 6 dB.

<sup>2</sup> Due to standard motion picture recommendations, theater systems with large format compression drivers are specified with 500 Hz crossovers.

# [KEY FEATURES]

Surround Systems

- DESIGNED FOR SMALL, MEDIUM, LARGE AND VERY LARGE VENUES
- SMOOTH, EVEN COVERAGE
- THX® APPROVED

## Surround Systems

### 3310

The **3310** features one 200 mm (8 in) low-frequency driver and a 1 inch titanium dome tweeter. The 3310's internal passive crossover includes a passive protection circuit to ensure maximum reliability. If JBL performance seems incompatible with your budget, consider the 3310 Cinema Surround System. The 3310 offers surprising performance at an equally surprising price.



3310

8330A

### 8330A

The **8330A** three-way features a 200 mm (8 in) low-frequency driver for smooth, extended bass response; a 130 mm (5 in) midrange transducer for the critical midrange and a 25 mm (1 in) titanium-laminate dome tweeter providing wide, even high frequency coverage. Add a modern, molded black textured enclosure with black grille and you know why the 8330A is the industry standard in its class.



### 8340A

The **8340A** Surround speaker is an unbeatable choice when very high power handling, high sensitivity, extended bass response and a remarkably compact cabinet are the requirements. The two-way 8340A's proven reliability and performance have positioned it as the industry standard for the extended dynamic range required by today's digital sound formats. At 19 lbs, installation is quick and painless.



8340A

## [SPECIFICATIONS]

	3310	8330A	8340A
FREQUENCY RANGE (-10 dB)	40 Hz - 20 kHz	40 Hz - 20 kHz	45 Hz - 18 kHz
FREQUENCY RESPONSE (± 3 dB)	100 Hz - 12 kHz	70 Hz - 14 kHz	70 Hz - 16 kHz
POWER CAPACITY <sup>1</sup>	75 W	100 W	250 W
COVERAGE ANGLES (H x V)	100° x 100°	110° x 105°	100° x 80°
CROSSOVER FREQUENCY:	2.5 kHz	650 Hz & 3.1 kHz	2.2 kHz
SENSITIVITY: 1 W, 1 m	89 dB	91 dB	96 dB
NOMINAL IMPEDANCE	8 ohms	8 ohms	8 ohms
DRIVERS: LF	200 mm (8 in)	200 mm (8 in)	250 mm (10 in)
MF		130 mm (5 in)	
HF	25 mm (1 in)	25 mm (1 in)	25 mm (1 in) horn
DIMENSIONS (H x W x D)	446 x 483 x 267 mm	457 x 457 x 260 mm	457 x 457 x 260 mm
	17.5 x 19 x 10.5 in	18 x 18 x 10.25 in	18 x 18 x 10.25 in
NET WEIGHT (EACH)	13 kg (29 lbs)	8.6 kg (19 lbs)	8.6 kg (19 lbs)

<sup>1</sup> IEC filtered random noise (50 Hz - 5 kHz) with a crest factor (peak to average ratio) of 6 dB.



Mann Grauman's Chinese Theatre: Hollywood, California



- EXCEPTIONAL LOW FREQUENCY AUGMENTATION
- APPROVED FOR THX® INSTALLATIONS

# Subwoofers

## 3635

When a small cinema and an equally small budget are the orders of the day, the JBL **3635** is the perfect choice. It features one 460 mm (18 in) transducer, an unobtrusive shallow enclosure (14½"), true JBL performance and a surprising price.

## 4641

When a 600 Watt cinema system is what you need, the **4641** is the perfect choice for cost effective, low frequency augmentation. The 4641 features one 460 mm (18 in) JBL 2241 VGC™ (Vented Gap Cooling) low-frequency transducer. The 4641 is THX® approved.



## 4642A

The **4642A** is a dual 460 mm (18 in) subwoofer system featuring two VGC (Vented Gap Cooling) 2241H low-frequency transducers. This high-performance, cost effective 1200 Watt system is ideal for low-frequency augmentation when smooth response down to the lowest audible frequencies is required. An outstanding performer! The 4642A is THX® approved. Also available with grilles.



## 4645C

Approved by THX®, the **4645C** is the industry standard. The 4645C is a single 460 mm (18 in) direct radiator bass reflex subwoofer system featuring the 2242 SVG™ (Super Vented Gap) low-frequency transducer for highest output with lowest distortion. The 4645C is the choice whenever a premium performance single 460 mm (18 in) 800 Watt system is required for low-frequency augmentation.



[CINEMA LOUDSPEAKER SYSTEMS]

## [SPECIFICATIONS]

	3635	4641	4645C	4642A
FREQUENCY RANGE (-10 dB)	28 Hz - 500 Hz	25 Hz - 500 Hz	To 22 Hz (no EQ)	22 Hz - 500 Hz
FREQUENCY RESPONSE (± 3 dB)	38 Hz - 100 Hz	See individual spec sheet	See individual spec sheet	See individual spec sheet
POWER CAPACITY	300 W	600 W	800 W	1200 W
CROSSOVER FREQUENCY	100 Hz	80 to 150 Hz	80 to 100 Hz	80 to 100 Hz
SENSITIVITY: 1 W, 1 m	100 dB	97 dB (40 - 100 Hz)	97 dB (40 - 100 Hz)	101 dB SPL
NOMINAL IMPEDANCE	8 ohms	8 ohms	8 ohms	4 ohms
LF DRIVER(S)	2042H (18 in)	2241H (18 in)	2242H (18 in)	2 x 2241H (18 in)
DIMENSIONS (H x W x D)	1168 x 651 x 368 mm 46 x 25.625 x 14.5 in	999.6 x 647.7 x 450 mm 39 x 25.5 x 17.75 in	999.6 x 647.7 x 450 mm 39 x 25.5 x 17.75 in	762 x 1219 x 610 mm 30 x 48 x 24 in
NET WEIGHT (EACH)	51 kg (113 lbs)	60 kg (131 lbs)	63 kg (138 lbs)	98 kg (216 lbs)

JBL has more experience in designing and building transducers for professional studio monitors than any other company. We not only use the latest engineering and design equipment, but also the most important test device of all, the human ear. We believe in physics, not fads, so while other companies pick parts off somebody else's shelf, we create our components from scratch. And by utilizing more than 50 years of experience in transducer design, we create the perfect transducer for each system.

In the great tradition of JBL Studio Monitors, we are pleased to introduce the LSR Series—the latest in transducer and system technology combined with recent breakthroughs in psychoacoustic research to provide a more accurate studio reference.

The Linear Spatial Reference (LSR) philosophy is based on a set of design goals that carefully control the overall performance of the system in a variety of acoustic spaces. Instead of focusing on a simple measure such as on-axis frequency response, LSR designs require much better control over dispersion via transducer selection and crossover design. Critical decisions of image placement, EQ, balance and timbre are typically made within  $\pm 30^\circ$  horizontally and  $\pm 15^\circ$  vertically. This workspace is where the engineer, producer and artist make critical mixing decisions and this is the area in which LSR is optimized for superb room response. By incorporating LSR into the system design requirements, placement rules are relaxed, a more stable image is maintained and off-axis coloration is minimized.



# LSR Studio Monitor Systems



**No Off the Shelf Parts. No Off the Shelf Thinking.** The JBL LSR Monitors are, quite literally, just that. Highlighted by a long list of performance-tailored components and customer-inspired features, they're like no other systems on the market today. The entire line, including the new LSR25P compact monitor, is a technical triumph; resulting in new standards and performance levels for a rapidly emerging multi-channel recording industry.

**Performance-Tailored Components.** Revolutionary transducer designs, optimized network topologies and innovative materials are some of the reasons why the LSR line is being hailed as 'the world's most advanced monitor'. JBL's Differential Drive® woofer permanently dispels the notion that better linearity, higher power handling and greater dynamic accuracy are somehow an unobtainable, evil triangle. Dynamic braking produces truly accurate bass at higher SPL's with maximum reliability.

Composite materials, including Carbon Fiber in the woofer as well as Titanium and Kevlar® in the high and mid frequency components, insures performance that is always optimally maintained.

**Not Just A Better Spec... A Better Monitoring System.** While all companies boast about their specifications, JBL went one step further. To guarantee that every component of the LSR family worked together for optimal performance, LSR development employed JBL's unique 'system-engineered' design philosophy. Simply put: the entire line was researched and refined as one, with an overall performance goal in sight. What this means to you is a monitor and subwoofer that work together as a system; delivering stunningly uniform and accurate performance in both stereo and multi-channel applications.

## DIFFERENTIAL DRIVE

The launch of the LSR line is highlighted by the single most significant advance in monitor history, JBL's patented Differential Drive Technology. Providing unparalleled performance, the woofer permanently dispels the notion that better linearity, higher power handling and greater dynamic accuracy are mutually exclusive. JBL's Differential Drive uses two drive coils with twice the thermal surface area of traditional speakers. As a result, LSR systems provide higher peak output with less power consumption. This reduces spectral shift that causes monitors to sound different when driven at different power levels, a long standing obstacle in monitoring technology. By reducing the negative thermal related effects, LSR monitors sound the same at low, medium and high levels.



## 053ti HIGH FREQUENCY TRANSDUCER

The high frequency device is a 1-inch composite diaphragm integrated with an Elliptical Oblate Spheroidal (EOS) Waveguide with 60° x 100° dispersion. The Mid and High devices are mounted within millimeters of each other on a cast aluminum sub baffle that can be rotated for horizontal or vertical placement. This gives maximum flexibility in placement to reduce console and ceiling splash that destabilizes imaging and depth.

## 252G LOW FREQUENCY TRANSDUCER

The neodymium 12-inch woofer is based on JBL's patented Differential Drive technology. With the neodymium structure and dual drive coils, power compression is kept to a minimum to reduce spectral shift as power levels increase. An added third coil between the drive coils acts as a dynamic brake to limit excess excursion and reduce distortion at the highest levels. The cone is made of a carbon fiber/polypropylene composite forming a rigid piston supported by a soft butyl rubber surround.

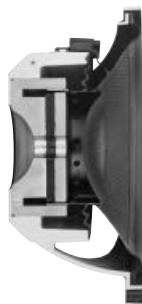

## C500G MIDRANGE TRANSDUCER

The midrange is a 2-inch neodymium motor with a 5-inch woven Kevlar cone. The powerful motor structure was chosen to support the low crossover point to the woofer. In order to achieve the goal of accurate spatial response the crossover points are located at 250 Hz and 2.2 kHz. These

transition points match the directivity characteristics of the three transducers, for optimum spatial response.

## CARBON FIBER COMPOSITE CONE

## DUAL TOP PLATE

## DYNAMIC BRAKE COIL

## NEODYMIUM MAGNET

## ALUMINUM DIECAST HEATSINK

## DUAL DRIVE COILS

## DIECAST FRAME

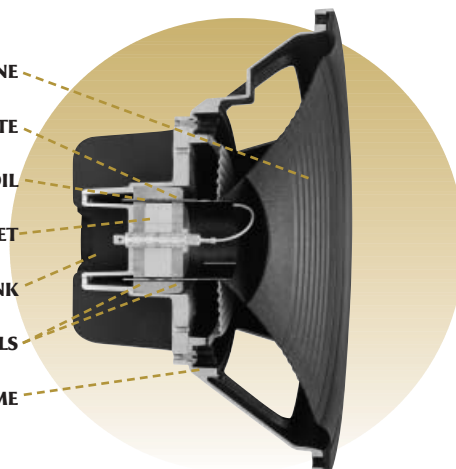

# [KEY FEATURES]

LSR Studio Monitors

- THX® APPROVED
- ACCURATE SPATIAL RESPONSE
- HORIZONTAL OR VERTICAL PLACEMENT
- PATENTED DIFFERENTIAL DRIVE® TECHNOLOGY

# LSR Studio Monitor Systems

## LSR25P

The **LSR25P** Bi-Amplified Monitor System is sized to provide an extremely accurate reference for workstations, edit suites and small control rooms. The 5.25" woofer is based on JBL's research and field proven experience in low distortion, high excursion designs. The motor structure incorporates Symmetrical Field Geometry (SFG). The high excursion capability provides a substantial increase in dynamic range over typical transducer design. A cast aluminum basket provides advanced heat dissipation for low power compression. The entire enclosure is diecast aluminum and acts as a heatsink for the amplifiers and transducers. The structure is shielded for use within close proximity of video monitors.

## LSR28P

The **LSR28P** Linear Spatial Reference Bi-Amplified Studio Monitor System features the 218F low-frequency transducer, an 8" woofer based on JBL's patented Differential Drive technology. The cone is made of a carbon fiber/polypropylene composite forming a rigid piston supported by a soft butyl rubber surround. The LSR28P, like the LSR32, features the 053ti high frequency transducer. The integrated bi-amplified power system and active crossover network are optimized for system performance and includes active circuitry for level calibration and frequency response adjustment.



## LSR32

The **LSR32** Linear Spatial Reference Studio Monitor System features the 252G low-frequency transducer, a neodymium 12" woofer based on JBL's patented Differential Drive technology. The cone is made of a carbon fiber/polypropylene composite forming a rigid piston supported by a soft butyl rubber surround. The midrange transducer, the C500G, is a 2" neodymium magnet structure with a woven 5" Kevlar cone. The 053ti high frequency transducer is a 1" composite diaphragm integrated with an Elliptical Oblate Spheroidal (EOS) Waveguide with 60° x 100° dispersion, critical to the smooth spatial response required in today's working environments.



The mid and high frequency devices of the LSR32 are mounted on a sub-baffle that can be rotated for horizontal or vertical placement. The dividing network is designed with optimum performance componentry and is user-adjustable above 3 kHz to compensate for the effects of near-field and mid-field spectral balance.

## LSR12P

The **LSR12P** Linear Spatial Reference Powered Subwoofer System operates as a companion to the LSR32, LSR28P and LSR25P. The LSR12P is multi-channel compatible for ProLogic, AC-3, DTS and other multi-channel formats. This system features the 252F low-frequency transducer, a neodymium 12" woofer based on JBL's patented Differential Drive technology. The cone is made of a carbon fiber/polypropylene composite forming a rigid piston supported by a soft butyl rubber surround. The integrated 250 W power amplifier provides correct drive levels for optimized frequency response. Bass management for multiple formats is provided with separate left, center and right crossover functions as well as a discrete input.



LSR32



LSR12P



LSR28P



LSR25P

Transport your **LSR25P** easily and safely with the **LSR25P Tote**. This soft carry case has wheels and holds a pair of **LSR25P** monitors.

# [SPECIFICATIONS]

	LSR25P	LSR28P	LSR32	LSR12P
FREQUENCY RANGE (-6 dB)	56 Hz - 22 kHz	37 Hz - 22 kHz	40 Hz - 22 kHz	25 Hz - 110 Hz
POWER	LF: 100 W/HF: 50 W	LF: 200 W/HF: 70 W	200 W (IEC)	250 W
SENSITIVITY	+4 dBu/-10 dBV	+4 dBu/-10 dBV	90 dB (1 W/1 m)	+4 dBu/-10 dBV
DISTORTION (96 dB)	<0.5% <sup>2</sup>	<0.5% <sup>1</sup>	<0.5% <sup>1</sup>	<1.0%
DIMENSIONS (H x W x D)	173 x 269 x 241 mm 6.8 x 10.6 x 9.5 in	406 x 330 x 325 mm 16 x 13 x 12.75 in	635 x 394 x 292 mm 25 x 15.5 x 11.5 in	635 x 394 x 305 mm 25 x 15.5 x 12 in
NET WEIGHT (each)	7.8 kg (17 lbs)	20.5 kg (45 lbs)	21.4 kg (47 lbs)	22.7 kg (50 lbs)

<sup>1</sup> 120 Hz to 22 kHz

<sup>2</sup> 150 Hz to 20 kHz

# 4200 & 4400 Series

## 4200 SERIES



## 4200 SERIES

MODELS: 4206, 4208

**The 4200 Series Monitors** are console-top speakers designed specifically for use in the near field. To provide maximum stereo imaging while reducing the potential for listener fatigue, the pure titanium dome tweeter and cone transducer are aligned to deliver both high and low-frequency information to the listening position at precisely the same instant. Expect smooth extended bass output with less distortion and power compression than competitive systems. The 4206 and 4208 are rated at 8 ohms and are magnetically shielded.

## 4400 SERIES

MODELS: 4408A, 4410A, 4412A

**The 4400 Series Studio Monitors** play a major role in the audio industry. Recording, broadcast, movie and television studios worldwide rely on the 4400 Series monitors as the critical listening source. These industry standards utilize JBL transducer technology with SFG™ magnet structures, large diameter voice coils and a titanium dome tweeter. 4400 Series monitors are sold in mirror imaged pairs.

**The 4408A** with its 8" low-frequency transducer, is a compact two-way system ideal for the smaller recording studio or for broadcast control rooms.

**The 4410A** is a three-way system, with a 10" low-frequency transducer, designed as a vertical line array. This system delivers incredibly fine transient response characteristics and spatial detail.

**The 4412A** is a three-way system ideal for applications requiring maximum low-frequency output from a bookshelf-sized monitor. With its 12" low-frequency transducer and tight transducer complement, the 4412A is a great all-purpose monitor for any application.



## [SPECIFICATIONS]

	4206	4208	4408A	4410A	4412A
FREQUENCY RESPONSE	65 Hz - 20 kHz (± 3 dB)	60 Hz - 20 kHz (± 3 dB)	50 Hz - 20 kHz (± 2 dB)	45 Hz - 20 kHz (± 2 dB)	45 Hz - 20 kHz (± 2 dB)
POWER CAPACITY	75 W (IEC)	75 W (IEC)	100 W (IEC)	125 W (IEC)	150 W (IEC)
SENSITIVITY: 1 W, 1 m	87 dB SPL	89 dB SPL	89 dB SPL	90 dB SPL	89 dB SPL
NOMINAL IMPEDANCE			8 ohms	8 ohms	8 ohms
CROSSOVER FREQUENCY	2.8 kHz	2.6 kHz	2.5 kHz	900 Hz, 4 kHz	850 Hz, 4 kHz
TRANSDUCERS: LF	165 mm (6.5 in)	200 mm (8 in)	200 mm (8 in)	250 mm (10 in)	300 mm (12 in)
MF				125 mm (5 in) cone	125 mm (5 in) cone
HF	25 mm (1 in)	25 mm (1 in)	25 mm (1 in)	25 mm (1 in)	25 mm (1 in)
DIMENSIONS (H x W x D)	390 x 229 x 241 mm	451 x 286 x 229 mm	438 x 305 x 293 mm	597 x 362 x 286 mm	362 x 597 x 286 mm
NET WEIGHT (each)	6.8 kg (15 lbs)	9.3 kg (20.5 lbs)	12 kg (26 lbs)	19 kg (43 lbs)	21 kg (47 lbs)



# Digital Signal Processing

The DSC260A Two Channel Digital System Controller provides programmable crossover, equalization and signal delay functions. The **DSC260A** provides two inputs and six outputs that can be assigned to either or both inputs. Performance includes a low noise floor, smooth amplitude response and maximum dynamic range. Typical applications include stereo three way systems or delay tower operation.

## KEY FEATURES: DSC260A

### Comprehensive crossover

- 12, 18, 24 or 48 dB/octave crossover filters
- Butterworth or Linkwitz-Riley slope topologies
- Mid-filter type limiters with variable threshold

### Up to 600 ms signal delay

### Up to 30 bands of assignable Parametric EQ

### Convenient storage and recall

- 60 user defined presets
- Remote MIDI recall

### Pre-configured for JBL systems

- Sound Power Series
- Cinema 5000 Series
- Array Series
- SR-X and SR-X/F

## [SPECIFICATIONS]

	DSC260A
CONFIGURATION	Stereo 2 and 3 way, Mono 4, 5 and 6 way
INPUTS	2 channels, +20 dBu max. level, 10kOhms, Electronically balanced XLR connectors
OUTPUTS	6 channels, +10 dBu into 600 Ohms max. level, Electronically balanced XLR connectors
DISPLAY	2 x 16 character backlit LCD
SAMPLING RATE	48 kHz
FREQUENCY RESPONSE	20 Hz - 20 kHz (<math>\pm 0.5\text{ dB}</math>)
THD	<math>< .05\%</math>, 20 Hz - 20 kHz @ +10 dBu
DIMENSIONS (H x W x D)	44.4 x 483 x 203 mm 1.75 x 19 x 8 in
NET WEIGHT (each)	2.8 kg (6.2 lbs)

# EASE v4.0

**EASE v4.0 is an acoustic simulation software program designed for the Windows operating system that provides sound system designers an invaluable tool for predicting the performance of a sound system in a given venue. The software program is primarily geared toward large-room acoustics (churches, stadiums, arenas, theaters, etc.) and with additions to v4.0 offers valuable tools for smaller environments such as Privacy indexes for office spaces, etc.**

It includes numerous acoustical design and analysis tools for Contractors, Engineers and Acoustical Consultants, and with the new Vision module offers greatly improved visual rendering capabilities with the ability to add light sources and import surfaces, making it very desirable for the Architectural world. All features of EASE 4.0 are available as a block, or as partial options. As before, licensing is effected by means of a License Key; however, contrary to the procedure known from version 3.0, this can be obtained directly via the Internet immediately after installation of the program. Program updates can be downloaded directly from the Internet, as well.

Special features of EASE 4.0 for Windows:

- Enhanced user-friendly windows for menus and working surfaces allow direct access to the various program modules and program parameters
- Ample Speaker Data format of 5 Degrees and 1/3-Octave resolution, higher resolutions of up to 1 Degree and 1/24-Octave bandwidth can be stored in DLLs and used for calculations
- Introduction of complex Speaker Data including magnitude and phase, direct reading of measured impulse responses in all common measuring-file formats (TEF20, MLSSA, WAVE, MF)
- Provision of Speaker-DLLs for Line-Arrays
- Cluster calculation modules for speaker assemblies for far-field applications, DLLs for near-field and far-field calculations
- Data format of wall materials expanded to include diffusion coefficient
- Improved and simplified entering of room data, no limitation of model components, newly developed DXF import from AutoCAD 3D volume models, and entering of textures

- Simplified Room Modeling thanks to new Tools like expanded Extrude function and Object definition for partial models
- Room Visualization by high-definition rendering technique and with textures
- New Hide Option as 3D Rendering by means of lighting appliances
- New room-acoustical calculating module AURA based on CAESAR (University of Aachen) offers new and expanded tools and indexes not available in v3.0
- 2D and 3D Mapping of all room-acoustical measures according to ISO 3382 with due application of the expanded Wall Material data base (absorption and diffusion)
- New Ray-Tracing options in AURA, like Echogram and AURA-Response
- Better visualization of impulse response computations
- New Predicted Tail computation for obtaining a complete impulse response
- Expanded features of off-line and online (real time) Auralization in EARS

- Real time auralization remains possible without additional hardware and in dual channel operation
- Storage capacity limited only by the actual hardware layout

EASE 4.0 for Windows is totally compatible with EASE 3.0 and is capable of reading all EASE loudspeaker and project data files and of converting them into the new format. Current EASE 3.0 users will be able to upgrade to version 4.0 for a nominal upgrade charge. A Pentium-III-Processor with 1000 Hz or more is recommended as a minimum not only for meeting the requirements of auralisation. EASE is supplied on CD-ROM and requires at least 128 MB of RAM plus 150 MB of available hard disk space (without database, which requires 100 MB additionally).

Like Version 3.0, EASE 4.0 is a 32-bit program capable of functioning with the operating systems Windows 98/NT/2000/XP. Windows 95 can no longer be recommended, since it requires special adjustments and Service Packages. All features of EASE 3.0 were included in the new version.

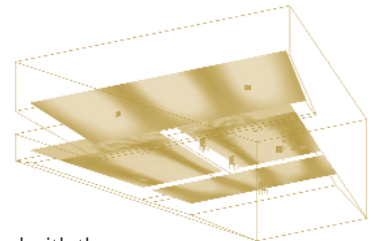

# Product Index

Product . . . . .	Page	4622 . . . . .	42	AM4212/00, 64 & 95 . . . . .	14	EVOi.324 . . . . .	10	PD128 . . . . .	16
2012H . . . . .	37	4622N . . . . .	42	ASB4128 . . . . .	15	EVOi.net . . . . .	10	PD162 . . . . .	16
2020H . . . . .	37	4632 . . . . .	43	ASB6118 . . . . .	15	EVOi.sys . . . . .	10	S.A.F.E. Hardware . . . . .	22
2142H . . . . .	37	4638 . . . . .	45	ASB6128 . . . . .	15	LSR12P . . . . .	50	SF12M . . . . .	25
2152H . . . . .	37	4641 . . . . .	47	ASB6128V . . . . .	15	LSR25P . . . . .	50	SF15 . . . . .	25
2206H . . . . .	37	4642A . . . . .	47	ASH6118 . . . . .	15	LSR28P . . . . .	50	SF25 . . . . .	25
2226H/J . . . . .	37	4645C . . . . .	47	CCS6000 . . . . .	4	LSR32 . . . . .	50	SF22SP . . . . .	25
2241H . . . . .	37	4648A . . . . .	45	Control 19CS/19CST . . . . .	3	MP212 . . . . .	26	SMS1 . . . . .	7
2242H . . . . .	37	4670D . . . . .	45	Control 1 . . . . .	8	MP215 . . . . .	26	SP222 . . . . .	9
2352 . . . . .	40	4675C . . . . .	45	Control 23/23T . . . . .	4	MP225 . . . . .	26	SP225-6 . . . . .	9
2353 . . . . .	40	4675C-4LF . . . . .	45	Control 24C/24CT . . . . .	3	MP255S . . . . .	26	SP225-9 . . . . .	9
2354 . . . . .	40	4675C-8LF . . . . .	45	Control 24C/24CT Micro . . . . .	3	MP410 . . . . .	26	SR-X Covers . . . . .	35
2370A . . . . .	40	4890A . . . . .	22	Control 24CT MicroPlus . . . . .	3	MP412 . . . . .	26	SR4702X . . . . .	35
2380A . . . . .	40	4892A . . . . .	22	Control 25/25T . . . . .	4	MP415 . . . . .	26	SR4715X-1 . . . . .	35
2382A . . . . .	40	4892A-90 . . . . .	22	Control 25AV . . . . .	4	MP418S . . . . .	26	SR4718X . . . . .	35
2385A . . . . .	40	4893A . . . . .	22	Control 26C/26CT . . . . .	3	MP418SP . . . . .	26	SR4719X . . . . .	35
2386A . . . . .	40	4894A . . . . .	22	Control 26-DT . . . . .	3	MS125S . . . . .	9	SR4722X/F . . . . .	35
2402H . . . . .	38	4894A-90 . . . . .	22	Control 28/28T-60 . . . . .	4	MS26 . . . . .	9	SR4725X/F . . . . .	35
2404H . . . . .	38	5641 . . . . .	44	Control 29AV . . . . .	4	MS28 . . . . .	9	SR4726X/F . . . . .	35
2405H . . . . .	38	5644 . . . . .	44	Control 30 . . . . .	4	MTC-1A . . . . .	8	SR4731X/F . . . . .	35
2426H/J . . . . .	38	5671 . . . . .	44	Control 5 . . . . .	8	MTC-51 . . . . .	8	SR4732X/F . . . . .	35
2446H/J . . . . .	38	5672 . . . . .	44	Control SB-2 . . . . .	4	MTC-52 . . . . .	8	SR4733X/F . . . . .	35
2447H/J . . . . .	38	5674 . . . . .	44	Control SB210 . . . . .	4	MTC-8 . . . . .	8	SR4735X/F . . . . .	35
2450H/J . . . . .	38	8330A . . . . .	46	Custom Shop . . . . .	17	MTC-CM Series . . . . .	4	SS2-BK . . . . .	30
2451H/J . . . . .	38	8340A . . . . .	46	DSC260A . . . . .	52	MTC-H Series . . . . .	4	SS3-BK . . . . .	26
2509A . . . . .	40	AL6115 . . . . .	15	EASE . . . . .	52	MTC-MR . . . . .	3	VT Accessories . . . . .	21
3310 . . . . .	46	AL6125 . . . . .	15	E-System 10 . . . . .	32	MTC-NC . . . . .	3	VT4880 . . . . .	19
3622N . . . . .	42	AM4200/64 & 95 . . . . .	14	E-System 15 . . . . .	32	MTC-PC2 . . . . .	4	VT4881 . . . . .	19
3632 . . . . .	43	AM4315/64 & 95 . . . . .	14	EON 1500 . . . . .	29	MTC-SB2 Series . . . . .	4	VT4887 . . . . .	19
3635 . . . . .	47	AM6315/64 & 95 . . . . .	14	EON 15P-1 . . . . .	29	MTC-SSG . . . . .	4	VT4888 . . . . .	19
3677 . . . . .	45	AM6340/64 & 95 . . . . .	14	EON G2 Accessories . . . . .	30	MTC-TR . . . . .	3	VT4889 . . . . .	19
3678 . . . . .	45	AM6200/64 & 95 . . . . .	14	EON10 G2 . . . . .	30	MTC-UB . . . . .	4	Z21S . . . . .	6
4206 . . . . .	51	AM6215/64 & 95 . . . . .	14	EON15 G2 . . . . .	30	MTC-V Series . . . . .	4	Z32S . . . . .	6
4208 . . . . .	51	AM6212/00, 64 & 95 . . . . .	14	EONSUB G2 . . . . .	30	MTC-WMG . . . . .	4	Z-M1 . . . . .	6
4408A . . . . .	51	AC2215/00, 64 & 95 . . . . .	15	EVO DCI . . . . .	10	PD743 . . . . .	16	Z-M2 . . . . .	6
4410A . . . . .	51	AC2212/00, 64 & 95 . . . . .	15	EVO HS-1 . . . . .	11	PD764 . . . . .	16	ZR-V . . . . .	6
4412A . . . . .	51	AM4215/64 & 95 . . . . .	14	EVO WM300 . . . . .	11	PD125 . . . . .	16		

## JBL LIMITED WARRANTY

The JBL Warranty on professional loudspeaker products (except for enclosures) remains in effect for five years from the date of the first consumer purchase. JBL amplifiers are warranted for three years from the date of the original purchase. Enclosures and all other JBL products are warranted for two years from the date of the original purchase.

Your JBL Warranty protects the original owner and all subsequent owners as long as: A.) Your JBL product has been purchased in the Continental United States, Hawaii or Alaska. (This Warranty does not apply to JBL products purchased elsewhere except for purchases by military outlets. Other purchasers should contact the local JBL distributor for warranty information.) and B.) The original dated bill of sale is presented whenever warranty service is required.

Except as specified below, your JBL Warranty covers all defects in material and workmanship. The following are not covered: Damage caused by accident, misuse, abuse, product modification or neglect; damage occurring during shipment; damage resulting from failure to follow instructions contained in your Instruction Manual; damage resulting from the performance of repairs by someone not authorized by JBL; claims based upon any misrepresentations by the seller; any JBL product on which the serial number has been defaced, modified or removed. JBL will pay all labor and material expenses for all repairs covered by this warranty.



**JBL**

**PROFESSIONAL**

## JBL PROFESSIONAL AND HARMAN INTERNATIONAL

JBL is the largest brand within Harman International, a \$1.8 billion U. S. corporation listed on the New York Stock Exchange, solely dedicated to professional, consumer, and OEM audio.

JBL's factory is part of the Harman International Business Campus, located in Northridge in the San Fernando Valley of Los Angeles. The 44 acre site comprises all operations of JBL Professional, along with Harman Corporate Engineering activities and other corporate functions.

The factory is constantly upgrading its methods, procedures and work flow, and has received ISO 9002 certification, an important benchmark in the recognition of efficient manufacturing, administration and overall product quality.

All of JBL Professional's transducers are engineered and fabricated at the Northridge facility. Everything except metal casting and plastic molding is done here: all aspects of machining, diaphragm forming, wire milling, voice coil winding, finishing,

assembly and testing are in-house activities, carried out by dedicated, quality-oriented personnel. JBL has always had a very stable workforce, and many of the factory employees have been with the company for two decades and longer.

All JBL Professional loudspeaker enclosures are constructed on-site from components produced in JBL's extensive wood mill. Final assembly is done in the JBL Professional factory. Automated equipment is used extensively for uniformity and efficiency. Innovative techniques in enclosure materials, construction and assembly methods are employed.

JBL Professional has the most rigorous standards for system power rating in the professional loudspeaker industry. Power testing of transducers is an ongoing activity at JBL Professional. Samples from all production lots are tested at full rated power to industry standards to ensure that they meet the rigid performance specifications set for them. This is the professional customer's assurance that JBL's loudspeaker components will continue to perform as expected.

**JBL Professional · 8500 Balboa Boulevard · Northridge, CA 91329 · [www.jblpro.com](http://www.jblpro.com)**

**H** A Harman International Company