

# JBL 6007/6008 INSTALLATION AND SERVICE MANUAL

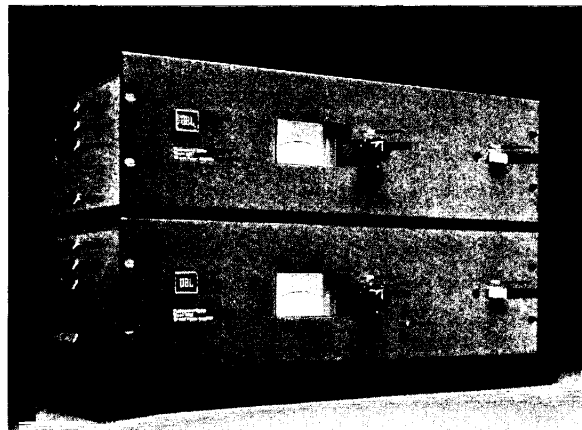

## Owners Instructions

### Architectural Specifications

The amplifier shall be single channel with an input gain control and an output level meter on the front panel. The amplifier shall accommodate an unbalanced high impedance input, or a balanced low impedance input with an optional plug-in accessory transformer.

The amplifier shall be capable of delivering a minimum of 60 W, continuous sine wave, 20 Hz-20 kHz, into a 4  $\Omega$  load. (6007: The amplifier shall incorporate an output transformer allowing full power operation, 35 Hz-20 kHz, into an 8  $\Omega$ , 16  $\Omega$  or 70.7 V line as well as a direct output terminal for a 4  $\Omega$  load.) (6008: No output transformer and only a direct output terminal shall be provided, but it shall be possible to install an output transformer easily at any time.)

The amplifier shall have < 0.2% THD, 20 Hz-20 kHz, @ 60 W, direct output. (6007: The amplifier shall have < 0.2% THD, 35 Hz-20 kHz, @ 60 W, transformer output.) Frequency response shall be  $\pm$  0.5 dB, 20 Hz-20 kHz, @ 1 W. Power bandwidth shall be 10 Hz-40 kHz.

Construction of the amplifier shall be modular. The entire amplifier circuit, except for the power supply (6007: and output transformer) shall be mounted on a single circuit board attached to the heat sink, which assembly shall be removable from the unit with the mainframe still mounted in a rack. Cables connecting the circuit board to the mainframe shall be of a length sufficient to allow removal of the board without disconnection and shall disconnect easily at two plugs. The amplifier shall occupy three standard EIA rack spaces and shall operate on 120/240 V AC, 50/60 Hz.

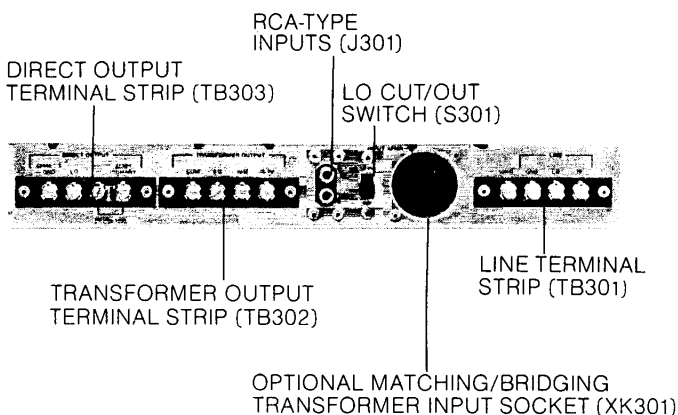
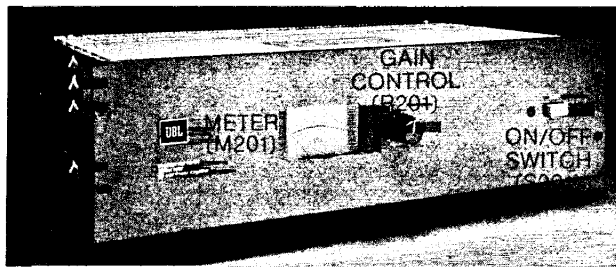

FIGURE 1

## Product Specifications

Model	6008	6007
Power Output <sup>1</sup>		
Direct	60 W	60 W
Transformer	Optional	60 W
Power Bandwidth		
Direct – Full	20 Hz-20 kHz, $\pm$ 0.5 dB	
– $\frac{1}{2}$	10 Hz-40 kHz, $\pm$ 0.5 dB	
Transformer – Full	35 Hz-20 kHz, $\pm$ 1 dB	
THD <sup>2</sup>		
Direct	< 0.2%	
Transformer	< 0.2%	
IM <sup>3</sup>		
Full, 10 W, 0.15 W	< 0.2%	
Load Impedance		
Direct	4 $\Omega$	4 $\Omega$
Transformer (taps)		8 $\Omega$
		16 $\Omega$
		83 $\Omega$
Output Regulation		
Direct	Better than 15%	
Transformer	Better than 15%	
Power Gain	72 dB	
Input Sensitivity		
Unbalanced		
(50 k $\Omega$ )		0.4 V
Balanced <sup>4</sup>		0.27 V
Balanced <sup>5,6</sup>		0.07 V
Signal-to-Noise Ratio <sup>7</sup>	90 dB	
Low-Cut Filter	6 dB/octave below 250 Hz, switchable	
Power Requirements	120/240 V AC, 50/60 Hz	
Power Consumption		
Quiescent	20 W	
$\frac{1}{2}$ Power	105 W	
Full Power	165 W	
Fuse	2 A, 3 AG (120 V)	1 A, 3 AB (240 V)
Maximum Ambient Temp.	60°C (140°F)	
Mounting EIA STD Spaces	3	
Dimensions		
Front Panel	483 x 133 mm (19 x 5 $\frac{1}{2}$ in)	
Depth of Controls	19 mm ( $\frac{3}{4}$ in)	
Depth Behind Panel	325 mm (12 $\frac{3}{4}$ in)	
Net Weight	10.3 kg (22 $\frac{1}{2}$ lb)	12.7 kg (28.0 lb)
Shipping Weight	13.5 kg (29 $\frac{1}{2}$ lb)	15.8 kg (34 $\frac{1}{4}$ lb)
Accessories	JBL 5195 Matching/Bridging Transformer	
	JBL 60-6008 Output Transformer Assembly	

- NOTES: 1. Continuous sine wave.  
 2. Total harmonic distortion at rated output.  
 3. SMPTE standard.  
 4. 600  $\Omega$  or 15 k $\Omega$  with 5195 Matching/Bridging Transformer.  
 5. 600  $\Omega$ , 14 dB step-up configuration.  
 6. Requires internal modification.  
 7. Requires 20 kHz equivalent bandwidth filter.

## Installation

The 6007/6008 is suitable either for rack mounting in three EIA rack spaces without additional bracing or ventilation, or for counter-top placement. A full set of mounting hardware is packed with each unit. All external connections and matching/bridging transformer option are made on the rear panel, Figure 1.

## Operating Temperature

Because the 6007/6008 is cooled by convection, adequate clearance on the top of the unit must be provided to allow heat dissipation. The minimum recommended clearance when stacking the unit is one EIA standard panel space.

A thermal switch in these units provides thermal protection by shutting down the amplifier if the internal temperature exceeds a safe operating level. The maximum allowable ambient temperature for the amplifier is 60°C (140°F).

## Operating Controls

All operating switches, meter and level control are located on either the front panel or the rear panel, Figure 1. Control, meter and switch functions are given in Table 1.

## Input Connections

Input connections to the amplifier may be either direct-coupled or transformer-isolated at the LINE terminal strip, TB301, or the RCA-type phono jacks, J301, Figure 1. Direct-coupling is accomplished by connecting the center conductor of a shielded cable to LO and the shield lead to GND, or to either RCA-type

phono jack. Table 2 lists the terminals and the RCA-type phono jacks and applications of the LINE terminal strip. For transformer-isolated input, a 5195 matching/bridging transformer (Figure 2) must be plugged into the 9-pin receptacle, XK301, Figure 1. The input leads are connected to terminals HI, LO and GND of the LINE terminal strip.

## Output Connections

Table 3 shows the output configurations available.

TABLE 1

<b>Gain</b>	Controls input of amplifier. Control is wired ahead of the active circuitry and can be used as an input pad to prevent overloading and clipping of the non-inverting operational amplifier stage. NOTE: When the JBL 5195 matching/bridging transformer is used, the gain control is across the output of the transformer and therefore cannot be used to prevent input transformer saturation if excess input levels occur.
<b>Power Switch</b>	Applies primary power to amplifier.
<b>Meter</b>	Provides approximation of the output level, with +3 indicating that the amplifier is delivering its rated continuous sine wave power into 4 Ω.
<b>Low cut/out</b>	Offers the user a response roll-off of 6 dB per octave below 250 Hz.

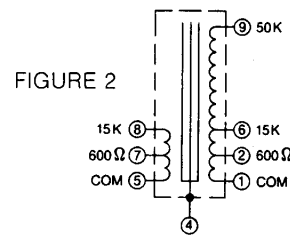

TABLE 2/TABLE 3

Terminals	RCA-Type Phono Jacks	Function	Application	Terminating Resistor	Special Instructions
50 kΩ GND		Direct Coupled	For unbalanced high impedance (50 kΩ) sources	— none —	
	"A" or "B"			— none —	
HI LO GND		Transformer isolated	Balanced high impedance (15 kΩ) source up to level of +15 dBm (with 5195 matching/bridging transformer)	— none —	
			Balanced 600 Ω source up to level of +15 dBm (with 5195 transformer)	620 Ω, ½ W, connected to terminals "HI" and "LO"	
			Balanced 600 Ω source with up to level of 4 dBm with 14 dB additional gain.	— none —	Internal modification requiring service technician.

Terminals (TB301)	Terminals (TB302)	Impedance	Direct Out	Transformer Out	Link
LO, Chassis GND		4 Ω (20 V)	Yes		None
	8 Ω, COM	8 Ω (28.28 V)		Yes	"HI" to "XFMR Primary"
	16 Ω, COM	16 Ω (40 V)		Yes	"HI" to "XFMR Primary"
	70.7 V, COM	50 Ω		Yes	"HI" to "XFMR Primary"

## Service and Maintenance Instructions

The following procedures are designed to assist in the isolation of malfunctions. The operations described should be undertaken only after an investigation of all external connections and adjustments has indicated, beyond reasonable doubt, that the problem is actually within the amplifier.

**WARNING**  
THIS SECTION OF THE MANUAL  
CONTAINS SERVICE INSTRUCTIONS  
FOR USE BY QUALIFIED SERVICE  
PERSONNEL ONLY.

**WARNING:** Disconnect the amplifier from the power source before performing service operations or replacing components.

### Voltage Conversion

Either amplifier can be operated from either a 120 V AC or 240 V AC, 50/60 Hz source. The line voltage selector terminal strip, TB401, Figure 3, changes the primary connections of the power transformer. Use the following procedure to change the voltage range:

1. Remove the 10 screws which hold the top cover to the chassis.
2. To convert from 120 V AC to 240 V AC, remove the two terminal strip jumpers, Figure 4a. Install one jumper only per Figure 4b.
3. Change the line cord and/or attachment plug to match the supply source receptacle, or use a 120 V to 240 V AC adapter (not provided). The adapter as well as the power supply cord and/or attachment plug used for the 240 V AC mode in the U.S., Canada and Japan shall be both UL Listed and CSA Certified for use with said power source receptacle and wired per Table 4. For use in other countries, adapter, line cord and/or attachment plug selection shall be based on local regulations governing 240 V AC, 50/60 Hz supply sources.
4. Change the line fuse from a 2A, 3AG type to a 1A, 3AB.

FIGURE 4A

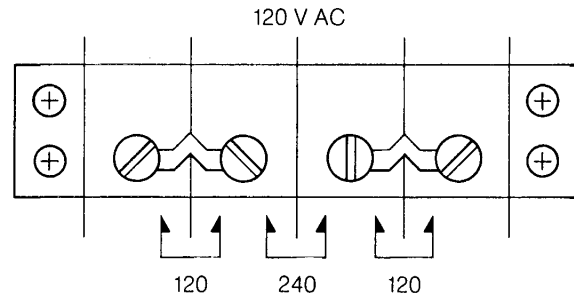

FIGURE 4B

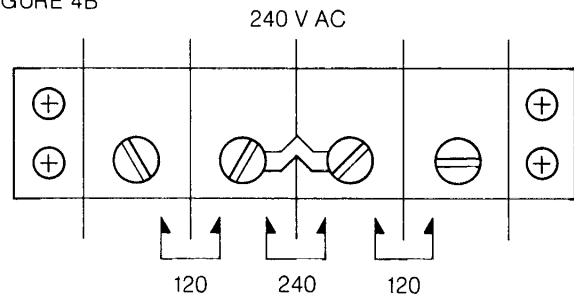

FIGURE 3

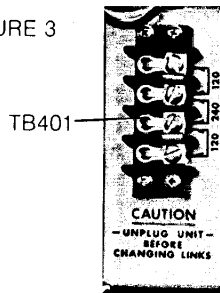
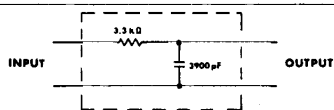

TABLE 4

Country	Wire Color Code	Line Cord Connections		
		Terminal Strip (TB401)	Fuse Holder (Center Terminal)	Ground Lug (Figure 3)
U.S., Canada and Japan	Black	—	Attached	—
	White	Attached	—	—
	Green	—	—	Attached
Europe	Blue	—	Attached	—
	Brown	Attached	—	—
	Green/Yellow	—	—	Attached

Instrument Type	Required Characteristic	Recommended Instrument
Test Oscillator	Frequency Range: 20 Hz - 20 kHz Distortion: <0.001% Output: 1 V RMS Min.	Sound Technology Model 1700 A
Distortion Analyzer	Measurable to 0.002%	Sound Technology Model 1700 A
Multimeter	Accuracy: 0.1% reading + 1 digit DC Range: $\pm 199.9$ mV to $\pm 1199$ V Resistance: $\pm 0.2\%$ of reading + 1 digit Input Impedance: 10 M $\Omega$	Fluke Model 8000A
Output Load Resistors	100 W, 4 $\Omega$ and 8 $\Omega$ Non-Inductive Type, 1%	Dale NH-100
Resistor Decade Box	1 $\Omega$ - 1 k $\Omega$ Min.	
Variable Autotransformer	Capable of supplying Min. of 500 W over a range of 90 - 136 V. 1. If autotransformer does not have an AC voltmeter to indicate output voltage, monitor the output with either a multimeter or AC voltmeter. 2. If autotransformer does not have a watt meter, a watt meter capable of indicating 15 - 270 W will be required.	GenRad W5MT3W

20 kHz Equivalent  
Bandwidth Filter



### Recommended Test Equipment

The following test procedures are required after an IC, driver transistor, bias network diode, thermistor, or output device is replaced:

### Bias Adjustment

Verify that the distortion at 20 kHz, 60 W, is the same as 20 kHz at 1 W and that the stable idle power is 15 - 20 W. If not, the following procedure is required:

1. Substitute resistor R37 with a decade box.
2. Adjust the amplifier for 1 W at 20 kHz.
3. Adjust the decade for minimum distortion and substitute R37 with the closest EIA standard resistor.
4. Verify distortion at 60 W and 1 W.

NOTE: Amplifier must be warm before performing distortion measurements or adjustments.

### DC Offset Adjustment

Connect the multimeter to test point #2 on the circuit board. With the meter set at the lowest DC voltage range (mV), adjust the DC NULL control, R10, for a minimum DC voltage,  $0 \pm 25$  mV.

NOTE: Amplifier must be warm before making adjustments.

### Installation of Optional Output Transformer

(option on 6008)

To install the optional output transformer, Figure 5, Model No. 60-6008:

1. Remove the heat sink/circuit board assembly.
2. Place the optional output transformer in the corner of the chassis and secure it at the four holes in the bottom of the chassis with the hardware provided.

3. Attach the Molex connector to the mating connector of the amplifier.
4. Remove the cover over the cutout for the TRANSFORMER OUTPUT terminal strip. Slip the new terminal strip of the output transformer through the cutout and orient it so that the GRAY wire is the COM. Screw the terminal strip in place with the screws that held the cover.

NOTE: If the output transformer is to be used, install a LINK between LO and HI of the DIRECT OUTPUT terminal strip, Figure 1.

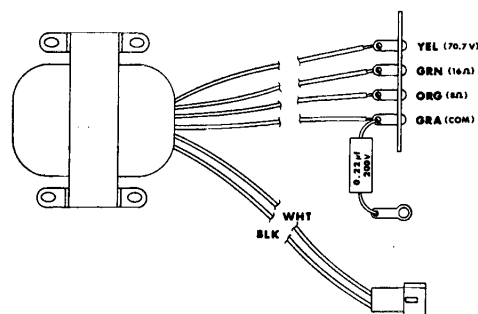

### 14 dB Additional Gain Conversion

14 dB of additional input sensitivity, using the optional JBL Model 5195 matching/bridging transformer, can be offered to the user by removing the RED wire connected to pin #8 of the 9-pin receptacle, XK301, and reconnecting it to pin #7.

Performance plot of a typical unit

**WARNING**  
THIS SECTION OF THE MANUAL  
CONTAINS SERVICE INSTRUCTIONS  
FOR USE BY QUALIFIED SERVICE  
PERSONNEL ONLY.

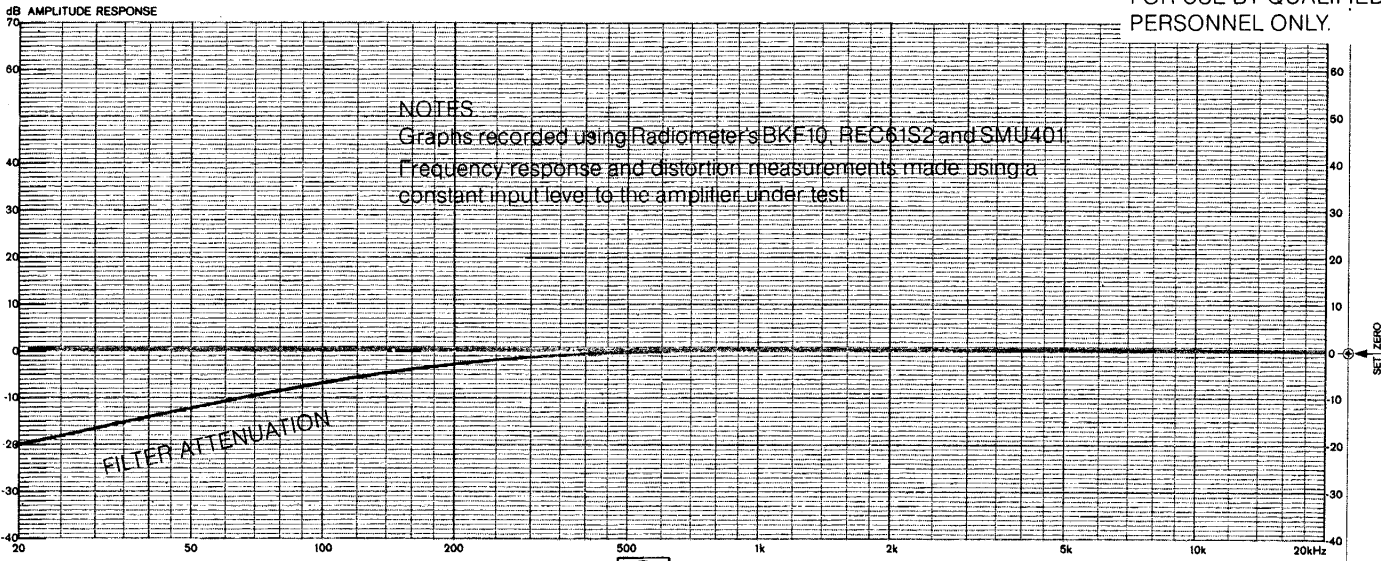

NOTES  
Graphs recorded using Radiometer's BKF10, REC61S2 and SMU401  
Frequency response and distortion measurements made using a  
constant input level to the amplifier under test

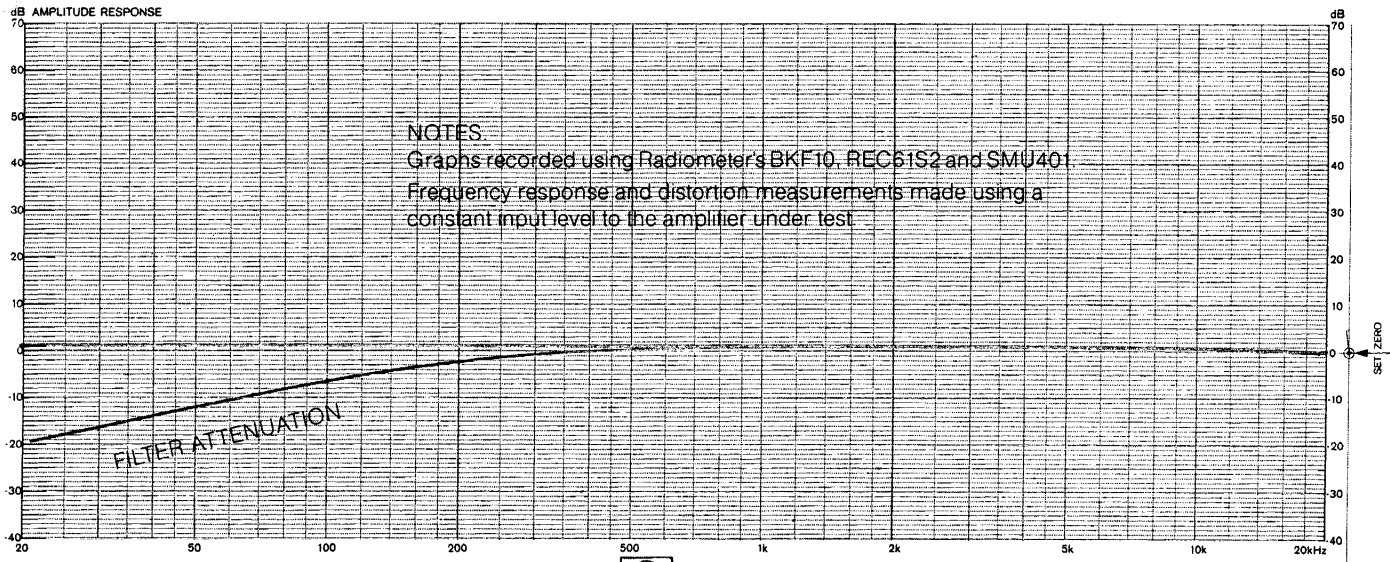
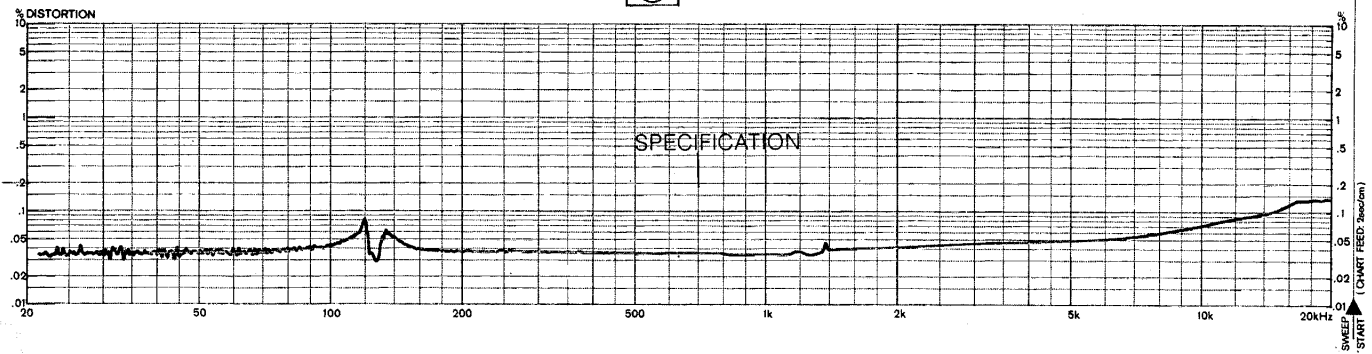
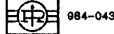

NOTES  
Graphs recorded using Radiometer's BKF10, REC61S2 and SMU401  
Frequency response and distortion measurements made using a  
constant input level to the amplifier under test

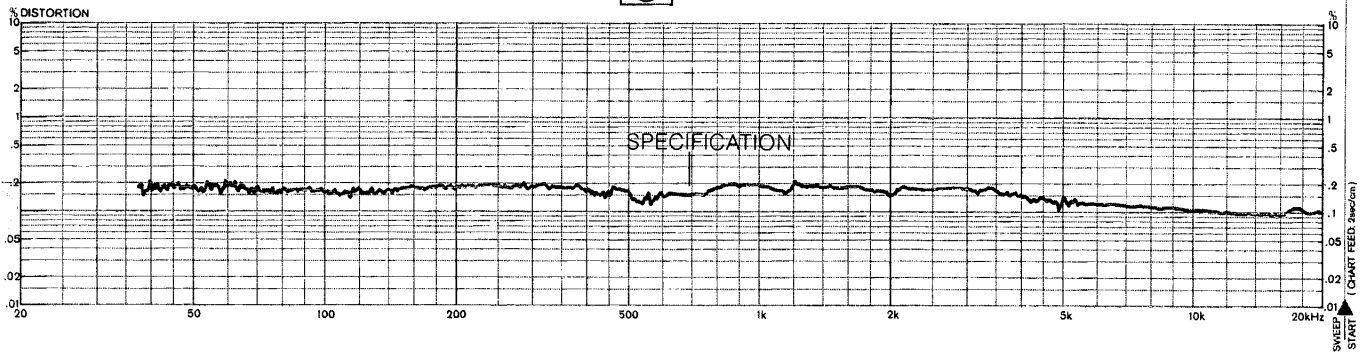
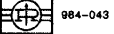

**RADIOMETER  
COPENHAGEN**

Measuring object: 6007  
60 M. 1. 0

Rec. no.:  
Date: 7/21/78  
Sign: Matsbetin

**RADIOMETER  
COPENHAGEN**

Measuring object: 6007  
60 M. 1. 0

Rec. no.:  
Date: 7/21/78  
Sign: Matsbetin

**WARNING**  
 THIS SECTION OF THE MANUAL  
 CONTAINS SERVICE INSTRUCTIONS  
 FOR USE BY QUALIFIED SERVICE  
 PERSONNEL ONLY.

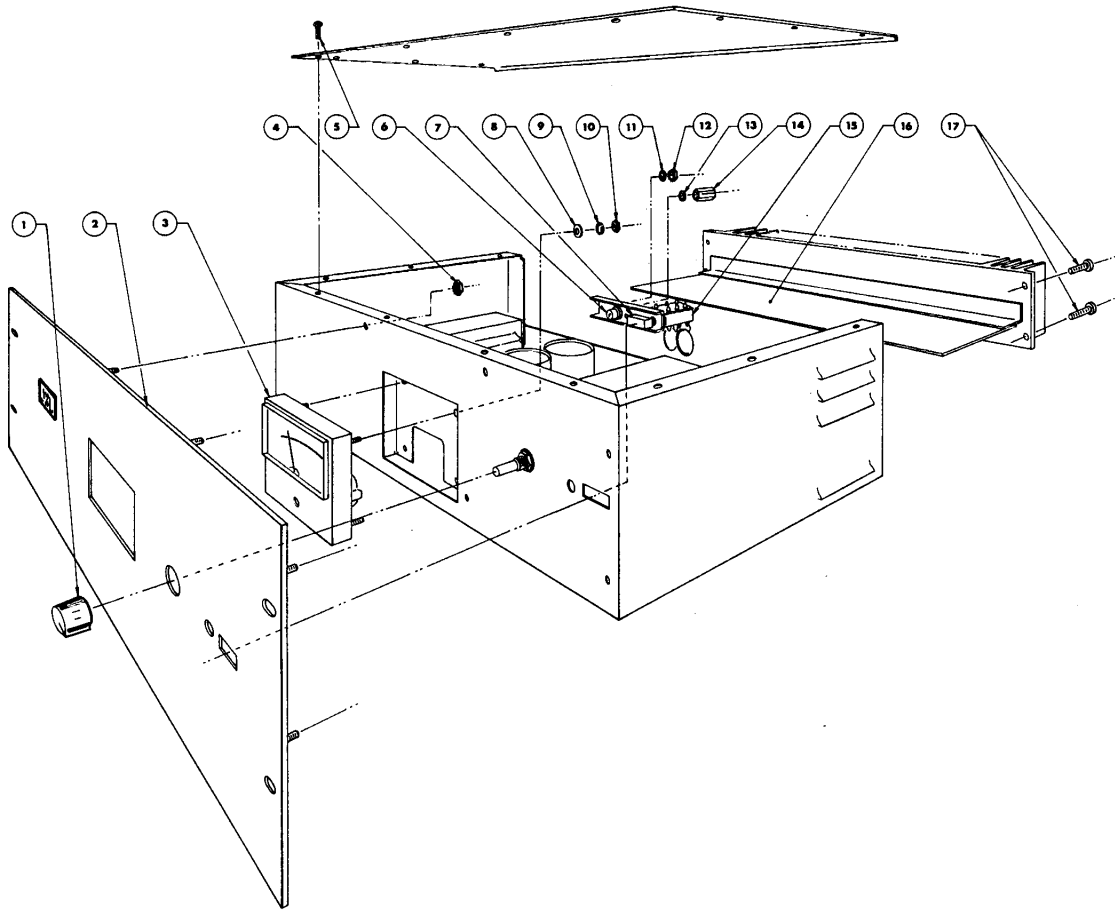

Item	JBL Part No.	Qty.	Description
1	52886	1	knob
2	55651	1	panel
3	55098	1	meter
4	51580	7	10-32 Keps <sup>3</sup>
5	10997	10	4-40 x 1/4 Phillips-head machine screw
6	54959	1	lamp
7	54969	1	knob
8		4	3 mm <sup>1</sup>
9		4	3 mm <sup>1</sup>
10		4	3 mm <sup>1</sup>
11		1	<sup>2</sup>
12	89508	1	10-32 Keps <sup>2</sup>
13	11908	1	No. 6 inter-tooth washer
14	54968	1	6-32 hex spacer
15	55523	1	switch
16	55039	1	power amplifier board
17	55153	4	6-32 x 1/2 hex washer head screw

\*NOTES: 1. No JBL replacement for the 3 mm set.

2. Unit may have either a Keps nut, Keps nut and washer or Keps nut, split washer and flat washer.

3. Keps nut locked to panel stud with Loctite.

Circuit Description	JBL Part No.	Description		
<b>CAPACITORS</b>				
All capacitors are in $\mu$ F unless otherwise noted.				
C1	47795	5	35 V	
C2	48504	100	25 V	
C3	56153	0.1	100 V	
C4	56153	0.1	100 V	
C5	47795	5	35 V	
C6	48447	68 pF	500 V	Mica
C7	48429	10 pF	500 V	Mica
C8	47795	5	35 V	
C9	36188	22/25	25 V	
C10	55172	330	4 V	
C11	55172	330	4 V	
C13	48459	220 pF	500 V	Mica
C14	47795	5	35 V	
C15	47795	5	35 V	
C16	48459	220 pF	500 V	Mica
C17	55422	20	150 V	
C18	56152	0.0033	250 V	
C23	56152	0.0033	250 V	
C24	48490	0.1	250 V	
C25	48494	0.22	250 V	
C26	48929	1900 pF		Mica
C31	53054	0.01	250 V	
C32	53054	0.01	250 V	
C33	53054	0.01	250 V	
C34	53054	0.01	250 V	
C35	48503	1.0	100 V	
C36	48503	1.0	100 V	

<b>RESISTORS</b>				
Resistors are fixed, metal-film, $\frac{1}{2}$ W, $\pm$ 5% unless otherwise indicated.				
R1	35759	30 k		
R2	35789	510 k		
R3	10940	1 k		
R4	11464	10 k		
R5	11461	5.1 k		
R6	35693	51		
R7	36763	1.2 k	1 W	carbon
R8	36763	1.2 k	1 W	carbon
R9	10073	20 k		
R10	57791	500		Trim Pot
R11	10073	20 k		
R12	10074	4.7 k		
R13	83331	33 k		
R14	11464	10 k		
R15	11464	10 k		
R16	88211	820		
R17	88211	820		
R18	11464	10 k		
R19	35733	2.4 k		
R20	35733	2.4 k		
R21	11464	10 k		
R22	11507	100		
R23	10078	1.5 k		
R24	11464	10 k		
R25	10074	4.7 k		
R26	10074	4.7 k		
R27	10078	1.5 k		
R28	35684	22		
R29	35684	22		



Circuit Description	JBL Part No.	Description		
<b>RESISTORS</b>				
R30	11464	10 k		
R31	11507	100		
R32	11613	39 k		
R33	10083	470		
R35	10083	470		
R37		selected		
R38	35697	75		
R41	35697	75		
R43	35692	47		
R49	35692	47		
R50	35703	130		
R51	35703	130		
R52	81071	1	5 W	ww
R53	81071	1	5 W	ww
R54	81071	1	5 W	ww
R55	81071	1	5 W	ww
R58	81071	1	5 W	ww
R59	81071	1	5 W	ww
R60	36714	10	1 W	carbon
R61	36714	10	1 W	carbon
R62	36714	10	1 W	carbon
R63	11507	100		
R64	10077	12 k		
R65	10077	12 k		
R66	10078	1.5 k		
R67	10078	1.5 k		
R68	10940	1 k		
R69	10940	1 k		
R70	55409	2.2		
R71	55409	2.2		
R72	11507	100		
R73	11507	100		
R74	11604	6.8 k		
R75	11604	6.8 k		
<b>SEMICONDUCTORS</b>				
CR1	39869	1N4003		
CR2	39869	1N4003		
CR3	39869	1N4003		
CR4	52219	MSD 7000		
CR6	39869	1N4003		
CR7	39869	1N4003		
CR10	39869	1N4003		
CR11	39869	1N4003		
CR14	39869	1N4003		
CR15	39869	1N4003		
CR401	56230	Diode Bridge		
BR1	47611	Rectifier Bridge		
Q1	48340	MPSA06		
Q2	55201	MPS 4356		
Q3	48340	MPSA06		
Q4	55201	MPS 4356		
Q5	48340	MPSA06		
Q6	52210	MJE 350		
Q7	52209	MJE 340		
Q10	48340	MPSA06		
Q11	55201	MPS 4356		
Q12	57914	2N6045		
Q15	57913	2N6042		
Q17	57914	2N6045		

**WARNING**  
 THIS SECTION OF THE MANUAL  
 CONTAINS SERVICE INSTRUCTIONS  
 FOR USE BY QUALIFIED SERVICE  
 PERSONNEL ONLY.

Circuit Description	JBL Part No.	Description	
<b>SEMICONDUCTORS</b>			
Q18	57913	2N6042	
Q27	57913	2N6042	
Q28	55411	MJE 182	
Q29	55412	MJE 172	
VR1	52225	1N4746	
VR2	52225	1N4746	
VR3	52225	1N4746	
VR4	52225	1N4746	
<b>CHASSIS PARTS</b>			
<b>INDUCTOR</b>			
L1	52573	Air Core	1.9 $\mu$ H
<b>OPERATIONAL AMPLIFIER</b>			
U1	52216	LM318H	
<b>THERMISTOR</b>			
RT1	55408		
<b>FUSE</b>			
F301	57861	2A, 3AG	
F401	82974	7A, 3AG	SLO-BLO
<b>FUSE HOLDER</b>			
FX301	84126	Fuse Holder	
XF401	37020	Fuse Block	
<b>JACK</b>			
J301	84126	Phono Jack	
<b>POTENTIOMETER</b>			
R201	58377	50 k	Audio Taper Pot
<b>KNOB</b>			
	54969	Knob	
	52887	Black Knob	
<b>LAMP</b>			
DS201	54959	Indicator Lamp	
<b>LAMP SWITCH BRACKET</b>			
	55022	Lamp Switch Bracket	
<b>METER</b>			
M201	55098	VU meter	
<b>POWER CORD</b>			
W401	82477		
<b>CAPACITORS</b>			
C201	13189	0.01 $\mu$ F	1.4 kV
C202	13189	0.01 $\mu$ F	1.4 kV
C303	88751	0.015 $\mu$ F	250 V
C401	57862	7400 $\mu$ F	50 V
C402	57862	7400 $\mu$ F	50 V
<b>SWITCH</b>			
S201	55523	DPDT	
S301	82307		
<b>THERMAL BREAKER</b>			
S302	55397	80°C	
<b>TERMINALS</b>			
TB301	86422		
TB303	86422		
TB401	55110		
<b>TRANSFORMERS</b>			
A401	60-6008	output transformer assy (6007 only)	
T402	56027	power transformer	

**WARNING**  
 THIS SECTION OF THE MANUAL  
 CONTAINS SERVICE INSTRUCTIONS  
 FOR USE BY QUALIFIED SERVICE  
 PERSONNEL ONLY.

atic

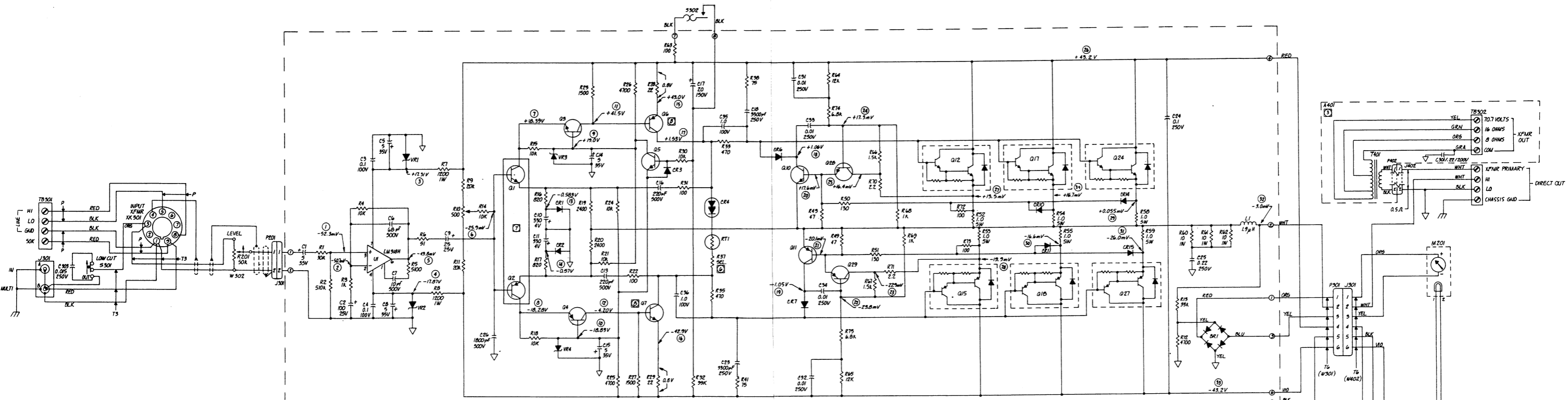

REFERENCE DESIGNATION CODE: FRONT PANEL 201 & UP.  
 REAR CHASSIS 301 & UP.  
 CHASSIS 401 & UP.

Q6 AND Q7 TO HAVE THE SAME BETA COLOR CODE.  
 Q1 AND Q2 ARE BONDED TOGETHER WITH THERMAL EPOXY.  
 R37 SELECTED FOR STABLE IDLE POWER OF 15-20 W, 20 Ω TYPICAL.  
 R10 IS DC OFFSET NULL CONTROL ADJUSTMENT FOR 0 ± 25 mV.  
 R11 USED IN 6007 ONLY.  
 R12 VALUES IN MICROFARADS.  
 R13 VALUES IN OHMS.  
 R14 MEASURED AT 120 V AC LINE, NO SIGNAL OF TYPICAL UNIT.  
 OTHERWISE SPECIFIED.

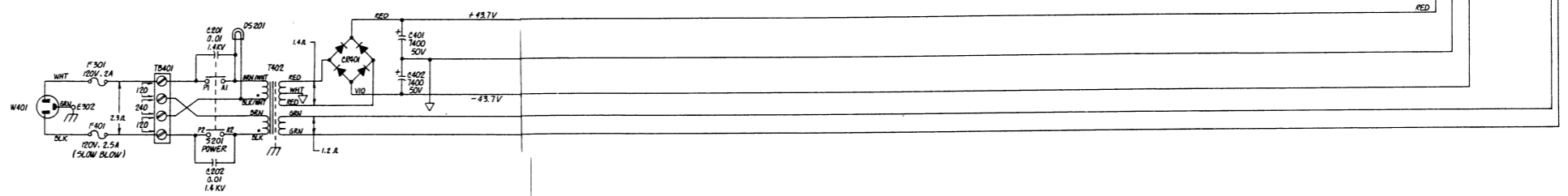



**Chassis Parts Location**

**WARNING**

THIS SECTION OF THE MANUAL CONTAINS SERVICE INSTRUCTIONS FOR USE BY QUALIFIED SERVICE PERSONNEL ONLY.

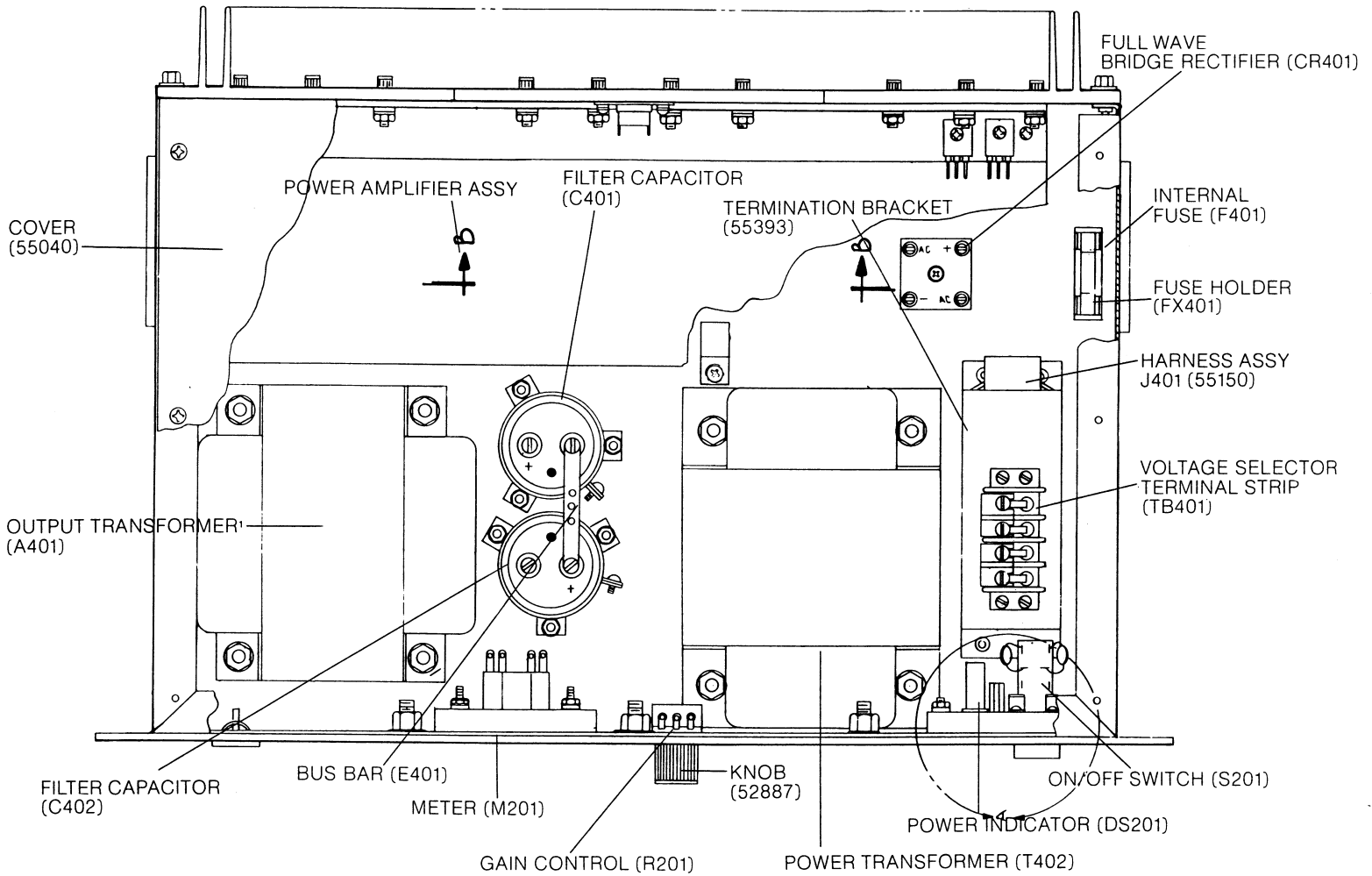

VIEW B-B

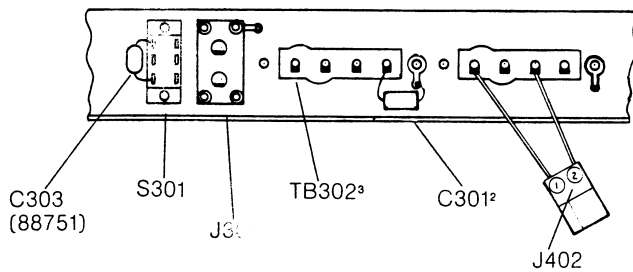

VIEW A-A

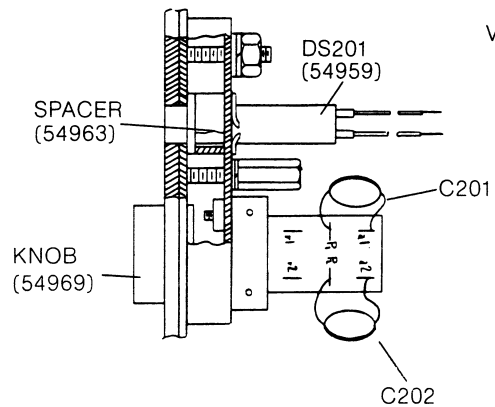

**NOTES:**

1. Used on 6007 only.
2. Part of output transformer assy.
3. TB302 used on 6007 only. 6008 uses cover plate 55124.

