

REVISION HISTORY

E. C. N.	REV	DESCRIPTION	DATE	APPROVED
	2	INITIAL RELEASE FOR PRODUCTION	12-06-05	DWN CM PE
	3	SEE 138977-1.3.XLS FOR COMPONENT DATA AND REVISION HISTORY.	12-30-05	KLW EB
	4	SEE 138977-1.4.XLS FOR COMPONENT DATA AND REVISION HISTORY.	03-17-06	KLW EB

COMPONENT MAP  
TOP SIDE

7

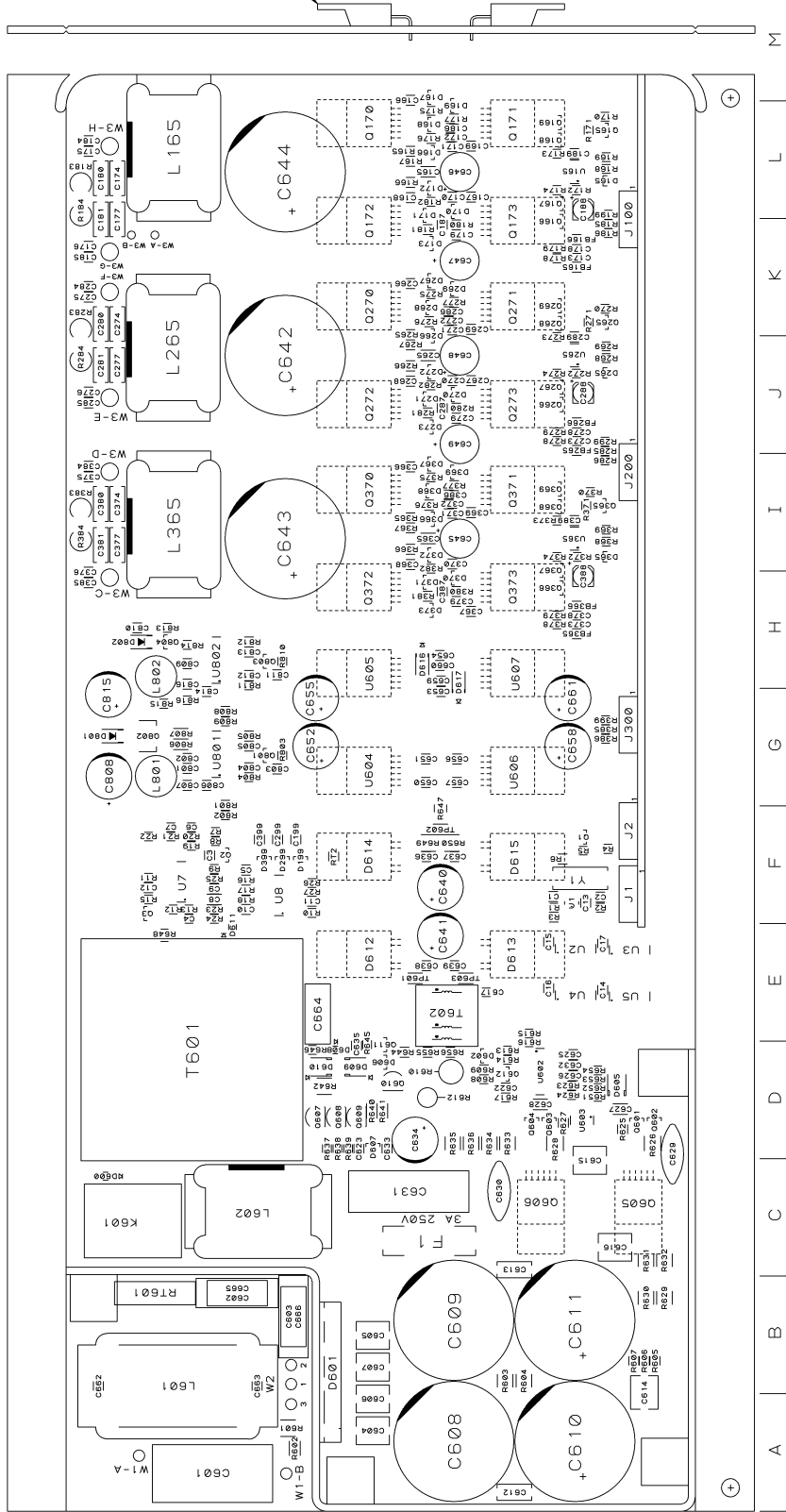

DISTRIBUTION		DWN	KLW	12-06-05
FILENAME		PE	EB	12-06-05
TOLERANCE UNLESS OTHERWISE SPECIFIED		.00 = ±.02"		
		.000 = ±.010"		
		DRILLS = ±.003"		
DO NOT SCALE DRAWING				

UNCONTROLLED		UNLESS OTHERWISE MARKED IN RED INK BY CM AS A CONTROLLED COPY, COPIES OF THESE DOCUMENTS INCLUDING ASSOCIATED ELECTRONIC REPRODUCTIONS ARE FOR REFERENCE ONLY.	
PWA. FR 1 MAIN		SIZE	DWG NO.
TITLE		B	138977-1
SCALE		NONE	PROJ. NO. MAMPJ00
SHEET		1	OF 6

1718 W. MISHAWAKA RD.  
ELKHART IN, 46517  
PHONE 574-294-8000  
WWW.CROWNAUDIO.COM

**Crown**  
INTERNATIONAL, INC.

POWER SUPPLY FILTERING

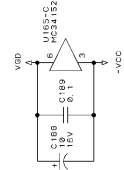
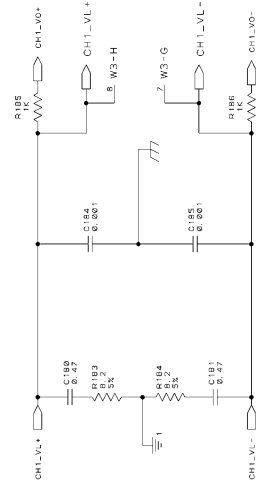
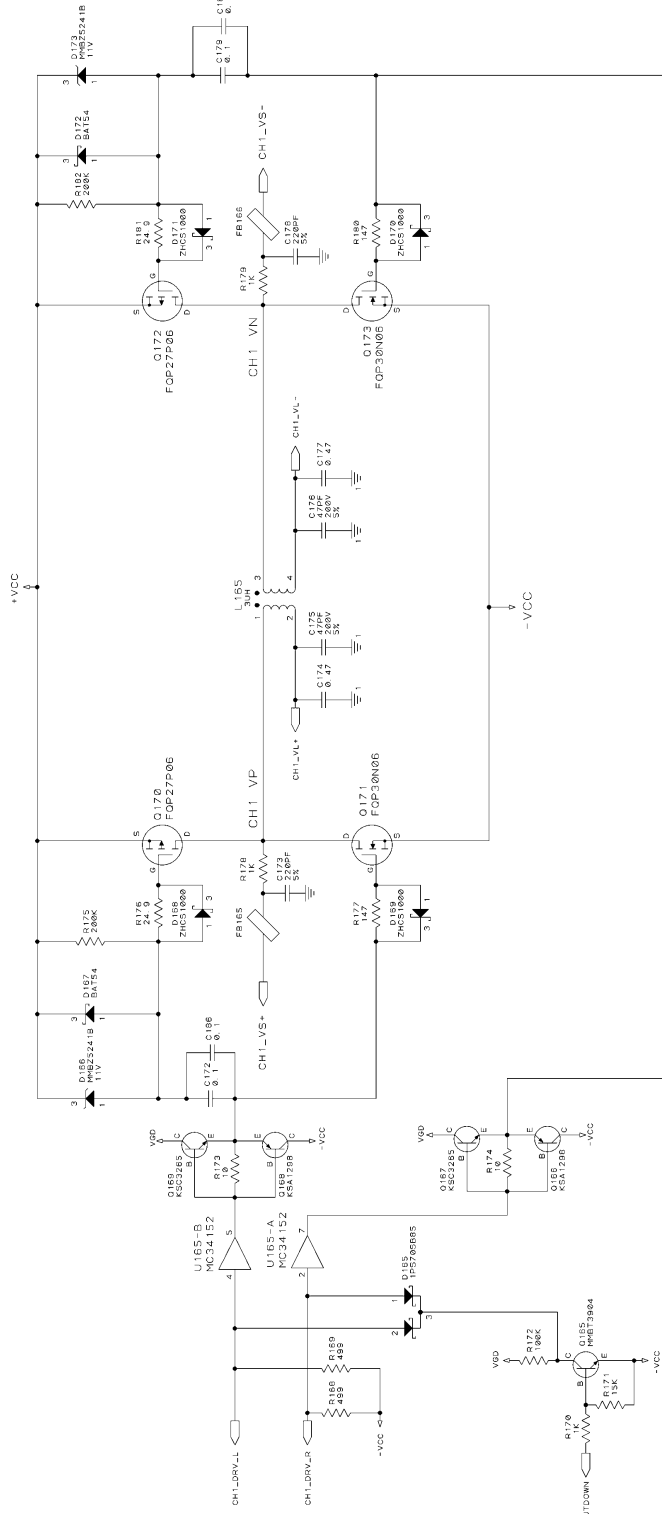
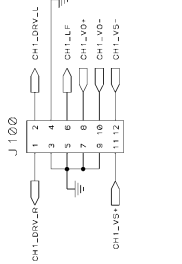
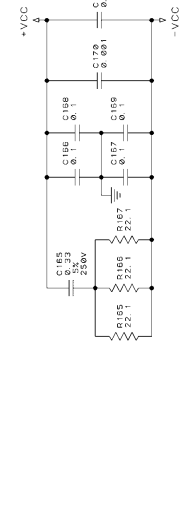

CH1 OUTPUT

UNCONTROLLED REPRODUCTIONS OF THESE DRAWINGS OR SPECIFICATIONS ARE PROHIBITED. UNLESS OTHERWISE SPECIFIED, ALL DIMENSIONS SHALL BE IN MILLIMETERS. UNLESS OTHERWISE SPECIFIED, ALL DIMENSIONS SHALL NOT BE REPRODUCED, COPIED, OR USED FOR ANY OTHER PURPOSES WITHOUT PERMISSION OF THE ORIGINAL AUTHOR. THESE DRAWINGS ARE FOR REFERENCE ONLY. ELECTRONIC REPRODUCTIONS ARE FOR REFERENCE ONLY. ELECTRONIC REPRODUCTIONS ARE FOR REFERENCE ONLY.

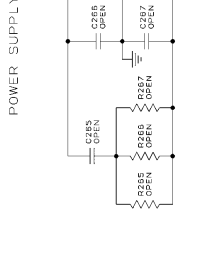
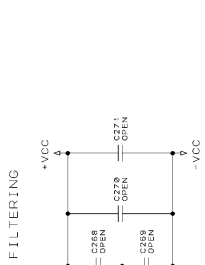
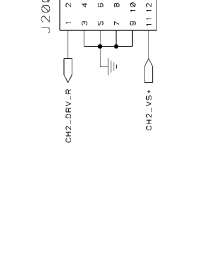
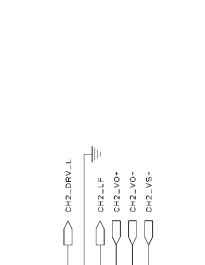
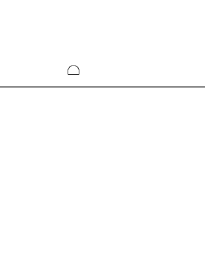

UNCONTROLLED REPRODUCTIONS ARE PROHIBITED. THESE DRAWINGS AND SPECIFICATIONS ARE THE PROPERTY OF THE COMPANY AND SHALL NOT BE REPRODUCED, COPIED, OR USED IN ANY MANNER WITHOUT THE WRITTEN PERMISSION OF THE COMPANY.

SIZE (INCH)	C	SCALE	NONE	PROJ NO.	MAX38P	SHEET	3 OF 6
REV	138977-1						4

CH2 OUTPUT

POWER SUPPLY FILTERING

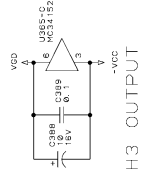
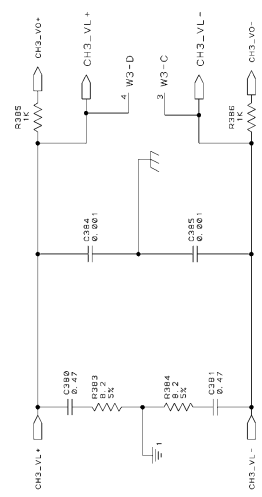
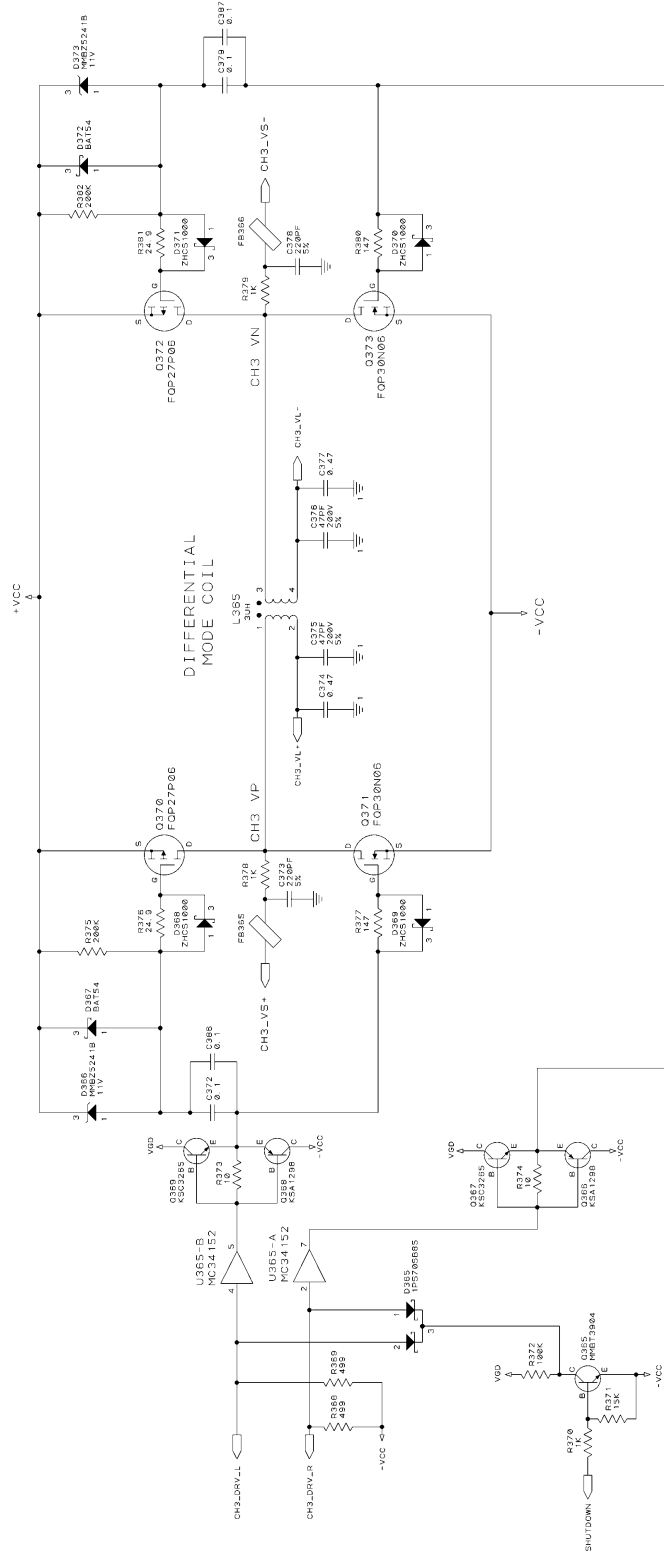
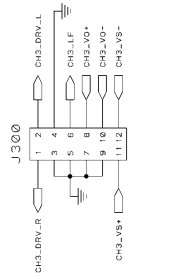
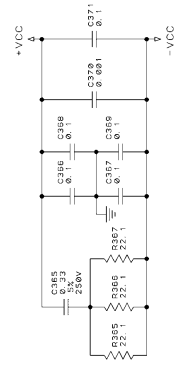

UNCONTROLLED REPRODUCTIONS OF THESE DRAWINGS ARE PROHIBITED. THESE DRAWINGS AND SPECIFICATIONS ARE THE PROPERTY OF THE COMPANY AND SHALL NOT BE REPRODUCED, COPIED, OR USED IN ANY MANNER WITHOUT THE WRITTEN PERMISSION OF THE COMPANY.

SIZE (DWG NO.) 138977-1  
 SCALE NONE  
 PROJ NO. MKX38MP  
 SHEET 4 OF 6

REV 4

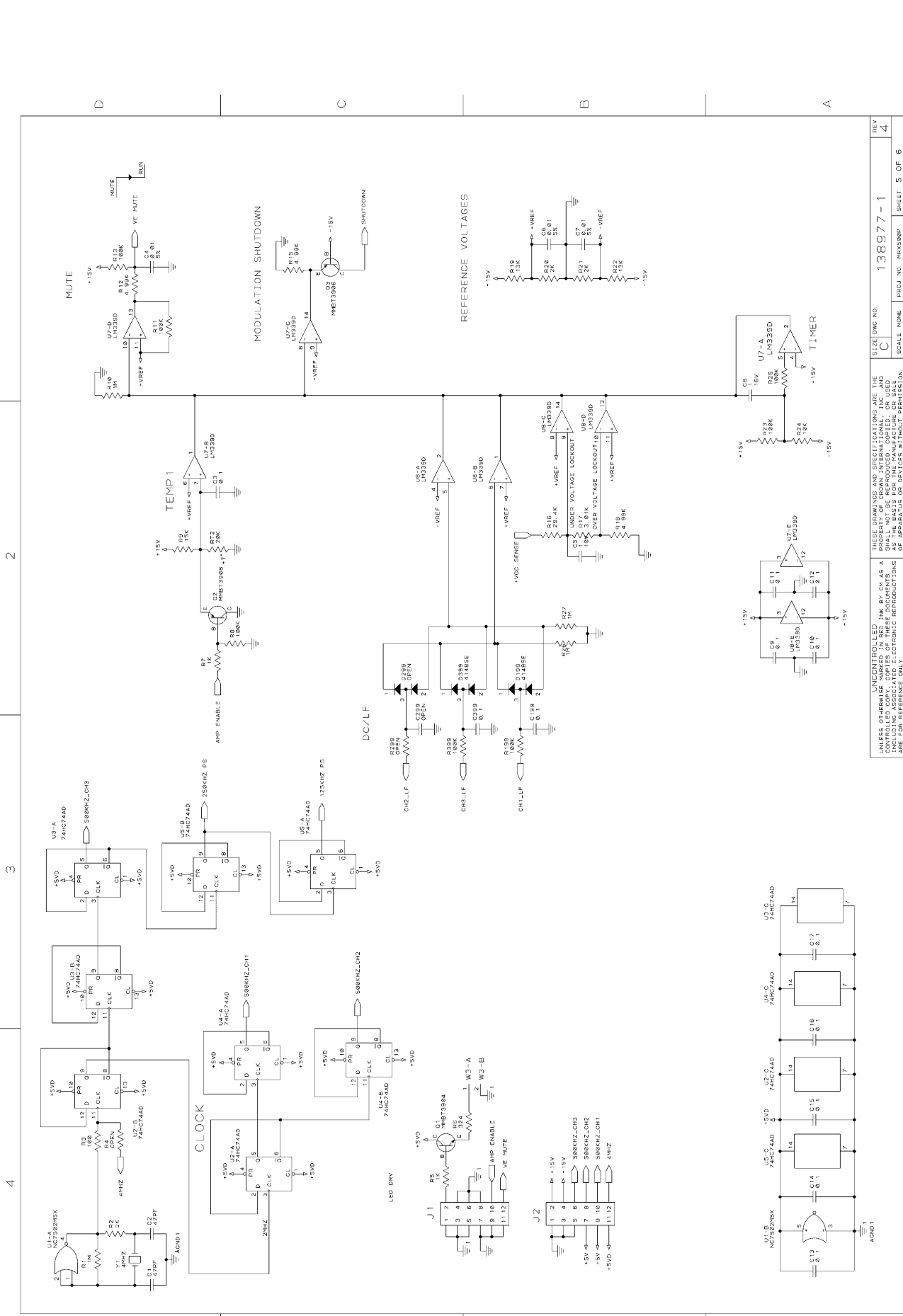

UNCONTROLLED TIME BY CH AS A CONTROLLED COPY. COPIES OF THESE DOCUMENTS SHALL NOT BE REPRODUCED, COPIED, OR USED FOR ANY OTHER PURPOSES WITHOUT PERMISSION. THESE DRAWINGS AND SPECIFICATIONS ARE THE PROPERTY OF THE COMPANY AND ARE FOR REFERENCE ONLY.

138977-1

PROJ. NO. PRR398P SHEET 5 OF 6

REV 4

SCALE NONE

SIZE DWG NO. C

# SMPS

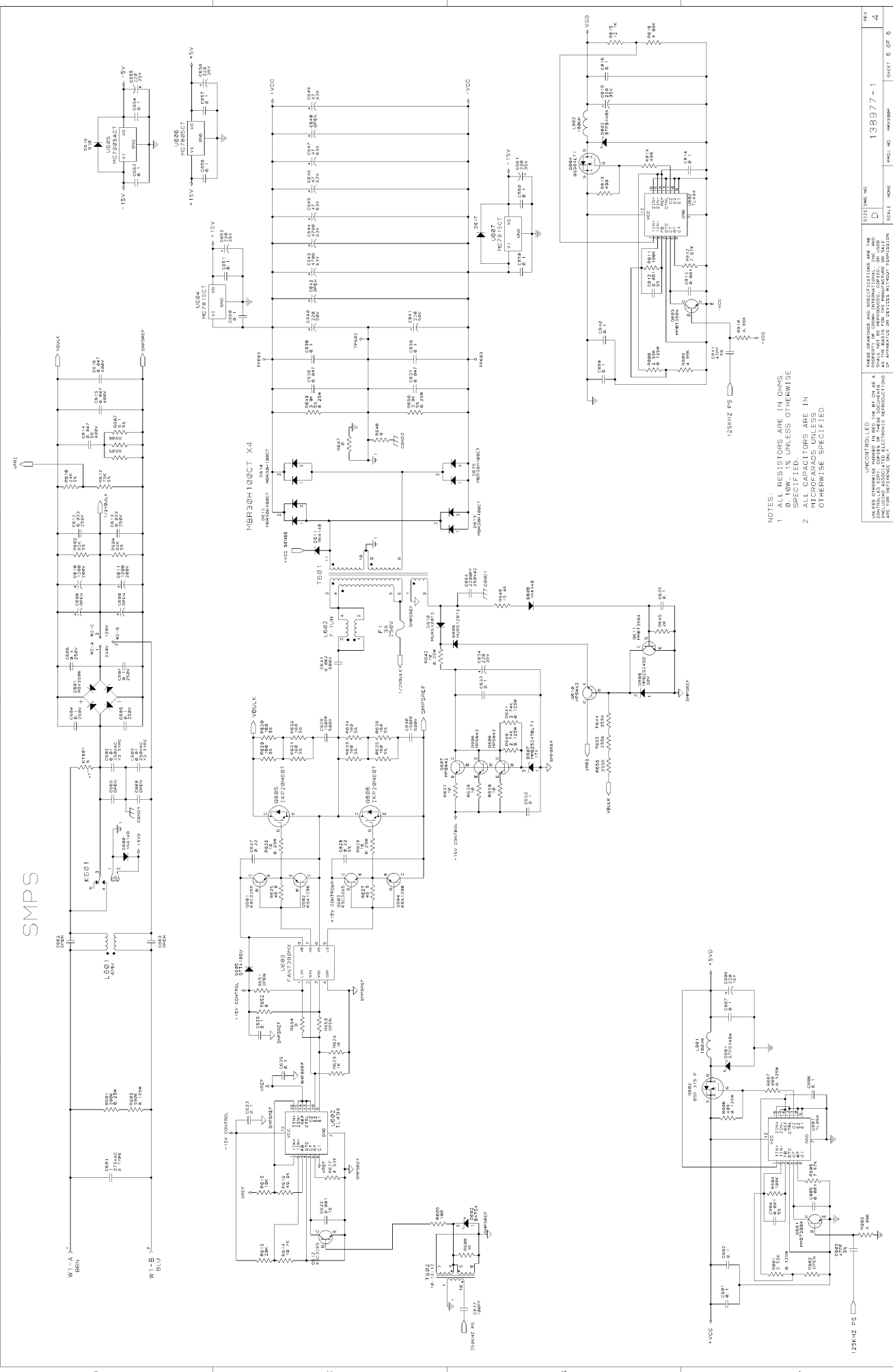

NOTES:  
 1. ALL RESISTORS ARE IN OHMS.  
 2. CAPACITORS UNLESS OTHERWISE SPECIFIED ARE IN MICROFARADS.  
 3. ALL CAPACITORS ARE IN MICROFARADS UNLESS OTHERWISE SPECIFIED.

REV	138977-1	PROJ. NO.	138977-1
SCALE	1:1	SCALE	1:1
NO.	4	NO.	4
UNCONTROLLED THESE DRAWINGS AND SPECIFICATIONS ARE THE PROPERTY OF THE COMPANY AND SHALL NOT BE REPRODUCED, COPIED, OR USED IN ANY MANNER WITHOUT THE WRITTEN PERMISSION OF THE COMPANY. THIS DRAWING IS FOR REFERENCE ONLY.			