

## Introduction

---

Parametric equalisers have been used for many years for creative equalisation in recording and broadcast studios. Their suitability for corrective equalisation in sound reinforcement systems has been limited by both a lack of accurate spectrum analysis and certain limitations in operational flexibility. Today, the widespread use of improved analysis equipment means that even narrow-band room resonances can be found and the results of corrective equalisation measured accurately.

Series 400 Parametrics can be used with great effect in both creative and corrective applications and offer unsurpassed flexibility as an equalisation device. They are uniquely suited to sound reinforcement applications. Each of five parametric filters can be positioned at any centre frequency between 20Hz and 20kHz with a wide choice of bandwidths from broad to notch. The DN410 offers even greater flexibility with an expanded 10 band single channel mode. Separate high and low frequency cut filters are featured on all models.

Where creative equalisation is required, such as in audio for video post production, broadcast and obviously recording studio's, both the DN405 and DN410 will find instant popularity whenever powerful equalisation is found to be needed.

Like all Klark-Teknik equaliser products the Series 400 Parametrics are carefully designed for excellent noise, distortion and sonic performance. When using an equaliser remember that the need to use large amounts of boost or cut within the equalisation curve indicates that there may be something fundamentally wrong with the sound system or room acoustics, which should be further investigated and corrected before final equalisation is applied.

## DN410 Parametric Equaliser



The Klark-Teknik DN410 is a dual channel, 2 x 5 band parametric equaliser offering 15dB of boost or 25dB of cut at any frequency between 20Hz-20kHz, and variable filter bandwidths from less than 1/12 octave to in excess of 2 octaves. In the expanded 'single' mode, all 10 parametric filters are placed into channel A.

### Filter Performance

The following curves illustrate the variety of filter responses possible when using the DN410 parametric. The five parametric sections are designed to be free from interaction between each other and so using more than one filter gives a response curve that is simply the sum of the various individual responses.

### Parametric

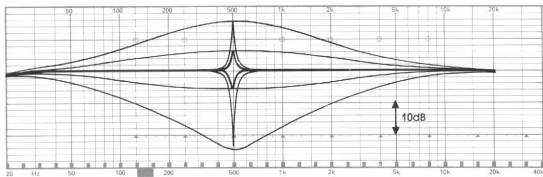

Shows the range of bandwidths and amplitudes possible using a single parametric filter. The centre frequency could, of course, be anywhere between 20Hz and 20kHz.

### Notching

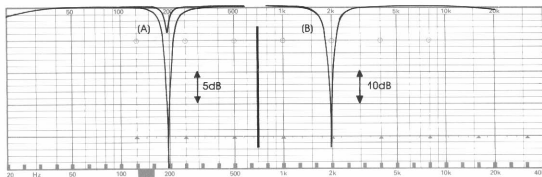
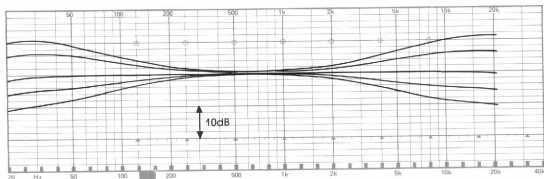

Figure A demonstrates typical notch performance, with filter bandwidths set at minimum. Figure B shows the effect of tuning two notch filters to the same centre frequency for increased rejection.

## Shelving



Shows the use of a parametric filter to obtain LF and HF shelving responses. The filter is shown set at minimum and maximum frequencies in turn, with bandwidth at maximum.

## LF/HF Cut

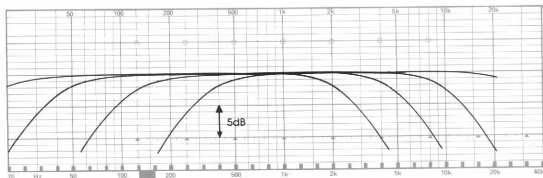

Demonstrates the performance of LF and HF cut filters, with controls set for minimum, maximum and intermediate frequencies. Slope for both filters is 12dB octave.

## Other Features

The channel eq. in/out switch removes both the equaliser section and the high/low-pass filters from the signal path.

Other features include an overload LED, which warns of impending overload at any point in the equaliser, a signal ground lift switch and an optional security cover to prevent unauthorised personnel from tampering with the control settings. A failsafe relay is incorporated into the design, which automatically and silently bypasses the equaliser in the event of power supply failure. This relay also acts at switch-on to isolate the equaliser until the power rails have settled, thus precluding the possibility of a potentially damaging switch-on thump.

This product is built to the same high electrical and mechanical standards as all Klark-Teknik equipment and is both robust and stylish. It occupies two standard units of rack space and has an electronically balanced input and unbalanced output. Output balancing transformers are available and retrofittable.

## Reliability Control

---

Even with the advanced technology incorporated in this product each instrument is given the full backing of Klark-Teknik's "**reliability control**" which proves each product against a specification consistent with the highest professional standards. Only top quality components are used, and every unit is bench tested and aligned before a burn-in period and final performance test.

## Options

---

Aluminium security cover

Perspex security cover

Transformer input\*/output balancing

\*input transformer balancing is non retrofittable and has to be specified with order.

### Options Ordering Information

Perspex security cover

Aluminium security cover

Output balancing transformer

Input balancing transformer

Parts Number

SCP ..... Model No.

SCA ..... Model No.

BU37

BN37

## Instrument Familiarisation

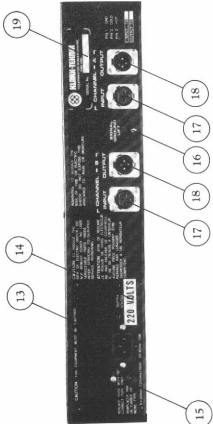
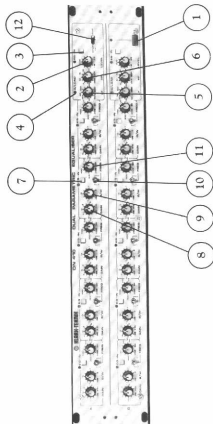

### Front Panel Functions

- The **power switch** is a two pole type isolating both the live and neutral conductors. When the power is on, a red status LED lights, when it is fully on.
- The **input level control** allows system gain up to 20 dB to be set. It is fully clockwise position.
- The **input level indicator** shows the level of the signal path. The **channel so, in-out switch** removes both the high/low-pass filters and the complete equaliser section from the signal path. Eq. 'in' status is indicated by LED.
- The **Overload LED** The signal level is monitored for exceeding a threshold, set 3dB before clipping, will cause the LED to light. This threshold is set at +19dB, but it must be remembered that excessive boost of some frequencies combined with a high average input signal, can occasionally be pushed down to correct the problem. However, if the input signal itself exceeds +19dBm the input stage will be overloaded. If this problem arises, the signal level from the output of the preceding piece of equipment must be turned down.
- The **filter (high pass)** has a continuously variable turnover frequency from 15Hz to 300Hz.
- The **high frequency filter** (low pass) has a continuously variable turnover frequency from 2.3kHz to 30kHz.
- The **bandwidth control** sets the individual parametric filter from the signal path. Eq. 'in' status is indicated by LED except when cancelled by switching channel eq. to 'out'.
- The **gain control** sets gain between +15 and -25dB for the parametric filter. A clockwise to less than 1/2 octave when anti-clockwise.
- The **bandwidth control** sets filter bandwidth between 2 octaves when fully clockwise to less than 1/2 octave when anti-clockwise.
- The **range switch** selects the filter centre frequency as follows:  
 1. 10/20Hz-20kHz  
 2. 10/20Hz-20kHz  
 3. 10/20Hz-20kHz
- The **frequency control** sets the filter centre frequency within the limits selected by the range switch. A nominal 10:1 sweep range allows precise tuning of notch centre mode.
- The **Single Dual** mode switch places all 10 parametric filters into channel A in 'single' and configures the unit for normal 2 x 5 band operation in 'dual'. Note that only channel A level control, sweep filter and eq. in our switch function in 'single' mode.

### Rear Panel Functions

- Mains is supplied via an IEC standard 3 pin connector. A compatible power cord is supplied with the unit.
- Voltage selector switch. This unit is designed to be switchable between two voltages, 110V and 230V. To facilitate this, a slide switch is fitted, accessible from the rear panel. The power supply MUST be disconnected before the switch is reset. Note too that any attempt to operate with 110V supply with the correct type and rating of fuse, as indicated adjacent to the fuse holder.
- The **mains fuse** is located in a fuse holder fitted to the rear panel. Always replace with the correct type and rating of fuse, as indicated adjacent to the fuse holder.
- Earth/line** switch. Situated on the rear panel, this switch is used to connect the unit to earth/loops. It will generally solve the problem, i.e. also safe, unlike the practice of disconnecting the mains earth from the power cord.
- Input and output connections are made via complementary
- For further details see page entitled Audio Connections.
- The **serial number** of this unit should be quoted in any correspondence concerning the unit.

## Audio Connections

### Input

The input circuitry is a transformerless, electronically balanced design which achieves a symmetry of better than  $-50\text{dB}$  from  $20\text{Hz}$  to  $10\text{kHz}$ .

If transformer balancing of the input is required, this must be stipulated at the time of order; it is not retro-fittable.

### Output

The standard output is unbalanced, but balancing transformers are available and may be retrospectively fitted. The output circuitry is capable of driving a  $600\ \text{ohm}$  load at a level of  $+22\text{dBm}$ .

### Input

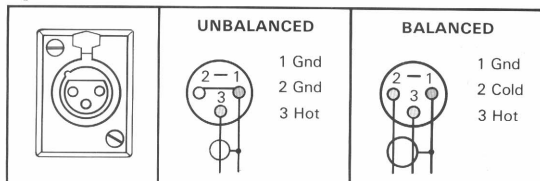

### Output

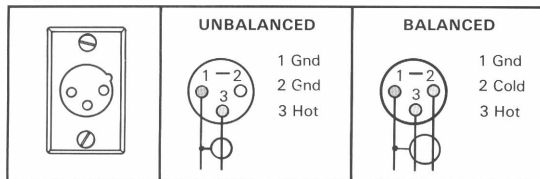

### Pin 2/Pin 3 Hot operation

The unit can be quickly re-configured to accommodate either XLR wiring standard by removing the top cover and changing the orientation of 4 plug-in links per connector, as shown on the adjacent PCB legend. When using a fully balanced system, either pin 2 or pin 3 may be the HOT terminal. In "Single" mode use channel A connectors only.

### Balanced Circuits

Transformer or electronically balanced connections have the benefit of "common mode rejection" which eliminates externally induced interference such as mains hum etc. Balancing is especially useful when long cable runs are used between pieces of equipment.

Transformer balanced circuits have the added advantage of being, "fully floating" with the ground (earth) or screen being totally isolated from the signal. In installations where a difference in earth potential is likely to occur this isolation prevents grounding problems which can, in some cases, damage the equipment.

## DN410 Technical Specifications

---

### Inputs

Type  
Impedance (ohm)  
Balanced  
Unbalanced

### Two

Balanced (electronically)  
20K  
10K

### Outputs

Type  
Min. Load impedance  
Source  
Max. level

### Two

Unbalanced  
600 ohm  
<60 ohm  
+22dBm

### Performance

Frequency response (20Hz-20kHz)  
Distortion (@ +4dBm)  
Equivalent input noise  
(20Hz-20kHz unweighted)  
Channel separation  
Gain  
Overload indicator

$\pm 1.5$ dB  
<0.01% @ 1kHz  
<-90dBm  
>80dB @ 1kHz  
+6dB  
+19dBu

### Filters

Type  
Bandwidth  
Max. boost/cut  
Frequency ranges  
High pass filter  
Low pass filter

Parametric (2 x 5)  
Variable from 1/12 - 2 octaves  
+15/-25dB  
20Hz-200Hz/200Hz-2kHz/2kHz-20kHz  
15Hz-300Hz/12dB octave  
2k5Hz-30kHz/12dB octave

### Power Requirements

Voltage  
Consumption

110/120/220/240V 50/60Hz  
<15VA

### Weight

Nett  
Shipping

4.5kg  
7kg

### Dimensions

Width  
Depth  
Height

482mm (19 inch)  
235mm (9¼ inch)  
89mm (3½ inch)

### Terminations

Inputs  
Outputs  
Power

3 pin XLR  
3 pin XLR  
3 pin CEE

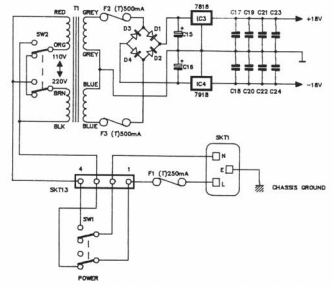
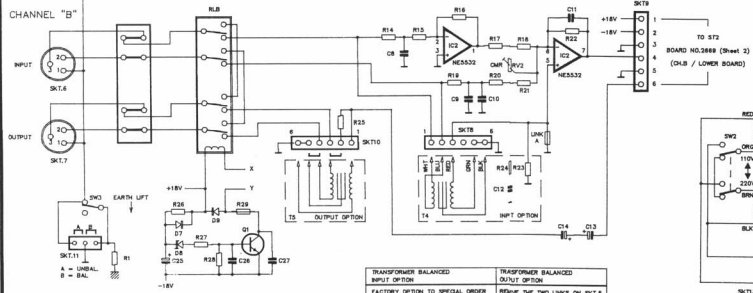
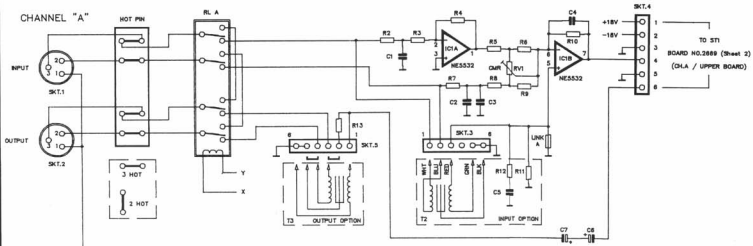

TRANSFORMER BALANCED INPUT OPTION	TRANSFORMER BALANCED OUTPUT OPTION
FACTORY OPTION TO SPECIAL ORDER ONLY. COMPONENTS REMOVED / LINK A, RV1 R2-R9, R14-R21, C1-C3, C8-C10, REPLACED WITH LINKS R4, R13, R18, R22. COMPONENTS ADDED R11, R12, C5, R23, R24, C12	REMOVE THE TWO LINKS ON SKT.5 PLUS IN TRANSFORMER WITH THE SPECIFIC TRANSFORMER WITH THE DSPM AND WASHER PROVIDED. CHANGE THE LINK ON SKT.11 TO THE "BAL" POSITION

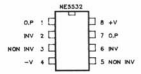



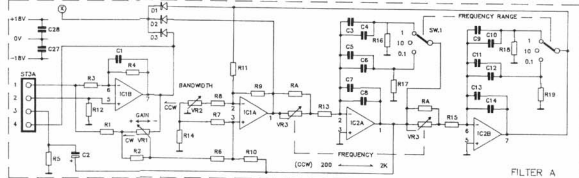
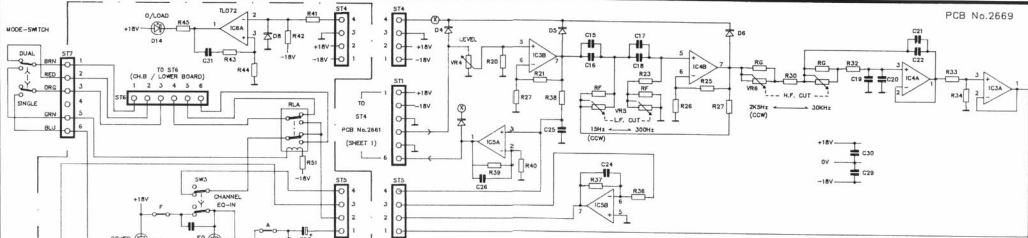

FILTERS B,C,D WHICH ARE NOT SHOWN  
ARE IDENTICAL TO FILTERS A,E.

ALL IC'S NE5532 UNLESS STATED

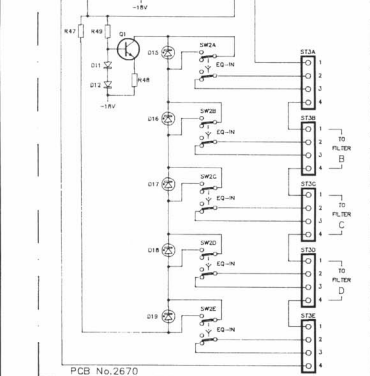
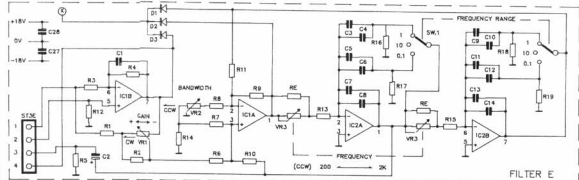

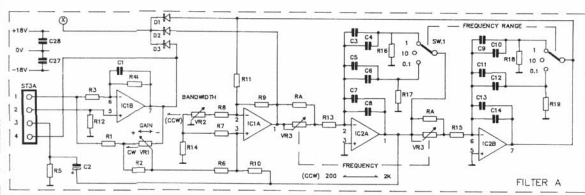
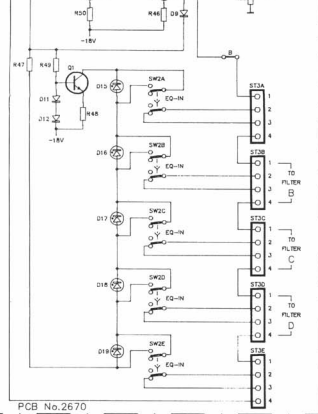
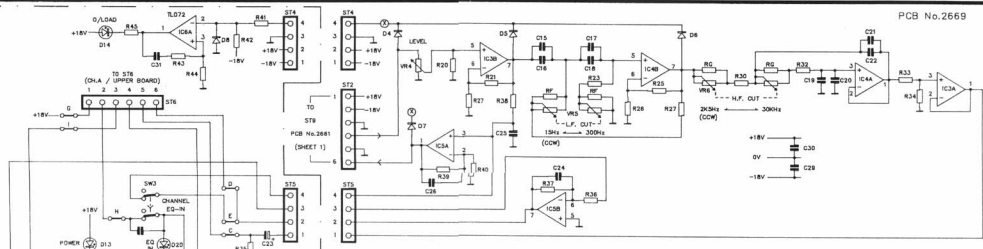

FILTERS B,C,D WHICH ARE NOT SHOWN ARE IDENTICAL TO FILTERS A,E.

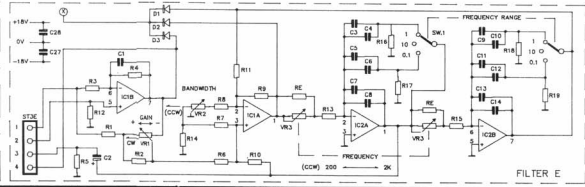

CHANNEL A

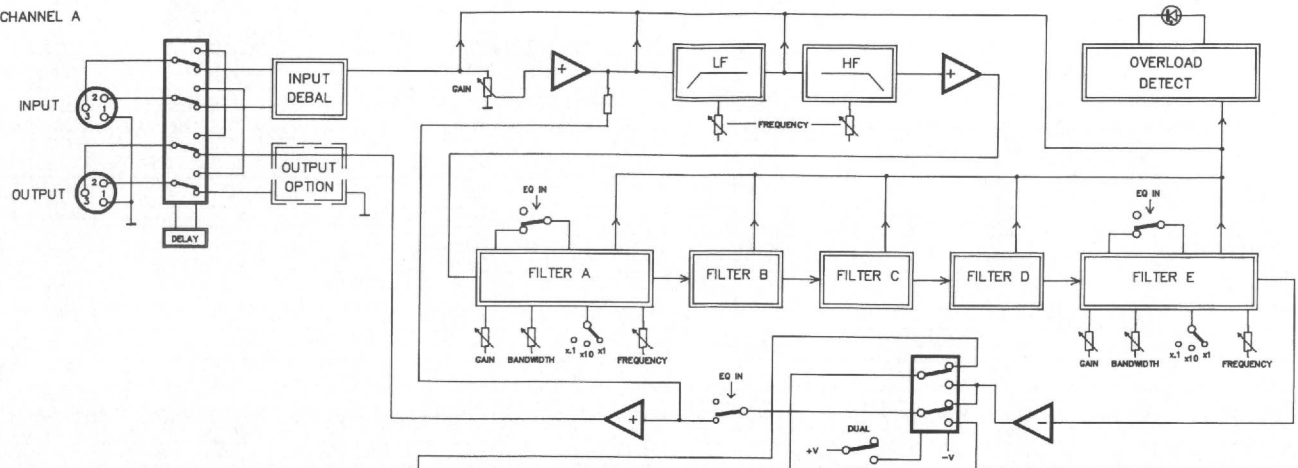

CHANNEL B

