

CONNECTORS AND PIN DEFINITIONS

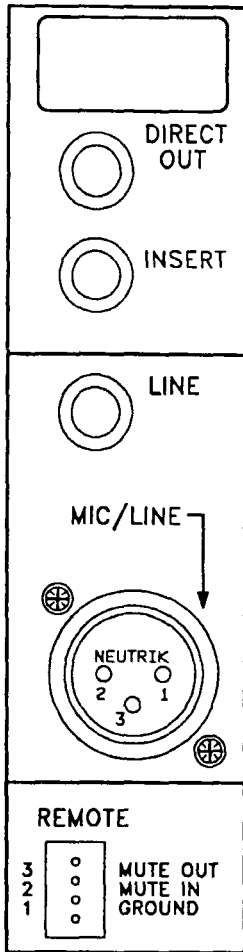

Direct Output : 1/4" TRS Jack Socket,
 'A' Gauge, Unbalanced
 Nominal Output level: 0dBu
 Tip : Signal
 Ring : Ground
 Sleeve: Ground
 Output Impedance : <75 Ohm

Insert Point : 1/4" TRS Jack Socket,
 'A' Gauge, Unbalanced
 Nominal Input/Output level: 0dBu
 Tip : Insert Send
 Ring : Insert Return
 Sleeve: Ground
 Output Impedance : <75 Ohm
 Input Impedance : >10 kOhm

Line Input : 1/4" TRS Jack Socket,
 'A' Gauge, Balanced
 Nominal Input Level: -16dBu to +14dBu
 Tip : Signal +ve (Hot)
 Ring : Signal -ve (Cold)
 Sleeve: Ground
 Input Impedance : >10 kOhm

Mic Input : 3 Pin Female XLR type, Balanced
 Nominal Input Level: -66dBu to -16dBu
 Pin 2 : Signal +ve (Hot)
 Pin 3 : Signal -ve (Cold)
 Pin 1 : Ground
 Input Impedance : >2 kOhm

Remote Mute Connector

- 1 Ground
- 2 Mute Input Grounding this pin mutes the channel.
- 3 Mute Output This pin is grounded when the MUTE switch is depressed.

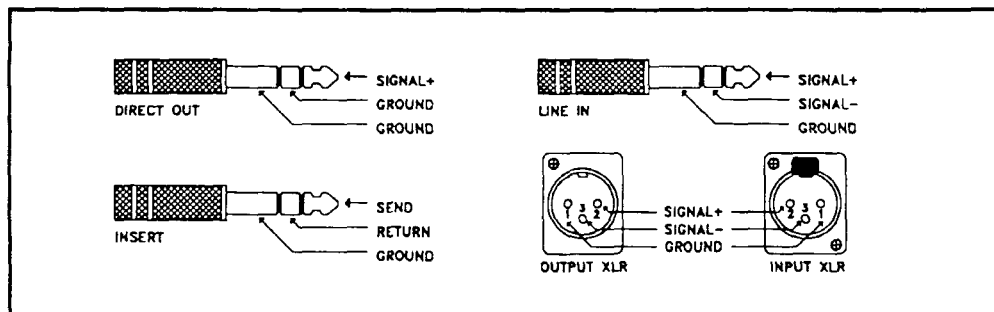

CS8

OPERATION MANUAL

CONTENTS

INTRODUCTION	4
CS8 OVERVIEW	7
SAFETY PRECAUTIONS	8
TRANSPORT	8
CS8 QUICKSTART	9
CS8 SPECIFICATIONS	12
OPTIONS	12
CS8 DIMENSIONS AND WEIGHTS	13
THE MONO INPUT MODULE	14
CONNECTORS AND PIN DEFINITIONS	24
INPUT MODULE LINKS	25
CS8 MONO INPUT BLOCK DIAGRAM	26
THE STEREO INPUT MODULE	27
CONNECTORS AND PIN DEFINITIONS	35
STEREO INPUT MODULE LINKS	36
STEREO INPUT MODULE BLOCK DIAGRAM	37
THE GROUP OUTPUT MODULE (1-6)	38
CONNECTORS AND PIN DEFINITIONS	42
GROUP MODULE 1-6 LINKS	43
GROUP MODULE 1— 6 BLOCK DIAGRAM	44
THE GROUP OUTPUT MODULE (7-8)	45
CONNECTORS AND PIN DEFINITIONS	51
GROUP MODULE 7-8 LINKS	52
GROUP MODULE 7-8 BLOCK DIAGRAM	53
THE MASTER MODULE	54
CONNECTORS AND PIN DEFINITIONS	61
MASTER MODULE LINKS	63
MASTER MODULE BLOCK DIAGRAM	65
THE METERBRIDGE (OPTIONAL)	66
FITTING THE METERBRIDGE	67
BUS LINKING	68
MULTIPOLE CONNECTORS (OPTIONAL)	69
THE POWER SUPPLY	70
THE DLB600 AUTOSWITCHOVER UNIT	72
CS8 GROUNDING	73
A TECHNICAL PRIMER	74
INSTALLATION GUIDE	79
GLOSSARY	81
DECLARATION OF CONFORMITY	86
WARRANTY	87

The information in this manual has been carefully verified and is believed to be correct, however, EVI Pro Audio reserves the right to modify the product described in this manual at any time. This document may not be copied or reproduced by any method whatsoever, whether in part or in whole, without the written permission of EVI Pro Audio.

© Copyright 1997 EVI Pro Audio Group. All rights reserved.

DOC02-CS8/A

INTRODUCTION

The CS8 has been designed as a cost effective multipurpose console suitable in applications ranging from theatre sound reinforcement to high quality touring systems. It features SIS (Spatial Imaging System) which combines a central loudspeaker cluster with a left/right system to form three discrete sound channels.

This configuration will be very familiar to those who have been exposed to feature film sound, home theatre or multimedia productions. In SIS sound systems the centre channel is reserved for voice and, in music reinforcement, is sometimes used for solo instruments. The centre cluster is designed to cover an entire auditorium while its frequency response is tailored to roll off rapidly below 80Hz. There are a number of advantages created by working this way.

With a discrete centre channel handling all critical vocal reinforcement, intelligibility is maximised. Reverberation can be controlled through careful attention to the coverage pattern of the cluster along with careful aiming. Reflections in the space that are associated with the vocal signal are more coherent because the space is being excited from a single source and since the low frequency response of the cluster can be tailored to a range appropriate for vocals, problems, such as the proximity effect of cardioid microphones, can be minimized. The physical separation of the voice from instrumental (or sound effect) backgrounds also aids the ear making the featured vocal stand out in relief over the rest of the mix.

As the centre cluster is primarily for vocals it is more likely to be operated in its linear region below the onset of overload. This and the fact that the signals that it reproduces have relatively simple harmonic structures results in greatly improved clarity by minimizing distortion. The left/right accompaniment channels can be driven into overload without distorting the vocal signal.

The DDA CS8 is an uniquely powerful and flexible console that is purpose built for controlling such systems and maximising their performance. A typical application might be a small multi purpose hall as the illustration overleaf shows.

Such halls generally serve a wide range of functions that may include lectures or assemblies, multi-media events or industrial shows, and live performances of music or theatrical plays.

Illustrated in the diagram is an LCR sound system designed to meet the varying requirements of such programs. A central cluster, optimized for voice reinforcement and consisting of two dual-concentric horn loudspeakers, is flown over the stage lip. The left-right system consists of full-range, electronically controlled loudspeakers with subwoofers, and is designed for music reproduction. The left-right system may be either permanently installed, or made portable so that it can be wheeled in and configured as necessary.

The diagram overleaf shows how such a system would typically be connected to be controlled from the CS8 console. Separate master equalisers are provided for each of the three channels, and the center cluster employs an electronic crossover while the left-right system uses dedicated controllers.

The input side of the block diagram merely shows a few possible sources — the actual complement of inputs would be dictated by the usage of the hall. As illustrated, a podium override function may be provided by connecting a podium-mounted SPST switch to a simple isolation interface (a relay, for example), grounding the Cut In terminals on the CS8 Remote Mute connectors to mute all channels other than the podium microphone.

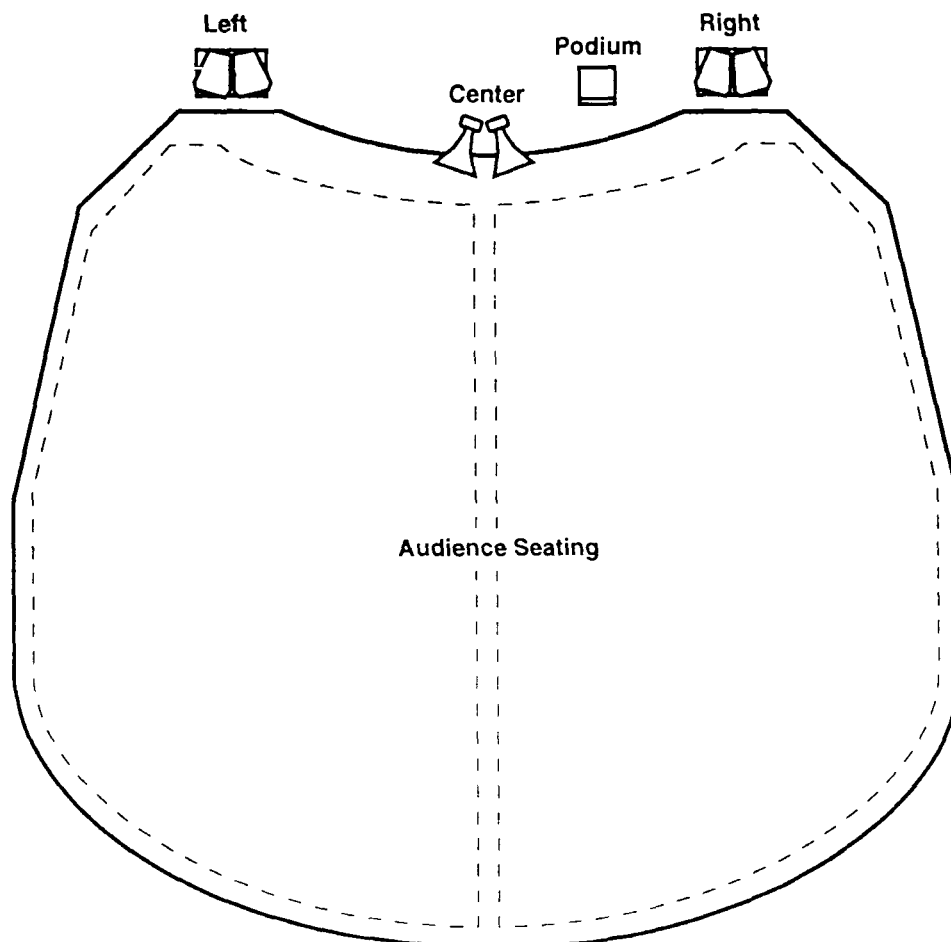

The CS8 console provides a wealth of possibilities for this application. As an example, where budget permits, a surround speaker system may be installed and the outputs of AV equipment routed through a surround decoder, then into four CS8 inputs. By setting up the console groups as LCRS respectively, dramatic and convincing segues between live and pre-recorded surround material could be made.

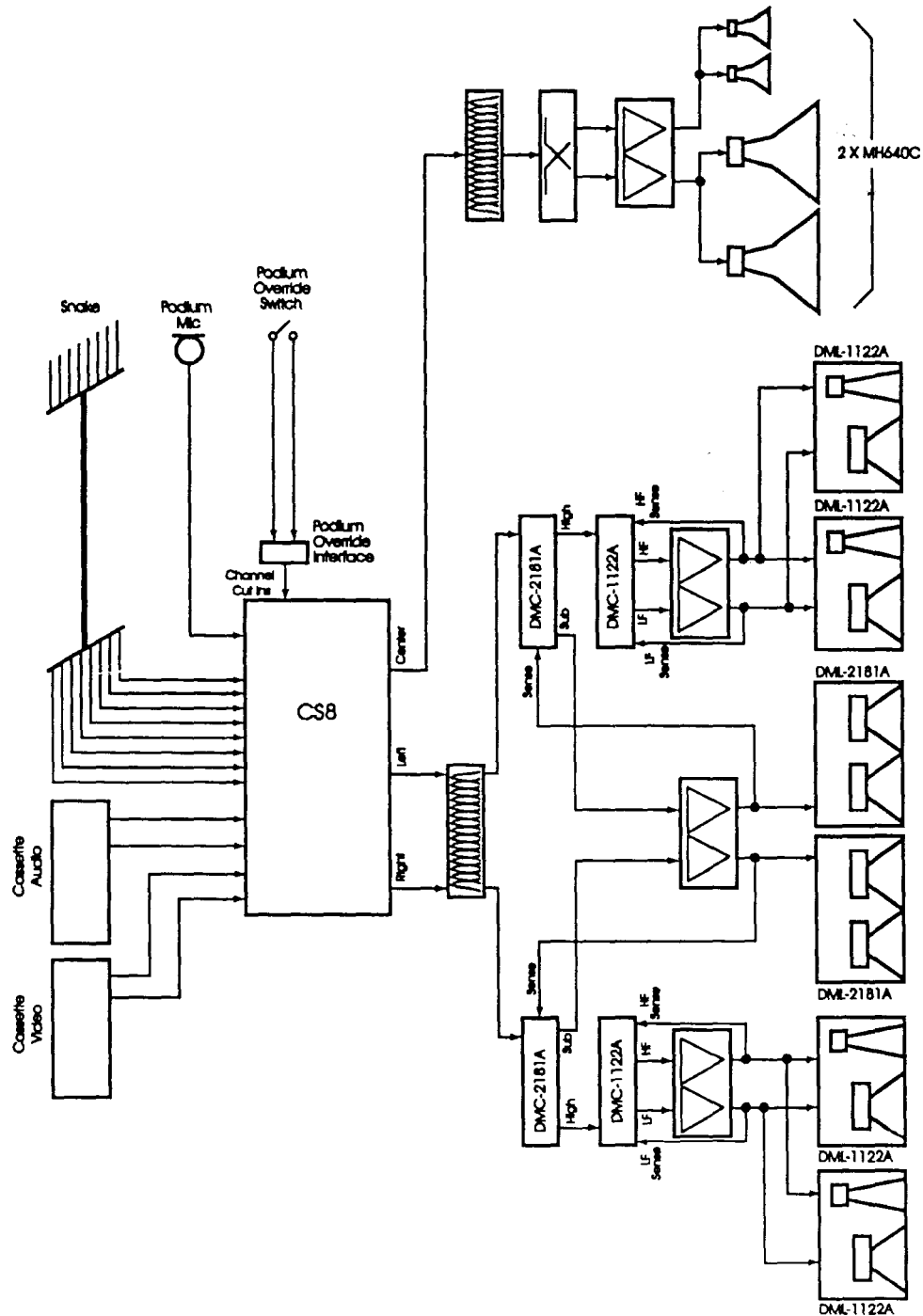

Further application related information can be found in the DDA SIS leaflet available through your dealer.

CS8 OVERVIEW

The CS8 has been designed as a cost effective multipurpose console suitable in applications ranging from theatre sound reinforcement right through to high quality touring systems.

ALL DDA CS8 consoles include:-

- A customer specified number of mono input modules, each with 4 band EQ, 8 Aux sends, individual group routing and incorporating the Spatial Image System (SIS™) to the 3 main outputs
- 4 Stereo inputs, featuring the same EQ, and auxiliary access as the mono inputs, and mono input capability
- 8 sub-groups, each capable of being routed to the main outputs in stereo or LCR panning styles
- 6 Matrix Outputs, each sourced from the 8 groups, LCR outputs and an external input
- 2 stereo returns, capable of applying EQ and routing via long throw fader to the groups, mix and aux busses
- Input module remote muting
- Input signal 0dB level indication
- Accurate output signal indication with 'Bus Peak' indication
- Group and main bus peak indication
- Pre-Fade inserts on the aux, group, main and matrix outputs
- Optional VU output meterbridge, LED Input/Output meterbridge, Spare PSU with autoswitchover, further stereo inputs, transformer balancing and Midi Muting.

SAFETY PRECAUTIONS

IMPORTANT - PLEASE READ BEFORE INSTALLING YOUR CS8 CONSOLE

Strong sources of electromagnetic radiation e.g. high power cabling, video monitors and radio transmitters may cause degradation of the audio quality due to induced voltages in the chassis and connection leads. Site the console away from such sources. For the same reason it is advisable to site the power supply away from the console.

- √ Electronic components are susceptible to conditions of excessive heat or extreme cold so take care not to use your console under such conditions.
- √ Before powering up the console make sure that the power supply voltage selection matches the local mains supply.
- √ Never connect or disconnect the power cable without switching off the power supply. Similarly switch off the console before removing or servicing modules.
- √ Do not attempt to wipe clean the console with a cleaning liquid. Most surfaces can be simply cleaned with a soft dry brush. Should the chassis or channel ident strips need cleaning use only water or isopropyl alcohol. Solvent based products should not be used as they may damage these parts.
- √ Use a wax based crayon to write on the scribble strips. The use of adhesive backed tapes may damage the screen printing on the modules

TRANSPORT

It is recommend that you retain all the packing from your console should you ever need to return it for service or move the console to other premises.

If the console has to be moved regularly then we suggest that you purchase a foam lined flight case, available from your distributor if you cannot purchase one locally.

Only use the power supply and cables provide. Your warranty is invalidated if other supplies or cables are used.

If you experience any problem with the local mains, or during thunder storms, switch off the power supply and unplug it from the mains supply.

CS8 QUICKSTART

For this you should have the following items available.

- Microphone and cable (XLR to XLR connectors).
- Power amplifier with mains cord and signal cable.
- Loudspeaker with connecting cable.
- Headphones.
- CS8 Console.

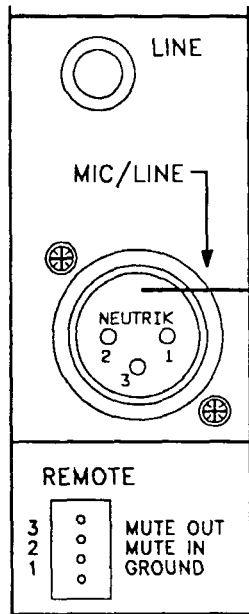

First of all make sure that the power supply is suitable for connection to your local supply.

Connect the console to the power supply.

Connect the microphone into channel 1 and the power amplifier into the MON L output (and MON R if you have a stereo amplifier). Connect your speakers to the amplifier and set the volume control(s) to a low position.

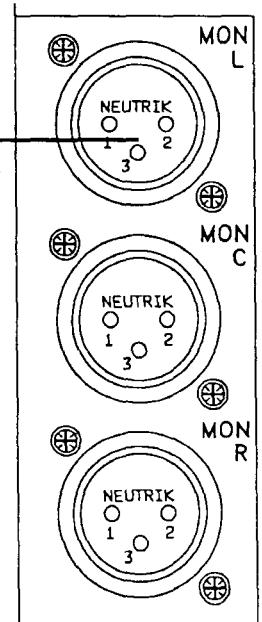

Switch on the console FOLLOWED by the power amplifier.

Check that the leds on the master module are illuminated for the +/- 18V and +48V power rails. If phantom power is required for your microphone then ensure that the ON led is illuminated. If not use a blunt non conductive instrument such as a pencil or pen to push the switch which is located under the panel.

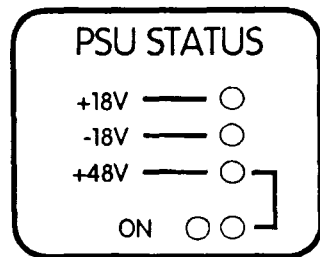

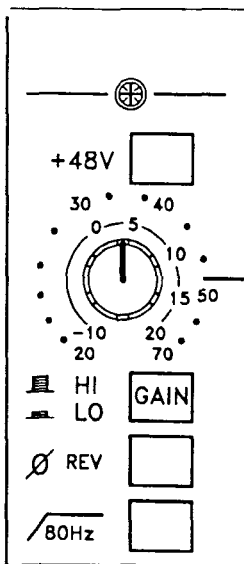

Press the +48V switch on the input module if phantom power is required.

Select the microphone input on channel 1 by having the HI/LO switch in the UP position.

Turn up the input gain control on channel 1 until the signal present led is on but not so high that the peak led is on when speaking into the microphone.

Place the channel 1 fader close to the 0dB calibration mark and press the routing button labelled MIX. This will route the signal to the stereo output of the console.

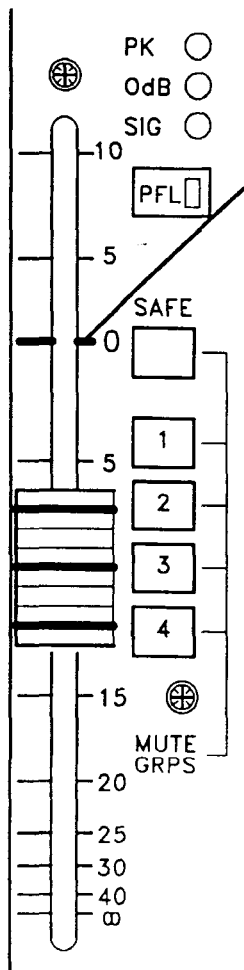
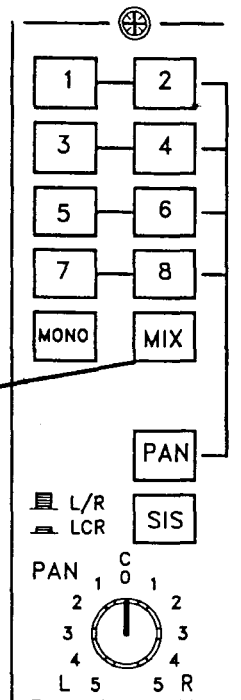

MIX

0dB Calibration

On the master module ensure that the monitor source button is in the UP position and that the MIX switch is pressed. Push the master faders up to 0dB calibration point and you will now see the microphone signal on the left and right output meters. Increase the monitor level control and you will hear the microphone.

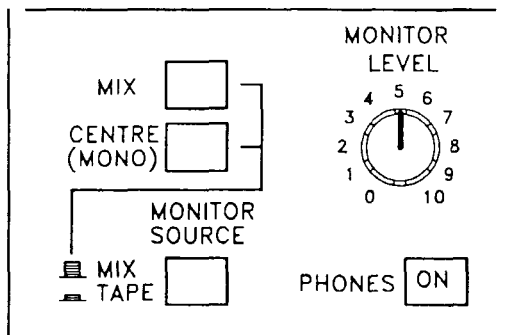

Beware of feedback if the loudspeakers and microphone are located close to one and other.

Plug headphones into the headphone socket located under the armrest and press the PHONES ON button on the master module. You will now hear the signal on your headphones.

Try pressing the PFL button on the input module that you are using and note that you can see the microphone signal on the left meter. This should now be independent of the channel fader setting and is known as the pre fade signal. It can be used to check the input signal without it being routed or passed to any output.

QUICKSTART SETUP

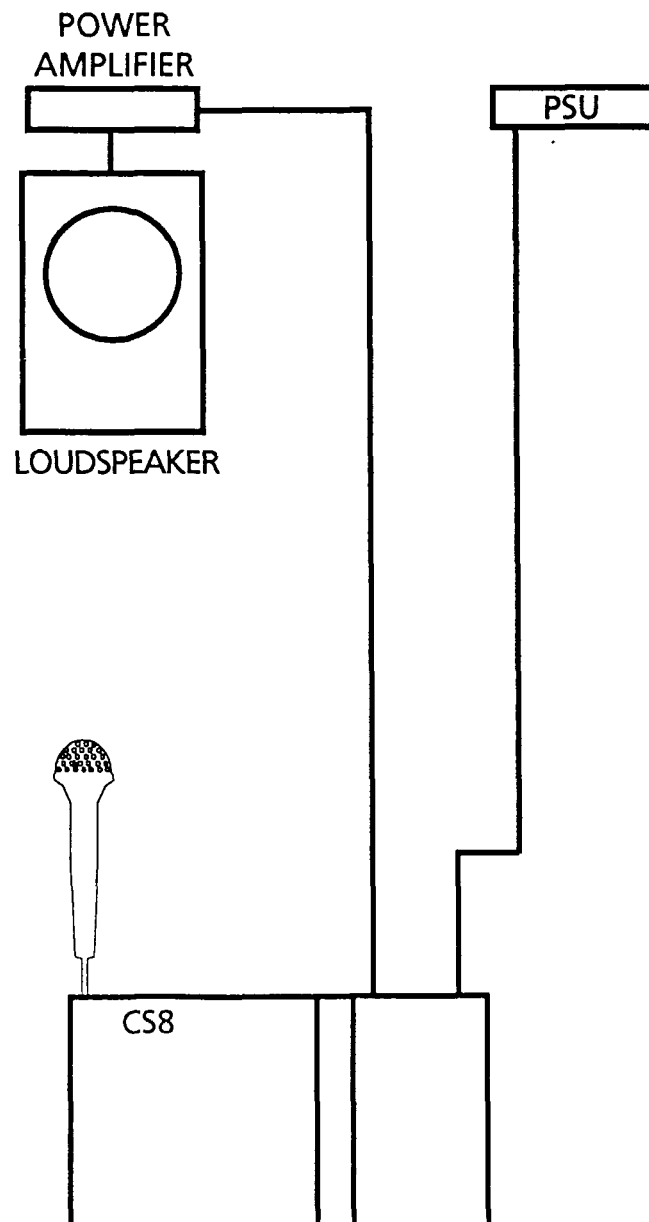

CS8 SPECIFICATIONS

Nominal Operating Level +4dBu with a unity gain structure.

Frequency Response 20Hz - 20kHz +/-0.5dB any input to any output at a gain < 50dB.

EQ range

HF +/-15dB @ 10kHz shelving

LF +/-15dB @ 100Hz shelving

Hi Mid +/-15dB 470Hz - 15kHz, Q = 1.4

Lo Mid +/-15dB 70Hz - 2.2kHz, Q = 1.4

Channel Routing Attenuation > 90dB @ 1kHz

Channel Mute Attenuation > 95dB @ 1kHz

Channel Fader Attenuation > 85dB @ 1kHz

Distortion

0.005% @1kHz any input to any output at a gain < 50dB.

Noise: -82dBu (24 channels routed and cut)

EIN: -127.5dBu ref 200 ohms

EIN: -128.7dBu ref 150 ohms

Maximum output level: +20dBu into a bridging load

Output impedance: <75R

Maximum input level: +30dBu

Phono connector levels: Nominal -10dBV

Signal present threshold: -21dBu

Peak led threshold: 3dB below clipping

Power consumption: < 600 Watts

OPTIONS

Input transformers

Output transformers

LED Meterbridge

Flight case

VU Meterbridge

Multipole connectors

Bus linking cable

Spare power supply with auto switchover.

CS8 DIMENSIONS AND WEIGHTS

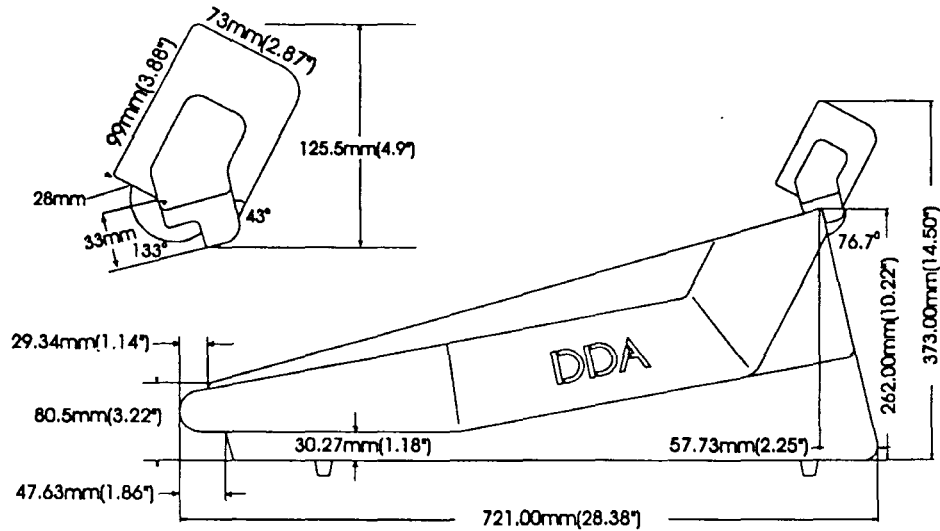
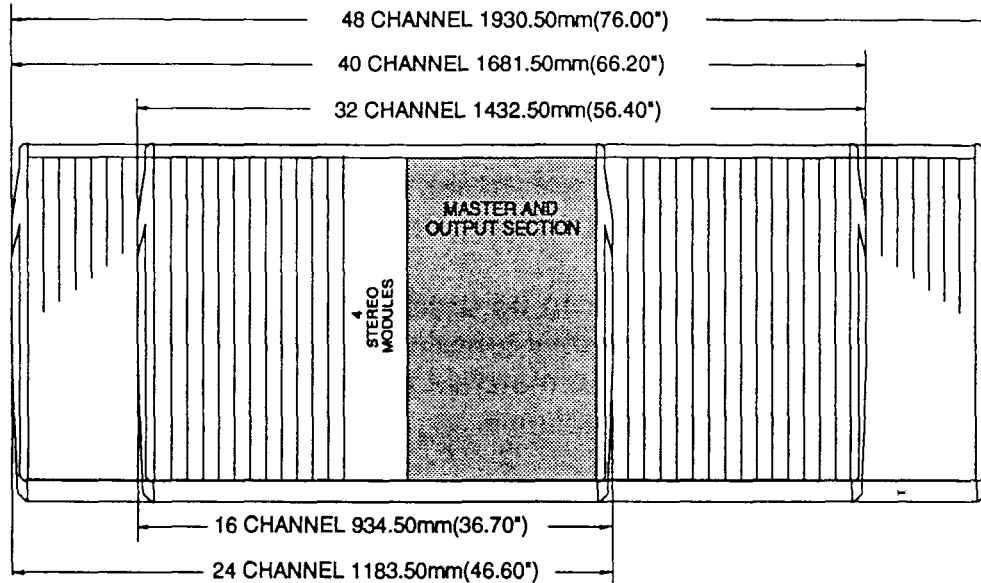

Meterbridge Widths:

VU 46.6 inches/1183.5mm (This cannot be fitted to a 16 input console)
 LED As per corresponding console width.

Weights (packed):

Frame Size	Console	LED Meterbridge
16	26.4kg/58lbs	4.7kg/10.4lbs
24	36kg/80lbs	6.0kg/13.3lbs
32	45.6kg/100lbs	7.4kg/16.3lbs
40	55.2kg/122lbs	8.6kg/19.0lbs
48	64.8kg/143lbs	10.0kg/22.0lbs

VU Meterbridge 6.5kg/14.5lbs

These weights assume a fully fitted console. Meterbridges are shipped in with the console packing but not mounted on the console.

Power Supply Weight (packed): 7.8kg(17.2lbs)

Dimensions: 2U Rack Mounting with a depth of 265mm(10.43")

THE INPUT SECTION

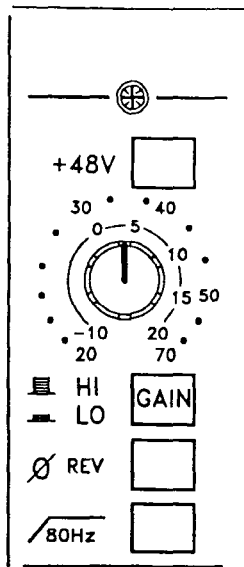

+48V

Provides 48 volt phantom power for a condenser microphone, or D.I. box. The +48V ON switch on the master module must be ON for phantom power to operate. Optional balancing transformers may be fitted on the Mic/Line input.

GAIN CONTROL

The gain control is a wide range rotary potentiometer which is active on both Mic and Line Inputs. With HI GAIN selected the gain can be adjusted from 20dB to 70dB while for LO GAIN the adjustment is from -10dB to +20dB.

HI/LO GAIN

When pressed this inserts an attenuator into the signal path and alters the range of gain adjustment available. This should be used when high level or line level signals are connected to the channel through the line input jack. Note that if a jack is not inserted into the line input socket then the XLR connector may be used as the line input.

Ø REV

Pressing this reverses the phase (strictly the polarity) of the input signal. This may be useful if a microphone has a reversed output compared with other microphones in use or if a cable is swapping the polarity of the signal. Under some circumstances the phase switch can also be used to reduce the spill between microphones although great care is needed to avoid degrading the required signal.

/80Hz

This switch inserts an 80Hz highpass filter with a rolloff of 18dB per octave into circuit after the input amplifier. This may be used to eliminate unwanted low-frequency noises transmitted to the microphone through a floorstand for example.

EQUALISER

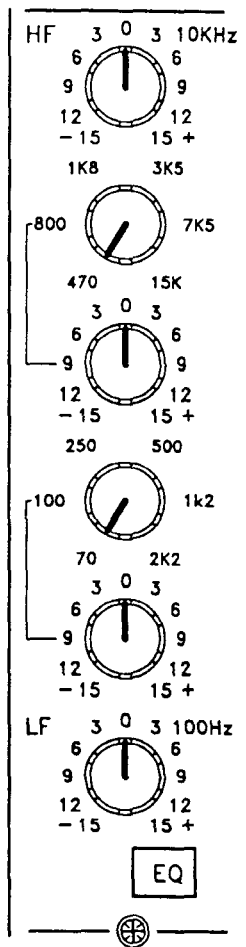

The equaliser on the input module is a four band design, incorporating two swept mid-range sections and fixed frequency shelving high and low frequency sections.

HF

A high frequency equaliser providing 15dB of boost or cut at 10kHz.

HI MID

A swept middle frequency equaliser, providing 15dB of boost or cut. The frequency is adjustable from 470Hz to 15kHz and the equaliser has a Q of 1.4. Q is a way of describing the range of frequencies that the equaliser will affect — with a low Q covering more frequencies than a high Q. It can also be stated as Bandwidth or width and a Q of 1.4 is equivalent to a bandwidth of about 1 octave.

LO MID

A swept middle frequency equaliser, providing 15dB of boost or cut. The frequency is adjustable from 70Hz to 2k2Hz and the equaliser has a Q of 1.4.

LF

A low frequency equaliser providing 15dB of boost or cut at 100Hz.

EQ

This switch allows the equaliser to be switched in and out of circuit. It may be used to minimise the signal path when the equaliser is not in use. It is also possible to make instant comparisons between the equalised and unequalised signal by using this switch.

INSERT POINT

An insert point is located after the EQ section allowing the introduction of an effect unit or similar into the signal path. Insert points allow the signal path in the module to be broken and for an effect device such as a compressor to be inserted. With no jack inserted signal is normalled through to the insert return point but when a jack is inserted this path is broken and the signal from the jack is forced out of the module through the effect unit and back through the insert return to join the main signal path again.

The following graphs illustrate the frequency response of the different equaliser sections.

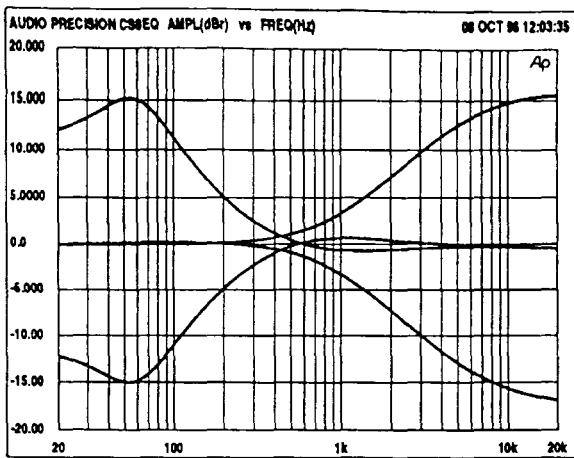

THE HIGH AND LOW FREQUENCY EQUALISER RESPONSE

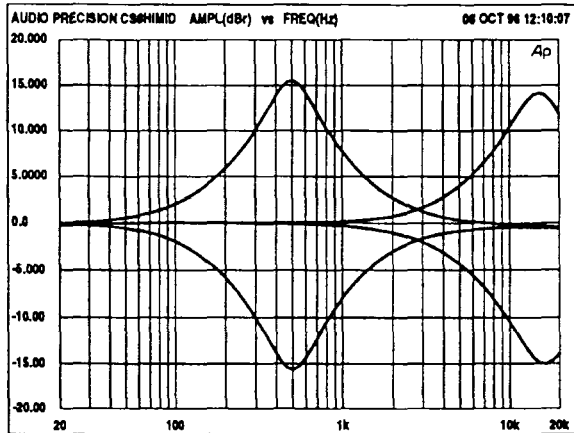

THE HI-MID FREQUENCY EQUALISER RESPONSE SHOWING FREQUENCY RANGE

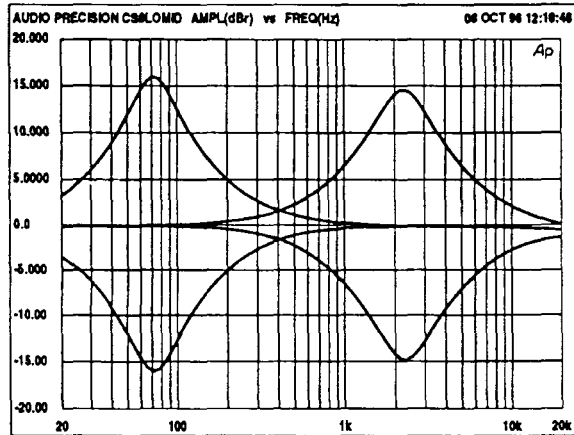

THE LO-MID FREQUENCY EQUALISER RESPONSE SHOWING FREQUENCY RANGE

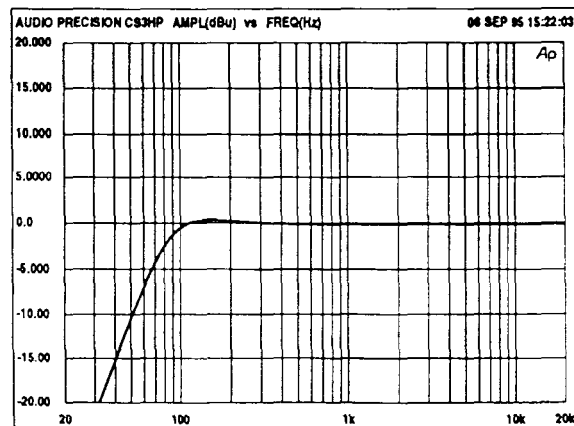

THE HIGH PASS FILTER RESPONSE.

AUXILIARIES

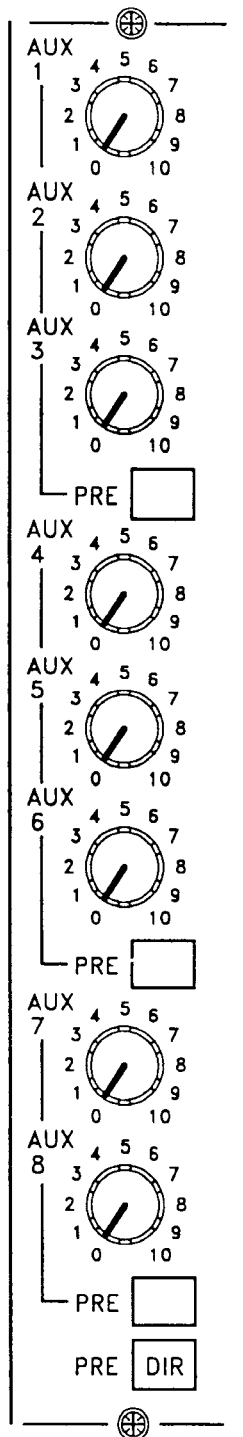

Auxiliary outputs have many uses and it is probably simplest to consider the auxiliaries as additional mixing buses. They can be used to send signal to an effect unit such as a reverberation device or to develop another mix for use as foldback or monitoring.

Each auxiliary has a master level control which equates to the master faders of the console. This controls the output level of the auxiliary and the contributions from individual channels can be adjusted using the controls located on the modules. Signals to the auxiliary sends can be switched pre or post fader. In pre fade mode the auxiliary signal will only depend upon the position of the auxiliary send control but in post mode the signal will depend both upon the channel fader position and the position of the auxiliary send control.

There are two pre fade signals, one is taken from before the equaliser and is always present while the second is taken immediately before the fader but will mute if the channel is muted. If required this auxiliary mute can be disabled by removing link 1 and inserting link 2. Selection of the pre-fade signal is made by removing and installing links according to the table on page 25. Normally the pre fader post mute signal is used to feed the auxiliaries.

There are eight auxiliary outputs. Additionally, the channel direct output may be used to provide a dedicated auxiliary send.

AUX 1

Controls the level of the channel signal fed to Auxiliary 1.

AUX 2

Controls the level of the channel signal fed to Auxiliary 2.

AUX 3

Controls the level of the channel signal fed to Auxiliary 3.

PRE

Changes the auxiliary 1-3 signals from being post fade to pre fade.

AUX 4

Controls the level of the channel signal fed to Auxiliary 4.

AUX 5

Controls the level of the channel signal fed to Auxiliary 5.

AUX 6

Controls the level of the channel signal fed to Auxiliary 6.

PRE

Changes the auxiliary 4-6 signals from being post fade to pre fade.

AUX 7/AUX 8

Controls the level of the channel signal fed to Auxiliary 7.

PRE

Changes the auxiliary 7-8 signals from being post fade to pre fade.

PRE DIR

Changes the DIRECT OUTPUT signal from a post fader signal to a pre fader signal. Normally the pre-equaliser signal is used, however, a post equaliser signal may be link selected.

THE DIRECT OUTPUT

Direct outputs can be used to feed effects devices or even the inputs to a multi-track tape recorder. The Direct Output can be selected to be pre or post fader by the PRE DIR switch. Only the signal going through the module is available on the direct output and no mixing with signals from other channels can take place inside the console. The Direct Output can be switched to the pre equaliser signal using the front panel mounted PRE DIR switch.

ROUTING AND STATUS

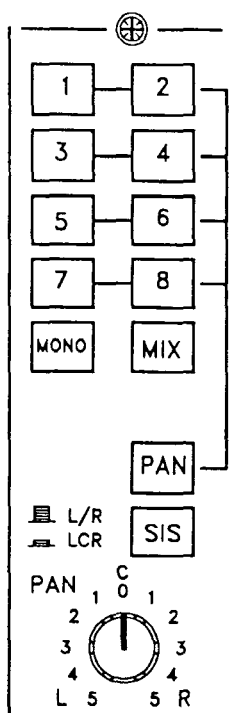

ROUTING AND PANNING

Routing switches allow the signal to be sent to the various console outputs. In addition to the groups it is possible to send to the L/R (stereo) mix bus and the Centre (mono) bus.

The pan control allows a mono signal to be panned or spread across a pair of groups or the stereo mix creating a stereo signal from a mono one. The pan control effectively splits the signal into left and right components with their amplitudes depending upon the rotation of the control. In the centre position equal levels will be sent to both left and right or odd and even groups. If panned hard left then the left signal will be 3dB higher than with the pan control in the centre position while there will be no signal on the right side. This situation is reversed with a hard right pan.

SPATIAL IMAGING SYSTEM

The SIS™ system allows the console to be used in surround sound systems. In addition to the Left and Right buses there is a Centre bus which can be used as a stand alone mono bus or for panning to when the SIS button is depressed. The CS8 has three loudspeaker outputs allowing true LCR monitoring of the three main console outputs. The SIS brochure, available through your dealer, fully explains the SIS concepts.

1-8

These switches route the post fader signal to the groups. When panning to the groups and odd an even group must be used as the stereo pair.

MONO

Routes the post fader signal to the mono or centre bus. In L/R pan mode with MIX selected no signal will be routed to the mono output if this switch is not depressed. With the pan control in LCR(SIS) mode and MIX selected the centre output of the pan pot is routed to the mono or centre bus without this button being pressed. If the button is pressed the centre pan pot output will be replaced by the post fade signal.

MIX

Routes the post-fade, post-pan channel signal to the stereo mix bus or the left, centre and right buses if LCR(SIS) panning is selected.

PAN (Switch)

This assigns the post pan pot signal to the groups. An odd and an even group should be used. Left panned signal will go to odd groups while right panned signals will go to even groups.

SIS — L/R (L/C/R)

This changes the pan pot from a stereo pan pot to a left, centre, right pan pot.

PAN (Control)

This pans the signal across the selected buses. Operation depends upon whether L/R or L/C/R mode is selected. L/R mode pans the signal across the left and right outputs of the console while L/C/R mode pans the signal across the left, centre and right buses.

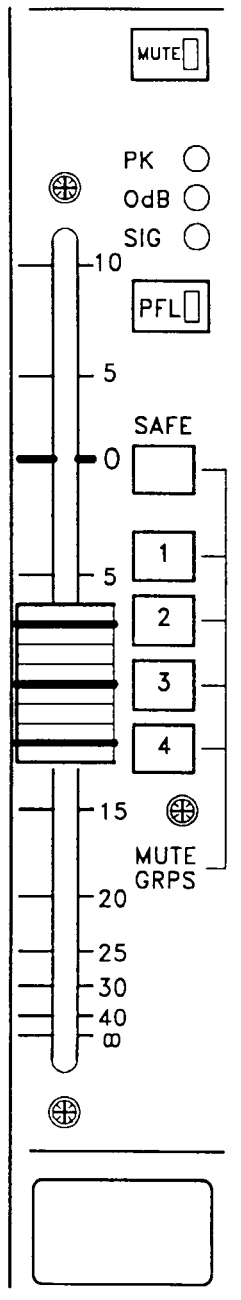

MUTE

This switch mutes the signal. Indication of a MUTE is given by an led in the switch. All post-fade auxiliary sends and routing assignments are muted in addition to the pre fade, post mute sends.

The MUTE function can be remotely controlled through the rear panel REMOTE connector. Mute information from the module can also be sent to other channels within the console or to an external device such as a midi sequencer.

PK

This led (light emitting diode) indicates when the pre fade signal is approaching clipping level. If clipping occurs the signal will be severely distorted and the channel input gain should be reduced.

0dB

Indicates when the pre fade signal is at or above 0dB.

SIG

This led shows when signal is present in the channel and can be a useful aid on occasions when no output can be found from the console.

PFL

The PFL button feeds the post insert return signal to the Monitor Section (loudspeakers or headphones), replacing the selected monitor source. The main stereo and centre outputs of

the console are not affected unless SIP operation is selected on the master module. The led in the PFL switch will illuminate when the PFL function is active and PFL signals from different channels that are active simultaneously will be mixed together. If **Solo In Place** mode is selected then all other channels on the console will be muted while only the channel initiating the solo will be heard. This allows signals to be previewed exactly as they will appear in a mix but in isolation.

MUTE GROUPS 1-4

These assign the module to one or more of the 4 mute groups. As a master mute switch is pressed on the master module any modules assigned to that mute group will be muted. The local MUTE switch will illuminate to indicate a group mute.

SAFE

This prevents a channel from responding to the mute groups without deassigning it.

FADER

The fader is the main signal level control for the channel, and is a long-throw type to give smooth control of the channel level. Note that the fader is calibrated and the normal operating position is expected to be close to the 0dB mark.

If the fader is significantly lower than this then the input signal is too high and either the input gain control (near the top of the module) should be reduced or the GAIN switch pressed to select a line level input (LO). If this action is not taken distortion may result.

If the fader has to be pushed above the 0dB point then this indicates that the input signal is low and that the input gain should be increased or the GAIN switch set for microphone operation (HI). If this action is not taken the signal may contain more noise than necessary.

INPUT MODULE LINKS

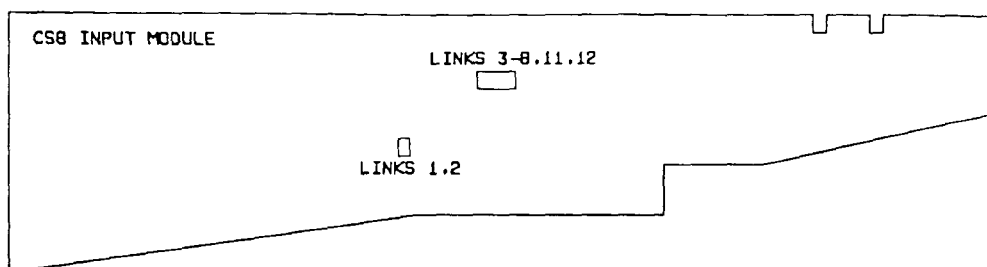

INPUT MODULE PC1394			
LINK	FUNCTION	FITTED AS SUPPLIED	NOTES
1	AUXILIARY CUT ENABLE	YES	INSTALL ONLY ONE LINK
2	AUXILIARY CUT DISABLE		
3	PRE FADER TO AUX 1-3	YES	INSTALL ONLY ONE LINK
4	PRE EQ TO AUX 1-3		
5	PRE EQ TO AUX 4-6		INSTALL ONLY ONE LINK
6	PRE FADER TO AUX 4-6	YES	
7	PRE EQ TO AUX 7-8		INSTALL ONLY ONE LINK
8	PRE FADER TO AUX 7-8	YES	
9	N/A		
10	N/A		
11	PRE EQ TO DIR OUT	YES	INSTALL ONLY ONE LINK
12	POST EQ TO DIR OUT		

The above links will not normally require alteration unless the console is reconfigured.

Auxiliary Link Options

Auxiliaries 1-3

Link 3 is normally installed causing the pre fade signal fed to auxiliaries 1, 2 and 3 to be pre fade post mute, meaning they will mute if the channel is muted. Link 4 will make the signal pre equaliser and independent of the mute.

Auxiliaries 4-6

Link 6 is normally installed causing the pre fade signal fed to auxiliaries 4, 5 and 6 to be pre fade post mute, meaning they will mute if the channel is muted. Link 5 will make the signal pre equaliser and independent of the mute.

Auxiliaries 7-8

Link 8 is normally installed causing the pre fade signal fed to auxiliaries 7 and 8 to be pre fade post mute, meaning they will mute if the channel is muted. Link 7 will make the signal pre equaliser and independent of the mute.

CS8 MONO INPUT BLOCK DIAGRAM

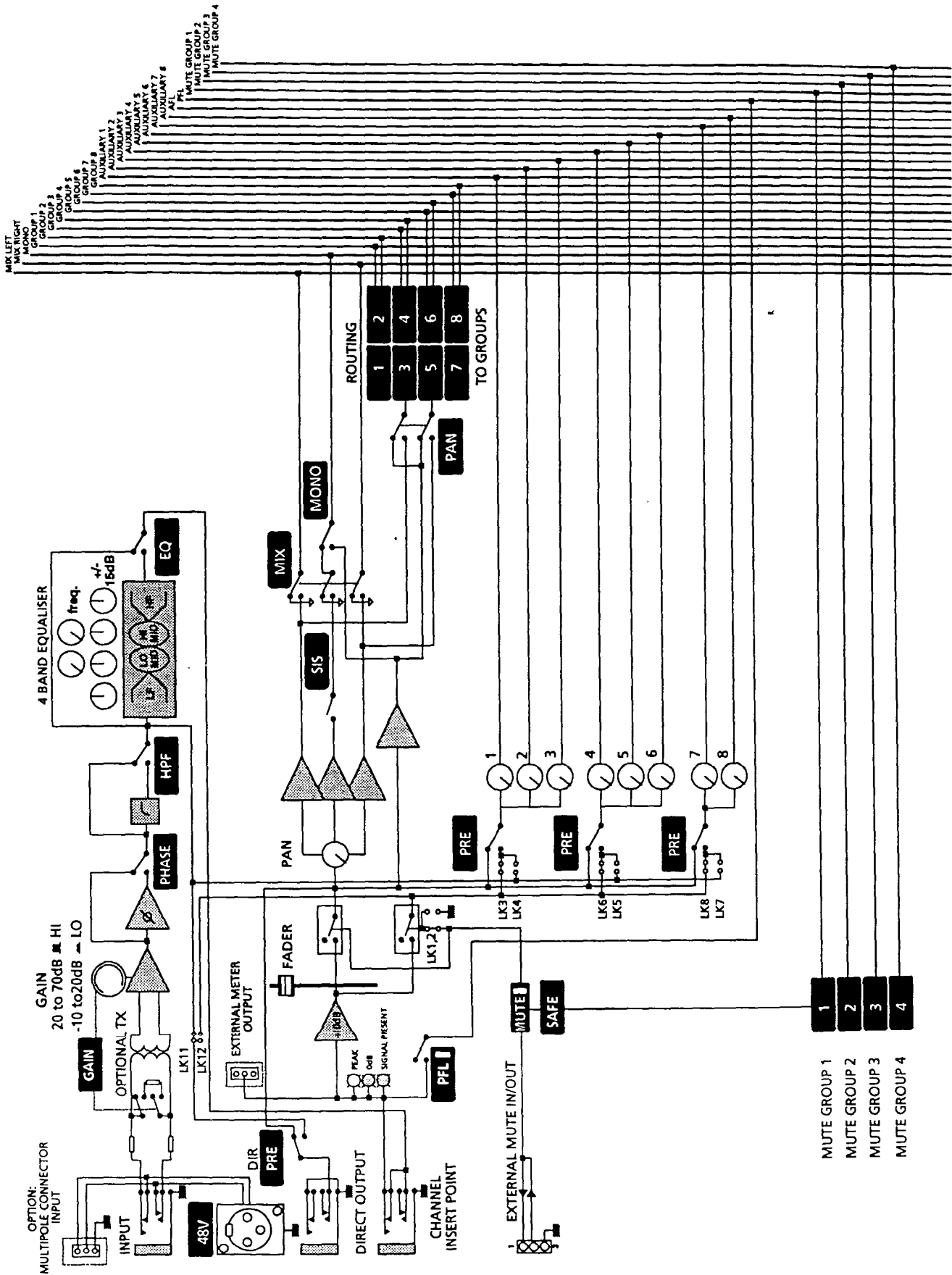

THE STEREO INPUT MODULE

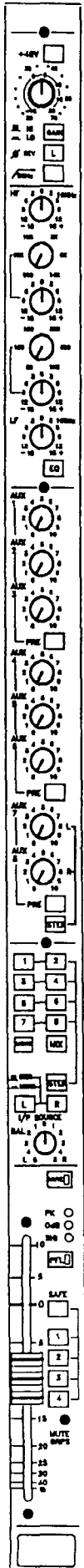

The stereo input module is designed to complement the mono input module. The inputs can be at either microphone (low) level or line (high) level and selection is made by using the GAIN HI/LO switch. Normally four stereo modules will be mounted to the left of the master module within a block of 8 channels.

In the case that the module can only be fed with a mono source then either the left or right input can be used in conjunction with the L and R switches. These allow only the left or right input to be fed through the stereo signal path. If two mono signals were presented to the module these switches could be used to select the required input.

In the case that a stereo input needs to be mixed to mono both L and R buttons can be pressed and a mono version of the input signal will be created and fed through the stereo signal path.

Auxiliaries 7 and 8 may be used as a stereo send by pressing the STEREO button otherwise they will carry mono versions of the input signal as do the other auxiliaries. When used in stereo there is no pan control but the level to 7 and 8 can be independently adjusted to position the stereo image.

Routing is through independent switches and they must be used in ODD/EVEN pairs to achieve stereo routing to the groups. Routing to the MIX is in full stereo.

THE INPUT SECTION

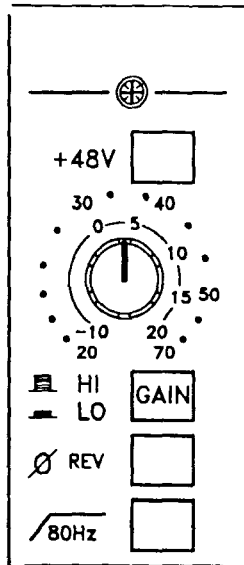

+48V

Provides 48 volt phantom power for a condenser microphone, or D.I. box. The +48V ON switch on the master module must be ON for phantom power to operate. Optional balancing transformers may be fitted on the Mic/Line input.

GAIN

The gain control is a wide range rotary potentiometer which is active on both Mic and Line Inputs. With HI GAIN selected the gain can be adjusted from 20dB to 70dB while for LO GAIN the adjustment is from -10dB to +20dB.

HI/LO GAIN

Pressing this inserts an attenuator into the signal path and alters the range of gain adjustment available. This should be used when high level or line level signals are connected to the channel through the line input jack. Note that if a jack is not inserted into the line input socket then the XLR connector may be used as the line input. The TRS jack could also be used as a microphone input although it is not recommended and phantom power will not be available.

Ø REV

Pressing this reverses the phase (strictly the polarity) of the left input signal. This should only be used when a stereo signal has a phase or polarity difference between the left and right signals.

80Hz

This switch inserts an 80Hz highpass filter with a rolloff of 18dB per octave into circuit after the input amplifier. This may be used to eliminate unwanted low-frequency noises transmitted to the microphone through a floorstand for example.

EQUALISER

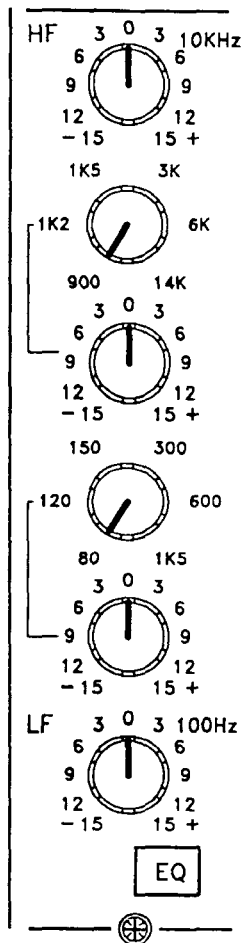

The equaliser on the stereo input module is a four band design, incorporating a swept lo-mid section, a swept hi-mid section and fixed frequency, shelving, high and low frequency sections.

HF

A high frequency equaliser, providing 15dB of boost or cut at 10kHz.

HI-MID

A swept middle frequency equaliser, providing 15dB of boost or cut. The frequency is adjustable from 900Hz to 14kHz and the equaliser has a Q of 1.4.

LO-MID

A swept middle frequency equaliser, providing 15dB of boost or cut. The frequency is adjustable from 80Hz to 1.5kHz and the equaliser has a Q of 1.4.

LF

A low frequency equaliser, providing 15dB of boost or cut at 100Hz.

EQ IN

This switch allows the equaliser to be switched in and out of circuit. It may be used to minimise the signal path when the equaliser is not in use. It is also possible to make instant comparisons between the equalised and unequalised signal by using this switch.

AUXILIARIES

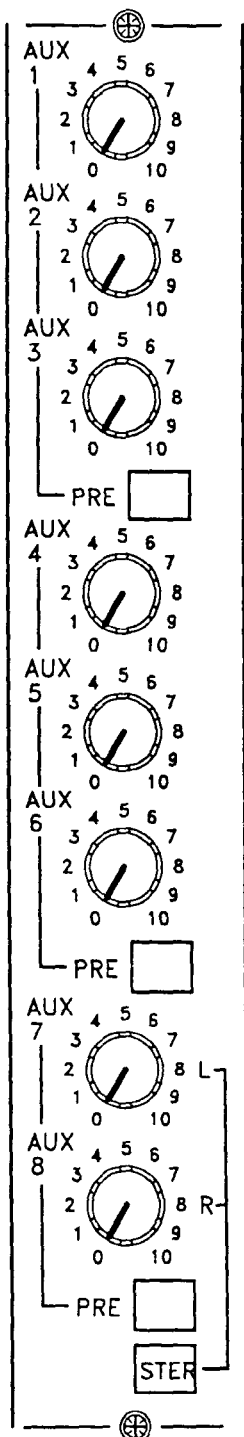

There are eight auxiliary sends available on the console with the outputs located on the master module. Auxiliaries 7 and 8 may be used as a stereo pair if required.

AUX 1, AUX 2, AUX 3

These control the level of the mono summed channel signal fed to Auxiliaries 1, 2 and 3.

PRE

Allows the pre fade signals to be routed to the above auxiliaries.

AUX 4, AUX 5, AUX 6

These control the level of the mono summed channel signal fed to Auxiliaries 4, 5 and 6.

PRE

Allows the pre fade signals to be routed to the above auxiliaries.

AUX 7,

This controls the level of the channel signal fed to Auxiliary 7.

AUX 8

This controls the level of the channel signal fed to Auxiliary 8.

PRE

Allows the pre fade signals to be routed to the above auxiliaries.

STER

Auxiliaries 7 and 8 can be used as a stereo pair by depressing this switch. Depending upon the PRE switch either the stereo post fader or the stereo pre fader signals will be used.

The auxiliaries can be used to create additional mixes and in many cases these mixes will be sent to an effects device such as a reverberation unit. Another major use of the auxiliaries is providing foldback to artists in order that they can hear other performers or a backing track.

Sometimes stereo foldback is preferred and auxiliaries 7 and 8 can be configured for stereo use. It is even possible to send stereo foldback from the mono inputs by adjusting the levels sent to auxiliaries 7 and 8. When the levels are equal the image will appear central but by reducing the left output (auxiliary 7) the image will appear to move to the right and of course when the right output is reduced (auxiliary 8) the image will appear to move to the left hand side.

AUXILIARY LINKING

1-3

Link 3 is normally installed giving the pre fade post mute signal. If link 3 is removed and link 4 installed the signal becomes the pre equaliser signal.

4-6

Link 6 is normally installed giving the pre fade post mute signal. If link 6 is removed and link 7 installed the signal becomes the pre equaliser signal.

7-8

Link 11 is normally installed giving the pre fade post mute signal. If link 11 is removed and link 12 installed the signal becomes the pre equaliser signal. If stereo operation is selected then links 21 and 22 are normally installed giving the pre fader post mute signals. If links 17 and 18 are installed in place of links 21 and 22 then the pre equaliser signals are used.

ROUTING AND STATUS

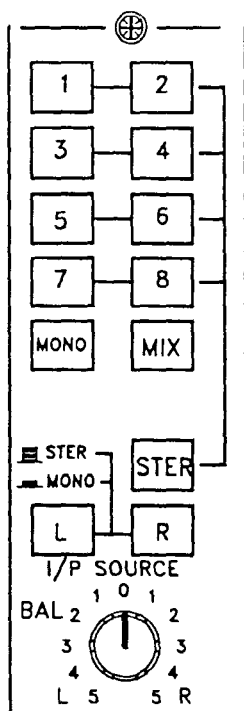

1-8

These switches route the mono post fader signal to the groups.

MONO

Routes the mono post fader signal to the mono or centre bus.

MIX

Routes the post-fade, post-balance channel signal to the stereo mix bus.

STER

This assigns the post BALANCE stereo signal to the groups. An odd and an even group should be used. Left panned signal will go to odd groups while right panned signals will go to even groups.

L I/P SOURCE

This cuts the RIGHT input signal replacing it with the LEFT input signal. Thus the module carries the left input signal only through the stereo signal path.

R I/P SOURCE

This cuts the LEFT input signal replacing it with the RIGHT input signal. Thus the module carries the right input signal only through the stereo signal path.

If both the above switches are pressed then the left and right input signals are combined to mono and fed through both signal paths in the module.

BAL

This alters the relative left and right levels of the stereo signal onto the left and right buses of the console. It works as a pan control giving full attenuation of the unwanted side at extremes of travel. A balance control with a more limited range of operation can be made from the pan control. (Please refer to the technical manual for this.)

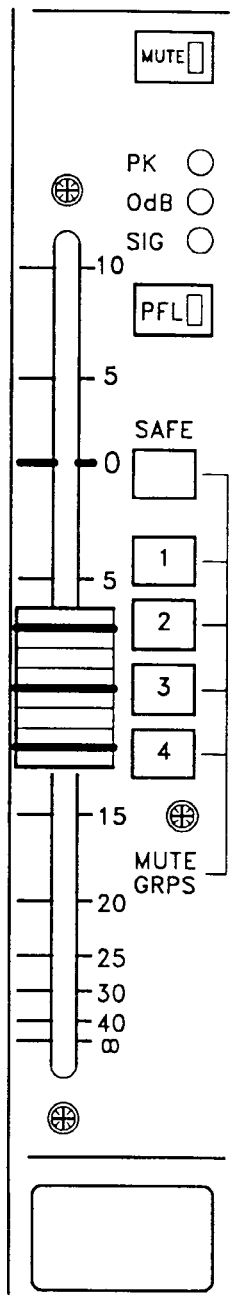

MUTE

This switch mutes the signal. Indication of a MUTE is given by an led in the switch. All post-fade auxiliary sends and routing assignments are muted in addition to the pre fade, post mute sends.

The MUTE function can be remotely controlled through the rear panel REMOTE connector. Mute information from the module can also be sent to other channels within the console or to an external device such as a midi sequencer.

PK

This led (light emitting diode) illuminates when the signal is getting close to clipping level. If clipping occurs the signal will be severely distorted and the channel input gain should be reduced. A single led is used to indicate the higher of the left and right signals.

0dB

Indicates when the pre fade signal is at or above 0dB. A single led is used to indicate the higher of the left and right signals.

SIG

This led shows when signal is present in the channel and can be a useful aid on occasions when no output can be found from the console. A single led is used to indicate signal on either or both of the left/right signal paths.

PFL

The PFL button feeds the post insert return signal to the Monitor Section (loudspeakers or headphones), replacing the selected monitor source. The main stereo and centre outputs of the console are not affected unless SIP operation is selected on the master module. The led in the PFL switch will illuminate when the PFL function is active and PFL signals from different channels that are active simultaneously will be mixed together. If Solo In Place mode is selected then all other channels on the console will be muted while only the channel initiating the solo will be heard. This allows signals to be previewed exactly as they will appear in a mix but in isolation.

SAFE

This prevents a channel from responding to the mute groups without deassigning it.

MUTE GROUPS 1-4

These assign the module to one or more of the 4 mute groups. As a master mute switch is pressed on the master module any modules assigned to that mute group will be muted. The local MUTE button will illuminate during a group mute.

FADER

The fader is the main signal level control for the channel, and is a long-throw type giving smooth control of the channel level. Note that the fader is calibrated and the normal operating position is expected to be close to the 0dB mark.

If the fader is significantly lower than this then the input signal is too high and either the input gain control (near the top of the module) should be reduced or the GAIN switch pressed to select the line input (LO). If this action is not taken distortion may result.

If the fader has to be pushed above the 0dB point then this indicates that the input signal is low and that the input gain should be increased or the GAIN switch set for microphone operation (HI). If this action is not taken the signal may contain more noise than necessary.

CONNECTORS AND PIN DEFINITIONS

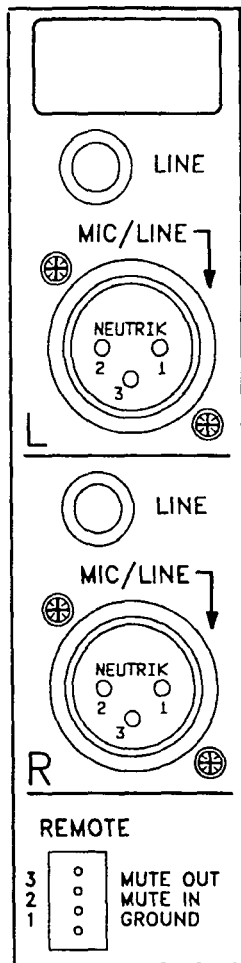

Line Input : 1/4" TRS Jack Socket,
'A' Gauge, Balanced
Nominal Input Level: -16dBu to +14dBu
Tip : Signal +ve (Hot)
Ring : Signal -ve (Cold)
Sleeve: Ground
Input Impedance : >10 kOhm

Mic/Line Input : 3 Pin Female XLR type, Balanced
Nominal Input Level: -16dBu to -66dBu
Pin 2 : Signal +ve (Hot)
Pin 3 : Signal -ve (Cold)
Pin 1 : Ground
Input Impedance : >2 kOhm

Remote Mute Connector

- 1 Ground
- 2 Mute Input Grounding this pin mutes the channel.
- 3 Mute Output This pin is grounded when the CUT switch is depressed.

STEREO INPUT MODULE LINKS

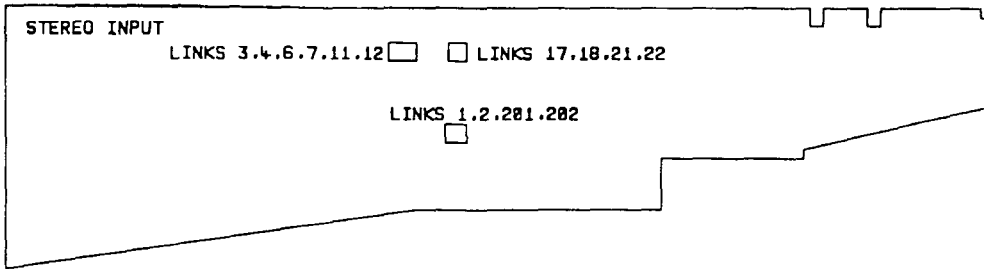

STEREO INPUT MODULE PC1418			
LINK	FUNCTION	FITTED AS SUPPLIED	NOTES
1	AUXILIARY CUT ENABLE (LEFT)	YES	INSTALL ONLY ONE LINK
2	AUXILIARY CUT DISABLE (LEFT)		
3	PRE FADER MONO TO AUX 1-3	YES	INSTALL ONLY ONE LINK
4	PRE EQ MONO TO AUX 1-3		
6	PRE FADER MONO TO AUX 4-6	YES	INSTALL ONLY ONE LINK
7	PRE EQ MONO TO AUX 4-6		
11	PRE FADER MONO TO AUX 7-8	YES	INSTALL ONLY ONE LINK
12	PRE EQ MONO TO AUX 7-8		
17	PRE EQ LEFT TO AUX 7-8		FIT AS A PAIR
18	PRE EQ RIGHT TO AUX 7-8		
21	PRE FADER LEFT TO AUX 7-8	YES	FIT AS A PAIR
22	PRE FADER RIGHT TO AUX 7-8	YES	
201	AUXILIARY CUT ENABLE (RIGHT)	YES	INSTALL ONLY ONE LINK
202	AUXILIARY CUT DISABLE (RIGHT)		

STEREO INPUT MODULE BLOCK DIAGRAM

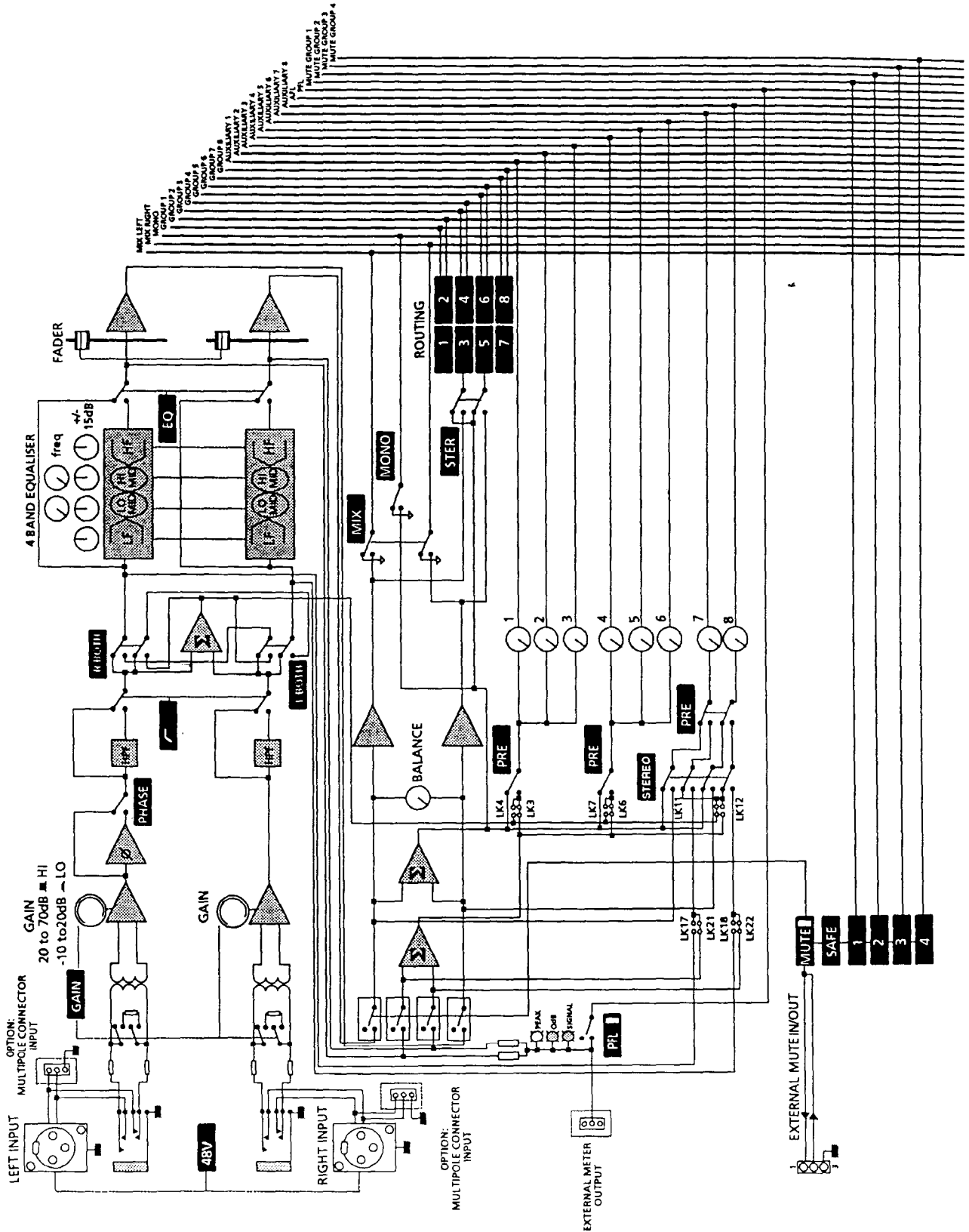

THE GROUP OUTPUT MODULE (1-6)

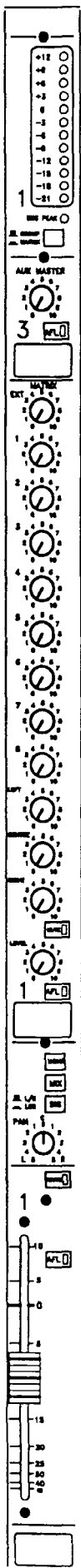

Group modules 1 through 6 contain an auxiliary master output and a matrix in addition to the group output stage. Each matrix output can be derived from the 8 group outputs, the left, centre and right mixes and an external input. All outputs may optionally be transformer balanced and/or paralleled to a multiway connector.

A matrix can be most useful when a number of inputs require to be routed to a number of outputs but not necessarily at the same level. It can be likened to having a small number of additional mixers within the console. In the case of the CS8 the group outputs form many of the inputs to the matrix and there is thus a level control for each of the eight group signals into the matrix section of every output module. The group outputs are bused across the modules horizontally while matrix output 2 for example is the vertical sum of all the signals with their controls turned up on matrix module 2.

Matrices are often used in theatres where feeds to dressing rooms, bar areas, the foyer and other areas are required. With a matrix the output to an area can be precisely controlled without the compromise of using a mix intended for another purpose. Productions using many sound effects may use the matrix to feed the effects to loudspeakers located throughout the auditorium giving very precise localization for the sounds. The Left, Centre and Right matrix feeds can be used to feed the master console outputs to any matrix destination making it very simple to duplicate the front of house mix to different areas.

The group output may be used either to feed a tape recorder or to send to another destination such as a power amplifier. If required the group can be sub mixed down onto the stereo bus of the console. This makes it simple to control the level of all the channels assigned to the group as only the one master fader will alter the level of the entire group. Individual faders on the input channels can of course still be moved to alter the balance within the group.

THE METER SECTION

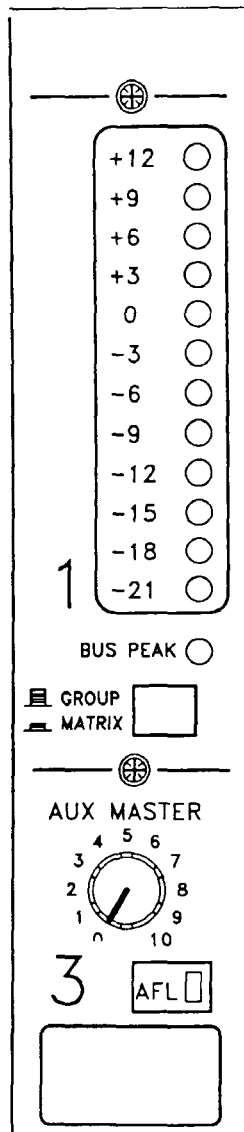

METER

This meter indicates the level of the group or matrix output. It has a PEAK reading characteristic.

BUS PEAK

This indicates when the group or matrix summing amplifier is in danger of running into distortion. The signals routed to the group or matrix should be reduced in level by pulling the input faders down or reducing the input gain of the routed channels.

GROUP/MATRIX

The meter normally reads the group output. With this switch depressed the meter will read the matrix output. Note that the BUS PEAK led will then indicate any peaks on the matrix bus.

THE AUXILIARY MASTER SECTION

AUX MASTER

This adjusts the overall level of an auxiliary send. The illustration shows auxiliary 3.

AFL

This allows the auxiliary send to be checked by switching it through to the monitoring system.

The auxiliary output can then be heard and its level observed on the master meters.

There is a pre fader auxiliary insert point allowing effects units to be inserted into the auxiliary signal path. This allows the effect to be auditioned using the AFL button and keeps the noise from the effect unit proportional to the signal level. Thus if the auxiliary level is reduced the noise from the effect unit will also be reduced.

THE MATRIX SECTION

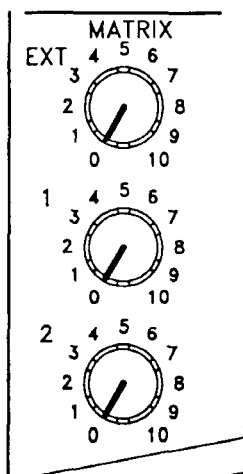

EXT

This adjusts the level of the external input into this channel's matrix output. The external input is a line or high level input.

1-8

This adjusts the level of groups 1-8 into this channel's matrix output.

LEFT

This adjusts the level of left mix into this channel's matrix output.

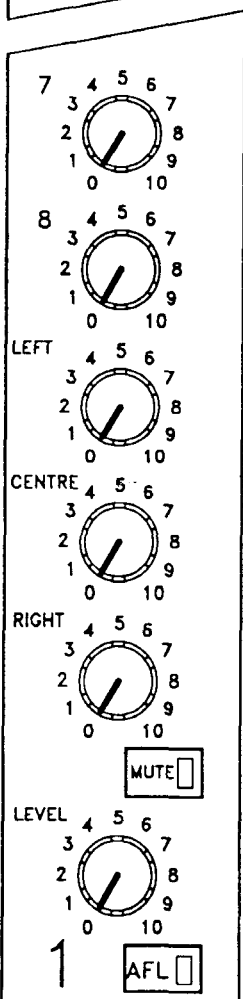

RIGHT

This adjusts the level of the right mix into this channel's matrix output.

CENTRE

This adjusts the level of the centre mix into this channel's matrix output.

MUTE

This mutes the matrix output.

LEVEL

This adjusts the level of the matrix output. The matrix output is the sum of all the above inputs.

AFL

This allows the matrix send to be checked by switching it through to the monitoring system. The matrix output can then be heard and its level observed on the master meters.

There is a pre fader matrix insert point allowing effects units to be inserted into the matrix signal path. This allows the effect to be auditioned using the AFL button and keeps the noise from the effect unit proportional to the signal level. Thus if the auxiliary level is reduced the noise from the effect unit will also be reduced.

THE GROUP OUTPUT SECTION

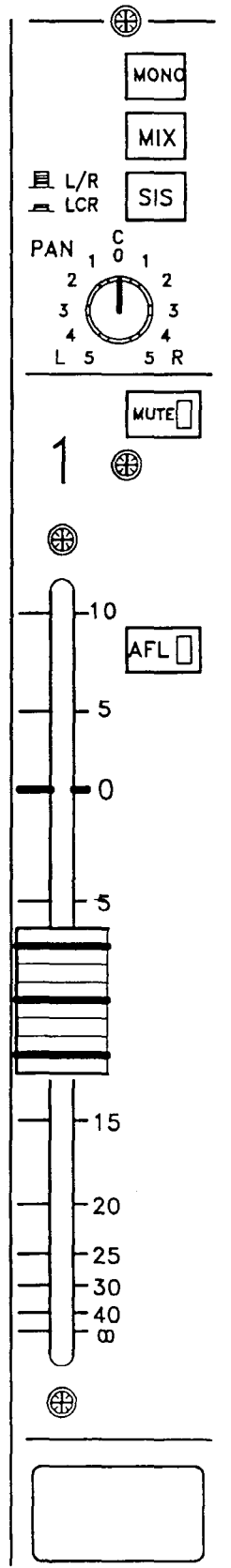

MONO

This feeds the post fade group signal to the mono or centre bus of the console when pressed. In LCR mode the centre output of the pan pot will be replaced by the post fader signal if this switch is pressed. In L/R mode the mono output will not receive a signal until this switch is pressed.

MIX

When MIX is pressed the group signal is sent to the stereo mix. The pan control can be switched to LCR mode and the centre bus will then be fed with the centre output of the pan pot.

SIS — L/R (L/C/R)

This changes the pan pot from L/R mode to LCR mode where the signal will pan between left and centre or right and centre.

MUTE

Pressing this mutes the group signal. An led indicates the MUTE condition.

PAN

This adjusts the relative levels of signal sent to the left and right outputs or the left, centre and right outputs depending upon the selected pan mode when MIX is pressed.

FADER

The fader controls the level of the group output. As with the input module, fader operation close to the 0dB calibration point is expected and any large deviation from this would indicate that the signal from the modules feeding the group is too high or too low.

AFL

This allows the group output to be checked by switching it through to the monitoring system. The group can then be heard and its level observed on the master meters.

CONNECTORS AND PIN DEFINITIONS

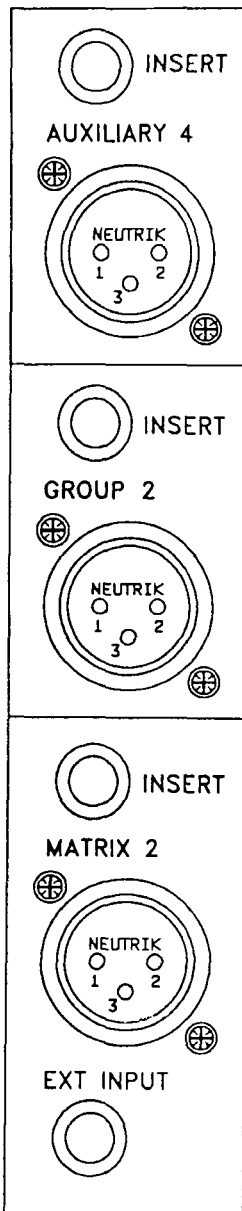

Auxiliary Output : 3 Pin Male XLR type, Balanced
Nominal Input Level: 0dBu
Pin 2 : Signal +ve (Hot)
Pin 3 : Signal -ve (Cold)
Pin 1 : Ground
Output Impedance : < 75 Ohm

Insert Point : 1/4" TRS Jack Socket,
'A' Gauge, Unbalanced
Nominal Input/Output level: 0dBu
Tip : Insert Send
Ring : Insert Return
Sleeve: Ground
Output Impedance : <75 Ohm
Input Impedance : >10 kOhm

Group Output : 3 Pin Male XLR type, Balanced
Nominal Output Level: 0dBu
Pin 2 : Signal +ve (Hot)
Pin 3 : Signal -ve (Cold)
Pin 1 : Ground
Output Impedance : < 75 Ohm

Insert Point : As above

Matrix Output : 3 Pin Male XLR type, Balanced
Nominal Input Level: 0dBu
Pin 2 : Signal +ve (Hot)
Pin 3 : Signal -ve (Cold)
Pin 1 : Ground
Output Impedance : < 75 Ohm

Insert Point : As above

External Input : 1/4" TRS Jack Socket, 'A' Gauge,
Balanced
Nominal Input Level: 0dBu
Tip : Signal +ve (Hot)
Ring : Signal -ve (Cold)
Sleeve: Ground
Input Impedance : >10 kOhm

GROUP MODULE 1-6 LINKS

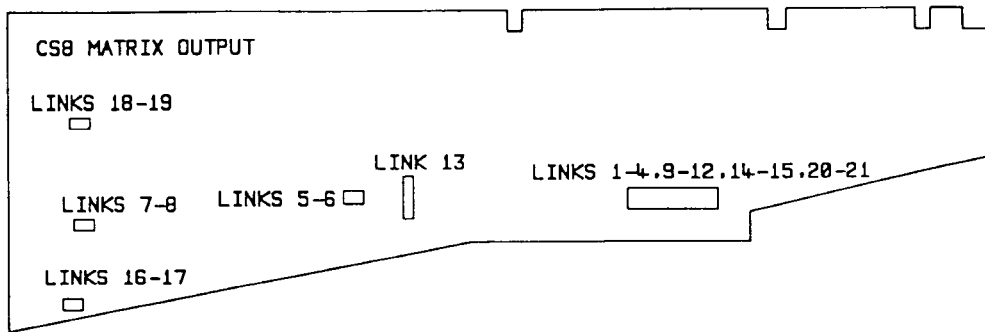

GROUP MODULE 1-6 PC1398			
LINK	FUNCTION	FITTED AS SUPPLIED	NOTES
1	BUS 3 SELECT		MODULE POSITION DEPENDENT
2	BUS 4 SELECT		
3	BUS 5 SELECT		
4	BUS 6 SELECT		
5	MATRIX POST FADER	YES	
6	MATRIX PRE FADER		
7	GROUP OUTPUT TRANSFORMER BYPASS	YES	REMOVE IF AN OUTPUT TRANSFORMER IS FITTED
8	GROUP OUTPUT TRANSFORMER BYPASS	YES	
9	AUX 3 SELECT		MODULE POSITION DEPENDENT
10	AUX 4 SELECT		
11	AUX 5 SELECT		
12	AUX 6 SELECT		
13	MATRIX ASSIGN		
14	N/A		
15	N/A		
16	MATRIX OUTPUT TRANSFORMER BYPASS	YES	REMOVE IF TRANSFORMERS ARE USED
17	MATRIX OUTPUT TRANSFORMER BYPASS	YES	
18	AUXILIARY OUTPUT TRANSFORMER BYPASS	YES	
19	AUXILIARY OUTPUT TRANSFORMER BYPASS	YES	
20	AUX 1 SELECT		MODULE POSITION DEPENDENT
21	AUX 2 SELECT		
22	AUX 7 SELECT		
23	AUX 8 SELECT		
24	BUS 1 SELECT		
25	BUS 2 SELECT		

GROUP MODULE 1— 6 BLOCK DIAGRAM

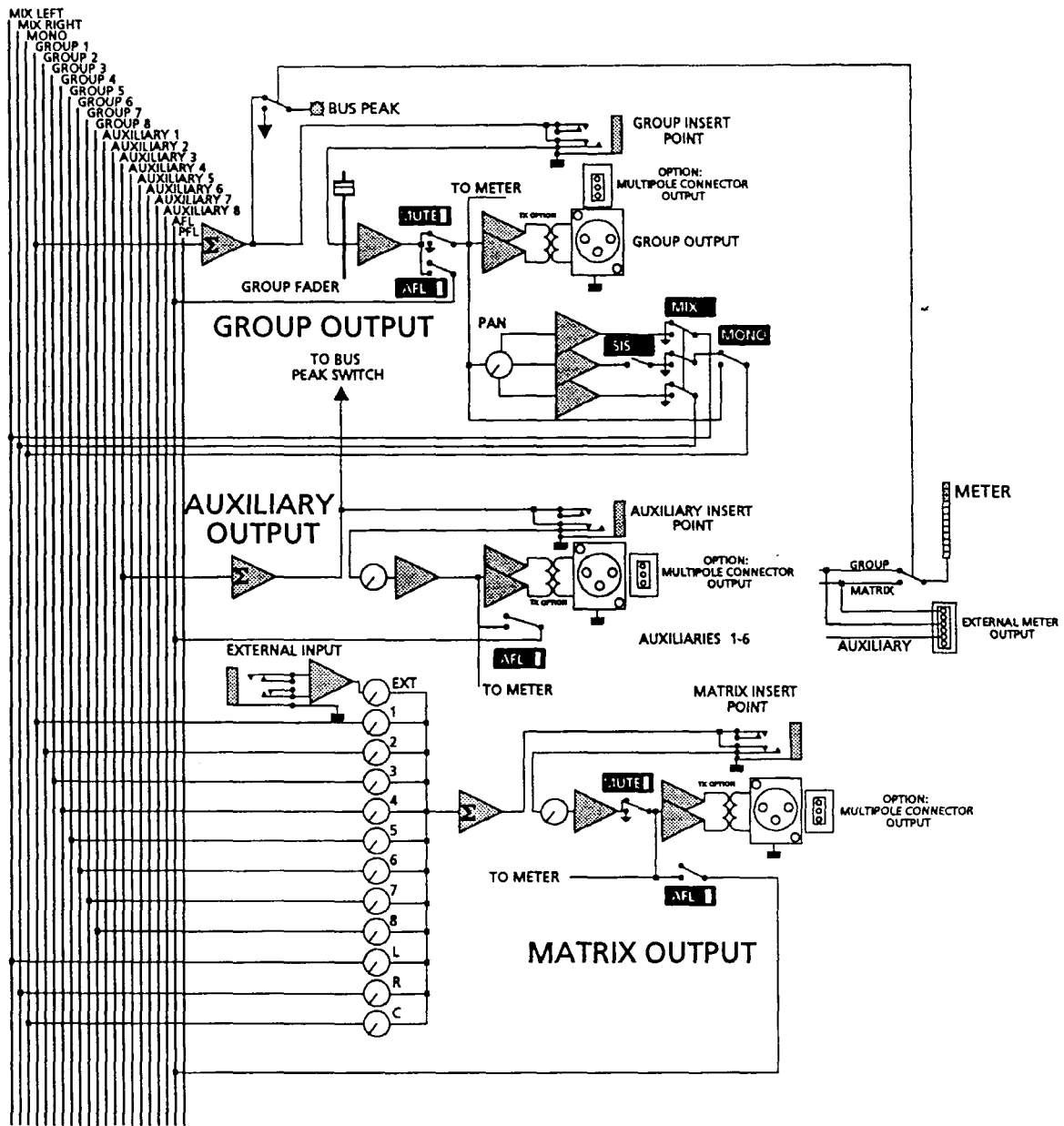

THE GROUP OUTPUT MODULE (7-8)

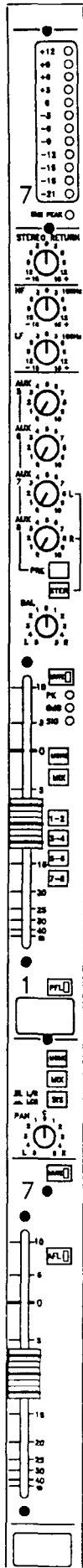

The final two output modules contain a Stereo Return in addition to the Group Output stage. The group outputs are electronically balanced and may optionally be transformer balanced and/or paralleled to a multiway connector. An insert point is provided in the group signal path allowing the connection of external processing devices such as limiter/compressor units.

The stereo returns allow line level stereo (or mono) signals to be fed into the console through a fader for level control, to be level balanced and then to be routed to the group buses or the main L/R or Mono buses. In the event of a large mix they may assist in creating the required number of inputs or if consoles are linked together then they may be used to carry the outputs of the slave console onto the buses of the master console. The input jacks are wired such that if a mono signal is fed to the left input then it will also be routed to the right input through the normalling connections of the jack sockets.

In addition to the stereo returns the CS8 is fitted as standard with 4 fully featured stereo input modules.

A twelve segment led meter reads the signal present on the Group output. It is post fade and post mute and therefore will show no signal if the fader is closed or the group is muted.

The group outputs can be used in their own right as console outputs to be fed to loudspeaker systems or tape machine inputs. They can also be sub mixed onto the main left, right and centre buses of the console creating the ability to control the level of several input channels onto the main buses with one (group) fader.

THE METER SECTION

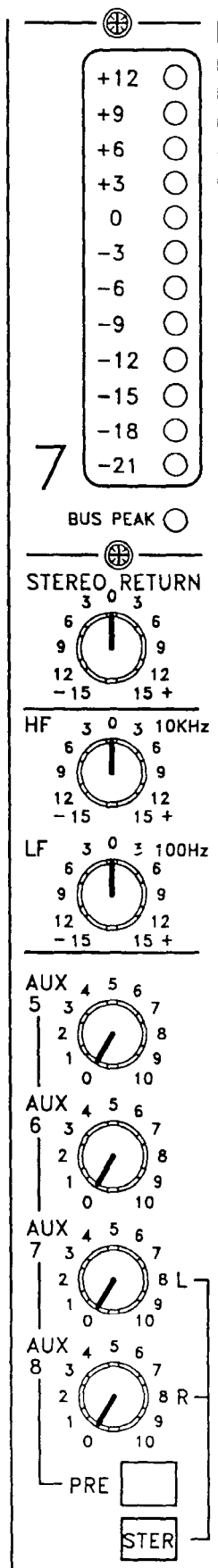

METER

This meter indicates the level of the group output. It has a Peak reading characteristic.

BUS PEAK

This indicates when the group summing amplifier is in danger of running into distortion. The signals routed to the group should be reduced in level by pulling their faders down or reducing the input gain of the routed channels.

STEREO RETURN

This is a high (line) level stereo input that can be routed to the left, right and mono mixes, the group buses and auxiliaries 5, 6, 7 and 8 of the console. It could be used to bring a stereo tape machine into the console or the output of an effect device whether stereo or mono. The input of the effect device would normally be fed from an auxiliary output of the console.

Note that if a mono signal is connected to the left input and nothing is plugged into the right input the signal will be sent to the left and right signal paths. This saves a special cable having to be made for use with mono signal sources. If a mono input is connected to the right input then only the right signal path will receive this signal.

GAIN

Adjusts the input gain of the effect return.

EQUALISER

HF

A high frequency equaliser with 15dB of boost and cut and at 10kHz.

LF

A low frequency equaliser with 15dB of boost and cut at 100Hz.

AUXILIARIES

AUX 5

This adjusts the signal level to auxiliary 5. Normally the signal is post fade and mono.

AUX 6

This adjusts the signal level to auxiliary 6. Normally the signal is post fade and mono.

AUX 7

This adjusts the signal level to auxiliary 7. Normally the signal is post fade and mono.

AUX 8

This adjusts the signal level to auxiliary 8. Normally the signal is post fade and mono.

PRE

This selects the pre fade signal to be sent to the auxiliaries in place of the post fade signal.

STEREO

This selects the stereo pre or post fade signal to be sent to auxiliaries 7 and 8 in place of the mono pre or post fade signals.

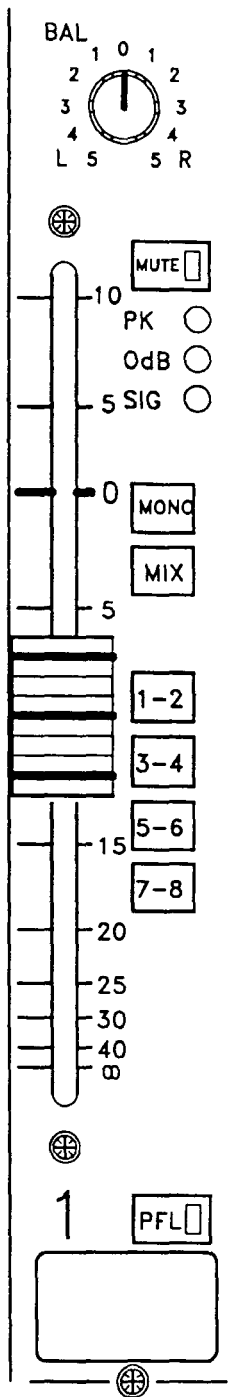

BAL

This adjusts the relative signal levels sent to the left and right groups within the range +3dB to OFF. At the centre detented position equal levels will be sent to the left and right outputs.

MUTE

This mutes the STEREO RETURN signal. An led indicates the MUTE condition.

PK

This led (light emitting diode) illuminates when the return signal is approaching clipping level.

0dB

Indicates when the pre fade stereo return signal is at or above 0dB.

SIG

This led shows when signal is present in the stereo return.

In each case a single led is used to indicate the higher of the left and right signals.

MONO

Routes the return signal to the mono or centre mix. The left and right signals are combined to mono for this.

MIX

Routes the return signal to the L/R stereo mix.

FADER

This is the level control for the return signal, and adjusts the amount of level sent to the routed outputs.

1-2, (3-4), (5-6), (7-8)

Routes the return signal to groups 1 and 2 (or 3-4, 5-6, 7-8).

PFL

This allows the pre fade auxiliary return signal to be soloed. The solo is pre fader and therefore will not depend on the position of the stereo input fader.

THE GROUP OUTPUT SECTION

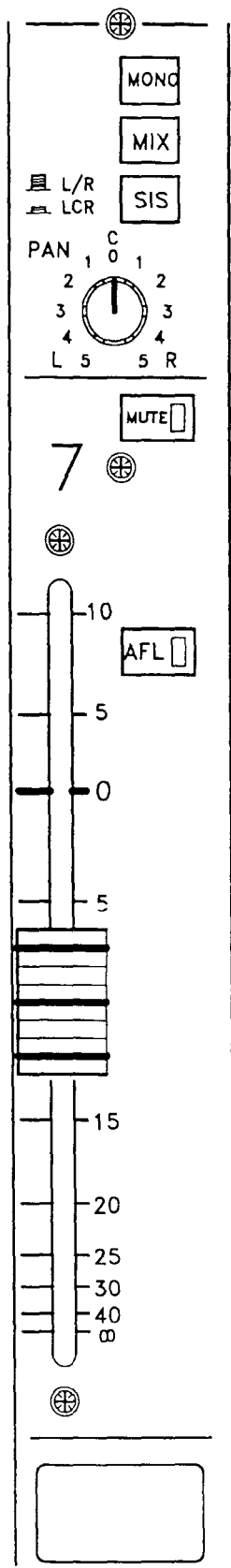

This section is identical to the group output section on the first 6 output modules.

MONO

This feeds the post fade group signal to the mono or centre bus of the console when pressed. In LCR mode the centre output of the pan pot will be replaced by the post fader signal if this switch is pressed. In L/R mode the centre output will not receive a signal until this switch is pressed.

MIX

When MIX is pressed the group signal is sent to the stereo mix. The pan control can be switched to LCR mode and the centre bus will then be fed with the centre output of the pan pot without the MONO button being pressed.

SIS — L/R (L/C/R)

This changes the pan pot from L/R mode to LCR mode where the signal will pan between left and centre or right and centre.

BAL

This adjusts the relative levels of signal sent to the left and right outputs or the left, centre and right outputs depending upon the selected pan mode when MIX is pressed.

MUTE

This mutes the group, the MUTE condition is indicated by an led.

FADER

The fader controls the level of the group output. As with the input module, fader operation close to the 0dB calibration point is expected and any large deviation from this would indicate that the signal from the modules feeding the group are too high or too low.

AFL

Allows the post fader pre mute group signal to be soloed. Thus the AFL level indicated on the solo meter will depend upon the group fader but not on the MUTE switch.

There is a pre-fader group insert point allowing an effect unit or similar to be introduced into the signal path.

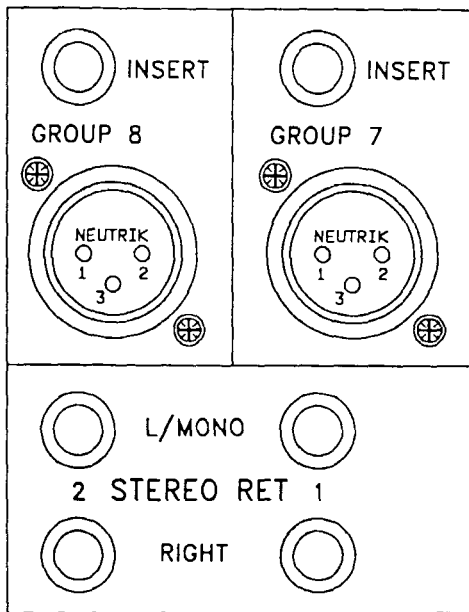

CONNECTORS AND PIN DEFINITIONS

Group Output :

3 Pin Male XLR Type, Balanced

Nominal Output Level: +4dBu

Pin 2 : Signal +ve (Hot)

Pin 3 : Signal -ve (Cold)

Pin 1 : Ground

Output Impedance : <75 Ohm

Stereo Inputs :

TRS Jack Socket, 'A' Gauge, Balanced

Nominal Input Level: 0dBu

Tip : Signal +ve (Hot)

Ring : Signal -ve (Cold)

Sleeve: Ground

Input Impedance : >10kOhm

Insert Points :

TRS Jack Socket, 'A' Gauge, Unbalanced

Nominal Input Level: 0dBu

Tip : Insert Send

Ring : Insert Return

Sleeve: Ground

Output Impedance : <75 Ohm

Input Impedance: >10 kOhm

GROUP MODULE 7-8 LINKS

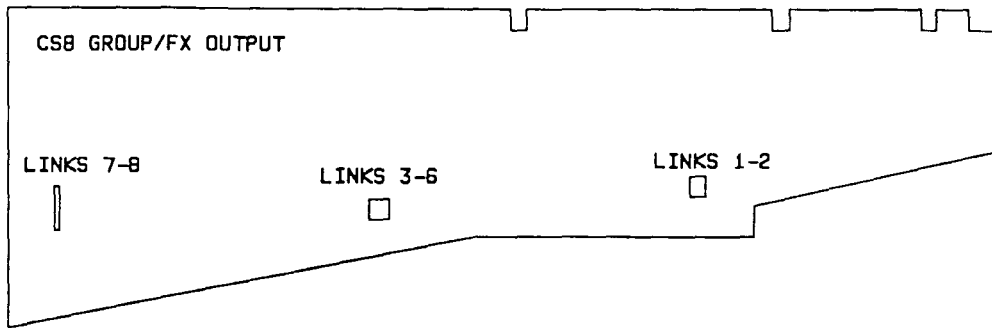

GROUP MODULE 7-8 PC1395			
LINK	FUNCTION	FITTED AS SUPPLIED	NOTES
1	BUS 7 SELECT		MODULE POSITION DEPENDENT
2	BUS 8 SELECT		
3	MATRIX GROUP 7 ASSIGN		MODULE POSITION DEPENDENT
4	MATRIX GROUP 8 ASSIGN		
5	MATRIX POST	YES	INSTALL ONLY ONE LINK
6	MATRIX PRE		
7	TRANSFORMER BYPASS	YES	REMOVE BOTH WHEN AN OUTPUT TRANSFORMER IS USED
8	TRANSFORMER BYPASS	YES	

The above links will not normally require alteration unless the console is reconfigured.

GROUP MODULE 7-8 BLOCK DIAGRAM

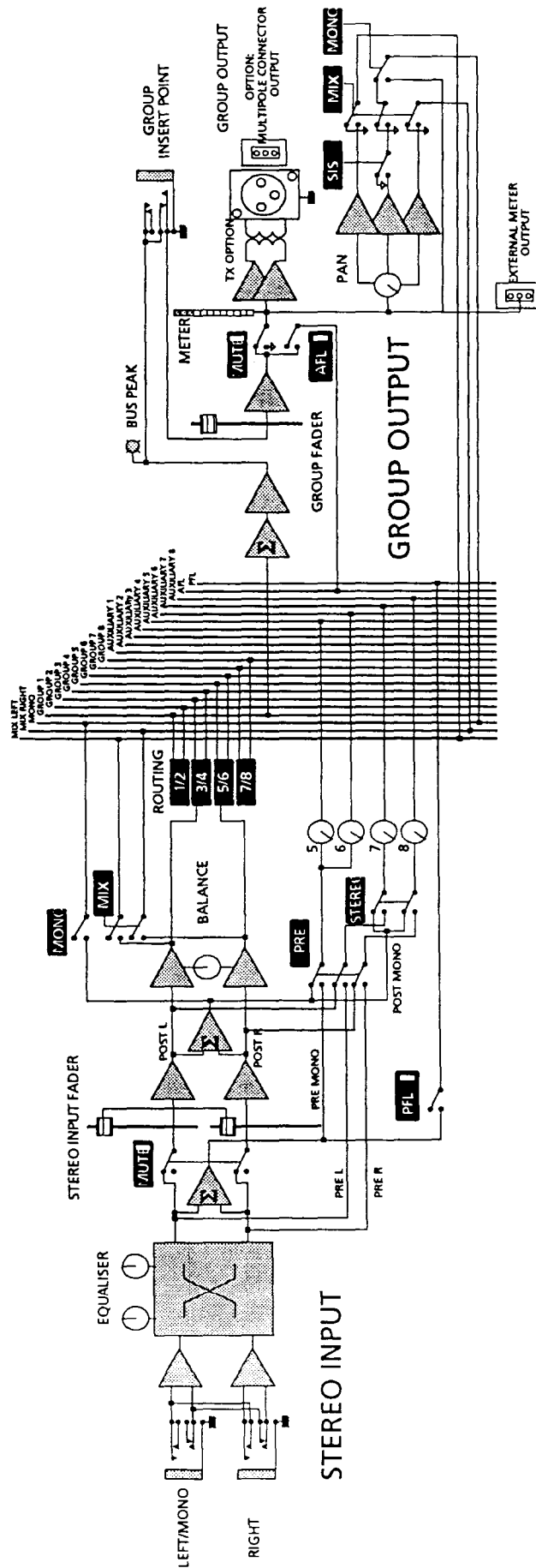

1

THE MASTER MODULE

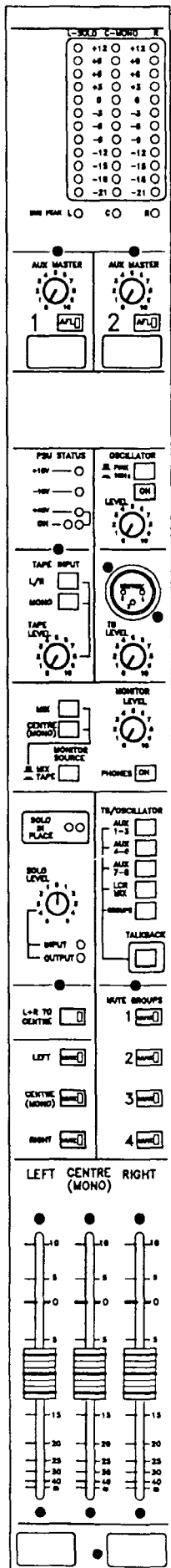

The Master module contains the main stereo and centre outputs, two Auxiliary master outputs, the monitoring section and a talkback microphone input. In addition, two rear mounted 4 pin XLR connectors are provided for LITTLITES™ which can be used if the console is to be operated under low or poor lighting conditions (maximum power, 5 Watts at 12V).

Pre-fader insert points are provided in the left, right and centre output signal paths. Plugging in a jack automatically breaks the normal signal path to insert the external equipment.

The Stereo Mix, Group, and Auxiliary outputs have a nominal operating level of 0dBu and can be transformer balanced.

Left, Centre and Right monitoring is possible on loudspeakers while the headphone output is stereo only. The three bargraph meters follow the output of the stereo mix under normal operating conditions. If a PFL or AFL button is pressed, the left meter shows the level of the soloed signal.

There is also an unbalanced stereo output on phono connectors taken from before the mix insert send points which can be used to feed a tape recorder or DAT machine. The nominal operating level is -10dBV. This allows the feed to the tape recorder to remain unaffected by any device connected to the master module insert points and to be independent of the master faders. The centre or mono output of the console is fed equally to the left and right tape outputs.

METERS AND AUXILIARIES

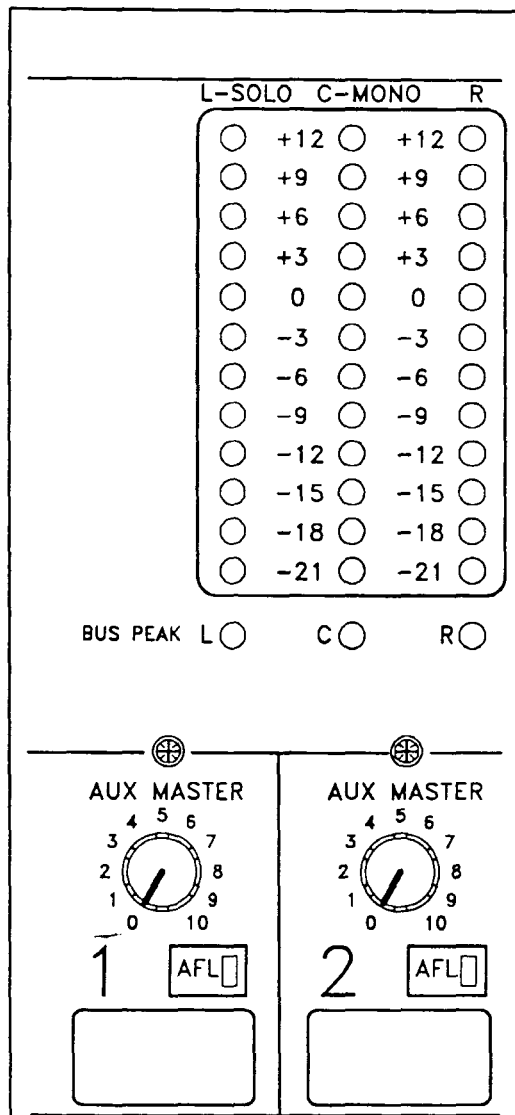

METERS

The three peak reading meters indicate the levels of the left, centre (mono) and right outputs of the console. The left meter is additionally used to indicate solo levels in which case the remaining two meters will not indicate.

BUS PEAK LEDS

There are three LEDs to indicate that the left, centre and right bus summing amplifiers are approaching clipping. Any indication here will mean that the level from the input modules, the groups if sub-mixed into the main outputs, or the stereo inputs is too high and should be reduced to avoid distortion.

AUX MASTER SECTION

LEVEL

These controls adjust the output levels for Auxiliaries 1 and 2.

AFL

This allows the auxiliary signal to be previewed. The post fade auxiliary signal is used and therefore it is dependent on the position of the output level control.

There is a pre-fader auxiliary insert point allowing the introduction of an effect unit or similar into the auxiliary signal path.

A scribble strip is provided for identification.

The auxiliary outputs may optionally be transformer balanced and/or fed to multipole connectors.

PSU STATUS

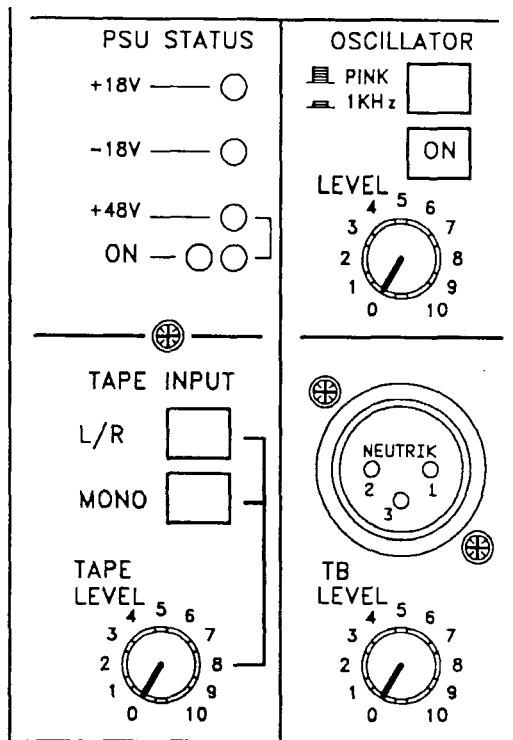

+18/-18/+48

These 3 leds indicate the presence of the two power rails and the phantom voltage supply.

+48V ON

This recessed switch enables the phantom power supply across the console.

OSCILLATOR

PINK/1K

This selects either the 1kHz sine wave oscillator or the pink noise source.

ON

This enables the oscillator and the pink noise source.

LEVEL

This adjusts the amplitude of the oscillator and pink noise source.

TAPE INPUT

TAPE LEVEL

This controls the level of the stereo tape input signal from the rear panel phono connectors when selected by the following switches to feed the left, right or mono outputs of the console.

L/R

The feeds the tape return signal onto the master left and right outputs of the console. Note that this feed is injected after the master faders and the level is adjusted by the TAPE LEVEL control.

MONO

This feeds the tape return signal onto the mono or centre output of the console. Note that this feed is injected after the master faders and the level is adjusted by the TAPE LEVEL control.

The above may be referred to as an intermission playback facility. It allows a tape or other external source to be played through the main console outputs with the master faders closed thus preventing any console signal sources from being heard.

MONITORING

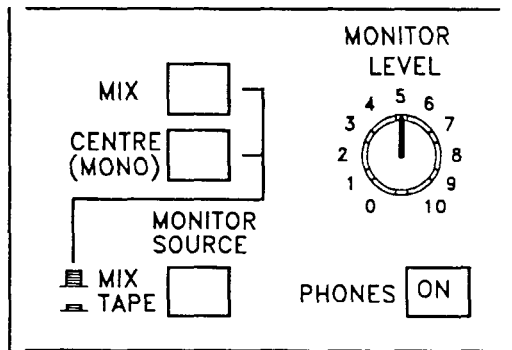

MONITOR SOURCE

When pressed this selects the tape input as the source for the monitoring system.

MIX

This selects the Left/Centre/Right outputs of the console to the monitoring system when MIX is the selected source, (Monitor Source UP).

CENTRE (MONO)

This selects the centre bus to the monitoring system where it is mixed equally onto the left and right monitor signal paths. If TAPE is selected the centre feed is cut off and no signal will indicate on the centre meter. This switch should be used when it is required to listen to the centre mix on headphones and when there are only two monitor loudspeakers.

MONITOR LEVEL

This controls the level of the local monitor and headphone outputs. Note that there are three loudspeaker outputs for monitoring the left, centre and right mixes.

PHONES ON

Pressing this enables alternative monitoring through stereo headphones. Note that this only monitors the left and right mixes and CENTRE TO L/R should be pressed when the Centre mix requires to be monitored on headphones. The HEADPHONE socket is located under the armrest on the front of the console.

COMMUNICATIONS

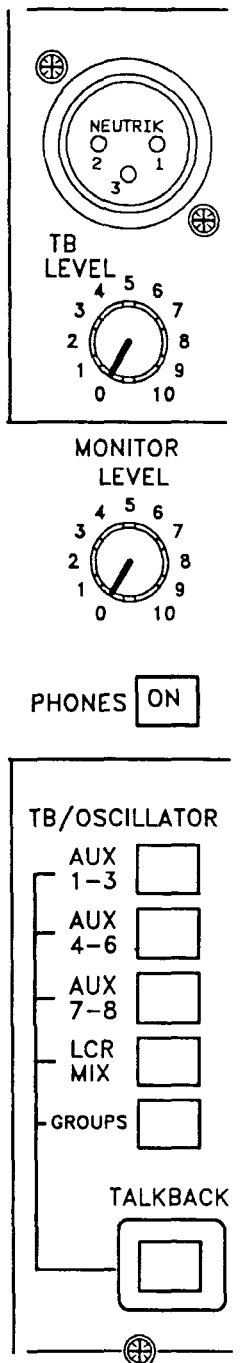

TALKBACK MIC

A microphone may be plugged in to this socket to provide talkback facilities to the output buses. The microphone may be a dynamic type, or, using an internal link for phantom powering, may be a condenser microphone.

TB LEVEL

This adjusts the level of the talkback microphone signal.

AUX 1—3

If 1—3 is pressed, the talkback microphone or oscillator signal is routed to the Auxiliary 1, 2 and 3 buses.

AUX 4—6

If 4—6 is pressed, the talkback microphone or oscillator signal is routed to the Auxiliary 4, 5 and 6 buses.

AUX 7—8

If 7—8 is pressed, the talkback microphone or oscillator signal is routed to the Auxiliary 7 and 8 buses.

LCR MIX

If pressed the talkback or oscillator signal is routed to the L/R and Mono (centre) buses.

GROUPS

If pressed the talkback microphone or oscillator signal is routed to all the group outputs.

TALKBACK

This allows the talkback and oscillator signals to pass to the selected destination. When pressed the monitor output of the console will dim by 10dB to reduce the possibility of feedback. In normal operation only this switch would be pressed when talkback is required while the above routing switches would be left assigned to the required destinations. Note that the switch is latching and must be pressed again to release it.

SOLO

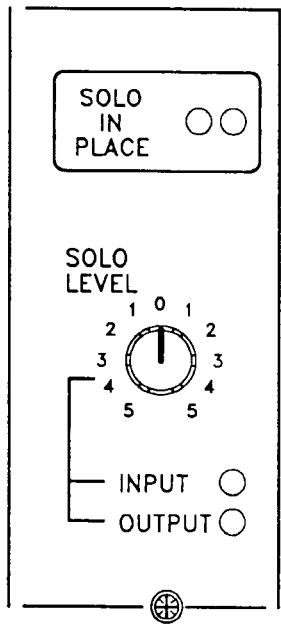

AFL/PFL/SIP

Selection of any AFL or PFL solo signal will override the monitor selection leaving the console output unaffected. SIP operates differently and will affect the main outputs of the console.

SOLO LEVEL

This control adjusts the audio level of a soloed (PFL/AFL) signal. This will not affect the solo meter reading. It can be used to match the audio level of the solo to that of the mix.

INPUT SOLO

This led will indicate when a solo (PFL) has been selected on an input to the console.

OUTPUT SOLO

This led will indicate when a solo (AFL) has been selected on an auxiliary, matrix or group output.

Priority is given to an input solo. If an output solo is active and an input solo is then activated the output solo will be muted for the duration of the input solo.

SOLO IN PLACE

Solo In Place is a special mode where the monitor system does not switch over to listen to the solo bus. For SIP mode to operate the monitor selection must be set to MIX. The monitor system remains listening to the mix outputs and when a solo on an input module is requested a signal is sent back from the master module to MUTE ALL OTHER INPUT MODULES.

Thus only the channel(s) with the solo (PFL) key pressed will be heard. This can be a dangerous mode particularly during live work and for this reason the master SIP MODE switch is recessed. To operate the switch a blunt non conducting instrument should be used to push the switch through the panel hole. An led illuminates to warn that SIP MODE is selected.

MASTER FADERS

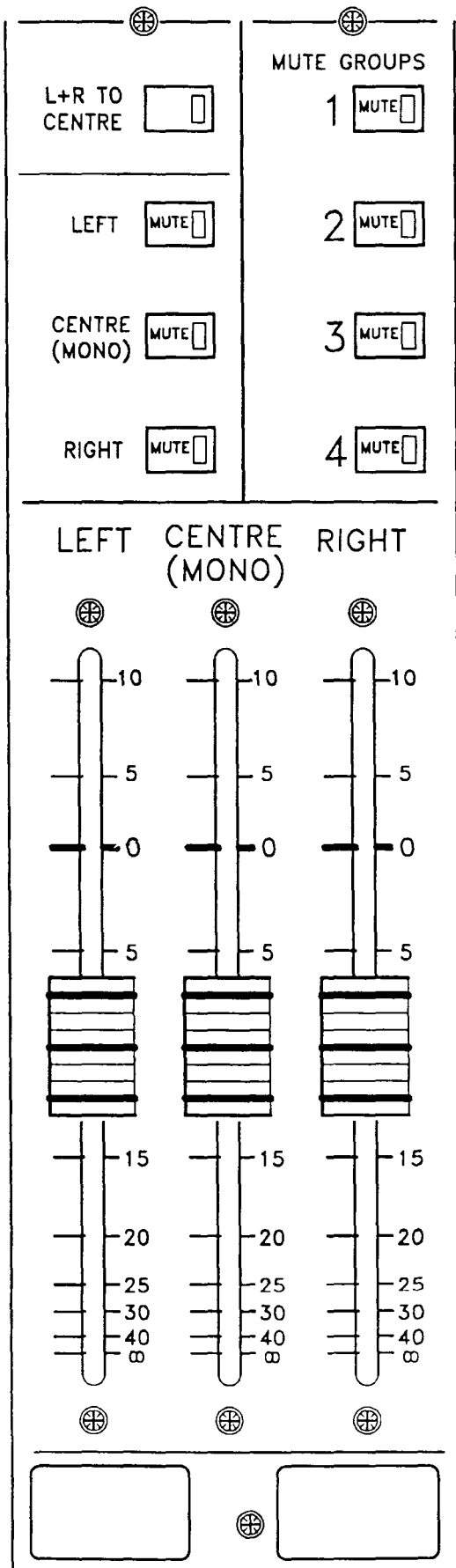

L+R TO CENTRE

This mixes the post fader left and right outputs onto the centre output of the console.

MUTE

Independent MUTE switches are provided for the left, centre and right outputs of the console.

MUTE GROUPS

Four switches are provided to enable operation of the four mute groups provided on the console. Pressing MUTE 1 for example will mute any channels assigned to that mute group.

FADERS

LEFT, CENTRE (MONO) and RIGHT faders are provided to give smooth control of the output signals. Operation around the 0dB calibration point is expected and significant deviations from this would indicate that the levels routed to the master outputs are incorrect.

HEADPHONES

Stereo headphones with impedances from 100 ohms to 600 ohms may be plugged into the headphone socket. This socket is located below the armrest and to the right hand side of the console.

CONNECTORS AND PIN DEFINITIONS

Please refer to the diagram overleaf for connector positions.

Left and Right Outputs : 3 Pin XLR type, Balanced

Nominal Output Level: 0dBu

Pin 2 : Signal +ve (Hot)

Pin 3 : Signal -ve (Cold)

Pin 1 : Ground

Output Impedance : <75 Ohm

Mono (Centre) Output : 3 Pin XLR type, Balanced

Nominal Output Level: 0dBu

Pin 2 : Signal +ve (Hot)

Pin 3 : Signal -ve (Cold)

Pin 1 : Ground

Output Impedance : <75 Ohm

Tape Play Inputs : Phono Sockets

Nominal Input Level: -10dBV

Tip : Signal +ve (Hot)

Sleeve: Ground

Input Impedance : >40 kOhm

Tape Record Outputs : Phono Sockets

Nominal Output Level: -10dBV

Tip : Signal +ve (Hot)

Sleeve: Ground

Output Impedance : 1k5 Ohm

Insert Points : 1/4" TRS Jack socket, 'A' Gauge, Unbalanced

Nominal Input level: 0dBu

Tip : Insert Send

Ring : Insert Return

Sleeve: Ground

Output Impedance: <75 Ohm

Input Impedance: >10 kOhm

Monitor Outputs : 3 Pin XLR type, Balanced

Pin 2 : Signal +ve (Hot)

Pin 3 : Signal -ve (Cold)

Pin 1 : Ground

Output Impedance : <75 Ohm

Nominal Output level: 0dBu

Headphone Output : TRS Jack Socket, 'A' Gauge

Nominal Output level: +14dBu

Tip : Left Channel

Ring : Right Channel

Sleeve: Ground

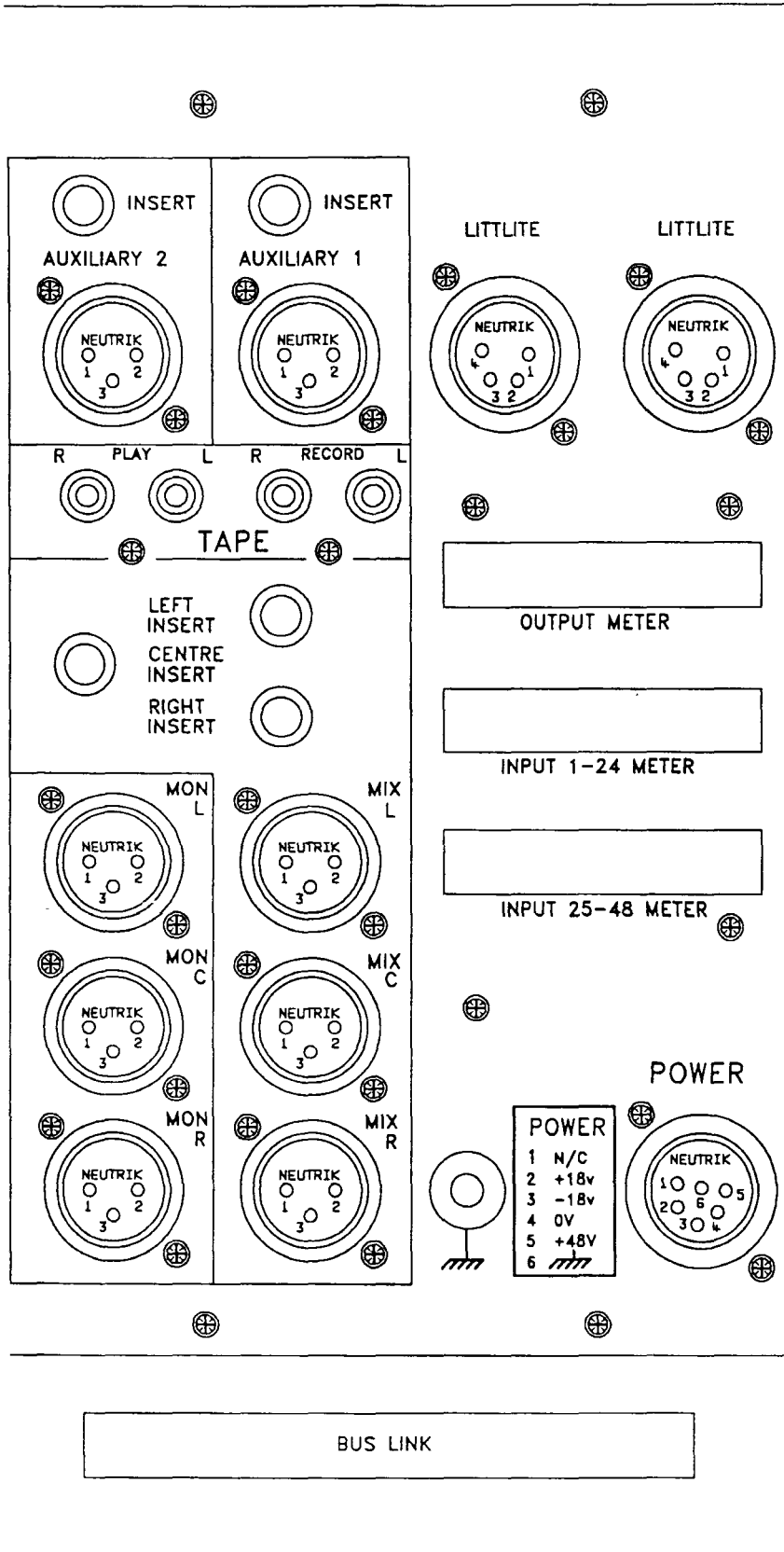

INSERT INSERT

AUXILIARY 2 AUXILIARY 1

NEUTRIK NEUTRIK

1 2 3 1 2 3

R PLAY L R RECORD L

TAPE

LEFT INSERT

CENTRE INSERT

RIGHT INSERT

MON L MIX L

NEUTRIK NEUTRIK

1 2 3 1 2 3

MON C MIX C

NEUTRIK NEUTRIK

1 2 3 1 2 3

MON R MIX R

NEUTRIK NEUTRIK

1 2 3 1 2 3

LITTLITE LITTLITE

NEUTRIK NEUTRIK

1 2 3 1 2 3

OUTPUT METER

INPUT 1-24 METER

INPUT 25-48 METER

POWER

1	N/C
2	+18v
3	-18v
4	0v
5	+48V
6	⏏

NEUTRIK

1 2 3 4 5

6

BUS LINK

MASTER MODULE LINKS

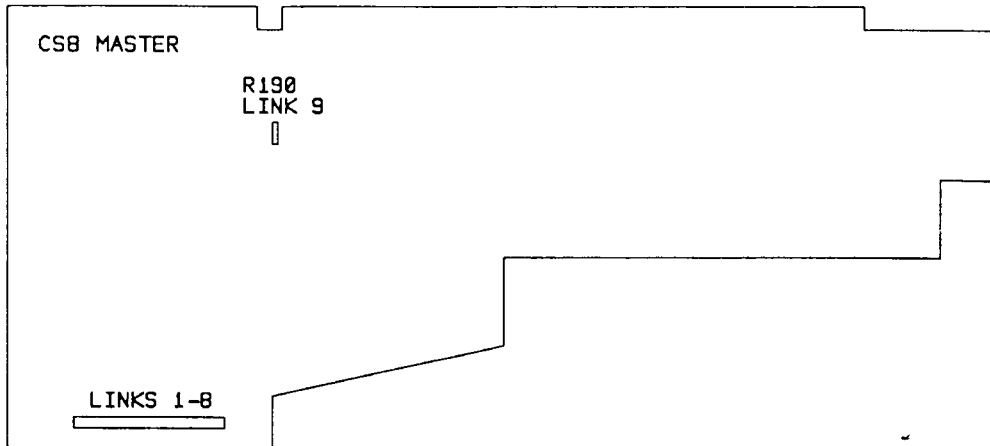

MASTER MODULE PC1396			
LINK	FUNCTION	FITTED AS SUPPLIED	NOTES
1	AUXILIARY 1 TRANSFORMER BYPASS	YES	REMOVE WHEN FITTING AN OUTPUT TRANSFORMER
2	AUXILIARY 1 TRANSFORMER BYPASS	YES	
3	LEFT MIX TRANSFORMER BYPASS	YES	REMOVE WHEN FITTING AN OUTPUT TRANSFORMER
4	LEFT MIX TRANSFORMER BYPASS	YES	
5	RIGHT MIX TRANSFORMER BYPASS	YES	REMOVE WHEN FITTING AN OUTPUT TRANSFORMER
6	RIGHT MIX TRANSFORMER BYPASS	YES	
7	CENTRE MIX TRANSFORMER BYPASS	YES	REMOVE WHEN FITTING AN OUTPUT TRANSFORMER
8	CENTRE MIX TRANSFORMER BYPASS	YES	
9	METER ENABLE	YES	REMOVE WHEN METERBRIDGE IS FITTED

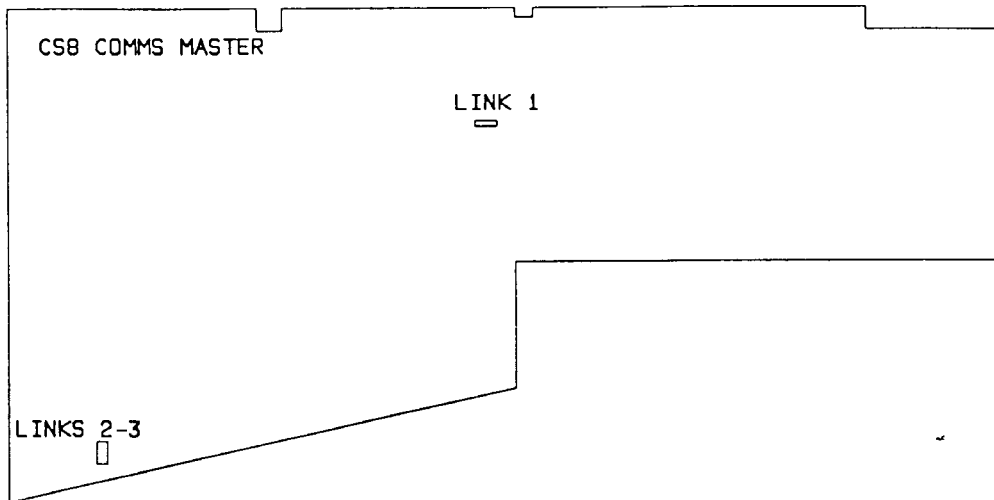

COMMS MODULE PC1397			
LINK	FUNCTION	FITTED AS SUPPLIED	NOTES
1	TALKBACK MICROPHONE PHANTOM POWER		
2	AUXILIARY 2 TRANSFORMER BYPASS	YES	REMOVE WHEN FITTING OUTPUT TRANSFORMERS
3	AUXILIARY 2 TRANSFORMER BYPASS	YES	

The above links will not normally require alteration unless the console is reconfigured.

MASTER MODULE BLOCK DIAGRAM

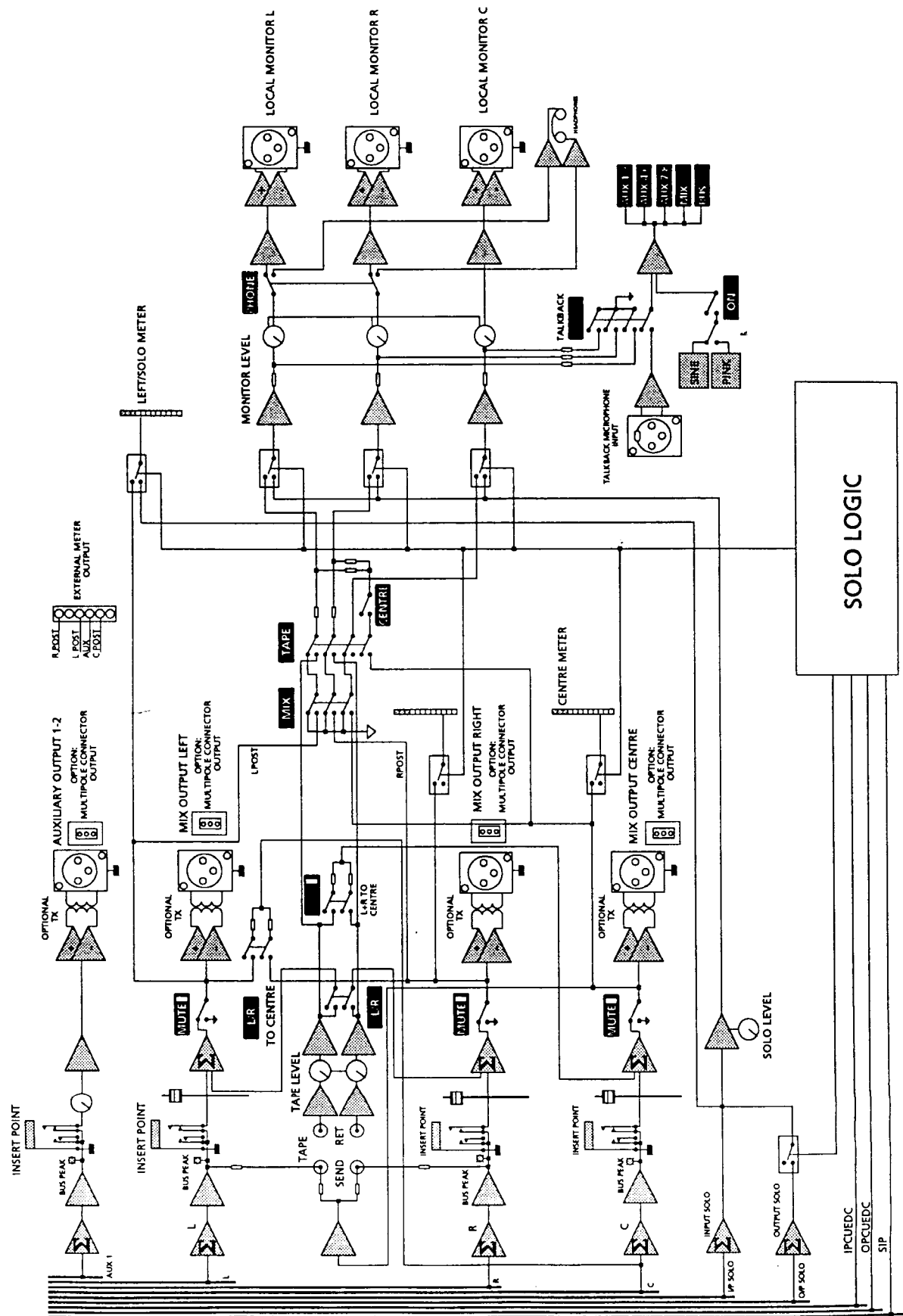

THE METERBRIDGE (OPTIONAL)

Meterbridges are available with either VU meters or LED Bargraph meters.

The VU Meterbridge has 11 meters. Three meters are dedicated to the Left, Centre and Right mixes while the remaining eight meters can be switched between the Auxiliary, Group and Matrix outputs.

The LED Bargraph Meterbridge incorporates input metering in addition to eleven output meters. Where stereo input modules are fitted one meter will be used to indicate the higher of the left and right signals. All bargraph meters have 12 segments displaying a range from -21dBu to +12dBu in 3dB steps with a peak reading characteristic.

Three switches allow selection of either the Auxiliary, Group or Matrix signals on the meterbridge. The output module meters, which can be switched between Group and Matrix, remain active enabling any two sets of output signals to be viewed at one time.

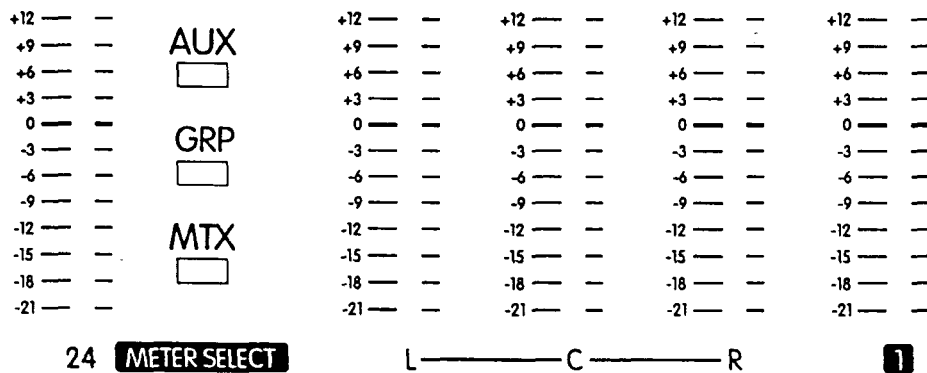

The above illustration shows the signal selection switches on the led meterbridge.

The meterbridge also carries LITTLITE™ connectors. When the meterbridge is mounted the console connectors are concealed by the wiring to the meterbridge and are therefore unavailable for use.

When the console is shipped the meterbridge will not be mounted.

FITTING THE METERBRIDGE

Meterbridges can be easily (retro) fitted to consoles as follows.

If required, modify the master module so that the meters will only display solo audio levels — this will already be done on consoles leaving the factory with a meterbridge. This necessitates removing the master module from the console.

To remove the master module first of all ensure that the console is not powered. Remove the double width blanking panel with the DDA logo on it. This is retained by a screw at the top and bottom. Remove the 10 screws retaining the top and bottom of the master module and the 6 screws retaining the rear of the module to the frame. Gently ease out the module into a working position.

Remove Link 9 on PC1396 by cutting it and fit R190 (100k). The simplest method is to solder the new resistor across the pads on the component side of the board thus avoiding having to disassemble the module to gain access to the solder side of the board.

Reinstall the master module into the console.

Remove the plastic blanking plugs from the console, position the meterbridge and mount it by inserting the supplied screws.

Wire the meterbridge connectors onto the master module connector panel following the identification information on the cables and the module connector panel.

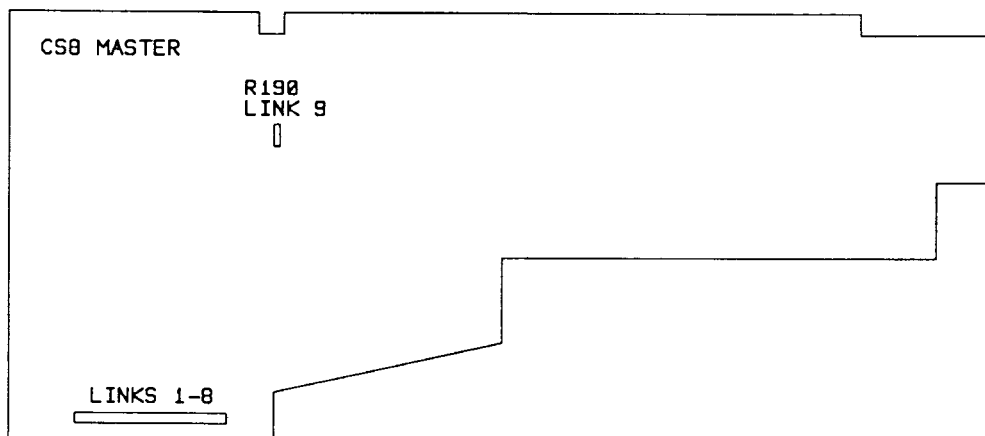

The meterbridge is pre aligned and no adjustment will be required after installation.

BUS LINKING

Bus linking enables a pair of CS8 consoles to be used in a master/slave configuration. Normally a concealed connector will link the input modules to the output modules within a console. This connector can be removed and replaced by a DDA supplied bus linking cable which performs differently depending upon whether the console is to be a master or a slave.

The BUS LINK connector is located on the rear of the frame below the master module. Access is made by removing the BUS LINK panel to expose a connector with a handle. Remove this connector from the console and plug in the appropriate end of the linking cable depending upon whether the console is to be a master or a slave. Similar action should be taken on the second console using the other end of the linking cable. Connect the ground cable to the ground studs on each console.

If a console is to be a master then use the master end of the bus link cable which maintains the link between the input and the output modules. The cable then connects the input modules from the slave console onto the master console buses.

If a console is to be a slave console then use the slave end of the cable which breaks the link between the input and output modules and connects the input modules over to the buses of the master console. The master and output modules of this console are now disabled.

When linked operation is no longer required the link cable should be removed from both consoles and the original connectors replaced. It is strongly recommended that the cover plates are then replaced to prevent the ingress of electromagnetic interference.

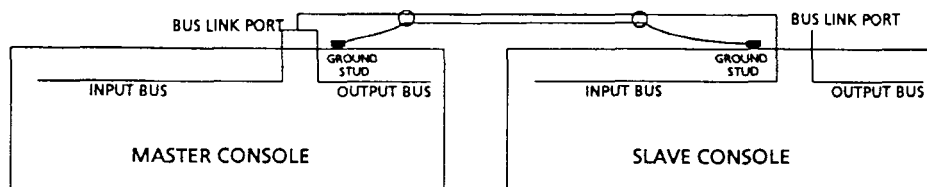

The above illustration shows how the link cable joins the input modules of the slave console to the buses of the master console. Note that both consoles must still have their own power supply.

As more audio signals are now being mixed onto the buses the bus levels will increase and there may be a risk of overload. To prevent this the input faders should be reduced by a small amount on all of the input channels.

MULTIPOLE CONNECTORS (OPTIONAL)

Multipole connectors are of most use in a mobile situation reducing the time taken to rig and derig a sound system. The risk of a misplug is reduced as less connections have to be made while both inputs and outputs can be wired to the multipole connectors.

Modules have a connector fitted which is wired in parallel with the existing input or output connector. This connector is wired to a multipole connector through a cable loom thus placing the multipole connector input in parallel with the original input or output.

The multipole connectors are fitted by removing the existing blanking plates on the rear of the console frame and replacing them with the connector panels.

THE POWER SUPPLY

The PSI2860 power supply for the console is a free standing fan cooled unit operating within the voltage range 90 — 240V AC @ 50-60Hz. The unit may also be rack mounted although care should be taken that the transformer does not cause interference with other rack mounted equipment.

The outputs are rated as follows :-

+/-18V	at 6.0 Amps maximum
+48V	at 350mA maximum.

DC Pinout

1	Not connected
2	+18 Volts
3	-18 Volts
4	0 Volts
5	+48 Volts
6	Chassis

The PSI2860 power supply is tested in accordance with:-

IEC65, 5th edition 1985 amendment number 1
EMKO-TUE(12B-SEC) 205/91.

Always connect the power supply to the console and the electricity supply before switching on.

Fusing:	240/230/220V	CSM02-0006	T3.15A
	120/100/90V	CSM02-0007	T6.3A

**REFER SERVICE AND REPAIR TO A QUALIFIED AND
COMPETENT PERSON OR DEALER.**

WARNING: THIS SUPPLY MUST BE EARTHED

MAINS VOLTAGE SELECTION

Mains voltage selection for the power supply should be carried out according to the diagram below. Do not adjust these settings with the power supply connected to the electricity supply. The switches are located under the top cover which must be removed in order to make the adjustment.

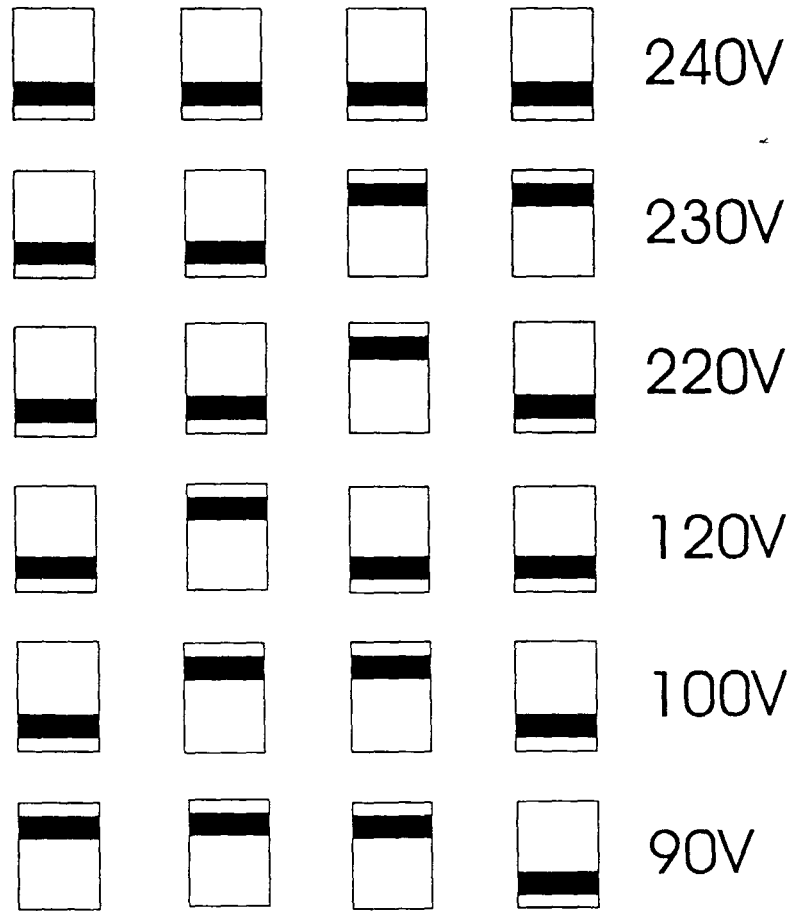

An incorrect setting may lead to noisy operation of the console or damage to the power supply and console.

THE DLB600 AUTOSWITCHOVER UNIT

The DLB600 Diode Linking Box gives added security to any console operation by allowing two power supplies to feed one console. In the event of one supply failing the other supply will take over the entire load and an indication will be given of the failure. There are no controls or adjustments associated with this product and correct operation will result as long as two supplies are connected. The unit may be rack mounted, carries CSA approval and is designed for use with power supplies of type PSU350, PSU350J or PSI2860.

OPERATION

Connect a PSI2860 power supply to each input of the DLB600 and connect the output of the DLB600 to the console. If required an extra cable, DDA Part No. ACBL14-103, may be used to extend the output cable of the DLB600.

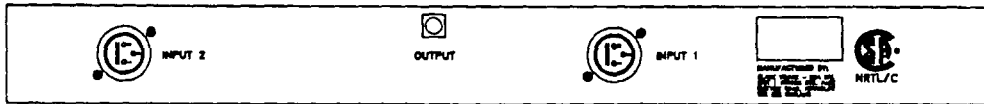

CS8 GROUNDING

The following illustration shows the grounding system of the CS8 console. There are several points to note as follows:-

0 Volts (Audio Ground) is not externally available on the console.

Pin 1 of all XLR style connectors is connected to chassis.

The sleeve of all jack connectors is connected to chassis.

The chassis ground is effectively forming a continuous shield covering the electronics and the cable carrying the signal between them.

As can be seen there is a large ground loop created even in this simple example, however if all equipment has pin1 taken to chassis this should present no problem and there is no need to use cables with the earth disconnected at one end. Most problems arise when cable shields are connected to audio ground and the best common mode rejection available on input stages will not cure the problems created by this connection.

The power supply has a ground lift switch located on the rear panel which can be used in the event of grounding problems. When this switch is operated the console chassis is removed from the mains ground and connected to 0V Audio. The console chassis is then no longer connected to mains earth.

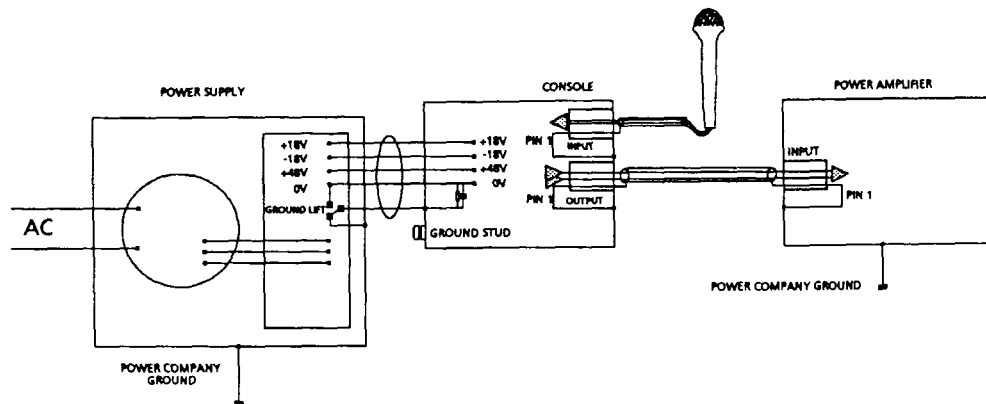

A TECHNICAL PRIMER

Before any console is switched on many decisions will have been made with regard to what channels the signal sources will appear on and in fact this may even have influenced the build of the console. Some operators favour all the microphones to the left side of the console with other sources to the right while other people may prefer a layout more akin to the actual physical layout of the microphones and other signal sources.

A WORD ABOUT CONNECTORS

Two types of connector are used to interface the console to external signals. Firstly XLR type connectors are used for the microphone inputs. These connectors have a large contact area and therefore are very suitable for low level signals.

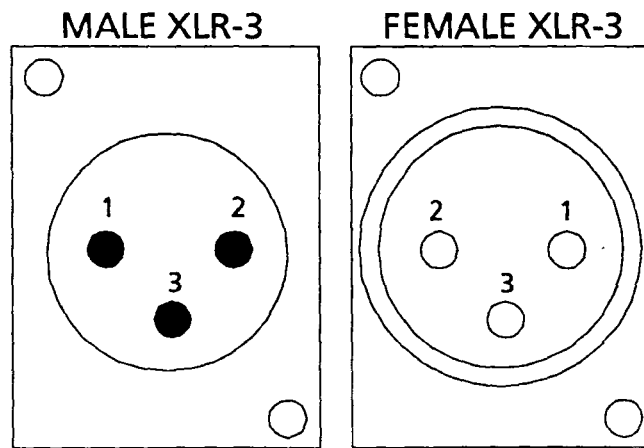

It is perhaps worth mentioning at this point that there are two different conventions for the wiring of XLR connectors. The international convention uses pin 2 as the hot pin while the older American convention uses pin 3 as the hot pin. When going from balanced input to balanced output this is of little consequence but when unbalanced signals such as those found on the insert points are used then phase reversal can result. The CS8 and all DDA products are wired PIN 2 HOT.

1/4 inch TRS jacks are used for high level signals such as the line inputs and the stereo return inputs. These jacks are used in 3 different ways.

- 1 To carry a balanced signal, the line input for example.
- 2 To carry an unbalanced signal, the direct output for example.
- 3 To carry an unbalanced signal in and out through the same connector at the same time, the insert point for example. The TIP is used to send signal while the RING receives signal. The sleeve is a common ground.

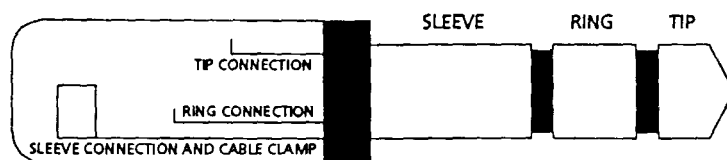

1/4 INCH TRS 'A' GAUGE JACK PLUG

A technique known as "normalling" or "innering" can be used to carry signal through jacks which have no plugs inserted. The jack socket is equipped with spring terminals making contact with the tip, ring and sleeve connections until a plug is inserted. Signal wired to these sprung connections will normally connect to the tip, ring and sleeve connections and an example of this is where the auxiliary left input is also used as a mono input by wiring it through to the right input connector.

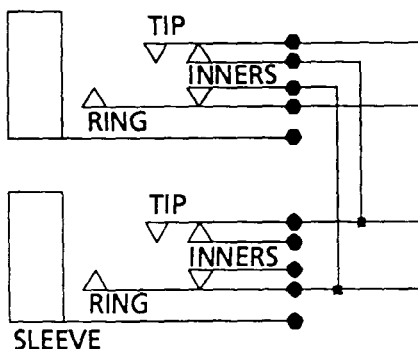

Thus a mono input signal is fed to both left and right signal paths. If a stereo input is required then the insertion of a jack plug into the right jack cuts off the signal from the left jack letting the right and left signals go the appropriate signal paths. Another example is the insert jack where the tip and ring inner connections are wired together. When the insert point is not in use signal fed to the tip is returned to the ring through the normalled connection then to proceed through the remainder of the module.

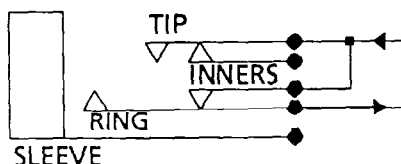

BALANCED OR UNBALANCED ?

Relating to a home stereo system unbalanced operation is the norm with the ground being used as the signal return path. This can be prone to interference especially with the longer cable lengths used in professional applications.

To counter this, balanced operation is usually preferred where the signal send and return use individual wires which will normally have an overall screen. Thus XLRs have 3 pins, two for the balanced signal and one for ground which is now used for screening purposes, rather than as a signal return path. It is common practise to have the ground connected at one end of a cable only to reduce the risk of ground loops which can induce hum and interference into the wanted audio signal. When jacks are used they must be of the TRS (Tip, Ring, Sleeve) type to carry a balanced circuit.

The internal electronics of the console are unbalanced therefore every balanced input must have a balanced to unbalanced input stage and every balanced output must have an unbalanced to balanced output stage. These stages also modify the level of the signal such that the internal console signal is optimised for noise and distortion.

INTERCONNECTION

A number of points require to be addressed when connecting inputs and outputs together if either or both are unbalanced. The crucial points are grounding and how the screen is connected. The following table gives an indication of the connections under all possible cases. Note that "balanced" means balanced and floating such as from a transformer while "differential" refers to an electronically balanced input or output which cannot float.

Output	Input	Screen	See Note
Unbalanced	Unbalanced	Source	
Unbalanced	Balanced	Source	
Unbalanced	Differential	Source	
Balanced	Unbalanced	Destination	1
Balanced	Balanced	Source	
Balanced	Differential	Destination	2
Differential	Unbalanced	Source	3
Differential	Balanced	Source	
Differential	Differential	Source	

- 1 The shield is connected to the destination earth point, which is the opposite of normal practice, because the signal wires being shielded are referenced to the input earth, not the output earth.

- 2 If the output transformer is centre tapped to earth, the screen should be connected at the source.
- 3 When an active differential output is operated in unbalanced mode, it is very important that the output current returns to earth via the shortest, least reactive route. Check for instability at the output.

A simple test to show the vulnerability of any piece of equipment to earth currents has been proposed by John Windt in the June 1995 issue of the Journal of the Audio Engineering Society. The test consists of passing a peak AC current of 100mA through the ground system of a piece of equipment and measuring the degradation in signal to noise ratio. In its simplest form this would be at 50/60Hz, although a more elaborate test could consist of a wide band frequency sweep from 20Hz to 200kHz as suggested by Cal Perkins in the same issue of the AES Journal. Of course, there are many different ground paths possible, so it is necessary to try as many as possible, such as pin 1 to pin 1 of any XLR connectors or to the jack sleeves or to the metalwork etc. The results of this test are far from subtle, with 30-50db reductions in signal to noise ratio quite commonly observed! The scary thing is that this can actually represent a real world situation, unlike a simple bench test measurement of noise, which is usually taken in an idealised situation. A well designed and implemented internal grounding method, as found in the CS8, should ensure that there is negligible effect on performance.

DECIBELS (dBs)

Many signal levels are quoted in dBs as this relates more to the perceived effect of the signals. 0dBm relates to a power level of 1mWatt into 600 ohms giving 0.775 Volt. Normally 600 ohm impedances are not used and dBu are quoted meaning 0.775 Volt independent of impedance. dBV are encountered more and more frequently and they are referenced to 1V. Thus there is a difference of 2.2dB between 0dBu and 0dBV. When dBs are used without a suffix it simply means that they are a ratio of two readings and the absolute measurement is not important. Thus the ratios in dBu's or dBV's are the same but absolute measurements are made to different reference levels.

Many products operate at +4dBu while many newer semi-professional products including some 1 inch multi track tape machines operate at -10dBV. This leads to approximately a 12dB difference between signal levels as -10dBV equates to -7.8dBu.

PANNING

When a signal is split across a stereo bus some compromise is involved regarding the levels sent to the buses for the following reasons.

Two identical signals, when combined electrically, will double in amplitude which is an increase of 6dB. If the signals are fed through a stereo loudspeaker system then the acoustic summing and perceived effect is that the signal amplitude has increased by 3dB. There is thus a 3dB difference between the two summing mechanisms.

For a console optimised for sound reinforcement the pan pot should be 3dB down in the centre position while for broadcasting where peak levels are important due to transmitter and land line overloading, the pan pot should be 6dB down. 4.5dB is often chosen because it is halfway between the extremes. An error of 1.5dB is acceptable in most situations.

Splitting the signal across an LCR bus is similar as only two of the buses are active at any time. If the signal is centrally panned then only the centre (mono) output is active.

The CS8 pan pots are 3dB down in the centre position relative to fully left and right panned signal levels.

INSTALLATION GUIDE

There are a number of points to consider when installing a mixing console. Many of these points will have been addressed before the console is even unpacked but it is worth repeating them again.

POSITION

The console should be located in a convenient space commensurate with the use to which the console is being put. Ideally a cool area is preferred which is not in close proximity to power distribution equipment or other potential sources of interference. Provision should be made for some flat surface surrounding the console to prevent people using it as a table top. One of the worst fates that can befall a console is for a cup of coffee to be tipped into it by someone resting it on the control surface!

POWER

The power supply should be located as far from the console as the connecting cable will allow. It should be set for the appropriate line voltage and plugged into the mains outlet using the supplied cable.

WIRING

The console uses four different connector styles:-

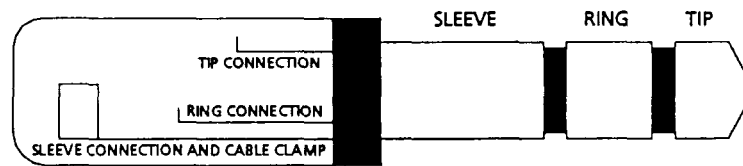

1/4 INCH TRS 'A' GAUGE JACK PLUG

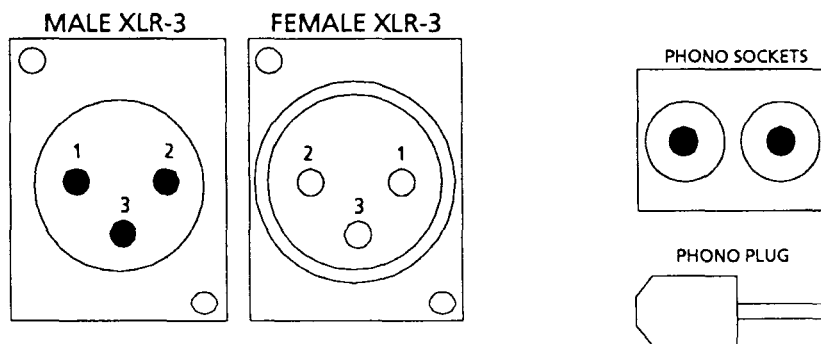

TRS jack sockets, XLR male connectors, XLR female connectors and phono connectors.

The cables used should be of as high a quality as possible. Many installation problems can be traced back to poor or faulty cables and connectors.

As mentioned before there are two different conventions for the wiring of XLR connectors. The international convention uses pin 2 as the hot pin while the older American convention uses pin 3 as the hot pin. When going from balanced input to balanced output this is of little consequence but when unbalanced signals such as those found on the insert points are used then phase reversal can result. The CS8 and all DDA products are wired PIN 2 HOT.

ATTENTION

CABLES

This product should only be used with high quality, screened twisted pair audio cables, terminated with metal bodied 3 pin XLR connectors. The cable shield should be connected to Pin 1. Any other cable type or configuration for the audio signals may result in degraded performance due to electromagnetic interference.

ELECTRIC FIELDS

Should this product be used in an electromagnetic field that is amplitude modulated by an audio frequency signal (20Hz - 20kHz), the signal to noise ratio may be degraded. Degradation of up to 60dB at a frequency corresponding to the modulation signal may be experienced under extreme conditions (3V/m, 90% modulation).

No permanent damage or degradation of performance will be caused by these conditions.

GLOSSARY

This section provides a simple explanation of some of the terms used when describing the console features.

"A" GAUGE JACK

This is a 1/4" jack which has a large tip diameter compared with a "B" gauge jack which has a smaller diameter tip and is usually found in broadcast use. Both types could be described as TRS (Tip, Ring, Sleeve) and it is the A Gauge that is used on DDA product.

AFL

After Fade Listen. For listening to post fade signals - those controlled by the channel fader.

AUXILIARY SENDS

These are extra signal paths out of the console which are separate from the main mix and group outputs. Each auxiliary output is like a separate mixer and can be controlled independently of the main faders. They are used to provide special mixes to artists as they are recording (normally called FOLDBACK) or as a signal to be sent to an effect such as a reverberation or delay device.

BUS

This is the common point for all signals routed to a particular destination, usually taking the form of a piece of wire or cable running across the console. A number of signals routed to the same bus will appear as one signal at the output of the bus mixing amplifier.

BUS TRIM

A control used to adjust the level of all signals mixed on the same bus.

D.I.

Direct Inject is an input used for high level devices such as keyboards where the line input would not be sensitive enough.

DIM

This reduces the monitor level by a preset amount, usually 20dB in DDA products.

DIRECT OUTPUT

This refers to the individual output of a channel which is available even if the channel is not routed.

EBO

Electronically Balanced Output.

EQ
Equaliser or Tone Control.

GROUND SENSING OUTPUT

An output stage where any ground noise is injected into the feedback loop in such a way that it appears in phase on the amplifier output. As the ground should be the reference for the following stage, if it is moving and the signal is moving in the same way then no net signal results.

GROUP OUTPUT

Group outputs can be used to feed loudspeaker clusters or a multitrack tape machine. They can also be sub mixed to the main stereo bus in the console making it easier to control large numbers of inputs.

HF
High Frequency

HIGH PASS FILTER (HPF)

A filter which cuts out frequencies below its operating frequency. It can be used to filter out rumble picked up by a microphone for example.

INSERT POINT

Sometimes referred to as a patch point. This is an interruption to the signal path to allow for the insertion of a signal processing device.

INTERMISSION PLAYBACK

This allows a signal to be played out from the master outputs of the console with the master faders closed thus preventing stage microphones or other signal sources from reaching the master outputs.

LF
Low Frequency.

LINE INPUT

An input designed to accept high level signals as opposed to microphone level signals.

LOW PASS FILTER (LPF)

This is the inverse of a HIGH PASS filter and is used to reduce frequencies above the operating frequency

MASTER

This normally refers to the main stereo output section of a console which controls the level of the stereo mix and associated functions such as monitoring.

PARAMETRIC EQ

An equaliser section which has variable frequency, level and Q.

PAN

A pan control or Pan Pot or Panoramic Potentiometer is used to spread a mono signal across multiple buses.

PEAKING EQ

In this form of equaliser the response is tailored to enhance a selected frequency relative to the frequencies above and below it. Peaking equalisers are normally used as the mid sections of an equaliser. Also known as "bell shaped" or "swept".

PFL

Pre Fade Listen. For listening to pre fade signals.

PINK NOISE

A random sound with equal energy per octave of bandwidth. It is often used to equalise sound systems.

POST-FADER

A signal derived after a fader and therefore dependant upon the position of the fader.

PRE-FADER

A signal derived before a fader and therefore not dependant upon the position of the fader.

Q

Associated with peaking equalisers the Q is the factor which describes how wide the peak or trough of enhancement is. The smaller the Q the wider the bandwidth of the equaliser will be. Typically a fixed Q equaliser will have a Q of about 1.5 equating to a bandwidth of about 1 octave.

QUASI BALANCED

An arrangement whereby a bus is terminated with a differential input. The bus however is not truly balanced, instead a bus common is used to pick up any interference which will also be picked up by the true bus. The interference then appears as a common mode signal at the mixing amplifier.

RETURN

Any signal that is sent out of the console and is returned after some form of processing.

ROUTING

The sending of a signal to a bus normally by pressing a switch. Signal can be routed to several buses simultaneously if required.

SCRIBBLE STRIP

An area of the console reserved for the user to write on, usually in order to identify channel usage.

SEND

The output from a channel insert point is called the (insert) send.

SHELVING EQ

This means that the response of the equaliser becomes constant after the turnover or corner frequency has been passed. Thus a high frequency shelving equaliser operating at 10kHz will have a rising response as the frequency approaches 10kHz but will be flat after 10kHz. This is normally used on the high and low frequency sections of an equaliser.

SIP

Solo in Place. This mode cuts all the input channels that are not soloed.

SLATE

The ability to talk to tape from the operating position of the console.

SWEEP FREQUENCY

A control which selects a centre frequency to operate around. Most often used with peaking equalisers but it can also be used to determine the roll off point of shelving EQs as well.

TRS JACK

A Tip, Ring, Sleeve 'A' gauge jack.

VCA

Voltage Controlled Amplifier. An amplifier whose gain can be controlled by a DC Voltage applied to its control port.

WRITING STRIP

See scribble strip.

XLR

The XLR (in fact a specific manufacturer's model reference) is an industry standard connector of high quality and is normally used for balanced signals, primarily microphones and balanced outputs. The most common is a three pin version, although there are types with more pins for other purposes. In fact XLR is derived from eXtra Low Resistance !



Declaration of Conformity

The Directives Covered by this Declaration.

89/336/EEC Electromagnetic Compatibility Directive, amended by
92/31/EEC & 93/68/EEC

72/23/EEC Low Voltage Equipment Directive, amended by 93/68/
EEC.

The Products Covered by this Declaration.

Model CS3 Mixing Console.

Model CS8 Mixing Console.

Model CS12M Mixing Console.

The Basis on which Conformity is being Declared

The Products named above and hence the Variants thereof listed
above comply with the requirements of the above EU directives by
meeting the following standards:

EN55013(1990)

EN 55020

EN 60065

Signed: 
G.M.Squires
Authority: Product Support Manager.
Date: 1st January 1997.

Attention

The attention of the specifier, purchaser, installer, or user is drawn to special
limitations to use which must be observed when these products are taken into
service to maintain compliance with the above directives. Details of these special
measures and limitations to use are available on request, and are also contained
in product manuals.

If within a period of three years from the date of delivery of the equipment to the End User it shall prove defective by reason only of faulty materials and/or workmanship (but not faulty design) to such an extent that the effectiveness and/or the usability thereof is materially affected, the Equipment or the faulty component shall be returned to the Distributor or DDA and subject to the following conditions the Distributor or DDA will repair or at its option replace the defective components. Any components replaced will become the property of DDA.

Any Equipment or component returned will be at the risk of the End User whilst in transit (both to and from the Distributor or DDA) and postage and/or freight charges must be prepaid.

This Warranty shall only be available if:-

- i) The Equipment has been properly installed in accordance with the instructions contained in this manual.
- ii) The End User has notified the Distributor or DDA in writing within 14 days of the defect appearing.
- iii) No persons other than authorised representatives of DDA or the Distributor have effected any replacement of parts, maintenance adjustments or repairs to the Equipment.
- iv) The End User has used the Equipment for such purposes as DDA recommends with only such operating supplies as meet DDA's specifications or approval and otherwise in all respects in accordance with DDA's recommendations.

Defects arising as a result of the following are not covered by this Warranty :-

Faulty or negligent handling, chemical or electro-chemical or electrical influences, accidental damage, Acts of God, neglect, deficiency in electrical power, air conditioning or humidity control.

Benefit of this Warranty may not be assigned by the End User. End Users who are consumers should note that their rights under this Warranty are in addition to and do not affect any other rights to which they may be entitled against the seller of the Equipment.

DDA shall not be liable for any damage caused to persons or property due to :-

- i) Incorrect usage of the Equipment
- ii) Other equipment attached to the Equipment, which is not approved by DDA
- iii) Modifications made by non-authorised persons, or by using non-recommended parts, or incorrectly made.

In no circumstances shall DDA be liable for any indirect or consequential costs, damages or losses (including loss of business profits, operating time or otherwise) arising out of the use or inability to use the product, whether or not the likelihood of damage was advised to DDA or its distributor.

Fuses and filament lamps are specifically excluded from this warranty.

This notice does not affect your statutory rights.