

Service Manual

KARMA

CONTENTS

- 1) Structural Diagram - - - - -
- 2) Block Diagram - - - - -
- 3) Circuit Diagram - - - - -
- 4) Diagnostics - - - - -
- 5) Parts List - - - - -

Revision: 1.00
Issued date: June 26th, 2001
Issued by: KORG INC.

X-9100 KARMA for Service Manual

W= 1100mm

D= 320mm

H= 119mm

Weight= 10.0kg

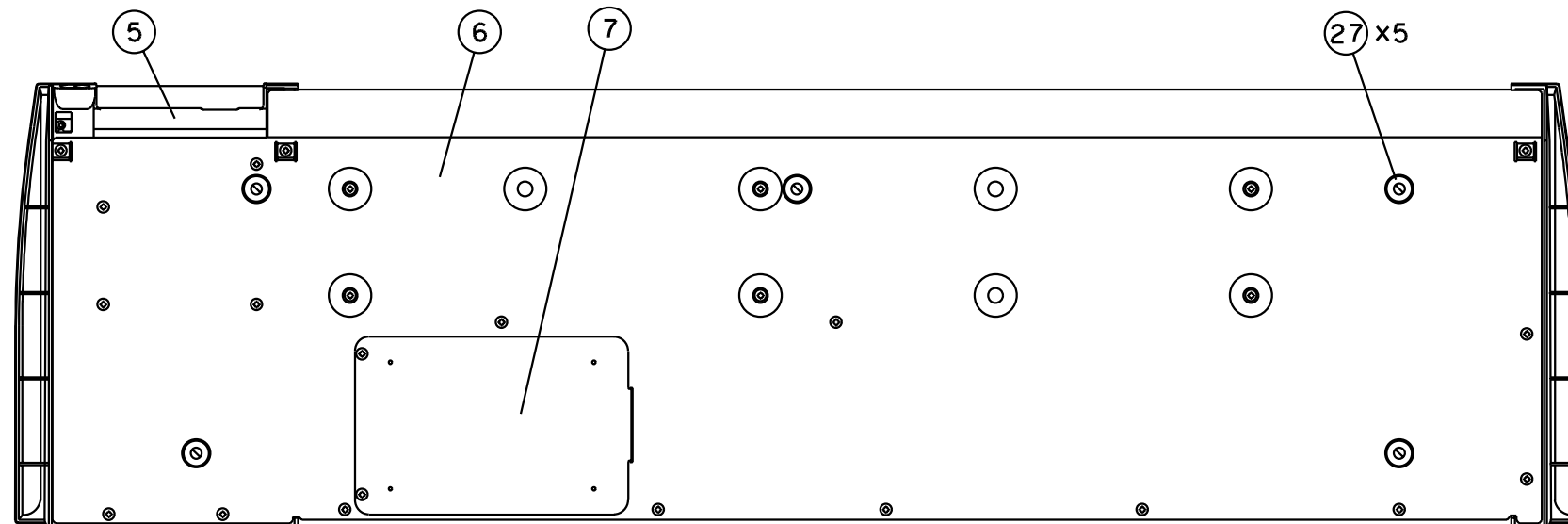
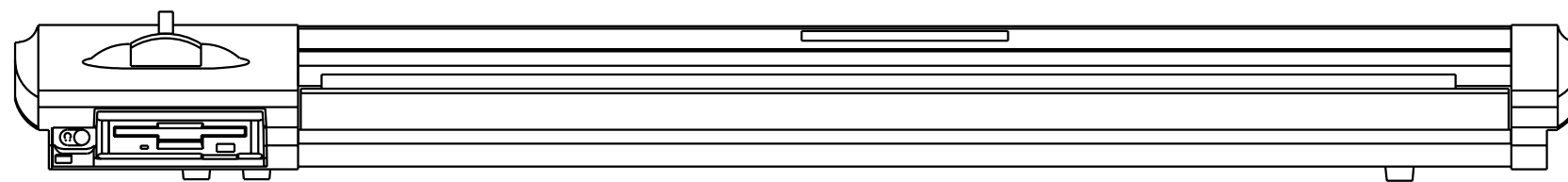
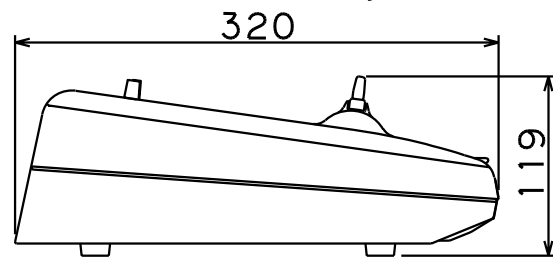
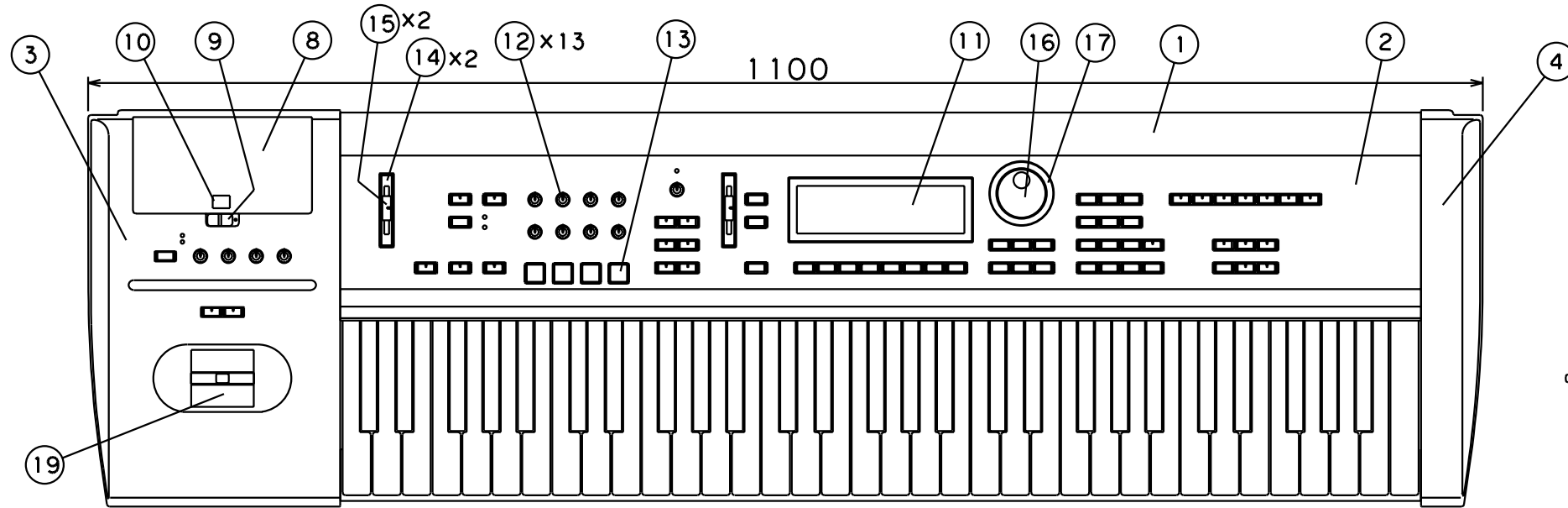
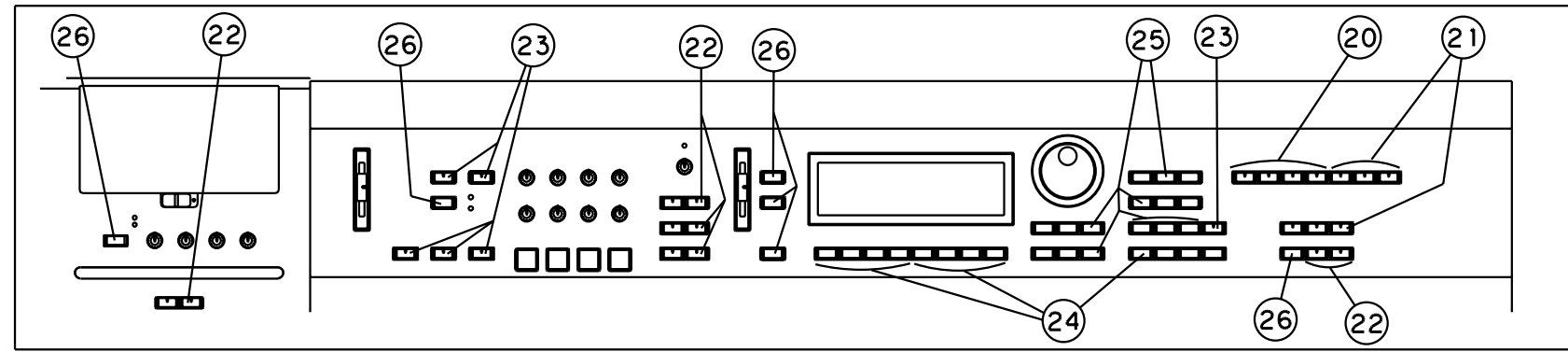
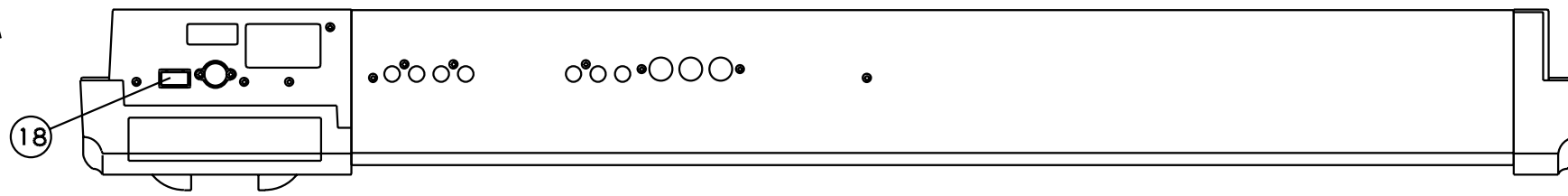

NO.	PART CODE	PART NAME	QTY
1	641041608	X-9100 PANEL KOC-C10216-1	1
2	630033000	X-9100 PANEL SHEET F30084-1	1
3	646075500	X-9100 SIDE PLATE L ASSY H30206	1
4	646075600	X-9100 SIDE PLATE R E10179-1	1
5	646075800	X-9100 FDD COVER KOC-E20206-1	1
6	641041629	X-9100 BOTTOM COVER C10218-1	1
7	641041625	X-9100 OP COVER KOC-C30550	1
8	646075700	X-9100 SIMM COVER KOC-E20207-1	1
9	646075900	X-9100 SLIDE HOOK 1 KOC-E40514	1
10	540025200	PUSH LATCH 024A	1
11	630033100	X-9100 LCD WINDOW KOC-E40513-1	1
12	620040700	X-9100 VR KNOB KOC-E40519-1	13
13	620037900	X-8110 KNOB L H40148-4	1
14	646065400	X-610/620 SVR FRAME ASSY 30 H4012	2
15	620026800	X-410 SVR KNOB (GRAY) E40239-3	2
16	620036000	X-610 ENCODER KNOB(BLK)E40466-3	1
17	646066600	X-610 ENCODER FRAME KOC-E40467	1
18	620024600	X-952 PSW KNOB KOC-E40304-2	1
19	646040000	X-011/012 JS COVER KOC-E20134	1
20	620031800	4 LINKAGE KNOB A-4-BK H40130-4-BK	1
21	620031900	4 LINKAGE KNOB A-3-BK H40130-3-BK	2
22	620032000	4-LINKAGE KNOB A-2-BK H40130-2-BK	5
23	620032100	4-LINKAGE KNOB A-1-BK H40130-1-BK	6
24	620033800	4 LINKAGE KNOB B-4-BK H40131-4-BK	3
25	620034000	4 LINKAGE KNOB B-3-BK H40131-3-BK	5
26	620032400	4-LINKAGE KNOB B-1-BK H40131-1-BK	6
27	500022500	CASE LEG FF-004	5

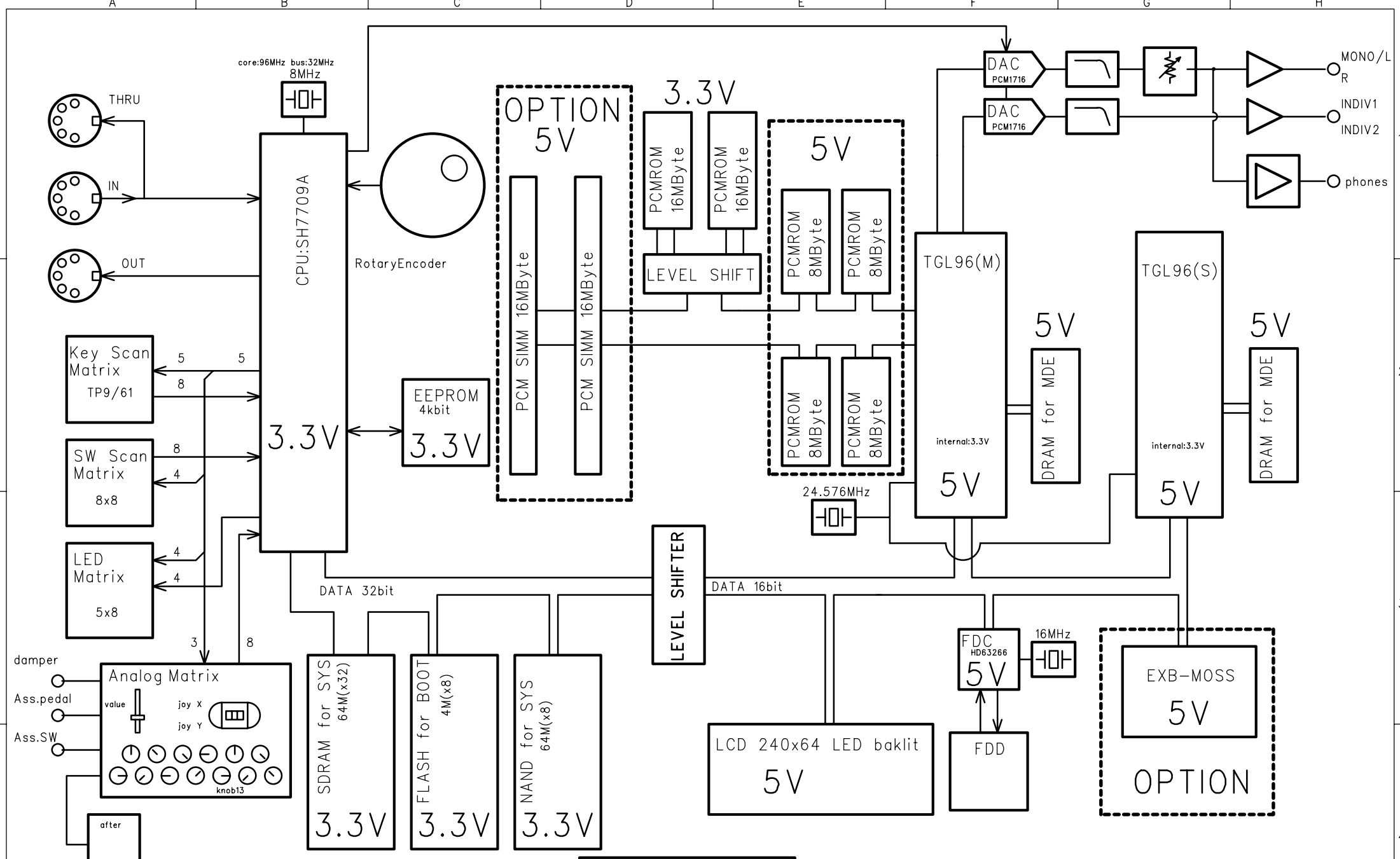

△			
△			
△			
△			
△			
MARK	REVISION REASON	DATE	REVISED BY

POWER SUPPLY

- +5V 1.5A for digital
- +3.3V 1A for digital
- +8V 300mA for DAC,phones
- +12V 50mA for line
- 12V 50mA for line

DRAWN BY <i>DRAGON</i>	CHECKED BY	APPROVED BY	MODEL TITLE
KORG		DRAWING NO. KOD-B30083	DATE Nov.29'00

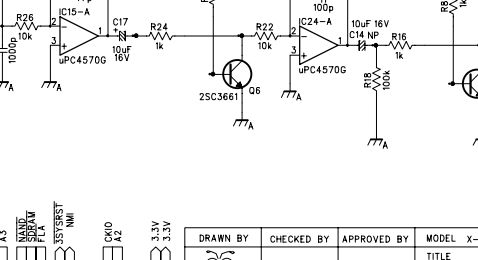
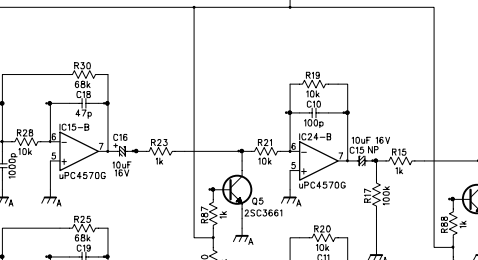
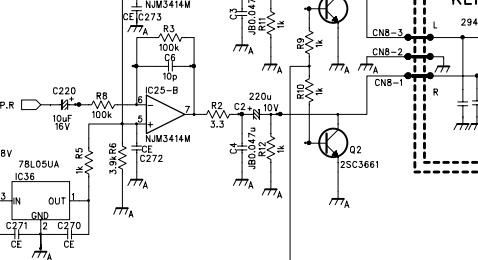
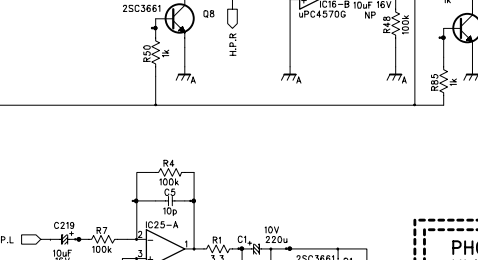
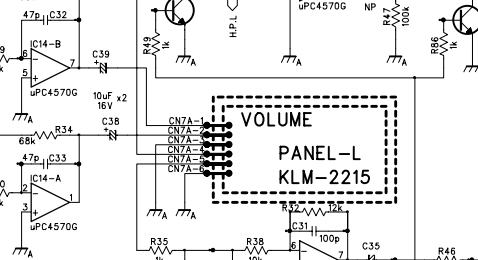
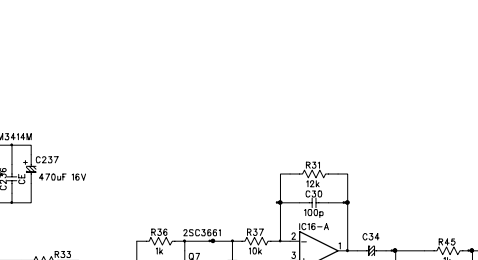
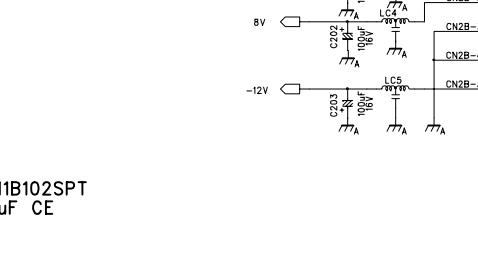
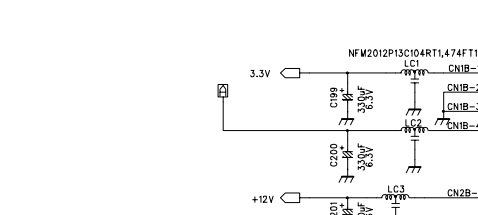
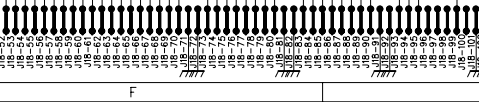
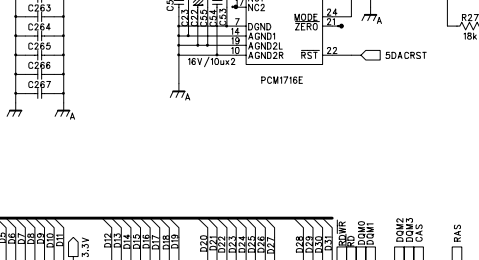
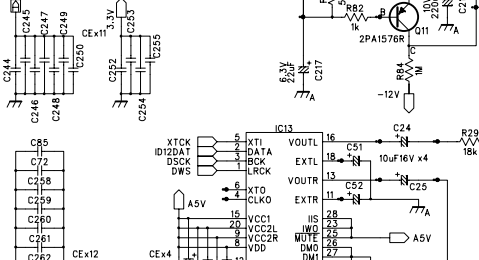
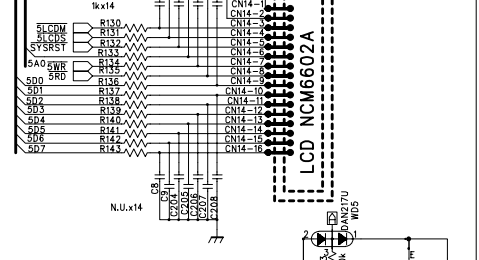
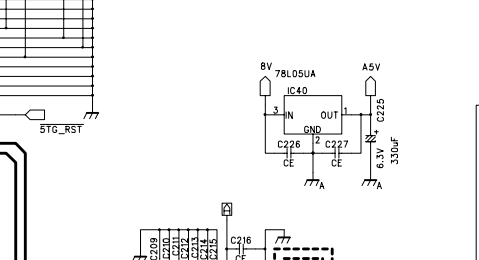
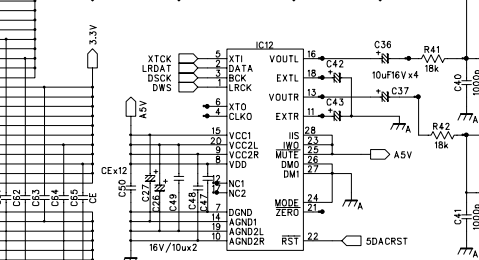
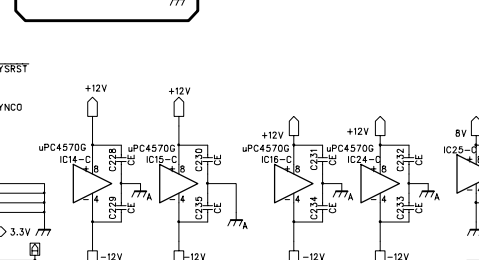
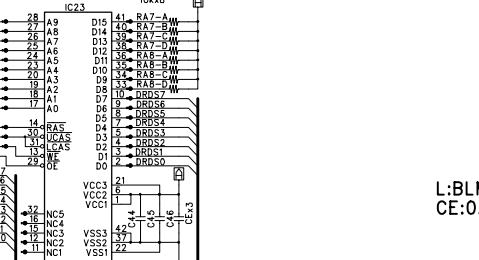
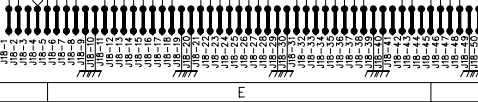
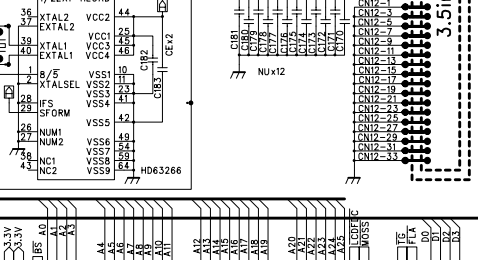
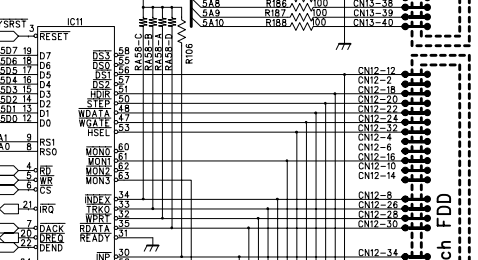
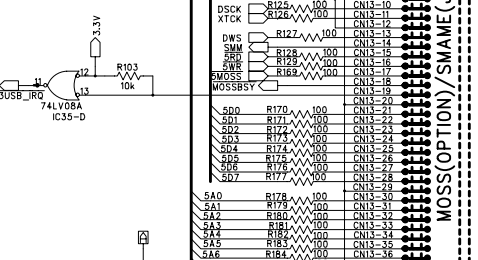
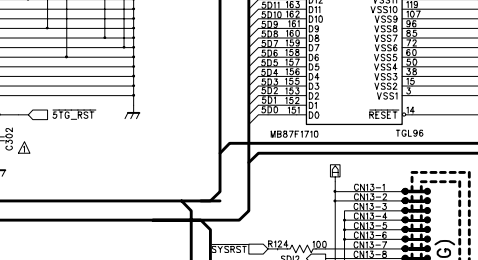
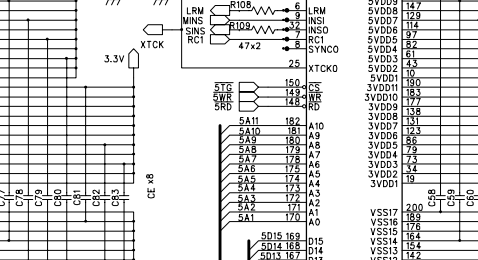
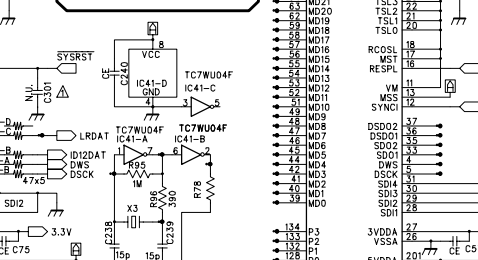
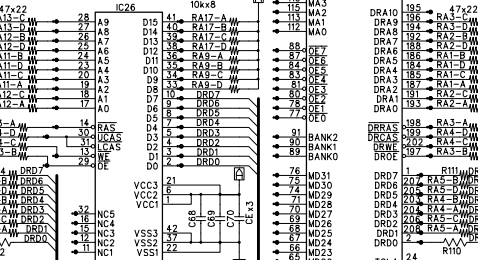
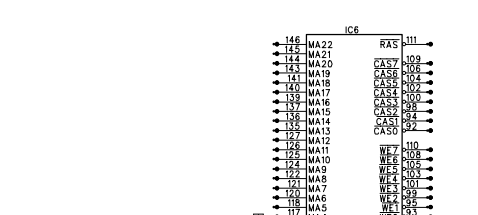
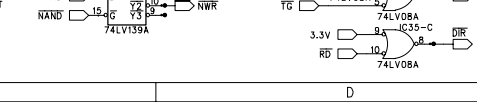
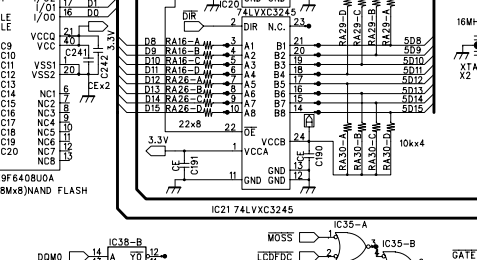
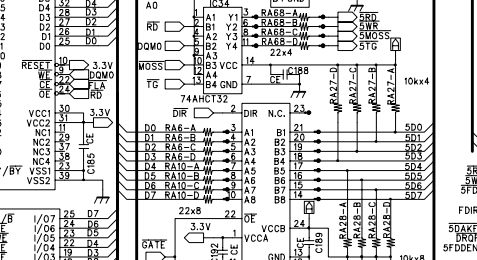
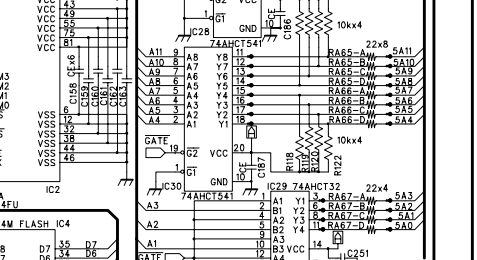
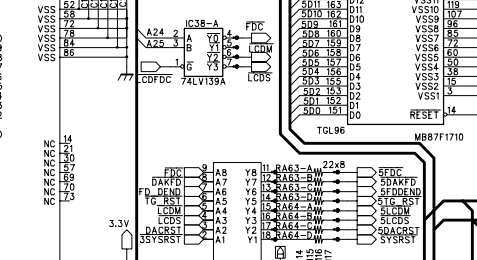
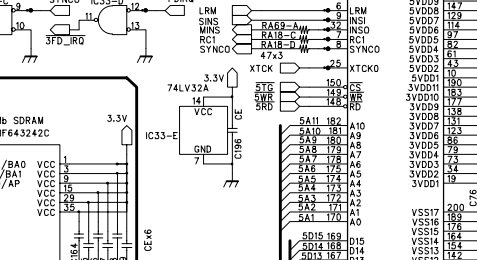
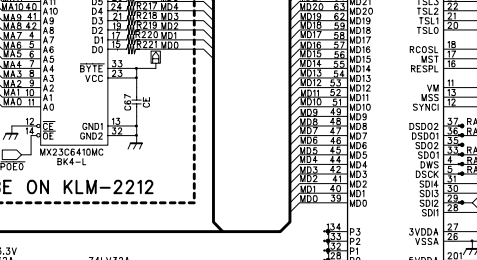
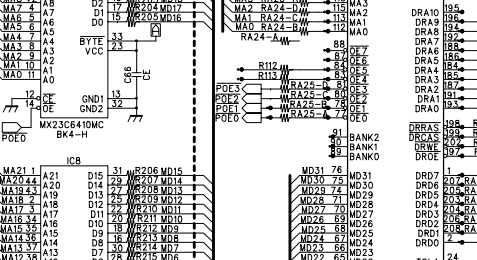
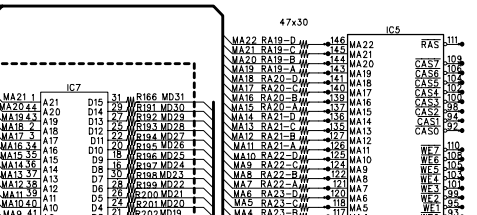
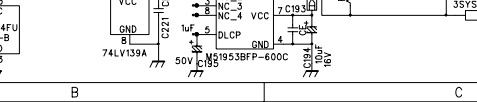
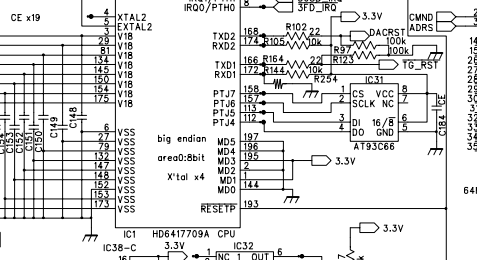
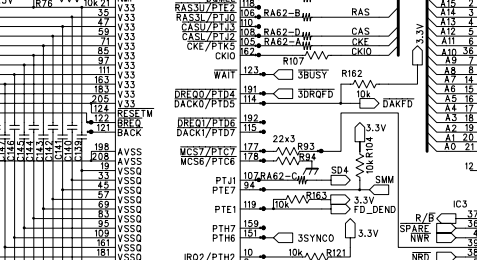
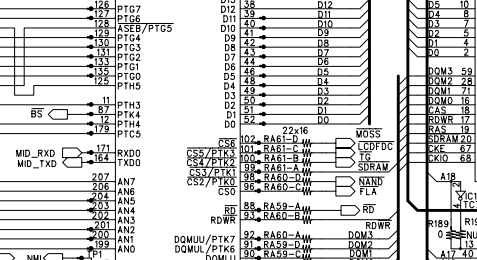
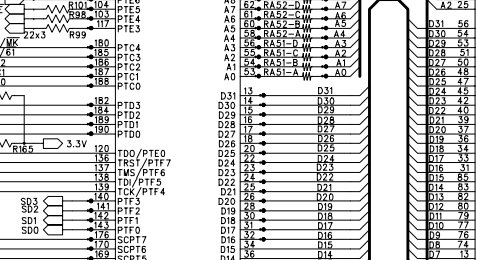
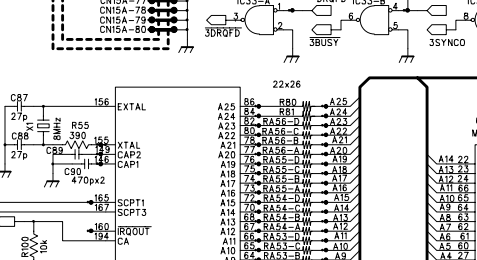
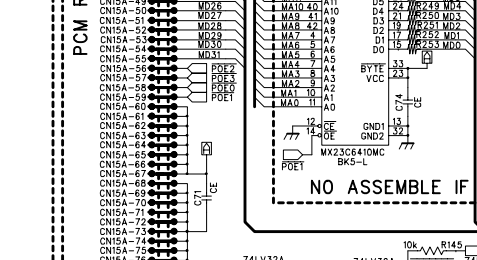
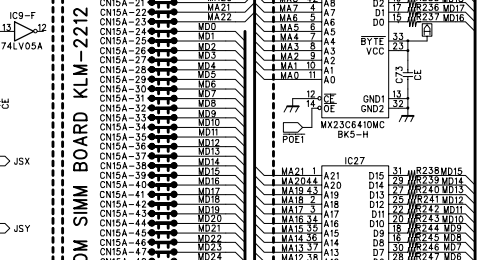
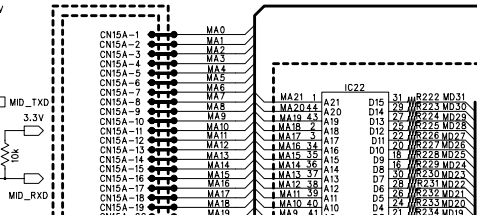
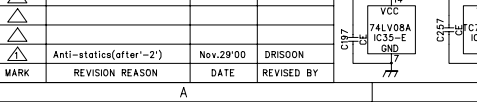
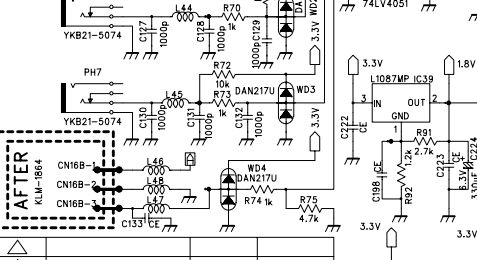
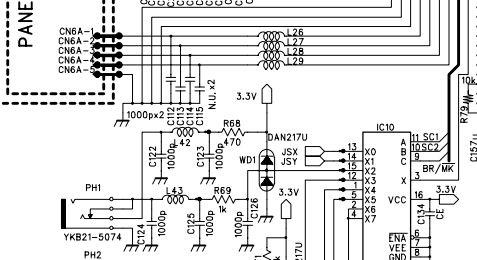
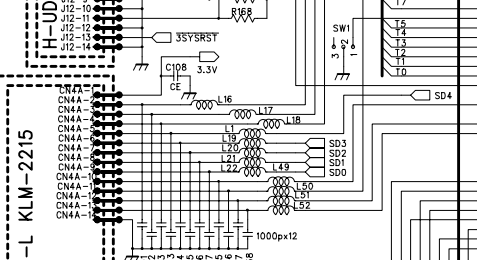
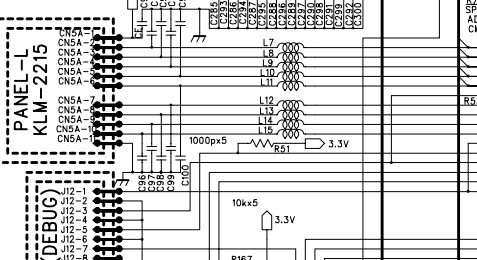
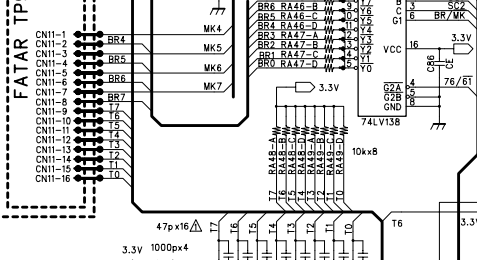
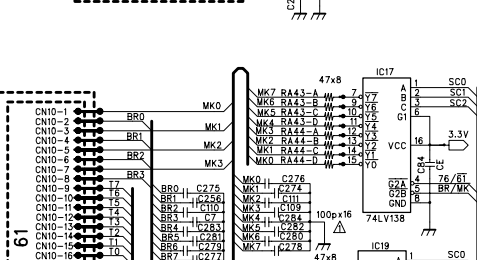
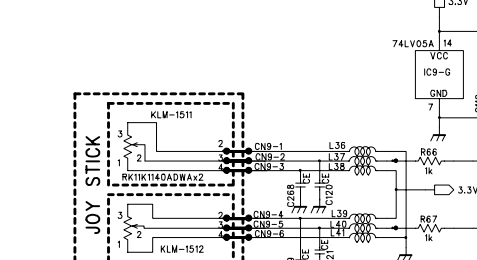
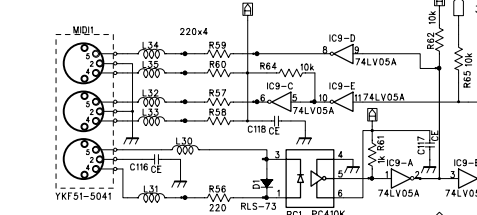
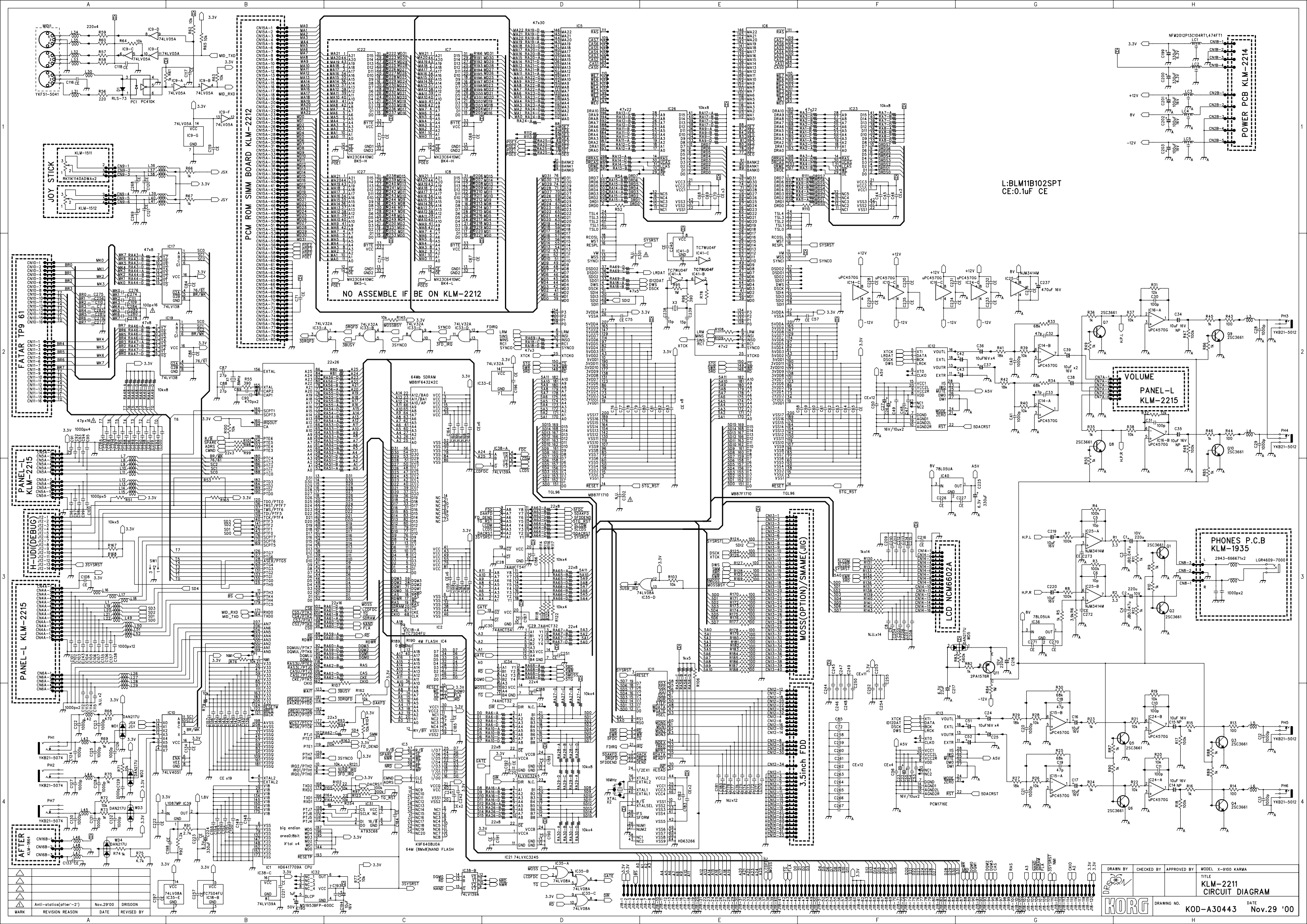
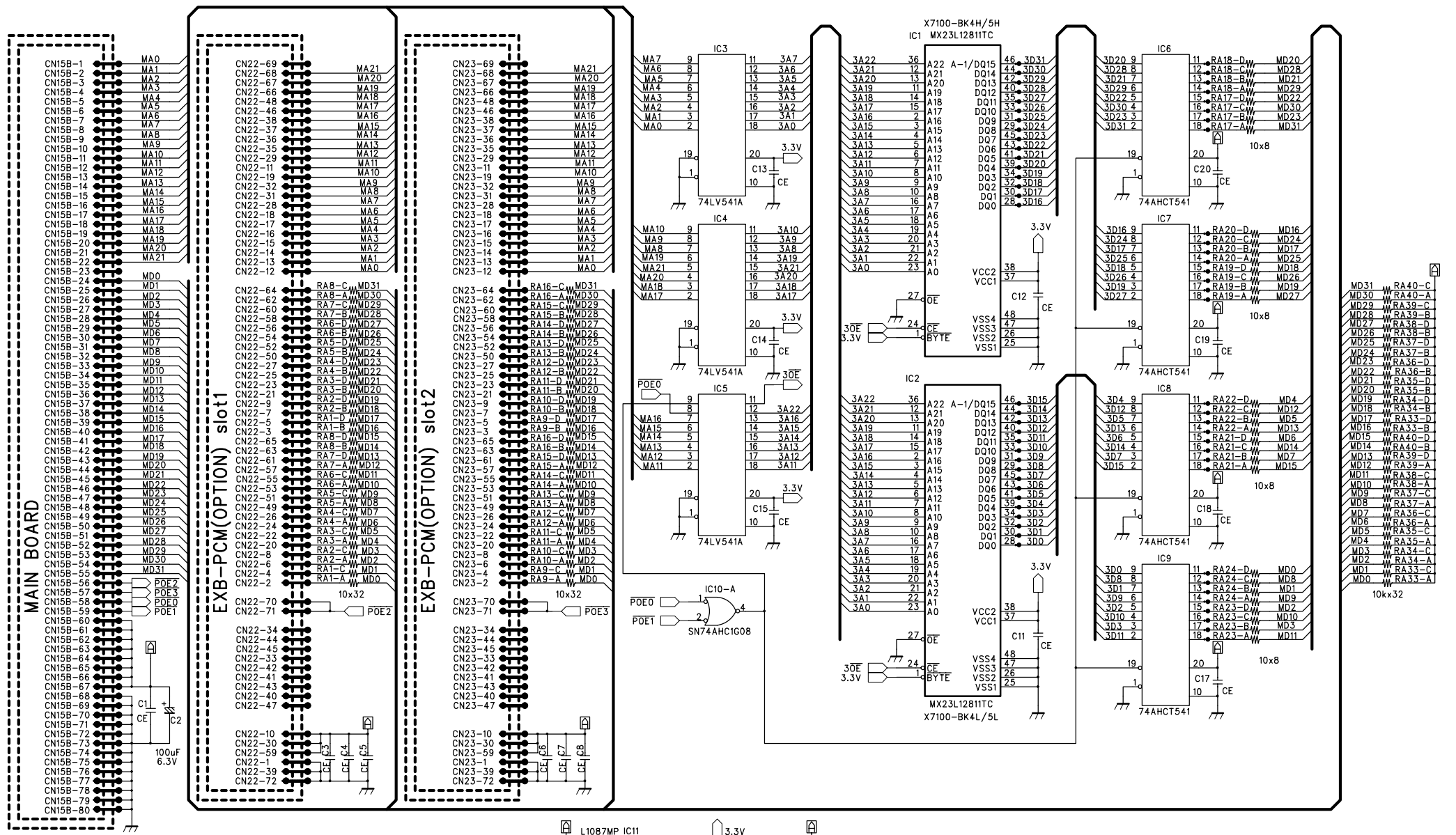

Table with 4 columns: MARK, REVISION, REASON, DATE. Includes revision history for the circuit diagram.



MARK	REVISION	REASON	DATE	REVISED BY
△				
△				
△				
△				

CE:0.1uF CE

DRAWN BY	CHECKED BY	APPROVED BY	MODEL X-9100 KARMA
			TITLE
			KLM-2212 CIRCUIT DIAGRAM
DRAWING NO.		DATE	
KOD-A40484		Sep.30 '00	

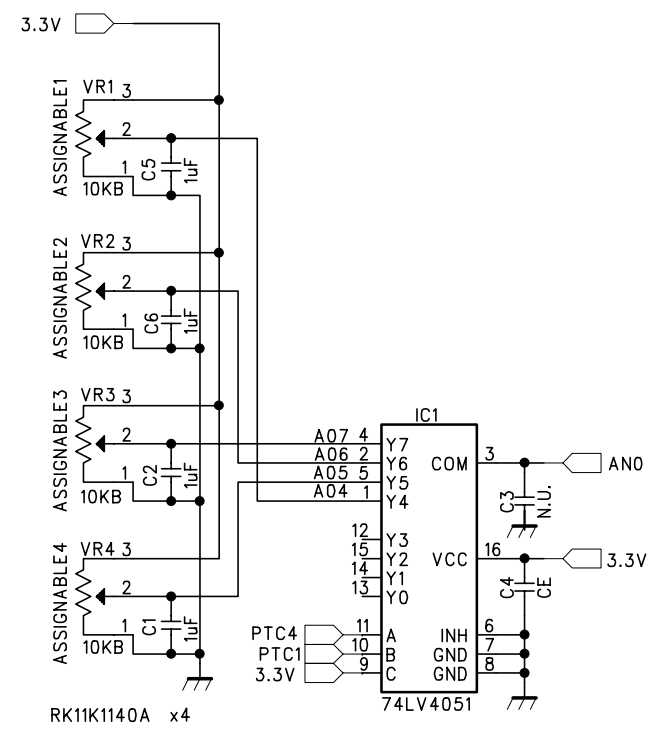
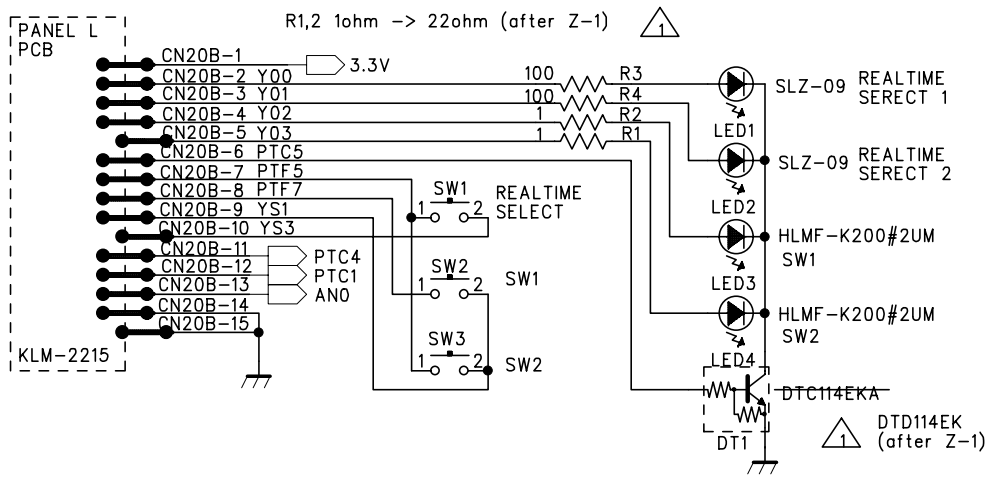

△			
△			
△			
△			
△	improved LEDs brightness	'00/12/25	S.Ohnishi
MARK	REVISION REASON	DATE	REVISED BY

DRAWN BY	CHECKED BY	APPROVED BY	MODEL X-9100
S.Ohnishi			TITLE KLM-2213(RT Control) Schematics
DRAWING NO.		DATE	
KOD-A40482		'00.6.30.	



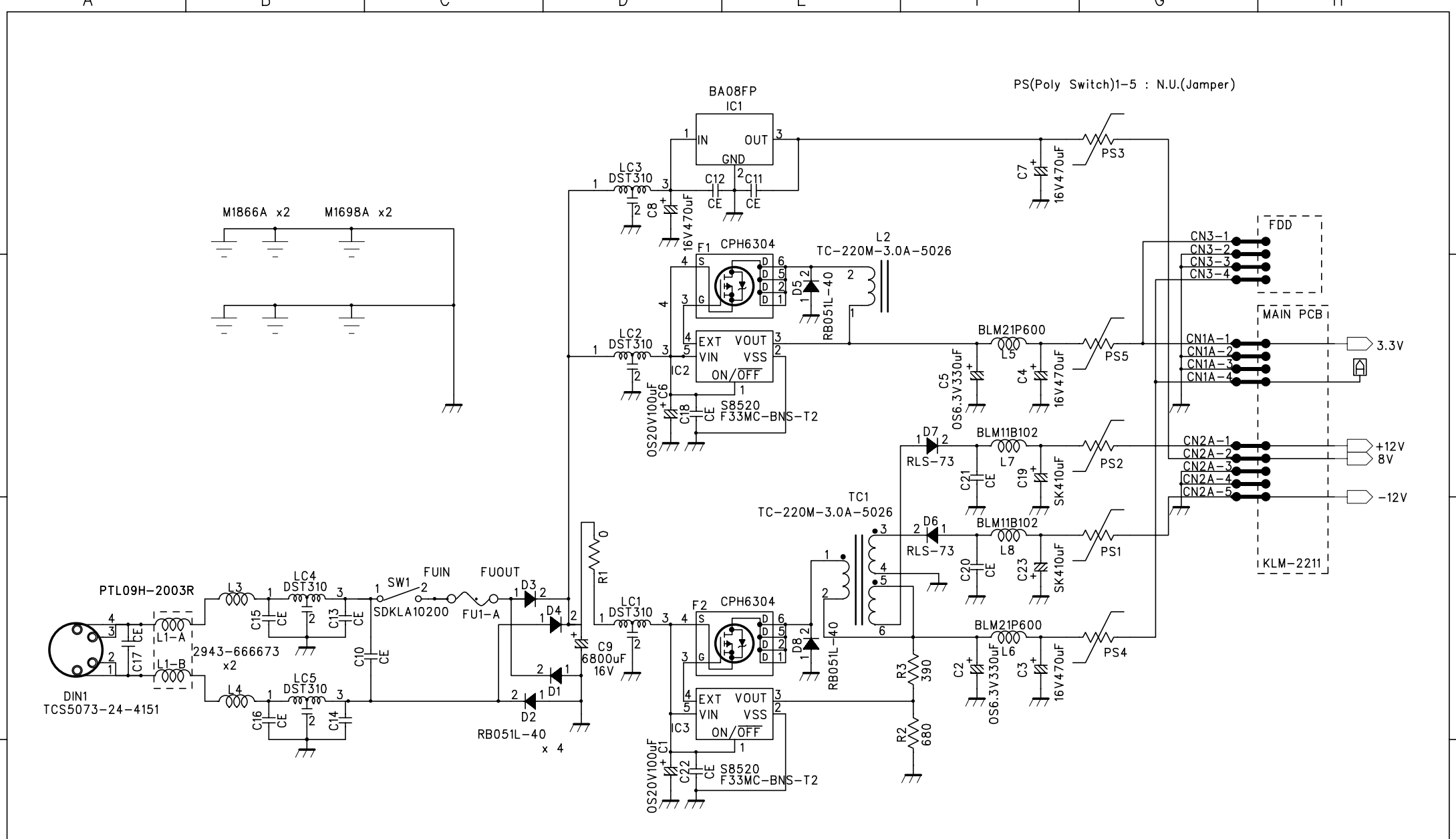

PS(Poly Switch)1-5 : N.U.(Jumper)

MARK	REVISION REASON	DATE	REVISED BY
△			
△			
△			
△			

DRAWN BY	CHECKED BY	APPROVED BY	MODEL X-9100
S.Ohnishi			TITLE KLM-2214(Power) Schematics
DRAWING NO. KOD-A40479		DATE '00.11.10.	



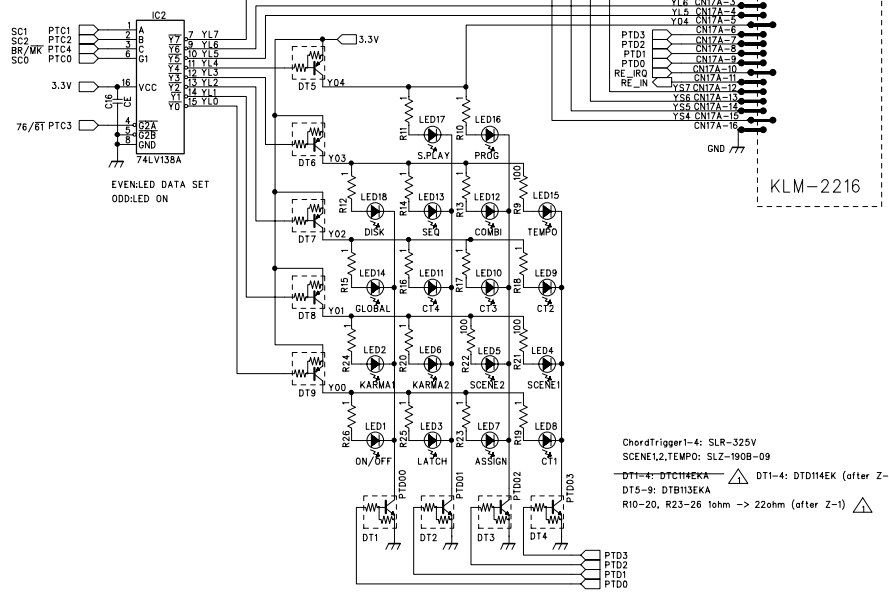
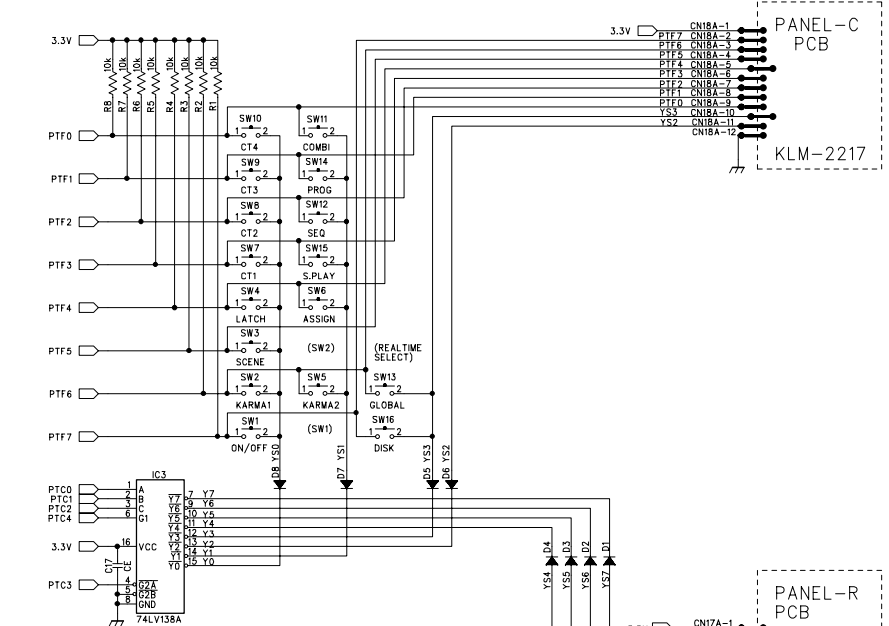
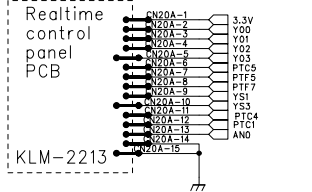
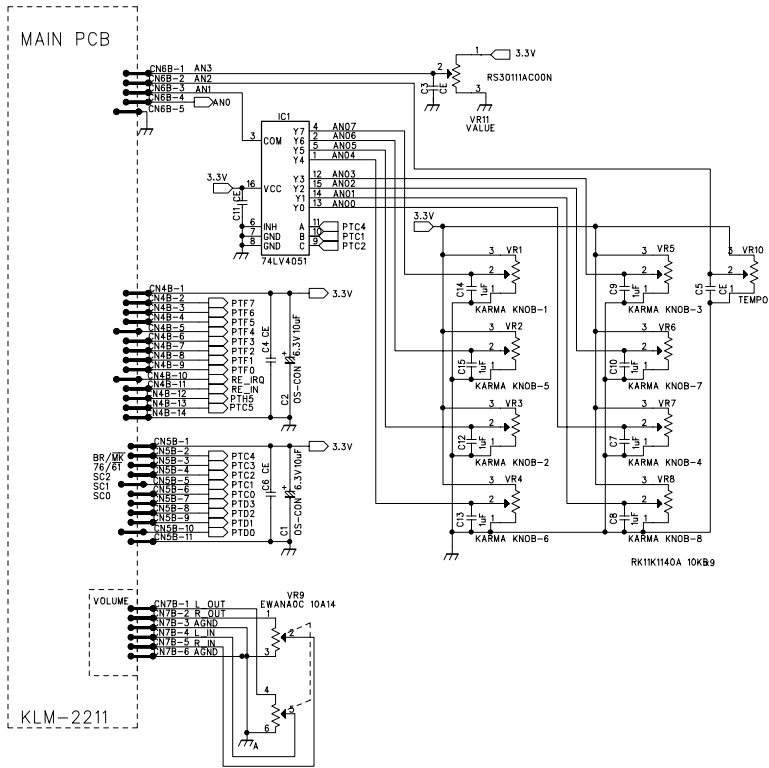

ChordTrigger1-4: SLR-325V
 SCENE1,2,TEMPO: SLZ-190B-09
 DT1-4: DTCT14EKA DT1-4: DTD14EK (after Z-1)
 DT5-9: DTB113EKA
 R10-20, R23-26 10hm -> 22ohm (after Z-1) △

△			
△			
△			
△			
△	improved LEDs brightness	'00/12/25	S.Ohnishi
MARK	REVISION REASON	DATE	REVISED BY

DRAWN BY	CHECKED BY	APPROVED BY	MODEL X-9100
S.Ohnishi			TITLE KLM-2215 (Panel L) Schematics
DRAWING NO. KOD-A30441		DATE '00.6.30.	



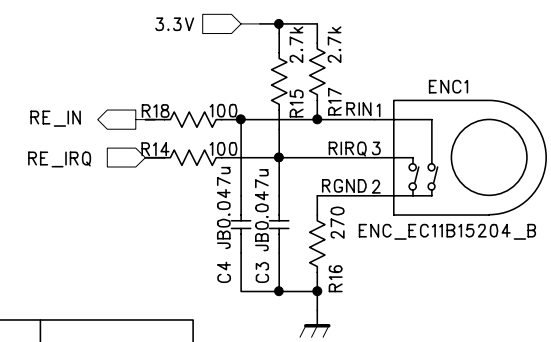
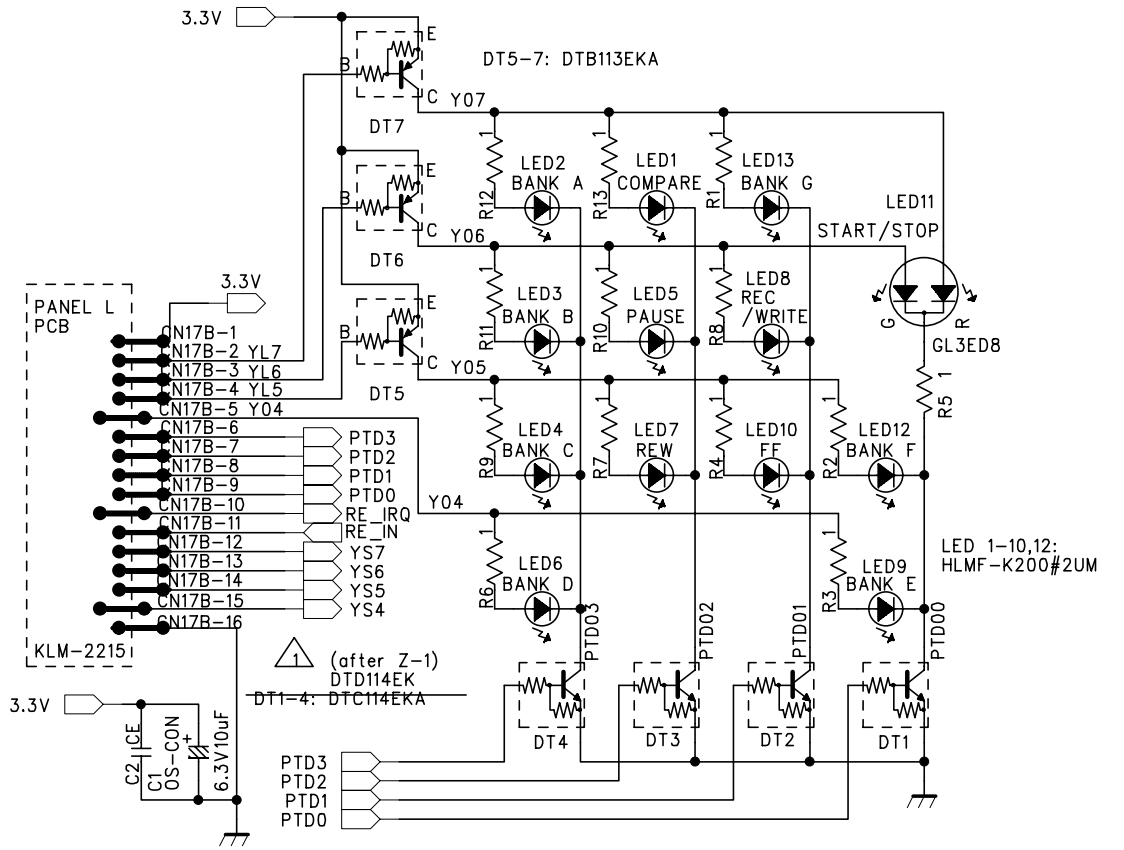
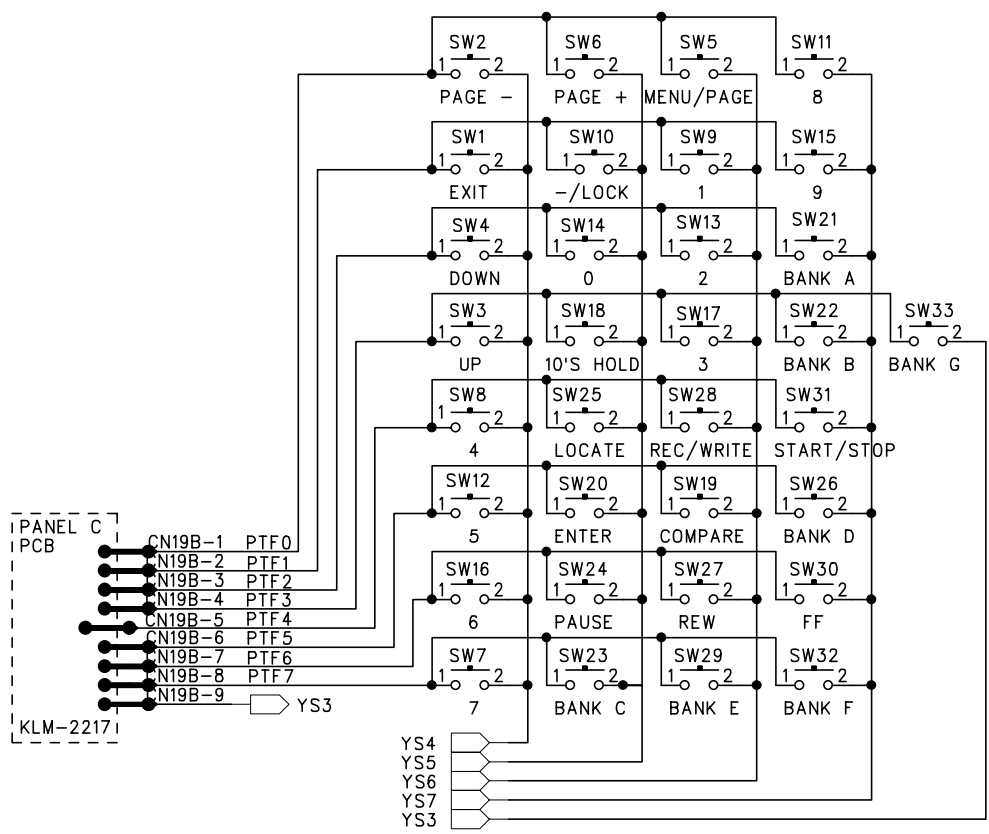

R1-13 10hm -> 22ohm (after Z-1)

	improved LEDs brightness	'00/12/25	S.Ohnishi
MARK	REVISION REASON	DATE	REVISED BY

DRAWN BY	CHECKED BY	APPROVED BY	MODEL X-9100
S.Ohnishi			TITLE KLM-2216 (PANEL R) Schematics
KORG		DRAWING NO. KOD-A40480	DATE '00.9.1.

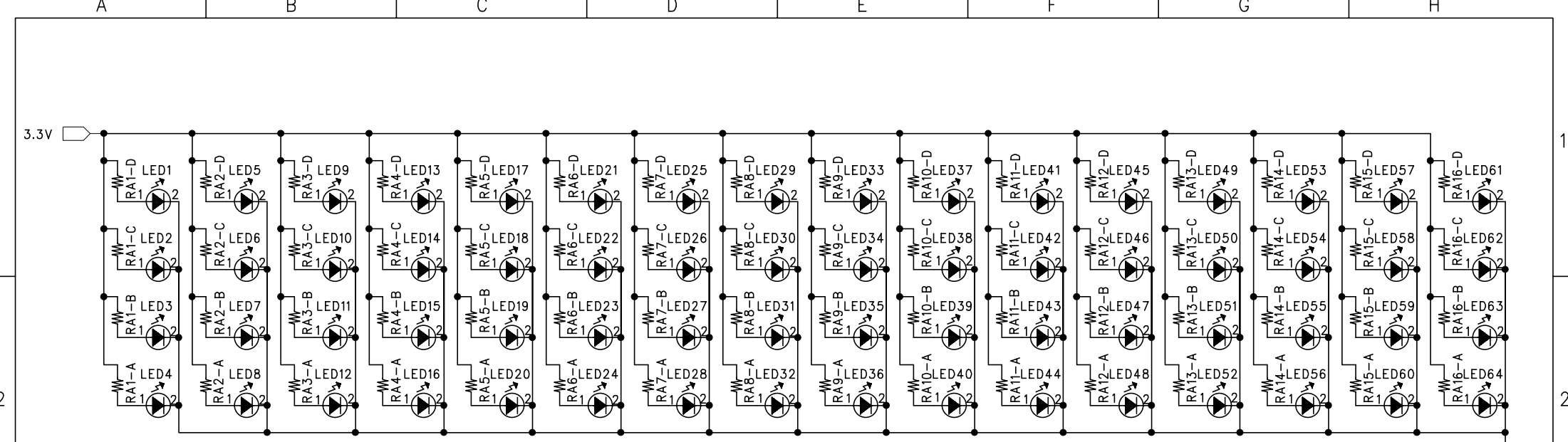

RA1-16 : 120ohm
 LED1-64: EL-17-21UYC/S530-A2

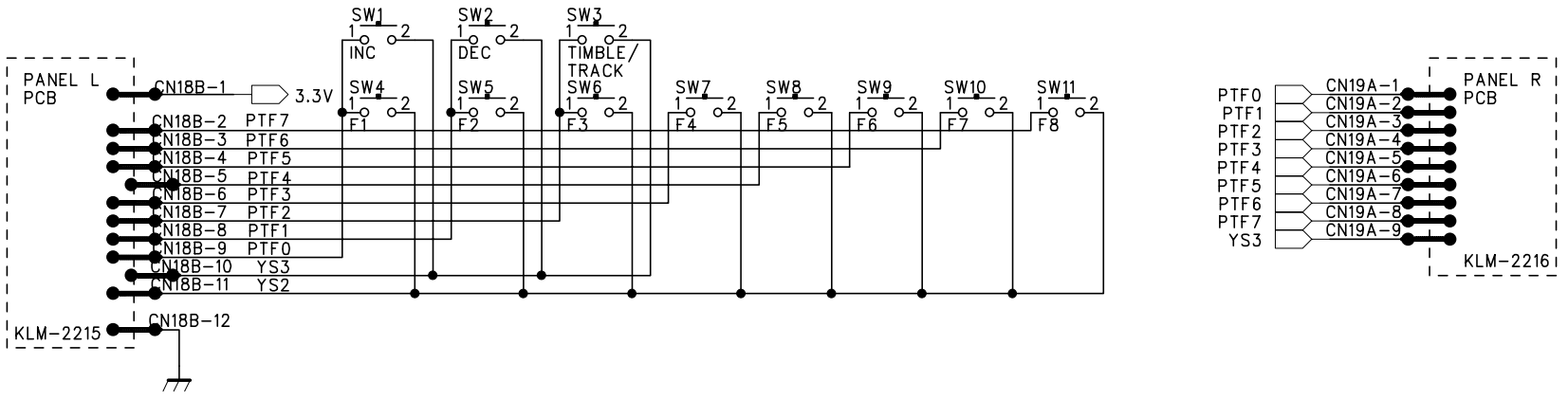

MARK	REVISION REASON	DATE	REVISED BY
△			
△			
△			
△			

DRAWN BY	CHECKED BY	APPROVED BY	MODEL X-9100
S.Ohnishi			TITLE KLM-2217 (PANEL C) schematics
		DRAWING NO.	DATE
		KOD-A40481	'00.6.30.

SW MATRIX PTC3 : L PTC4 : H

PTC2	L	L	L	L	H	H	H	H
PTC1	L	L	H	H	L	L	H	H
PTC0	L	H	L	H	L	H	L	H
	$\bar{Y}0$	$\bar{Y}1$	$\bar{Y}2$	$\bar{Y}3$	$\bar{Y}4$	$\bar{Y}5$	$\bar{Y}6$	$\bar{Y}7$
PTF0	CHORD TRIGGER2	CHORD TRIGGER3	F1	INC	EXIT	MENU/PAGE	PAGE +	8
PTF1	CHORD TRIGGER1	CHORD TRIGGER4	F2	DEC	PAGE -	-/LOCK	1	9
PTF2	ASSIGN	GLOBAL	F3	TIMBLE/TRACK	DOWN	0	2	BANK A
PTF3	KARMA2	PROG	F4	BANK G	UP	+ /10'SHOLD	3	BANK B
PTF4	LATCH	DISK	F5		4	ENTER	COMPARE	BANK C
PTF5	SCENE	SEQ	F6	SELECT	5	LOCATE	PAUSE	BANK D
PTF6	KARMA1	COMBI	F7	SW1	6	REC/WRITE	REW	BANK E
PTF7	ON/OFF	S.PLAY	F8	SW2	7	START/STOP	FF	BANK F

LED MATRIX PTC3 : L PTC0 : H

PTC4	L	L	L	L	H	H	H	H
PTC2	L	L	H	H	L	L	H	H
PTC1	L	H	L	H	L	H	L	H
	$\bar{Y}0$	$\bar{Y}1$	$\bar{Y}2$	$\bar{Y}3$	$\bar{Y}4$	$\bar{Y}5$	$\bar{Y}6$	$\bar{Y}7$
PTD0	ON/OFF	KARMA1	GLOBAL	DISK	BANK E	BANK F	S/S GREEN	S/S RED
PTD1	LATCH	KARMA2	CHORD TRIGGER4	SEQ	S.PLAY	FF	REC/WRITE	BANK G
PTD2	ASSIGN	SCENE2	CHORD TRIGGER3	COMBI	PROG	REW	PAUSE	COMPARE
PTD3	CHORD TRIGGER1	SCENE1	CHORD TRIGGER2	TEMPO	BANK D	BANK C	BANK B	BANK A
PTC5	REALTIME	ASSIGNABLE	SW1	SW2				

A/D MATRIX AN2 : TEMPO AN3 : VALUE

PTC2	L	L	L	L	H	H	H	H
PTC1	L	L	H	H	L	L	H	H
PTC4	L	H	L	H	L	H	L	H
	$\bar{Y}0$	$\bar{Y}1$	$\bar{Y}2$	$\bar{Y}3$	$\bar{Y}4$	$\bar{Y}5$	$\bar{Y}6$	$\bar{Y}7$
ANO					ASSIGN-ABLE1	ASSIGN-ABLE4	ASSIGN-ABLE2	ASSIGN-ABLE3
AN1	4	8	7	3	6	2	5	1

△			
△			
△			
△			
△			
MARK	REVISION REASON	DATE	REVISED BY

DRAWN BY	CHECKED BY	APPROVED BY	MODEL
			TITLE
DRAWING NO.			DATE
KOD-A*****			

KORG

DRAWING NO.

KOD-A*****

DATE

KARMA

How to start and operate the test mode

How to start :

ENTER + 5 + POWER ON : Full test

ENTER + 2 + POWER ON : All but internal test

ENTER + 3 + POWER ON : EXB-MOSS test

(internal test + MOSS DSP1 ~ 6 waveform confirmed)

How to operate :

ENTER : Proceed to the next test

VALUE ▲ : Item up

VALUE ▼ : Item down

FF>> : Step up

<<REW : Step down

Notes when the test mode is started:

- When the test mode is started, the calibration value of the joystick is cleared. So please execute this test item by all means.
- When any of the internal test items is indicated in the LCD, the contrast of the LCD can be adjusted by turning the Rotary encoder. However, it sometimes cannot be indicated while the internal test being executed because the data process does not catch up with the operation. So if the contrast of the LCD is required, please execute it after the internal test is done.

PART CODE	PART NAME	NOTE	QTY
001186400	PCB ASSY KLM-1864 PROPHECY	KARMA M.PART	1
001193500	PCB ASSY KLM-1935 Z1/I30/TRITO	KARMA M.PART	1
001221100	PCB ASSY KLM-2211 KARMA	KARMA M.PART	1
001221200	PCB ASSY KLM-2212 KARMA	KARMA M.PART	1
001221300	PCB ASSY KLM-2213/5/6 KARMA	KARMA M.PART	1
001221400	PCB ASSY KLM-2214 KARMA	KARMA M.PART	1
001221700	PCB ASSY KLM-2217 KARMA	KARMA M.PART	1
304020230	TR 2SC3661-TA/TB(3K) (TS)	KLM-2211 KARMA	10
304020400	TR 2SA1576A T106 (TS)	KLM-2211 KARMA	1
304050140	DIGITAL TR DTC114EKA T146 (TS)	KLM-2213/5/6 K	9
304050280	DIGITAL TR DTB113EK T146 (TS)	KLM-2213/5/6 K	8
304060300	FET CPH6304-TL(TS)	KLM-2214 KARMA	2
312010900	LED GL3ED8	KLM-2213/5/6 K	1
313005800	LCD MODULE NCM6602B	KARMA M.PART	1
314001400	DIODE RLS-73 TE-11 (TS)	KLM-2214 KARMA	2
314001400	DIODE RLS-73 TE-11 (TS)	KLM-2211 KARMA	1
314010300	DIODE 1S2076TD (TA)	KLM-2213/5/6 K	8
314010310	LED HLMF-K200#2UM (TR)	KLM-2213/5/6 K	25
314028800	LED SLZ-190B-09-T2 (TR)	KLM-2213/5/6 K	5
314030700	SCHOTTKY DIODE RB051L-40TE25	KLM-2214 KARMA	6
314031000	LED SLR-325VRT31(TR)	KLM-2213/5/6 K	4
314031700	LED EL-17-21UYC/S530A2/TRB(TS)	KLM-2217 KARMA	64
315001000	DOUBLE DIODE DAN217U T106(TS)	KLM-2211 KARMA	5
320004538	IC HD63266F (S)	KLM-2211 KARMA	1
320004675	IC HD6417709AF100B (S)	KLM-2211 KARMA	1
320012223	IC MB87F1710PFV-G-BND(S)	KLM-2211 KARMA	2
320012278	IC MBM29LV004TC-90TN(X9100):S	KLM-2211 KARMA	1
320012280	IC MB81F643242C-10FN(S)	KLM-2211 KARMA	1
320040069	MX23L12811TC12X7100BK4H/5H(S)	KLM-2212 KARMA	1
320040070	MX23L12811TC12X7100BK4L/5L(S)	KLM-2212 KARMA	1
324001015	IC UPC4570G2-E2 (TS)	KLM-2211 KARMA	4
324001167	IC UPC78L05T-E2 (TS)	KLM-2211 KARMA	2
324003010	IC TC7WU04F TE12L (TS)	KLM-2211 KARMA	1
324003022	IC TC7S04FU (TE85L) (TS)	KLM-2211 KARMA	1
324003060	IC TC58V64AFT(EL) (TS)	KLM-2211 KARMA	1
324007010	IC BA08FP-E2 (TS)	KLM-2214 KARMA	1
324009019	IC NJM2115M-TE2 (TS)	KLM-1864 KARMA	1
324009031	IC NJM3414AM-T1 (TS)	KLM-2211 KARMA	1
324011012	IC M51953BFP-600C (TS)	KLM-2211 KARMA	1
324021005	IC AT93C66-10SI/SC2.7 (TS)	KLM-2211 KARMA	1
324021014	IC SN74LV138ANS-EL (TS)	KLM-2213/5/6 K	2
324021019	IC SN74AHCT32PWR(TS)	KLM-2211 KARMA	2
324021026	IC SN74AHCT541PWR(TS)	KLM-2212 KARMA	4
324021026	IC SN74AHCT541PWR(TS)	KLM-2211 KARMA	2
324021031	IC SN74AHC1G08DBVR(TS)	KLM-2212 KARMA	1
324021032	IC SN74LV4051ANSR (TS)	KLM-2213/5/6 K	2
324021102	IC SN74LV08APWR (TS)	KLM-2211 KARMA	1
324021103	IC SN74LV32APWR (TS)	KLM-2211 KARMA	1
324021106	IC SN74LV139APWR (TS)	KLM-2211 KARMA	1

PART CODE	PART NAME	NOTE	QTY
324021108	IC SN74LV138APWR (TS)	KLM-2211 KARMA	2
324021114	IC SN74LV05APWR (TS)	KLM-2211 KARMA	1
324021118	IC SN74LVC541APWR (TS)	KLM-2212 KARMA	3
324021119	IC SN74LV4051APWR (TS)	KLM-2211 KARMA	1
324021120	IC SN74LVCC3245APWR (TS)	KLM-2211 KARMA	1
324023008	IC S-8520F33MC-BNS-T2(TS)	KLM-2214 KARMA	2
324024001	IC L1087MPX-ADJ (TS)	KLM-2212 KARMA	1
324024001	IC L1087MPX-ADJ (TS)	KLM-2211 KARMA	1
324036008	IC PCM1716E/2K(TS)	KLM-2211 KARMA	2
324037004	IC HY5118164CJC-60-TE1(TS)	KLM-2211 KARMA	2
334000600	PHOTO COUPLER PC-410K (TS)	KLM-2211 KARMA	1
335011900	CRYSTAL OSC CA-301 24.576MHZ	KLM-2211 KARMA	1
335012400	CRYSTAL OSC CA-301 8MHZ	KLM-2211 KARMA	1
335400139	CERAMIC OSC CSTCV16.00MXJ0C1	KLM-2211 KARMA	1
350002233	SFR RH0615CN3J 3.3K	KLM-1864 KARMA	1
350002447	SFR RH0615CS5J 470K	KLM-1864 KARMA	1
360024500	VR RK11K1140ADW	KLM-1511/1512	2
362009007	VR RK11K1140A9L	KLM-2213/5/6 K	13
365007800	SVR RS30111AC00N	KLM-2213/5/6 K	1
365009500	SLIDE VR EWA NA0C10B14 10KB	KLM-2213/5/6 K	1
370005000	REC EC11B15204A5	KLM-2213/5/6 K	1
374000600	TSW EVQ11A09K (TR)	KLM-2217 KARMA	11
374000600	TSW EVQ11A09K (TR)	KLM-2213/5/6 K	52
375014800	PSW SDKLA10200	KLM-2214 KARMA	1
402002800	COIL 2943-666671	KLM-1935 KARMA	2
402004600	COIL 2943-666673	KLM-2214 KARMA	2
402006500	COIL TC-600M-3A-5026	KLM-2214 KARMA	1
402006600	COIL TBC0.8X18:0.3X45:0.3X27T	KLM-2214 KARMA	1
402007100	COIL PLT09H-2003R	KLM-2214 KARMA	1
404001050	CHIP COIL BLM21P600SGTP(TS)	KLM-2214 KARMA	2
404001070	CHIP COIL BLM11B102SPT:TS	KLM-2214 KARMA	2
404001070	CHIP COIL BLM11B102SPT:TS	KLM-2211 KARMA	48
405011500	AC-AC ADAPTOR KA161(100/3.0A)	KARMA JP M.PAR	1
405011600	AC-AC ADAPTOR KA163(120V/3.0A)	KARMA US M.PAR	1
405011600	AC-AC ADAPTOR KA163(120V/3.0A)	KARMA CN M.PAR	1
405011600	AC-AC ADAPTOR KA163(120V/3.0A)	KARMA EX M.PAR	1
405011700	AC-AC ADAPTOR KA169(230V/3.0A)	KARMA WG M.PAR	1
405011700	AC-AC ADAPTOR KA169(230V/3.0A)	KARMA UK M.PAR	1
405011700	AC-AC ADAPTOR KA169(230V/3.0A)	KARMA FR M.PAR	1
405011700	AC-AC ADAPTOR KA169(230V/3.0A)	KARMA GE M.PAR	1
405011800	AC-AC ADAPTOR KA165(240V/3.0A)	KARMA AU M.PAR	1
420005800	61TP/9S+PCBOARD+AFTERTOUC	KARMA M.PART	1
430008468	F.D KMFD-00P	KARMA M.PART	1
435001900	FDD(2MODE) JU-257A726P	KARMA M.PART	1
450003100	PHONE JACK LGR4609-7000	KLM-1935 KARMA	1
454004300	PHONE JACK YKB21-5012	KLM-2211 KARMA	4
454009900	PHONE JACK YKB21-5074G	KLM-2211 KARMA	3
454011700	DIN CONNECTOR TCS5073-24-4151	KLM-2214 KARMA	1
464002401	FUSE 125V 2.5A GGS2.5	KARMA M.PART	1

PART CODE	PART NAME	NOTE	QTY
471070301	CONNECTOR TOP B3B-PH-K-S (U)	KLM-1864 KARMA	1
471101030	CONNECTOR TOP SC25-03WS	KLM-2211 KARMA	1
471101040	CONNECTOR TOP SC25-04WS	KLM-2214 KARMA	2
471101040	CONNECTOR TOP SC25-04WS	KLM-2211 KARMA	1
471101050	CONNECTOR TOP SC25-05WS	KLM-2214 KARMA	1
471101050	CONNECTOR TOP SC25-05WS	KLM-2211 KARMA	1
471101060	CONNECTOR TOP SC25-06WS	KLM-2213/5/6 K	1
471101060	CONNECTOR TOP SC25-06WS	KLM-2211 KARMA	1
471102030	CONNECTOR TOP SJ20-03WX	KLM-2211 KARMA	1
471102030	CONNECTOR TOP SJ20-03WX	KLM-1935 KARMA	1
471102050	CONNECTOR TOP SJ20-05WX	KLM-2213/5/6 K	1
471102050	CONNECTOR TOP SJ20-05WX	KLM-2211 KARMA	1
471102060	CONNECTOR TOP SJ20-06WX	KLM-2211 KARMA	1
471102090	CONNECTOR TOP SJ20-09WX	KLM-2217 KARMA	1
471102090	CONNECTOR TOP SJ20-09WX	KLM-2213/5/6 K	1
471102110	CONNECTOR TOP SJ20-11WX	KLM-2213/5/6 K	1
471102110	CONNECTOR TOP SJ20-11WX	KLM-2211 KARMA	1
471102120	CONNECTOR TOP SJ20-12WX	KLM-2217 KARMA	1
471102120	CONNECTOR TOP SJ20-12WX	KLM-2213/5/6 K	1
471102140	CONNECTOR TOP SJ20-14WX	KLM-2213/5/6 K	1
471102140	CONNECTOR TOP SJ20-14WX	KLM-2211 KARMA	1
471102150	CONNECTOR TOP SJ20-15WX	KLM-2213/5/6 K	2
471102160	CONNECTOR TOP SJ20-16WX	KLM-2213/5/6 K	2
474019500	CONNECTOR 1-215079-6 16P (AMP)	KLM-2211 KARMA	2
474019700	CONNECTOR 76382-404	KLM-1864 KARMA	1
474028900	SIMM CONNECTOR 52706-7220	KLM-2212 KARMA	2
474031000	CONNECTOR B16B-PHDSS	KLM-2211 KARMA	1
474032000	CONNECTOR 8802-080-170S	KLM-2212 KARMA	1
474032100	CONNECTOR 8812-080-170S	KLM-2211 KARMA	1
474032800	CONNECTOR 302A-34PGASA(OR B)03	KLM-2211 KARMA	1
474032900	CONNECTOR 302A-40PGAS003	KLM-2211 KARMA	1
475002964	HARNESS HNS-2964	KARMA M.PART	1
475002965	HARNESS HNS-2965	KARMA M.PART	1
475002966	HARNESS HNS-2966	KARMA M.PART	1
475002967	HARNESS HNS-2967	KARMA M.PART	1
475002968	HARNESS HNS-2968	KARMA M.PART	1
475002969	HARNESS HNS-2969	KARMA M.PART	1
475002970	HARNESS HNS-2970	KARMA M.PART	1
475002971	HARNESS HNS-2971	KARMA M.PART	1
475002972	HARNESS HNS-2972 BOARD IN	KLM-1511/1512	1
475002973	HARNESS HNS-2973	KARMA M.PART	1
475002974	HARNESS HNS-2974	KARMA M.PART	1
475002975	HARNESS HNS-2975	KARMA M.PART	1
475002976	HARNESS HNS-2976	KARMA M.PART	1
475002977	HARNESS HNS-2977	KARMA M.PART	1
475002978	HARNESS HNS-2978	KARMA M.PART	1
475102268	HARNESS HNS-2268(F) L=31CM	KARMA M.PART	1
475102269	HARNESS HNS-2269(F) L=25CM	KARMA M.PART	1
475102979	HARNESS DDD34101-40C(HNS-2979)	KARMA M.PART	1

PART CODE	PART NAME	NOTE	QTY
480010380	DIN JACK YKF51-5041	KLM-2211 KARMA	1
500022500	CASE LEG FF-004	KARMA M.PART	5
500032700	X-9200 PCB SPACER KOC-C40920	KARMA M.PART	1
500032800	X-9100 SPONGE SPACER C40944	KARMA M.PART	1
515400100	FUSE HOLDER CNT47-0003A(TR)	KLM-2214 KARMA	2
525001400	FERRITE CORE F5 T 25X12X15	KARMA M.PART	1
540023500	POWER PLUG ECP01 05A	KARMA UK M.PAR	1
540023900	PCB SPACER MSPLS-6	KARMA M.PART	1
575018400	LED SPACER LH-5-4.5 L=4.5MM	KLM-2213/5/6 K	1
620024600	X-952 PSW KNOB KOC-E40304-2	KARMA M.PART	1
620026800	X-410 SVR KNOB (GRAY) E40239-3	KARMA M.PART	2
620031800	4 LINKAGE KNOB A-4-BK H40130-4	KARMA M.PART	1
620031900	4 LINKAGE A-3-BK E20180/H40130	KARMA M.PART	2
620032000	4-LINKAGE KNOB A-2-BK	KARMA M.PART	5
620032100	4-LINKAGE KNOB A-1-BK	KARMA M.PART	6
620032400	4-LINKAGE KNOB B-1-BK	KARMA M.PART	6
620033800	4 LINKAGE KNOB B-4-BK H40131-4	KARMA M.PART	3
620034000	4 LINKAGE KNOB B-3-BK H40131-3	KARMA M.PART	5
620036000	X-610 ENCODER KNOB(BLK)E40466-	KARMA M.PART	1
620037900	X-8110 KNOB L H40148-4	KARMA M.PART	1
620040700	X-9100 VR KNOB KOC-E40519-1	KARMA M.PART	13
630032100	X-9200 LED FILTER KOC-E40507	KARMA M.PART	1
630033000	X-9100 PANEL SHEET F30084-1	KARMA M.PART	1
630033100	X-9100 LCD WINDOW KOC-E40513-1	KARMA M.PART	1
630033500	X-9100 SHIELD SHEET KOC-F40940	KARMA M.PART	1
641041436	GND METAL FITTING M1866-A	KLM-2214 KARMA	2
641041436	GND METAL FITTING M1866-A	KLM-1935 KARMA	1
641041534	X-7100/7110 LCD ANGLE C41145	KARMA M.PART	1
641041608	X-9100 PANEL KOC-C10216-1	KARMA M.PART	1
641041609	GND METAL FITTING M1698A	KLM-2214 KARMA	2
641041623	X-9100 JACK PLATE 2 C41068-2	KLM-2211 KARMA	3
641041624	X-9100 SIDE CHASSIS KOC-C30549	KARMA M.PART	1
641041625	X-9100 OP COVER KOC-C30550	KARMA M.PART	1
641041626	X-9100 PCB CHASSIS KOC-C10220	KARMA M.PART	1
641041627	X-9100 CHASSIS L KOC-C10219	KARMA M.PART	1
641041628	X-9100 SUPPORT ANGLE C30551	KARMA M.PART	1
641041629	X-9100 BOTTOM COVER C10218-1	KARMA M.PART	1
641041630	X-9100 PLATE KOC-C41204	KARMA M.PART	1
644006200	X-011/012 WHEEL SPRING C40848	KARMA M.PART	2
644009000	X-8510 GND SPRING(K) KOC-C4116	KARMA M.PART	2
646038900	X-011/012 JS FRAME KOC-E30145	KARMA M.PART	1
646039000	X-011/012 VR PLATE KOC-E40309	KARMA M.PART	1
646039100	X-011/012 WHEEL SUPPORT E40308	KARMA M.PART	1
646039200	X-011/012 JS LEVER KOC-F40523	KARMA M.PART	1
646039300	X-011/012 JS WHEEL KOC-E30148	KARMA M.PART	1
646040000	X-011/012 JS COVER KOC-E20134	KARMA M.PART	1
646065400	X-610/620 SVR FRAME ASSY 30	KARMA M.PART	2
646066600	X-610 ENCODER FLAME KOC-E40467	KARMA M.PART	1
646074500	X-9100 LCD FRAME KOC-E30257	KARMA M.PART	1

PART CODE	PART NAME	NOTE	QTY
646075500	X-9100 SIDE PLATE L ASSY	KARMA M.PART	1
646075600	X-9100 SIDE PLATE R E10179-1	KARMA M.PART	1
646075700	X-9100 SIM COVER KOC-E20207-1	KARMA M.PART	1
646075800	X-9100 FDD COVER KOC-E20206-1	KARMA M.PART	1
646075900	X-9100 SLIDE HOOK 1 KOC-E40514	KARMA M.PART	1
646076000	X-9100 SLIDE HOOK 2 KOC-E40515	KARMA M.PART	1