

REVISIONS			
REV	DESCRIPTION	DRAFTER CHECKER	Q.C. AUTH.
1	CHANGE TITLE PER DCR 951002-01	CW 10/3/95	RWH 10/3/95
2	CHANGE R53 (SHT 1) AND R22 (SHT3) PER ECO 960830-00	RWH 9/10/96 KE 9/30/96	DHS 10/3/96 DHS 9/30/96

- NOTES**
- UNLESS OTHERWISE INDICATED, RESISTORS ARE 1/10W
 - UNLESS OTHERWISE INDICATED, RESISTORS ARE 5%
 - UNLESS OTHERWISE INDICATED, CAPACITORS ARE UFM
 - DIGITAL GROUND ANALOG GROUND CHASSIS GROUND POWER GROUND
 - [XXXX] DENOTES [SHEET NUMBER/SECTOR]
 - LAST REFERENCE DESIGNATORS USED: C64, J1, R95, U51, Y1.

DOCUMENT CONTROL BLOCK: #060-10398	
SHEET NUMBER	REVISION NUMBER
1 OF 6	2
2 OF 6	1
3 OF 6	2
4 OF 6	1
5 OF 6	1
6 OF 6	1

CONTRACT NO.		lexicon		3 OAK PARK BEDFORD, MA 01730	
APPROVALS	DATE	TITLE			
DRAWN RWH	11/1/94	SCHEM. DSP BD. PCM-90			
CHECKED KE	11/1/94	SIZE B	CODE	NUMBER	REV
Q.C. DHS	11/1/94			060-10398	2
ISSUED JW	11/1/94	FILE NAME	10398-2.1 SHEET 1 OF 6		

4.21.10398.14.95

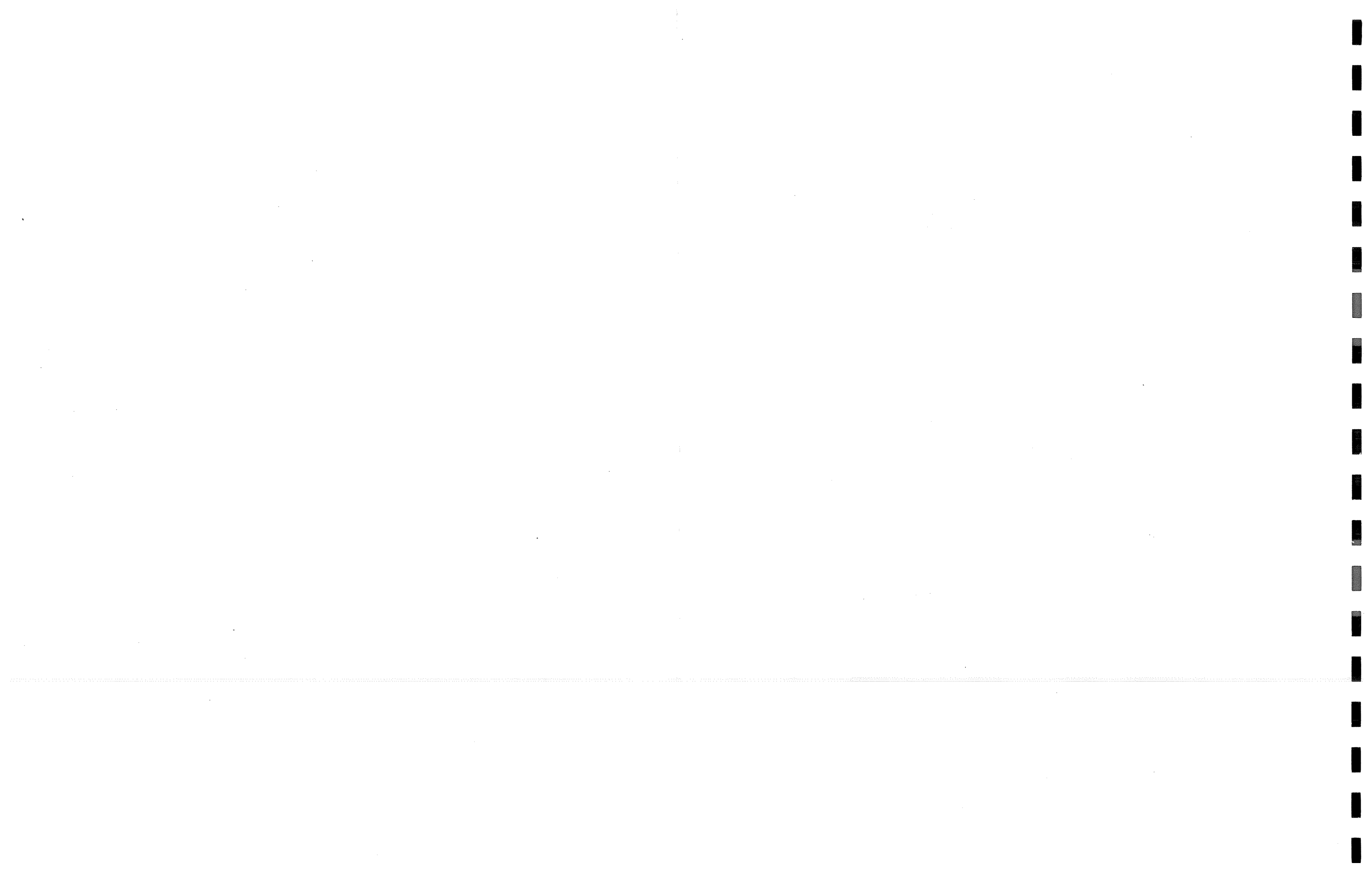

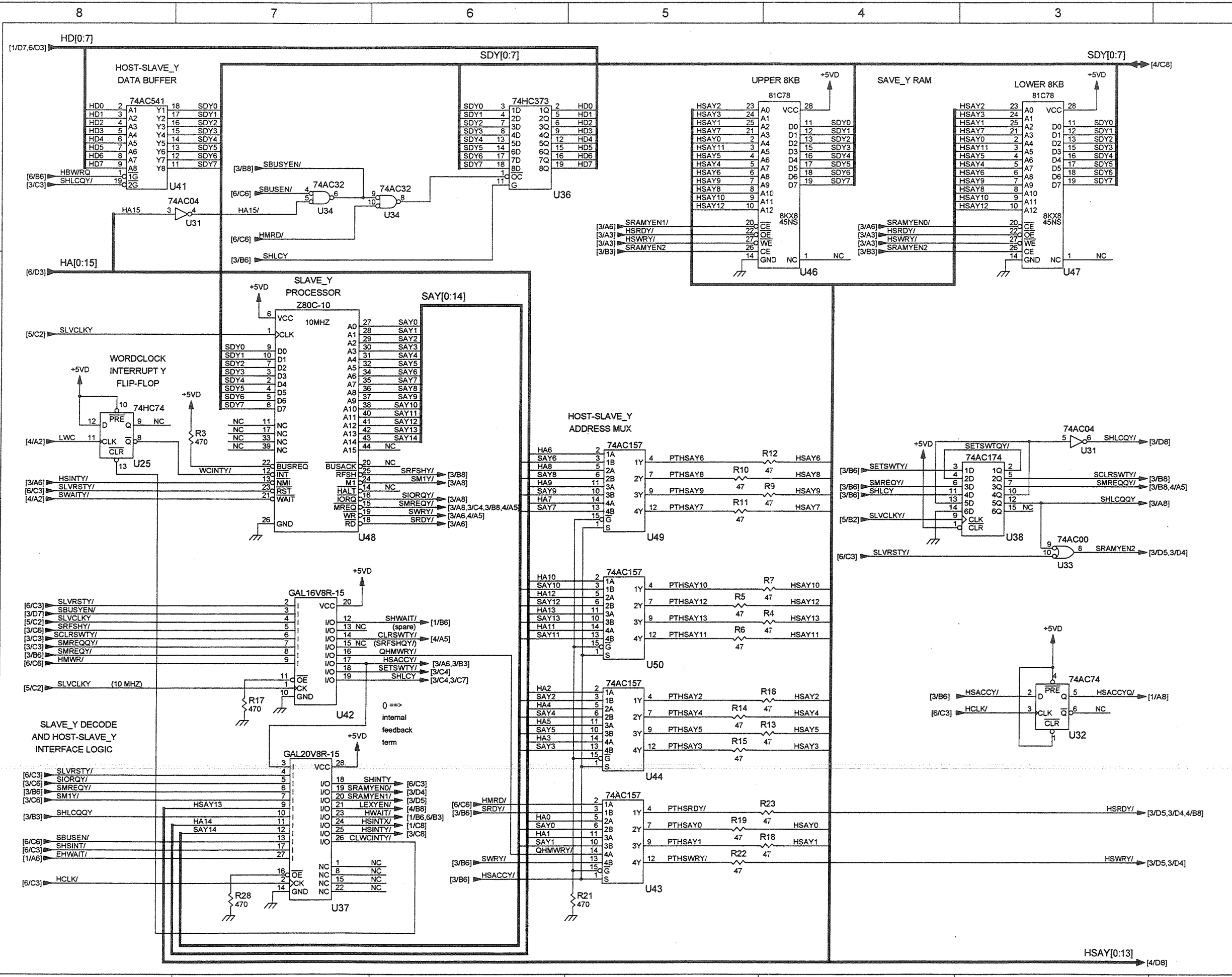

REVISIONS			
REV	DESCRIPTION	DRAFTER CHECKER	Q.C. AUTH.
1	CHANGE TITLE PER DCR 951002-01	CW 10/3/95	RWH 10/3/95
2	CHANGE R22 (PER ECO 960830-00)	RWH 9/10/96	CW 9/30/96
		KE 9/30/96	DHS 9/30/96

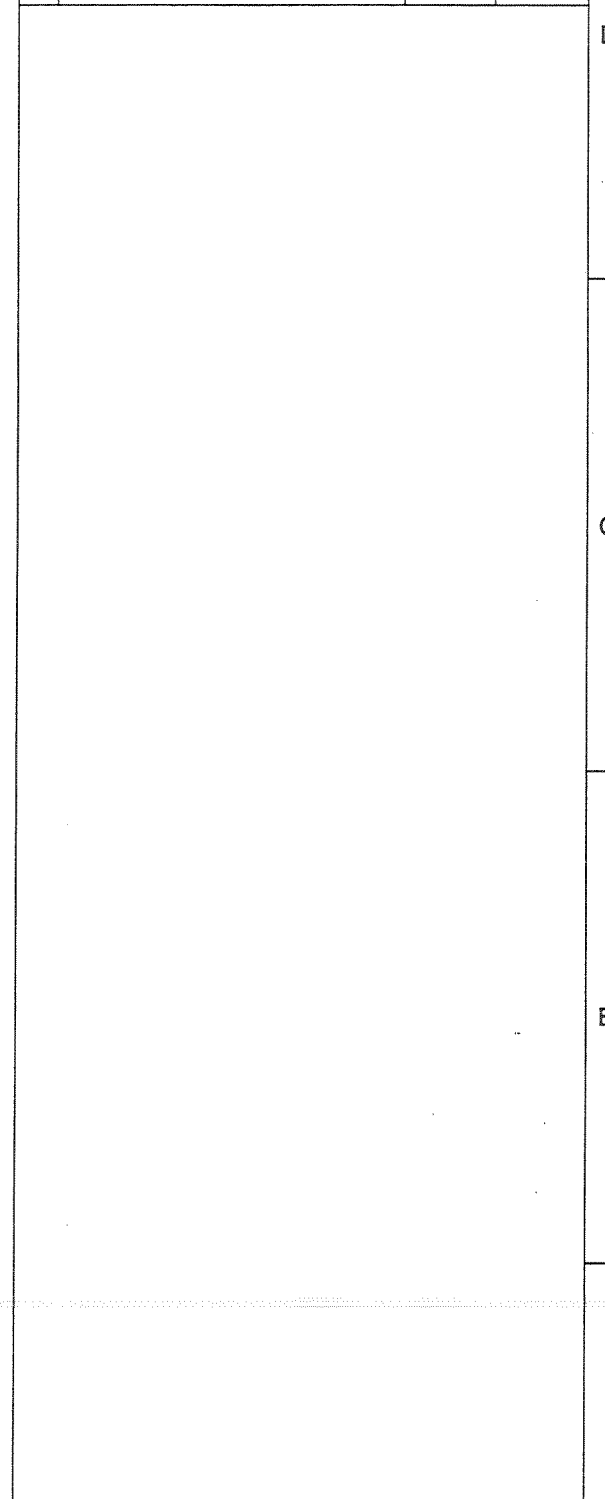

CONTRACT NO.	lexicon	3 OAK PARK BEDFORD, MA 01730
APPROVALS	DATE	TITLE
DRAWN RWH	11/1/94	SCHEM, DSP BD, PCM-90
CHECKED KE	11/1/94	SLAVE Y INTERFACE
Q.C. DHS	11/1/94	SIZE B CODE NUMBER REV
ISSUED JW	11/1/94	FILE NAME 10398-2.3 SHEET 3 OF 6

4-23-1997_14:45

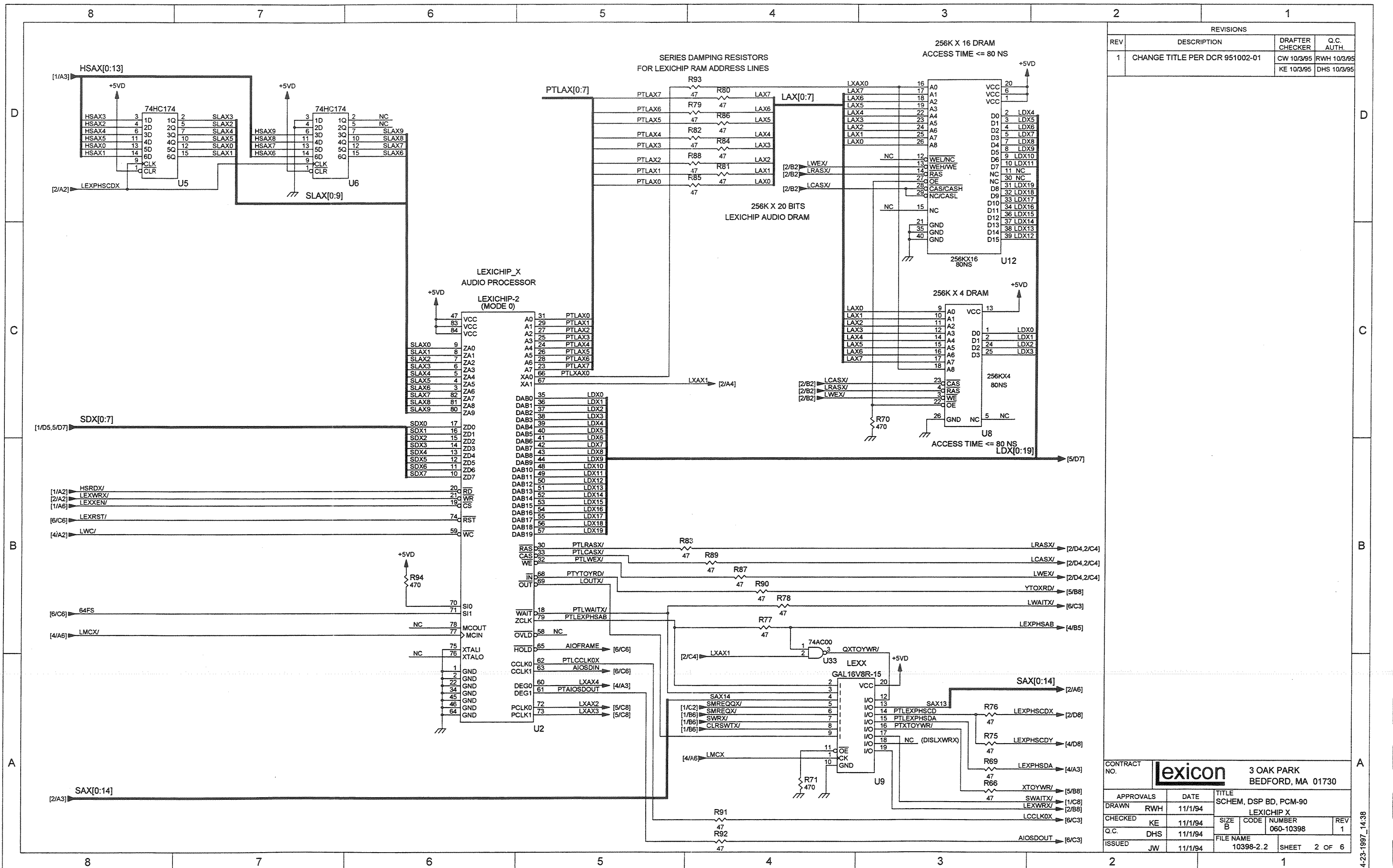

REVISIONS			
REV	DESCRIPTION	DRAFTER CHECKER	Q.C. AUTH.
1	CHANGE TITLE PER DCR 951002-01	CW 10/3/95 KE 10/3/95	RWH 10/3/95 DHS 10/3/95

CONTRACT NO.		lexicon 3 OAK PARK BEDFORD, MA 01730	
APPROVALS	DATE	TITLE	
DRAWN RWH	11/1/94	SCHEM, DSP BD, PCM-90	
CHECKED KE	11/1/94	SIZE B	CODE NUMBER
Q.C. DHS	11/1/94	FILE NAME	REV 1
ISSUED JW	11/1/94	10398-2.2	SHEET 2 OF 6

4-23-1997_14:38

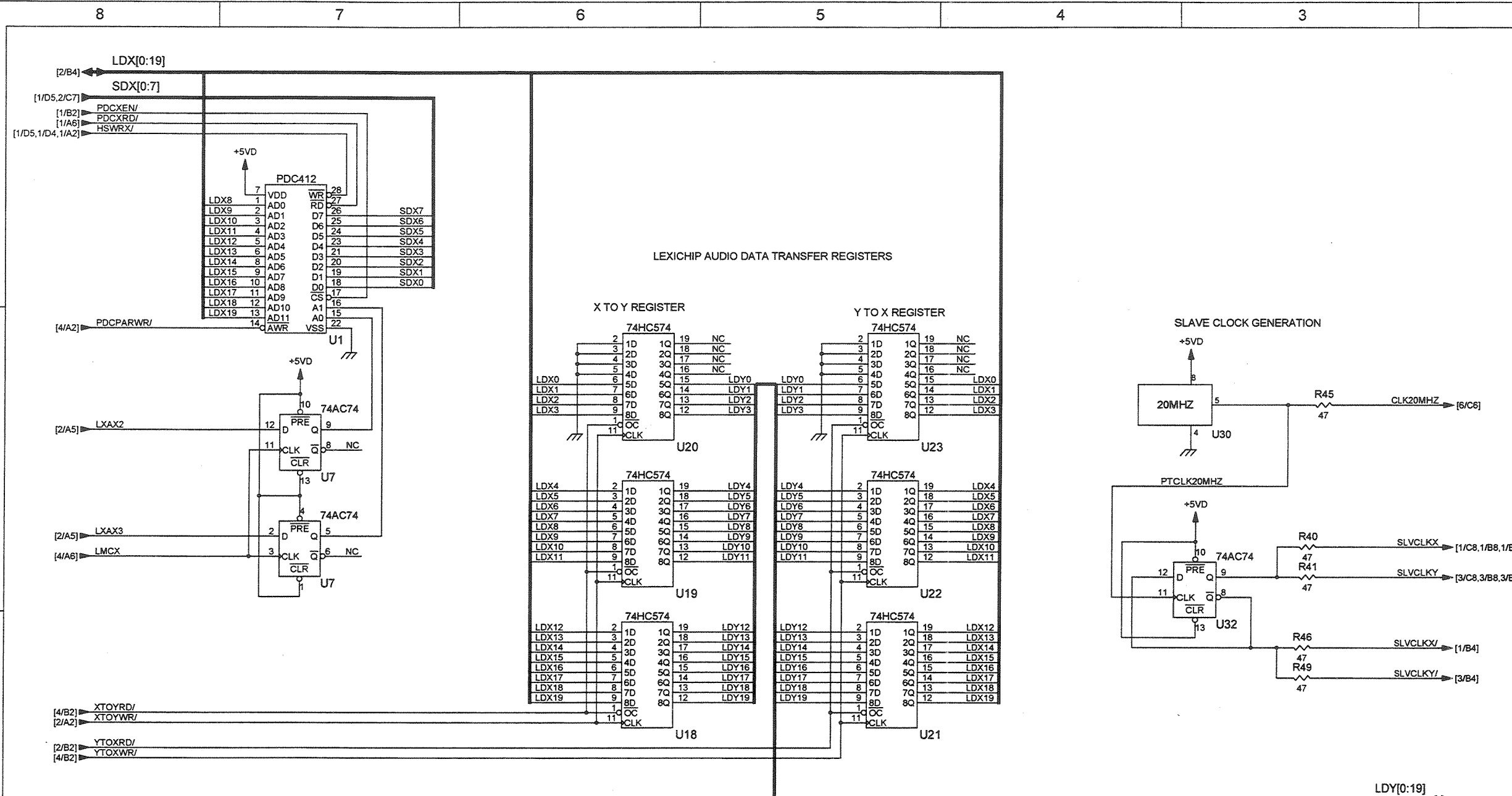

REVISIONS			
REV	DESCRIPTION	DRAFTER CHECKER	Q.C. AUTH.
1	CHANGE TITLE PER DCR 951002-01	CW 10/3/95 KE 10/3/95	RWH 10/3/95 DHS 10/3/95

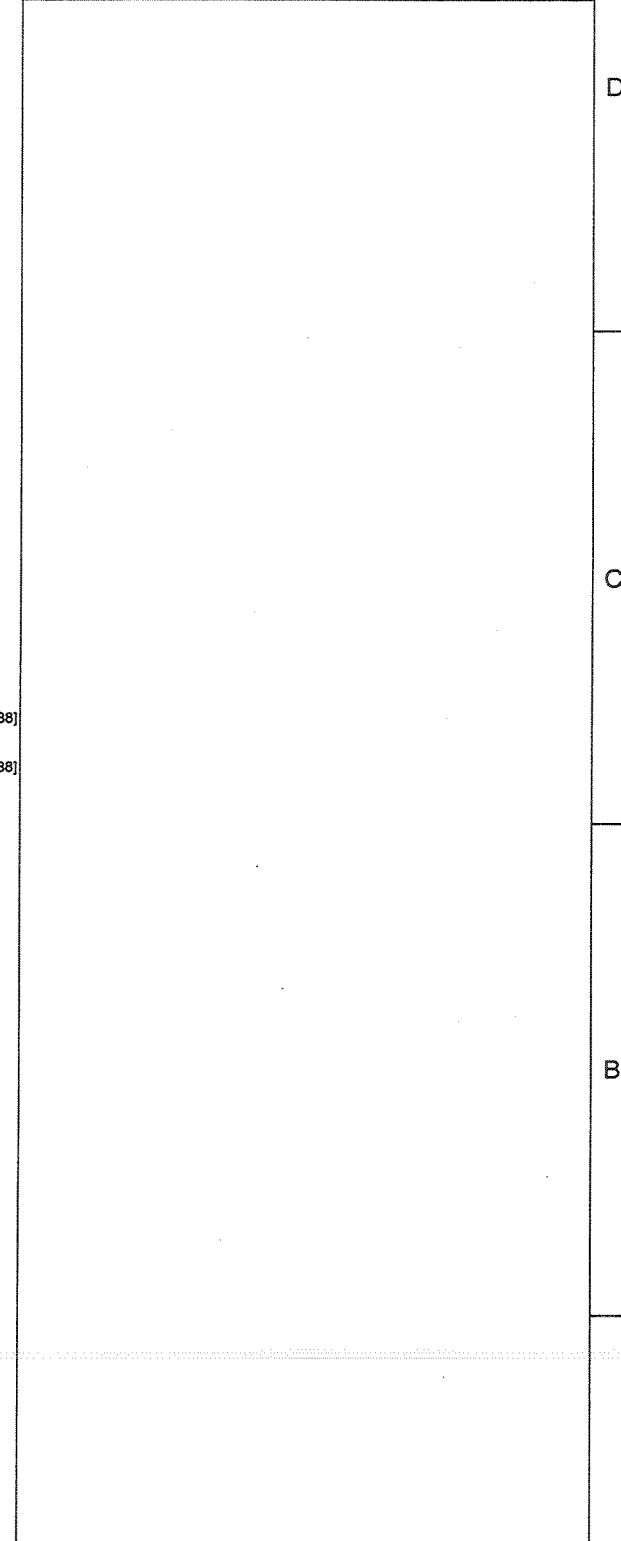

CONTRACT NO.		lexicon		3 OAK PARK BEDFORD, MA 01730	
APPROVALS	DATE	TITLE			
DRAWN RWH	11/1/94	SCHEM, DSP BD, PCM-90			
CHECKED KE	11/1/94	PEAK-DETECT. XFER REGS			
Q.C. DHS	11/1/94	SIZE B	CODE	NUMBER	REV
ISSUED JW	11/1/94	FILE NAME	10398-2.5	SHEET	5 OF 6

4-23-1997_15:35

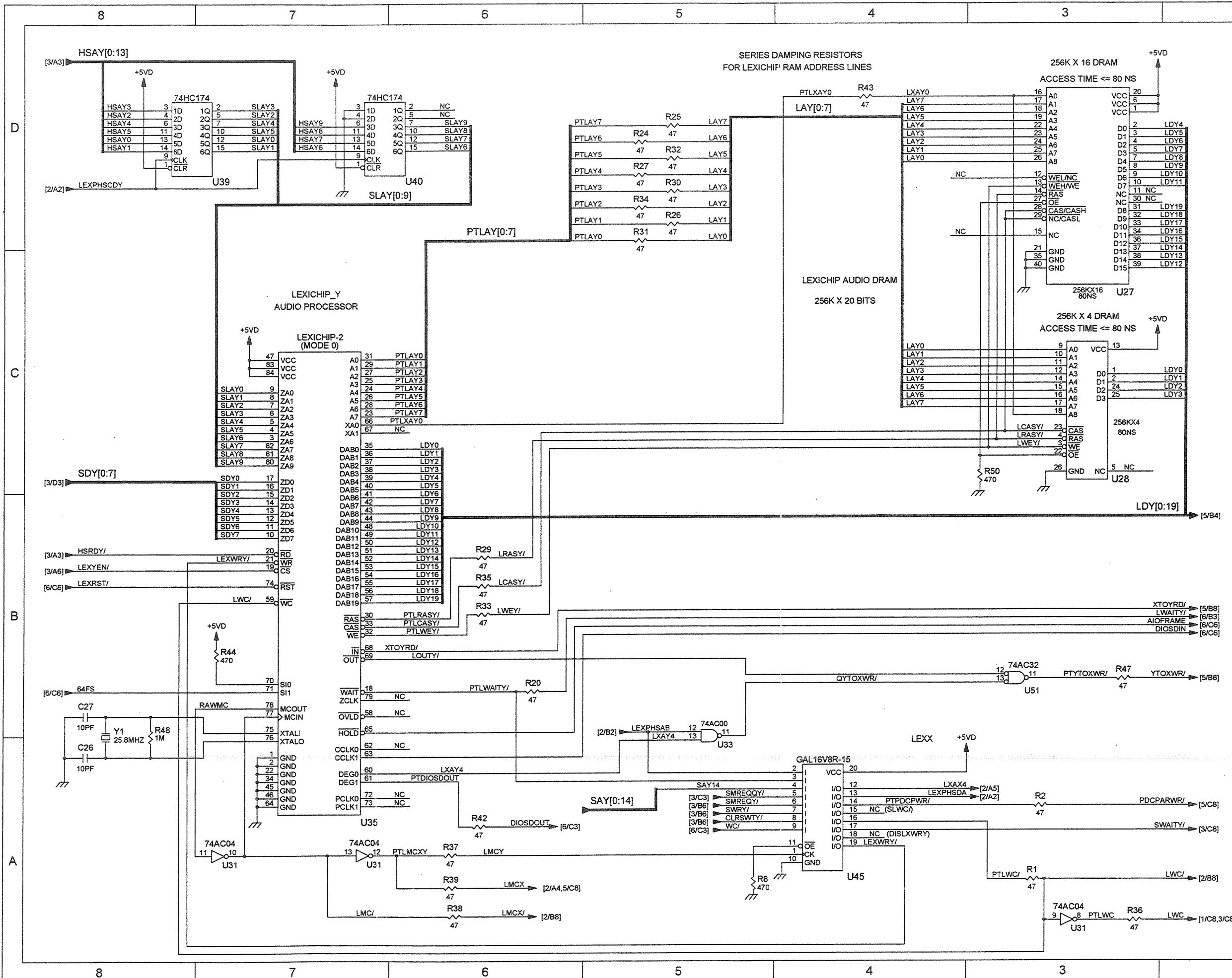

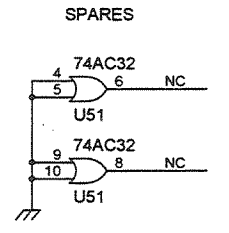

REVISIONS			
REV	DESCRIPTION	DRAFTER	Q.C. AUTH.
1	CHANGE TITLE PER DCR 951002-01	CW 10/3/95	RWH 10/3/95
		KE 10/3/95	DHS 10/3/95

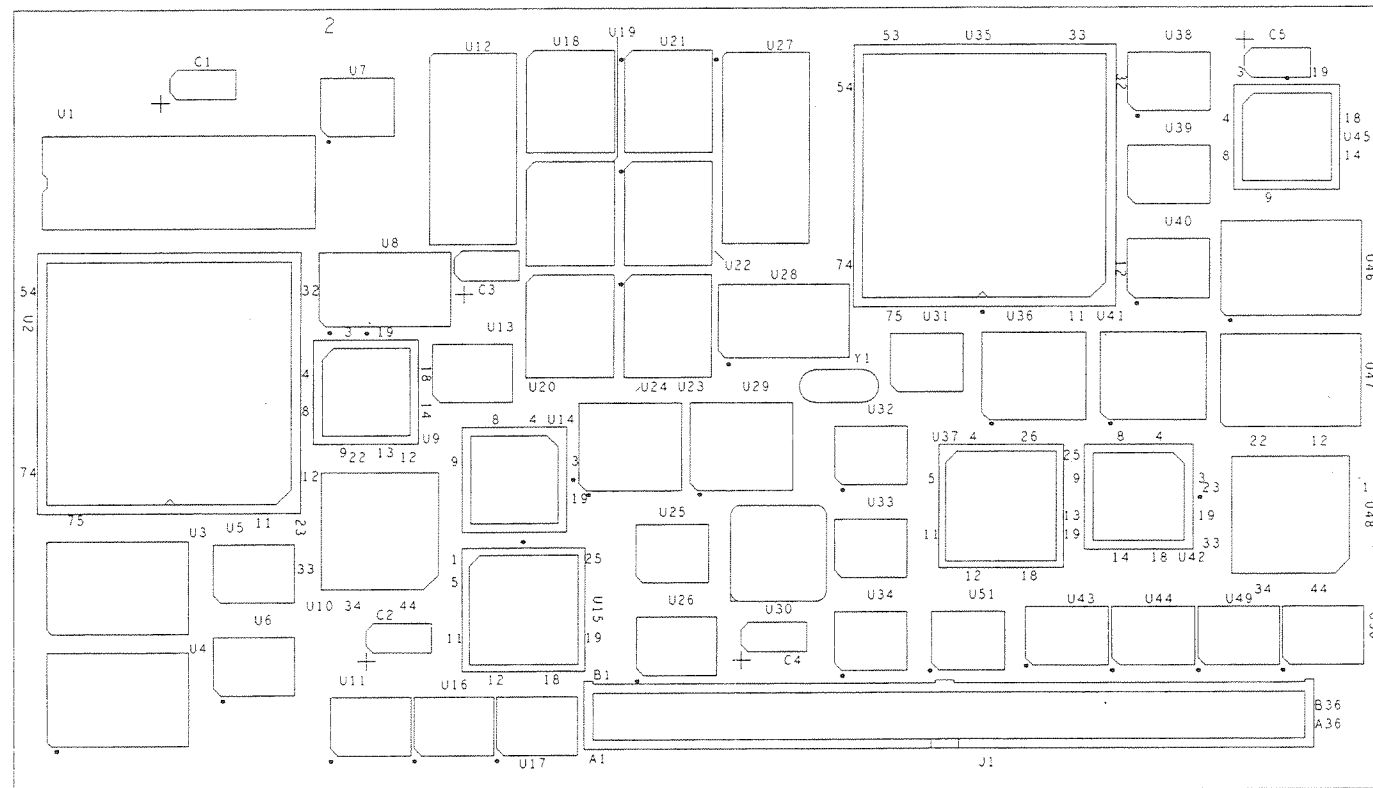

CONTRACT NO.		lexicon 3 OAK PARK BEDFORD, MA 01730	
APPROVALS	DATE	TITLE	
DRAWN RWH	11/1/94	SCHEM, DSP BD, PCM-90	
CHECKED KE	11/1/94	SIZE B	CODE NUMBER
Q.C. DHS	11/1/94	8	060-10398
ISSUED JW	11/1/94	FILE NAME	SHEET 4 OF 6
		10398-2.4	

4-23-1997_14:49



	
PC BD, DSP, PCM-91	REV
COMPONENT LAYOUT	3
SCALE N/A	SHEET 1 OF 2

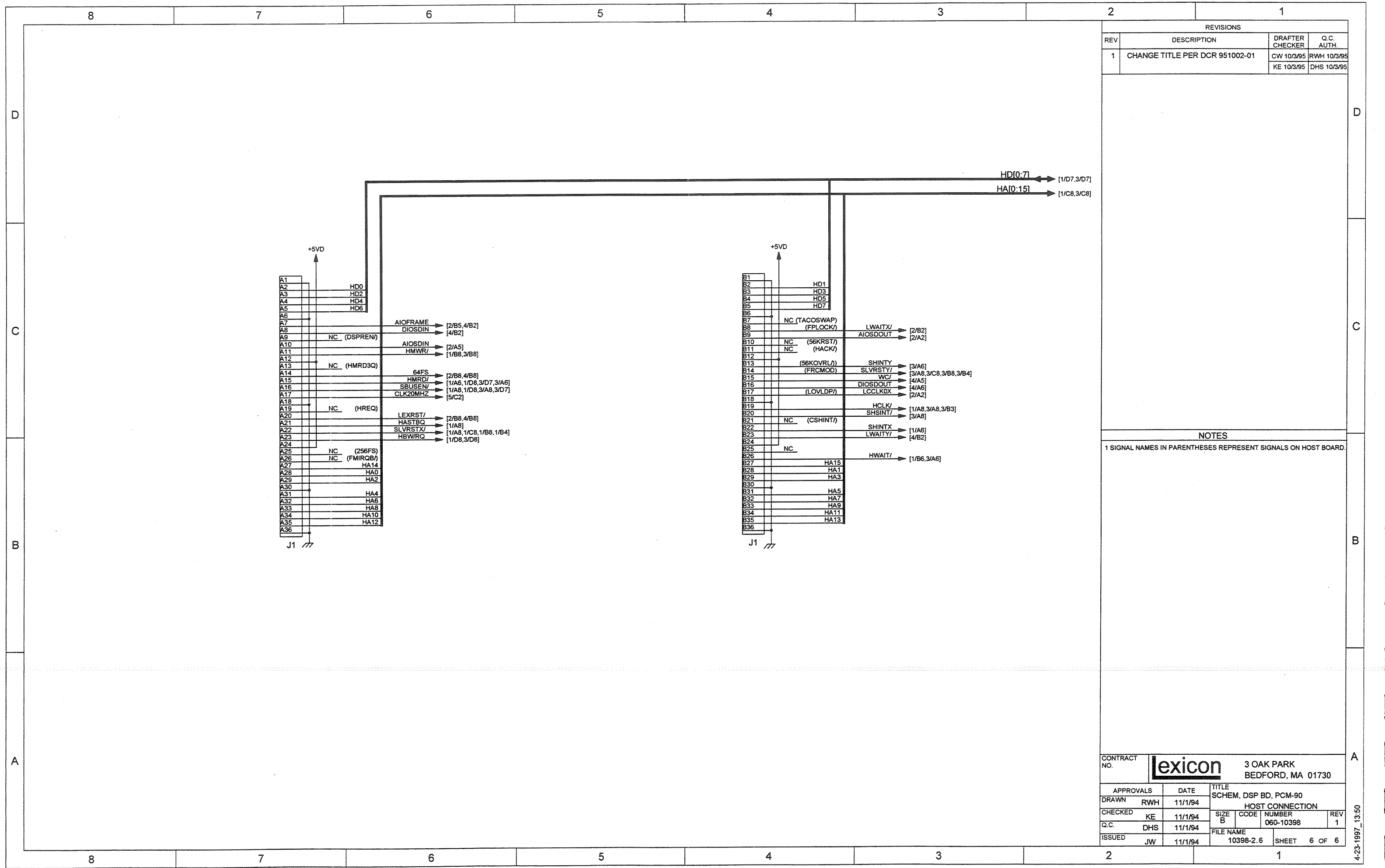

REVISIONS			
REV	DESCRIPTION	DRAFTER CHECKER	Q.C. AUTH.
1	CHANGE TITLE PER DCR 951002-01	CW 10/3/95 KE 10/3/95	RWH 10/3/95 DHS 10/3/95

NOTES
1 SIGNAL NAMES IN PARENTHESES REPRESENT SIGNALS ON HOST BOARD.

CONTRACT NO.		lexicon		3 OAK PARK BEDFORD, MA 01730	
APPROVALS	DATE	TITLE			
DRAWN RWH	11/1/94	SCHEM, DSP BD, PCM-90			
CHECKED KE	11/1/94	HOST CONNECTION			
Q.C. DHS	11/1/94	SIZE B	CODE	NUMBER 060-10398	REV 1
ISSUED JW	11/1/94	FILE NAME		10398-2.6 SHEET 6 OF 6	

4-23-1997_13:50

8 7 6 5 4 3 2 1

D
C
B
A

D
C
B
A

REVISIONS			
REV	DESCRIPTION	DRAFTER CHECKER	Q.C. AUTH.

NOTES

1 // DIGITAL GROUND ∇ ANALOG GROUND ⊕ CHASSIS GROUND ⊥ POWER GROUND

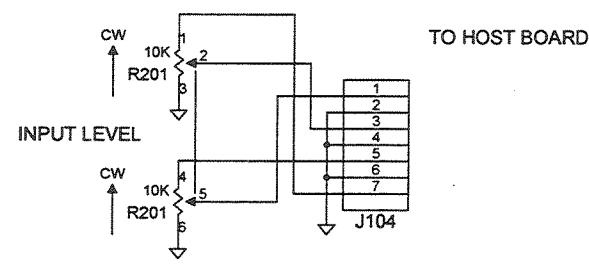

CONTRACT NO.	lexicon	3 OAK PARK BEDFORD, MA 01730	
APPROVALS	DATE	TITLE	
DRAWN RWH	5/20/97	SCHEM, POT BD, M80&1/90&1	
CHECKED DHS	8/14/97	SIZE B	CODE NUMBER 060-12699
Q.C. CW	8/15/97	FILE NAME	REV 0
ISSUED DHS	8/15/97	12699-0.1	SHEET 1 OF 1

8 7 6 5 4 3 2 1

8-15-1997_16:31

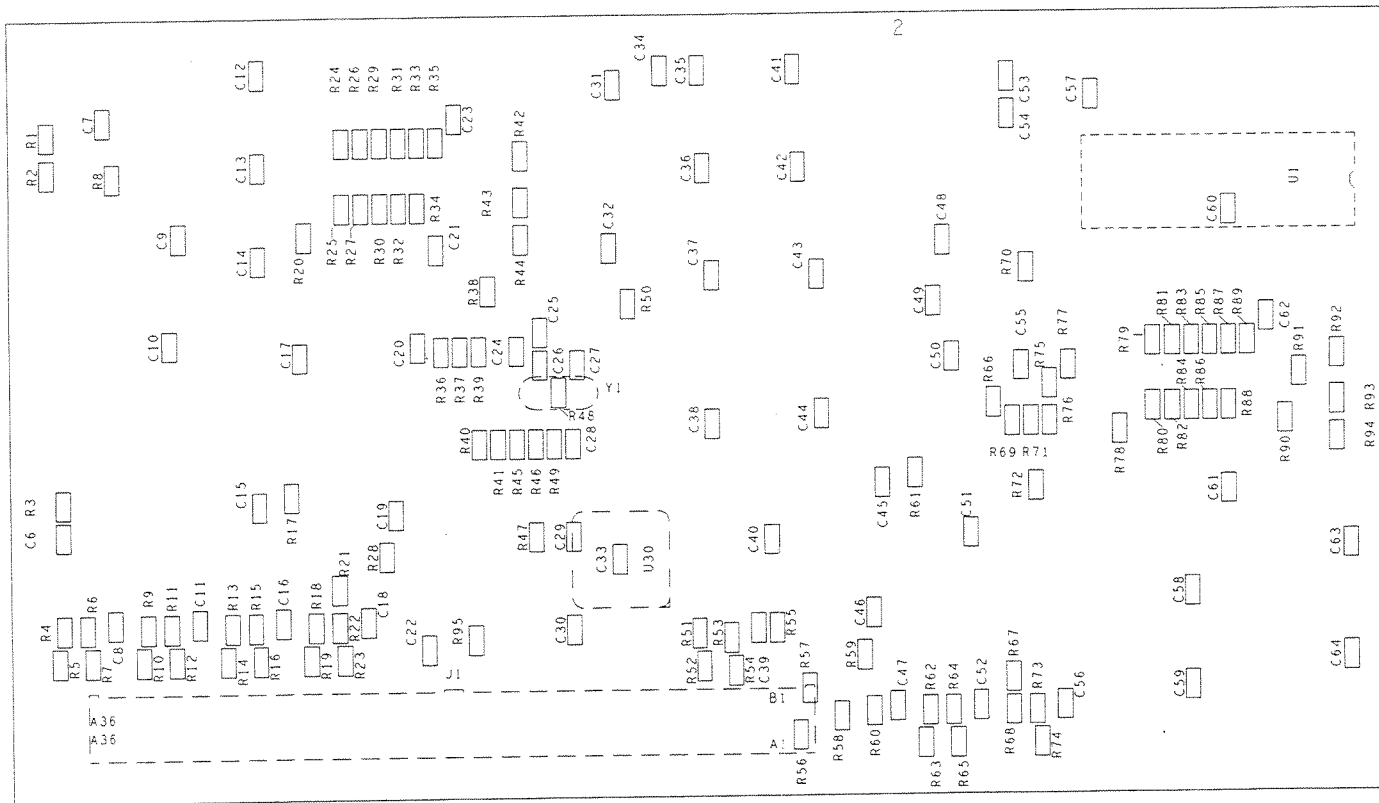

	
PC BD, DSP, PCM-91 COMPONENT LAYOUT	REV 3
SCALE N/A	SHEET 2 OF 2

8 7 6 5 4 3 2 1

D
C
B
A

REVISIONS			
REV	DESCRIPTION	DRAFTER CHECKER	Q.C. AUTH.

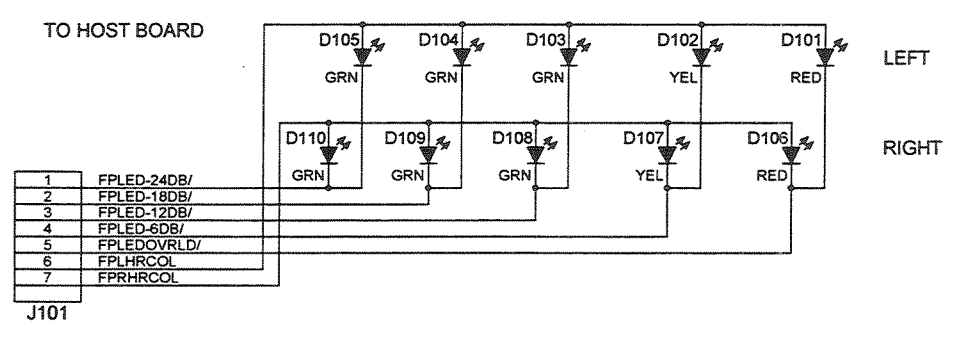



NOTES			
1	DIGITAL GROUND	ANALOG GROUND	CHASSIS GROUND
			POWER GROUND

CONTRACT NO.		lexicon		3 OAK PARK BEDFORD, MA 01730	
APPROVALS	DATE	TITLE			
DRAWN	RWH 5/20/97	SCHEM, HDRM BD, M80&1/90&1			
CHECKED	DHS 8/14/97	SIZE	CODE	NUMBER	REV
Q.C.	CW 8/15/97	B		060-12691	0
ISSUED	DHS 8/15/97	FILE NAME		SHEET	
		12691-0.1		1 OF 1	

8 7 6 5 4 3 2 1

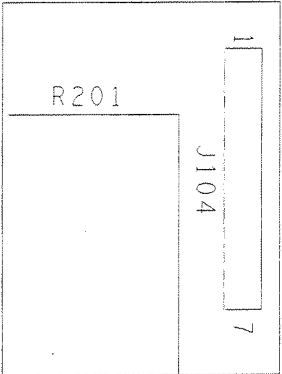
8-18-1997_10:00



 lexicon	
POT BD, PCM-81/91 COMPONENT LAYOUT	REV 3
SCALE N/A	SHEET 1 OF 1

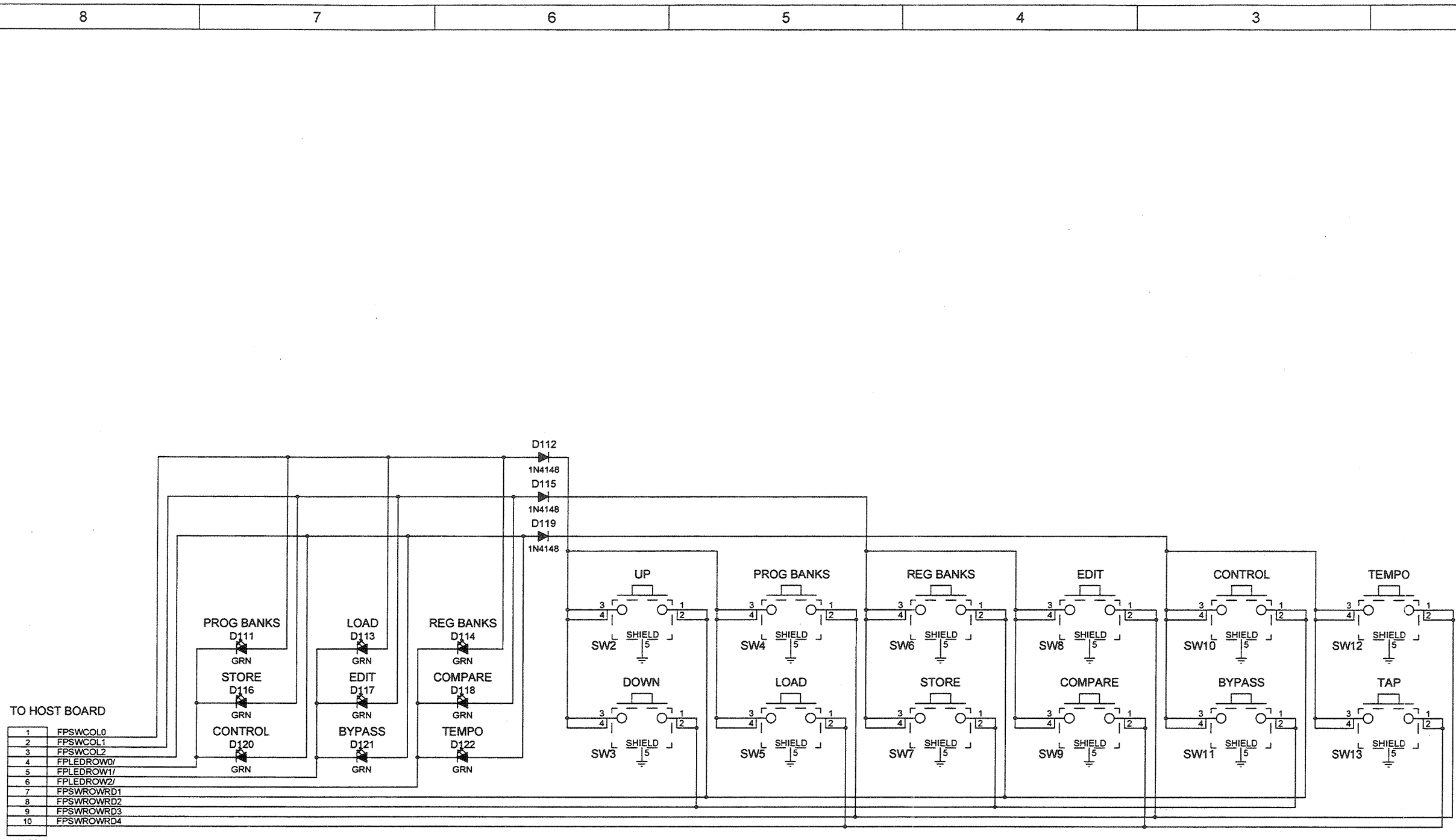

TO HOST BOARD

1	FPSWC0L0
2	FPSWC0L1
3	FPSWC0L2
4	FPLEDROW1
5	FPLEDROW2
6	FPSWROWRD1
7	FPSWROWRD2
8	FPSWROWRD3
9	FPSWROWRD4
10	FPSWROWRD4

REVISIONS			
REV	DESCRIPTION	DRAFTER CHECKER	Q.C. AUTH.

NOTES

1	DIGITAL GROUND	ANALOG GROUND	CHASSIS GROUND	POWER GROUND
---	----------------	---------------	----------------	--------------

CONTRACT NO.	lexicon	3 OAK PARK BEDFORD, MA 01730		
APPROVALS	DATE	TITLE		
DRAWN RWH	5/20/97	SCHEM, SW BD, M80&1/M90&1		
CHECKED DHS	8/14/97	SIZE B	CODE	NUMBER
Q.C. CW	8/15/97	060-12675		REV 0
ISSUED DHS	8/15/97	FILE NAME	SHEET 1 OF 1	
		12675-0.1		

8-16-1997 9:57

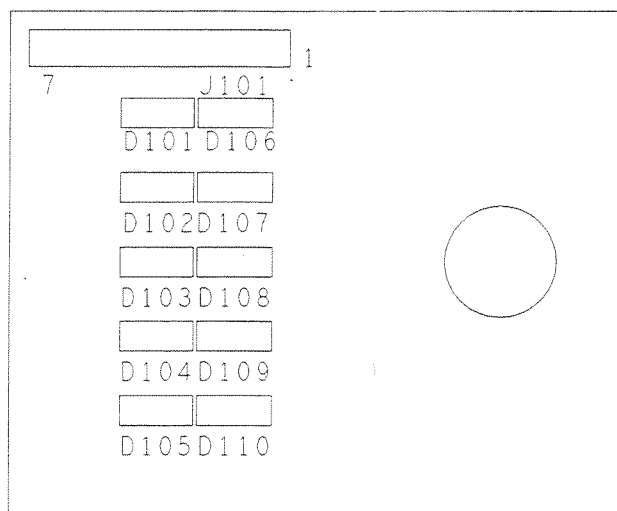

HDRM BD, PCM-81/91	REV
COMPONENT LAYOUT	5
SCALE N/A	SHEET 1 OF 1

8 7 6 5 4 3 2 1

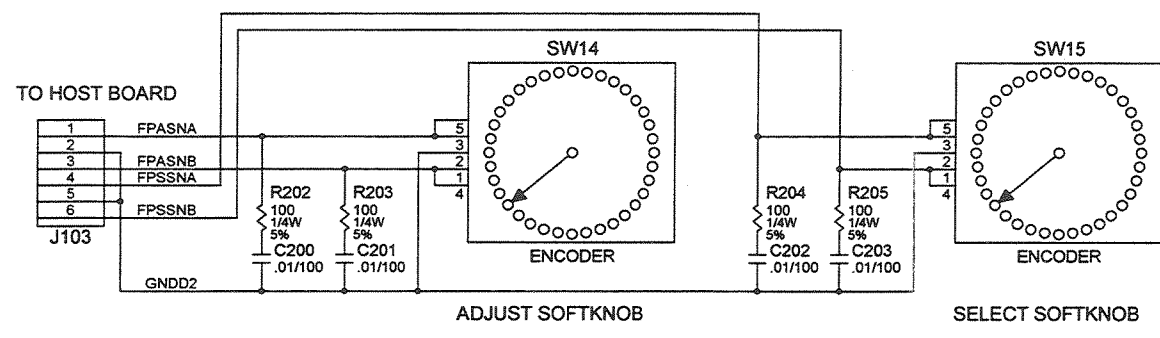

REVISIONS			
REV	DESCRIPTION	DRAFTER CHECKER	Q.C. AUTH.

NOTES

1 UNLESS OTHERWISE INDICATED, CAPACITORS ARE UFV

2 DIGITAL GROUND ANALOG GROUND CHASSIS GROUND POWER GROUND

CONTRACT NO.		lexicon		3 OAK PARK BEDFORD, MA 01730	
APPROVALS	DATE	TITLE			
DRAWN	RWH	5/20/97	SCHEM, ENC BD, M80&1/90&1		
CHECKED	DHS	7/24/97	SIZE	CODE	NUMBER
Q.C.	CW	8/15/97	B		060-12683
ISSUED	DHS	8/15/97	FILE NAME	REV	
			12683-0.1	SHEET	1 OF 1

8 7 6 5 4 3 2 1

8-18-1997_9.58

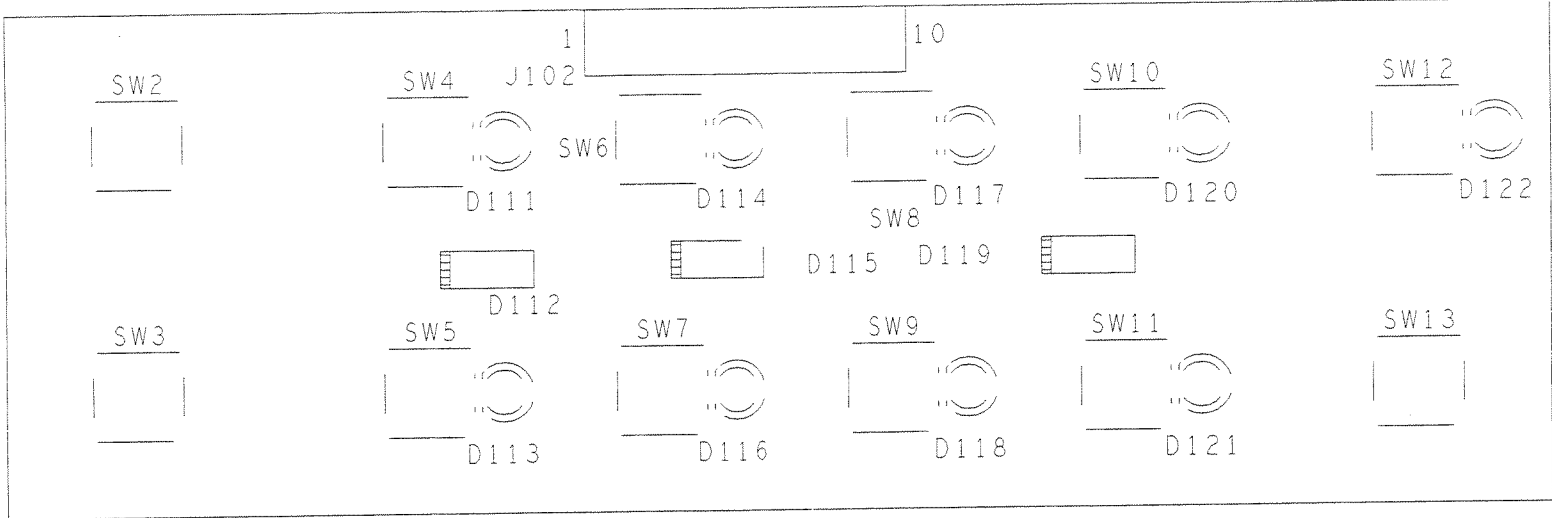

lexicon	
SWITCH BD, PCM-81/91 COMPONENT LAYOUT	REV 4
SCALE N/A	SHEET 1 OF 1