

REV	DESCRIPTION	REVISIONS	DRAWN	CHECKER	AUTH.

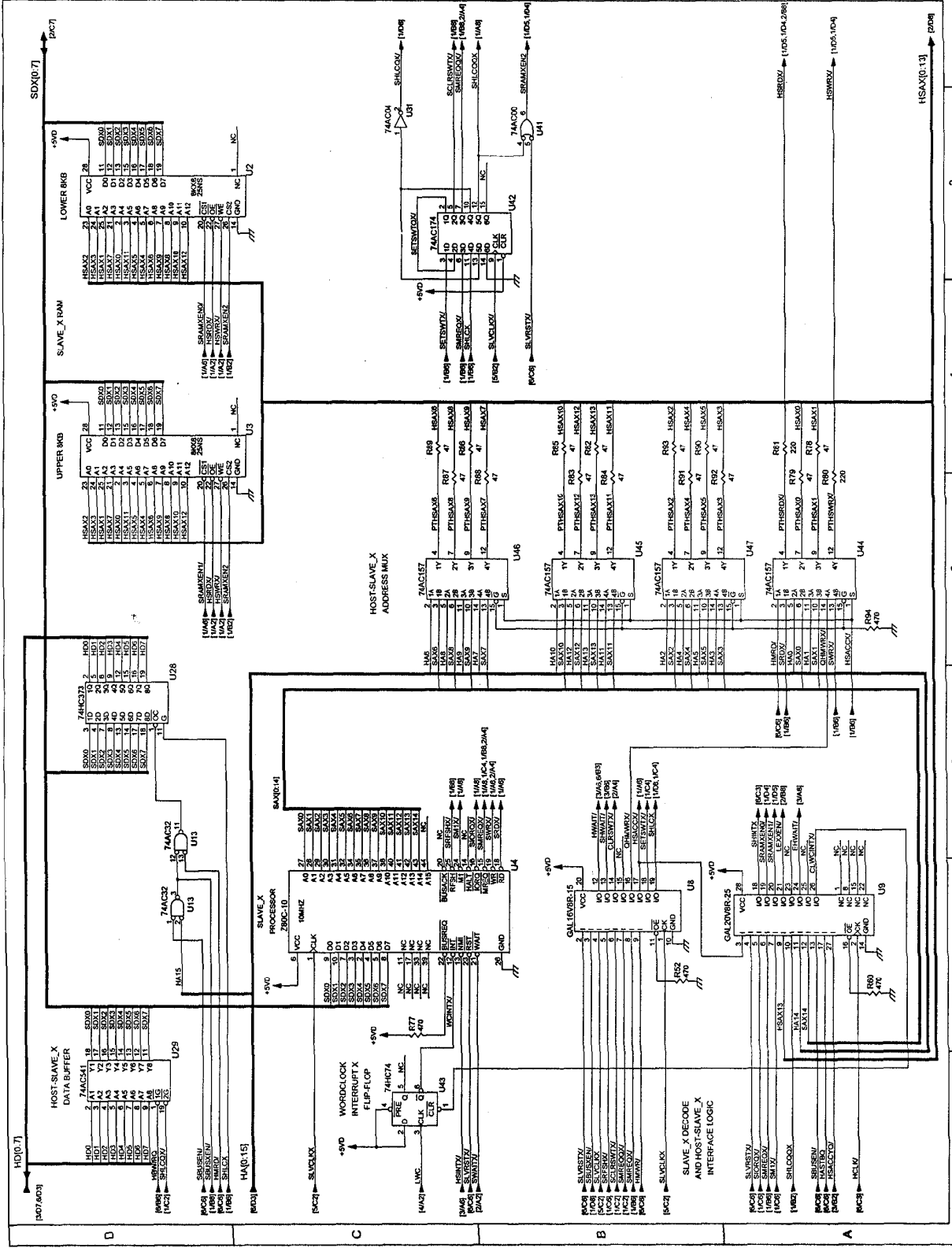

1 UNLESS OTHERWISE INDICATED, RESISTORS ARE 1/10W  
 2 UNLESS OTHERWISE INDICATED, CAPACITORS ARE 100P  
 3 UNLESS OTHERWISE INDICATED, CAPACITORS ARE 100N  
 4 DIGITAL GROUND → CHASSIS GROUND  
 5 ANALOG GROUND → CHASSIS GROUND  
 6 POWER GROUND → CHASSIS GROUND  
 7 5VDDQ0 DENOTES SHEET NUMBER(S)  
 8 LAST REFERENCE DESIGNATORS USED: C00, J1, R04, U08, V1

SHEET NUMBER	REVISION NUMBER
1 OF 8	0
2 OF 8	0
3 OF 8	0
4 OF 8	0
5 OF 8	0
6 OF 8	0
7 OF 8	0
8 OF 8	0

APPROVALS	DATE	TITLE
DRAWN RWH	5/1/87	SLAVE X INTERFACE
CHECKED JAT	7/15/87	SEE LOG NUMBER
ISSUED MAG	7/15/87	FILE NAME 06012027.0

DOCUMENT CONTROL BLOCK: 06012027

CONTRACT NO. 3 OAK PARK BEDFORD, MA 01730

ISSUED 7/15/87 12027.0.1 SHEET 1 OF 8

REV	DESCRIPTION	REVISIONS	DRAWN	CHECKER	AUTH

REV	DESCRIPTION	REVISIONS	DRAWN	CHECKER	AUTH

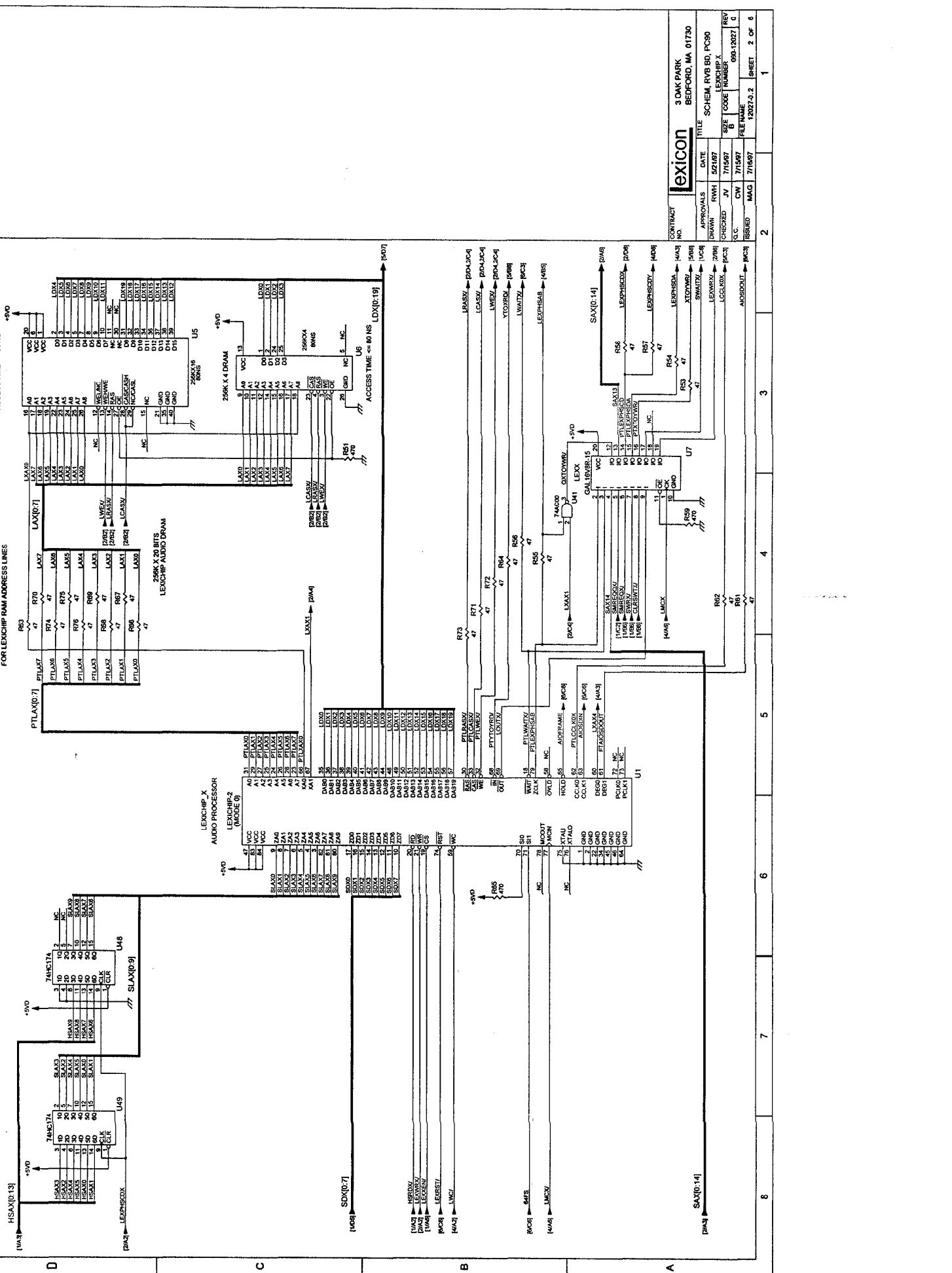

CONTRACT NO.	TITLE	DATE	ISSUED
3 OAK PARK	SCHEM, RV9 BD, PC90	7/15/97	7/16/97
BEDFORD, MA 01730			

APPROVALS	DATE	ISSUED

DESIGN	DATE	ISSUED

REV	DATE	ISSUED

REV	DATE	ISSUED

REV	DATE	ISSUED

REV	DATE	ISSUED

REV	DATE	ISSUED

REV	DESCRIPTION	DRAWER	C.C.
		CHECKER	AUTH

REV	DESCRIPTION	DRAWER	C.C.
		CHECKER	AUTH

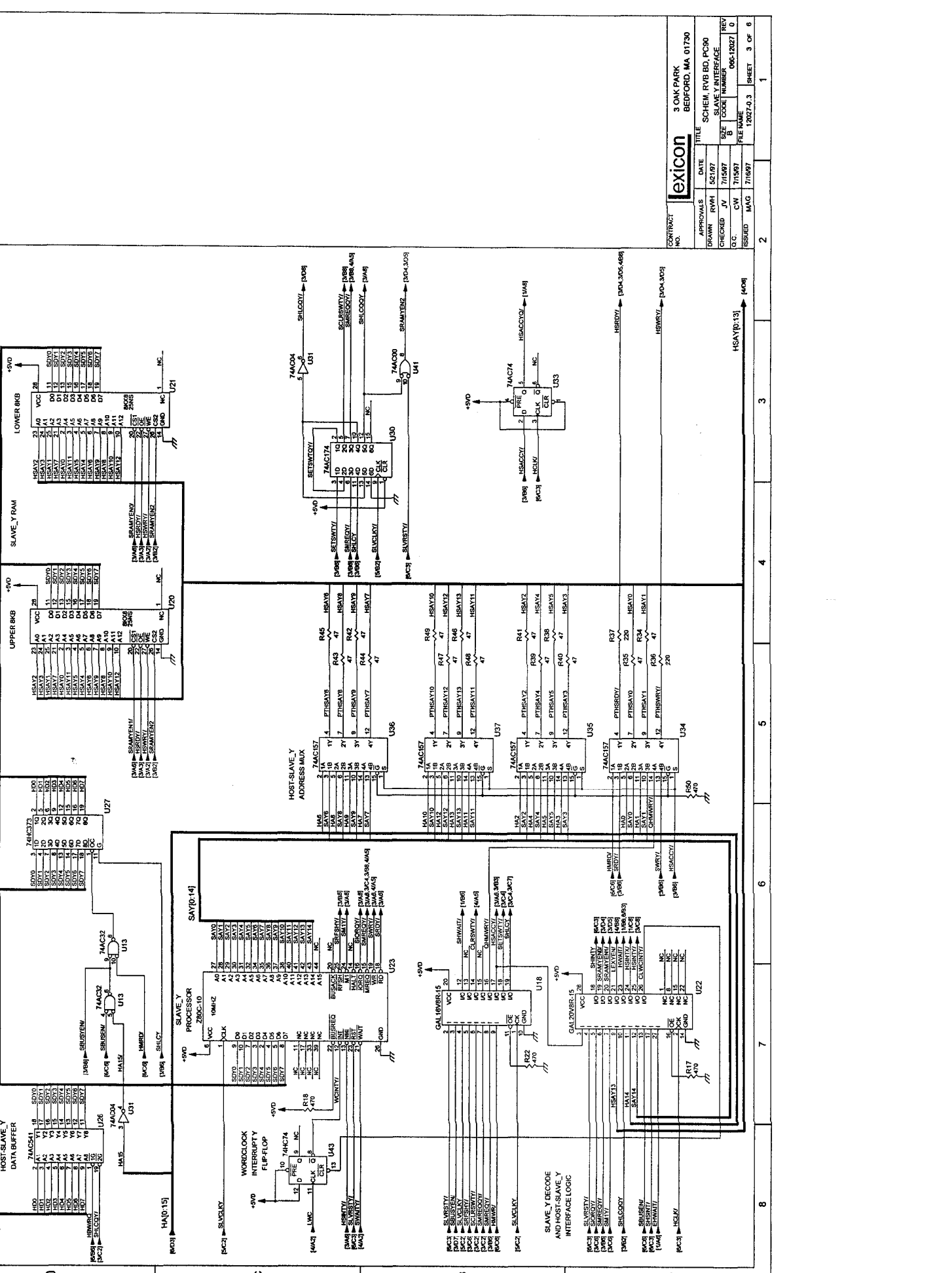

REV	DESCRIPTION	DRAWER	C.C.
		CHECKER	AUTH

REV	DESCRIPTION	DRAWER	C.C.
		CHECKER	AUTH

REV	DESCRIPTION	DRAWER	C.C.
		CHECKER	AUTH

REV	DESCRIPTION	DRAWER	C.C.
		CHECKER	AUTH

REV	DESCRIPTION	DRAWN	CHECKER	O.C. AUTH.

EXTRACT NO.	TITLE	DATE	SCHEM. RVB BD. PC90
APPROVALS	DATE	LEXICHIP Y	
DRAWN RMT 2/21/97			
CHECKED JV 7/15/97			
ISSUED MAG 7/16/97	120270.4	SHEET	4 OF 8

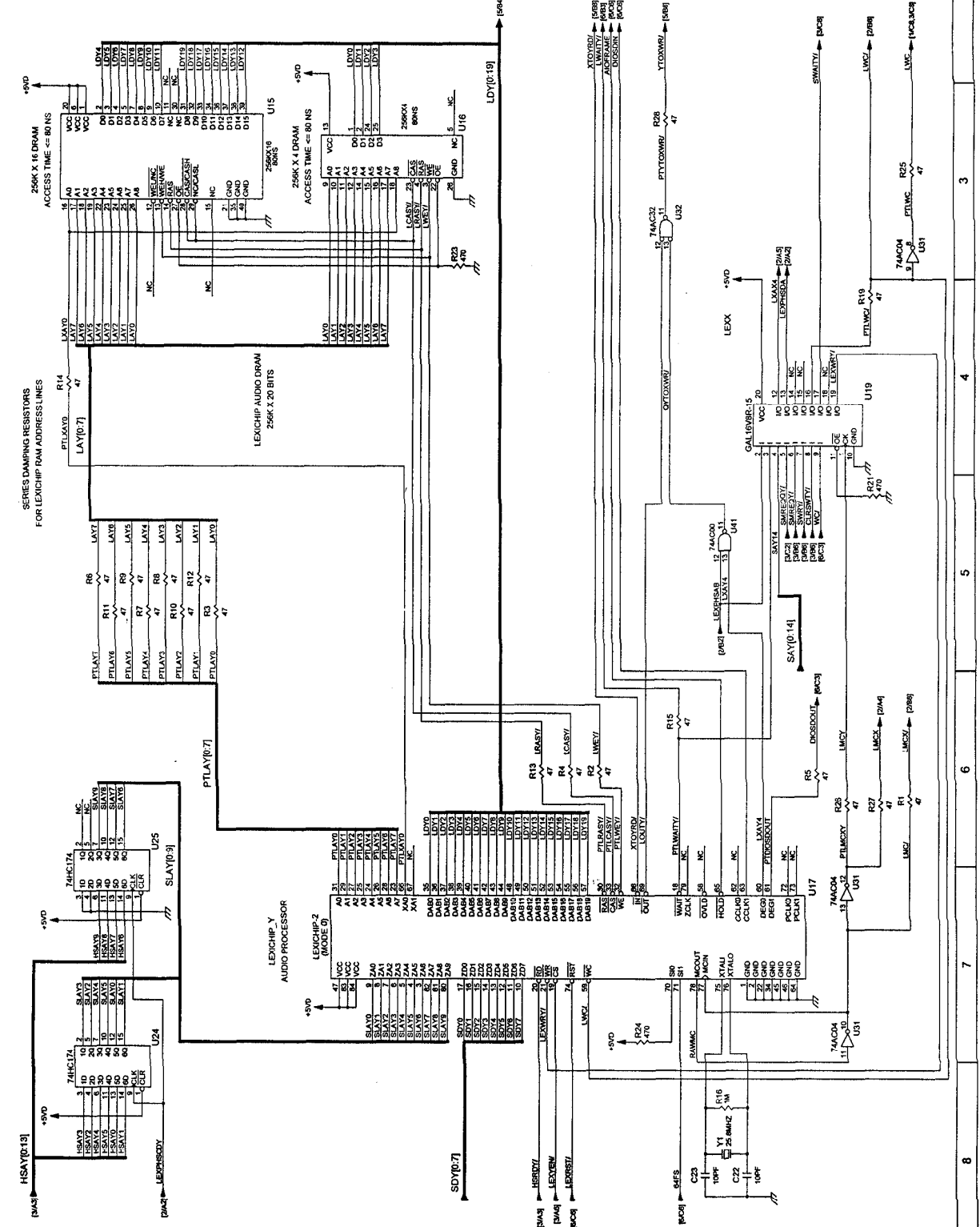

2  
3  
4  
5  
6  
7  
8

SPARES

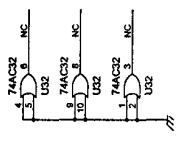

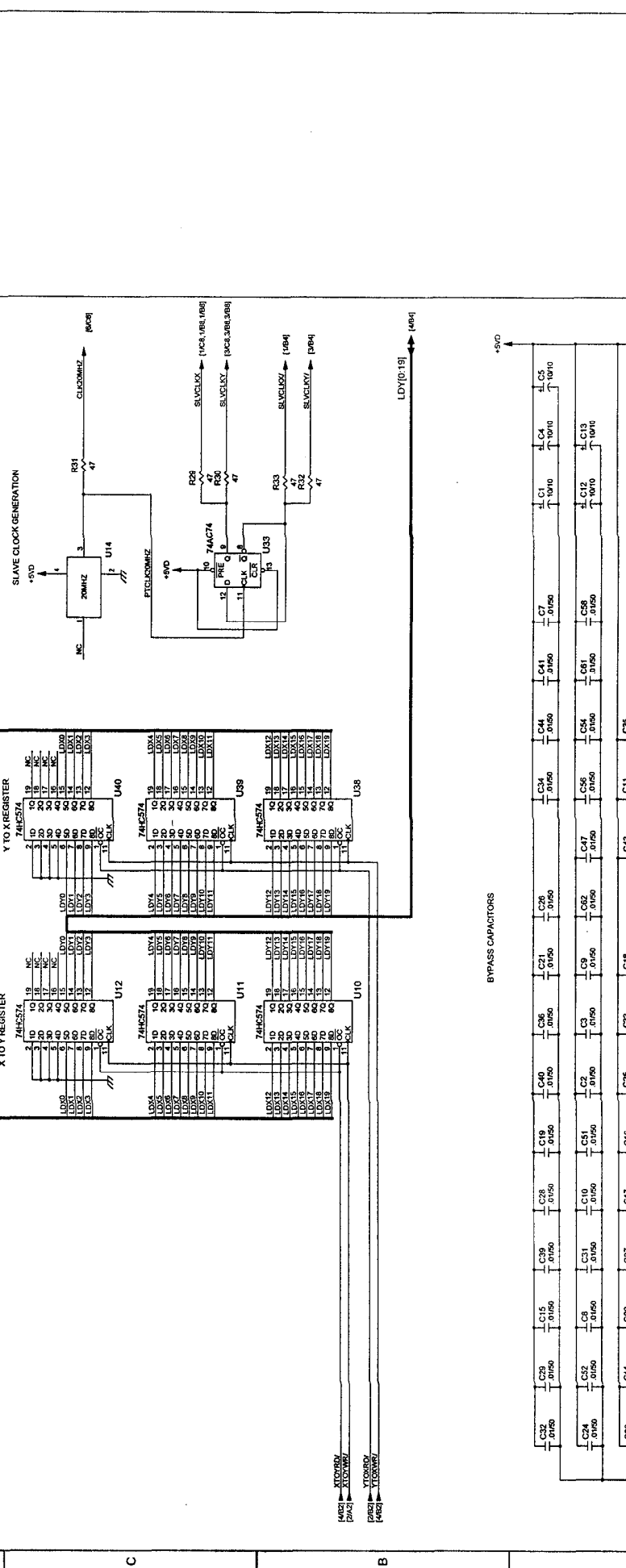

CONTRACT NO.		3 OAK PARK BEDFORD, MA 01730	
APPROVALS		DATE	
BY: JMW	RWH	5/2/97	TITLE
CHECKED: J.V.	CW	7/15/97	SCHEM. RYB BD. PC30
G.C.	MAG	7/15/97	PEAK/DETECT XFER REGS
ISSUED			SHEET 5 OF 6
			FILE NAME
			12027-0.5
			REV
			000-12027 0

REV	DESCRIPTION	DATE	CHECKER	Q.C. AUTH.
-----	-------------	------	---------	------------

1				
---	--	--	--	--

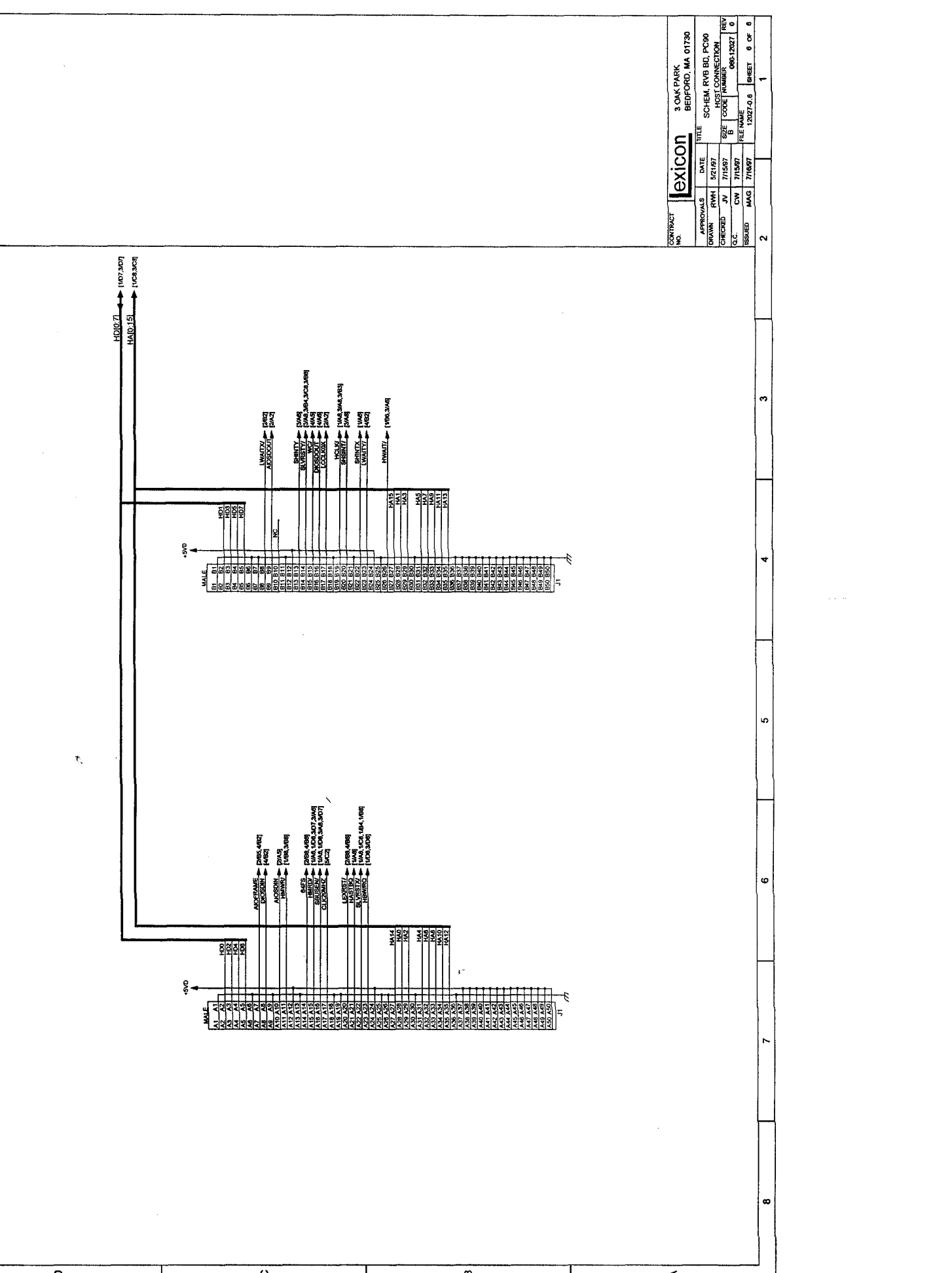

<b>lexicon</b> 3 OAK PARK BEDFORD, MA 01730	
CONTRACT NO.	
APPROVALS	DATE
DESIGNED BY	7/21/97
CHECKED BY	7/15/97
ISSUED BY	7/16/97
TITLE	SCH-EM, RVB BD, PC90
SCALE	HOST CONNECTION
Q.C.	FILE NAME
	12027-0.6
	SHEET 6 OF 6

2	3	4	5	6	7	8
---	---	---	---	---	---	---