

<sup>®</sup>  
**MACKIE**

# 1604-VLZ PRO 16-CHANNEL MIC/LINE MIXER OWNER'S MANUAL

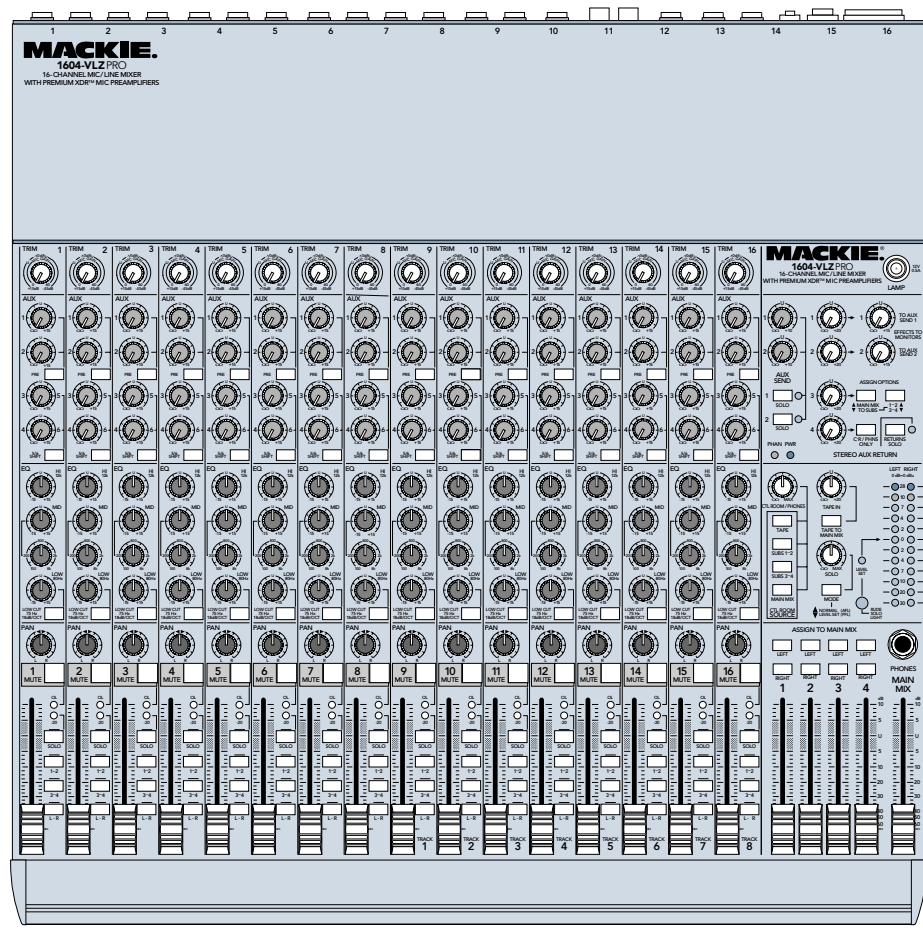

<div style="display: inline-block; background-color: black; color: white; padding: 2px 10px; font-weight: bold; margin: 0 10px;">CAUTION AVIS</div>
<b>RISK OF ELECTRIC SHOCK DO NOT OPEN</b> <b>RISQUE DE CHOC ELECTRIQUE NE PAS OUVRIR</b>
<b>CAUTION: TO REDUCE THE RISK OF ELECTRIC SHOCK DO NOT REMOVE COVER (OR BACK) NO USER-SERVICEABLE PARTS INSIDE REFER SERVICING TO QUALIFIED PERSONNEL</b> <b>ATTENTION: POUR EVITER LES RISQUES DE CHOC ELECTRIQUE, NE PAS ENLEVER LE COUVERCLE. AUCUN ENTRETIEN DE PIECES INTERIEURES PAR L'USAGER. CONFIER L'ENTRETIEN AU PERSONNEL QUALIFIE.</b> <b>AVIS: POUR EVITER LES RISQUES D'INCENDIE OU D'ELECTROCUTION, N'EXPOSEZ PAS CET ARTICLE A LA PLUIE OU A L'HUMIDITE</b>

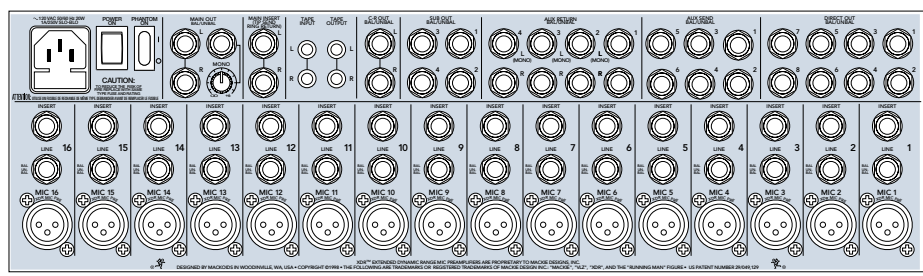

The lightning flash with arrowhead symbol within an equilateral triangle is intended to alert the user to the presence of uninsulated "dangerous voltage" within the product's enclosure, that may be of sufficient magnitude to constitute a risk of electric shock to persons.  
*Le symbole éclair avec point de flèche à l'intérieur d'un triangle équilatéral est utilisé pour alerter l'utilisateur de la présence à l'intérieur du coffret de "voltage dangereux" non isolé d'ampleur suffisante pour constituer un risque d'électrocution.*



The exclamation point within an equilateral triangle is intended to alert the user of the presence of important operating and maintenance (servicing) instructions in the literature accompanying the appliance.  
*Le point d'exclamation à l'intérieur d'un triangle équilatéral est employé pour alerter les utilisateurs de la présence d'instructions importantes pour le fonctionnement et l'entretien (service) dans le livret d'instruction accompagnant l'appareil.*

## SAFETY INSTRUCTIONS

- 1. Read Instructions** — All the safety and operation instructions should be read before this Mackie product is operated.
- 2. Retain Instructions** — The safety and operating instructions should be kept for future reference.
- 3. Heed Warnings** — All warnings on this Mackie product and in these operating instructions should be followed.
- 4. Follow Instructions** — All operating and other instructions should be followed.
- 5. Water and Moisture** — This Mackie product should not be used near water — for example, near a bathtub, washbowl, kitchen sink, laundry tub, in a wet basement, near a swimming pool, swamp or salivating St. Bernard dog, etc.
- 6. Cleaning** — Clean only with a dry cloth.
- 7. Ventilation** — This Mackie product should be situated so that its location or position does not interfere with its proper ventilation. For example, the Component should not be situated on a bed, sofa, rug, or similar surface that may block any ventilation openings, or placed in a built-in installation such as a bookcase or cabinet that may impede the flow of air through ventilation openings.
- 8. Heat** — This Mackie product should be situated away from heat sources such as radiators, or other devices which produce heat.
- 9. Power Sources** — This Mackie product should be connected to a power supply only of the type described in these operation instructions or as marked on this Mackie product.
- 10. Power Cord Protection** — Power supply cords should be routed so that they are not likely to be walked upon or pinched by items placed upon or against them, paying particular attention to cords at plugs, convenience receptacles, and the point where they exit this Mackie product.
- 11. Object and Liquid Entry** — Care should be taken so that objects do not fall on, and liquids are not spilled into, this Mackie product.

**12. Damage Requiring Service** — This Mackie product should be serviced only by qualified service personnel when:

- A.** The power-supply cord or the plug has been damaged; or
- B.** Objects have fallen, or liquid has spilled into this Mackie product; or
- C.** This Mackie product has been exposed to rain; or
- D.** This Mackie product does not appear to operate normally or exhibits a marked change in performance; or
- E.** This Mackie product has been dropped, or its chassis damaged.

**13. Servicing** — The user should not attempt to service this Mackie product beyond those means described in this operating manual. All other servicing should be referred to the Mackie Service Department.

**14.** To prevent electric shock, do not use this polarized plug with an extension cord, receptacle or other outlet unless the blades can be fully inserted to prevent blade exposure.

*Pour prévenir les chocs électriques ne pas utiliser cette fiche polarisée avec un prolongateur, un prise de courant ou une autre sortie de courant, sauf si les lames peuvent être insérées à fond sans laisser aucune partie à découvert.*

**15. Grounding or Polarization** — Precautions should be taken so that the grounding or polarization means of this Mackie product is not defeated.

**16. Power Precautions** — Unplug this Mackie product during lightning storms or when unused for long periods of time. Note that this Mackie product is not completely disconnected from the AC mains service when the power switch is in the OFF position.

**17.** This apparatus does not exceed the Class A/Class B (whichever is applicable) limits for radio noise emissions from digital apparatus as set out in the radio interference regulations of the Canadian Department of Communications.

*ATTENTION — Le présent appareil numérique n'émet pas de bruits radioélectriques dépassant les limites applicables aux appareils numériques de class A/de class B (selon le cas) prescrites dans le règlement sur le brouillage radioélectrique édicté par les ministere des communications du Canada.*

**18.** Exposure to extremely high noise levels may cause permanent hearing loss. Individuals vary considerably in susceptibility to noise-induced hearing loss, but nearly everyone will lose some hearing if exposed to sufficiently intense noise for a period of time. The U.S. Government's Occupational Safety and Health Administration (OSHA) has specified the permissible noise level exposures shown in the following chart.

According to OSHA, any exposure in excess of these permissible limits could result in some hearing loss. To ensure against potentially dangerous exposure to high sound pressure levels, it is recommended that all persons exposed to equipment capable of producing high sound pressure levels use hearing protectors while the equipment is in operation. Ear plugs or protectors in the ear canals or over the ears must be worn when operating the equipment in order to prevent a permanent hearing loss if exposure is in excess of the limits set forth here.

Duration Per Day In Hours	Sound Level dBA, Slow Response	Typical Example
8	90	Duo in small club
6	92	
4	95	Subway Train
3	97	
2	100	Very loud classical music
1.5	102	
1	105	Tami screaming at Adrian about deadlines
0.5	110	
0.25 or less	115	Loudest parts at a rock concert

**WARNING** — To reduce the risk of fire or electric shock, do not expose this appliance to rain or moisture.

# READ THIS PAGE!!!

We realize that you must have a powerful hankerin' to try out your new 1604-VLZ PRO. Or you might be one of those people who never reads manuals. Either way, all we ask is that you read this page NOW, and the rest can wait until you're good and ready. But do read it — you'll be glad you did.

## 1 LEVEL-SETTING PROCEDURE

Message to seasoned pros: *do NOT* set levels using the old "Turn the trim up until the clip light comes on, then back off a hair" trick. When a Mackie Designs mixer clip light comes on, you really are about to clip.

This procedure really works — it assures low noise and high headroom. Please read on.

It's not even necessary to hear what you're doing to set optimal levels. But if you'd like to: Plug headphones into the PHONES output jack, then set the C-R PHONES knob about one-quarter of the way up.

The following steps must be performed *one channel at a time*:

1. Turn the TRIM, AUX send and fader controls fully down.
2. Be sure the 1-2, 3-4 and L-R channel assignment switches are all disengaged.
3. Set the EQ knobs at the center detents.
4. Connect the signal source to the MIC or LINE channel input.
5. Engage (push in) the channel's SOLO switch.
6. Push in the MODE switch in the output section (LEVEL SET (PFL) mode) — the LEVEL SET LED will light.
7. Play something into the selected input, at real-world levels.
8. Adjust the TRIM control so that the display on the meter stays around "0." (Only the left meter is active in the Level-Setting Procedure.)
9. If you'd like to apply some EQ, do so now and return to the previous step.
10. Disengage that channel's SOLO switch.
11. Repeat for each of channels 1-16.

## Other Nuggets of Wisdom

For optimum sonic performance, the channel faders and the MAIN MIX fader should be set near the "U" (unity gain) markings.

Always turn the MAIN MIX fader and CTL ROOM/PHONES knob down before making connections to and from your 1604-VLZ PRO.

If you shut down your equipment, turn off your amplifiers first. When powering up, turn on your amplifiers last.

**Save the shipping box!** You may need it someday, and you don't want to have to pay for another one.



## 2 INSTANT MIXING

Here's how to get going right away, assuming you own a microphone and a keyboard:

1. Plug your microphone into Channel 1's MIC input.
2. Turn on the 1604-VLZ PRO.
3. Perform the **Level-Setting Procedure 1**.
4. Connect cords from the MAIN OUT jacks to your amplifier.
5. Hook up speakers to the amp and turn it on.
6. Set channel 1's fader to the "U" mark.
7. Engage (push in) Channel 1's L-R switch.
8. Set the MAIN MIX fader one-quarter of the way up.
9. Sing like a canary!
10. Plug your keyboard into channels 3 and 4.
11. Turn channel 3's PAN knob fully left and channel 4's PAN knob fully right.
12. Set those faders to the "U" mark.
13. Perform the **Level-Setting Procedure 1**.
14. Engage the L-R switch on these channels.
15. Play like a madman *and* sing like a canary! It's your first mix!

**Please write your serial number here for future reference (i.e. insurance claims, tech support, return authorization, etc.):**

**Purchased at:**

**Date of purchase:**

# INTRODUCTION

Thank you for choosing a Mackie Designs professional compact mixer. The 1604-VLZ PRO is equipped with our new precision-engineered XDR™ Extended Dynamic Range premium studio-grade mic preamp featuring:

- Full gain range from 0 to 60dB
- +22 dBu line signal handling capability
- 130 dB dynamic range
- Distortion less than 0.0007%, 20Hz to 20kHz
- Bullet-proof RF rejection using DC pulse transformer circuitry

Now that you have your 1604-VLZ PRO, find out how to get the most from it. That's where this manual comes in.

## HOW TO USE THIS MANUAL

Since many of you folks will want to hook up your 1604-VLZ PRO immediately, the first pages you will encounter after the table of contents are the ever popular hookup diagrams. These show typical mixer setups for Record/Mixdown, Video, Disc Jockey and Stereo PA. After this section is a detailed tour of the entire mixer.

Every feature of the 1604-VLZ PRO will be described "geographically;" in other words, in order of where it is physically placed on the mixer's top or rear panel. These descriptions are divided into the first three manual chapters, just as your mixer is organized into three distinct zones:

1. PATCHBAY: The zillion jacks on the back of the "pod."
2. CHANNEL STRIP: The sixteen channel strips on the left.
3. OUTPUT SECTION: The output section on the right.

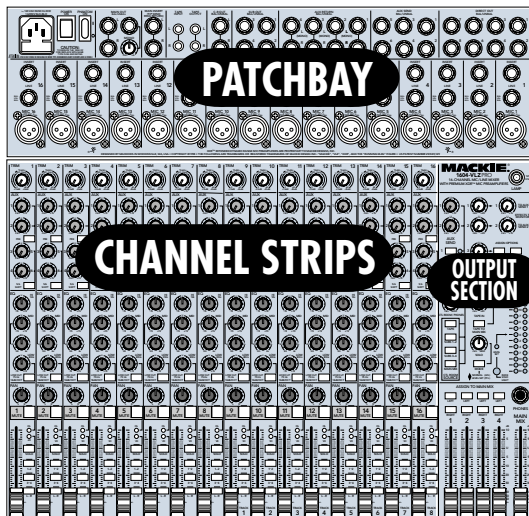

Whenever a specific 1604-VLZ PRO component is mentioned, it'll be in all capital letters sans-serif type. That can help you find references to specific controls much faster, without slowing you down as you read normally. For example: The quick brown fader jumped over the RUDE SOLO LIGHT.

Throughout these chapters you'll find illustrations, with each feature numbered. If you're curious about a feature, simply locate it on the appropriate illustration, note the number attached to it, and find that number in the nearby paragraphs or refer to the table of contents.

You'll also find cross-references to these numbered features within a paragraph. For instance, if you see "*To wire your own cables:* 12," simply find that number in the manual and you've found your answer. (These are not page numbers.)

You'll also notice feature numbers just floating in space, like this 33. These numbers direct you to relevant information.



This icon marks information that is critically important or unique to the 1604-VLZ PRO. For your own good, read them and remember them. They will be on the final test.



This icon will lead you to in-depth explanations of features and practical tips. While not mandatory, they'll have some valuable information.

## A PLUG FOR THE CONNECTORS SECTION

Appendix A is a section on connectors: XLR connectors, balanced connectors, unbalanced connectors, special hybrid connectors.

More resources on our website @ [www.mackie.com](http://www.mackie.com)

## THE GLOSSARY: A Haven of Non-Techiness For The Neophyte

The "Glossary of Terms" is a fairly comprehensive dictionary of pro-audio terms. If terms like "clipping," "noise floor," or "unbalanced" leave you blank, refer to this glossary for a quick explanation.

## ARCANE MYSTERIES ILLUMINATED

"Arcane Mysteries" discusses some of the down 'n' dirty practical realities of microphones, fixed installations, grounding, and balanced versus unbalanced lines. It's a goldmine for the neophyte and even the seasoned pro might learn a thing or two.

# CONTENTS

1	LEVEL-SETTING PROCEDURE .....	3	51	PRE .....	21
2	INSTANT MIXING .....	3	52	5/6 SHIFT .....	21
3	HOOKUP DIAGRAMS .....	6	53	OUTPUT SECTION DESCRIPTION .....	22
4	CONVERTING TO RACKMOUNT MODE .....	9	54	MAIN MIX FADER .....	22
6	PATCHBAY DESCRIPTION .....	10	55	VLZ MIX ARCHITECTURE .....	22
7	E-Z INTERFACE .....	10	56	SUB FADERS .....	22
8	MIC/LINE INPUTS ON EVERY CHANNEL ....	10	57	ASSIGN TO MAIN MIX .....	22
9	MIC INPUTS .....	10	58	TAPE IN (LEVEL) .....	23
11	PHANTOM POWER .....	10	59	TAPE TO MAIN MIX .....	23
12	LINE INPUTS .....	11	61	SOURCE .....	23
13	TRIM .....	11	62	CTL ROOM/PHONES .....	23
14	INSERT .....	11	63	MODE (NORMAL (AFL)/LEVEL SET (PFL)) ...	24
15	DIRECT OUT .....	11	64	LEVEL SET LED .....	24
16	SPLIT MONITORING .....	12	65	SOLO (LEVEL) .....	24
17	AUX SEND OUTPUTS .....	12	66	RUDE SOLO LIGHT .....	24
18	EFFECTS: SERIAL OR PARALLEL? .....	13	67	METERS .....	25
19	AUX RETURN INPUTS .....	13	68	AUX TALK .....	25
21	SUB OUTS .....	13	69	AUX SEND (MASTER) .....	25
22	C-R OUTS (CONTROL ROOM OUTPUTS) ....	14	71	AUX SENDS SOLO .....	26
23	PHONES OUTPUT .....	14	72	AUX RETURNS (LEVEL) .....	26
24	TAPE OUTPUT .....	14	73	EFFECTS TO MONITOR .....	26
25	TAPE INPUT .....	14	74	MAIN MIX TO SUBS (AUX RET 3) .....	26
26	MAIN INSERT .....	15	75	1-2/3-4 (AUX RET 3) .....	26
27	MAIN OUTS .....	15	76	C-R/PHNS ONLY (AUX RET 4) .....	27
28	MONO OUTPUT .....	15	77	RETURNS SOLO .....	27
29	MONO LEVEL .....	15	78	MODIFICATIONS .....	27
31	POWER CONNECTION .....	15	79	1604-VLZ PRO BLOCK DIAGRAM .....	28
32	FUSE .....	15	80	GAIN STRUCTURE DIAGRAM .....	29
33	POWER SWITCH .....	16	81	SPECIFICATIONS .....	30
34	POWER LED .....	16	82	SERVICE INFO .....	31
35	PHANTOM SWITCH .....	16	APPENDIX A: CONNECTIONS .....		32
36	PHANTOM LED .....	16	TRACK SHEET .....		36
37	BNC LAMP SOCKET .....	16	COLOPHON .....		38
38	CHANNEL STRIP DESCRIPTION .....	17	1604-VLZ PRO LIMITED WARRANTY .....		39
39	“U” LIKE UNITY GAIN .....	17			
40	FADER .....	17			
41	ASSIGN (1-2, 3-4, L-R) .....	17			
42	SOLO .....	18			
43	-20 (SOLO) LED .....	18			
44	OL (MUTE) LED .....	18			
45	MUTE .....	19			
46	PAN .....	19			
47	3-BAND MID-SWEEP EQ .....	19			
48	LOW CUT .....	20			
49	AUX .....	20			

### 3 HOOKUP DIAGRAMS

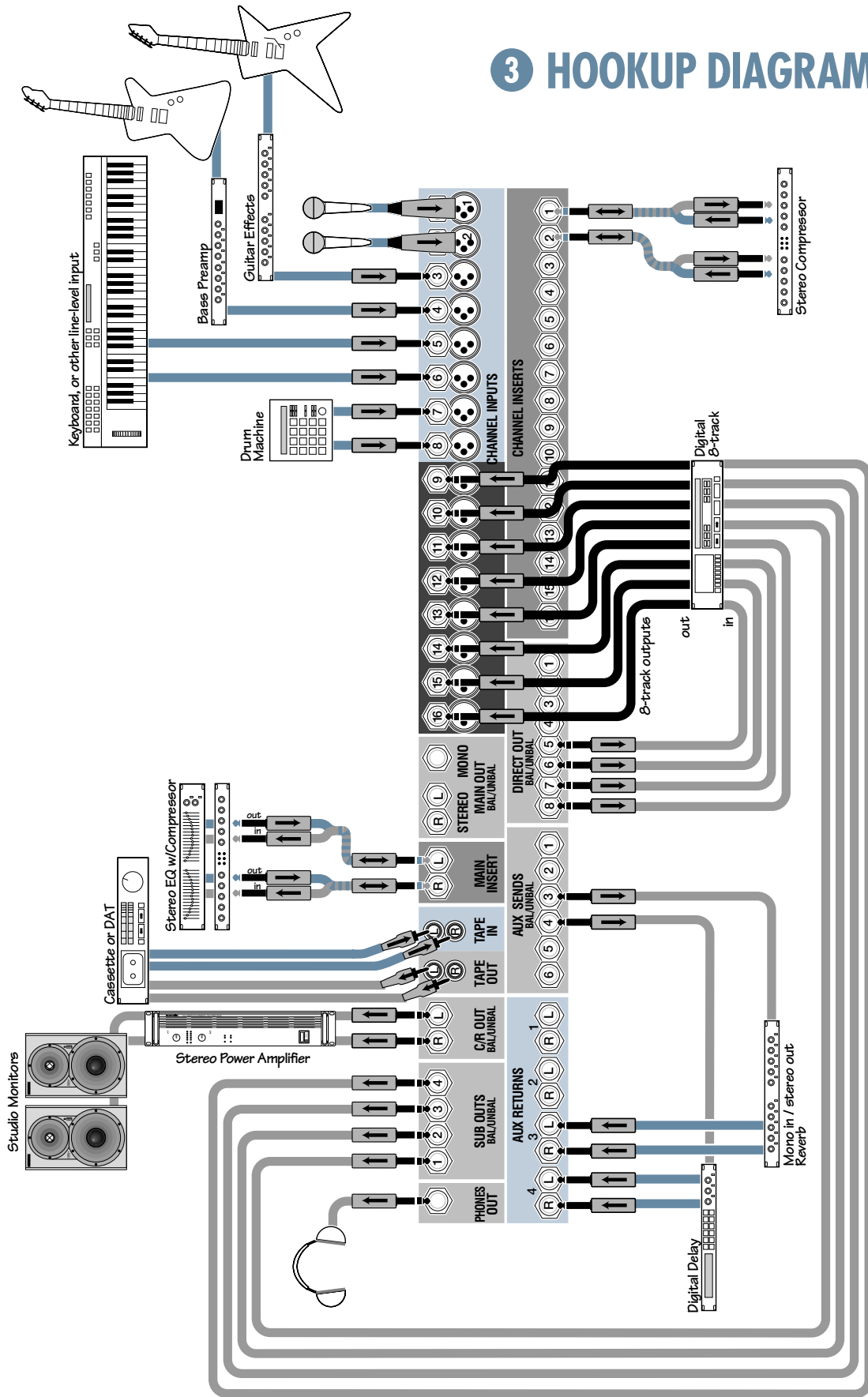

1604-VLZ PRO 8-Track Tracking

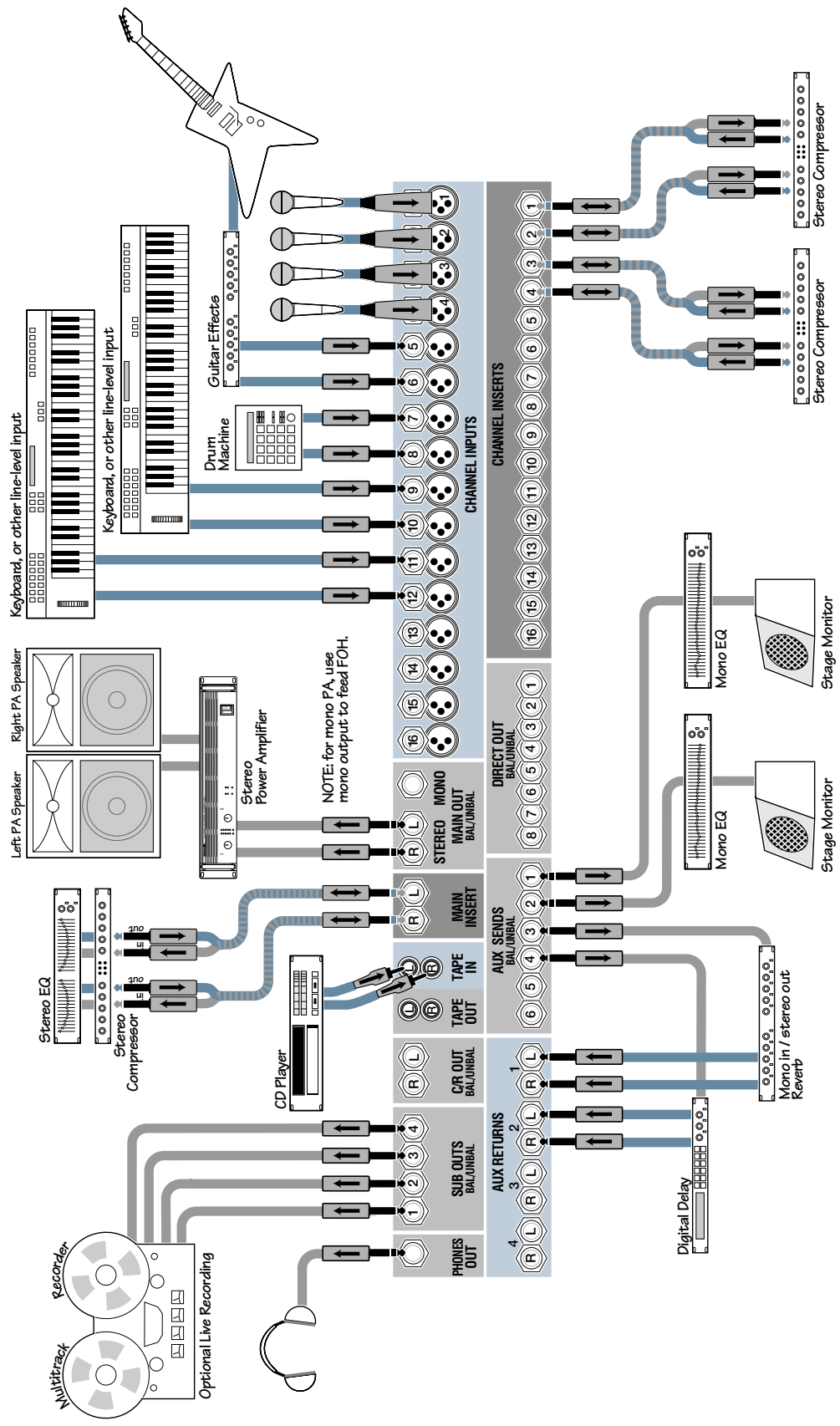

1604-VLZ PRO Stereo P.A.

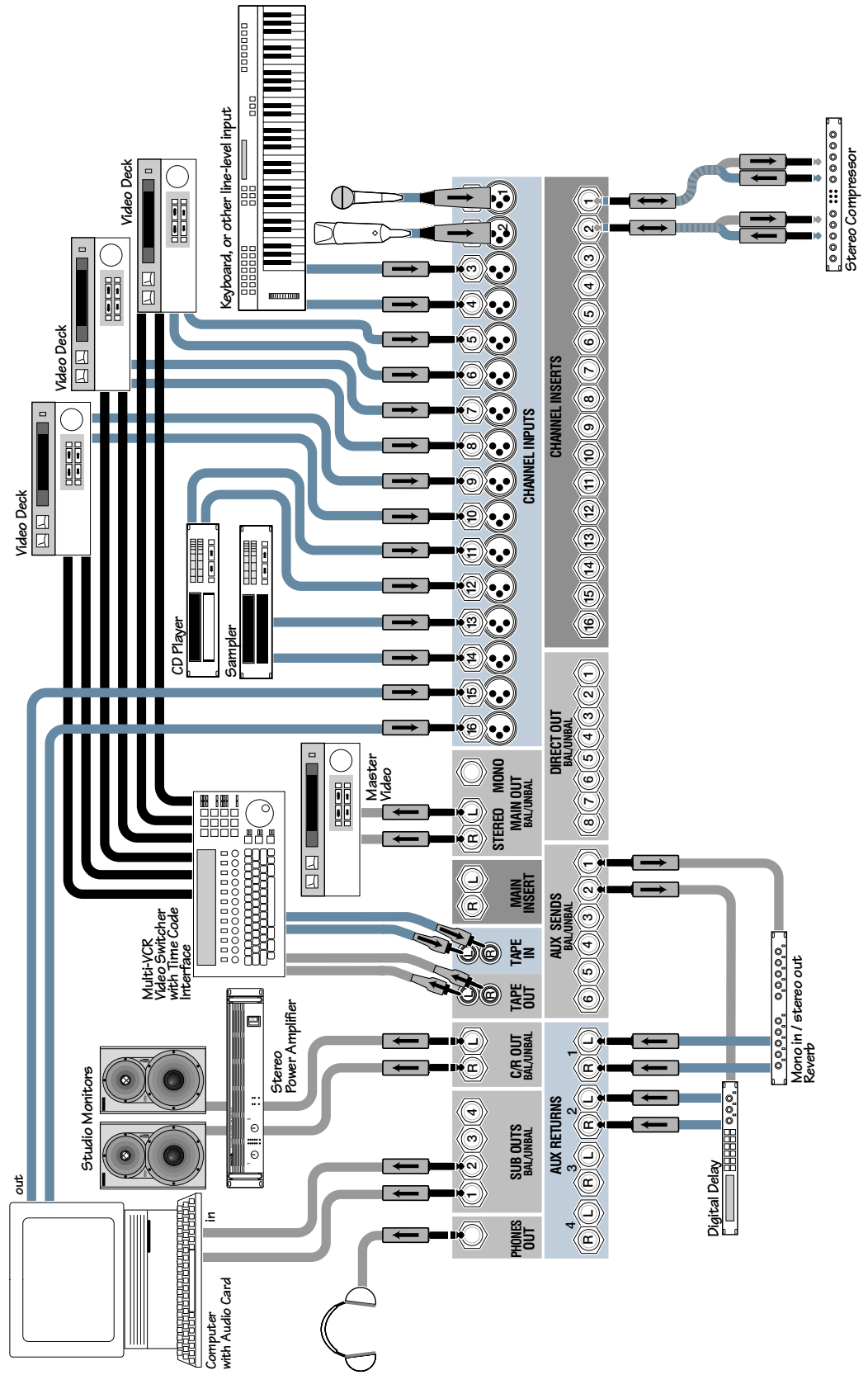

## 1604-VLZ PRO Video Setup



## 4 CONVERTING TO RACKMOUNT MODE

Not only is the new 1604-VLZ PRO a compact, professional-quality tabletop mixer, it's rack-mountable! Its unique rotating input pod makes this possible.

One of the things that revolutionized the compact mixer industry was the “convertible pod” found on the original, classic CR-1604. Using an ordinary Phillips screwdriver, the mixer could be converted from desktop mode (as it comes from the factory) to rackmount mode.

Fear not. We wouldn't dare take that feature out of the New Improved 1604-VLZ PRO. It's still there and still takes just a few minutes with your trusty screwdriver. Here's how it's done:

1. Remove ALL the cords from the mixer — audio, power, lamps, everything.
2. Place the mixer, face down, on a clean soft surface, like a blanket or very large dog.
3. Remove the four screws securing the cable cover **a** and set the plate aside.
4. Replace two of the screws; the ones at the pod end of the mixer **b**.
5. Remove two pod-mounting screws on each side of the mixer **c**.
6. Gently pull the pod away from the slots, rotate it, and place it, tabs first, into the rackmount tabs **d**, located on the underside of the main chassis. Be careful not to constrict or pinch any of the ribbon or power cables.
7. Carefully install the pod-mounting screws in their new locations **d**.
8. Install the rack ears that came with the mixer. They can be installed in either of two depths: **e** mixer's surface flush with the rack rails, like ordinary rackmount equipment, or **f** mixer's surface sunken into the rack, to protect the knobs from being bumped.

An optional accessory called the ROTOPOD-VLZ is available and can be used in desktop or rackmount installations. It will put the patchbay jacks on the same plane as all the knobs, buttons and faders. This is a lifesaver in applications that demand frequent repatching, and costs a heck of a lot less than an external patchbay, not to mention all the interface and patch cords: [82](#). Please visit your dealer for more exciting details. Be sure to order the “VLZ” version so you don't end up with the one for the classic CR-1604!

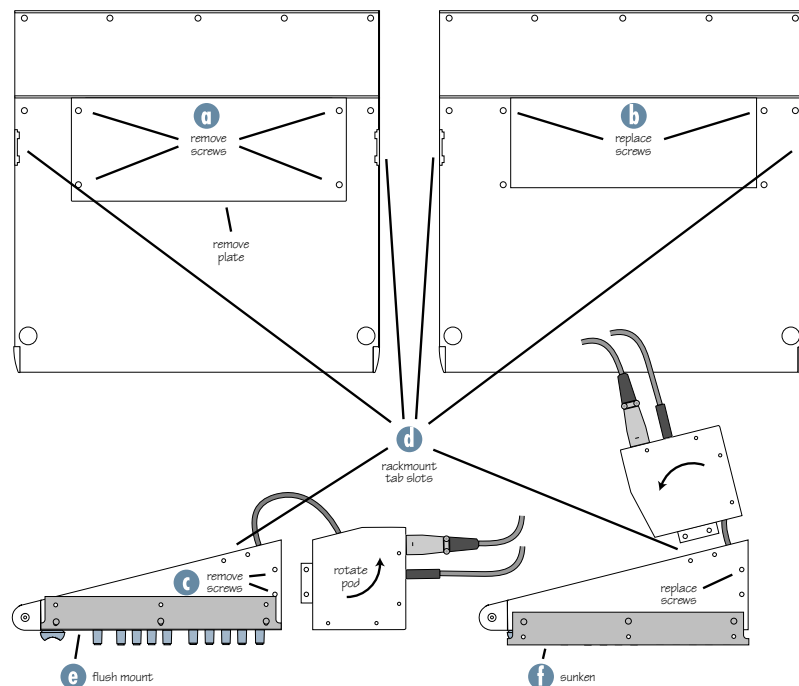

## 6 PATCHBAY DESCRIPTION

At the risk of stating the obvious, this is where you plug everything in: microphones, line-level instruments and effects, and the ultimate destination for your sound: a tape recorder, PA system, etc. A few of the features described in this section are on top of the mixer, but most are out back on the “pod.”



### 7 E-Z INTERFACE

Concerned about levels, balancing, impedances, polarity, or other interface goblins? Don't be. On your

1604-VLZ PRO, you can patch anything almost anywhere, with nary a care. Here's why:

- Every input and output is balanced (except insert, phones and RCA jacks).
- Every input and output will also accept unbalanced lines (except XLR jacks).
- Every input is designed to accept virtually any output impedance.
- The main left and right mix outputs can deliver 28dBu into as low as a 600 ohm load.
- All the other outputs can deliver 22dBu into as low as a 600 ohm load.
- All the outputs are in phase with the inputs.

All we ask is that you perform the **Level-Setting Procedure 1** every time you patch in a new sound source. So stop worrying and start mixing!

### 8 MIC/LINE INPUTS ON EVERY CHANNEL

The original CR-1604 had six mic/line channels and ten line-only channels. That was fine for most applications, but live sound users were forced to go out and buy the XLR-10 mic input add-on module. No more. Each and every channel on the New Improved 1604-VLZ PRO has the legendary Mackie mic/line input circuit. It's like getting a free XLR-10 with your mixer!

### 9 MIC INPUTS

We use phantom-powered, balanced microphone inputs just like the big studio mega-consolos, for exactly the same reason: This kind of circuit is excellent at rejecting hum

and noise. You can plug in almost any kind of mic that has a standard XLR-type male mic connector. Always be sure to perform the **Level-Setting Procedure 1**. To learn how signals are routed from these inputs: 38. If you wire your own, connect them like this:

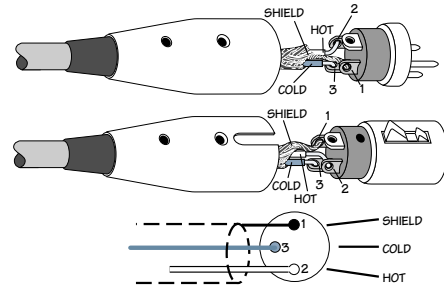

*Pin 1 = ground or shield*

*Pin 2 = positive (+ or hot)*

*Pin 3 = negative (- or cold)*

Professional ribbon, dynamic, and condenser mics will all sound excellent through these inputs. The 1604-VLZ PRO's mic inputs will handle almost any kind of mic level you can toss at them, without overloading.

### 11 PHANTOM POWER

Most condenser mics require phantom power, where the mixer sends low-current DC voltage to the mic's electronics through the same wires that carry audio. The 1604-VLZ PRO's phantom power is globally controlled by the PHANTOM switch on the rear panel 35.

Semipro condenser mics often have batteries to accomplish the same thing. “Phantom” owes its name to an ability to be “unseen” by dynamic mics (Shure® SM57/SM58, for instance) that don't need external power and aren't affected by it anyway.



Unless you know for certain it is safe to do so, never plug single-ended (unbalanced) microphones, instruments or electronic devices into the MIC input jacks if the phantom power is on.

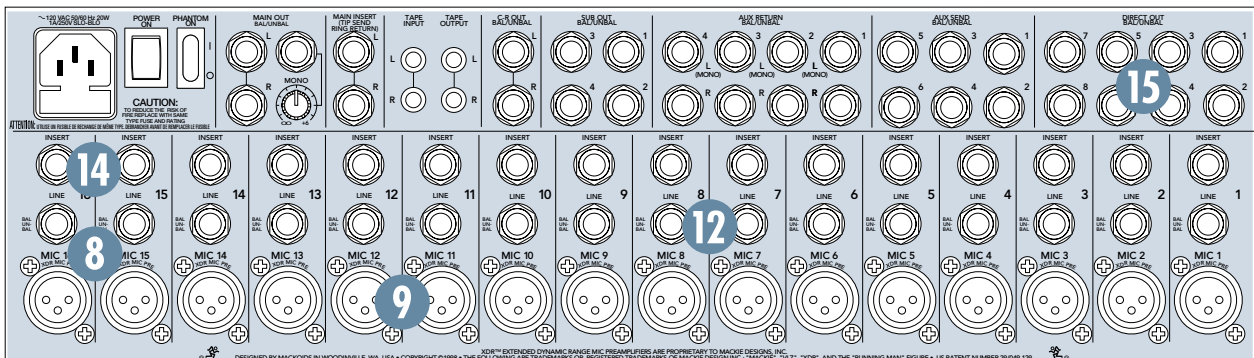

## 12 LINE INPUTS

These 1/4" jacks share circuitry (but not phantom power) with the mic preamps. You can use these inputs for virtually any signal you'll come across, from instrument levels as low as -50dB to operating levels of -10dBV to +4dBu, as there is 60dB of gain available via the TRIM knob 13. Always be sure to perform the **Level-Setting Procedure** 1.

To learn how signals are routed from these inputs: 38. To connect balanced lines to these inputs, use a 1/4" tip-ring-sleeve (TRS) plug, the type found on some stereo headphones:

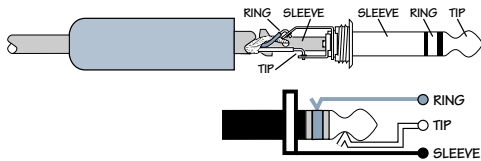

*Tip = positive (+ or hot)*  
*Ring = negative (- or cold)*  
*Sleeve = shield or ground*

To connect unbalanced lines to these inputs, use a 1/4" mono (TS) phone plug or standard instrument cable:

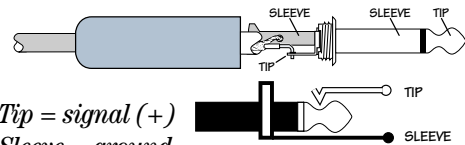

*Tip = signal (+)*  
*Sleeve = ground*

## 13 TRIM

Yes it's true, these controls are not located in the patchbay section at all. They're found along the top row of knobs in the channel strip section. But their purpose is so closely linked with the MIC and LINE input jacks that we couldn't bear to separate them. Here's why: Every time you plug something into a MIC or LINE input jack, you should perform the **Level-Setting Procedure** 1, and that procedure is basically "how to use the TRIM knob."

TRIM adjusts the input sensitivity of the MIC and LINE inputs. This allows signals from the outside world to be adjusted to optimal internal operating levels.

Through the XLR jack (MIC), there will be 0dB of gain with the knob fully down, ramping to 60dB of gain fully up.

Through the 1/4" input (LINE), there is 15dB of attenuation fully down and 45dB of gain fully up, with a "U" (unity gain) mark at 10:00.

This 15dB of attenuation can be very handy when you are inserting a signal that is very hot, or you want to add a lot of EQ gain, or both. Without this "virtual pad," a scenario like that might lead to channel clipping.

## 14 INSERT

These 1/4" jacks are for connecting serial effects processors such as compressors, equalizers, de-essers, or filters 18. The INSERT point is after the TRIM control, but before the channel's EQ, LOW CUT, fader and MUTE controls. Insert cables must be wired thusly:

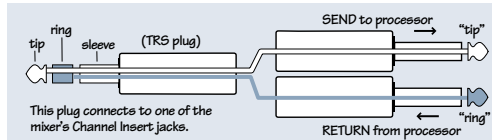

*Tip = send (output to effects device)*  
*Ring = return (input from effects device)*  
*Sleeve = common ground*

Even though channels 1-8 already have DIRECT OUT jacks 15, INSERT jacks can also be used as channel direct outputs; post-TRIM, pre-LOW CUT, and pre-EQ. Here's three ways you can use the INSERT jacks:

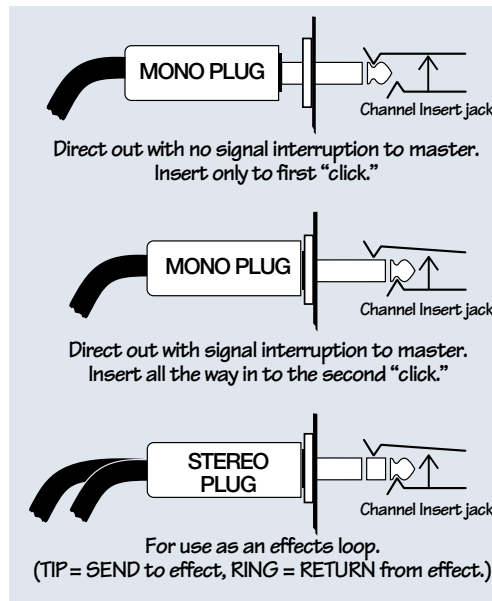

## 15 DIRECT OUT

Found only on channels 1-8, these 1/4" jacks deliver the signal from the very end of the channel path; post-TRIM, post-EQ, post-LOW CUT, post-fader and post-MUTE. They are the key player in "split monitoring," making the 1604-VLZ PRO perfect for an 8-track studio. *Tb wire your own cables:* 27.

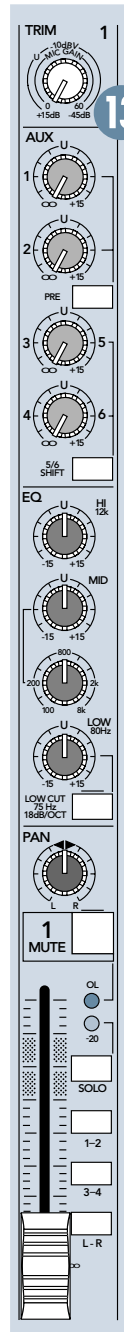

## 16 SPLIT MONITORING

With split monitoring, you use the first eight channels for your sound sources: vocal mics, drum mics, keyboard/synth outputs, guitar effects outputs, that sort of thing. From there, the channels manipulate the sound, but are not assigned to the output section. Instead, they're patched from the channel's **DIRECT OUT** jacks to the corresponding multitrack input (**DIRECT OUT 1** to multitrack input 1, 2 to 2, 3 to 3, etc.). The signals will now be recorded or pass directly through the multitrack, depending on each track's record-ready status.

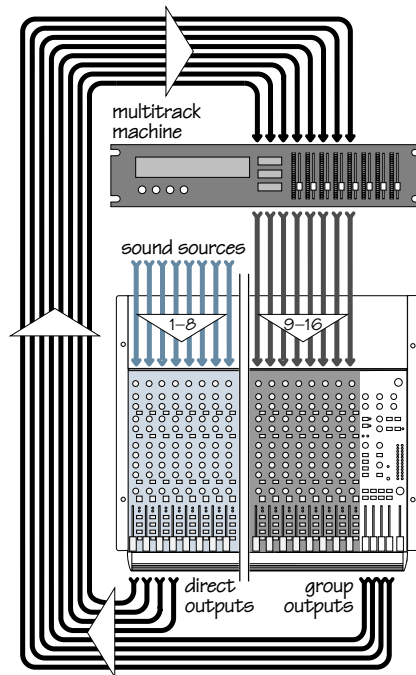

The outputs of the multitrack are then patched to the next eight **LINE** inputs on the 1604-VLZ PRO (multitrack out 1 to **LINE** input 9, 2 to 10, 3 to 11, etc.). Aha! That's why it says "TRACK 1" next to channel 9's fader, "TRACK 2" next to channel 10, and so forth. These channels (9–16) will be assigned to the mixer's output section, delivering the signals to their ultimate destination, which may be your mixdown 2-track, your control room system, or your headphones.

But let's not forget that the 1604-VLZ PRO is a 4-bus mixer. These buses lead to the **SUB OUTS** 21, and are designed to accomplish the task of getting channels to the multitrack without using the direct outputs.

For example, a channel is assigned to **SUB OUT 1**. **SUB OUT 1**'s output is patched to multitrack input 1. From there, the multitrack output goes to the mixer's channel 9 **LINE** input, as we just discussed. (Hot tip: To feed an 8-track deck with 4 sub outputs, simply use Y-cords: **SUB OUT 1** feeds tracks 1 and 5, 2 feeds 2 and 6, 3 feeds 3 and 7, and 4 feeds 4 and 8. Tracks in record mode will accept the signal, and tracks in safe mode will ignore the signal.)

The advantages: You can assign any channel to any track, without repatching. You can assign multiple channels to one track and control the overall level of that subgroup 56. You can't bounce tracks without this feature.

Perhaps the best method is to do both: Use the **SUB OUTS** to feed multichannel submixes (like a drum kit) to some of the tracks, and the **DIRECT OUT** jacks to feed single-channel signals (like bass guitar) to the other tracks.

The point is that you never listen directly to the source channels (1–8). You listen to the monitor channels (9–16) and they're listening to the multitrack that is listening to the source channels. The main advantage is that you won't be forced to constantly repatch your multitrack — just set it up and forget it. You'll also know for certain that the signals are indeed getting to the multitrack, since you're constantly listening to it.

Another method of interfacing a multitrack is called inline monitoring, and requires a mixing console dedicated to that, like the Mackie 8•Bus. Each of its channels is actually two channels: one carrying the mic/line sound source and the other carrying the multitrack output.

## 17 AUX SEND OUTPUTS

These 1/4" jacks usually patch to the inputs of your parallel effects devices 18 or to the inputs of your stage monitor amps. To learn how signals are routed to these outputs: 68. *To wire your own cables:* 27.

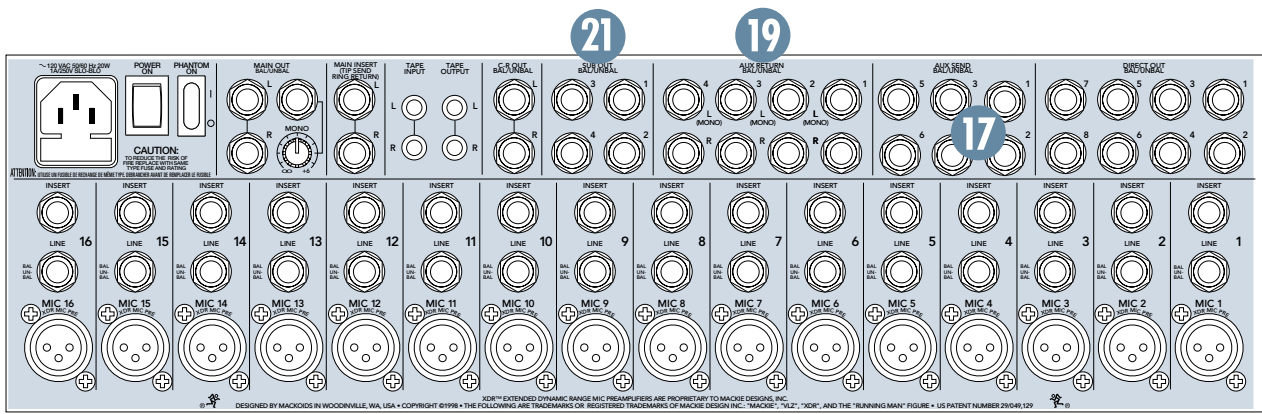

## 18 EFFECTS: SERIAL OR PARALLEL?

You've heard us carelessly toss around the terms "serial" and "parallel." Here's what we mean by them:

"Serial" means that the *entire* signal leaves the mixer (INSERT send), is routed through the effects device, and returns to the mixer (INSERT return). Examples: compressor, limiter, graphic equalizer. Line-level sources can also be patched through a serial effects device before or after the mixer.

"Parallel" means that a *portion* of the signal in the mixer is tapped off to the device (AUX SEND), processed, and returned to the mixer (AUX RETURN) to be mixed with the original "dry" signal. This way, multiple channels can all make use of the same effects device. Examples: reverb, digital delay.

## 19 AUX RETURN INPUTS

This is where you connect the outputs of your parallel effects devices (or extra audio sources). They'll accept just about any pro or semipro effects device on the market. *To learn how signals are routed from these inputs:* 12. *To wire your own cables:* 12.

**Mono:** If you have an effects device with a mono output (one cord), plug that into L input of an AUX RETURN and leave the right input unplugged. That way, the signal will be sent to both sides, magically appearing in the center as a mono signal.

## 21 SUB OUTS

These 1/4" jacks are usually patched to the inputs of a multitrack deck, or to secondary amplifiers in a complex installation. *To learn how signals are routed to these outputs:* 56. *To wire your own cables:* 27.

## Double Busing

How on earth do you get four jacks to feed eight tracks? To feed an 8-track deck with only four SUB OUTS, simply use four Y-cords:

- SUB OUT 1 feeds tracks 1 and 5
- SUB OUT 2 feeds tracks 2 and 6
- SUB OUT 3 feeds tracks 3 and 7
- SUB OUT 4 feeds tracks 4 and 8

Tracks in record mode will accept the signal, and tracks in safe mode will ignore the signal. It's that easy.

### Serial Device (e.g., Compressor)

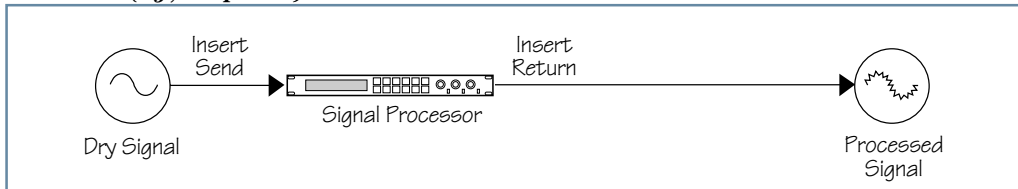

### Parallel Device (e.g., Reverb)

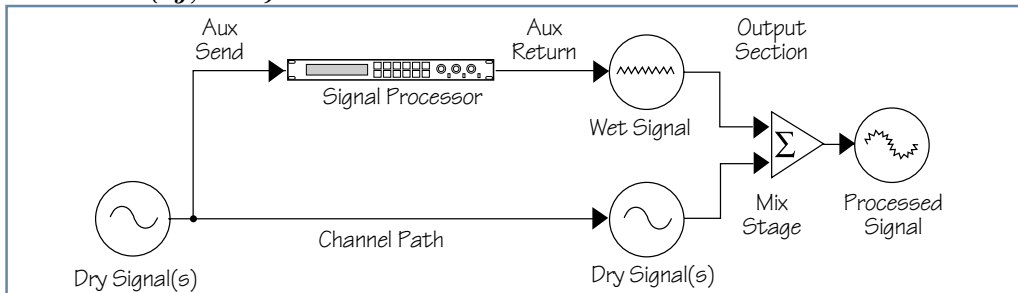



This method is exactly the same as the double-busing feature found in other mixers. Built-in double-busing is nothing more than Y-cords living inside the mixer instead of hanging out the back. If we had room for the extra jacks, we would have thrown them in, but we don't, so we didn't. Sonically, there is no difference whatsoever.

Y-cord advice: Do *not* use the stereo "headphone-to-left/right" splitter adapters. Use the type that send the same signal to two places; the tip of the source plug feeds the tips of both destination plugs (Radio Shack® #42-2150, for instance.)

### 22 C-R OUTS (CONTROL ROOM OUTPUTS)

These 1/4" jacks are usually patched to the inputs of your control room amplifier or a headphone distribution amplifier. *To learn how signals are routed to these outputs:* 62. *To wire your own cables:* 27.

### 23 PHONES OUTPUT

The 1604-VLZ PRO's stereo 1/4" phones jack will drive any standard headphone to very loud levels. Walkperson-type phones can also be used with an appropriate adapter. *To learn how signals are routed to these outputs:* 62. If you're wiring your own cable for the PHONES output, follow standard conventions:

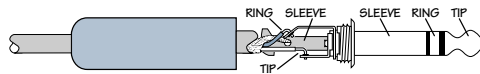

*Tip = left channel*  
*Ring = right channel*  
*Sleeve = common ground*

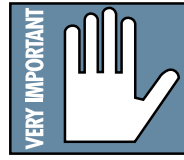
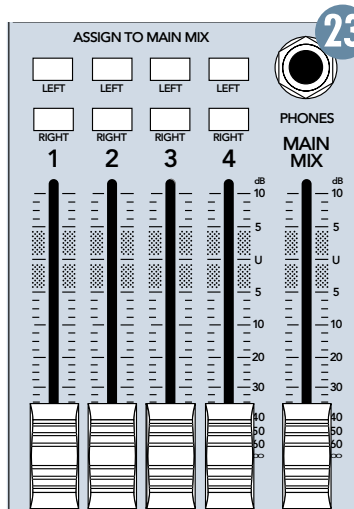

**WARNING:** When we say the headphone amp is loud, we're not kidding. It can cause permanent ear damage. Even intermediate levels may be painfully loud with some earphones. **BE CAREFUL!**

Always turn the CTL ROOM/PHONES knob all the way down before connecting headphones. Keep it down until you've put the phones on. Then turn it up slowly. Why? *"Engineers who fry their ears find themselves with short careers."*

### 24 TAPE OUTPUT

These unbalanced RCA jacks tap the MAIN MIX outputs to make simultaneous recording and PA work more convenient. Connect these to your 2-track recorder's inputs. *To learn how signals are routed to these outputs:* 54.

*Mono:* If you want to feed a mono signal to your tape deck or other device, simply use the 1/4" MONO output jack 28. Alternatively, use an RCA Y-cord to combine the TAPE OUTPUT jacks (Radio Shack® #274-511, for instance). Do not attempt this with any other outputs on the 1604-VLZ PRO.

### 25 TAPE INPUT

These unbalanced RCA jacks are designed to work with semipro as well as pro recorders. Connect your 2-track tape recorder's outputs here, using standard hi-fi RCA cables. *To learn how signals are routed from these inputs:* 58.

Use these jacks for convenient playback of your mixes. You'll be able to review a mix, and then rewind and try another pass without repatching or disturbing the mixer levels. You can also use these jacks with a portable tape or CD player to feed music to a PA system between sets 59.



**WARNING:** Pushing TAPE TO MAIN MIX in the output section can create a feedback path between TAPE INPUT and TAPE

OUTPUT. Make sure your tape deck is not in record, record-pause or input monitor mode when you engage this switch, or make sure the TAPE IN level knob is fully counterclockwise (off).

## 26 MAIN INSERT

These 1/4" jacks are for connecting serial effects such as compressors, equalizers, de-essers, or filters 18. The INSERT point is after the mix amps, but before the MAIN MIX fader. Insert cables must be wired thusly:

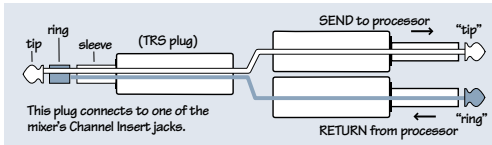

*Tip = send (output to effects device)*

*Ring = return (input from effects device)*

*Sleeve = common ground (connect shield to all three sleeves)*

## 27 MAIN OUTS

These 1/4" jacks are usually patched to the inputs of your 2-track mixdown deck (unless you've chosen to use the TAPE OUTPUT RCA jacks), or to the house amplifier during live sound sessions. To learn how signals are routed to these outputs: 54. To use these outputs to drive balanced inputs, connect 1/4" TRS (Tip-Ring-Sleeve) phone plugs like this:

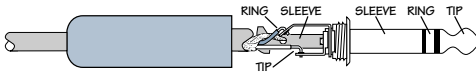

*Tip = + (hot)*

*Ring = - (cold)*

*Sleeve = ground*

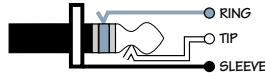

To use these outputs to drive unbalanced inputs, connect 1/4" TS (Tip-Sleeve) phone plugs like this:

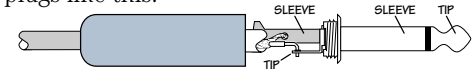

*Tip = signal*

*Sleeve = ground*



## 28 MONO OUTPUT

It happens to everybody sooner or later: The forces that govern your world will demand a monaural output from your painstakingly-created stereo panorama. The last thing you want to do is start twirling all your carefully-placed PAN settings to one side. What to do? Stick a cord in this 1/4" jack, hand the other end to Mr. Mono, and you're done. He's got his mono mix and you've still got your stereo mix. The MONO output is nothing more than a mix of the left and right MAIN MIX.

## 29 MONO LEVEL

So, Mr. Mono comes running back, screaming about the mono mix being so loud that his camcorder is melting. Just reach for this knob and turn it down a bit. Just the thing for send-

ing mono signals to mic inputs like camcorders, telephone interface boxes, even answering machines. With the pot all the way up (fully clockwise), you'll have 6dB of extra gain with unity gain halfway between the one and two o'clock positions.

## 31 POWER CONNECTION

Just in case you lose the cord provided with the 1604-VLZ PRO, its power jack accepts a standard 3-prong IEC cord like those found on most professional recorders, musical instruments, and computers. At the other end of our cord is — get this — a plug! Not a black cube or, as we're fond of calling them, a "wall wart." We did this for some very good reasons:

The 1604-VLZ PRO has sophisticated power requirements that a wall wart cannot provide. Wall warts are inconvenient, fragile, radiate huge hum fields, hog extra jacks on your power strip and get in the way. If you lose a wall wart, you're in trouble, but if you lose the 1604-VLZ PRO's power cord, you can get a new one at any electronics, music, or computer store. You can even buy them at Radio Shack® (part # 278-1257).

Plug the 1604-VLZ PRO into any standard grounded (3-pin) AC outlet or into a power strip of proper voltage.

**VERY IMPORTANT**  **WARNING: Disconnecting the plug's ground pin can be dangerous. Please don't do it.**

## 32 FUSE

The 1604-VLZ PRO is fused for your (and its own) protection. If you suspect a blown fuse, disconnect the power cord, pull the fuse drawer out (located just below the cord receptacle) and replace the fuse with a 1A SLO BLO, 5x20mm, available at electronics stores or your dealer (or a 500mA [0.5 amps] SLO BLO 5x20mm if your 1604-VLZ PRO is a 220V-240V unit).

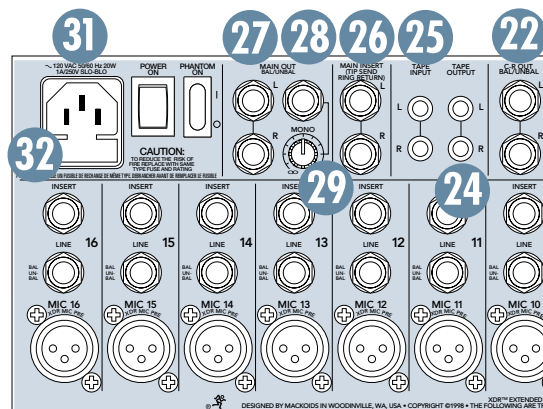

### 33 POWER SWITCH

If this one isn't self-explanatory, we give up. You can leave this switch on all the time; the 1604-VLZ PRO is conservatively designed, so heat buildup isn't a problem even in 24-hour-a-day operation. There's nothing that will burn out or get used up. You may notice that the 1604-VLZ PRO's "pod" feels quite warm (the pod is the chassis that contains the jacks). This is perfectly normal.

### 34 POWER LED

You've probably already figured this out, but if the POWER switch is on, this LED (light-emitting diode), located in the output section, will light. If the switch is off, well, you get the idea. If the POWER switch is on and the LED does not glow, one of three things has happened: Somebody tripped over the power cord and yanked it from the outlet, your electricity has been turned off due to nonpayment, or the fuse has blown 32.

### 35 PHANTOM SWITCH

The PHANTOM switch controls the phantom power supply for condenser microphones as discussed at the start of this section 11. When turned on (or off), the phantom power circuitry takes a few moments for voltage to ramp up (or down). This is also perfectly normal. For an even closer look, refer to **Appendix C**.

### 36 PHANTOM LED

Located right next to the POWER LED in the output section, this is just to let you know which way you have the PHANTOM switch set. If your dynamic mics work and your condensers don't, chances are this LED is off, so turn it on.

You'll notice that when you turn the phantom power off, the LED stays on for a while. This is a natural phenomenon — the LED is actually a yellow voltmeter telling you that the phantom power takes time to ramp itself down to zero volts. So, if you've turned phantom power off to connect something to the mic inputs, wait until the yellow LED stops glowing and then make your connections safely.

### 37 BNC LAMP SOCKET

Located in the top right corner of the output section, this 12V socket will drive any standard BNC-type lamp (a Littlite® #12G or #12G-HI (high-intensity), for instance).

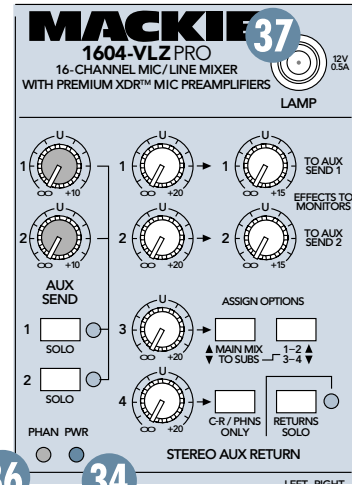

36

34

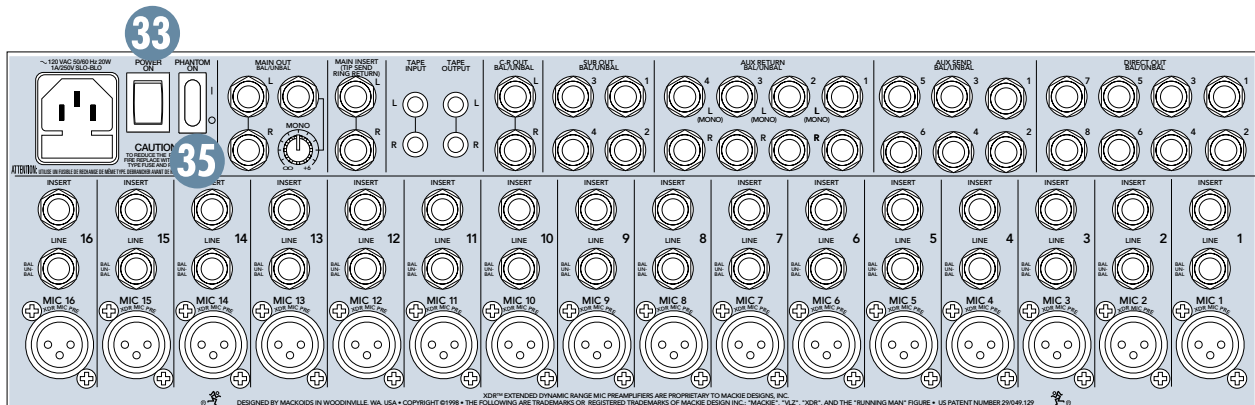



## 38 CHANNEL STRIP DESCRIPTION

The sixteen channel strips look alike and function identically. The only difference is that the eight on the left have **DIRECT OUT** jacks 15 and the eight on the right don't. We'll start at the bottom and work our way up.



### 39 "U" LIKE UNITY GAIN

Mackie mixers have a "U" symbol on almost every level control. This "U" stands for "unity gain," meaning no change in signal level. Once you have performed the **Level-Setting Procedure** 1, you can set every control at "U" and your signals will travel through the mixer at optimal levels. What's more, all the labels on our controls are measured in decibels (dB), so you'll know what you're doing level-wise if you choose to change a control's settings.

You won't have to check it here and check it there, as you would with some other mixers. In fact, some don't even have any reference to actual dB levels at all! Ever seen those "0–10" fader markings? We call these AUMs (Arbitrary Units of Measurement), and they mean nothing in the real world. You were smart — you bought a Mackie.

### 40 FADER

The fader is almost the last control in a channel's signal path. It's placed after the **EQ** and **MUTE** controls (post-EQ/post-MUTE and before the **PAN** control (pre-PAN)). The "U" mark, about three-quarters of the way up, indicates unity gain, meaning no increase or decrease of signal level. All the way up provides an additional 10dB, should you need to boost a section of a song. If you find that the overall level is too quiet or too loud with a fader near unity, you'll want to confirm the **TRIM** setting by performing the **Level-Setting Procedure** 1.



### A Clean Fade

Faders are not rocket science — they operate by dragging a metal pin (the wiper) across a carbon-based strip (the track). It is possible for airborne crud to land on the track. Should that happen, you may hear scratchy noises or signal dropouts as the wiper stumbles over the crud. Do all you can to keep airborne crud out of your profession. Use air conditioned rooms whenever possible, avoid smoking near the mixer, keep food and drink away from the mixer, and for pity's sake, never put the mixer in your kitchen! We also recommend "exercising" the faders — give them a few full-travel excursions once a week or so, and that will help scare the crud away. We do *not* recommend spray cleaners.

### 41 ASSIGN (1–2, 3–4, L–R)

Alongside each channel fader are four buttons, labeled **SOLO**, **1–2**, **3–4** and **L–R**. The latter three are collectively referred to as channel assignment switches. **1**, **3** and **L** are the left sides of these stereo pairs, and **2**, **4** and **R** are the right sides. Used in conjunction with the channel's **PAN** knob 46, these switches determine the destination of a channel's signal: With the **PAN** knob set at the center detent, the left and right sides receive equal signal levels. To feed only one side or the other, just turn the **PAN** knob accordingly.

If you're doing a mixdown to a 2-track, simply engage the **L–R** switch on each channel that you want to hear, and they'll be sent to the **MAIN MIX**. If you want to create a subgroup of certain channels, engage either the **1–2** or **3–4** switches instead of the **L–R**, and they'll be sent to the appropriate subgroup faders 56. From there, the subgroups can be sent back to the **MAIN MIX** 57, allowing you to use the subgroup faders as a master control for those channels.

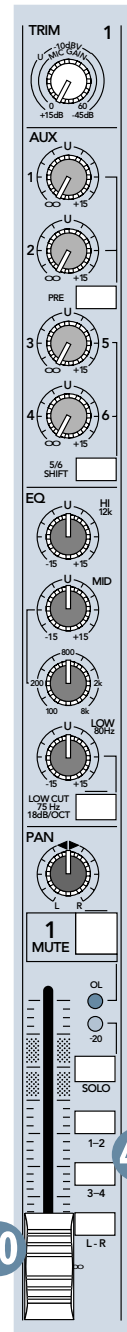

If you're printing new tracks or bouncing existing ones, you'll also use the 1–2 and 3–4 switches, but not the L–R switch. Here, you don't want the subgroups sent back into the MAIN MIX, but sent out, via the SUB OUTS jacks, to your multitrack inputs 16. However, if you're printing tracks via the DIRECT OUT jacks 15, all the channel assignment switches should be disengaged (up).

The 1604-VLZ PRO is what we call a “true 4-bus mixer.” Each channel can be assigned or unassigned to any of the subgroups without affecting the other subgroups or settings within the channel, and each subgroup has its own master fader 56 and dedicated output 21. In fact, since there are 4 subgroups *and* the MAIN L–R MIX, it's actually a true 6-bus mixer. We could have named it the CR1606-VLZ. Darn!

#### 42 SOLO

This lovable switch allows you to check signals through your PHONES output or C-R OUTS 42 without having to assign them to the L-R, 1-2 or 3-4 mixes. You can solo as many channels as you like. SOLO does not interrupt any of the other channels, buses or outputs — that's called nondestructive solo. Not only that, via the MODE switch 63, the 1604-VLZ PRO's solo system comes in two flavors: NORMAL (AFL) (sometimes called SIP, or solo-in-place) and LEVEL SET (PFL) (sometimes called PFL, or pre-fader-listen).

During NORMAL (AFL) mode, the soloed channel's signal is sent directly to the C-R OUTS, PHONES output, and meter display just as it would sound to the channel's assignment switches: post-EQ, post-fader and post-PAN. The only difference is that SOLO works regardless of the channel's assignment positions, and that makes it really handy — you can check out a channel before you assign it.

NORMAL (AFL) is the preferred mode during mixdown: If the channel has some midrange boost at 4.236kHz, is panned a smidgen to the left, and its fader is at –5.385dB, that's exactly what you'll hear if you SOLO during NORMAL (AFL) mode. It's just as if you took the time to MUTE all the other channels.

LEVEL SET (PFL) solo is the key player in the all-important **Level-Setting Procedure 1**. It'll send the channel's actual internal levels to the meters so you'll know just what's going on, level-wise. This procedure should be performed every time a new sound source is patched into a channel's MIC or LINE input jacks.

LEVEL SET (PFL) is also the preferred mode for SR (sound reinforcement, or live sound), to preview channels before they are let into the mix. It won't give you stereo placement, but will give you signal even if the fader is pulled down.

Remember, LEVEL SET (PFL) taps the channel signal before the fader. If you have a channel's fader set way below “U” (unity gain), SOLO won't know that and will send a unity gain signal to the C-R OUTS, PHONES output and meter display. That may result in a startling level boost at these outputs, depending on the position of the SOLO level knob 65.

In a nutshell, soloed channels are sent to the SOURCE mix 61, that ultimately feeds your C-R OUTS, PHONES output and meter display. Whenever SOLO is engaged, all SOURCE selections (MAIN MIX, 1–2, 3–4 and TAPE) are defeated, to allow the soloed channel to do just that — SOLO!

#### 43 –20 (SOLO) LED

An LED that does two completely different things! Saves space, but requires some explanation. First, the “–20” part: Often referred to as “signal activity,” this LED will flicker in time with the signal present in that channel. It's handy for confirming that a channel is indeed active, and may also lend a clue as to what the signal is. For instance, a kick drum will cause the LED to pulse in time with the drum, and a synth pad will cause it glow a bit more steadily.

Now for the “SOLO” part. When a channel's SOLO switch is engaged, this LED will glow steadily, without flickering. It will also be brighter than it would be as a –20 indicator. In conjunction with the RUDE SOLO LIGHT 66, you can find a rogue SOLO switch very quickly.

#### 44 OL (MUTE) LED

Another LED that does two completely different things! First, the “OL” part: “OL” means overload, or clip. You don't want that to happen. Ever. Clipping can happen to any mixer — it's the point where the signal's voltage exceeds the supply voltages that power the circuitry. The 1604-VLZ PRO's OL LED will come on just before clipping, so if you see it, take immediate action: Perform the **Level-Setting Procedure 1**. If that doesn't help, check for excessive use of EQ boost or fader gain. Like the –20 LED, it will tend to flicker in time with that channel's signal.

Now for the “MUTE” part. Assuming your levels are set correctly, the OL LED will never

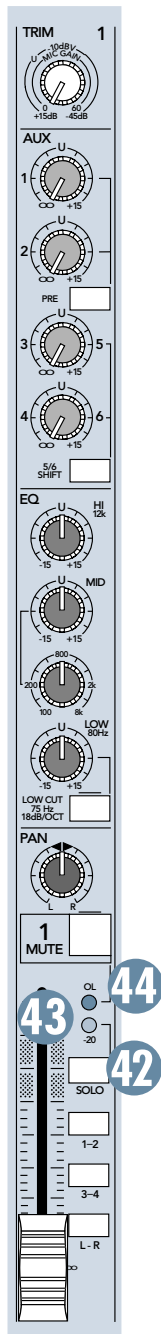

come on as a result of clipping. That's pretty boring. So, to liven things up, this LED will glow steadily when that channel's MUTE switch is engaged.

If you need a quick reference to these LEDs, write this on the back of your hand:

name	color	flickering	glowing
-20 (SOLO)	green	signal is present	channel is soloed
OL (MUTE)	red	channel is clipping	channel is muted

#### 45 MUTE

Engaging a channel's MUTE switch provides the same results as turning the fader all the way down: Any channel assignment to L-R, 1-2 or 3-4 will be interrupted. All the *post* AUX sends 17 will be silenced, as will the DIRECT OUT signals on channels 1 through 8. And of course, that fun-loving OL (MUTE) LED will commence to glow. The PRE AUX sends 51, channel INSERT send 14 and SOLO (in LEVEL SET (PFL) mode) will continue to function during MUTE.

Depending on the audio content in a channel, engaging its MUTE switch may cause a slight popping sound. This is not a problem within the mixer, and it can be avoided: Simply engage the LOW CUT switch 43 on each channel (unless its low frequency content is vitally important, such as a kick drum or bass guitar). LOW CUT eliminates subsonic debris, which causes the pop, and its effect is usually transparent.

#### 46 PAN

PAN adjusts the amount of channel signal sent to the left versus the right outputs. Pan determines the fate of the L-R assignment, subgroups 1-2 and 3-4, and the SOLO (in LEVEL SET (PFL) mode). With the PAN knob hard left, the signal will feed the left MAIN MIX, subgroup 1, subgroup 3 and left NORMAL (AFL) solo mode (assuming their assignment switches are engaged). With the knob hard right, signal feeds the right MAIN MIX, subgroup 2, subgroup 4 and right NORMAL (AFL) solo mode. With the PAN knob set somewhere in-between left and right, the signal will be divided between the left and right busses.

#### Stereo Sources

Your life will be easier if you follow this standard convention: When patching stereo sound sources to a mixer, always plug the left signal into an "odd" channel (1, 3, 5, etc.) and the right signal into the adjacent "even" channel (2, 4, 6, etc.). Then pan the odd channel hard left and the even channel hard right.



#### CONSTANT LOUDNESS !!!

The 1604-VLZ PRO's PAN controls employ a design called "Constant Loudness." It has nothing to do with living next to a freeway. As you turn the PAN knob from left to right (thereby causing the sound to move from the left to the center to the right), the sound will appear to remain at the same volume (or loudness).

If you have a channel panned hard left (or right) and reading 0dB, it must dip down about 4dB on the left (or right) when panned center. To do otherwise, like those Brand X mixers, would make the sound appear much louder when panned center.

#### 47 3-BAND MID-SWEEP EQ

The 1604-VLZ PRO has a 3-band, mid-sweep equalization: LOW shelving at 80Hz, MID sweep peaking from 100Hz to 8kHz, and HI shelving at 12kHz. It's probably all the EQ you'll ever need! (Shelving means that the circuitry boosts or cuts all frequencies past the specified frequency. For example, the 1604-VLZ PRO's LOW EQ boosts bass frequencies starting at 80Hz and continuing down to the lowest note you never heard. Peaking means that certain frequencies form a "hill" around the center frequency.)

The LOW EQ provides up to 15dB boost or cut at 80Hz. The circuit is flat (no boost or cut) at the center detent position. This frequency represents the punch in bass drums, bass guitar, fat synth patches, and some really serious male singers.

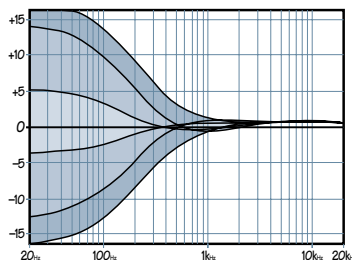

Used in conjunction with the LOW CUT switch 43, you can boost the LOW EQ without injecting a ton of subsonic debris into the mix. We recommend using the LOW CUT feature on all channels, except low frequency signals, like kick drums and bass guitars.

The MID EQ, or "midrange," has a fixed bandwidth of 1.5 octaves. The MID knob sets the amount of boost or cut, up to 15dB, and is effectively bypassed at then center detent. The frequency knob sets the center frequency, sweepable from 100Hz to 8kHz.

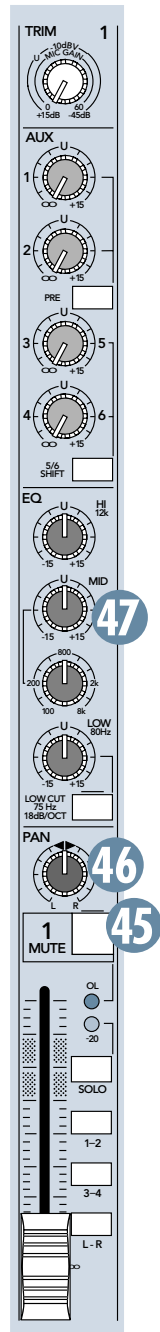

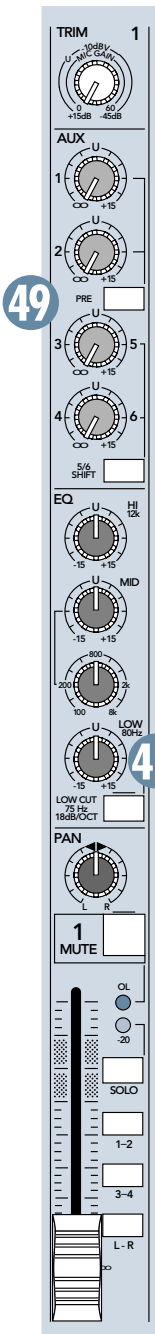

49

48

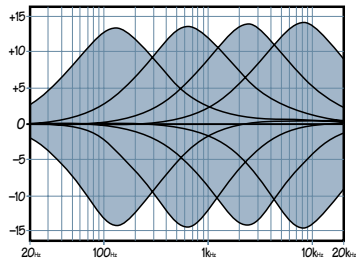
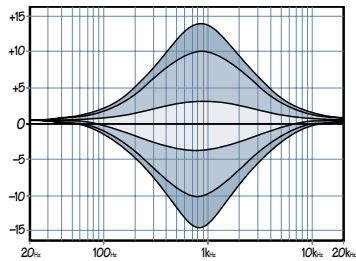

Most of the root and lower harmonics that define a sound are located in the 100Hz–8kHz frequency range, and you can create drastic changes with these two knobs. Many engineers use MID EQ to cut midrange frequencies, not boost them. One popular trick is to set the MID fully up, turn the frequency knob until you find a point where it sounds just terrible, then back the MID down into the cut range, causing those terrible frequencies to disappear. Sounds silly, but it works. Sometimes.

The HI EQ provides you up to 15dB boost or cut at 12kHz, and it is also flat at the detent. Use it to add sizzle to cymbals, an overall sense of transparency, or an edge to keyboards, vocals, guitar and bacon frying. Turn it down a little to reduce sibilance or to mask tape hiss.

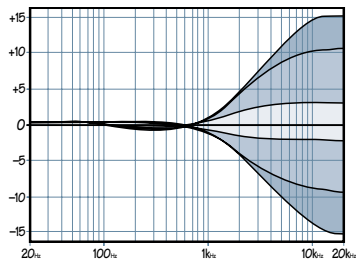

With too much EQ, you can screw things up royally. We've designed a lot of boost and cut into each equalizer circuit because we know everyone will occasionally need that. But if you max the EQ on every channel, you'll get mix mush. Equalize subtly and use the left sides of the knobs (cut), as well as the right (boost). If you find yourself repeatedly using full boost or cut, consider altering the sound source, such as placing a mic differently, trying a different kind of mic, changing the strings, or gargling.

## 48 LOW CUT

The LOW CUT switch, often referred to as a high pass filter (all depends on how you look at it), cuts bass frequencies below 75Hz at a rate of 18dB per octave. This ain't no thrown-in dime-store filter — an 18dB per octave curve requires an elaborate circuit. Nothing but the best for you.

We recommend that you use LOW CUT on every sound source except kick drum, bass guitar, bassy synth patches, or recordings of earthquakes. These aside, there isn't much down there that you want to hear, and filtering it out makes the low stuff you do want much more crisp and tasty. Not only that, but low cut can help reduce the possibility of feedback in live situations, and it helps to conserve amplifier power.

With LOW CUT, you can safely boost LOW EQ 47. Many times, bass shelving eq can really benefit voices. Trouble is, adding LOW EQ also boosts the subsonic debris: Stage rumble, mic handling clunks, wind noise and breath pops. LOW CUT removes all that debris so you can boost the LOW EQ without frying your woofer. Here's a frequency curve of LOW EQ combined with LOW CUT:

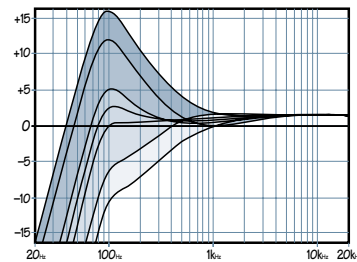

## 49 AUX 1, 2, 3, & 4

These four knobs tap a portion of each channel's signal, mix them together and send them to the AUX SEND outputs 17. They are off when turned fully down, deliver unity gain at the center detent, and can provide up to 15dB of gain turned fully up. Chances are you'll never need this extra gain, but it's nice to know it's there if you do.

The AUX SEND output are then patched to parallel effects processor inputs 18 or stage monitor amp inputs. AUX SENDS 1 and 2 levels are controlled not only by the channel's AUX knobs, but also by the AUX SEND master knobs 69.

AUX SENDS can also be used to generate separate mixes for recording or "mix-minuses" for broadcast. By using AUX 1 or 2 in the PRE mode 51, these mix levels can be obtained independently of a channel's fader settings.

We recommend going into a stereo reverb in mono and returning in stereo. We have found that on most “stereo” reverbs, the second input just ties up an extra aux send and adds nothing to the sound. There are exceptions, so feel free to try it both ways. Should you choose to use two aux sends, use the “odd” AUX (1, 3 or 5) to feed its left input and the “even” AUX (2, 4 or 6) to feed the right input. Remember, if you’re also dealing with a stereo source signal, you’ll want to follow the sides — use the odd AUX on the channel carrying the left side and the even AUX on the channel carrying the right.

### 51 PRE

This switch determines the tap point of AUX 1 and 2. Generally, “post” sends are used to feed effects devices, and “pre” sends are used to feed your stage monitors. See the “Pre vs. Post” diagram below. AUX 3 through 6 are always in post mode.

In post mode (switch up), AUX 1 and 2 will follow the EQ, LOW CUT, fader and MUTE settings. If you fade the channel, you fade the send. This is a must for effects sends, since you want the levels of your “wet” signals to follow the level of the “dry.”

In PRE mode (switch down), AUX 1 and 2 follow the TRIM and LOW CUT settings only. EQ, PAN, fader and MUTE settings have no effect on the PRE sends. This is the preferred method for setting up stage monitor feeds — they’ll be controlled independently of the fader and mute moves.

### 52 5/6 SHIFT

Don’t let the fact that there’s only four AUX knobs per channel fool you — the 1604-VLZ PRO has six AUX SENDS. With the 5/6 SHIFT switch up, the knobs labeled AUX 3 and AUX 4 deliver their signals to AUX SEND 3 and 4 outputs. With the shift switch down, the signals appear at the AUX SEND 5 and 6 outputs.

We recommend that AUX SEND 3 and 4 be patched into your “utility” effects, like a short reverb and slap delay; effects you use all the time. Use AUX SEND 5 and 6 for “exotic” effects, like harmonizers and multi-tap delays; they are not likely to be used as often.

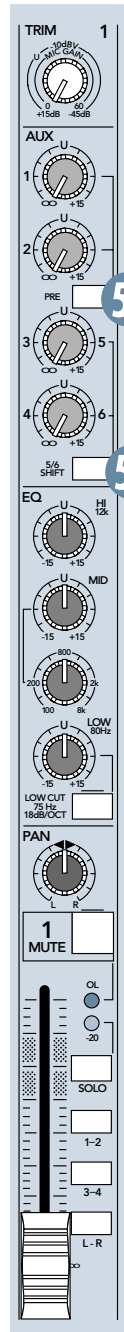
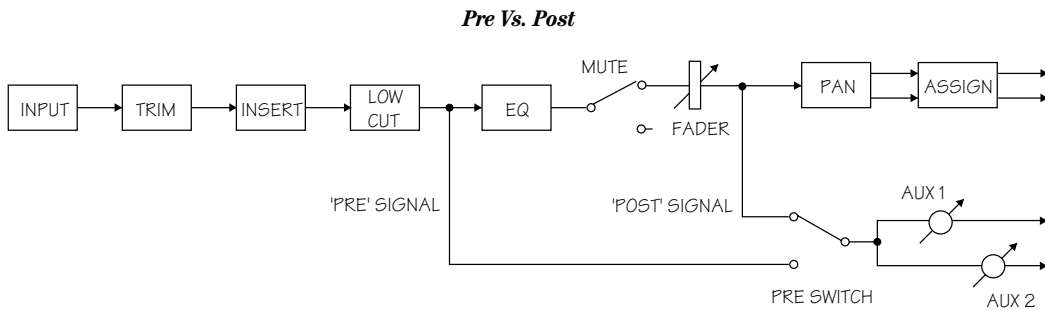

## 53 OUTPUT SECTION DESCRIPTION

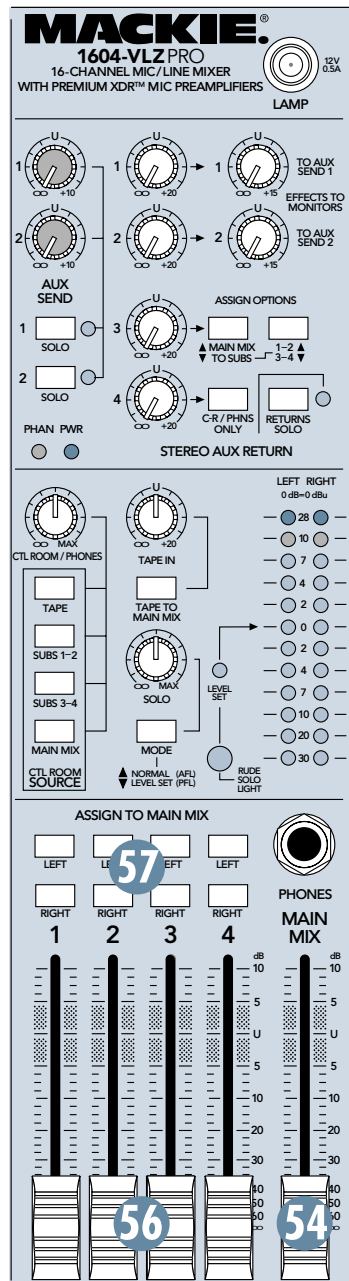

You've just learned about the input channels and how the signals get in and out. The signals come in via MIC and LINE input jacks, are manipulated by the channels, and then sent to the output section. In the output section, things get a bit more complicated, so put on your thinking caps.

### 54 MAIN MIX FADER

This fader controls the levels of signals sent to the MAIN OUT 1/4" TRS jacks (27) and TAPE OUTPUT RCA jacks (24). All channels and AUX RETURNS that are assigned to the MAIN MIX, not muted and not turned fully down will appear at the MAIN OUT. Before the main mix gets to this fader, the signals pass through the MAIN INSERT (26).

The MAIN MIX signals are off with the fader fully down, the "U" marking is unity gain, and fully up provides 10dB additional gain. This additional gain will typically never be needed, but once again, it's nice to know it's there. The fader itself is a stereo version of the channel and subgroup faders — same supersmooth custom taper, same dead silence when turned fully down. This is the fader to pull down at the end of the song when you want "The Great Fade-Out."

At Mackie, audio quality is much more important than the price of wall warts. All of our mixers now employ VLZ and built-in power supplies that deliver more than enough current, resulting in sonic specifications that rival consoles upwards of \$50,000!

### 56 SUBGROUP FADERS

As you might expect, these faders control the levels of signals sent to the SUB OUTS. All channels that are assigned to subgroups, not muted and not turned fully down will appear at the SUB OUTS. Unlike the MAIN OUT, the subgroup signals do *not* pass through an insert jack on their way to the subgroup faders. That's no problem — should you want to send these signals through a serial effects processor, simply patch from the SUB OUTS to the effect's input, and from the effect's output to whatever the final destination is, usually a multitrack recorder.

The subgroup signals is off when its fader is fully down, the "U" marking is unity gain, and fully up provides 10dB additional gain. Remember that if you're treating two subgroups as a stereo pair, subgroup 1 and 2 for example, make sure that both subgroup faders "ride" together, to maintain the left/right balance.

### 57 ASSIGN TO MAIN MIX

One popular use of the subgroups is to use them as master faders for a group of channels on their way to the MAIN MIX. Let's say you've got a drum kit hogging up seven channels and you're going to want to fade them out at a different rate than the other channels. You don't want to try that with seven hands or seven fingers, so just un-assign these channels from L-R, reassign them to subgroup 1-2, engage the ASSIGN TO MAIN MIX, LEFT on subgroup 1 and the ASSIGN TO MAIN MIX, RIGHT on subgroup 2. Now you can ride the entire stereo drum mix with two faders — 1 and 2.

If you engage just one ASSIGN TO MAIN MIX switch per subgroup (LEFT or RIGHT), the signal sent to the MAIN MIX will be the same level as the SUB OUTS. If you want the subgroup to appear in the center of the main mix, engage both the ASSIGN TO MAIN MIX, LEFT and ASSIGN TO MAIN MIX, RIGHT switches. The signal will be sent to both sides, and will be attenuated just enough to preserve constant loudness (46), just like the channel PAN knobs when set center.



### 55 VLZ MIX ARCHITECTURE

When designing a mixing circuit, the lowest noise and best crosstalk specs are achieved by using Very Low Impedance (VLZ). To implement VLZ in a mixer, the power supply must be able to deliver plenty of current to the circuitry. That's why those "wall wart" mixers are often noisy — they can't power a VLZ circuit.

## 58 TAPE IN (LEVEL)

This knob controls the level of the stereo signal coming from the TAPE INPUT RCA jacks. Its range is off when fully down, unity at the center detent, with 20dB additional gain turned fully up, which may come in handy if you've patched in a "walkperson" type device with wimpy output levels. After the TAPE IN level is determined, the stereo tape signal can be sent to either of two places — the MAIN MIX or the SOURCE matrix 61.

## 59 TAPE TO MAIN MIX

Engaging this switch is just like engaging the L-R switch on a channel — the signal, stereo in this case, is sent to the MAIN MIX. It does not interrupt other signals, just adds itself to them. This switch can be very handy in a live sound situation when you want to play soothing elevator music to an anxious crowd.



**WARNING: Engaging TAPE TO MAIN MIX can create a feedback path between TAPE INPUT and TAPE OUTPUT. Make sure**

**your tape deck is not in record, record-pause or input monitor mode when you engage this switch, or that the TAPE IN level knob is turned fully down.**

## 61 SOURCE

Typically, the engineer sends the main mix to an audience (if live) or to a mixdown deck (if recording). But what if the engineer needs to hear something other than the main mix? With the New Improved 1604-VLZ PRO, the engineer has several choices of what to listen to. This is one of those tricky parts — have a double espresso first.

Via the SOURCE switches, you can choose to listen to any combination of MAIN MIX, SUBS 1-2, SUBS 3-4 and TAPE. Selections made in the SOURCE matrix deliver stereo signals to the C-R OUTS, PHONES output and meter display. These signals are tapped after their respective level controls — post-MAIN MIX fader, post subgroup faders and post-TAPE IN knob. With no switches engaged, there will be no signal at these outputs and no meter indication, with two exceptions (SOLO 42/65 and AUX RETURN 4 76).

One of those exceptions is the SOLO function 42/65. Regardless of the SOURCE matrix selection, engaging a SOLO switch will replace that selection with the SOLO signal, also sent to the C-R OUTS, PHONES output and meter display. This is what makes the **Level-Setting Procedure 1** so easy to do.

Now you know how to select the signals you want to send to the engineer's control room and/or phones. From there, these signals all pass through the same level control, aptly named:

## 62 CTL ROOM/PHONES

As you might expect, this knob controls the levels of both the stereo C-R OUTS 22 and PHONES output 23. The control range is from off through unity gain at the detent, with 10dB of extra gain (when turned fully clockwise).

When MAIN MIX is your SOURCE selection, those signals will now pass through two level controls on the way to your control room amp and headphones — the MAIN MIX fader and this CTL ROOM/PHONES knob. This way, you can send a nice healthy level to the MAIN OUT jacks (MAIN MIX fader at "U"), and a quieter level to the C-R OUTS or PHONES (CTL ROOM/PHONES knob wherever you like it).

Whatever your selection, you can also use the C-R OUTS for other applications. Its sound quality is just as impeccable as the MAIN OUT outputs. It can be used as additional main mix output and this one will have its own level control. However, should you do this, be aware that if you engage a SOLO switch, that will interrupt the mix, as we've already covered 42.

Once again, engaging a SOLO switch 42 will cause this dramatic turn of events: Any existing SOURCE matrix selections will be replaced by the SOLO signals, appearing at the C-R OUTS, PHONES output and at the meter display. The audible solo levels are controlled by the SOLO level knob. The SOLO levels appearing on the meter display 67 are not controlled by anything — you wouldn't want that. You want to see the actual channel level on the meter display, regardless of how loud you're listening.

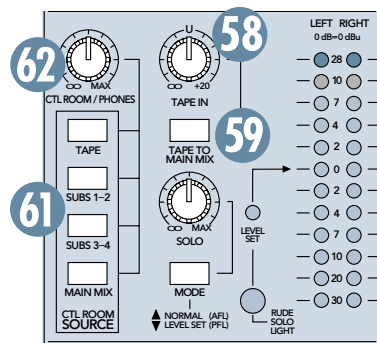

## 63 MODE (NORMAL (AFL)/LEVEL SET (PFL))

You may have already seen this, but in case you missed it: The 1604-VLZ PRO's solo system comes in two flavors: **NORMAL (AFL)** (sometimes called SIP, or solo-in-place) and **LEVEL SET (PFL)** (sometimes called PFL, or pre-fader-listen).

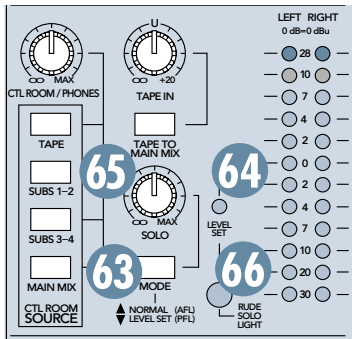

In **NORMAL (AFL)**, the soloed channel's signal is sent directly to the **C-R OUTS**, **PHONES** output and meter display just as it would sound to the channel's assignment switches: post-EQ, post-fader and post-PAN. The only difference is that **SOLO** works regardless of the channel's assignment positions, and that makes it really handy — you can

check out a channel before you assign it.

**NORMAL (AFL)** is the preferred mode during mixdown: If the channel has some midrange boost at 4.236kHz, is panned a smidgen to the left, and its fader is at  $-5.385\text{dB}$ , that's exactly what you'll hear if you **SOLO** during **NORMAL (AFL)** mode. It's just as if you took the time to **MUTE** all the other channels.

**LEVEL SET (PFL)** solo is the key player in the all-important **Level-Setting Procedure 1**. It'll send the channel's actual internal levels to the meters so you'll know just what's going on, level-wise. This procedure should be performed every time a new sound source is patched into a channel's **MIC** or **LINE** input jacks.

**LEVEL SET (PFL)** is also the preferred mode for **SR** (sound reinforcement, or live sound), to preview channels before they are let into the mix. It won't give you stereo placement, but will give you signal even if the fader is turned down.

Remember, **LEVEL SET (PFL)** taps the channel signal before the fader. If you have a channel's fader set way below "U" (unity gain), **SOLO** won't know that and will send a unity gain signal to the **C-R OUTS**, **PHONES** output and meter display. That may result in a startling level boost at these outputs, depending on the position of the **SOLO** level knob 65.

## 64 LEVEL SET LED

To quote step 6 of the **Level-Setting Procedure 1**, "Push in the **MODE** switch in the output section (**LEVEL SET (PFL)** mode) — the **LEVEL SET LED** will light." When the solo **MODE** switch is engaged, it's in **LEVEL SET (PFL)** mode, the mode you must be in to set levels. Now, when you engage any solo switch, this LED will be a "green light" to set levels. If you tried to set levels during **NORMAL (AFL)** mode, the meter display would be at the mercy of the channel fader, and that would be a big problem.

## 65 SOLO (LEVEL)

This knob controls the level of the signals coming from the **SOLO** system. Its range is off when fully down, unity at the center detent, with 10dB additional gain turned fully up. After the **SOLO** level is determined, the **SOLO** signals will proceed to take over the **C-R OUTS**, **PHONES** output and meter display 61.

Once again, **LEVEL SET (PFL)** **SOLO** taps the channel signal before the fader. If you have a channel's fader set way below "U" (unity gain), **LEVEL SET (PFL)** **SOLO** won't know that and will send a unity gain signal to the **C-R OUTS**, **PHONES** output and meter display. That may result in a startling level boost at these outputs, depending on the position of the **SOLO** level knob.

## 66 RUDE SOLO LIGHT

This flashing LED (light emitting diode) serves two purposes — to remind you that you're in **SOLO**, and to let you know that you're mixing on a Mackie. No other company is so concerned about your level of **SOLO** awareness. We even force the soloed channel's  $-20$  LED to play along, so you can find that rogue switch fast.

If you work on a mixer that has a **SOLO** function with no indicator lights, and you happen to forget you're in **SOLO**, you can easily be tricked into thinking that something is wrong with your mixer. Hence the **RUDE SOLO LIGHT**. It's especially handy at about 3:00 in the morning, when no sound is coming out of your monitors, even though your multi-track is playing back like mad.



## 67 METERS

The 1604-VLZ PRO's peak metering system is made up of two columns of twelve LEDs. Deceptively simple, considering the multitude of signals that can be monitored by it. If nothing is selected in the SOURCE matrix 61 and no channels are in SOLO, the meter display will just sit there. To put them to work, you must make a selection in the SOURCE matrix (or engage a SOLO switch).

Why? You want the meter display to reflect what the engineer is listening to, and as we've covered, the engineer is listening either to the C-R OUTS or the PHONES output. The only difference is that while the listening levels are controlled by the CTL ROOM/PHONES knob, the meter display reads the SOURCE mix before that control, giving you the real facts at all times, even if you're not listening at all.

When the solo MODE switch is set to LEVEL SET (PFL) (down) 63, all soloed signals will be sent to the left meter only. That, combined with LEVEL SET LED 64, are along the path of enlightenment known as the **Level-Setting Procedure** 1. During NORMAL (AFL) mode, the meters will behave normally.



### Meters vs. Reality

You may already be an expert at the world of “+4” (+4dBu=1.23V) and “-10” (-10dBV=0.32V) operating levels. Basically, what makes a mixer one or the other is the relative 0dB VU (or 0VU) chosen for the meter display. A “+4” mixer, with a +4dBu signal pouring out the back will actually read 0VU on its meter display. A “-10” mixer, with a -10dBV signal trickling out, will read, you guessed it, 0VU on its meter display. So when is 0VU actually 0dBu? Right now!

At the risk of creating another standard, Mackie's compact mixers address the need of both crowds by calling things as they are: 0dBu (0.775V) at the output shows as 0VU on the meter display. What could be easier? By the way, the most wonderful thing about standards is that there are so many to choose from.

Thanks to the 1604-VLZ PRO's wide dynamic range, you can get a good mix with peaks flashing anywhere between -20 and +10dB on the meter display. Most amplifiers clip at about +10dB, and some recorders aren't so forgiving either. For best real-world results, try to keep your peaks between “0” and “+7.”

Please remember: Audio meter displays are just tools to help assure you that your levels are “in the ballpark.” You don't have to stare at them (unless you want to).

## 68 AUX TALK

First of all, there is no particular alliance between AUX SEND 1 and AUX RETURN 1. They're just numbers. They're like two complete strangers, both named Fred.

*Sends* are outputs, *returns* are inputs. The AUX knob 49 taps the signal off the channel and sends it to the AUX SEND outputs 17. AUX 1 and 2 are sent to the AUX SENDS 1 and 2 master knobs before the AUX SEND outputs and AUX 3 through 6 are sent directly.

These outputs are fed to the inputs of a reverb or other device. From there, the outputs of the external device are fed back to the mixer's AUX RETURN inputs 19. Then these signals are sent through the AUX RETURN level controls, and finally delivered to the MAIN MIX.

So, the original “dry” signals come from the channels to the MAIN MIX and the affected “wet” signals come from the AUX RETURNS to the MAIN MIX, and once mixed together, the dry and wet signals combine to create a glorious sound. Armed with this knowledge, let's visit the Auxiliary World:

## 69 AUX SENDS (MASTER)

These knobs provide overall level control of AUX SENDS 1 and 2, just before they're delivered to their AUX SEND outputs 17. This is perfect for controlling the level of stage monitors, since you'll be using AUX 1 and 2 for this, with their PRE switches engaged 51. AUX SENDS 3 through 6 have no such control — they'll just send their mixes directly to their respective AUX SEND outputs at unity gain.

This knob goes from off (turned fully down), to unity gain at the center detent, with 10dB of extra gain (turned fully up). As with some other level controls, you may never need the additional gain, but if you ever do, you'll be glad you bought a Mackie.

This is usually the knob you turn up when the lead singer glares at you, points at his stage monitor, and sticks his thumb in the air. (It would follow suit that if the singer stuck his thumb down, you'd turn the knob down, but that never happens.)

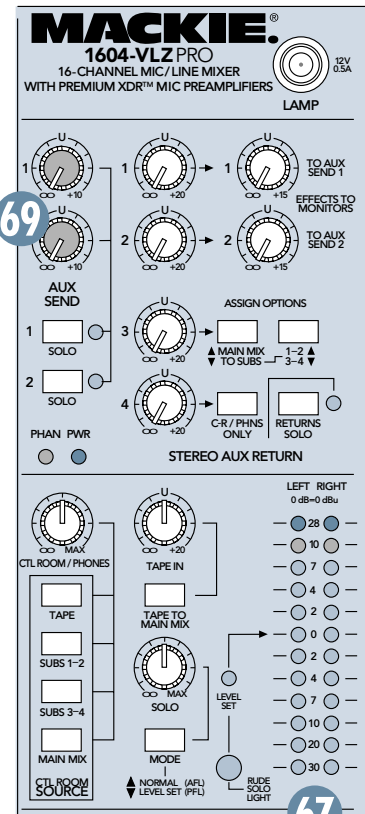

## 71 AUX SENDS SOLO

Once again, in a live sound situations AUX SEND 1 and 2 are likely to feed your stage monitors. You'll want to check the mix you're sending them, and that's what these two buttons are for. (AUX 3 through AUX 6 have no such switch.) Beside each switch is a green LED that, just like the channel's -20 LED 43, helps you find the rogue SOLO switch.

The only thing different about AUX SENDS SOLO is that it's not really PFL (pre-fader listen), and it's not really SIP (solo-in-place), it's actually AFL (after-fader listen, and yes, we know there's no fader in this case.) During NORMAL (AFL) mode 63, you'll get AUX SEND 1's solo signal, post-AUX SENDS master level, in the left side of the C-R OUTS, PHONES output and meter display, and AUX SEND 2 on the right side. (If you ever use AUX 1 and 2 to create a stereo monitor mix, you'll understand why.) In LEVEL SET (PFL) mode, you'll get the signal dead-center, but still post-AUX SENDS master level.

## 72 AUX RETURNS (LEVEL)

These four controls set the overall level of effects received from the stereo AUX RETURN input jacks 19. These controls are designed to handle a wide range of signal levels — each knob goes from off, to unity gain at the detent, to 20dB gain fully clockwise, to compensate for

low-level effects. Signals passing through the STEREO AUX RETURN level controls will proceed directly to the MAIN MIX fader 54, with exceptions that we'll discuss in a moment.

Typically, these knobs can just live at the center detent, and the effects device's output control should be set at whatever they call unity gain (check their manual). If that turns out to be too loud or too quiet, adjust the effects device's outputs, not the mixer. That way, the mixer's knobs are easy to relocate at the center detent.

## 73 EFFECTS TO MONITORS

If you want to add reverb or delay to the stage monitor mixes, these are the knobs for you. Operating independently of their respectively numbered AUX RETURNS level controls, these knobs are exactly the same as the AUX 1 and AUX 2 knobs found in the channel strip 49.

These two knobs feed AUX RETURN signals to their respective AUX SEND outputs 17: TO AUX SEND 1 feeds AUX RETURN 1 to AUX SEND 1 master, and TO AUX SEND 2 feeds AUX RETURN 2 to AUX SEND 2 master. They are off when turned fully down, deliver unity gain at the center detent, and can provide up to 15dB of gain turned fully up. AUX RETURN 3 and AUX RETURN 4 have no such knobs.

## 74 MAIN MIX TO SUBS (AUX RET 3)

With this switch up, AUX RETURN 3 behaves like all the others — it delivers a stereo signal, regulated by its level knob, to the MAIN MIX 54. When you engage this switch, the signals are removed from the MAIN MIX buses and sent to the 1-2/3-4 switch, which diverts the signal once more. We're not finished. Please read on.

## 75 1-2/3-4 (AUX RET 3)

As you've just read, if the MAIN MIX TO SUBS switch is disengaged, the 1-2/3-4 switch does absolutely nothing. Let's now assume it's engaged. AUX RETURN 3's stereo signal will not be sent to the MAIN MIX, but to subgroup faders 1 and 2 (1-2/3-4 switch up) or subgroup faders 3 and 4 (switch down).

Let's say you've made a stereo drum submix on subgroup faders 1 and 2, so you can ride those two faders instead of the seven channels that the drums came from. Subgroup fader 1 has its ASSIGN TO MAIN MIX, LEFT button engaged and subgroup fader 2 has its ASSIGN TO MAIN MIX, RIGHT button engaged, blending the drum submix back into the MAIN MIX. The drum channels are also sending signals to your reverb via the AUX sends and the reverb outputs are patched into AUX RETURN 3. So far so good.

Even though you could send AUX RETURN 3 directly to the MAIN MIX (MAIN MIX TO SUBS switch up), you don't want to. Instead, engage the MAIN MIX TO SUBS switch and make sure the 1-2/3-4 switch is up. Now the reverb return will be blended into the drum submix, and as you ride those two faders, the reverb level will follow.

Why do we want that? Because if you had just sent the reverb directly to the MAIN MIX

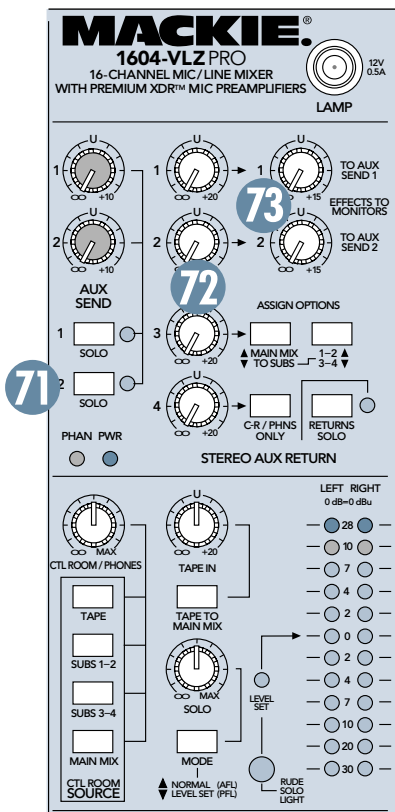

(MAIN MIX TO SUBS switch up) and you did a drum fade-out using subgroup faders 1 and 2, the “dry” signals would fade out, but the “wet” signals would keep on singing. All you would hear is the drum reverb (the “wet”), and none of the original drum signals (the “dry”). That’s because the reverb is being fed by the channel’s AUX sends, and they have no idea that you’ve pulled down the subgroup faders. That’s why we threw in these switches.

### 76 C-R/PHNS ONLY (AUX RET 4)

Once again, the default for all the STEREO AUX RETURNS is to feed them directly into the MAIN MIX. You’ve just learned about the optional exceptions involving AUX RETURN 3. AUX RETURN 4 also has an optional exception: By engaging the C-R/PHNS switch, you will remove AUX RETURN 4’s stereo signal from the MAIN MIX and send it directly to the CTL ROOM/PHONES SOURCE matrix 61. It matters not if any of the SOURCE matrix switches are assigned, but it will be interrupted, as usual, if a SOLO switch is engaged.

Let’s pretend you’re doing a live mix to a 2-track deck, a house PA, or both, and you want to play along to a click track. You could run the click track directly into the MAIN MIX, but you don’t want the mixdown deck and/or audience to hear it. By gum, this is the switch for you. Similarly, it can be used for voice-over tracks, narration, anything you want heard by the engineer and players but not by the audience and mixdown deck.

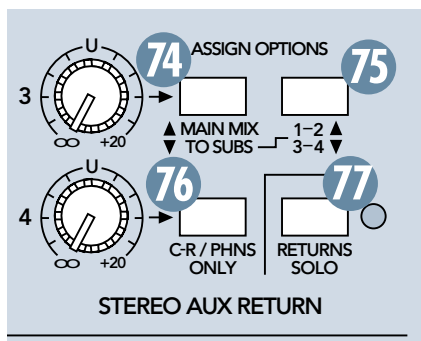

### 77 RETURNS SOLO

This switch operates just like the channel SOLO switches — engaging it sends signals to the C-R OUTS, PHONES output and meter display and interrupts whatever happened to be there before you soloed. It follows the MODE switch 63 setting as well. The only difference is that when you engage the RETURNS SOLO switch, it sends all four STEREO AUX RETURNS signals to the SOLO circuit.

Assume you want to solo the snare drum. Hit that channel’s SOLO switch, and you get the “dry” (no effects) snare only. That helps, but you want to hear it with the reverb you have patched into an AUX RETURN. Leaving that channel’s SOLO switch engaged, also engage the RETURNS SOLO switch, and now you’ll get the dry snare *and* its reverb.

Since it is a global feature, you’ll also get the signals from all the other AUX RETURNS, so there may be some sounds that you didn’t want to hear. If they offend your sensibilities, simply turn down the levels of the STEREO AUX RETURNS you don’t want to hear, or MUTE the channels feeding the unwanted signal to the effects device you *do* want to hear.

*Congratulations!* You’ve just read about all the features of your 1604-VLZ PRO. You’re probably ready for a cold one. Go ahead. The rest of the manual can wait.

### 78 MODIFICATIONS

For most folks, the 1604-VLZ PRO works just fine the way it is. But for special applications, there are two signal routing changes that can be performed easily on the 1604-VLZ PRO. Easy for someone with soldering experience, that is. If you don’t know how to solder, find a technician that can. This is NOT a good place to learn!

- Modification A changes AUX SEND 1 and 2, with the pre switch engaged, to be *post-EQ* instead of *pre-EQ*.
- Mod B changes the SOURCE matrix’s MAIN MIX selection to tap the stereo signal before the MAIN MIX level control (*pre*) instead of after (*post*).

Instructions for performing these modifications can be found on our website at [www.mackie.com](http://www.mackie.com) (click on Support). Or you can call Tech Support at 1-800-258-6883 for assistance.

# 79 1604-VLZ PRO BLOCK DIAGRAM

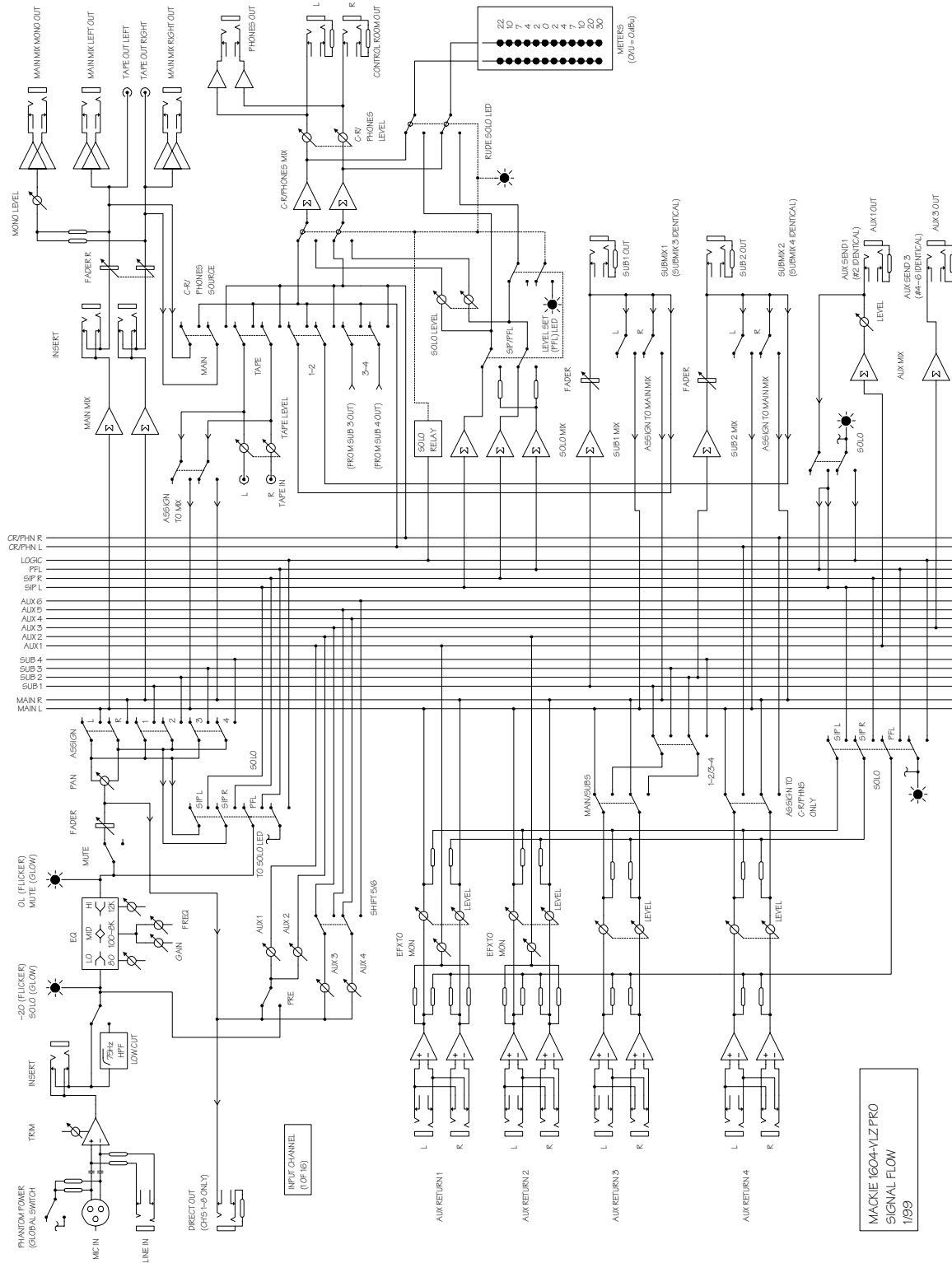

MACKIE 1604-VLZ PRO  
SIGNAL FLOW  
1/89

# 80 GAIN STRUCTURE DIAGRAM

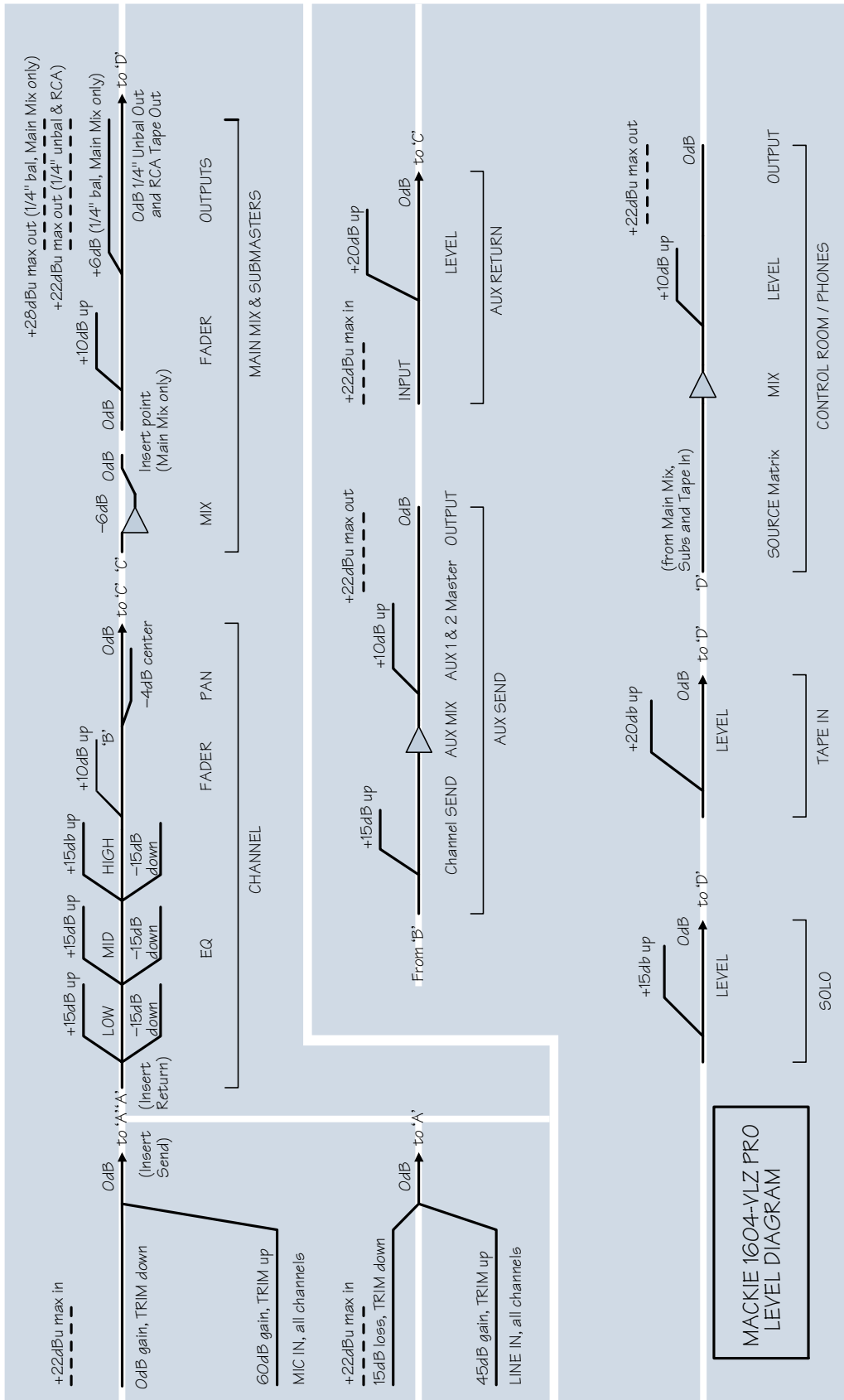

# 81 SPECIFICATIONS

## Main Mix Noise

20Hz–20kHz bandwidth, 1/4" Main Out, channel Trims @ unity gain, channel EQs flat, all channels assigned to Main Mix, odd channels panned left, even channels panned right

Main Mix fader unity, channel faders down: -86.5dBu (90dB Signal to Noise Ratio, ref +4dBu)  
Main Mix fader @ unity, channel faders @ unity: -84.0dBu

## Total Harmonic Distortion (THD)

1kHz @ +14dBu: 20Hz–20kHz  
Mic in to Main out: below 0.0007%

## Attenuation (Crosstalk)

1kHz relative to 0dBu, 20Hz–20kHz bandwidth, Line in, 1/4" Main Out, Trim @ unity

Channel Mute switch engaged: -84dBu  
Channel Gain knob down: -84dBu

## Frequency Response

Mic input to any output

20Hz to 60kHz: +0dB/-1dB  
20Hz to 100kHz: +0dB/-3dB

## Equivalent Input Noise (EIN)

Mic in to Insert Send out, max gain

150 ohm termination: -129.5dBm unweighted

## Common Mode Rejection (CMR)

Mic in to Insert Send out, max gain

1kHz: better than 90dB

## Maximum Levels

Mic in: +22dBu  
All other inputs: +22dBu  
Main Mix 1/4" TRS outputs: +28dBu  
All other outputs: +22dBu

## Impedances

Mic in: 1.3 kilohms  
Channel Insert return: 2.5 kilohms  
All other inputs: 10 kilohms or greater  
Tape out: 1.1 kilohms  
All other outputs: 120 ohms

## EQ

High Shelving: ±15dB @ 12kHz  
Mid Peaking: ±15dB, sweep 100Hz–8kHz  
Low Shelving: ±15dB @ 80Hz  
Low Cut Filter: 18dB/octave, -3dB @ 75Hz

## Power Consumption

120VA.C., 50/60Hz, 50 watts

## Fuse Ratings

120V: 1A Slo Blo, 5 x 20mm  
220–240V: 0.5A Slo Blo, 5 x 20mm

## Weight

20 lbs. (9.1kg)

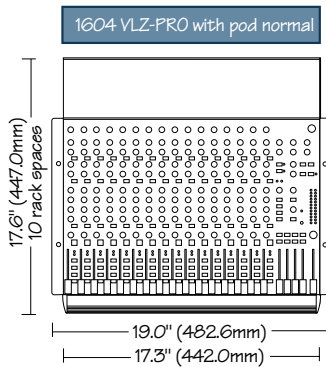
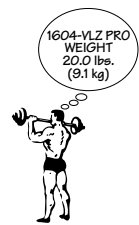

5.0" (127mm)

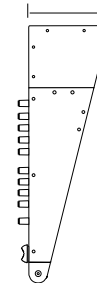

5.6" (142.2mm)

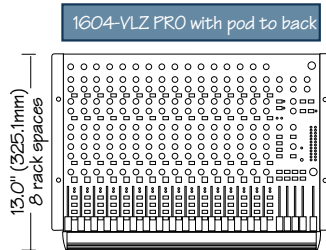
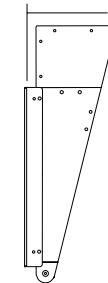

8.7" (221.0mm)

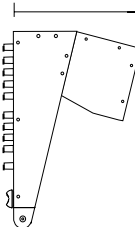

9.3" (236.2mm)

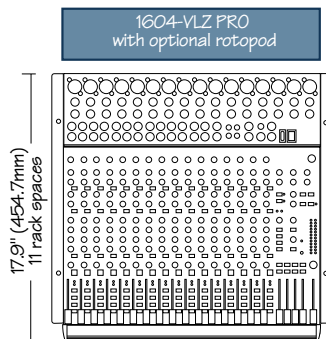
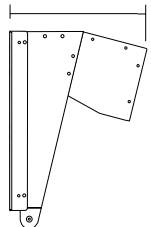

6.0" (152.4mm)

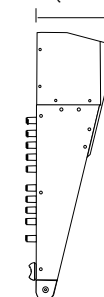

6.6" (167.6mm)

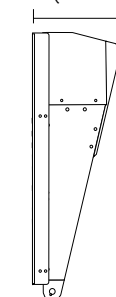

## 82 SERVICE INFO

Details concerning Warranty Service are spelled out on the Warranty Card included with your mixer (if it's missing, let us know and we'll rush one to you).

If you think your 1604-VLZ PRO has a problem, please do everything you can to confirm it before calling for service. Doing so might save you from being deprived of your mixer.

Of all Mackie products returned for service (which is hardly any at all), roughly 50% are coded "CND" — Could Not Duplicate, which usually means the problem lies somewhere other than the mixer. These may sound obvious to you, but here's some things you can check:

### TROUBLESHOOTING

#### Bad Channel

- Are the channels assigned to the correct mix (1-2, 3-4, L-R )?
- Is the fader up?
- Try unplugging any insert devices from the INSERT jacks.
- Try the same source signal in another channel, set up exactly like the suspect channel.

#### Bad Output

- Is the associated level control (if any) turned up?
- If you're listening to the C-R OUTS or PHONES outputs, has a SOURCE selection been made?
- If it's one of the MAIN OUTS, try unplugging its companion. For example, if it's the 1/4" LEFT MAIN OUT, unplug the RCA output. If the problem goes away, it's not the mixer.
- If it's a stereo pair, try switching them around. For example, if a left output is presumed dead, switch the left and right cords, at the mixer end. If the problem stays on the left, it's not the mixer.
- Unplug everything from the MAIN INSERTS.

#### Noise

- Turn the channel faders and AUX RETURN knobs down, one by one. If the sound disappears, it's either that channel or whatever is plugged into it, so unplug whatever that is. If the noise disappears, it's from your whatever.

#### Power

Our favorite question: Is the POWER switch on?  
Check the fuse 32.

### REPAIR

Service for the U.S. version of the 1604-VLZ PRO is only available from Mackie Designs, located in sunny Woodinville, Washington. (Service for mixers living outside the United States can be obtained through local dealers or distributors.) If your mixer needs service, follow these instructions:

1. Review the preceding troubleshooting suggestions. Please.
2. Call Tech Support at 1-800-258-6883, 8am to 5pm PST, to explain the problem and request an R.A. number. Have your mixer's serial number ready. **You must have a Return Authorization number, or we may refuse the delivery.**
3. Set aside the power cord, owner's manual, or anything else that you'll ever want to see again. We are responsible for the return of the mixer only.
4. Pack the mixer in its original package, including endcaps and box. This is **VERY IMPORTANT**. When you call for the RA number, please let Tech Support know if you need a new box. *Mackie is not responsible for any damage that occurs due to non-factory packaging.*
5. Include a legible note stating your name, shipping address (no P.O. boxes), daytime phone number, R.A. number and a detailed description of the problem, including how we can duplicate it.
6. Write the R.A. number in **BIG PRINT** on top of the box.
7. Ship the mixer to us. We suggest insurance for all forms of cartage. Ship to this address:  
**Mackie Designs Inc.**  
**SERVICE DEPARTMENT**  
**16220 Wood-Red Rd. NE**  
**Woodinville, WA 98072**
8. We'll try to fix the mixer within five business days. Ask Tech Support for current turn-around times when you call for your RA number. We normally send everything back prepaid using three-day shipping. However, if you rush your mixer to us by next-day air, we'll treat it in kind by shipping it back in the same way in which it was received. This paragraph does not necessarily apply to non-warranty service.

# APPENDIX A: CONNECTIONS

## “XLR” CONNECTORS

Mackie mixers use 3-pin female “XLR” connectors on all microphone inputs, with pin 1 wired to the grounded (earthed) shield, pin 2 wired to the “high” (“hot” or positive polarity) side of the audio signal and pin 3 wired to the “low” (“cold” or negative polarity) side of the signal (Figure A). All totally aboveboard and in full accord with the hallowed standards dictated by the AES (Audio Engineering Society).

Use a male “XLR”-type connector, usually found on the nether end of what is called a “mic cable,” to connect to a female XLR jack.

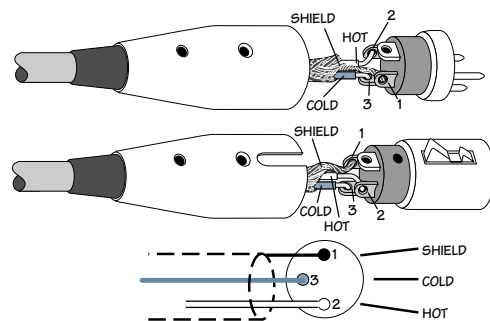

Figure A: XLR Connectors

## 1/4" TRS PHONE PLUGS AND JACKS

“TRS” stands for Tip-Ring-Sleeve, the three connections available on a “stereo” 1/4" or “balanced” phone jack or plug. See Figure B.

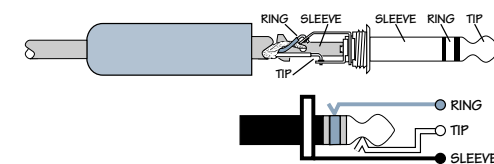

Figure B: 1/4" TRS Plugs

TRS jacks and plugs are used in several different applications:

- Stereo Headphones, and rarely, stereo microphones and stereo line connections. When wired for stereo, a 1/4" TRS jack or plug is connected tip to left, ring to right and sleeve to ground (earth). Mackie mixers do not directly accept 1-plug-type stereo microphones. They must be separated into a left cord and a right cord, which are plugged into the two mic preamps.

You can cook up your own adapter for a stereo microphone adapter: “Y” two cables out of a female 1/4" TRS jack to two male XLR plugs, one for the Right signal and one for the Left.

- Balanced mono circuits. When wired as a balanced connector, a 1/4" TRS jack or plug is connected tip to signal high (hot), ring to signal low (cold), and sleeve to ground (earth).
- Unbalanced Send/Return circuits. When wired as send/return “Y” connector, a 1/4" TRS jack or plug is connected tip to signal send (output from mixer), ring to signal return (input back into mixer), and sleeve to ground (earth).

## 1/4" TS PHONE PLUGS AND JACKS

“TS” stands for Tip-Sleeve, the two connections available on a “mono” 1/4" phone jack or plug (Figure C). TS jacks and plugs are used in many different applications, always unbalanced. The tip is connected to the audio signal and the sleeve to ground (earth). Some examples:

- Unbalanced microphones
- Electric guitars and electronic instruments
- Unbalanced line-level connections

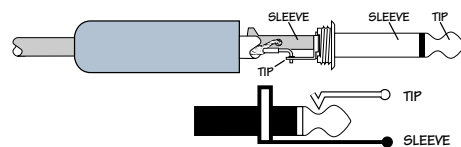

Figure C: TS Plug

## SWITCHED 1/4" PHONE JACKS

Switches can be incorporated into 1/4" phone jacks, which are activated by inserting the plug. These switches may open an insert loop in a circuit, change the input routing of the signal or serve other functions. Mackie uses switches in the channel insert and bus insert jacks, input jacks and AUX returns. We also use these switches to ground the line-level inputs when nothing is plugged into them.

In most cases, the plug must be inserted fully to activate the switch. Mackie takes advantage of this in some circuits, specifying circumstances where you are to insert the plug only partially. See **Special Mackie Connections**, later in this section.



## RCA PLUGS AND JACKS

RCA-type plugs (also known as phono plugs) and jacks are often used in home stereo and video equipment and in many other applications (Figure D). They are unbalanced and electrically identical to a ¼" TS phone plug or jack (See Figure C). Connect the signal to the center post and the ground (earth) or shield to the surrounding "basket."

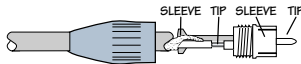

**Figure D: RCA Plug**

## UNBALANCING A LINE

In most studio, stage and sound reinforcement situations, there is a combination of balanced and unbalanced inputs and outputs on the various pieces of equipment. This usually will not be a problem in making connections.

- When connecting a balanced output to an unbalanced input, be sure the signal high (hot) connections are wired to each other, and that the balanced signal low (cold) goes to the ground (earth) connection at the unbalanced input. In most cases, the balanced ground (earth) will also be connected to the ground (earth) at the unbalanced input. If there are ground-loop problems, this connection may be left disconnected at the balanced end.
- When connecting an unbalanced output to a balanced input, be sure that the signal high (hot) connections are wired to each other. The unbalanced ground (earth) connection should be wired to the low (cold) and the ground (earth) connections of the balanced input. If there are ground-loop problems, try connecting the unbalanced ground (earth) connection only to the input low (cold) connection, and leaving the input ground (earth) connection disconnected.

In some cases, you will have to make up special adapters to interconnect your equipment. For example, you may need a balanced XLR female connected to an unbalanced ¼" TS phone plug.

## SPECIAL MACKIE CONNECTIONS

The balanced-to-unbalanced connection has been anticipated in the wiring of Mackie jacks. A ¼" TS plug inserted into a ¼" TRS balanced input, for example, will automatically unbalance the input and make all the right connections. Conversely, a ¼" TRS plug inserted into a ¼" unbalanced input will automatically tie the ring (low or cold) to ground (earth).

### TRS Send/Receive Insert Jacks

Mackie's single-jack inserts are the three-conductor, TRS-type ¼" phone. They are unbalanced, but have both the mixer output (send) and the mixer input (return) signals in one connector (See Figure E).

The sleeve is the common ground (earth) for both signals. The send from the mixer to the external unit is carried on the tip, and the return from the unit to the mixer is on the ring.

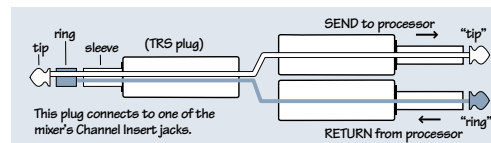

**Figure E: Insert Plug**

## Using the Send Only on an Insert Jack

If you insert a TS (mono) ¼" plug only partially (to the first click) into a Mackie insert jack, the plug will not activate the jack switch and will not open the insert loop in the circuit (thereby allowing the channel signal to continue on its merry way through the mixer).

This allows you to tap out the channel or bus signal at that point in the circuit without interrupting normal operation.

If you push the ¼" TS plug in to the second click, you will open the jack switch and create a direct out, which does interrupt the signal in that channel. See Figure F.



**NOTE: Do not overload or short-circuit the signal you are tapping from the mixer. That will affect the internal signal.**

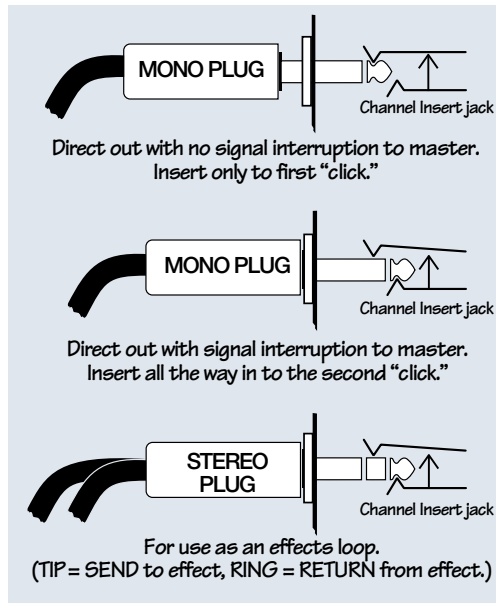

Figure F

## MACKIE STEREO INPUTS AND RETURNS: Mono, Stereo, Whatever

Stereo line inputs and stereo AUX returns are a fine example of the Mackie philosophy (which we just made up) of Maximum Flexibility with Minimum Headache. The inputs and returns will automatically be mono or stereo, depending upon how you use the jacks. Here's how it works:

A mono signal should be patched into the input or return jack labeled Left (MONO). The signal will be routed to both the left and right sides of the return circuit, and will show up in the center of the stereo pair of buses it's assigned to, or it can be "panned" with the Balance control.

A stereo signal, having two plugs, should be patched into the LEFT (MONO) and the RIGHT input or return jacks. A jack switch in the RIGHT jack will disable the mono function, and the signals will show up in stereo.

A mono signal connected to the RIGHT jack will show up in the right bus only. You probably will only want to use this sophisticated effect for special occasions (weddings, bar mitzvahs, Rush Limbaugh's birthday party, etc.)

## MULTS AND “Y”s

A mult or “Y” connector allows you to route one output to two or more inputs by simply providing parallel wiring connections. You can make “Y”s and mults for the outputs of both unbalanced and balanced circuits.



**Remember: Only mult or “Y” an output into several inputs. If you need to combine several outputs into one input, you must use a mixer; not a mult or a “Y.”**

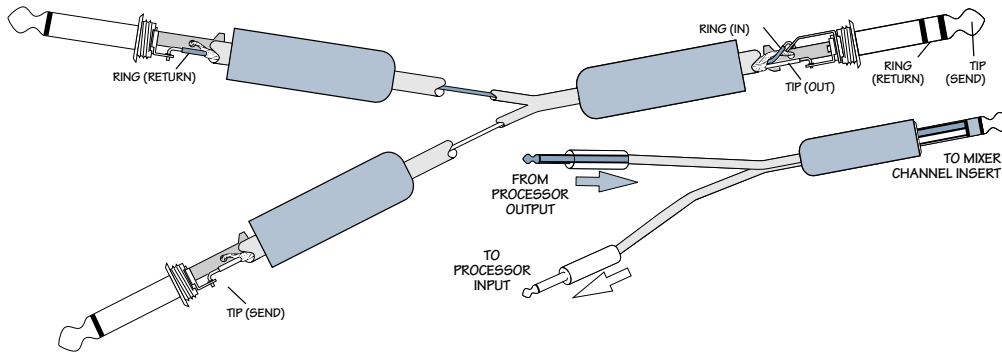

*Y-cord insert cable*

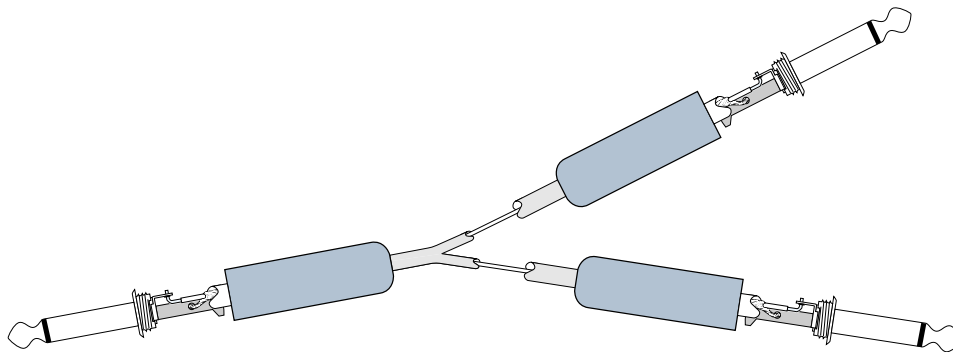

*Y-cord splitter cable*

# MACKIE.

## 1604-VLZ PRO 16-CHANNEL MIC/LINE MIXER WITH PREMIUM XDR™ MIC PREAMPLIFIERS

Session: \_\_\_\_\_

Date: \_\_\_\_\_

NOTES: \_\_\_\_\_

TRIM 1	TRIM 2	TRIM 3	TRIM 4	TRIM 5	TRIM 6	TRIM 7	TRIM 8



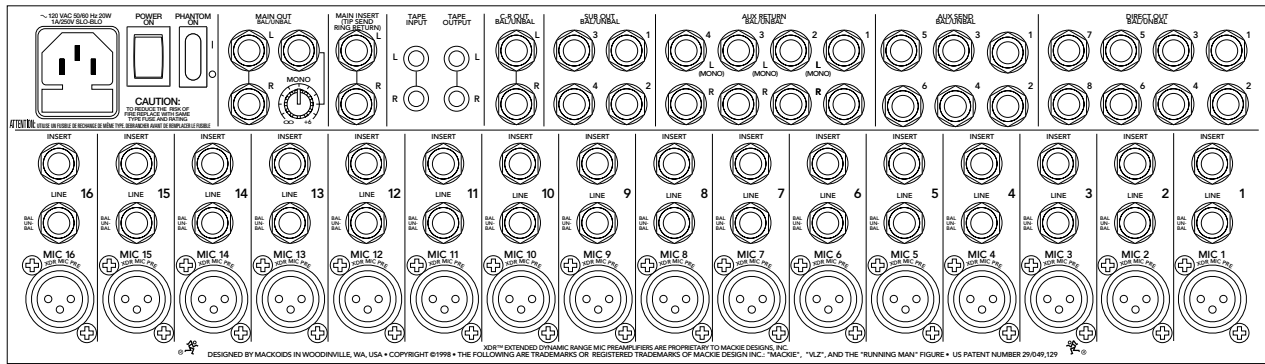

# MACKIE®

## 1604-VLZ PRO

16-CHANNEL MIC/LINE MIXER WITH PREMIUM XDR™ MIC PREAMPLIFIERS

12V 0.5A LAMP

TRIM	9	TRIM	10	TRIM	11	TRIM	12	TRIM	13	TRIM	14	TRIM	15	TRIM	16
10dBV U MIC GAIN	U	10dBV U MIC GAIN	U	10dBV U MIC GAIN	U	10dBV U MIC GAIN	U	10dBV U MIC GAIN	U	10dBV U MIC GAIN	U	10dBV U MIC GAIN	U	10dBV U MIC GAIN	U
AUX	U	AUX	U	AUX	U	AUX	U	AUX	U	AUX	U	AUX	U	AUX	U
EQ	U	EQ	U	EQ	U	EQ	U	EQ	U	EQ	U	EQ	U	EQ	U
PAN	U	PAN	U	PAN	U	PAN	U	PAN	U	PAN	U	PAN	U	PAN	U
MUTE	9	MUTE	10	MUTE	11	MUTE	12	MUTE	13	MUTE	14	MUTE	15	MUTE	16
TRACK	1	TRACK	2	TRACK	3	TRACK	4	TRACK	5	TRACK	6	TRACK	7	TRACK	8

**ASSIGN TO MAIN MIX**

LEFT LEFT LEFT LEFT

RIGHT RIGHT RIGHT RIGHT

1 2 3 4

**PHONES MAIN MIX**

dB

10 5 5 10 20 30

10 20 30

**ASSIGN OPTIONS**

SOLE SOLE

1-2 1-2

3-4 3-4

PHAN PWR

STEREO AUX RETURN

**LEFT RIGHT**

0 dB=0 dBu

20 10 7 4 2 0 2 4 7 10 20 30

CTL ROOM / PHONES

TAPE IN

TAPE TO MAIN MIX

SUBS 1-2

SUBS 3-4

MAIN MIX

CTL ROOM SOURCE

MODE

▲ NORMAL (AFL)

▼ LEVEL SET (PFL)

RUDE SLOD LIGHT

## COLOPHON

(Roll credits please) Manual written by Jeff Gilbert, based on a vignette by Ron Koliha, with tidbits borrowed from almost everywhere. Manual then defaced with proofreading pens in the hands of Mackie's legendary Tech Support staff. Manual composed on a rinky-dink PC using a low-budget word processor, then converted to this amazing piece of work using a 13-story 1000 gigawhopper Macintosh operated by Mackie's notorious Advertising staff. Please, feel

free to let us know if you find an error or stumble over a confusing paragraph. Thank you for reading the entire manual (we know you have, or you wouldn't be here).

Mackie Designs is always striving to improve our mixers by incorporating new and improved materials, components and manufacturing methods. Because we're always trying to make things better, we reserve the right to change these specifications at any time, without notice.



Mackie, the "Running Man" figure, VLZ and XDR are trademarks or registered trademarks of Mackie Designs Inc. All other brand names mentioned are trademarks or registered trademarks of their respective holders, and are hereby acknowledged.

©2003 Mackie Designs Inc.  
All Rights Reserved.

# MACKIE.®

## 1604-VLZ PRO LIMITED WARRANTY

Please keep your sales receipt in a safe place.

**A.** Mackie warrants all materials, workmanship and proper operation of this product for a period of **three years** from the original date of purchase. If any defects are found in the materials or workmanship or if the product fails to function properly during the applicable warranty period, Mackie, at its option, will repair or replace the product. Labor for replacing all potentiometers and switches is covered for the first year, after which it is excluded from warranty coverage and may be billed to you. **This warranty applies only to equipment sold and delivered within the U.S. by Mackie or its authorized dealers.**

**B.** Failure to register online or return the product registration card will not void the 3-year warranty.

**C.** Service and repairs of Mackie products are to be performed **only** at the factory (see D below) OR at an Authorized Mackie Service Center (see E below). Unauthorized service, repairs, or modification will void this warranty.

**D.** To obtain factory service:

**1.** Call Mackie at 800/258-6883, 8AM to 5PM Monday through Friday (Pacific Time) to get a Return Authorization (RA). Products returned without an RA number will be refused.

**2.** Pack the product in its original shipping carton. If you do not have the carton, just ask for one when you get your RA number, and we'll send a shipping carton out promptly. More information on packing can be found in the *Service* section of this manual. Do not use "packing peanuts," shredded newspapers, or other material with small particles, old underwear, or socks. Please seal the Mackie product in a plastic bag.

**3.** Also include a note explaining exactly how to duplicate the problem, a copy of the sales receipt with price and date showing, and your return street address (no P.O. boxes or route numbers, please!). If we cannot duplicate the problem at the Mackie Factory or establish the starting date of your Limited Warranty, we may, at our option, charge for service time.

**4.** Ship the product in its original shipping carton, **freight prepaid** to:

Mackie Designs  
Service Department  
16220 Wood-Red Rd. NE  
Woodinville, WA 98072 USA

**IMPORTANT: Make sure that the RA number is plainly written on the shipping carton.**

**E.** To obtain service from an Authorized Mackie Service Center:

**1.** Call Mackie at 800/258-6883, 8AM to 5PM Monday through Friday (Pacific Time) to get:

1) The name and address of your nearest Mackie Authorized Service Center and 2) A return authorization (RA). You must have an RA number before taking your unit to a service center.

**2.** Make sure that you have a copy of your product's sales receipt from the store where you bought the product. It is necessary to establish purchase date and thus determine whether or not your product is still under warranty. If you can't find it, the Authorized Service Center may charge you for repairs even if your product is still covered by Mackie's 3-Year Limited Warranty.

**3.** Make sure that the problem can be duplicated. If you bring your product to an Authorized Service Center and they can't find anything wrong with it, you may be charged a service fee.

**4.** If the Mackie Authorized Service Center is located in another city, pack the product in its original shipping carton. More information on packing can be found in the *Service* section of this manual.

**5.** Contact the Mackie Authorized Service Center to arrange service or bring the product to them.

**F.** Mackie and Mackie Authorized Service Centers reserve the right to inspect any products that may be the subject of any warranty claims before repair or replacement is carried out. Mackie and Mackie Authorized Service Centers may, at their option, require proof of the original date of purchase in the form of a dated copy of the original dealer's invoice or sales receipt. Final determination of warranty coverage lies solely with Mackie Designs Inc. or its Authorized Service Centers.

**G.** Any Mackie product deemed eligible for repair or replacement under the terms of this warranty will be repaired or replaced within thirty days of receipt by Mackie. Mackie may use refurbished parts for repair or replacement of any product. Products returned to Mackie that do not meet the terms of this Warranty will be repaired and returned C.O.D. with billing for labor, materials, return freight, and insurance. Products repaired under warranty at Mackie's factory will be returned freight prepaid by Mackie to any location within the boundaries of the USA.

**H.** Mackie warrants all repairs performed for 90 days or for the remainder of the original warranty period. Mackie assumes no responsibility for the quality or timeliness of repairs performed by Mackie Authorized Service Centers.

**I.** This warranty is extended to the original purchaser and to anyone who may subsequently purchase this product within the applicable warranty period.

**J.** This is your sole warranty. Mackie does not authorize any third party, including any dealer or sales representative, to assume any liability on behalf of Mackie Designs or to make any warranty for Mackie Designs.

**K.** THE WARRANTY GIVEN ON THIS PAGE IS THE SOLE WARRANTY GIVEN BY MACKIE AND IS IN LIEU OF ALL OTHER WARRANTIES, EXPRESS AND IMPLIED, INCLUDING THE WARRANTIES OF MERCHANTABILITY AND FITNESS FOR A PARTICULAR PURPOSE. THE WARRANTY GIVEN ON THIS PAGE SHALL BE STRICTLY LIMITED IN DURATION TO ONE YEAR FROM THE DATE OF ORIGINAL PURCHASE FROM AN AUTHORIZED MACKIE DEALER. UPON EXPIRATION OF THE APPLICABLE WARRANTY PERIOD, MACKIE SHALL HAVE NO FURTHER WARRANTY OBLIGATION OF ANY KIND. MACKIE SHALL NOT BE LIABLE FOR ANY INCIDENTAL, SPECIAL, OR CONSEQUENTIAL DAMAGES THAT MAY RESULT FROM ANY DEFECT IN THE MACKIE PRODUCT OR ANY WARRANTY CLAIM. Some states do not allow exclusion or limitation of incidental, special, or consequential damages or a limitation on how long warranties last, so some of the above limitations and exclusions may not apply to you. This warranty provides specific legal rights and you may have other rights which vary from state to state.

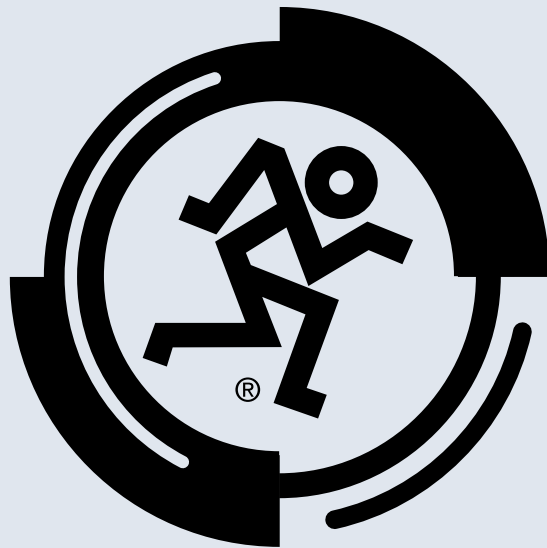

**MACKIE®**

**Mackie Designs Inc.**

16220 Wood-Red Road NE • Woodinville, WA 98071 • USA

US and Canada: 800.898.3211

Europe, Asia, Central and South America: 425.487.4333

Middle East and Africa: 31.20.654.4000

Fax: 425.487.4337 • [www.mackie.com](http://www.mackie.com)

E-mail: [sales@mackie.com](mailto:sales@mackie.com)