

KL200

LIVE PERFORMANCE CONSOLE

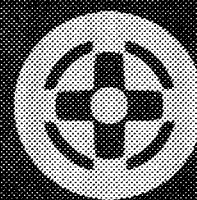
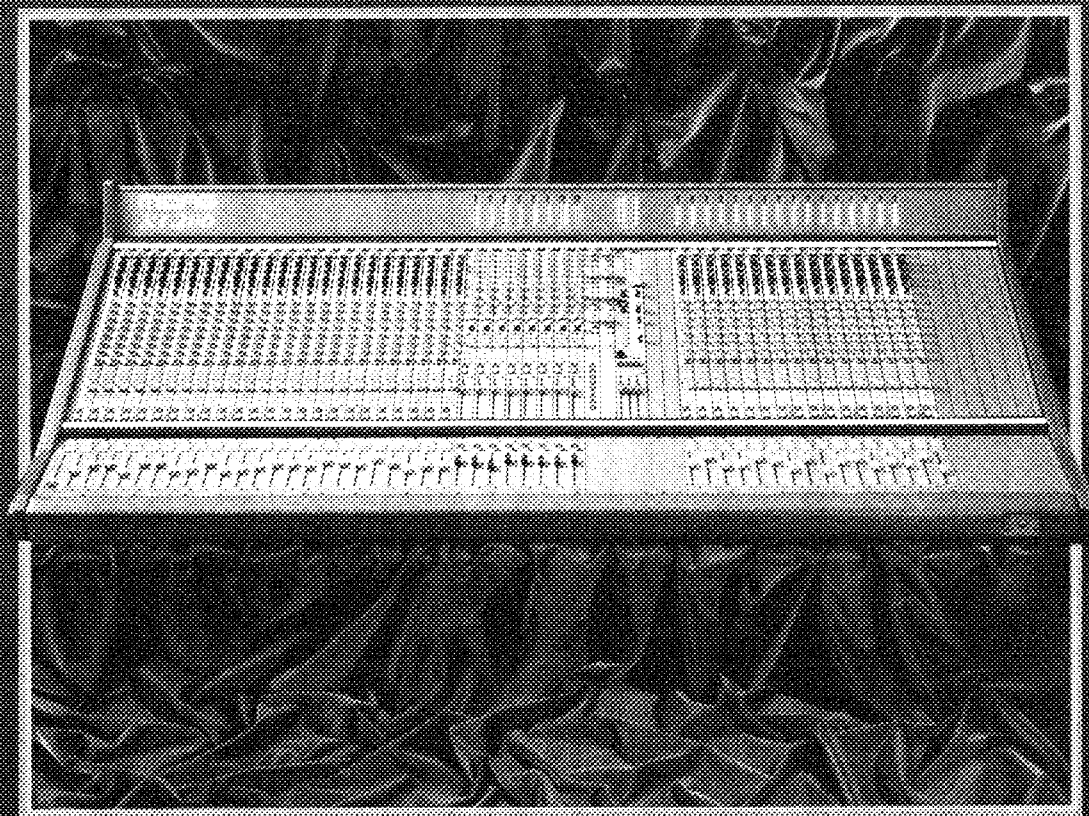

MDRS

a MARK IV company

A TOUCH MORE ACCESSIBLE

MIDAS XL200

LIVE PERFORMANCE CONSOLE

Contents

Introduction	
Midas XL201 Input Module	1
Midas XL202 Stereo Input Module	5
Midas XL203 Input Fader	9
Midas XL211 Stereo Group Module	11
Midas XL241 Mono Group Module	15
Midas XL213 VCA Fader	17
Midas XL251 Aux Masters 1-4 and Automute	21
Midas XL252 Aux/Masters 5-8 Module	25
Midas XL221 Master and Comms Module	29
Midas XL200 Metering	33
Midas XL200 Rear Panel	

Introduction to the XL200

Historically, Midas mixing consoles were always considered as high quality, high cost products which most PA companies could not afford - but all aspired to. The introduction of the XL3 console in 1993 was a milestone for Midas, as it marked the launch of a Midas product that allowed engineers to enjoy the same high sound and build quality, but at a fraction of the cost.

With the XL4 and XL3 consoles in the Midas product range, the introduction of the XL200 is yet another breakthrough for price versus performance. The design criteria was to develop a mid priced mixing console, while maintaining the outstanding sound quality and sonic performance. Frame construction techniques are a departure from traditional Midas design, as very little wiring is present in the frame with all input and insert connectors integral to each module. The addition of efficient, ergonomic and tactile control features also allows us to use the most cost effective manufacturing methods - the result is an outstanding mid priced console that brings the Midas dream within reach. The Midas XL200.....a touch more accessible.

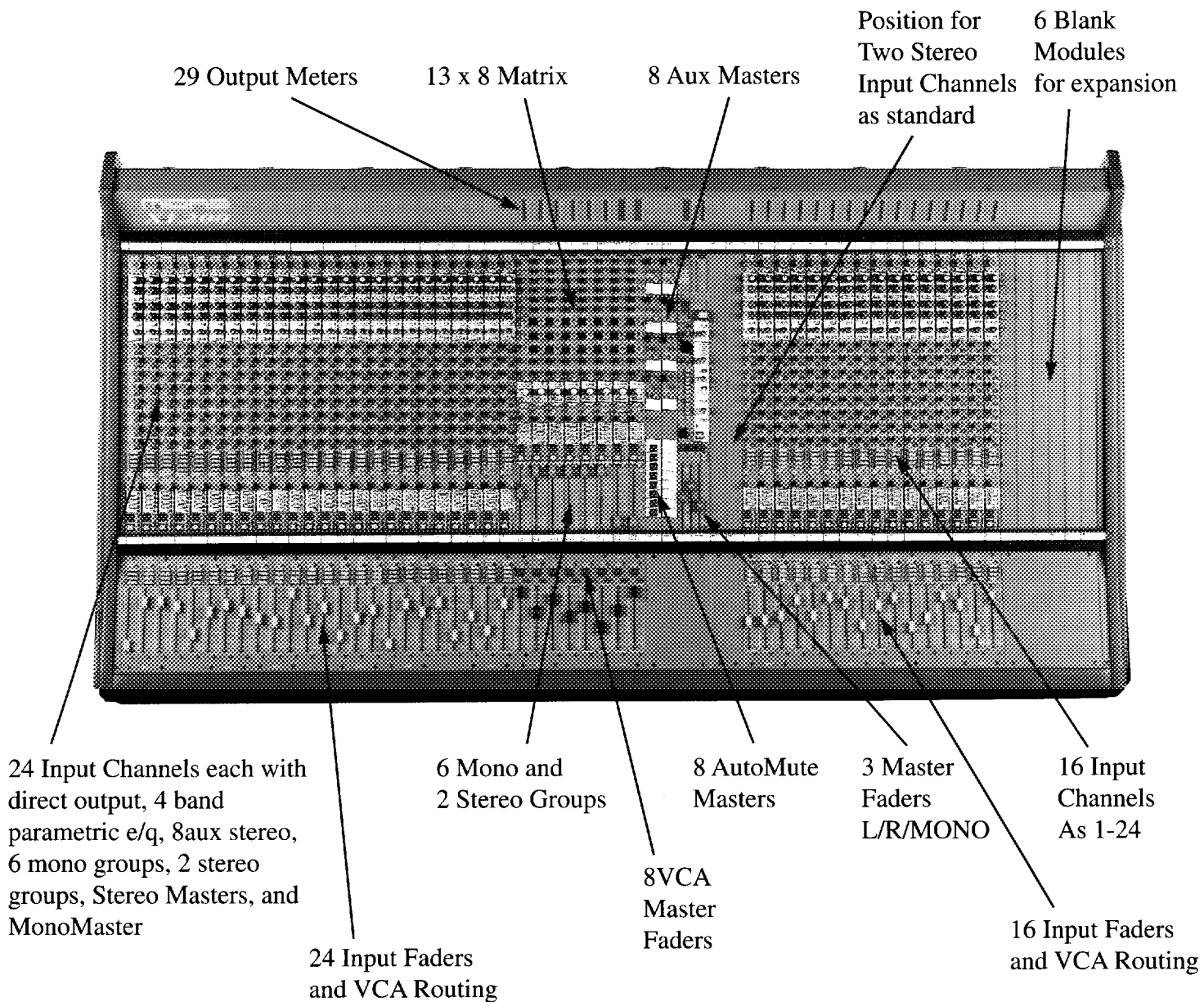

Midas XL200 Features

Mic Inputs.

The XL200 features a state of the art Analogue Devices™ mic amplifier which assures low distortion and excellent amplifier stability, RF rejection and noise performance.

Line inputs.

A separate Hi Z line input is incorporated which is ideal for playback of recorded material.

Direct Outputs.

Every input module is fitted with a direct output as standard making multi-track recording a simple task.

Equaliser.

The sonic performance of the legendary Midas equaliser is maintained including parametric mid's with sweepable frequency and switched 'Q'. The treble and bass sections have the traditional Midas wide frequency range shelving characteristic.

Inserts.

Each channel has a half normalised fully balanced insert send and return point which can be switched in or out from the front panel and set as either pre or post equaliser.

Input metering.

These peak reading meters cover a 30dB range in 3dB steps and monitor pre fader signals.

Audio busses.

Each channel can be routed to any combination of 21 audio busses comprising of 8 aux's, 6 mono groups, 2 stereo groups 2 stereo masters and 1 mono master. All switchable on the module front panel.

VCA and mute busses.

Each channel can be controlled by any combination of the 8 VCA master faders and 8 mute masters. Assignment of these busses is again switchable on the module front panel. Mutes may also be controlled by the optional automation system. A safe switch disconnects the channel from all mute groups.

Audio groups.

The main audio groups may also be assigned to any of the 8 automute groups. A safe switch is again included for each group. The input for the groups is derived from the 10 group busses.

Master.

The master module provides the main left, right and mono console outputs. A solo to master facility is incorporated on the left and right outputs to aid the engineer at sound checks.

Matrix.

The 8 matrix outputs are a part of the group modules, and derive their signals from the 6 mono audio groups, 2 stereo groups, left and right masters and mono master, creating a 13 x 8 matrix.

Output meters.

32 peak reading led bargraph meters (each covering a 60dB range in 3dB steps) are used to monitor all the group outputs i.e. 6 mono groups, 2 stereo groups, 8 matrix, and 8 auxiliary. 3 VU meters are used for the left, right, and mono outputs. They also automatically monitor the left, right, and mono solo functions.

The Optional Midi Automation.

The Midi automation system provides 10 mute groups, 128 snapshots of mute settings and a solo-in-place mode which can be used alongside the conventional PLF/AFL system.

XL200 Specification Overview and Statistics.

1. The XL200 is a 24 audio buss console with an additional 13 x 8 output matrix The busses are as follows:

8	mono aux groups	=	8
6	mono audio sub groups	=	6
2	stereo audio sub groups	=	4
1	stereo master	=	2
1	mono master	=	1
1	stereo Solo	=	2
1	mono Solo	=	1

2. The XL200 has 8 automute groups, and 8 input channel VCA sub groups which include VCA sub group muting.

3. The XL200 has either 40, 32, 24, or 16 input channels with separate line and mic inputs.

4. The 40 input XL200 has a total XLR input count of 71 as follows:

40	channel mic inputs
8	aux bus inject inputs
10	audio group bus inject inputs
8	matrix bus inject inputs
2	master bus inject inputs
1	comms input
1	talk mic input
1	solo

5. The XL200 has a total XLR output count of 32 as follows:

8	aux outputs
10	audio group outputs
8	matrix outputs
3	master outputs
2	local outputs
1	talk output

6. The 40 input XL200 has a total of 40 balanced jack line inputs.

7. The 40 input XL200 has a total of 40 balanced jack direct outputs.

8. The 40 input XL200 has a total of 122 balanced jacks for inserts, (arranged pairs) as follows:

- 40 input channel inserts sends
- 40 input channel inserts returns
- 10 audio group inserts sends
- 10 audio group inserts returns
- 8 matrix insert sends
- 8 matrix returns
- 3 matrix insert sends
- 3 matrix insert returns

9. The XL200 has a peak program meters with 10 LED segments for each input and 20 LED segment meters for each output.

10. XL200 configurations

XL200-44	40 mono inputs/2 stereo inputs/6 blank modules
XL200-36	32 mono inputs/2 stereo inputs/6 blank modules
XL200-28	24 mono inputs/2 stereo inputs/6 blank modules
XL200-20	16 mono inputs/2 stereo inputs/6 blank modules

XL200-24 compact	24 module positions only
XL200-16 compact	16 module positions only
XL200-32 extender	32 mono or stereo inputs
XL200-24 extender	24 mono or stereo inputs
XL200-16 extender	16 mono or stereo inputs

11. XL200 dimensions and weights

Dimensions	Width	1986mm (XL200-44)
		1736mm (XL200-36)
	Depth	1486mm (XL200-28)
		1236mm (XL200-20)
		1236mm (XL200-24 compact)
		986mm (XL200-16 compact)
		1236mm (XL200-32 extender)
		986mm (XL200-24 extender)
		674mm (XL200-16 extender)
		Height
	375mm (all consoles)	

Nett weight	129kg/285lb (XL200-44)
Shipping weight	301kg/665lb (XL200-44)

XL200 Technical Specification.

Input Impedance	Mic	2K Balanced
	Line	20K Balanced
Input Gain (all faders at 0dB)	Mic	Continuously variable from + 6dB to + 60dB
	Mic + Pad	Continuously variable from - 14dB to + 40dB
	Channel Line Input	Continuously variable from - 10dB to +20dB
	All other Line Inputs	0dB
Maximum Input Level	Mic	+ 15dBu
	Mic + Pad	+ 35dBu
	Channel Line Input	+ 26dBu
	All other Line Inputs	+21dBu
CMR at 1KHz	Mic (gain + 60dB)	> 70dB
	Mic + Pad (gain + 40dB)	> 50dB
Frequency Response (20 to 20KHz)	Mic to Mix (gain + 60dB)	+ 0dB to 1dB
	Line to Mix	+ 0dB to 1dB
Noise (20 to 20KHz)	Mic EIN ref 150 Ohms (gain + 60dB)	- 128dBu
	Line EIN ref 150 Ohms (gain + 10dB)	- 100dBu
System Noise (20 to 20KHz)	Summing Noise (12 channels routed with faders down)	- 86dB
	Line to Mix Noise (12 channels routed at 0dBm pan centre)	- 81dB

Summing Noise	(4X channels routed with faders down)	- 80dB
	Line to Mix Noise (48 channels routed at 0dB, pan centre)	- 75dB
Distortion at 1KHz	Mic to Mix (+ 60dB gain, 0dBu output)	< 0.03%
	Line to Mix (0dBu)	< 0.03%
Crosstalk at 1 KHz	Channel to Channel	< - 100dB
	Mix to Mix	< - 90dB
	Channel to Mix	< - 90dB
	Maximum Fader attenuation	> 90dB
Output Impedance	All Line Outputs	75 Ohms Balanced Source to drive > 600 Ohms
	Headphones	To drive > 8 Ohms Unbalanced
	Comms (Bi directional)	600 Ohms Nominal Unbalanced
Maximum Output Level	All Line Outputs	+ 21 dBu
	Headphones	+ 21dBu (8W into 8 Ohms)
	Comms (Bi directional)	- 10dBu
Nominal Signal Level	Mic	- 60dBu to + 14dBu
	Channel Line Inputs	- 20dBu to 6dBu
	All other Line Inputs and Outputs	0dBu
	Headphones	+ 10dBu
	Comms	- 20dBu
	Comms and Talk Mic	- 50dBu to 20dBu
Headroom at all stages	Comms, Talk and Headphone	> 10dB
	All other signals	> 20dB

Input Metering	Type	10 led peak reading
	Range	- 25dBu to + 12dBu
	Colour Green	Up to + 3dBu Normal signal
	Colour Yellow	+ 6dBu to + 9dBu High signal
Equaliser	Colour Red	+ 12dBu Signal Too High
	Hi pass slope	12dB / Oct.
	Hi pass frequency	Continuously variable - 3dB point from 20Hz to 400Hz
	Treble Gain	Continuously variable + 15 dB to - 15 dB Centre detent = 0dB
	Treble Shelving Freq.	Continuously variable - 3dB point from 2K to 20K
	Hi Mid Gain	Continuously variable + 15 dB to - 15 dB Centre detent = 0dB
	Hi Mid Freq.	Continuously variable centre from 400Hz to 8K
	Hi Mid Band width	Switchable 0.5 Oct and 1.0 Oct.
	Lo Mid Gain	Continuously variable + 15 dB to - 15 dB Centre detent = 0dB
	Lo Mid Freq.	Continuously variable centre from 100Hz to 2K
	Lo Mid Bandwidth	Switchable 0.5 Oct and 1.0 Oct.
	Bass Gain	Continuously variable + 15 dB to - 15 dB Centre detent = 0dB
	Bass Shelving Freq.	Continuously variable - 3dB point from 20Hz to 200Hz



MIDAS XL201 Input Module

Provides 48 volt phantom power for a condenser microphone, or DI box. Optional balancing transformers may be fitted on the Mic input.

The PHASE REVERSE switch inverts the phase of the selected input, Mic or Line, to allow compensation for different wiring standards.

EQUALISER The XL200 Equaliser is a four-band design having sweep frequency adjustment. Each band consists of two dual-concentric pots. The upper pot is the gain adjustment, the lower control being the frequency adjustment. The two mid-range sections each have a switch-selectable band width.

HIGH PASS FILTER CONTROL The frequency range of the filter is 20Hz to 400Hz, continuously variable.

INSERT In/Out The switch INS connects any outboard processor via the insert send and return connectors into circuit. The Insert point is normally located before the EQ section, but a switch located on the module pcb allows the insert to be post-EQ.

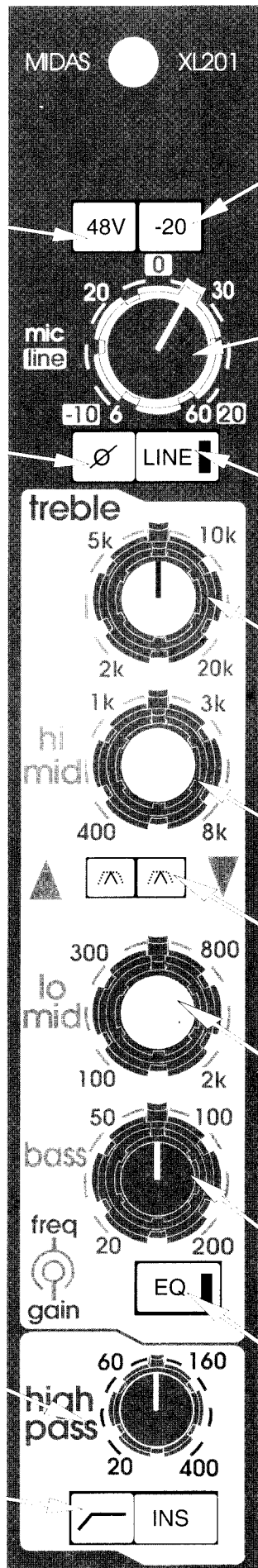

-20dB (PAD) Switching in -20 inserts a 20dB attenuator in circuit with the microphone input. This may be used when high- output microphones are employed, or to enable the use of the mic input for line-level signals.

GAIN The gain control is a wide range rotary potentiometer, and is active on both Mic and Line Inputs. On Mic, the gain can be adjusted from 6dB to 60dB. For Line inputs, the adjustment is from -10dB to +20dB.

LINE The LINE switch selects the signal on the line input socket to feed the channel path when it is down. In this case, the Mic signal is disconnected. The led illuminates when Line is selected.

HF Shelving section, providing +/- 15dB of gain with an adjustable frequency range of 2kHz to 20kHz.

HI MID Peaking section, providing +/- 15dB of gain, at frequencies from 400Hz to 8kHz.

BAND WIDTH Selects the band width to be 1.4 (1 Oct) or 2.9. The band width is 2.9 (0.5 Oct) when the switch is in the 'down' position.

LO MID Peaking section, providing +/- 15dB of gain, at frequencies from 100Hz to 2kHz.

LF Shelving section, providing +/- 15dB of gain with an adjustable frequency range of 20Hz to 200Hz.

EQ IN The EQ switch inserts the equaliser into circuit. When switched out, the equaliser is totally bypassed, keeping the signal path to a minimum. The led in the switch illuminates when the EQ is in circuit.

PRE Selects each auxiliary send to be pre channel fader.

AUXILIARIES The XL200 has eight auxiliary buses, accessed on the Input module from 8 independent rotary controls.

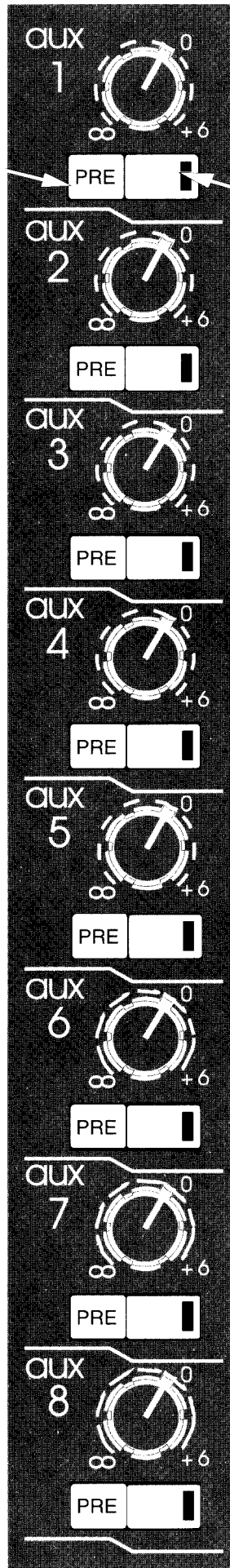

ON Enables each auxiliary to send via it's rotary control ROUTING and status.

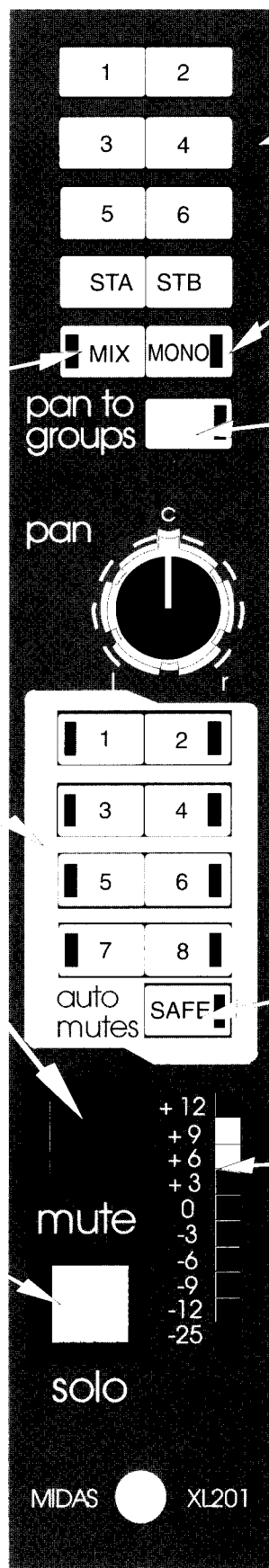

MIX Routes the post-fade, post-pan channel signal to the main stereo mix bus, with led indication. The PAN control is automatically inserted into circuit.

AUTOMUTE ROUTING

Switches 1-8 enable an input channel to be assigned to any or all of the automute scenes controlled from the master scene switches on the auxiliary send master module.

MUTE This switch mutes an input channel so that all functions are muted.

SOLO The SOLO button feeds a Pre-fader or post-fader signal (as selected on the master module PFL or AFL) to the Monitor section (loudspeakers or headphones), replacing the selected monitor source if one is selected. The main stereo output of the console is not affected unless SIP (Solo-in-place) mode has been selected on the master. The yellow led in the SOLO switch will flash when the SOLO function is active.

SOLO signals from different sources that are active simultaneously in the non-interlocked mode will be summed. To latch the SOLO function, press the button quickly and release. To unlatch, repeat. To SOLO a signal momentarily, hold down the CUE button for at least 1 second. On release, the CUE will also be released. See the section on THE SOLO SYSTEM for full functional details.

AUDIO GROUP ASSIGNS
Switches 1-6 route an input channel to any of the six mono audio sub groups. Switches STA and STB route an input channel to either of the stereo audio sub groups.

MONO Routes the post-fade, post-pan channel signal to the main mono mix bus, with led indication.

ON When this button is pressed, the PAN control is automatically inserted into circuit across the selected buses, allowing the signal to be positioned in the stereo image. When PAN is set to centre, equal levels are sent to both buses, with a 3dB drop relative to fully clockwise or anti-clockwise. Setting the PAN control fully anticlockwise sends full level to the Left bus, cutting the send to the Right bus; fully clockwise rotation sends full level to the Right bus, cutting the feed to Left.

MUTE SAFE Prevents the Mute Group (or scene preset) master from muting the channel, and may be used to locally override muted channels.

METER The ten segment led meter is fed pre fade at all times.



MIDAS XL202 Stereo Input Module

Provides 48 volt phantom power for a condenser microphone, or DI box.

The PHASE REVERSE switch inverts the phase of the left channel only to allow compensation for different wiring standards, or anomalies between stereo inputs.

LR switches. In their out position, the module acts as a stereo module with both channels being separate. The L switch assigns left input to both channels, R assigns right input to both channels. With both switches enabled, left and right inputs are mono.

EQUALISER. The XL200 Stereo Equaliser is a three band design, having fixed frequency shelving for treble and bass. The mid band is sweepable with range and bandwidth switching.

HIGH PASS FILTER CONTROL. The frequency range of the filter is 20Hz to 400Hz, continuously variable.

HIGH PASS FILTER SWITCH. Enables the high pass filter section.

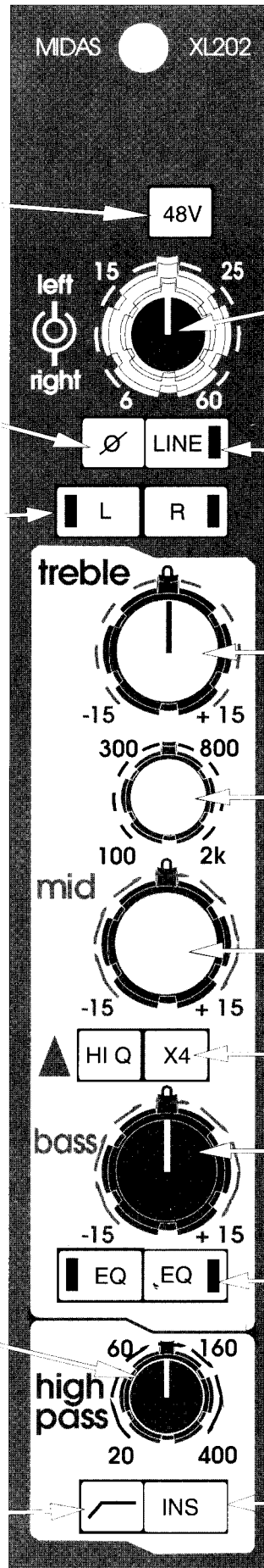

GAIN. The gain control is a wide range rotary potentiometer. The gain can be adjusted from 6dB to 60dB.

LINE. The line switch places a 20dB pad in both inputs, giving a gain range of -14 to +40dB. The LED illuminates when LINE is selected.

TREBLE shelving section, providing +/-15dB of gain at 12kHz.

MID FREQUENCY. Sweepable from 100Hz to 2kHz.

MID. Peaking section, providing +/- 15dB of gain.

X4. Used in conjunction with MID FREQUENCY, changes sweepable range to 400Hz - 8kHz.

Bass shelving section, providing +/-15dB of gain at 80Hz.

EQ. The EQ switches insert the equaliser into either left, right or both channels. The LEDs illuminate if either or both are selected.

INSERT In/Out. The switch INS connects any outboard processor via the insert send and return connectors into the respective left & right circuits. The insert points are normally located before the EQ section, but a switch located on the module pcb allows the insert to be post EQ.

PRE. Selects each auxiliary send to be pre channel fader.

AUXILIARIES. The XL200 has eight auxiliary buses. The feeds for auxes 1 to 4 are derived from a summed mono signal of left and right. The feeds for auxes 5 to 8 are selectable between summed mono and level/pan functions.

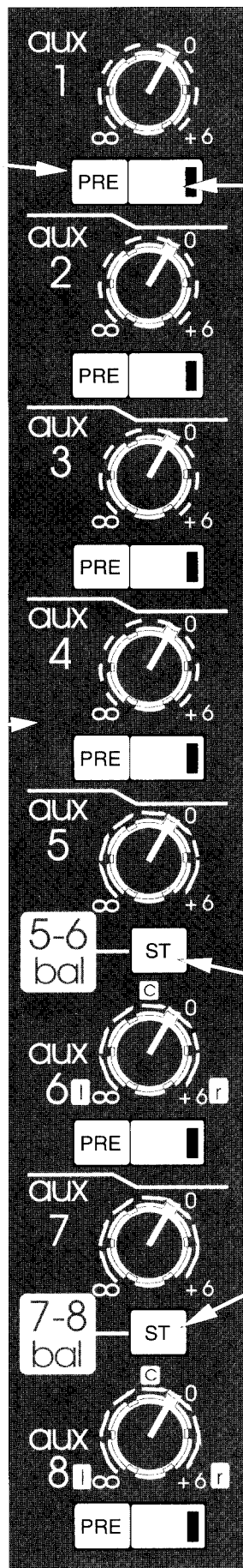

ON. Enables each auxiliary to send via it's rotary control with status LED.

ST. The ST switch when depressed, makes auxes 5-6 and 7-8 stereo pairs instead of discrete sends. 6 and 8 become the level controls for 5-6 or 7-8, thus 5 and 7 become the balance controls for 5-6 or 7-8.

MIX. Routes the post fade, post pan channel signals to the main stereo mix bus with LED indication.

AUTOMUTE ROUTING. Switches 1-8 enable an input channel to be assigned to any or all of the automute scenes controlled from the master scene switches on the auxiliary send master module.

MUTE. This switch mutes an input channel so that all functions are muted.

SOLO. The SOLO button feeds pre-fader or post-fader signals (as selected on the master module PFL or AFL) to the monitor section (loudspeakers or headphones), replacing the selected monitor source if one is selected. The main stereo output of the console is not affected unless SIP (Solo-in-place) mode has been selected on the master. The yellow LED in the SOLO switch will flash when the SOLO function is active.

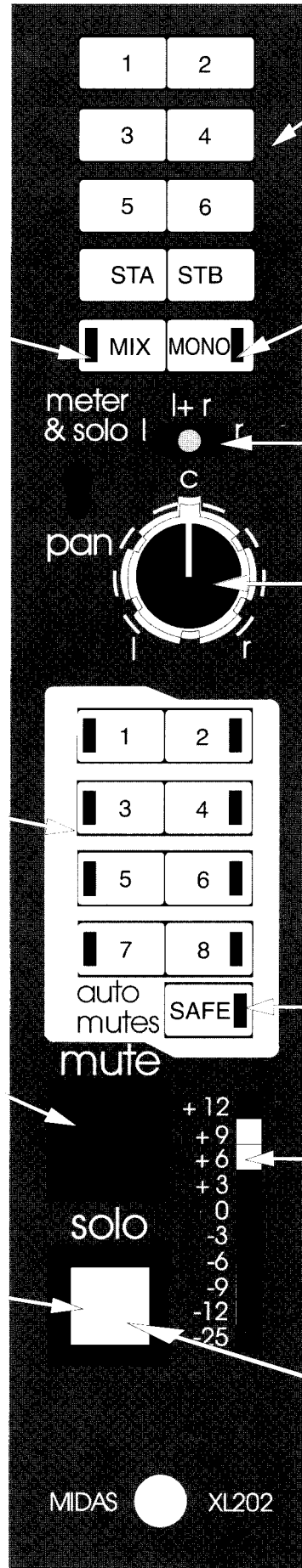

AUDIO GROUP ASSIGNS. Switches 1-6 route the input channel to the six mono audio sub groups. The left channel routing to odd groups (1,3,5) and the right channel routing to even groups (2,4,6). Switches STA and STB route the input channel in stereo to either of the stereo audio sub groups.

MONO. Routes the post-fade, sum of left and right signals to the main mono mix bus, with LED indication.

METER & SOLO. Selects left, right or mono mix to the channel meter and solo functions.

PAN. Balances the left and right channel signals sent to groups and masters.

MUTE SAFE. Prevents the Mute Group (or scene preset) master from muting the channel and may be used to locally override muted channels.

METER. The ten segment LED meter is fed pre fade at all times.

To latch the SOLO function, press the button quickly and release. To unlatch, repeat. To SOLO a signal momentarily, hold down the CUE button for at least 1 second. On release, the CUE will also be released. See the section on THE SOLO SYSTEM for full functional details.

MIDAS XL203 INPUT FADER

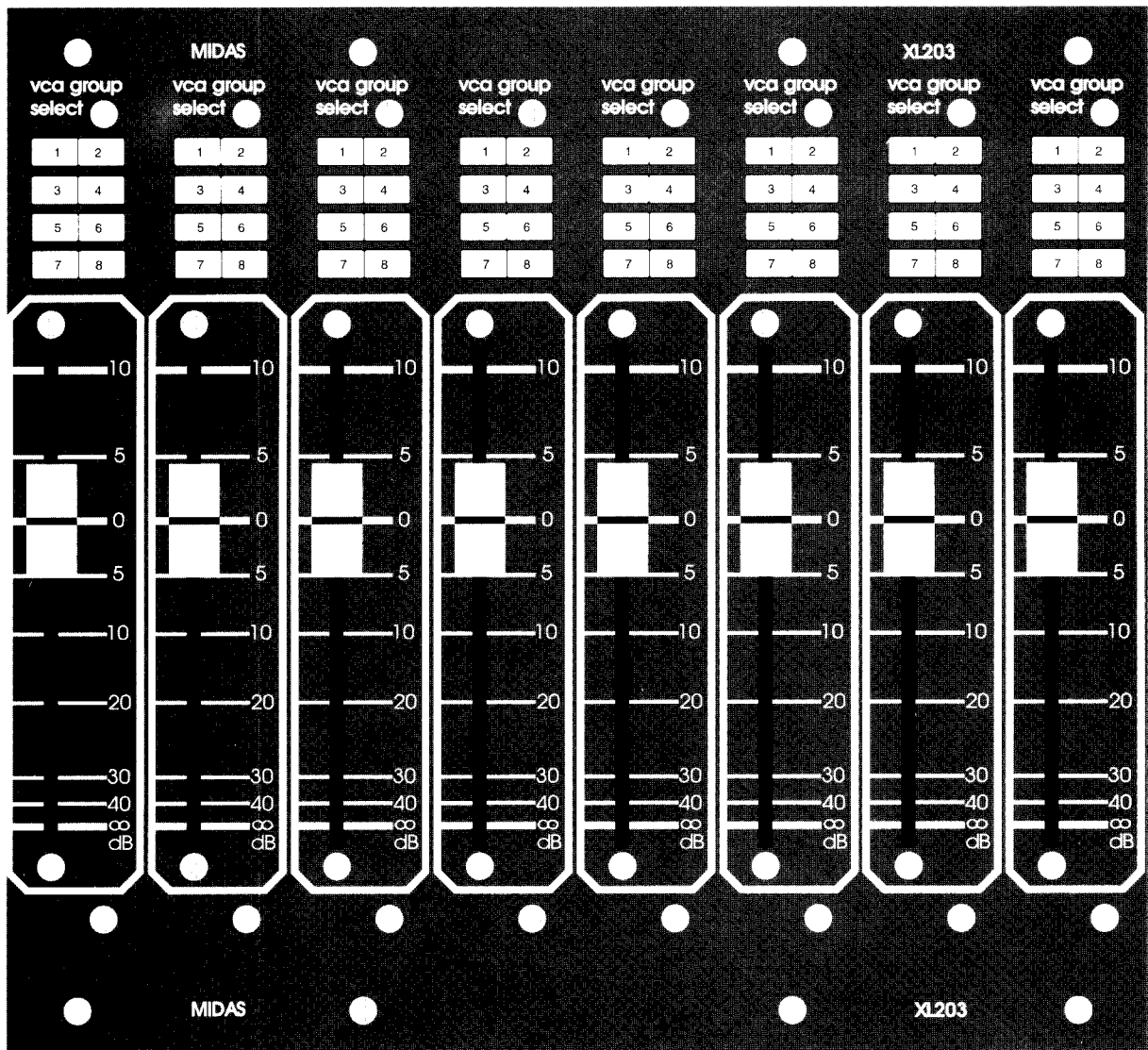

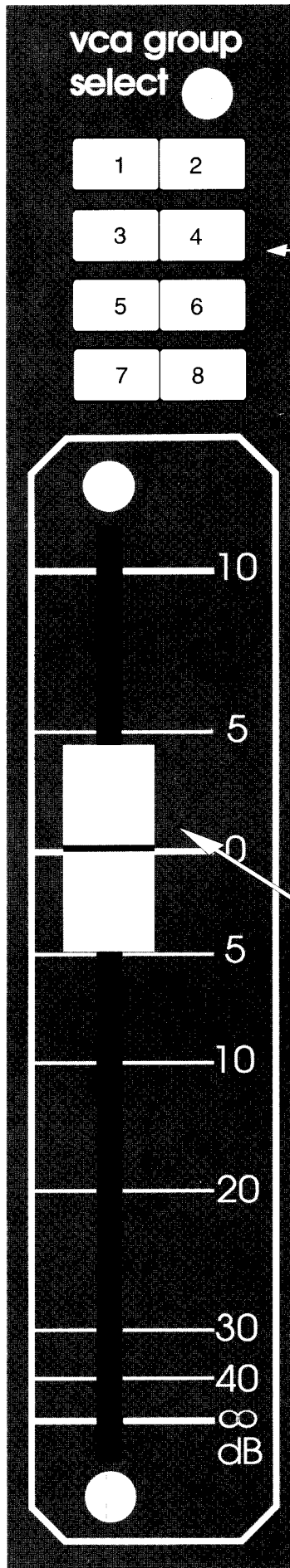

VCA GROUP SELECT
Assigns an input channel to any of the eight VCA sub groups.

FADER The fader is the main signal level control for the channel, and is a long-throw type which gives smooth control of the channel level.



MIDAS XL211 Stereo Group Module



Adjusts the level of the post fader Stereo Group A signal input to the Matrix. Similarly for Stereo B and Stereo L - R (in all cases, the lower control is right and the upper is left).

Adjusts the post-fader level of the Group 1 signal to the Matrix. Similarly, 2-6 controls Group signals 2-6.

MONO Adjusts the level of the Mono Master signal to the respective Matrix on the module.

MUTE Mutes the Matrix input and is indicated by an LED in the switch.

MUTE Mutes the Matrix output, with led indication.

MATRIX SEND PRE Allows the Group send to the Matrix to be fed pre-fader, rather than post-fader.

ST Routes the Group signal to L/R master buses via the pan pot.

PAN CONTROL Balances the Stereo Group signal sent to the main stereo mix.

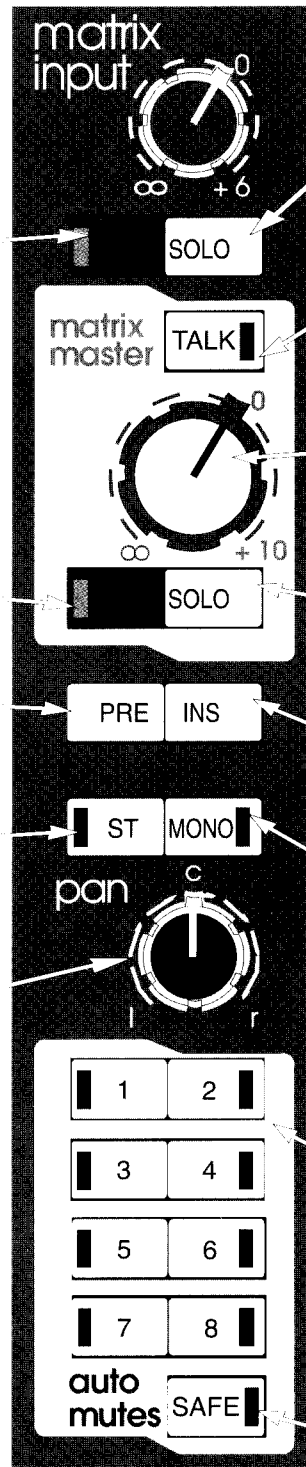

SOLO Solo's the Matrix signal to the main monitors (headphones or loudspeakers), with flashing led indication.

TALK Enables talkback signals to be routed to the Matrix output when the talk/generator system is used, with LED indication. This can be used to prevent talkback signals going to unwanted destinations.

MATRIX MASTER POT Controls the level of the Matrix output signal.

SOLO Solo's the Group signal to the main monitors (headphones or loudspeakers), with flashing LED indication. See the Input Module for a functional description of the solo button.

INS Enables the Group insert.

MONO Routes the Group signal to the mono master bus, the pan pot having no effect.

MUTE GROUP 1 ASSIGN Assigns the channel mute to Mute Group 1, with led indication. Similarly for assigns 2, 3, 4, 5, 6, 7 and 8.

MUTE SAFE Prevents the Mute Group master from muting the channel, and may be used to locally override muted channels.

MUTE Mutes the Group output and is indicated by an LED in the switch.

SOLO Solo's the Group signal to the main monitors (headphones or loudspeakers), with flashing LED indication. See the Input Module for a functional description of the solo button.

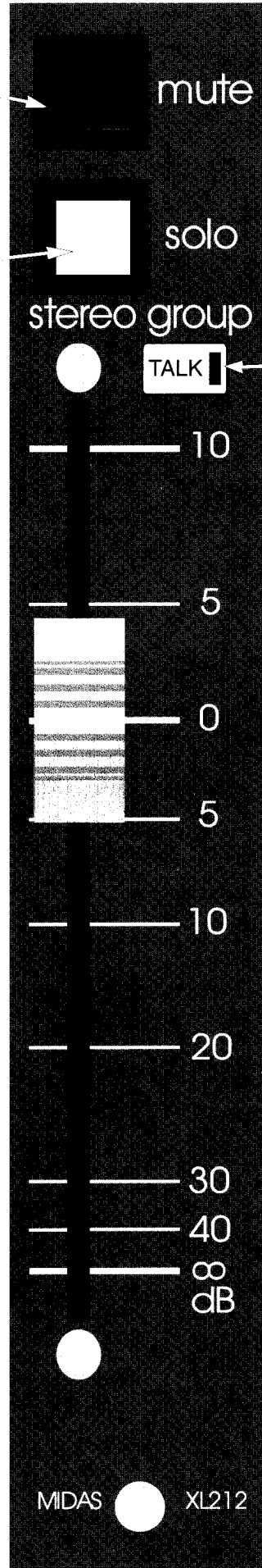

TALK Enables talkback signals to be routed to the Group output when the talk/generator system is used, with LED indication.



MIDAS XL241 Mono Group Module

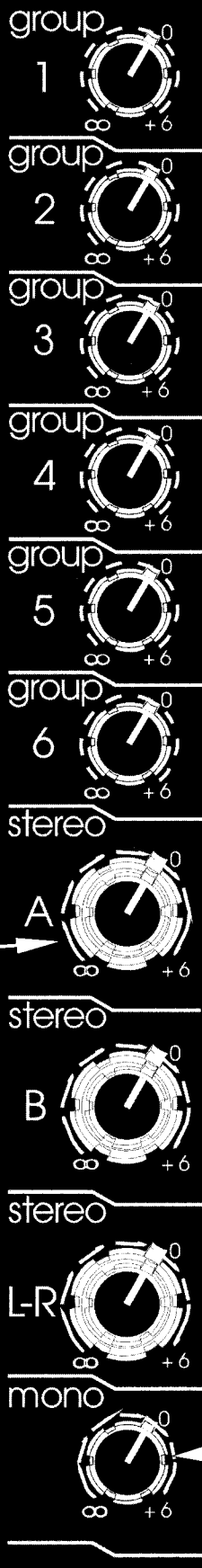

Adjusts the level of the post fader stereo Group A signal input to the matrix. Similarly for stereo B and stereo L - R (in all cases, the lower control is right and the upper is left).

Adjusts the level of the post-fader Group 1 signal input to the Matrix. Similarly for Controls 2-6 for Group signals 2 to 6.

MONO Adjusts the level of the main Mono (centre) signal from the main mono output fed to the Matrix on the module.

MUTE Mutes the Matrix input and is indicated by an LED in the switch.

MUTE Mutes the Matrix output, with led indication.

MATRIX SEND PRE Allows the Group send to the Matrix to be fed pre-fader, rather than post-fader.

ST Routes the Group signal to L/R master buses via the pan pot.

SOLO Solo's the Matrix signal to the main monitors (headphones or loudspeakers), with flashing LED indication.

TALK Enables talkback signals to be routed to the Matrix output when the talk/generator system is used, with LED indication. This can be used to prevent talkback signals going to unwanted destinations.

MATRIX MASTER POT Controls the level of the Matrix output signal.

SOLO Solo's the Matrix signal to the main monitors (headphones or loudspeakers), with flashing led indication. See the Input Module for a functional description of the solo button.

INS Enables the Group insert.

MONO Routes the Group signal to the mono master bus with the pan pot having no effect.

PAN CONTROL Places the Group signal in the main stereo master mix.

MUTE GROUP 1 ASSIGN Assigns the channel mute to Mute Group 1, with led indication. Similarly for assigns 2, 3, 4, 5, 6, 7 and 8.

MUTE SAFE Prevents the Mute Group master from muting the channel, and may be used to locally override muted channels.

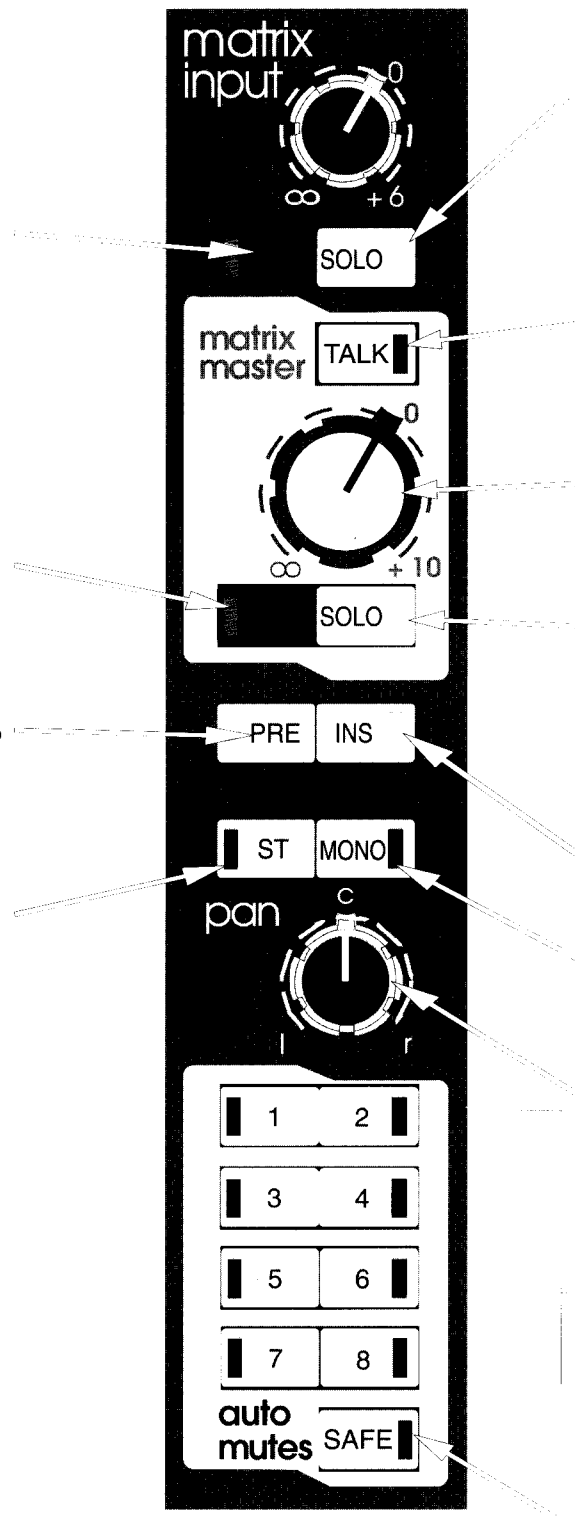

SOLO Solo's the Group signal to the main monitors (headphones or loudspeakers), with flashing LED indication. See the Input Module for a functional description of the solo button.

MUTE Mutes the Group output and is indicated by an LED in the switch.

TALK Enables talkback signals to be routed to the Group output when the talk/generator system is used, with LED indication.

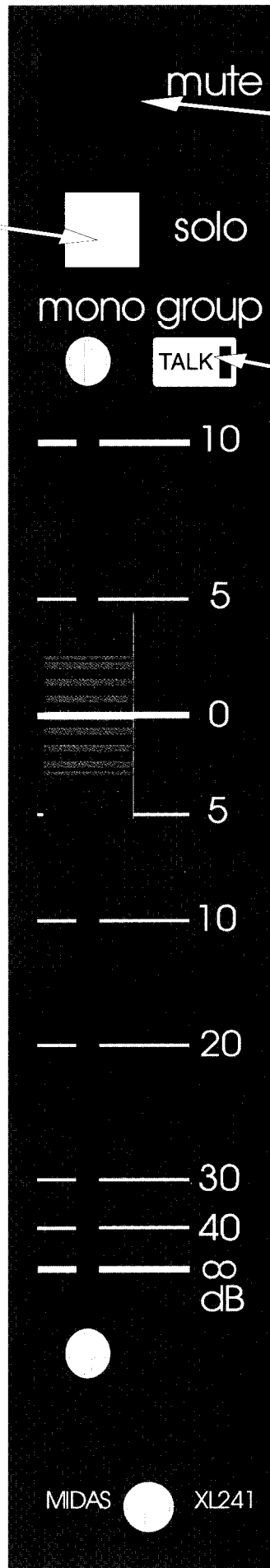

MIDAS XL213

VCA Fader

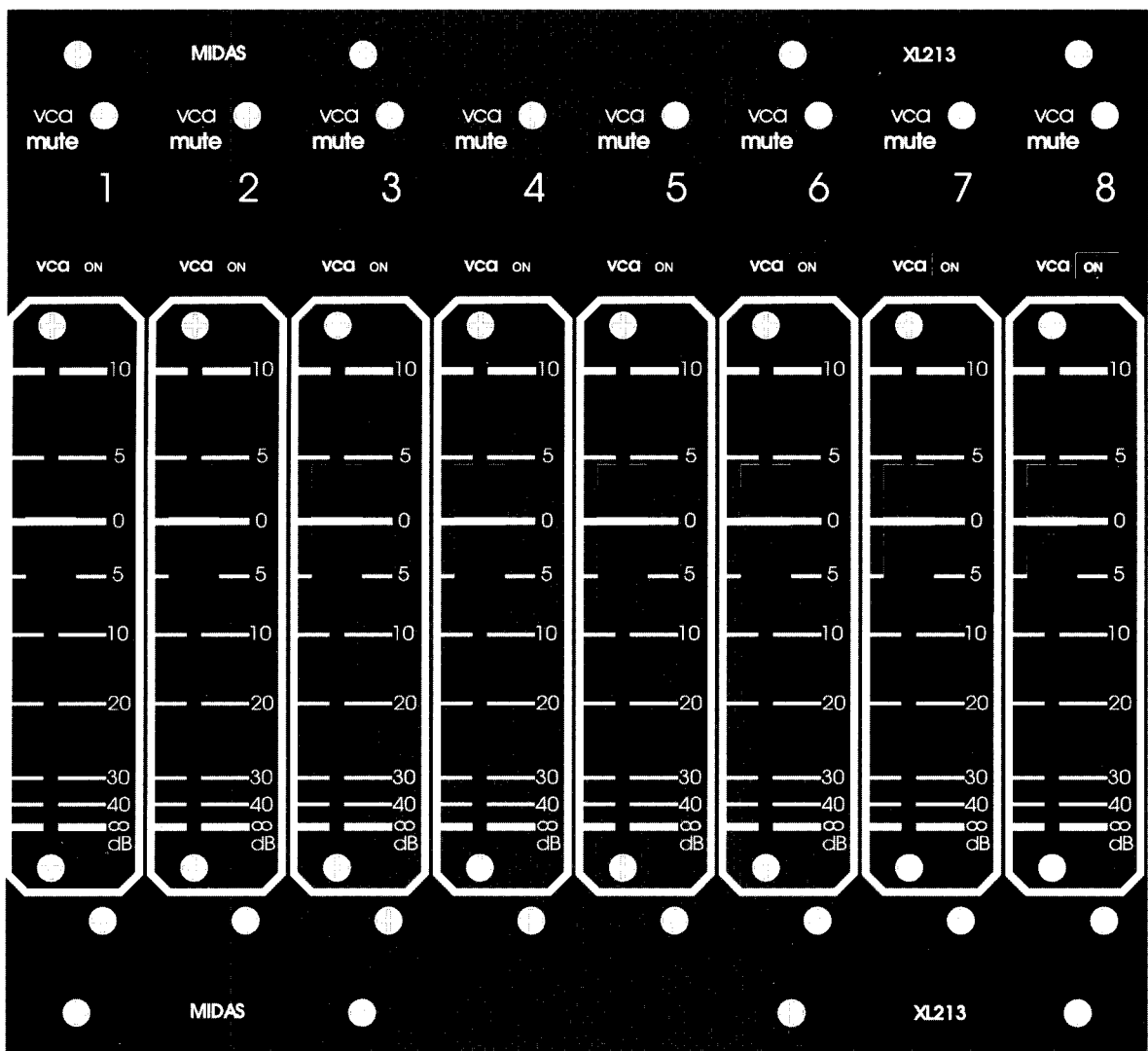

VCA MUTE Mutes any input and/or group assigned.

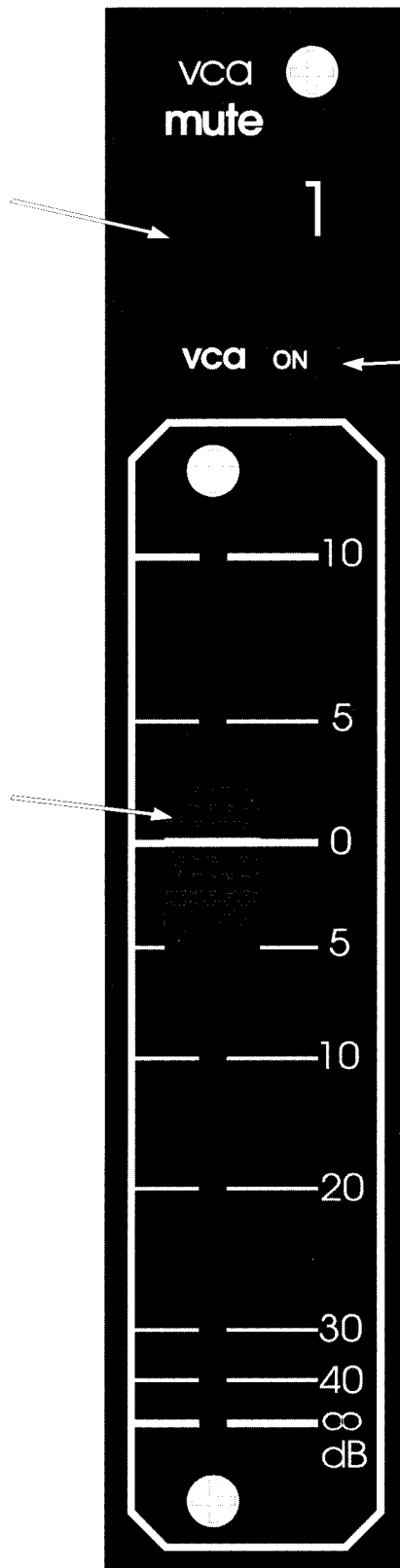

VCA ON Enables VCA Group Master fader.

VCA GROUP MASTER FADER Gives continuous adjustment of the Input and/or Group gains assigned from +10dB to off.



MIDAS XL251 Aux Master 1-4 and Automute

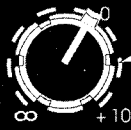

AUX MASTER 1-4 Adjusts the level of the auxiliary 1-4 Master output signal.

aux master

1

SOLO



MUTE Mutes the auxiliary 1-4 Master output signal, with LED indication.

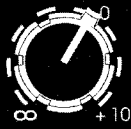

aux master

2

SOLO

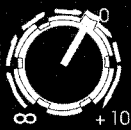

aux master

3

SOLO



aux master

4

SOLO



SOLO Solo's the auxiliary signal to the main monitors (headphones or loudspeakers), with flashing LED indication.

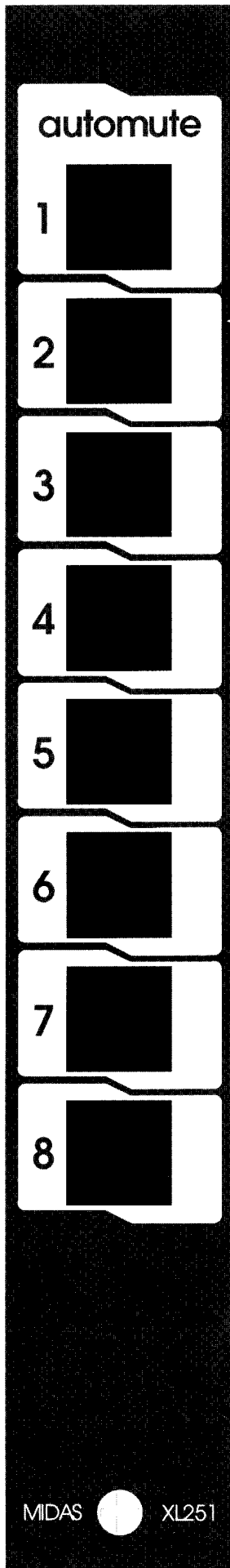

AUTOMUTES 1-8 The Auto Mute switches (1 to 8) activate the mute circuits on any assigned input channel or group



MIDAS XL252

Aux/Masters 5-8

Module

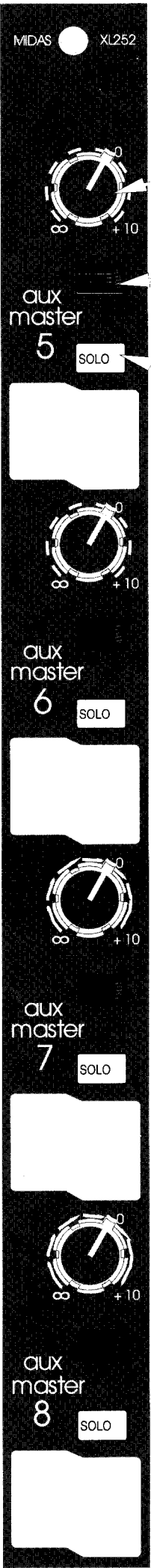

AUX MASTER 5-8 Adjusts the level of the auxiliary 5-8 Master output signal.

MUTE Mutes the auxiliary 5-8 Master output signal, with LED indication.

SOLO Solo's the auxiliary signal to the main monitors (headphones or loudspeakers), with flashing LED indication.

masters

1

2

3

4

5

6

7

8

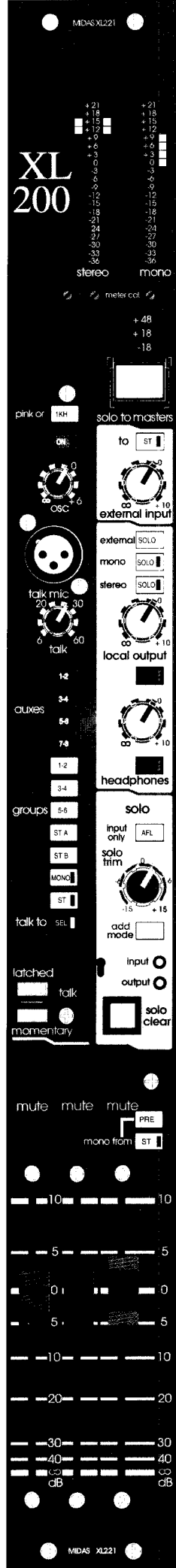

MIDAS XL221 Master & Comms Module

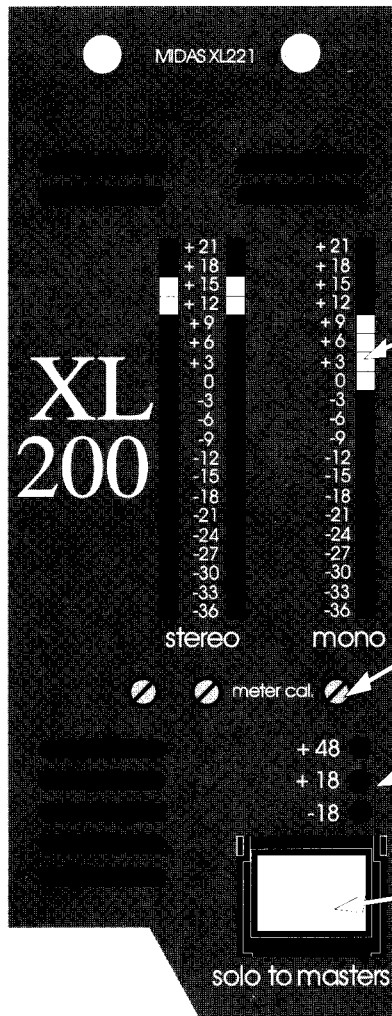

MONITOR METERS Three meters indicate left, right and mono, solo and PFL levels.

METER CALIBRATIONS Sub-panel presets to calibrate module and meterbridge monitor meters.

PSU INDICATOR LEDs Three led's which indicate all DC voltages are present.

SOLO TO MASTERS Selects the SOLO mode to be SIP (Solo-in-Place). This mode does not mute inputs when a channel or output is solo'ed. The main output signal is replaced by the solo'ed signal, until the solo is cleared when the original signal is returned to the main outputs.

PINK/1kHz Selects the type of output from the generator. In the 'up' position, the generator produces PINK noise, in the 'down' position a 1kHz sinewave tone.

ON Enables the generator, with led indication

OSC Adjusts the level of the generator output.

AUX 1-2, 3-4, 5-6, 7-8 Assigns the generator and/or talkback to Aux buses 1 and 2, or 3 and 4, or 5 and 6, or 7 and 8 .

GROUPS 1-2, 3-4, 5-6, 7-8 Assigns the generator and/or talkback to all the Group buses.

MONO Assigns the generator and/or talkback to the main Mono output.

ST Connects the external input to the Master left and right bus.

SEL Assigns the generator and/or talkback to the talk select bus.

TALK Talk system master switch. In the up position it is latched, and in the down position momentary.

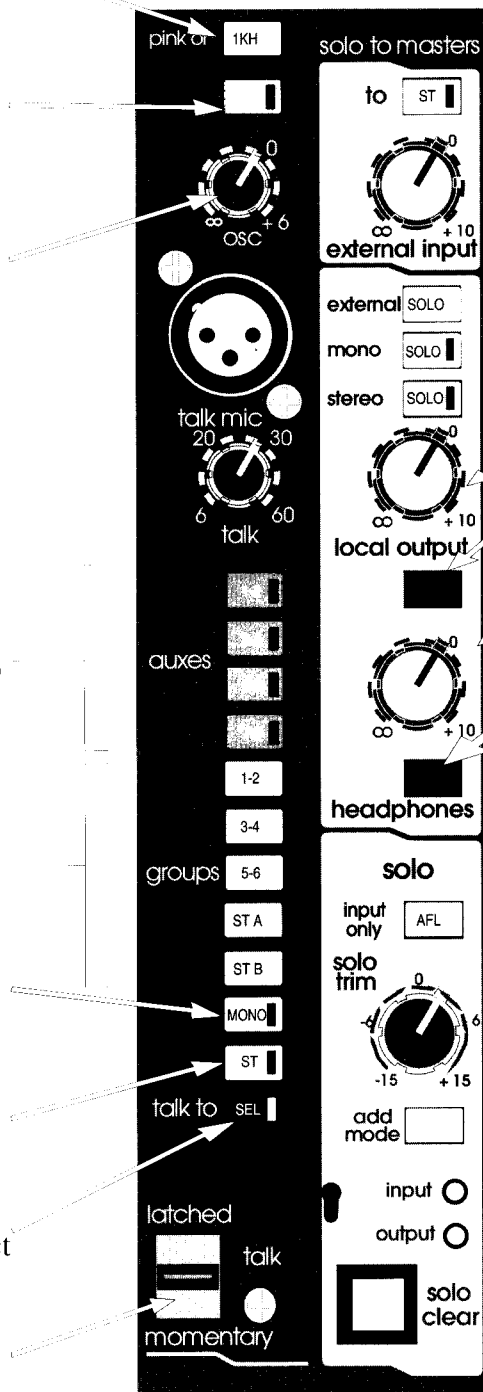

ST Connects the external input to the master left and right bus.
EXTERNAL INPUT LEVEL Adjusts the level of the External Input.

EXT SOLO Places the external input on the solo busses.
MONO Assigns the main Mono output to the solo system.
STEREO Assigns the main Stereo Left/Right output to the solo system.

LOCAL OUTPUT Adjusts the level of the local outputs.
MUTE Mutes the local output.

HEADPHONES Adjusts the level of the headphone output.
MUTE Mutes the headphone output.

AFL Selects the Solo mode
SOLO TRIM Adjusts the level of the Solo signal, most useful in the PFL mode.

ADD MODE In add mode, Solos are additive. Any number of Cue buttons may be pressed and the signals will be added. In normal mode, only one Solo may be active, so pressing a Solo will automatically cancel any previously selected Solo.

SOLO I/P LED Indicates that an input SOLO is active. Inputs take priority in normal mode, pressing an input SOLO will suspend any output SOLO until the input is released.

SOLO O/P LED Indicates that an output SOLO is active. This led will extinguish if an input SOLO is pressed while an output SOLO is already active.

SOLO CLEAR Clears all pressed SOLO buttons.

STEREO FADERS Control the level of the STEREO master busses.

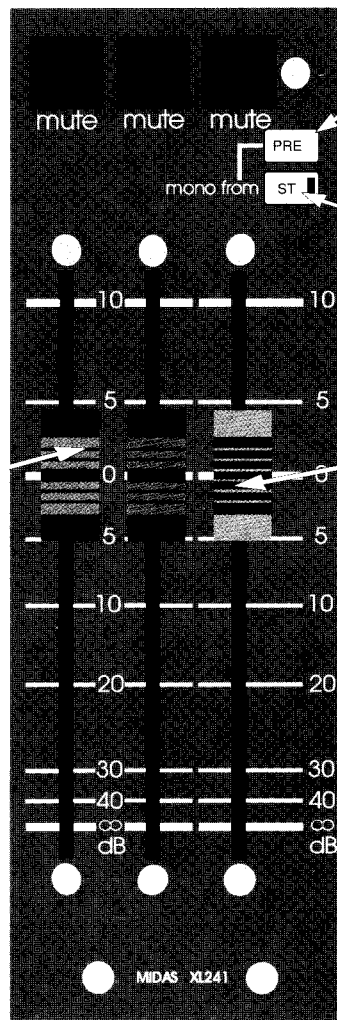

PRE Allows the signal feed from the main Left/Right outputs to the Mono output to be pre-fader rather than post-fader.

ST TO MONO Assigns the post-fader Left/Right Output to the main Mono output.

MONO FADER Controls the level of the MONO Master bus.

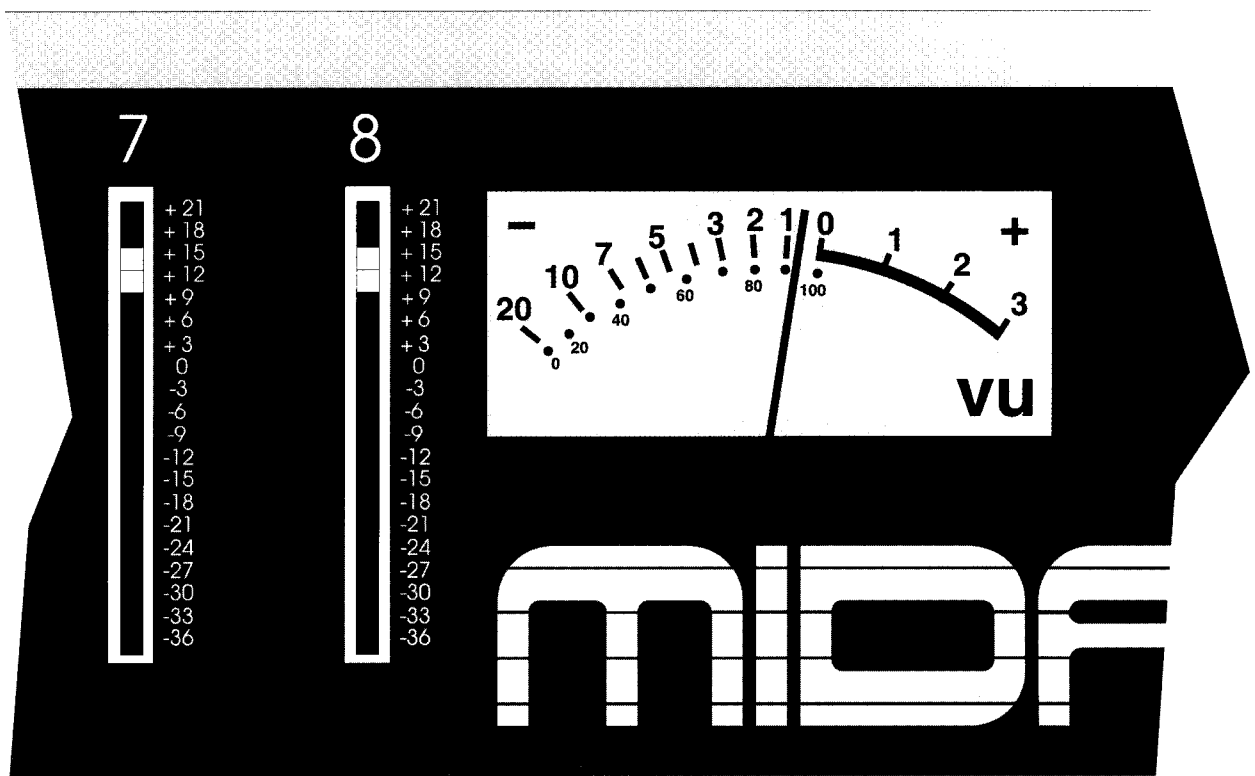

METERING

Separate LED ramps meter all input modules auxes, matrix and groups, while the mix outputs and solo functions are metered both with LED ramps and VU meters (as above).

