

POWERED MIXER

POWERPOD 1060

SERVICE MANUAL



PHONIC
www.phonic.com

POWERED MIXER

POWERPOD 1060**SERVICE MANUAL****CONTENTS**

PANE LAYOUT.....	3	PART LIST	
SYSTEM BLOCK DIAGRAM.....	4	MASTER & OUTPUT PCB-PART LIST	23
REAR SYSTEM BLOCK DIAGRAM.....	5	CHANNEL PCB-PART LIST.....	28
PCB		DIGITAL PCB-PART LIST.....	31
MASTER + CH7_8 & EFFECT PCB.....	6	AMPLIFIER PART LIST.....	33
CHANNEL 1_6 PCB.....	7	POWER PART LIST.....	37
DSP PCB.....	8	MISCELLANEOUS ITEMS.....	38
DSP SOLDER PCB.....	9	POWER REQUIREMENT CLASSIFICATION	42
AMPLIFIER PCB.....	10	IC LIST.....	44
POWER SUPPLY PCB.....	11		
SCHEMATIC		DIMENSIONS.....	45
L/R SUM SCHEMATIC.....	12	EXPLODED VIEW.....	46
CHANNEL 1~6 SCHEMATIC.....	13		
CHANNEL 7~8 SCHEMATIC.....	14		
DISPLAY & PRE SCHEMATIC.....	15		
REVERB DSP SCHEMATIC.....	16		
MON / EFX / CUE SUM SCHEMATIC....	17		
AMPLIFIER SCHEMATIC	18		
AC POWER SCHEMATIC	19		
OUTPUT SCHEMATIC.....	20		
REVERB D/A A/D SCHEMATIC.....	21		
X_MER SCHEMATIC.....	22		

Phonic reserves the right to improve or alter any information supplied within this document without prior notice.

V2.1 June. 9, 03

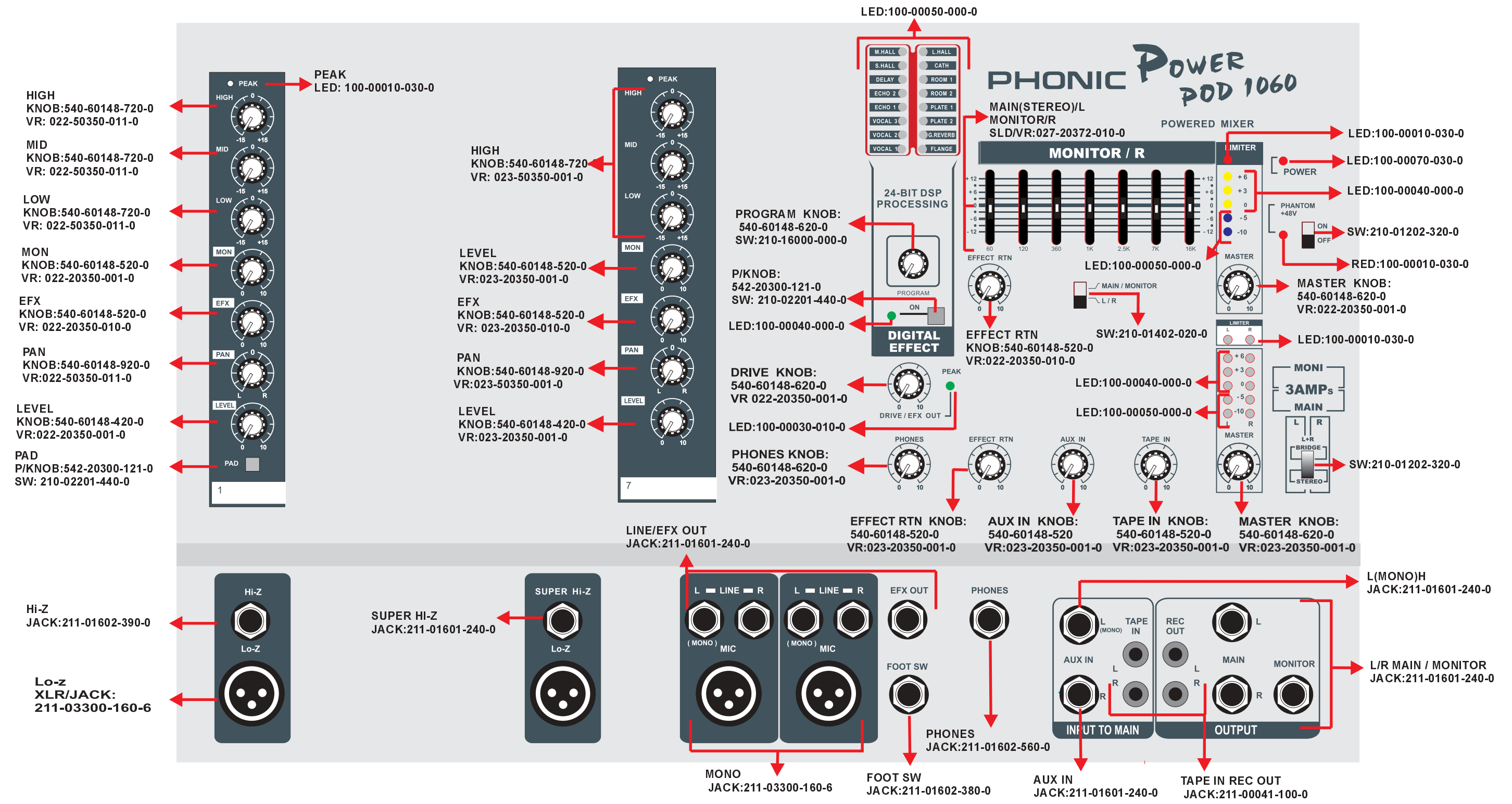

SYSTEM BLOCK DIAGRAM

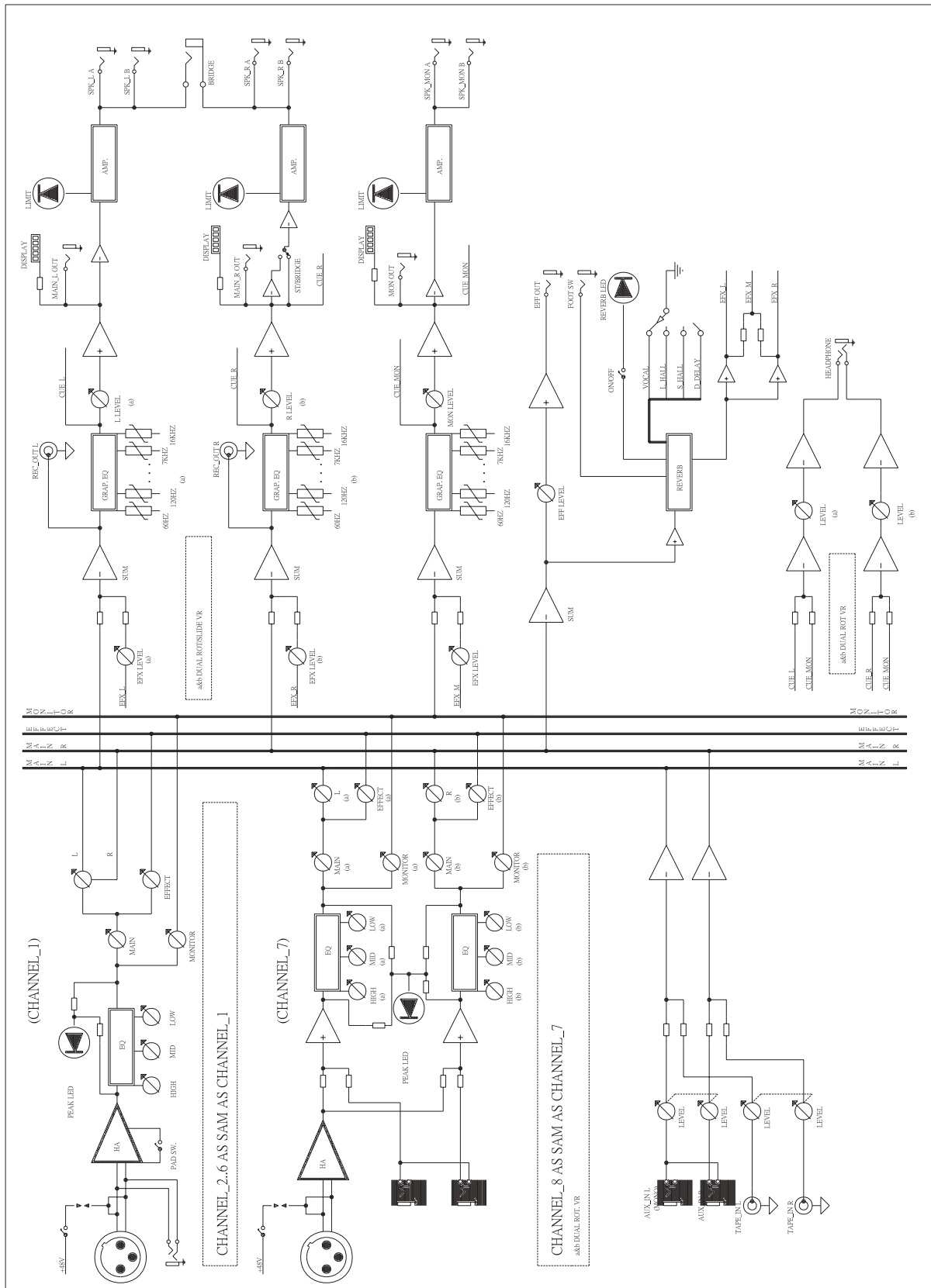

REAR SYSTEM BLOCK DIAGRAM

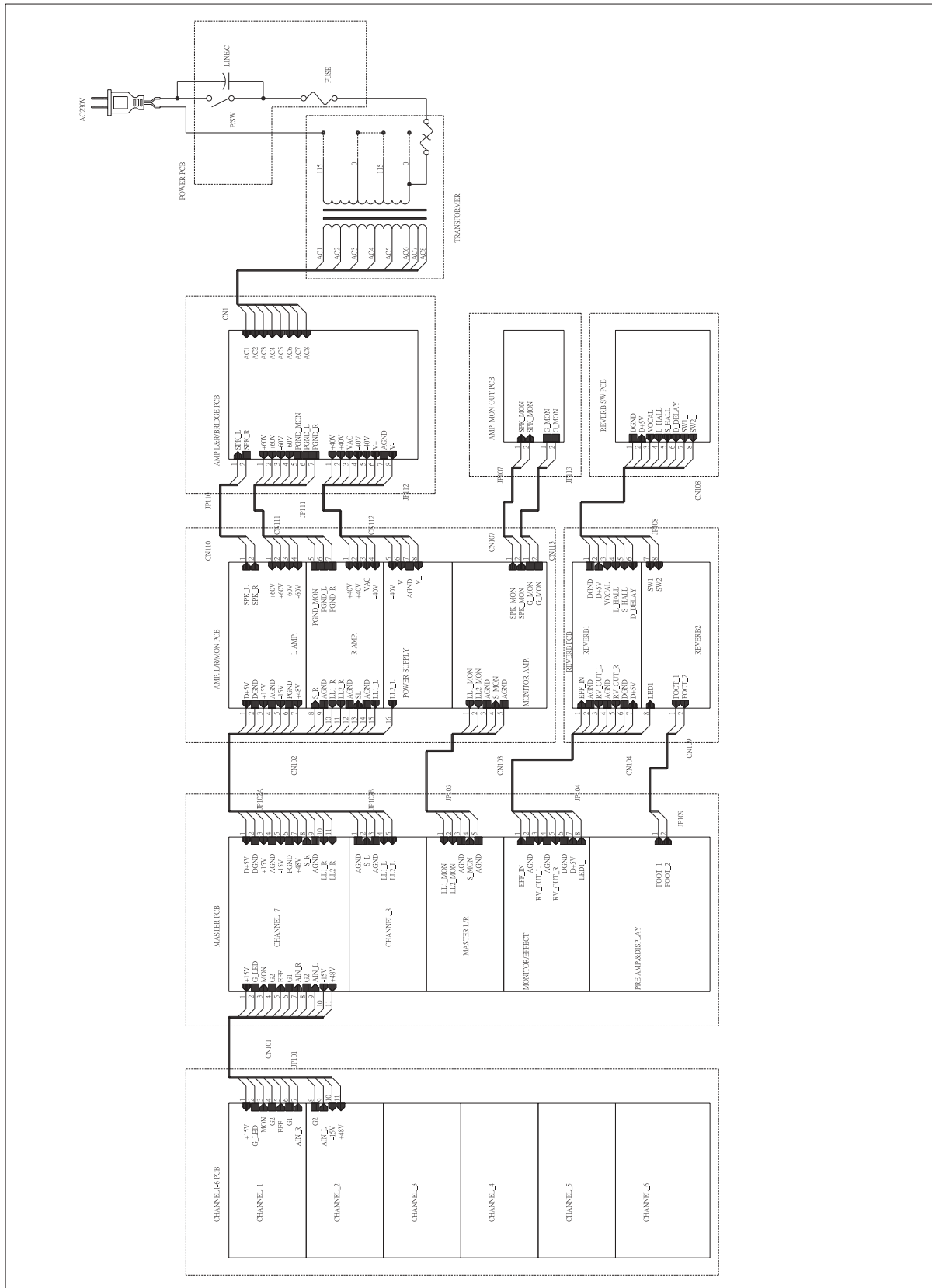

MASTER + CH7_8 & EFFECT PCB

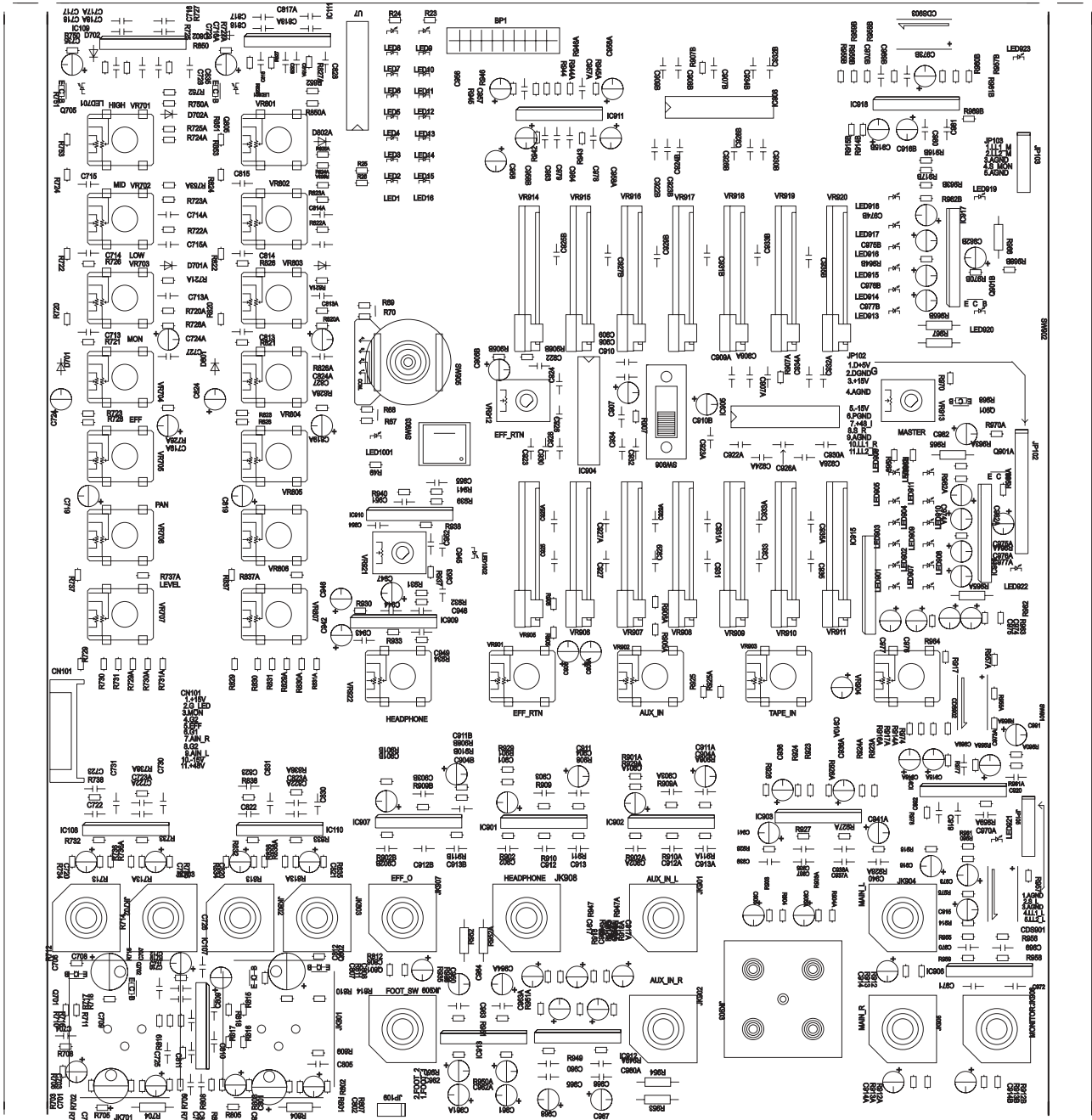

CHANNEL1_6 PCB

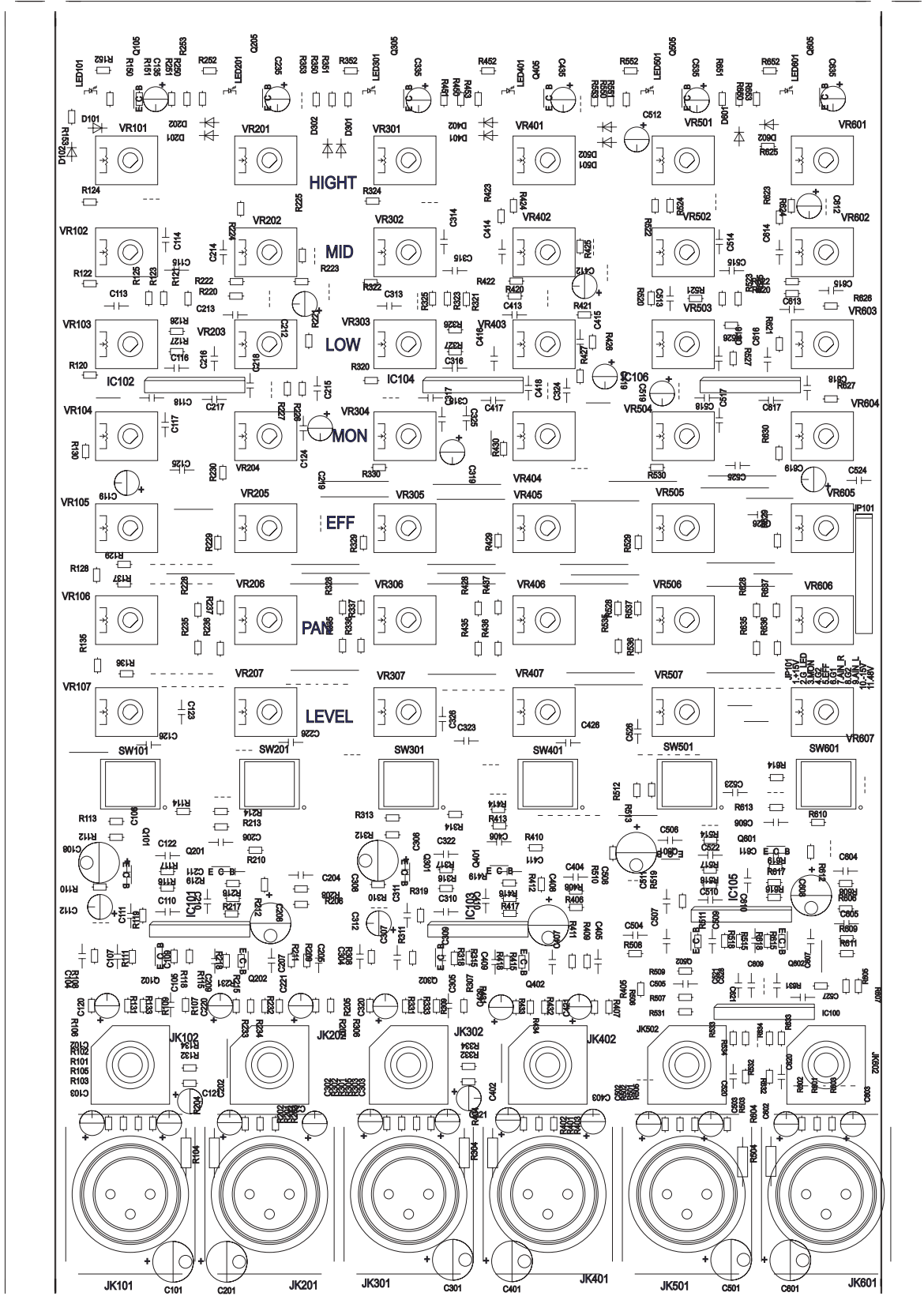

DSP PCB

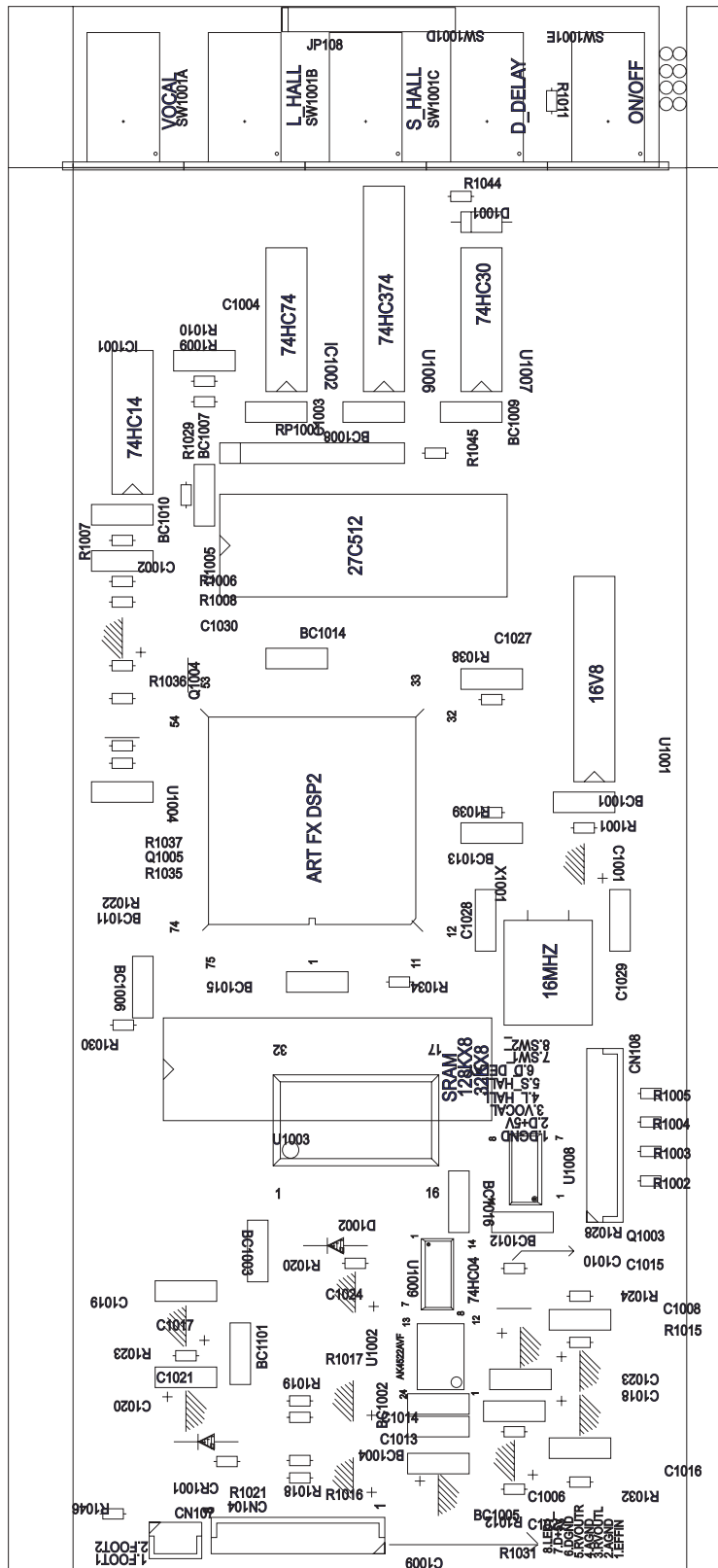

DSP SOLDER PCB

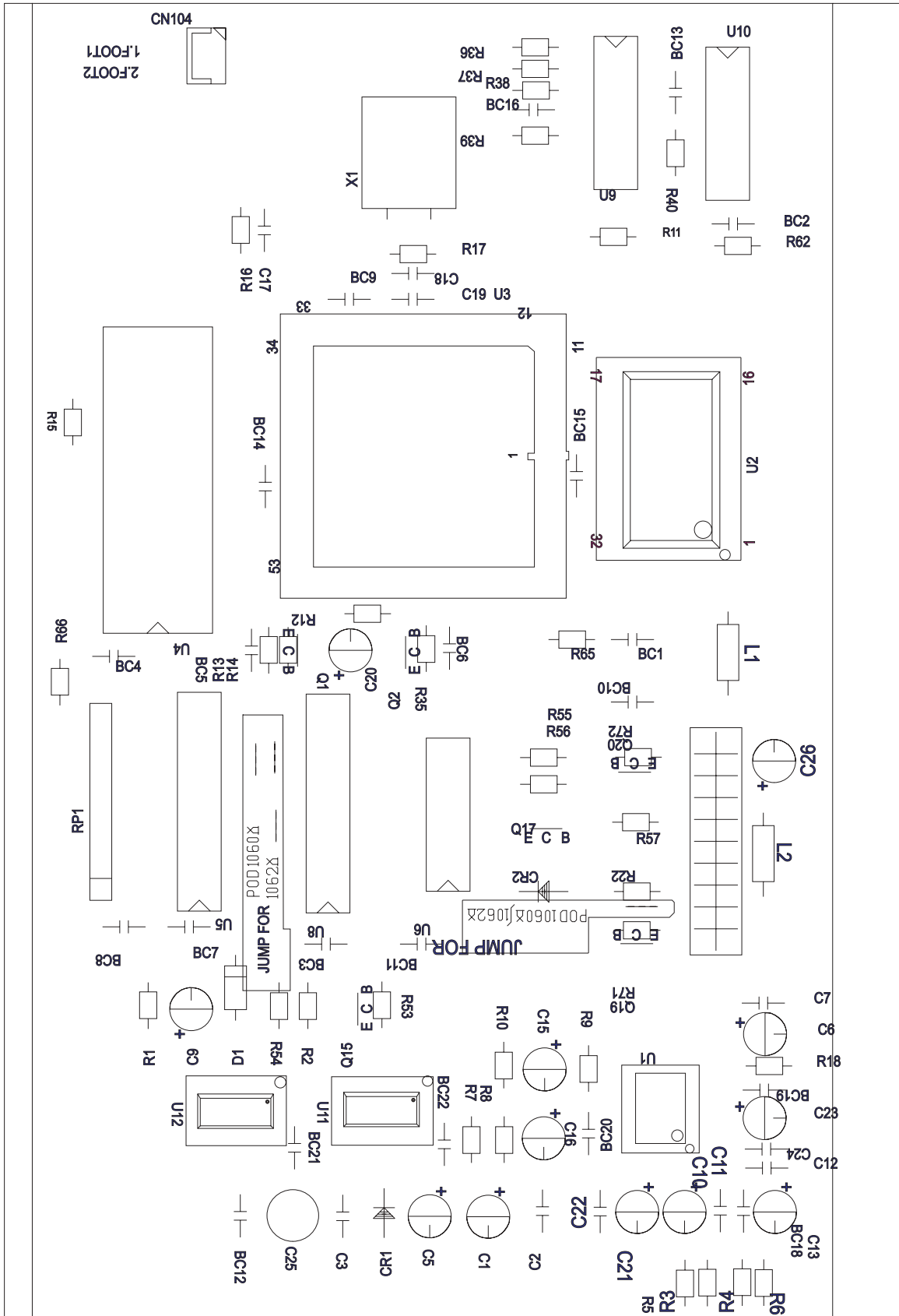

AMPLIFIER PCB

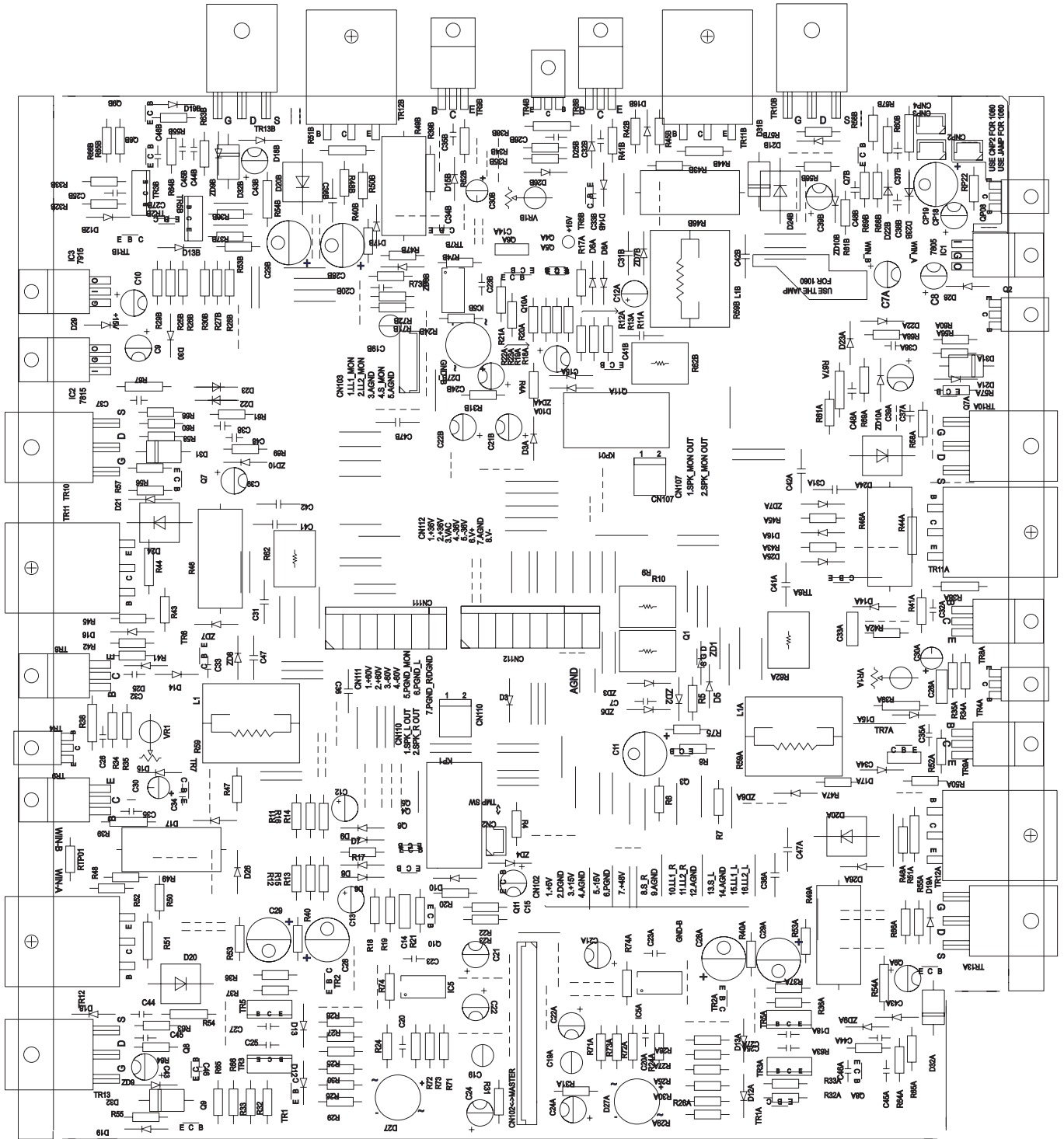

POWER SUPPLY PCB

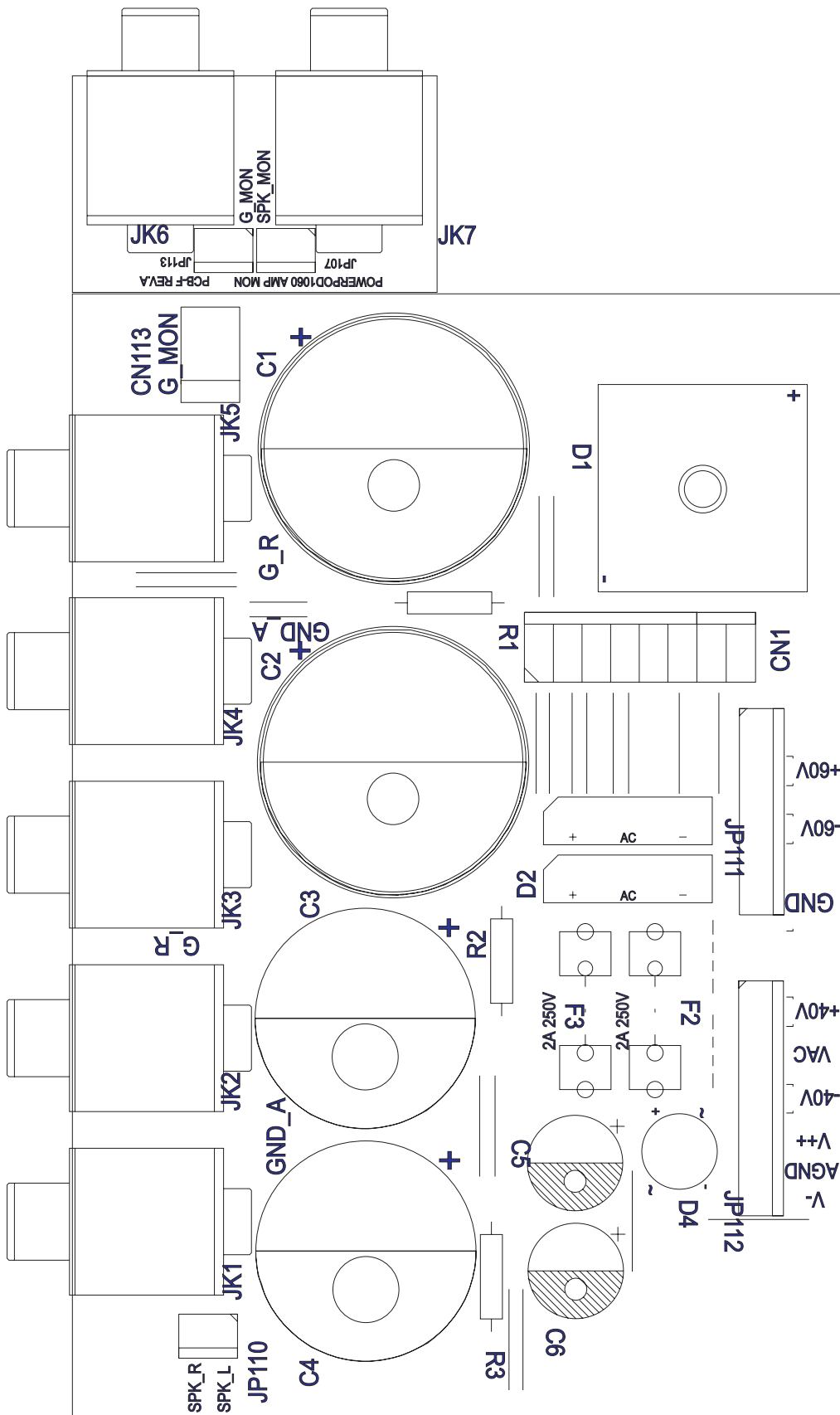

L/R SUM MASTER SCHEMATIC

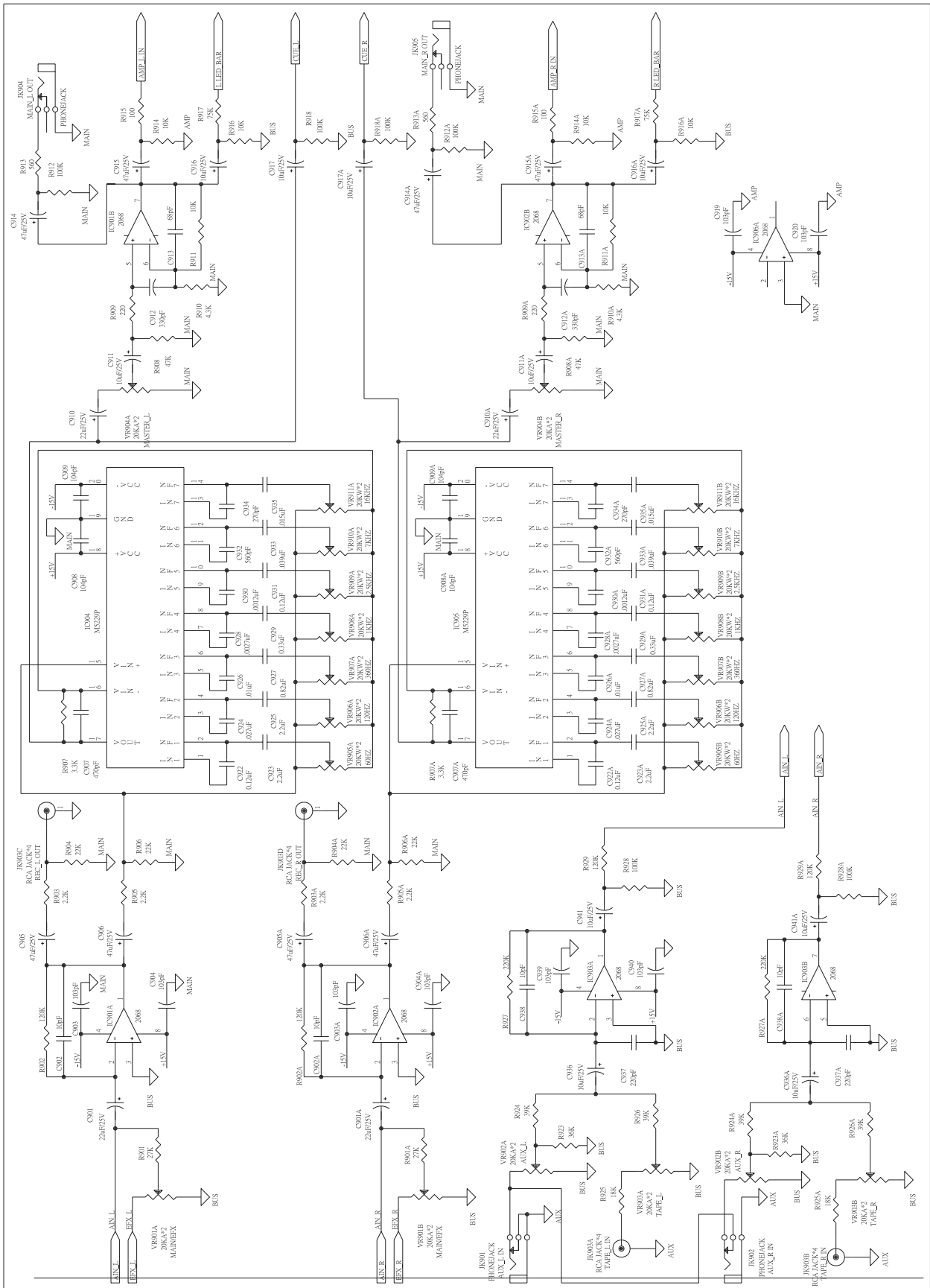

CH1_6 SCHEMATIC

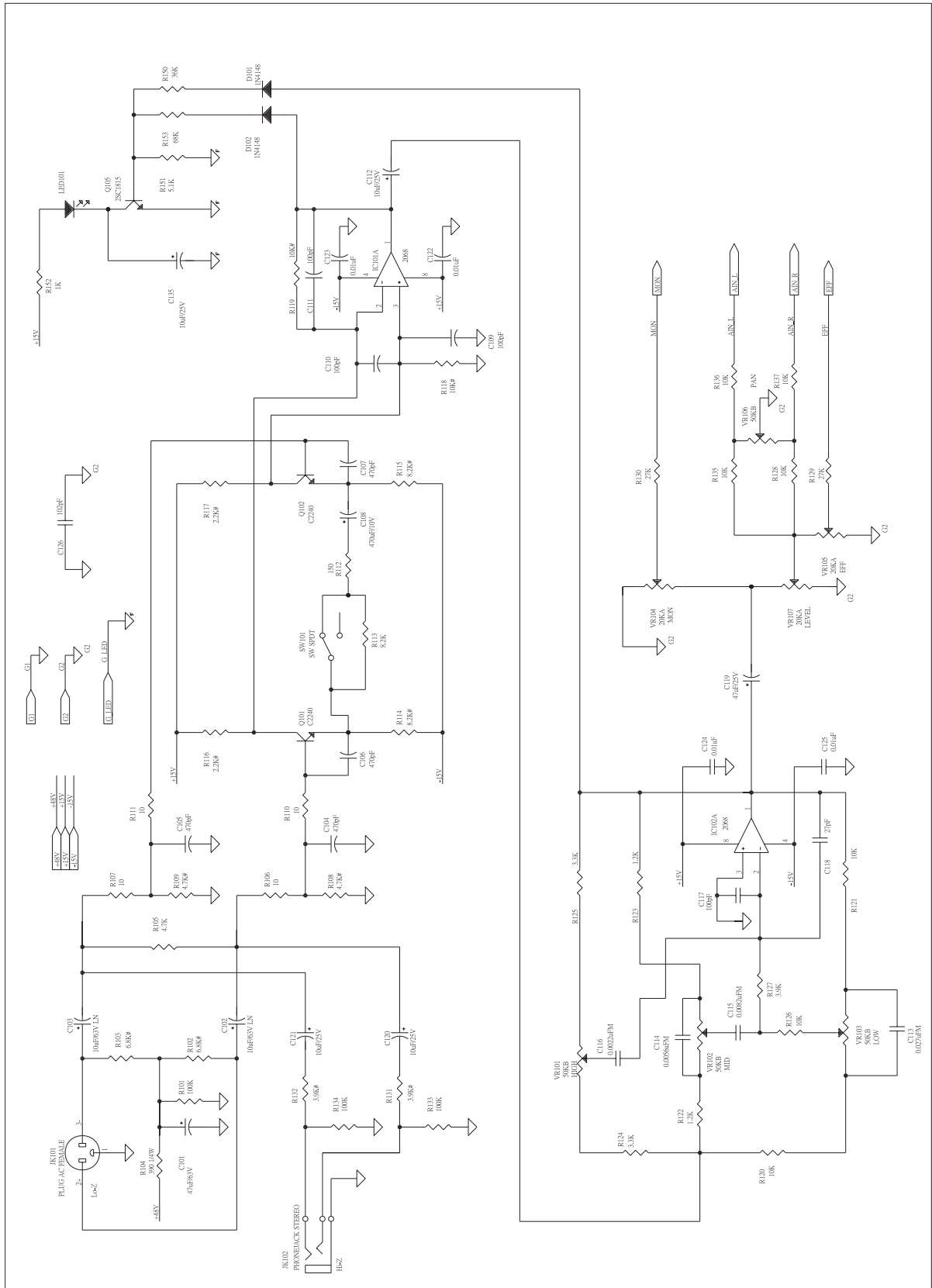

CH7_8 SCHEMATIC

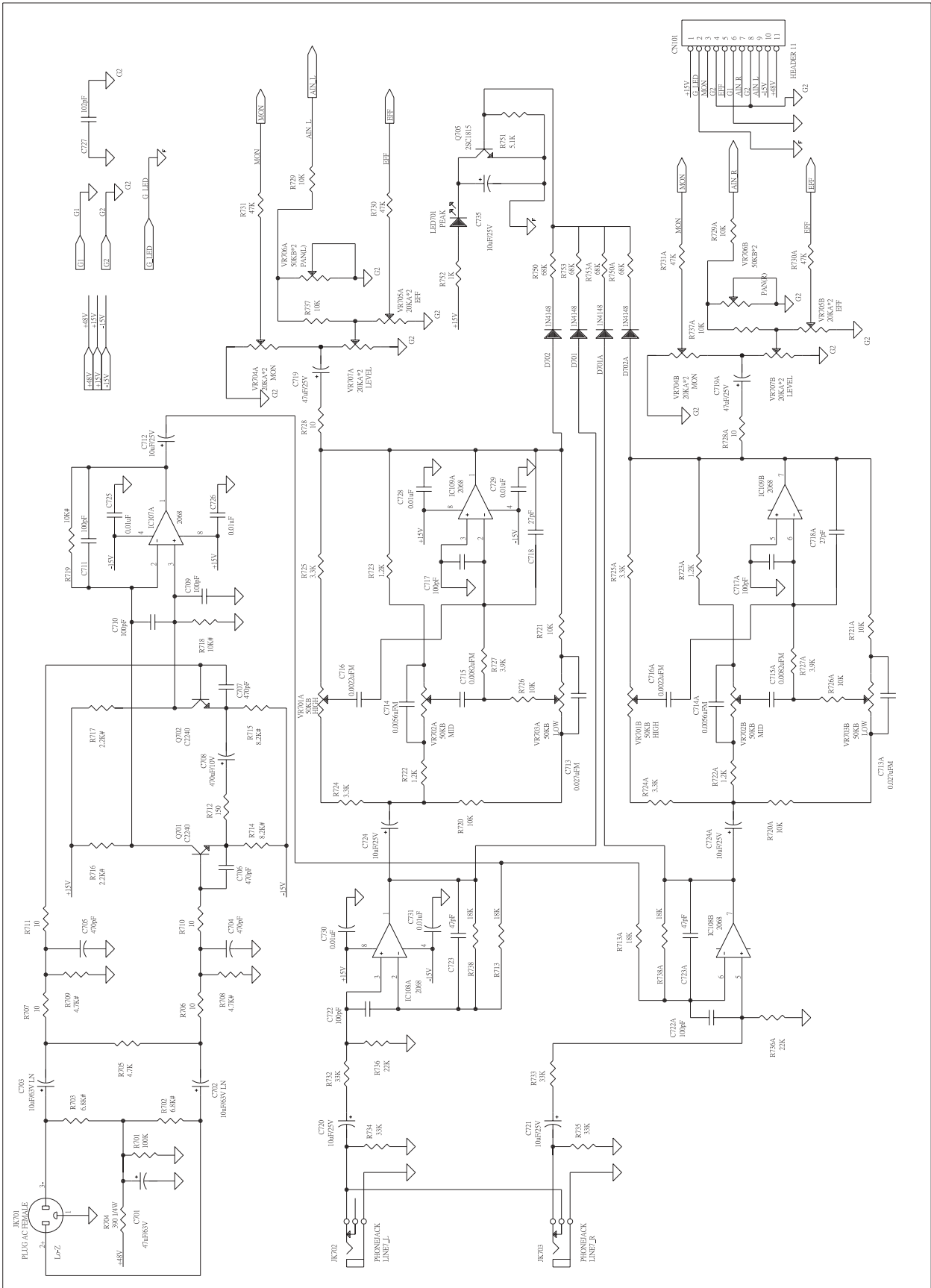

DISPLAY & PRE SCHEMATIC

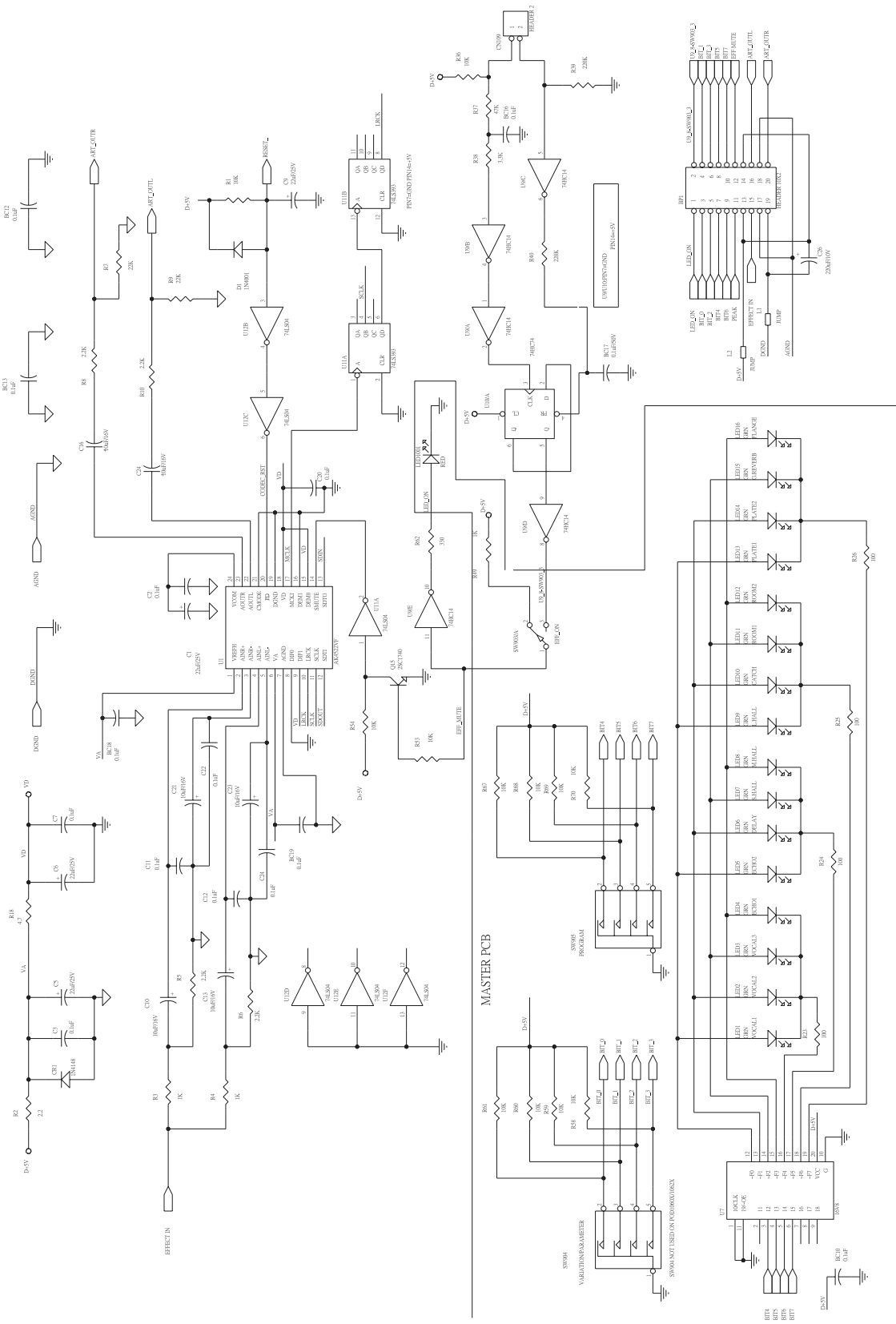

REVERB DSP SCHEMATIC

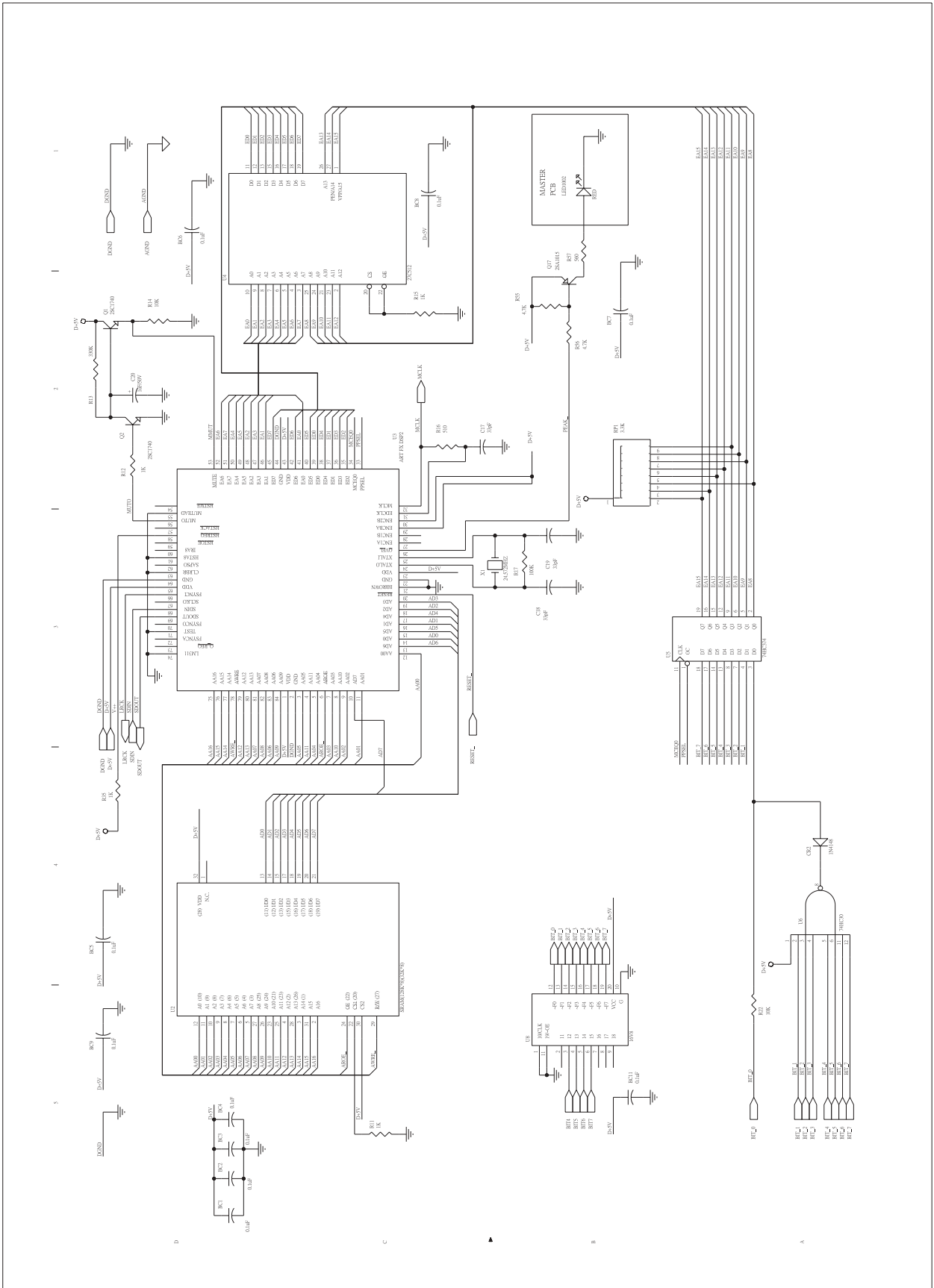

MON / EFX / CUE SUM SCHEMATIC

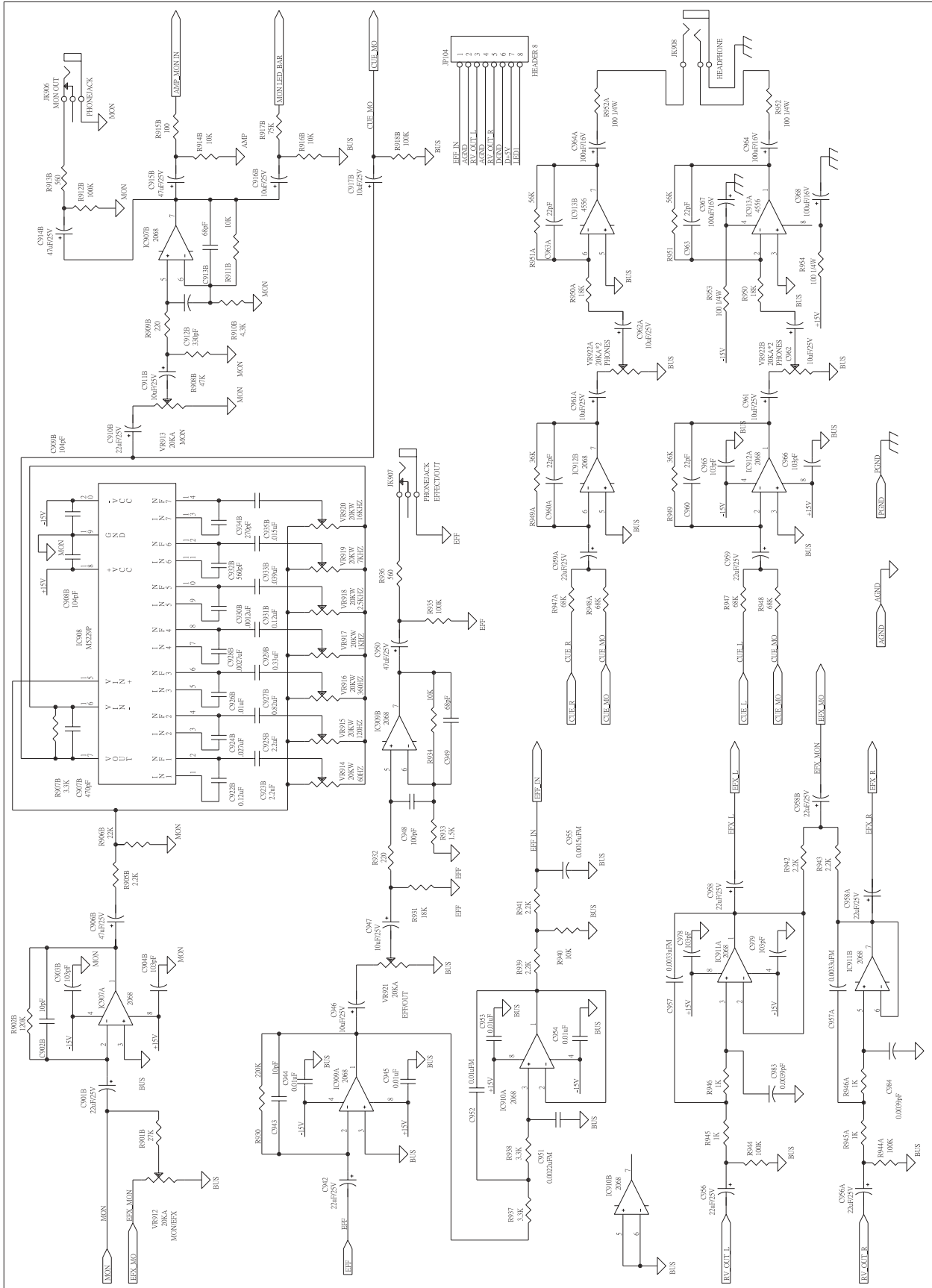

AMPLIFIER SCHEMATIC

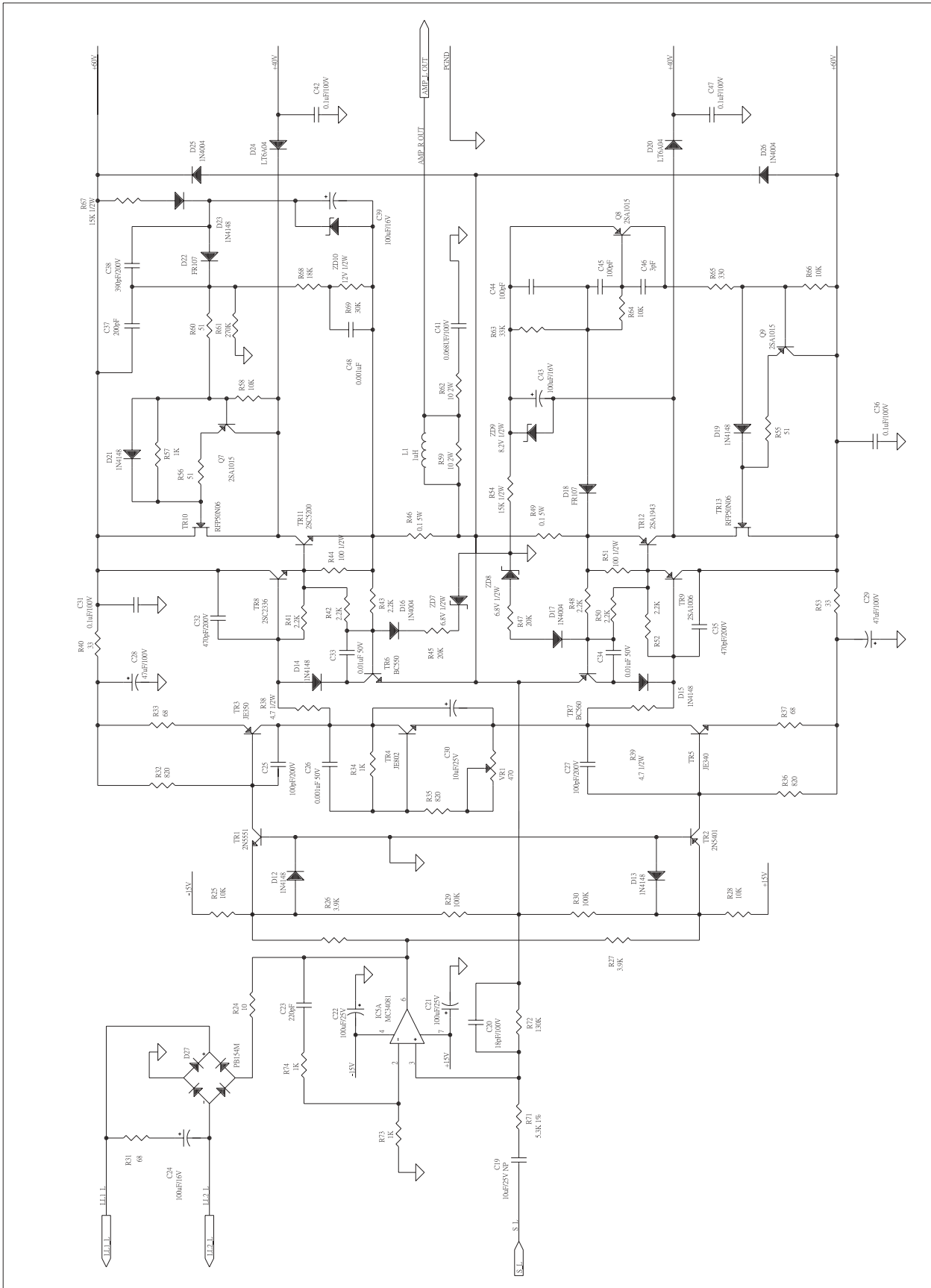

OUTPUT SCHEMATIC

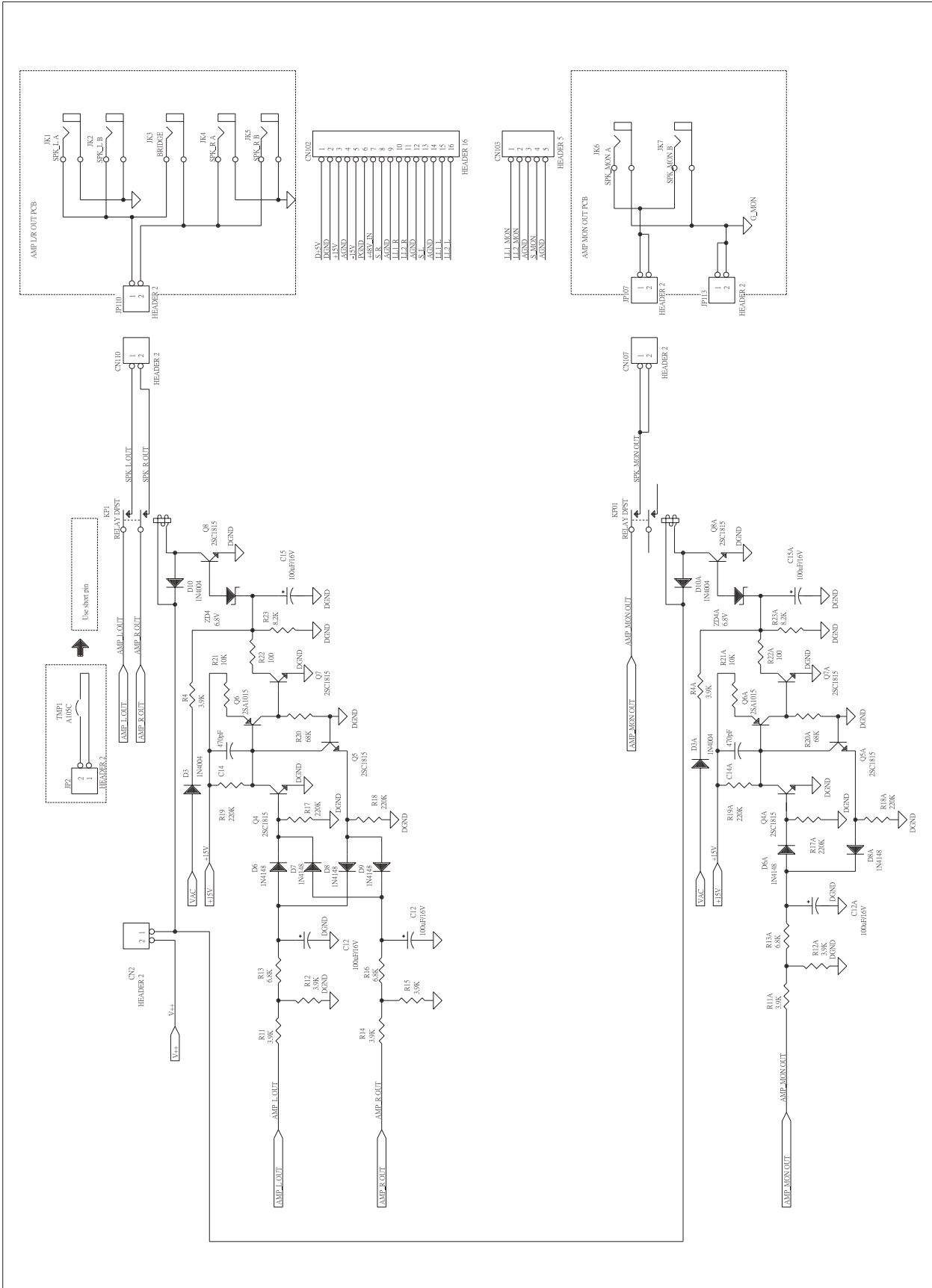

REVERB D/A A/D SCHEMATIC

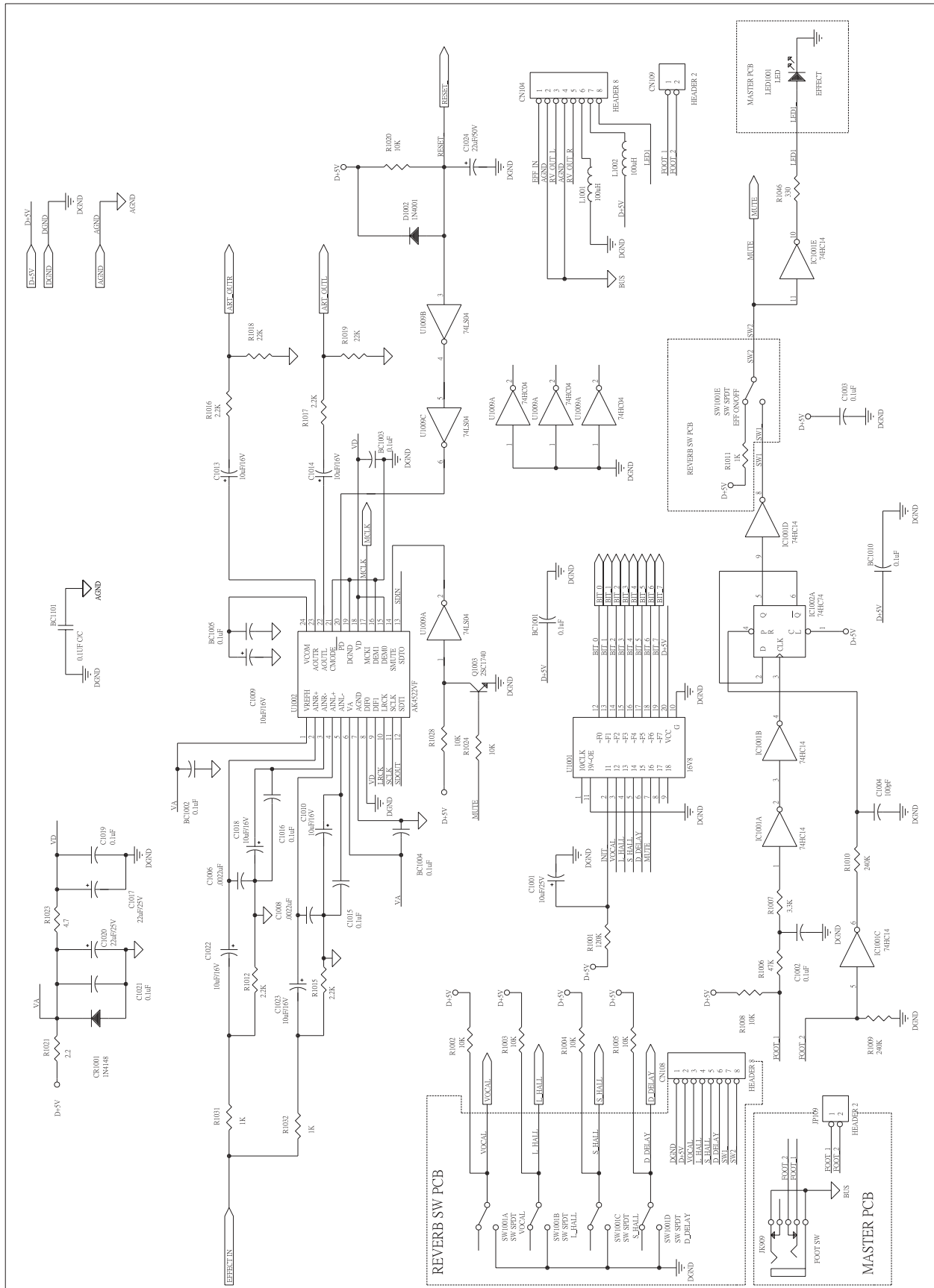

X_MER SCHEMATIC

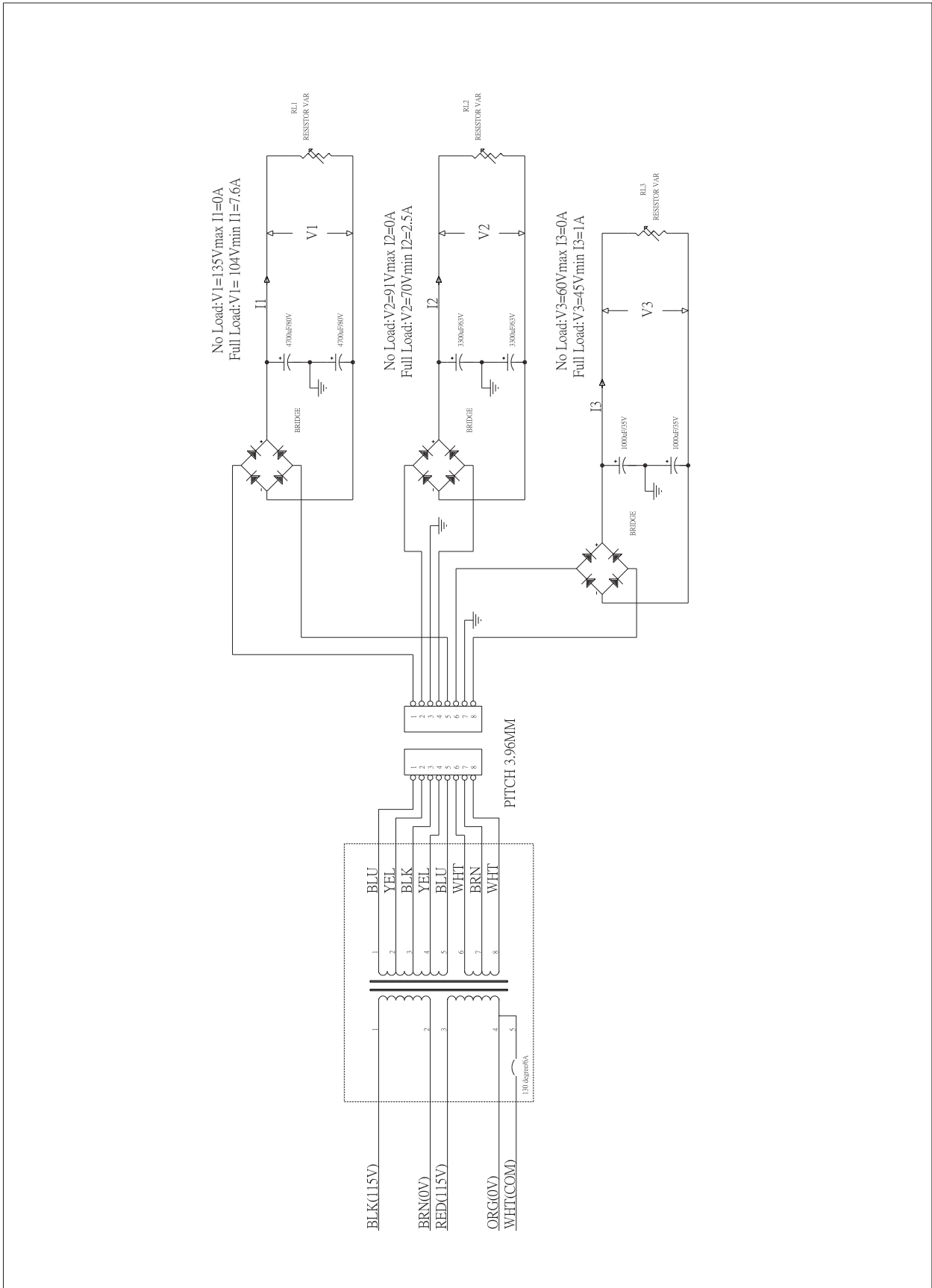

MASTER PCB-PART LIST

Ref.	Phonic Part No.	Specification
CDS901.902.903	010-00001-010-0	CDS P873-G35-552 HAMAMATSU
VR913.921	022-20350-001-0	S.ROT/VR 20KA L=30MM F=12MM
VR912	022-20350-010-0	S.ROT/VR 20KB 30MM P
VR704.707.804.807.902-904.922	023-20350-001-0	D.ROT/VR 20KA 30MM P
VR705.805.901	023-20350-010-0	D.ROT/VR 20KB 30MM P
VR701.702.703.706.801.802.803.806	023-50350-001-0	D.ROT/VR 50KB(C.C) 30MM P
VR905-911.914-920	027-20372-010-0	D.SLD/VR 20KW*2 20MM P
C923.923A.923B.925.925A.925B	037-22535-061-0	T/C 2.2MF K 16V T 5
929.929A.929B	040-33426-100-0	ML/C 0.33MF M 50V P 5 T
C927.927A.927B	040-82426-140-0	ML/C 0.82MF M 50V 5 T
D701.701A.702.702A.801.801A.802.802A	090-02000-020-0	DIODE 1N4148 SPECT26MM MINI
LED701.801.906.912..918.920-923.1001	100-00010-030-0	LED BL-B5141 RED
LED903.904.905.909.910.911.915.916.917	100-00040-000-0	LED 204YD YLW
LED901.902.907.908.913.914	100-00050-000-0	LED BL-B2141 GRN
LED919	100-00070-030-0	LED 204UBD D3 BLUE
IC904.905.908	160-00002-300-0	IC M5229P MITSUBISHI
IC107-111.901.902.903.906.907.909-912.914.918	160-00007-510-0	IC NJM2068L JRC
IC913	160-00018-000-0	IC NJM4556AL JRC
IC915.916.917	160-00019-100-0	IC BA6137
SW901.902	210-01202-320-0	SLD/SW SS-22F-11G(NON SHORTING)
JK903	211-00041-100-0	4P RCA/J RL-1414-4D
JK702.703.802.803.901.902.904-907	211-01601-240-0	6D3/J JY-6351-02-130 SCJ-0658
JK909	211-01602-380-0	6D3/J (SCJ-0658-Y)
JK908	211-01602-560-0	6D4/J YLJ-6405-300 (NUT&WASHER)
JK701.801	211-03300-160-6	XLR/J SKCA229-1K3F2
CN101	211-10110-000-0	11P WAFER/S A2001WV2-11P
JP109	212-10023-280-0	2P WAFER/P 220mm UL1007#24

MASTER PCB-PART LIST

Ref.	Phonic Part No.	Specification
JP103	212-10051-260-0	5P WAFER/P 1000mm UL1007#24 PITCH:2.5
JP104	212-10080-530-0	8P WAFER/P 150mm UL1007#26 PITCH:2.5
JP102AB	212-10160-050-0	16P WAFER/P 1000mm UL1007#24 PITCH2.5
ALL LED*23	615-20092-620-0	LED HOUSING LED3-13
R706.707.710.711.728.728A.806.8 07.810.811.828.828A	000-10006-400-0	CF RES. 10 J 1/8W T
R915.915A.915B960.960A.960B	000-10106-400-0	CF RES. 100 J 1/8W T
R952.952A.953.954	000-10126-400-0	CF RES. 100 J 0.25W T
R752.852.945.945A.946.946A.963 .963A.963B	000-10206-400-0	CF RES. 1K J 1/8W T
R966.967	000-10226-400-0	CF RES. 1K J 0.25W T
R720.720A.721.721A.726.726A.72 9.729A.820.820A.821.821A.826.8 26A.911.911A.B914	000-10306-400-0	CF RES. 10K J 1/8W T
R914B.916.916A.B934.940.955.95 5A.B.961.961A.B.962.A.B964.964 A.B968.968A.B	000-10306-400-1	
R914A.829.829A.737.737A.837.83 7A	000-10306-400-2	
R701.801.912.912A.B.918.918A.B .928.928A. 935.944.944A	000-10406-400-0	CF RES. 100K J 1/8W T
R722.722A.723.723A.822.822A.82 3.823A.969.969A.B	000-12206-400-0	CF RES. 1K2 J 1/8W T
R902.902A.902B.929.929A	000-12406-400-0	CF RES. 120K J 1/8W T
R712.812	000-15106-400-0	CF RES.150J 1/8W T
R933	000-15206-400-0	CF RES. 1K5 J 1/8W T
R713.713A.738.738A.813.813A.83 8.838A.925.925A.931.950.950A	000-18306-400-0	CF RES. 18K J 1/8W T
R909.909A.909B.932	000-22106-400-0	CF RES. 220 J 1/8W T
R903.903A.905.905A.B.942.943	000-22206-400-0	CF RES. 2K2 J 1/8W T
R736.736A.836.836A.904.904A.90 6.906A.906	000-22306-400-0	CF RES. 22K J 1/8W T B
R930.927.927A	000-22406-400-0	CF RES. 220K J 1/8W T
R901.1901A.901B958.958A.958B	000-27306-400-0	CF RES. 27K J 1/8W T

MASTER PCB-PART LIST

Ref.	Phonic Part No.	Specification
R724.724A.725.725A.824.824A.82 5.825A.907.907A.B.937.938.956.9 56A.B.957.957A.957B	000-33206-400-0	CF RES. 3K3 J 1/8W T
R732-735.832-835.959.959A.B	000-33306-400-0	CF RES. 33K J 1/8W T
R923.923A.949.949A	000-36306-400-0	CF RES. 36K J 1/8W T
R704.804	000-39126-400-0	CF RES. 390 J 0.25W T
R727.727A.827.827A	000-39206-400-0	CF RES 3K9 J 1/8W T
R924.924A.926.926A	000-39306-400-0	CF RES. 39K J 1/8W T
R910.910A.910B	000-43206-400-0	CF RES. 4K3 J 1/8W T
R705.805.970.970A.970B	000-47206-400-0	CF RES 4.7K J 1/8W T
R730.730A.731.731A.830.830A.83 1.831A.908.908A.908B	000-47306-400-0	CF RES. 47K J 1/8W T
R751.851	000-51206-400-0	CF RES. 5K1 J 1/8W T
R913.913A.913B.936	000-56106-400-0	CF RES. 560 J 1/8W T
R951.951A	000-56306-400-0	CF RES.56K J 1/8W T
R922	000-62206-400-0	CF RES. 6K2 J 1/8W T
R965.965A.965B	000-68126-400-0	CF RES. 680 J 0.25W T
R750.750A.753.753A.850.850A.85 3.853A.947.947A.948.948A	000-68306-400-0	CF RES. 68K J 1/8W T
R917.917A.917B	000-75306-400-0	CF RES 75K J 1/8W T
R718.719.818.819	006-10020-440-0	MF RES 10K F 1/8W T
R716.717.816.817	006-22010-440-0	MF RES 2K2 F 1/8W T
R708.709.808.809	006-47010-440-0	MF RES 4K7 F 1/8W T
R702.703.802.803	006-68010-440-0	MF RES 6K8 F 1/8W T
R714.715.814.815	006-82010-440-0	MF RES 8K2 F 1/8W T
C712.720.721.724.724A.735.812.8 20.821.824.824A.835.911.A.B916. A.B917.A.B936	030-10638-0A0-0	E/C 10MF Z 25V 5*11 T
C936A.941.941A946.947.961.961 A.962.962A.976.976A.976B	030-10638-0A0-1	
C964.964A.967.968	030-10728-0A0-0	E/C 100MF Z 16V 6*11 T
C975.975A.975B.977.977A.977B	030-10736-0A0-0	E/C 100MF M 25V 8*11 T
C901.A.B910.A. B942.956.956A.958.A. B959.959A. 974.A. B982.A.B	030-22638-0A0-0	E/C 22MF Z 25V 5*11 T
C719.719A.819.819A.905.905A.90 6.A.B914.A.B915.A.B950.973.A.B	030-47638-0A0-0	E/C 47MF Z 25V 6.3*11 T

MASTER PCB-PART LIST

Ref.	Phonic Part No.	Specification
	030-47666-0A0-0	E/C 47MF M 63V T
C708.808	030-47718-0A0-0	E/C 470MF Z 10V 8*11 T
C702.703.802.803	033-10664-0A0-0	LN E/C 10MF J 63V T 6*11
C926.926A.926B	040-10325-150-0	ML/C 0.01MF K 50V M 5 AL T
C922.922A.922B.931.931A.931B CE-1717	040-12425-160-6	ML/C 0.12MF K 50V 5 T
C935.935A.935B	040-15325-100-0	ML/C 0.015MF K 50V P 5 T
C924.924A.924B	040-27325-160-0	ML/C 0.027MF K 50V 5 T
C933.933A.933B	040-39325-160-0	ML/C 0.039UF K 50V 5 T
C902.902A.902B.938.938A.943	042-10025-050-0	C/C2 10PF K 50V 5 T
C709.710.711.717.717A.722.722A .809.810.811.817.817A.822.822A. 948.970.970A.B	042-10124-050-0	C/C2 100PF J 50V T
C727.827	042-10225-050-0	C/C2 0.001MF K 50V 5 T
C903.903A.903B.904.904A.904B. 919.920.939.940.965.966.971.972. 978-981	042-10325-050-0	C/C2 0.01MF K 50V T
C908.908A.908B.909.909A.909B	042-10426-050-0	C/C2 0.1MF M 50V 5 T
C960.960A.963.963A	042-22024-050-0	C/C2 22PF J 50V 5 T
C937.937A	042-22124-050-0	C/C2 220PF J 50V 5 T
C718.718A.818.818A	042-27025-050-0	C/C 27PF K 50V T
C934.934A.934B	042-27125-050-0	C/C2 270PF K 50V 5 T
C912.912A.912B.969.969A.969B	042-33125-050-0	C/C2 330PF K 50V T
C723.723A.823.823A	042-47024-050-0	C/C2 47PF J 50V 5 T
C704-707.804-807.907.907A.907B	042-47124-050-0	C/C2 470PF J 50V 5 T
C932.932A.932B	042-56124-050-0	C/C2 560PF J 50V 5 T
C913.913A.913B.949	042-68024-050-0	C/C2 68PF J 50V 5 T
C725.726.728-731.828-831.944.94 5.952.953.954	046-10304-060-0	M/C 0.01MF J 50V 5 T
C930.930A.930B	046-12204-060-0	M/C 0.0012MF J 50V 5 T
C716.716A.816.816A.951	046-22204-060-0	M/C 0.0022MF J 50V 5 T
C928.928A.928B	046-27204-060-0	M/C 0.0027MF J 50V 5 T
C713.713A.813.813A	046-27305-060-0	M/C 0.027UF K 50V T
C714.714A.814.814A	046-56204-060-0	M/C 0.0056MF J 50V T
C715.715A.815.815A	046-82204-060-0	M/C 0.0082 MF J 50V 5 T
Q705.805.901.901A.901B	120-00000-800-0	TRAN. 2SC1815 GR TOSHIBA
Q701.702.801.802	120-00001-010-0	TRAN 2SC2240-BL TOSHIBA

MASTER PCB-PART LIST

Ref.	Phonic Part No.	Specification
	290-01320-201-0	PCB POWERPOD1060 B MASTER
R939.941	382-20005-010-0	TINNER WIRE 5.0MM D0.6

CH PCB-PART LIST

Ref.	Phonic Part No.	Specification
VR104.107.204.207.304.307.404.4 07.504.507.604.607	022-20350-001-0	S.ROT/VR 20KA L=30MM F=12MM
VR105.205.305.405.505.605	022-20350-010-0	S.ROT/VR 20KB 30MM P
VR101-103.106.201-203.206.301- 303.306.401-403.406.501-503.506 .601-603.606.	022-50350-011-0	S.ROT/VR 50KB(C.C)L=30MM
C101.201.301.401.501.601	030-47666-0A0-0	E/C 47MF M 63V T
D101.102.201.202.301.302.401.40 2.501.502.601.602	090-02000-020-0	DIODE 1N4148 SPECT26MM MINI
LED101.201.301.401.501.601	100-00010-030-0	LED BL-B5141 RED
IC101-106.	160-00007-510-0	IC NJM2068L JRC
SW101.201.301.401.501.601	210-02201-440-0	PSH/SW 2P2T SFPC12MC03-PF
JK102.202.302.402.502.602	211-01602-390-0	6D3/J JY-6351-02-030 SCJ-0658
JK101.201.301.401.501.601	211-03300-160-6	XLR/J SKCA229-1K3F2
JP101	212-10110-160-0	11P WAFER/P 100mm UL1007#24 PITCH:2.0
ALL LED*6	615-20092-620-0	LED HOUSING LED3-13
R106.107.110.111.206.207.210.21 1.306.307.310.311.406.407.410.41 1.506.507.510.511	000-10006-400-0	CF RES. 10 J 1/8W T
R606.607.610.611	000-10006-400-1	
R152.252.352.452.552.652	000-10206-400-0	CF RES. 1K J 1/8W T
R120.121.126.128.135-137.220.22 1.226.228.235-237.320.321.326.3 28.335-337.420.421	000-10306-400-0	CF RES. 10K J 1/8W T
426.428.435-437.520.521.526.528 .535.536.537.620.621.626.628.635 -637	000-10306-400-1	
R101.133.134.201.233.234.301.33 3.334.401.433.434.501.533.534.60 1.633.634	000-10406-400-0	CF RES. 100K J 1/8W T
R122.123.222.223.322.323.422.42 3.522.523.622.623	000-12206-400-0	CF RES. 1K2 J 1/8W T
R112.212.312.412.512.612	000-15106-400-0	CF RES.150J 1/8W T
R129.130.229.230.329.330.429.43 0.529.530.629.630	000-27306-400-0	CF RES. 27K J 1/8W T
R124.125.224.225.324.325.424.42	000-33206-400-0	CF RES. 3K3 J 1/8W T

CH PCB-PART LIST

Ref.	Phonic Part No.	Specification
R150.250.350.450.550.650	000-36306-400-0	CF RES. 36K J 1/8W T
R104.204.304.404.504.604	000-39126-400-0	CF RES. 390 J 0.25W T
R127.227.327.427.527.627	000-39206-400-0	CF RES 3K9 J 1/8W T
R105.205.305.405.505.605	000-47206-400-0	CF RES 4.7K J 1/8W T
R151.251.351.451.551.651	000-51206-400-0	CF RES. 5K1 J 1/8W T
R153.253.353.453.553.653	000-68306-400-0	CF RES. 68K J 1/8W T
R113.213.313.413.513.613	000-82206-400-0	CF RES. 8K2 J 1/8W T
R118.119.218.219.318.319.418.419.518.519.618.619	006-10020-440-0	MF RES 10K F 1/8W T
R116.117.216.217.316.317.416.417.516.517.616.617	006-22010-440-0	MF RES 2K2 F 1/8W T
R131.132.231.232.331.332.431.432.531.532.631.632	006-39010-440-0	MF RES 3K9 F 1/8W T
R108.109.208.209.308.309.408.409.508.509.608.609	006-47010-440-0	MF RES 4K7 F 1/8W T
R102.103.202.203.302.303.402.403.502.503.602.603	006-68010-440-0	MF RES 6K8 F 1/8W T
R114.115.214.215.314.315.414.415.514.515.614.615	006-82010-440-0	MF RES 8K2 F 1/8W T
C112.120.121.135.212.220.221.235.312.320.321.335.412.420.421.435.512.520.521.535	030-10638-0A0-0	E/C 10MF Z 25V 5*11 T
C612.620.621.635	030-10638-0A0-1	
C119.219.319.419.519.619	030-47638-0A0-0	E/C 47MF Z 25V 6.3*11 T
C108.208.308.408.508.608	030-47718-0A0-0	E/C 470MF Z 10V 8*11 T
C102.103.202.203.302.303.402.403.502.503.602.603	033-10664-0A0-0	LN E/C 10MF J 63V T 6*11
C109.110.111.117.209.210.211.217.309.310.311.317.409.410.411.417.509.510.511.517	042-10124-050-0	C/C2 100PF J 50V T
C609.610.611.617	042-10124-050-1	
C126.226.326.426.526.626	042-10225-050-0	C/C2 0.001MF K 50V 5 T
C118.218.318.418.518.618	042-27025-050-0	C/C 27PF K 50V T
C104-107.204-207.304-307.404-407.504-507.604-607	042-47124-050-0	C/C2 470PF J 50V 5 T
C122-125.322-325.522-525	046-10304-060-0	M/C 0.01MF J 50V 5 T
C116.216.316.416.516.616	046-22204-060-0	M/C 0.0022MF J 50V 5 T

CH PCB-PART LIST

Ref.	Phonic Part No.	Specification
113.213.313.413.513.613	046-27305-060-0	M/C 0.027UF K 50V T
C114.214.314.414.514.614	046-56204-060-0	M/C 0.0056MF J 50V T
C115.215.315.415.515.615	046-82204-060-0	M/C 0.0082 MF J 50V 5 T
Q105.205.305.405.505.605	120-00000-800-0	TRAN. 2SC1815 GR TOSHIBA
Q101.102.201.202.301.302.401.402.501.502.601.602	120-00001-010-0	TRAN 2SC2240-BL TOSHIBA
	290-61060-100-0	CHANNEL PCB 94V0 POD1060/1080/1082
	382-20005-010-0	TINNER WIRE 5.0MM D0.6
	382-20007-510-0	TINNER WIRE 7.5MM D0.6
	382-20010-010-0	TINNER WIRE 10MM D0.6
	382-20012-510-0	TINNER WIRE 12.5MM D0.6
	382-20015-010-0	TINNER WIRE 15MM D0.6

DIGITAL PART LIST

Ref.	Phonic Part No.	Specification
RP1001	017-08090-010-0	NETWORK RES. A8-332 J 9P 3.3K
IC1002	171-00000-310-0	CMOS IC HD74HC74P HITACHI
U1007	171-00002-800-0	CMOS IC PC74HC30P
U1006	171-00002-900-0	CMOS IC PC74HC374P
IC1001	171-00003-500-0	CMOS IC 74HC14 HITACHI
U1005	177-01003-510-0	IC M27C512-12 SINGAPORE WINBOND
U1001	177-02000-331-0	GAL IC 16V8D-15LP LATTICE
SW1001	210-02205-060-0	PSH/SW SPUL52A005-PJ 5K4
CN109	211-10021-161-0	2P WAFER/S TJC3-2A P=2.5MM 180DEGREE
CN104.108	211-10081-140-0	8P WAFER/S A2501WV2-8P
U1001	211-11202-002-0	IC/S 20P 9.8*25MM
U1005	211-11282-001-0	IC/S 28P 17*35MM
JP108	212-10080-530-0	8P WAFER/P 150mm UL1007#26 PITCH:2.5
X1001	300-16004-003-0	CRYSTAL 16.000MHZ 300-16004-001-0
X1001	382-00012-020-0	TINNER WIRE 12MM*D0.8
U1008	170-00007-000-0	TTL IC 74HC393 SMD
U1009	171-00000-220-0	CMOS IC HD74HC04N (SMT)
U1003	177-01004-700-0	IC BS62LV1024SC-70 SOP BSI
U1004	177-04013-000-0	CHIP ART FX DSP2 84P JAPAN 100-1365-102
U1002	177-04022-000-0	IC AK4522A-VF VSOP AKM
	290-01320-403-0	POD1060/1062 DSP PCB
R1011.1022.1031.1032.1034.1035 .1045	000-10206-400-0	CF RES. 1K J 1/8W T
R1002-1005.1008.1024.1028.1037 .1044	000-10306-400-0	CF RES. 10K J 1/8W T
R1020.1039	000-10406-400-0	CF RES. 100K J 1/8W T
R1001	000-12406-400-0	CF RES. 120K J 1/8W T
R1012.1015	000-15206-400-0	CF RES. 1K5 J 1/8W T
R1029	000-22106-400-0	CF RES. 220 J 1/8W T
R1016.1017	000-22206-400-0	CF RES. 2K2 J 1/8W T
R1018.1019	000-22306-400-0	CF RES. 22K J 1/8W T

DIGITAL PART LIST

Ref.	Phonic Part No.	Specification
R1009.1010	000-24406-400-0	CF RES 240K J 1/8W T
R1046	000-33106-400-0	CF RES. 330 J 1/8W T
R1007	000-33206-400-0	CF RES. 3K3 J 1/8W T
R1036	000-33406-400-0	CF RES 330K J 1/8W T
R1006	000-47306-400-0	CF RES. 47K J 1/8W T
R1023	000-47706-400-0	CF RES 4.7 J 1/8W T
R1038	000-51106-400-0	CF RES. 510 J 1/8W T
C1030	030-10558-0A0-0	E/C 1MF Z 50V 5*11 T
C1009.1010.1013.1014.1016.1022 .1023	030-10638-0A0-0	E/C 10MF Z 25V 5*11 T
C1017.1020.1024	030-22638-0A0-0	E/C 22MF Z 25V 5*11 T
BC1001-1016.1101.C1002.1003.1 015.1018.1019.1021	040-10428-140-0	ML/C 0.1UF Z 50V 5 T
C1004	042-10124-050-0	C/C2 100PF J 50V T
C1006.1008	042-22225-050-0	C/C2 0.0022MF K 50V 5 T
C1027.1028.1029	042-33024-050-0	C/C2 33PF J 50V 5 T
D1002	090-00000-020-0	DIODE 1N4001 SILITEK T
CR1001	090-00008-000-0	DIODE IN914
D1001	090-02000-020-0	DIODE 1N4148 SPECT26MM MINI
Q1003.1004.1005	120-00004-600-0	TRAN. 2SC1740 LN-R ROHM (2SC1313G)
L1001	382-20012-510-0	TINNER WIRE 12.5MM D0.6

AMP PART LIST

Ref.	Phonic Part No.	Specification
R44.44A.44B.51.51A.51B	000-10136-400-0	CF RES. 100 J 0.5W T
R54.54A.54B.67.67A.67B	000-15336-400-0	CF RES. 15K J 0.5W T
R75	000-24236-400-0	CF RES 2.4KJ 1/2W T
R 38.38A.38B.39.39A.39B	000-47736-400-0	CF RES.4.7 1/2WT
R62.62A.62B	003-10071-600-0	CEMENT RES. 10 J 2W AL
R9.10	003-10073-601-0	CEMENT RES. 10 J 5W U
R46.46A.46B.49.49A.49B	003-10093-600-0	CE MENT 0.1 5W J
RTP01	011-10020-000-0	THERMISTER TDC05C310L
VR1.1A.1B	020-47138-000-6	T/VR 470J T-085C-B470 0.5W
C7A	030-10646-0A0-0	E/C 10MF 35V T 5*11
C11	030-10768-0A0-0	E/C 100MF Z 63V 10*17 T
C28.28A.28B.29.29A.29B	030-47686-0A0-0	E/C 47MF M 100V 10*17 T
C31.31A.31B.36.36A.36B.42.42A. 42B.47.47A.47B	046-10414-060-0	M/C 0.1MF J 100V 5 T
C41.41A.41B	046-68314-060-0	M/C 0.068MF J 100V T
L1.1A.1B	075-10082-100-0	INDUCTANCE 1UH K M
KP01.1	076-02422-010-0	RELAY OSA-SH-224DM3M
D3.3A.5.10.10A.16.16A.16B.17.17 A.17B.25.25A.25B.26.26A.26B.28. 29.30	090-00007-020-0	DIODE IN4004 SILTEK T
D20.20A.20B.24.24A.24B	090-00017-000-0	DIODE LT6A04
D18.18A.18B.22.22A.22b	090-02005-000-0	DIODE FR107 MOTOROLA (IN4935)
D27.27A.27B	090-10000-000-0	B/DIODE PB154
Q2.5.5A.5B	120-00005-000-0	TRAN MJE340 MOTOROLA
TR11.11A.11B	120-00008-600-0	TRAN 2SC5200-O TOSHIBA
QP08.4.4A.4B	120-00008-800-0	TRAN MJE802 MOTOROLA
TR8.8A.8B	120-00009-500-0	TRAN 2SC4793-M TOSHIBA
TR12.12A.12B	121-00006-000-0	TRAN 2SA1943-O TOSHIBA
TR3.3A.3B	121-00006-100-0	TRAN MJE350 MOTOROLA
TR9.9A.9B	121-00007-200-0	TRAN 2SA1837-M TOSHIBA
Q1	122-00000-200-0	FET 2SK30A-GR TOSHIBA
TR10.10A.10B.13.13A.13B	122-00002-400-0	MOSFET RFP 50N06
IC3	160-00002-909-0	IC 7915
IC1	160-00004-114-0	IC UPC7805H NEC (KIA)
IC2	160-00005-909-0	IC 7815
IC5.5A.5B	160-00021-900-0	IC NJM5534D JRC

AMP PART LIST

Ref.	Phonic Part No.	Specification
	210-10090-001-0	TMP/SW US-602SXRFCQ
CNP2.3	211-10021-150-0	2P WAFER/S 5267 A2505 WV P=2.5MM 180DEGREE
CN2	211-10021-161-0	2P WAFER/S TJC3-2A P=2.5MM 180DEGREE
CN107.110	211-10024-110-0	P WAFER/S A3963WV2-2P
CN103	211-10051-151-0	5P WAFER/S TJC3-5A PH=2.5MM 180 DEGREE
CN111	211-10074-000-0	7P WAFER/S A3963WV-7P PH=3.96 180DEGREE
CN112	211-10084-020-0	8P WAFER/S 396108 180 P=3.96MM
CN102	211-10161-030-0	16P WAFER/S A2501WV2-16P
JP2	212-10023-250-0	2P WAFER/P 200mm UL1007#22 P=2.5MM
TRAN&HEAT SINK*20	313-00000-000-0	TRANSISTOR WASHER TO-220
BUSHES*15	314-00000-050-0	BUSHES 602S(V.0) 180DEGREE
AMP_GND_B	379-02181-101-0	M.WIRE UL1007 #24 180MM BLK
AMP_WIN_A AMP_WIN_B	379-02351-151-0	M.WIRE UL1007 #24 350MM GRN
	526-20041-012-0	HEAT SINK POD1060/1080
	590-43006-100-0	M/E PAN SCR. M3.0*6 NI
	590-43008-100-0	M/E PAN SCR. M3.0*8 NI
	590-43012-100-0	M/E PAN SCR. M3.0*12 NI
TR10.10A.10B.13.13A.13B. IC1.2.3	610-00300-501-0	PLA. WAS. D3.0*D7.0*0.5 NI
	610-60300-700-0	PAN SPR WAS. D3.0*6.0*0.7ZN
HEAT SINK*7	615-60044-630-0	BOSS L=6.0
R24.24A.24B	000-10026-400-0	CF RES. 10 J 0.25W T
R8.22.22A	000-10126-400-0	CF RES. 100 J 0.25W T
R34.34A.34B.57.57A.57B.73.73A. 73B.74.74A.74B	000-10226-400-0	CF RES. 1K J 0.25W T
R25.25A.25B.28.28A.28B.58.58A. 58B.64.64A.64B.66.66A.66B	000-10326-400-0	CF RES. 10K J 0.25W T
R29.29A.29B.30.30A.30B	000-10426-400-0	CF RES. 100K J 0.25W T

AMP PART LIST

Ref.	Phonic Part No.	Specification
RP22	000-12126-400-0	CF RES. 120 J 0.25W T
R23.23A	000-12326-400-0	CF RES. 12K J 0.25W T
R72.72A.72B	000-13426-400-0	CF RES. 130K J 0.25W T
R5	000-15226-400-0	CF RES. 1K5 J 0.25W T
R68.68A.68B	000-18326-400-0	CF RES. 18K J 0.25W T
R45.45A.45B.47.47A.47B	000-20326-400-0	CF RES. 20K J 0.25W T
R21.21A.41.41A.41B.42.42A.42B. 43.43A.43B.48.48A.48B.50.50A.50 B.52.52A.52B	000-22226-400-0	CF RES. 2K2 J 0.25W T
R17.17A.18.18A.19.19A	000-22426-400-0	CF RES. 220K J 0.25W T
R61.61A.61B	000-27426-400-0	CF RES. 270K J 0.25W T
R69.69A.69B	000-30326-400-0	F RES. 30K J 0.25W T
R40.40A.40B.53.53A.53B	000-33026-400-0	CF RES. 33 J 0.25W T
R6.65.65A.65B	000-33126-400-0	CF RES. 330 J 0.25W T
R63.63A.63B	000-33326-400-0	CF RES. 33K J 0.25W T
R4.4A.11.11A.12.12A.14.15.26.26 A.26B.27. 27A.27B	000-39226-400-0	CF RES. 3K9 J 0.25W T
R7	000-39726-400-0	CF RES 3.9J 1/4W T
R55.55A.55B.56.56A.56B.60.60A. 60B	000-51026-400-0	CF RES. 51 J 0.25W T
R31.31A.31B.33.33A.33B.37.37A. 37B	000-68026-400-0	CF RES. 68 J 0.25W T
R13.13A.16	000-68226-400-0	CF RES. 6K8 J 0.25W T
R20.20A	000-68326-400-0	CF RES. 68K J 0.25W T
R32.32A.32B.35.35A.35B36.36A.3 6B	000-82126-400-0	CF RES. 820 J 0.25W T
R71.71A.71B	006-53012-440-0	MF RES. 5.3K F 0.25W T
C30.30A.30B	030-10638-0A0-0	E/C 10MF Z 25V 5*11 T
C8.9.10	030-10656-0A0-0	E/C 10MF M 50V 5*11 T
C12.12A.13.15.15A.24.24A.24B.3 9.39A.39B. 43.43A.43B	030-10728-0A0-0	E/C 100MF Z 16V 6*11 T
C21.21A.21B.22.22A.22B	030-10736-0A0-0	E/C 100MF M 25V 8*11 T
CP18	030-47628-0A0-0	E/C 47MF Z 16V 5*11 T
CP19	030-47658-0A0-0	E/C 47MF Z 50V 8*11 T
C19.19A.19B	032-10636-0A0-0	NP E/C 10MF M 25V 6.3*11 T
C46.46A.46B	042-03020-000-0	C/C2 3PF C 50V 5
C44.44A.44B.45.45A.45B	042-10124-050-0	C/C2 100PF J 50V T

AMP PART LIST

Ref.	Phonic Part No.	Specification
C25.25A.25B.27.27A.27B	042-101A6-050-0	C/C2 100PF M 250V 5 T
C7	042-10325-050-0	C/C2 0.01MF K 50V T
C20.20A.20B	042-18044-050-0	C/C2 18PF J 100V 5 T
C37.37A.37B	042-20124-050-0	C/C2 200PF J 50V 5 T
C23.23A.23B	042-22124-050-0	C/C2 220PF J 50V 5 T
C38.38A.38B	042-391A4-050-0	C/C2 390PF J 250V 5 T
C14.14A	042-47124-050-0	C/C2 470PF J 50V 5 T
C32.32A.32B.35.35A.35B.	042-471A5-050-0	C/C2 470P K 250V 5T
C26.26A.26B.48.48A.48B	046-10204-060-0	M/C 0.001MF J 50V 5 T
C33.33A.33B.34.34A.34B	046-10304-060-0	M/C 0.01MF J 50V 5 T
ZD10.10A.10B	090-01123-000-0	ZEN/DIODE 12V J 0.5W UNIZON
ZD2	090-01223-000-0	Z/DIODE 22V 0.5W IN5251B
ZD3.5	090-01273-010-0	ZEN/DIODE 27V K 0.5W
ZD1	090-01513-110-0	Z/D10DE 51V 1W MOTOROLA
ZD4.4A.7.7A.7B.8.8A.8B	090-01682-000-0	ZEN/DIODE 6.8V J0.5W UNIZO
ZD9.9A.9B	090-01822-000-0	ZEN DIODE 8.2V J 0.5W
D6.6A.7.8.8A.9.12.12A.B.13.13A.B .14.14A. B.15.15A.B.19.19A.B.21.21A.B.23. 23A.B	090-02000-020-0	DIODE 1N4148 SPEC T26MM MINI
Q3.4.4A.5.5A.10.10A.11.11A	120-00000-800-0	TRAN. 2SC1815 GR TOSHIBA
TR1.1A.1B	120-00001-400-0	TRAN. 2N5551 MOTOROLA
TR6.6A.6B	120-00009-700-0	TRAN. BC546B PHILIPS(代 BC550)
Q6.6A.7.7A.7B.8.8A.8B.9.9A.9B	121-00000-200-0	TRAN. 2SA1015 GR TOSHIBA
TR2.2A.2B	121-00000-300-0	TRAN. 2N5401 MOTOROLA
TR7.7A.7B	121-00007-500-0	TRAN. BC556B PHILIPS (BC560)
	290-01320-500-0	PCB POWERPOD1060-E AMP
	382-20005-010-0	TINNER WIRE 5.0MM D0.6
	382-20007-510-0	TINNER WIRE 7.5MM D0.6
	382-20010-010-0	TINNER WIRE 10MM D0.6
	382-20012-510-0	TINNER WIRE 12.5MM D0.6
	382-20015-010-0	TINNER WIRE 15MM D0.6

POWER PART LIST

Ref.	Phonic Part No.	Specification
R1.2	000-18336-400-0	CF RES. 18K J 1/2W
R3	000-39336-400-0	CF RES 39K J 0.5W T
C5.6	030-10846-000-0	E/C 1000MF M 35V 10*21 T
C3.4	030-33866-030-0	E/C 3300UF M 63V 25*30 P
C1.2	030-47878-000-0	E/C 4700MF Z 80V 31*35 P
C1A	058-68325-100-0	MEX-683K 0.068MF/250V 18*13.5 P=15
D4	090-10000-000-0	B/DIODE PB154
D1	090-10008-100-0	B/DIODE KBPC 3506W
D2.2A	090-10009-000-0	B/DIODE PBU805
SW1	210-02101-030-0	PSH/SW PA-03S-A1
JK1-7	211-01601-300-0	6D3/J M203A-2
CN113	211-10024-110-0	2P WAFER/S A3963WV2-2P
CN1	211-10084-020-0	8P WAFER/S 396108 180 P=3.96MM
JP113	212-10023-290-0	2P WAFER/P 350mm UL1015#18 PITCH:3.96
JP110.107	212-10023-310-0	2P WAFER/P 350mm UL1015#18 PITCH:3.96
JP111	212-10070-600-0	7P WAFER/P 350mm UL1015#18 PITCH;3.96
JP112	212-10080-520-0	8P WAFER/P 350mm UL1015#18 PITCH:3.96
F1*2.F2*2.F3*2	281-00000-020-0	FUSE CLIP FH-1206
PWR_GND_A PWR_G_R	379-10101-101-0	M.WIRE UL1015 #18 100MM BLK
	290-01320-300-0	PCB POWERPOD1060-C+F+H
	382-20010-010-0	TINNER WIRE 10MM D0.6
	382-20015-010-0	TINNER WIRE 15MM D0.6

MISCELLANEOUS ITEMS

Ref.	Phonic Part No.	Specification
LUG*1	315-00000-000-0	LUG D4 FOR GROUND
CABEL TIE	321-00000-020-0	CABEL TIE 140MM
CABEL TIE *15	321-00000-070-0	CABLE TIE HW-100MM
	347-00000-240-0	FAN SP601012M
	510-20770-300-0	PANEL POD1060 429C +432C
	511-20550-400-0	BACK PANEL POD1060 432C +429C
	528-20012-100-0	FAN NET 6G-60 POWERPOD1060
LEVEL*8	540-60148-420-0	R/KNOB 12 WHT BODY+430C(GREY) CAP
FOR MON/EFX*8 EFFECT RTN*2	540-60148-520-0	R/KNOB 12.0 430C(GREY)BODY+WHT CAP
AUX IN*1 TAPE IN*1		
FOR MASTER*2 PHONES*1	540-60148-620-0	R/KNOB 12 430C(GEY)BODY+491C(RED)CA P
EFFECT OUT*1		
FOR HIGH/LOW/MID*8	540-60148-720-0	R/KNOB 12 430C(GEY)BODY+647C(BLUE)C AP
FOR PAN*8	540-60148-920-0	R/KNOB 12 430C(GEY)BODY+432C(DEEP GEY)CAP
POWER/SW*1	542-20150-120-0	P/KNOB 13.5*10.5*10.5H BLK INNER DIMENSION3*3
ALL PUSH SW*11	542-20300-121-0	P/KNOB 5.8*5.8*8 431C+WHT
	551-20043-400-0	RT BRKT POWERPOD7/615/1060/740/PX7 00DLX
	551-20045-400-0	L BRKT POWERPOD7
	551-20056-400-0	FAN BRKT. POWERPOD1060
	551-60056-000-0	FRONT LF BRKT
	551-60057-000-0	BACK LF BRKT
	552-10166-000-0	PCB FIXED-RT ZNW
	552-10167-000-0	PCB FIXED-LF ZNW
FIXED *4	552-20048-420-0	ADHESIVE FIXED FW-5D-3M
	552-20049-400-0	X'MER FIXED POWERPOD1060
	553-20009-480-0	PCB SHIELD PLATE

MISCELLANEOUS ITEMS

Ref.	Phonic Part No.	Specification
	553-20010-490-0	PCB SHIELD PLATE SIZE:408*109.5*0.5
	560-20870-100-0	CARTON SIZE:560*390*410 A=B POD1060X
	561-21100-400-0	POD1060 GIFT BOX SIZE:545*370*390MM
UP RIGHT*1.DOWEN RIGHT*1.DOWEN LEFT*1.UP LEFT*1	562-24190-000-0	PULP PANEL 1032*581MM 5 PULP PANEL
	566-10015-010-0	SPONGE 40*10*5
	568-00003-000-0	PE BAG #10 240*340*0.05
	568-20059-000-0	PE BAG POWERPOD1060 SIZE:
	572-00000-050-0	DRYER 5g
	573-10124-010-0	GND LABEL MAR2
	573-60162-000-0	FAN BLACK LABEL D=22MM
	573-60343-000-0	LABEL LEVEL METER LABEL BLUE D=8mm
	574-6A069-011-0	OWN.MANU.POD1060/1062/615/ 740CHANG AFTER
	579-00000-068-0	MINI CATALOG PHONIC SERIES
PANEL & 5SW	590-03006-100-0	M/E FLT SCR. M3.0*6 NI
	590-03008-100-0	M/E FLT SCR. M3.0*8 NI
	590-03008-200-0	M/E FLT SCR. M3.0*8 BLK D=6
FOR FAN TO FAN BRACKET*8	590-03020-200-0	M/E FLT SCR M3*20 BLACK
POWER SW	590-43006-200-0	M/E PAN SCR. M3.0*6 BLK
PCB*22	590-53008-100-0	M/E SET SCR. M3.0*8 NI
PCB FIXED*6	590-53008-200-0	M/E SET SCR. M3.0*8 D=6 BLK
HEAT SINK*1	590-53010-200-0	M/E SET SCR. M3.0*10 BLK
PANEL&LR BRKT*6	590-54010-100-0	M/E SET SCR. M4*10 NI
	590-54010-200-0	M/E SET SCR. M4.0*10 BLK
	590-54018-200-0	M/E SET SCR. M4.0*18 BLK
	590-54030-200-0	M/E SET SCR. M4.0*30 BLK
PANEL & XLR/J*16	591-03008-200-0	T/P FLT SCR. D3.0*8 BLK
FOR RCA JACK	591-53008-100-0	T/P SET SCR. D3.0*8 NI
	600-00302-010-0	HEX. NUT M3.0*2.0 NI
	600-00403-510-0	HEX. NUT M4.0*3.5 NI

MISCELLANEOUS ITEMS

Ref.	Phonic Part No.	Specification
	600-20302-500-0	NUT M3.0*2.5ZW L20*W10
	600-20402-000-0	NUT M4.0*2.0 ZN L14*W10
PCB*22	610-00300-501-0	PLA. WAS. D3.0*D7.0*0.5 NI
	610-00300-518-0	FIBER WAS. D3*D7*0.5 RED
	610-00301-018-0	FIBER WAS. D3.0*8*1
ALL 6D3/J*18	610-00401-202-0	PLA. WAS. D4.0*D12.0*1.0 BLK
	610-20901-001-0	TOOTH WAS D9*12*1 NI
	610-30400-500-0	TOOTH WAS. D4.0*D8.5*0.5 ZN
GND	610-60401-001-0	PAN SPR. WAS. D4*7.6*1.0 NI
POWER SW*2	615-20023-630-0	BOSS 15+5
FIX MAST/DIGITAL PCB*3	615-20075-620-0	SPACE SUPPORT H-28
PCB&PANEL*16	615-20088-620-0	SPACER SUPPORT H-16
	615-20093-620-0	PCB LCC-30A
	615-20094-620-0	PCB BOSS LCB-5
PANEL&5 SW*2	615-20117-630-0	BOSS 17+5(M3)
	618-14180-662-0	SPEC FIXED PIN SR-2 WHT
FOR LED*11	631-20029-000-0	HEMELON 10*10
ALL EQ VR*14 FOR LIMITE	631-20032-000-0	HEMELON 36*10MM
LED*3		
	510-20770-300-F	PANEL POD1060
	511-20550-400-F	BACK PANEL POD1060 SECC1.0

MISCELLANEOUS ITEMS

Ref.	Phonic Part No.	Specification
	524-70001-020-7	HANDEL 210mm
	525-70000-010-7	FEET D25*D20*16T BLK POD408
	552-70000-200-7	HANDEL
HANDLE*2	590-25024-200-7	M/E BID SCR. M5*24 BLK
CONTER*16	592-23012-200-0	W/O BID SCR. M3.0*12 BLK
FEET*4	593-44020-200-7	W/O PAN SCR. D4.0*20 BLK
	600-70000-040-7	NUT M4
	600-70001-000-7	NUT M5 WHT
	636-70007-101-7	VINYL 2*50m BLK
	637-70000-000-7	BOX CONTER
	700-01800-000-7	PLANKING 4"*8"*18MM
	710-70000-000-7	GLUE PT-3670
	710-70001-010-7	GLUE
	711-73000-000-7	NAIL F30
	712-70000-530-7	PAINT
	714-70000-000-7	THINNER

POWER REQUIREMENT CLASSIFICATION

Ref.	Phonic Part No	Specification
<u>BS</u>		
	070-20368-800-0	X'MER 115/230V (POWERPOD1060)
F2.3	280-20263-000-0	FUSE T2A 250V VDE S
	280-63263-000-0	FUSE 6.3A 250V VDE/CE S
	307-00000-000-0	CORD CONNECTOR HW-C4
	370-26B40-439-1	P/CORD 230V 13A 2m5 BS 3P
	527-11000-000-0	STR.REL BUSHING 6W3-4 R (6N3-4)
	573-10032-010-0	POWER LABEL (ONLY USED IN BS)
	573-60240-000-0	BAR CODE LABEL PHONIC SERIES LABEL
<u>JIS</u>		
	070-20368-800-0	X'MER 115/230V (POWERPOD1060)
F1	280-10366-000-0	FUSE T10A UL/CSA S 5*20
F2.3	280-2026B-001-0	FUSE 2A 250V UL/CSA/JIS S
	307-00000-000-0	CORD CONNECTOR HW-C4
	370-24610-602-0	P/CORD 100V 12A 2.5M 1MM/2P JIS
	527-11000-000-0	STR.REL BUSHING 6W3-4 R (6N3-4)
	573-60240-000-0	BAR CODE LABEL PHONIC SERIES LABEL
<u>SAA</u>		
	070-20368-800-0	X'MER 115/230V (POWERPOD1060)
F2.3	280-20263-000-0	FUSE T2A 250V VDE S
F1	280-63263-000-0	FUSE 6.3A 250V VDE/CE S
	307-00000-000-0	CORD CONNECTOR HW-C4
	370-11310-809-0	P/CORD 240V 7.5A 6F 3P SAA
	527-11000-000-0	STR.REL BUSHING 6W3-4 R (6N3-4)
	573-60240-000-0	BAR CODE LABEL PHONIC SERIES LABEL

POWER REQUIREMENT CLASSIFICATION

Ref.	Phonic Part No	Specification
<u>IEC</u>		
	070-20368-800-0	X'MER 115/230V (POWERPOD1060)
F2.3	280-20263-000-0	FUSE T2A 250V VDE S
F1	280-63263-000-0	FUSE 6.3A 250V VDE/CE S
X'MER WIRE*2	307-00000-000-0	CORD CONNECTOR HW-C4
	370-23060-939-0	P/CORD 10/16A250V 2.5M2P CE
	527-11000-000-0	STR.REL BUSHING 6W3-4 R (6N3-4)
	573-60240-000-0	BAR CODE LABEL PHONIC SERIES LABEL
<u>SA</u>		
	070-20368-800-0	X'MER 115/230V (POWERPOD1060)
F2.3	280-20263-000-0	FUSE T2A 250V VDE S
F1	280-63263-000-0	FUSE 6.3A 250V VDE/CE S
	307-00000-000-0	CORD CONNECTOR HW-C4
	370-15020-829-0	P/CORD 15A/250V 1.0MM*3 6F 3P
	527-11000-000-0	STR.REL BUSHING 6W3-4 R (6N3-4)
	573-60240-000-0	BAR CODE LABEL PHONIC SERIES LABEL
<u>UL</u>		
	070-20368-800-0	X'MER 115/230V (POWERPOD1060)
F1	280-10366-000-0	FUSE T10A UL/CSA S 5*20
F2.3	280-2026B-001-0	FUSE 2A 250V UL/CSA/JIS S
	307-00000-000-0	CORD CONNECTOR HW-C4
	370-08010-733-0	P/CORD 125V10A 2.5M 1MM/3P UL/CSA
	527-11000-000-0	STR.REL BUSHING 6W3-4 R (6N3-4)
	573-60240-000-0	BAR CODE LABEL PHONIC SERIES LABEL

IC LIST

Ref.	Phonic	Specifications	Supplier
IC101-106.	160-00007-510-0	IC NJM2068L JRC	http://www.njr.com
IC904.905.908	160-00002-300-0	IC M5229P MITSUBISHI	http://www.mitsubishichips.com/common/cfm/eContentDriver.cfm
IC107-111.901.902.903.906.907.909-912.914.918	160-00007-510-0	IC NJM2068L JRC	http://www.njr.com
IC913	160-00018-000-0	IC NJM4556AL JRC	http://www.njr.com
IC915.916.917	160-00019-100-0	IC BA6137	http://www.elektro-obecnice.cz/data/katalogove_listy/elektroBA.html
IC1002	171-00000-310-0	CMOS IC HD74HC74P HITACHI	http://www.semiconductors.philips.com/
U1007	171-00002-800-0	CMOS IC PC74HC30P	http://www.semiconductors.philips.com/
U1006	171-00002-900-0	CMOS IC PC74HC374P	http://www.semiconductors.philips.com/
IC1001	171-00003-500-0	CMOS IC 74HC14 HITACHI	http://www.semiconductors.philips.com/
U1005	177-01003-510-0	IC M27C512-12 SINGAPORE WINBOND	http://us.st.com/stonline/index.shtml
U1001	177-02000-331-0	GAL IC 16V8D-15LP LATTICE	http://www.latticesemi.com/
U1008	170-00007-000-0	TTL IC 74HC393 SMD	http://www.semiconductors.philips.com/
U1009	171-00000-220-0	CMOS IC HD74HC04N (SMT)	http://www.semiconductors.philips.com/
U1003	177-01004-700-0	IC BS62LV1024SC-70 SOP BSI	http://www.bsi.com.tw/e_index.htm
U1004	177-04013-000-0	CHIP ART FX DSP2 84P JAPAN 100-1365-102	http://www.artproaudio.com/main.html
U1002	177-04022-000-0	IC AK4522A-VF VSOP AKM	http://www.akm.com/

DIMENSIONS

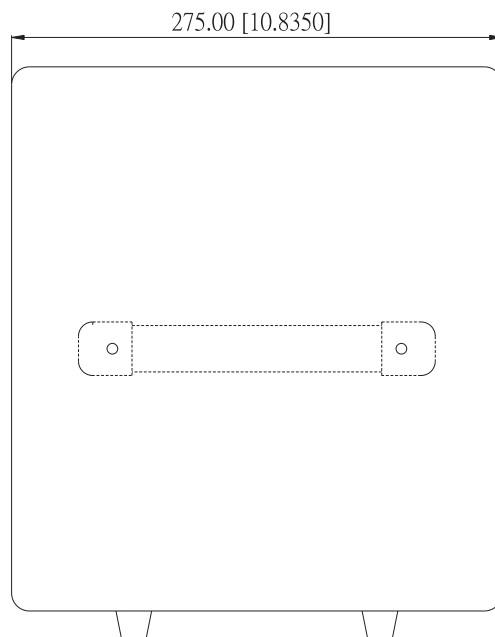
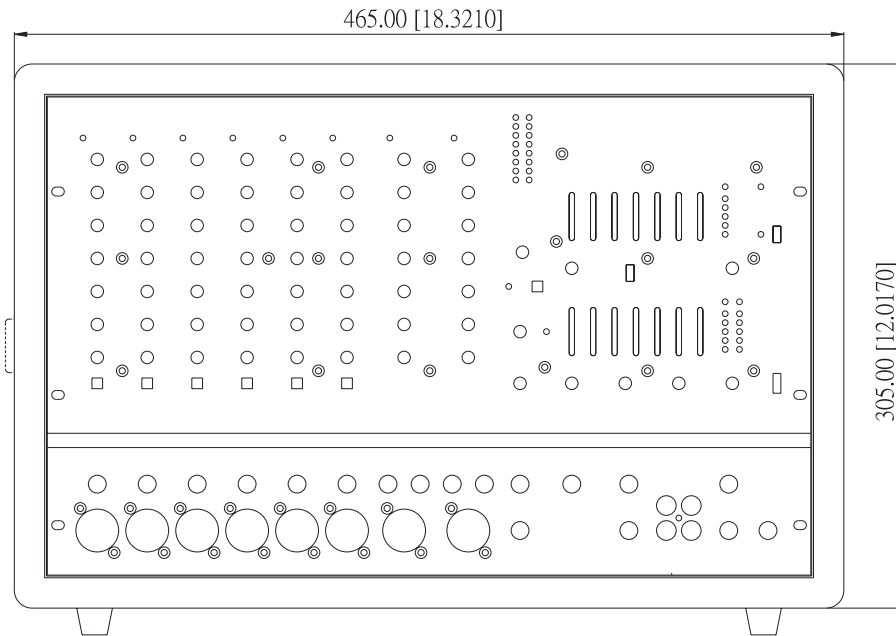

DIMENSIONS ARE SHOWN IN MM/INCH.

EXPLODED VIEW

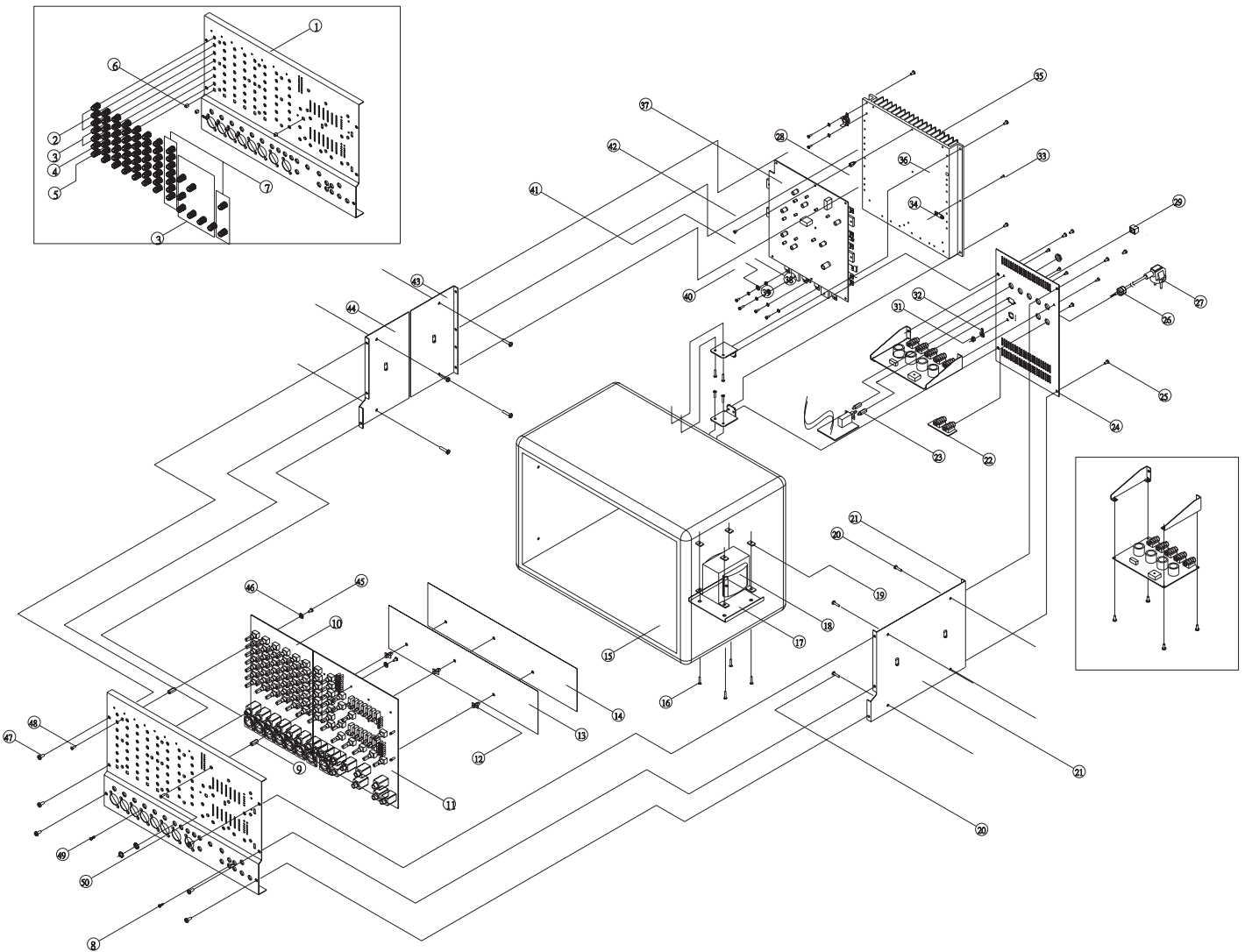

No	PART NO	Title	QTY	No	PART NO	Title	QTY	No	PART NO	Title	QTY	No	PART NO	Title	QTY
14	553-2009-480-0	PCB SHIELD PLATE	1	28	615-60044-630-0	BOSS H6.0	8	42	590-53012-100-0	M3.0*12 NI	8	50	591-53008-100-0	D3.0*8 BLK	1
13	553-20010-490-0	PCB SHIELD PLATE	1	27	370-23060-939-0	PCCORD	1	41	590-43006-100-0	M3.0*6 NI	8	49	591-03008-200-0	D3.0*8 BLK	16
12	615-20094-620-0	PCB BOSS	3	26	527-11000-000-0	SCR.REL.BUSHING	1	40	590-43008-100-0	M3.0*8 NI	13	48	590-03008-200-0	M3.0*8 BLK	10
11	F01-57000-002-0	PCB	1	25	590-54010-200-0	M4.0*10 BLK	10	39	610-60300-700-0	PAN SPR.WAS	26	47	590-54010-100-0	M4.0*10 NI	6
10	F01-32000-100-0	PCB	1	24	511-20550-800-0	BACK PANEL	1	38	314-00000-050-0	BUSHING	4	46	610-00301-018-0	FIBER WAS	19
9	615-20088-620-0	SPACER SUPPORT H16	19	23	615-20023-630-0	BOSS 15*5	2	37	F01-57000-005-0	PCB	1	45	590-53008-100-0	M3.0*8 NI	33
8	591-53008-100-0	D3.0*8	1	22	F01-57000-003-0	PCB	1	36	210-10090-001-0	TMP/SPW	1	44	551-60056-000-0	BRKT	1
7	540-60148-620-0	R/KNOB	6	21	551-20043-400-0	RT BRKT	1	35	526-60053-012-0	HEAT SINK	1	43	551-60057-000-0	BRKT	1
6	542-20300-121-0	R/KNOB	7	20	590-54018-200-0	M4.0*18 BLK	14	34	600-00301-102-0	WAS	1				
5	540-60148-420-0	R/KNOB	8	19	610-00401-200-0	PLA WAS	4	33	590-53010-200-0	M3.0*10 BLK	1				
4	540-60148-920-0	R/KNOB	8	18	070-60008-810-0	XMER	1	32	610-30400-500-0	TOOTH WAS	1				
3	540-60148-520-0	R/KNOB	19	17	551-60055-000-0	FAN BRKT	1	31	600-00403-510-0	NUT M3.0	1				
2	540-60148-720-0	R/KNOB	24	16	590-54030-200-0	M4.0*30 BLK	4	30	590-43006-200-0	M3.0*6 BLK	2				
1	510-60330-100-0	PANEL 1060X	1	15	W01-00008-000-0	WOOD BOX	1	29	542-20150-120-0	R/KNOB	1				

PHONIC
WWW.PHONIC.COM