

# Technical Service Manual

## USA Series

- ▲ USA 370
- ▲ USA 850
- ▲ USA 1300



Rev. A

---

▲ **USA 370**

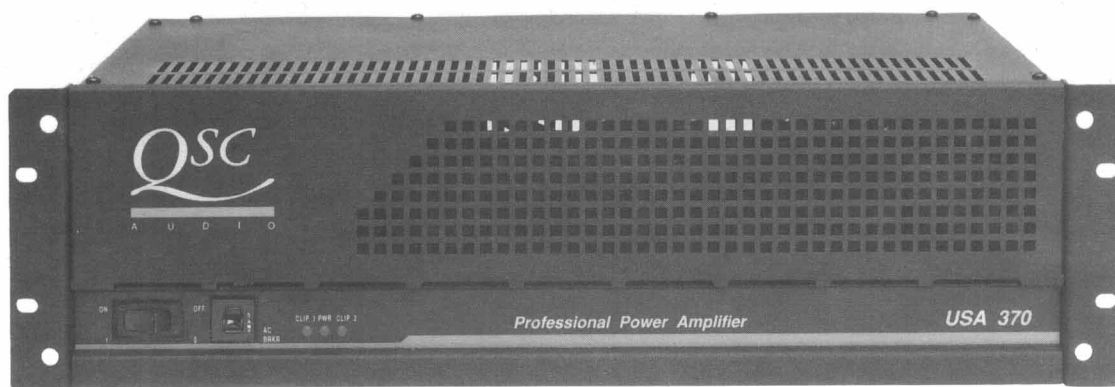

---

▲ **USA 850**



---

▲ **USA 1300**

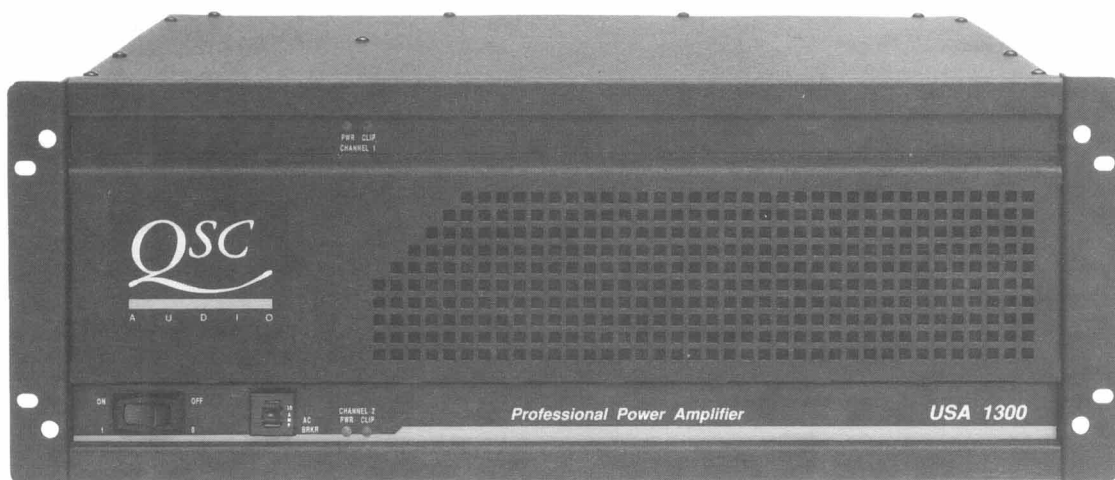



USA Amplifier Series

# **USA SERIES AMPLIFIER SERVICE MANUAL**

**USA 370**

**USA 850**

**USA 1300**

**QSC CUSTOMER SERVICE  
1-800-QSC AUDIO  
(800-772-2834)**



## Table of Contents

|   |       |
|---|-------|
| Product Specifications .....                  | 1     |
| Introduction & General Information .....      | 2     |
| USA Series Test and Calibration .....         | 3     |
| USA Series Troubleshooting .....              | 8     |
| USA Series Circuit Description .....          | 14    |
| USA Series Parts List                         |       |
| <i>USA1300 Ch.1 Main Board Assembly</i> ..... | 17    |
| <i>USA1300 Ch.2 Main Board Assembly</i> ..... | 17    |
| <i>USA1300 Chassis Assembly</i> .....         | 18    |
| <i>USA850 Main Board Assembly</i> .....       | 19    |
| <i>USA850 Chassis Assembly</i> .....          | 20    |
| <i>USA370 Main Board Assembly</i> .....       | 20    |
| <i>USA370 Chassis Assembly</i> .....          | 21    |
| <i>USA Input Jack Panel</i> .....             | 21    |
| Semiconductors .....                          | 22    |
| Chassis Drawings                              |       |
| <i>USA370/USA850 Chassis Assembly</i> .....   | 23-24 |
| <i>USA1300 Chassis Assembly</i> .....         | 25-26 |
| Wiring Diagrams                               |       |
| <i>USA370 Wiring Diagram</i> .....            | 27    |
| <i>USA850 Wiring Diagram</i> .....            | 28    |
| <i>USA1300 Wiring Diagram</i> .....           | 29    |
| Schematics                                    |       |
| <i>USA370 Schematic</i> .....                 | 30    |
| <i>USA850 Schematic</i> .....                 | 31    |
| <i>USA1300 Schematic</i> .....                | 32    |
| Printed Circuit Board Layout Traces           |       |
| <i>USA370 / USA850 Main PCB</i> .....         | 33    |
| <i>USA1300 Ch.1 Main PCB</i> .....            | 34    |
| <i>USA1300 Ch.2 Main PCB</i> .....            | 35    |
| <i>USA Series Jack Panel</i> .....            | 36    |

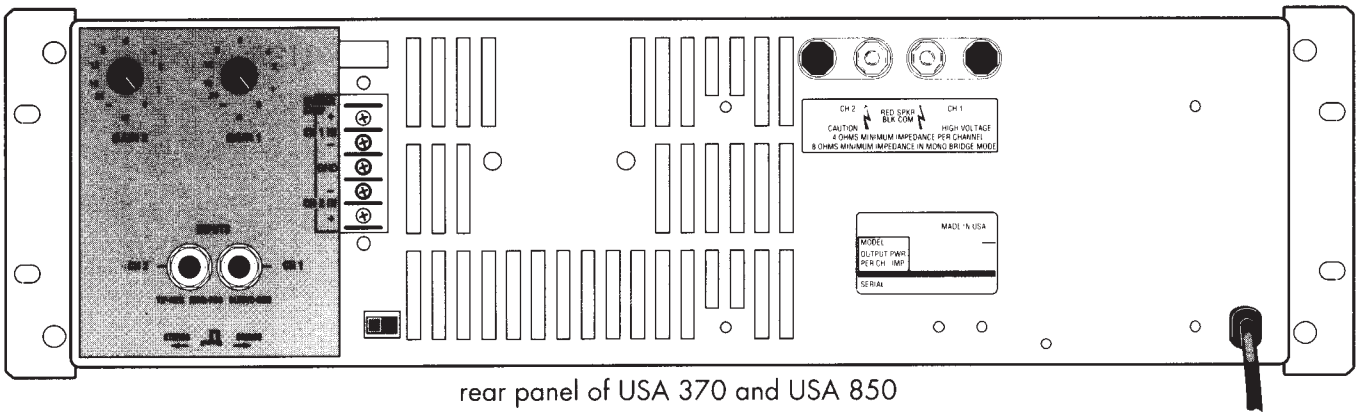

rear panel of USA 370 and USA 850

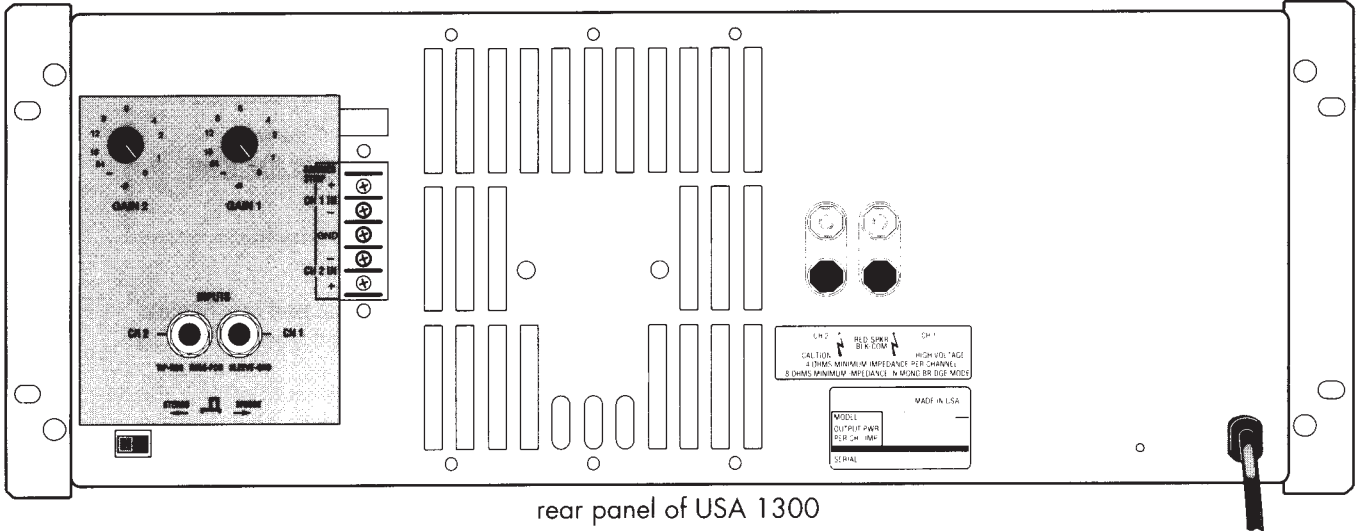

rear panel of USA 1300

|   | <b>USA 370</b>  | <b>USA 850</b>  | <b>USA 1300</b>   |
|---|---|---|---|
| <b>OUTPUT POWER</b> (typical, both channels driven):<br>4 ohms, 1 kHz, 1% THD<br>8 ohms, 1 kHz, 1% THD<br>8 ohms, 20 Hz to 20 kHz, 0.1% THD<br><br>2 ohms, 1 kHz, 1% THD:<br>(typical, single channel driven) | 185<br>125<br>110<br><br>250  | 425<br>270<br>240<br><br>550  | 650<br>400<br>365<br><br>1000   |
| <b>POWER BANDWIDTH:</b>   | 5 Hz to 60 kHz  | 5 Hz to 60 kHz  | 5 Hz to 70 kHz  |
| <b>DISTORTION</b> (8 ohms):   | THD, 20 Hz–20 kHz at rated power < 0.1%<br>SMPTE-IMD < 0.025%                           | THD, 20 Hz–20 kHz at rated power < 0.1%<br>SMPTE-IMD < 0.025%                           | THD, 20 Hz–20 kHz at rated power < 0.1%<br>SMPTE-IMD < 0.01%                            |
| <b>DYNAMIC HEADROOM:</b>  | 2 dB at 8 ohms  | 2 dB at 8 ohms  | 1.9 dB at 8 ohms  |
| <b>SENSITIVITY</b> (with gain control at maximum):  | 29 dB voltage gain, 1.12 Vrms for rated power at 8 ohms                                 | 32 dB voltage gain, 1.16 Vrms for rated power at 8 ohms                                 | 34 dB voltage gain, 1.13 Vrms for rated power at 8 ohms                                 |
| <b>POWER CONSUMPTION:</b>   | 4.4 Aac at 120 V.   | 8.6 Aac at 120 V.   | 12.7 Aac at 120 V.  |
| <b>FREQUENCY RESPONSE:</b>  | 20 Hz–20 kHz<br>+0,–1 dB at 1 watt.   | 20 Hz–20 kHz<br>+0,–1 dB at 1 watt.   | 20 Hz–20 kHz<br>+0,–1 dB at 1 watt.   |
| <b>DAMPING FACTOR:</b>  | Greater than 200 at 8 ohms  | Greater than 200 at 8 ohms  | Greater than 200 at 8 ohms  |
| <b>NOISE:</b>   | –100 dB below full output, A weighted   | –100 dB below full output, A weighted   | –100 dB below full output, A weighted   |
| <b>INPUT IMPEDANCE:</b>   | 20k $\Omega$ balanced and unbalanced noninverting or 10k $\Omega$ unbalanced inverting. | 20k $\Omega$ balanced and unbalanced noninverting or 10k $\Omega$ unbalanced inverting. | 20k $\Omega$ balanced and unbalanced noninverting or 10k $\Omega$ unbalanced inverting. |
| <b>POWER REQUIREMENTS:</b>  | 120, 220–240 Vac, 50/60 Hz  | 120, 220–240 Vac, 50/60 Hz  | 120, 220–240 Vac, 50/60 Hz  |
| <b>DIMENSIONS:</b>  | 5.25" (13.3 cm) tall (3 RU),<br>19" (48.3 cm) wide,<br>9.5" (24.1 cm) deep              | 5.25" (13.3 cm) tall (3 RU),<br>19" (48.3 cm) wide,<br>9.5" (24.1 cm) deep              | 7" (17.8 cm) tall (4 RU),<br>19" (48.3 cm) wide,<br>10.8" (27.4 cm) deep                |
| <b>WEIGHT:</b>  | 24 lb (10.9 kg) net, 28 lb (12.7 kg) shipping   | 34 lb (15.4 kg) net, 37 lb (16.8 kg) shipping   | 54 lb (24.5 kg) net, 57 lb (25.9 kg) shipping   |

Specifications subject to change without notice



## Introduction & General Information

This manual is prepared to assist technicians with the repair and calibration of the USA Series audio power amplifiers. The procedures described in this manual require advanced technical experience and sophisticated audio test equipment.

**WARNING:** *There are **NO** user serviceable components inside these products. Opening these products or attempting the adjustments described in this manual may expose the user to electrical shock. Refer servicing to qualified service personnel.*

This manual contains schematics, printed circuit board (PCB) drawings, parts lists, and mechanical assembly drawings. This information should be used in conjunction with the test and troubleshooting guide.

The electrical and electronic components are identified by circuit identification numbers on the schematics and the parts list. The test & troubleshooting sections refer to designations shown in the schematics.

Although many of the electronic components used in this product may be available from electronic suppliers, some components are specially tested and approved by QSC. A product repaired with non-QSC supplied components may not meet factory specifications. Repairs performed using non-QSC parts may void the product warranty. When in doubt, you may contact QSC Customer Service for assistance.

Parts orders to QSC should include the product model number, the part description, and the QSC part number (from the parts list in this manual). Parts will be shipped via UPS, F.O.B. Costa Mesa, California. Shipping, handling and COD charges may be added to the cost of the parts.

### Required Test Equipment:

1. Distortion Analyzer capable of 0.05% THD+N analysis
2. Function Generator
3. 20MHz Oscilloscope
4. Digital Multimeter
5. Variac (0-140 VAC, 10-20A, with AC Current Measuring)
6. High Power Load Bank (8, 4, & 2 ohm)

### Suggested Test Equipment:

1. Audio Precision - System One
2. Thermocouple probe



## USA Series Test & Calibration

NOTE: This test procedure will refer to the amplifier's channels as *CH1* (Channel 1) & *CH2* (Channel 2). Component designation will have the suffix "a" for CH1 and "b" for CH2.

### USA370 & USA850 Test Procedure

- ◆ SET-UP
  1. Connect a test load to the output terminals of the amplifier.
  2. Set the Stereo / Bridge switch to Stereo.
  3. Connect a distortion analyzer with a resolution of 0.05%, 20-20kHz (or better) to the output terminals of the amplifier.
  4. Connect a dual-channel oscilloscope to the following test points:
    - Ch1 - a 10X (vertical sensitivity - 2V/cm) scope probe to the channel speaker output.
    - Ch2 - a 1X scope probe (vertical sensitivity - 0.1V/cm) to the distortion analyzer output.
  5. Connect scope Ch. 2 (0.1V/cm) to distortion output.
  6. Set amp gain pots fully clockwise.
  7. Connect the output of the signal generator to the input terminals of the amplifier and select an output of 1.00 VRMS, 1KHz sine wave.
  8. Lift the ground on the scope and the distortion analyzer.
- ◆ POWER UP & MUTE DELAY TEST
  1. Slowly raise the variac voltage and watch for excessive current draw (Line current greater than 1A a.c. at 120 Volts.) *This is slightly less for 240V.* Pause at 95VAC (200VAC European) for three seconds until the mute / protect circuit disengages. Raise to 120VAC (240V European).
  2. Turn the power switch off and on a few times to verify the 2 - 3 second power-up muting delay.
- ◆ CHANNEL OUTPUT
  1. Look for normal signal on the scope of channel 1. Switch the input signal and scope to channel 2 and repeat output test. Check for noisy / contaminated gain pots by observing general instability on your distortion waveform while adjusting the gain control levels.
  2. Select an 8 ohm load and confirm that this product is passing 125 watts for USA370 and 270 watts for USA850 at 1KHz 1% distortion.
- ◆ BRIDGE MODE (1Vrms, sinewave, 1kHz)

Move the Bridge switch on the amp from the Stereo to Bridge position. Turn gain on CH2 fully counter clockwise (off). Remove the input plug from CH2. Check CH2 for full output with input applied to CH1. The output signal on CH2 should be 180 degrees out of phase with CH1 output signal. Turn power off and place the amplifier under test back into the Stereo mode.
- ◆ BIAS & RIPPLE (HUM) NULL ADJUSTMENT

HUM NULL:

  1. Use 0.1% scale on distortion analyzer. Adjust TR2 hum-null trimpot for minimum signal distortion. Make this adjustment with your input signal at 20kHz below full output. Let the amplifier cool down. See waveforms on next page for the correct adjustment.



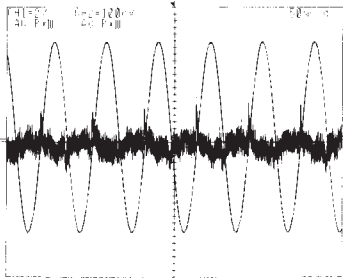

Correct Hum-null

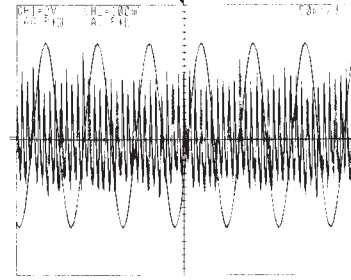

Incorrect Hum-null

**CROSSOVER AND BIAS SETTING:**

2. While still at 20kHz, reduce input signal 20dB (80%) from full output and adjust cross-over trimpot (TR3a & b) for a less than 400mVpk-pk cross-over spike protruding from the noise trace on the scope.

If a distortion analyzer is not available, a less accurate crossover distortion and bias adjustment can be made by monitoring the driver transistor (Q1 & Q2) bias current. With the amp at room temperature, and no input signal plugged into the amplifier, measure the DC voltage across the emitter resistors of Q1 and Q2. Adjust TR3a,b to obtain about 100mV d.c.

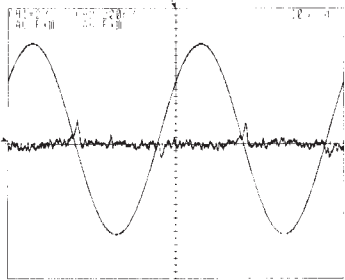

Correct Crossover

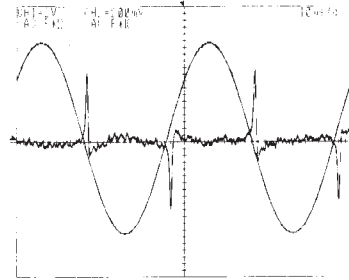

Incorrect Crossover

**♦ SHORT CIRCUIT CURRENT (1Vrms, sinewave, 1kHz)**

1. Select a 2-ohm load and verify even clipping on both channels by adjusting a 1kHz input signal to just beyond 1VRMS (sine wave). Apply a short to the output binding posts of each channel one channel at a time and adjust the short circuit current limits. TR4a & b is for positive clip adjust and current limiting while TR5a&b is for negative clip adjust and current limiting. AC current draw from the wall of 2.0A on the USA370 and 4.5A on the USA850 (1A, 240V and 2.25A, 240V respectively) should be evident. If adjustment is necessary, a symmetrical adjustment of the wipers on TR4 and TR5 will be necessary to maintain even clipping. This balanced adjustment should achieve two things. The setting of a 2.0 A (USA370), or 4.5A (USA850) a.c. current draw from the line voltage while at the same time maintaining even clipping on the negative and positive portions of your output sinewave.

2. While the amplifier is driving a short between the black and red binding posts of the channel under test, observe the main supply rail voltages, ideally they will be no more than 3 volts from each other.

3. Next, an important thing to look for is that the channel will recover from a short into a 2 ohm load.

4. Perform the same procedure for the next channel to be calibrated.

**♦ 2 OHM POWER**

Verify correct loading down to 2 ohms. 2 ohms is allowed to clip somewhat unevenly, but must pass 250W on the USA370 and 550W on the USA850 (one channel driven, 1kHz, 1% THD). At this point, verify CLIP and PILOT LED's by adjusting your generator control until the channel is just above clipping.



## USA Amplifier Series

- ◆ **FREQUENCY RESPONSE**

Set load to 8 ohms and scale your input to achieve 1 watt of power from the amplifier on each channel. Gain controls on the amplifier should be fully open. Check frequency response from 20Hz. (+0, -1dB at 1 watt) to 20KHz. (+0, -1dB at 1 watt) by sweeping random frequencies between these points. Check both channels.

- ◆ **POWER VS. DISTORTION TEST**

Check to ensure that both channels will produce rated power at 20Hz, 2KHz, and 20kHz. While verifying rated power check that at all frequencies the distortion measurement is less than 0.1% (just below the onset of clipping.)

- ◆ **THERMAL TEST**

Set input frequency to 2KHz and short both channels while they are producing power into a load. AC current of about 2.0-3.0 amps PER CHANNEL should be read from the 120v (240v) line voltage. Verify that the PTC circuit causes thermal shutdown after an extended period. When shutdown occurs, verify AC idle of .75 to 1.5 amps. While waiting for thermal shutdown, verify presence of IC (IC1a & b) voltage at pins 4 and 8 of 4 - 8 volts d.c..

- ◆ **CM TEST**

Check the Common Mode Rejection by inserting the 1/4" input jack halfway into each channel and observe a 50% signal reduction, and a 180 degrees phase inversion at the output of the amplifier under test.

- ◆ **OUTPUT NOISE**

Set the amplifier **GAIN** to 0dB, with a 2kHz 1.00Vrms input signal. Note the output level. Remove the signal input connector and measure the residual noise level produced into the load. The noise level should be 400 dB down from the full output power point measured. A signal to

- ◆ CHANNEL OUTPUT

1. Look for normal signal on the scope of channel 1. Switch the input signal and scope to channel 2 and repeat output test. Check for noisy / contaminated gain pots by observing general instability on your distortion waveform while adjusting the gain control levels.
2. Select an 8 ohm load and confirm that this product is passing 400 watts at 1KHz 1% distortion.

- ◆ BRIDGE MODE

Move the Bridge switch on the amp from the Stereo to Bridge position. Turn gain on CH2 fully counter clockwise (off). Remove the input plug from CH2. Check CH2 for full output with input applied to CH1. The output signal on CH2 should be 180 degrees out of phase with CH1 output signal. Turn power off and place the amplifier under test back into the Stereo mode.

- ◆ BIAS ADJUSTMENT

While still at 20kHz, reduce input signal 20dB (80%) from full output and adjust cross-over trimpot (TR1a & b) for a less than 400mVpk-pk cross-over spike protruding from the noise trace on the scope. An idle current (no signal applied with an 8 ohm load) should be less than or equal to 1.2A a.c.

If a distortion analyzer is not available, a less accurate crossover distortion and bias adjustment can be made by monitoring the driver transistor (Q1 & Q2) bias current. With the amp at room temperature, and no input signal plugged into the amplifier, measure the DC voltage across the emitter resistors of Q1 and Q2. Adjust TR1a,b to obtain about 80mV d.c.

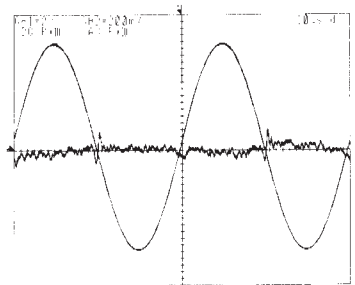

Correct Crossover

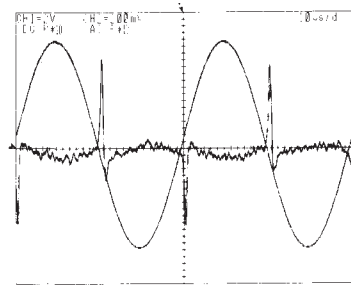

Incorrect Crossover

- ◆ SHORT CIRCUIT CURRENT

1. Select a 4-ohm load and verify even clipping on both channels by adjusting a 1kHz input signal to just beyond 1.13VRMS (sine wave) with gain control fully up on the channel under test. Apply a short to the output binding posts of each channel one channel at a time and adjust the short circuit current limits. TR2a & b is for current limit adjustments. Upon shorting the channel, AC current draw from the wall of 5.5A (2.5A, 240V) should be evident.

2. While the amplifier is driving a short between the black and red binding posts of the channel under test, observe the main supply rail voltages, ideally they will be no more than 3 volts from each other.

3. Next, an important thing to look for is that the channel will recover from a short into a 2 ohm load and clip evenly. In order to set even clipping, adjust TR3a&b. If an adjustment with TR3 is necessary it is very important to re-measure the d.c. voltage rails and ensure that they do not deviate more than 3 volts from each other (ignoring the polarity difference).

4. Perform the same procedure for the next channel to be calibrated.

- ◆ 2 OHM POWER

Verify correct loading down to 2 ohms. 2 ohms is allowed to clip somewhat unevenly, but must pass 1000W (one channel driven, 1kHz, 1% THD). At this point, verify CLIP and PILOT LED's by adjusting your generator control until the channel is just above clipping.

- ◆ FREQUENCY RESPONSE

Set load to 8 ohms and scale your input to achieve 1 watt of power from the amplifier on each channel. Gain controls on the amplifier should be fully open. Check frequency



## USA Amplifier Series

response from 20Hz. (+0, -1dB at 1 watt) to 20KHz. (+0, -1dB at 1 watt) by sweeping random frequencies between these points. Check both channels.

- ◆ **POWER VS. DISTORTION TEST**

Check to ensure that both channels will produce rated power at 20Hz, 2KHz, and 20kHz. While verifying rated power check that at all frequencies the distortion measurement is less than 0.1% (just below the onset of clipping.)

- ◆ **THERMAL TEST**

Set input frequency to 2KHz and short both channels while they are producing power into a load.

AC current of about 4.0 to 5.0 amps PER CHANNEL should be read from the 120v (240v) line voltage

Verify that the PTC circuit causes thermal shutdown after an extended period. When shutdown occurs, verify AC idle of .75 to 1.5 amps. While waiting for thermal shutdown, verify presence of IC (IC1a & b) voltage at pins 4 and 8 of 4 - 8 volts d.c..

- ◆ **CM TEST**

Check the Common Mode Rejection by inserting the 1/4" input jack halfway into each channel and observe a 50% signal reduction, and a 180 degrees phase inversion at the output of the amplifier under test.

- ◆ **OUTPUT NOISE**

Set the amplifier **GAIN** to 0dB, with a 2kHz 1.00Vrms input signal. Note the output level.

Remove the signal input connector and measure the residual noise level produced into the load.

The noise signal should be 100 dB down from the full output power point measured. A signal to noise ratio should be better than 100dB (A weighted). Check both channels.

- ◆ **FINAL CHECK**

This completes the electronic test procedure. Inspect the amplifier for mechanical defects. Inspect the solder connections. Reassemble the amplifier and verify the amplifier's operation before returning the product to service.



## USA Series Troubleshooting

### Current Draw

*(Circuit breakers and fuses blow. Burning smell or smoke)*

**Symptoms:** All MODELS

- ◆ Fuses immediately blow
- ◆ Amplifier quickly gets very hot
- ◆ Line circuit breakers tripping upon turn on
- ◆ Amplifier exhibits very loud hum with chassis vibration
- ◆ Amplifier emits smoke
- ◆ A burning smell is emanating from the amplifier

#### Possible Causes:

- ◆ EXCESSIVE CURRENT WITHOUT SIGNAL PRESENT  
The amplifier draws high current when the AC supply voltage is first applied up (with signal but no load). This symptom means there is a short in the power stages of the circuit. It is possible to lift the fuse for each channel to isolate the problem to one channel (the USA1300 has two fuses per channel). This could also show a misadjusted bias setting. See calibration procedures in this manual for setting bias.
- ◆ FAST CURRENT DRAW (increases rapidly at only a few volts AC voltage):  
Reversed or shorted main bridge rectifier B1.  
Both supply clamping diodes D6, D7 reversed or shorted  
Both polarities output transistors or drivers shorted.
- ◆ MEDIUM CURRENT DRAW (increases slowly, can go to 30 VAC before current becomes excessive.):  
Single polarity driver or output short.  
Single supply clamping diode D6 or D7 reversed or shorted.  
Open or missing bias diodes D1, D2 or bias trim pot TR3 and R38.
- ◆ SLOW CURRENT DRAW (above 60 volts AC before current begins to increase, amp may pass signal).  
Severely misadjusted bias circuit or defective bias diodes D1-2.  
Severe oscillation causing current drain.
- ◆ RUNAWAY CURRENT DRAW (30-40V AC before current begins to increase or runaway):  
A reversed filter capacitor: caution, may vent explosively.

### Protection, Muting Circuit & Power On/Off Delay

*(The amplifier locks up or does not startup and shut off correctly)*

**Symptoms :** All MODELS

#### USA370, & USA850

- ◆ Both channels do not come out of protect
- ◆ Amplifier will not thermally protect
- ◆ Pilot LED not working
- ◆ Too little or too much muting delay

#### USA1300

- ◆ Relay won't turn on
- ◆ Poor mute circuit timing
- ◆ No D.C. protect
- ◆ Shuts off under signal
- ◆ No Red protect LED
- ◆ No thermal shutdown



## USA Amplifier Series

### *Possible Causes:* USA370, & USA850

- ♦ BOTH CHANNELS DO NOT COME OUT OF PROTECT
  - Q11 or Q12 shorted base emitter
  - Voltage on Z5 should be 14v - 15v. If this voltage is low, check for leaky E8, E9, defective Z5, or open R33.
  - Check for open LD3 and open PTC.
- ♦ AMPLIFIER WILL NOT THERMALLY PROTECT
  - Check for shorted LD3 and PTC, incorrect R35, R34, open pilot LD2, or open R39.
- ♦ MUTING DELAY
  - Too Much: Check for open LD2 or R39, incorrect R33, R34, R35 or shorted LD3.
  - Too Little: Check for incorrect E8, E9, or R33.
- ♦ PILOT LED NOT WORKING
  - Check for shorted or open pilot LD2. Check R39.

### *Possible Causes:* USA1300

- ♦ RELAY WON'T TURN ON
  - Check speaker bus for DC; if over 10V DC is present, the protect circuit is operating normally to prevent operation. If DC is present, (presumably without current draw), continue below; if no DC is present on the output, skip to the section below other protection related faults.
  - Check relay power voltage. With relay off, voltage at E5 should measure 36V (set by Zener Z6). If not check R31, D9, or shorted Z6.
  - If power voltage is OK, check voltage on timing capacitor E4. Should rise to 12-15V, in three seconds, which triggers Q19. If not, check R19, R20, E4's polarity, or for a shorted Q20.
  - If timing voltage is OK, check relay transistor Q21. If good, a 47K resistor from base to speaker bus should activate relay.
  - If relay driver Q21 is OK, check driver Q19 and LED LD3.
- ♦ POOR MUTE CIRCUIT TIMING
  - NO MUTING DELAY (*relay or circuit is "stuck on"*)
    - Relay driver Q21 shorted or wrongly mounted. Check by jumping base to emitter, should turn it off if OK.
    - Driver Q19 shorted or wrongly stuffed (check by jumping base to emitter as above).
    - D7 reversed (charges timing capacitor E7 immediately)
    - R20 low (fast E4 charge)
    - R19 low (low voltage on E4 turns Q19 on too soon)
    - Missing or high R23 (no off current)
  - EXCESSIVE MUTING DELAY
    - Check timing capacitor E4 voltage. If it rises normally but circuit is slow to turn on, check Z7 (lift temporarily while checking circuit), LD3 bad or intermittent, R23 too low.
    - Timing capacitor voltage wrong; check for R19, R20, reversed E4, missing R22.
    - Reversed or wrong Q20 type.
- ♦ NO D.C. PROTECT
  - DC FAULT WITHOUT CURRENT DRAW. In most cases, shorts in the output circuit will cause current draw, but certain shorts will only cause DC offset in the output. In both cases, measure the various circuit voltages, and look for abnormal values to help trace the fault, which can be a solder or component short (zero volts), reversed zener or diode (.6V) reversed electrolytic (several volts), or wrong value parts (abnormal voltage). Look at the following points in the circuit.
    - Shorted IC rail, sometimes both shorted together; including input cable connectors and jacks
    - Defective Z2-3 gives zero volts on IC rail.
    - Collector-base short on driver (rare without further damage)
    - Sometimes IC forces the rest of the circuit into DC due to shorts in the feedback network, etc. To check this, remove IC, check for +15V, -15V on IC rails, and balanced voltages in the drivers and outputs. If so, output stage is probably OK, look for problems in IC, or its associated parts.
    - Defective or reversed IC (pull and check voltages).
    - R30 missing or very high.
    - B2 defective or wrongly mounted on PCB.
    - Q20 defective or wrong type.
    - D7 reversed (also no muting delay).
    - Replace LD-3 if voltage drop across it is less than 1.5V.





- ♦ SHUTS OFF UNDER SIGNAL  
E6 missing, defective, or much too small.
- ♦ NO RED PROTECT LED  
Check LED voltage. If over +2V, LED is defective. If 0V with relay off (meaning no positive voltage to LED), check for solder short, or there is no "protect" power, (missing R29), which defeats shut-down circuits. Be sure to correct before proceeding.
- ♦ NO THERMAL SHUTDOWN  
Short amplifier load with full signal to raise heat sink temperature and put voltmeter across PTC, (yellow sensor on heat sink), looking for voltage across PTC to rise from .7V cold to about 5.5V at shutdown.  
No Red "Protect", may have no R29, which defeats whole thermal circuit (no voltage across PTC). If the PTC reaches 6V but won't shut down, check Z7, or relay drive circuit stuck on (see above). If red "protect" /R12 is OK, but no voltage across PTC, then the PTC is defective or shorted (lift temporarily or replace with 10K pot, confirm shutdown).

---

### **Faults with Signal Present**

*(The amplifier passes a signal but is not running correctly)*

**Symptoms : All MODELS**

- ♦ Output power "breaking up"
- ♦ 'Ringing' sound with no input to amplifier
- ♦ Output collapses into a 8, 4 or 2 ohm load
- ♦ Voltage rails ok without signal.
- ♦ Amplifier gets too hot
- ♦ One channel clips prematurely
- ♦ Excessive hum with no input to amplifier

**Possible Causes:**

- ♦ OUTPUT POWER "BREAKING UP" (*Output distorted*)  
Hum-null components may have burned open. Check R7, R8 and TR2.  
Ground traces may be bad. Check for continuity between speaker ground, input ground and ac ground.
- ♦ "RINGING" SOUND WITH NO INPUT TO AMPLIFIER  
C2 and/or C4 (C4, C7, USA1300) may be bad.  
Check op amp IC1.
- ♦ OUTPUT COLLAPSES INTO A LOAD  
No continuous ground between main pcb to heatsink through pem stud. The spring tooth lock washer may not be biting through anodized surface on main heatsink.  
Misadjusted TR4 or TR5.  
Check for R20 and R21.
- ♦ VOLTAGE RAILS OK WITHOUT SIGNAL *Collapses with a signal*  
E2 or E3 leaking.  
Check for capacitance value of C2 and C4 (C7, C13, E1, USA1300).
- ♦ AMPLIFIER GETS TOO HOT WITHOUT LOAD  
TR3 (TR1, USA1300), misadjusted, opened or burned.  
Incorrect bias diode (should be 1N4934) D1, D2 (D5, D6, USA1300).  
Missing C2 or C4 (C4, C7, USA1300). High frequency oscillations evident.  
Open R17, R18 (R16, R17, USA1300).  
Defective op amp IC1. Unstable and generating high frequencies).
- ♦ ONE CHANNEL CLIPS PREMATURELY  
R15 or R16 may be open.  
Misadjusted TR4 & TR5.  
Into a 4 ohm load, check for open R22, or open D4 & D5 (D1 & D2, USA1300).  
Check R7 & R8 for open or incorrect value.  
Check for open R12, R13, R20, R21 (R14, R15, R52, R53, USA1300)  
450 ohm chargeback resistor R22 may be open.



- Check for open on D4 and D5.
- ◆ EXCESSIVE HUM WITH NO INPUT TO AMPLIFIER  
TR2 (hum-null trim potentiometer) misadjusted, opened or burned.  
Check for mismatched capacitance value of output filter capacitors.

---

### ***Instability***

*(Gain problems, spurious noises, and oscillations)*

**Symptoms :** All MODELS

- ◆ General Output Distortion
  - ◆ "Ringing" sound with no input to amplifier
  - ◆ Excessive or unbalanced crossover
  - ◆ Output waveform appears "fuzzy"

**Possible Causes:**

*First, distinguish between instability (fuzziness), "ringing" which is momentary instability after a transition, "step" distortion, crossover distortion (both often show ringing), or general distortion.*

- ◆ GENERAL OUTPUT DISTORTION  
SEVERE:  
All loads, often with current draw: usually very low or missing slew rate capacitor C4, or feedback capacitor C2.  
MEDIUM:  
Especially with a light load, often too high a value of a stability capacitor; check feedback capacitor C2, secondary stability capacitors C9, (C5,6 USA1300); and output filter R32/C5 (USA1300-R27,28/C10). Jump with comparable value, if better, replace with increased value, if worse, try replacing with 50% lower value).  
LOW GAIN:  
Suspect open circuit in feedback shunt R5 (USA1300-R7/E1). Check for broken circuit trace. Substitute IC, and check IC socket for contamination.
- ◆ "RINGING" SOUND WITH NO INPUT TO AMPLIFIER  
Usually indicates marginal instability, usually triggered after passing through the crossover. Can indicate problem in "minor" stability components. Also check output filter.  
Possibly the crossover is larger than usual.
- ◆ EXCESSIVE OR UNBALANCED CROSSOVER (*Excess notch or ringing at zero crossing*)  
Severe: shorted bias diode D1-2 (D5, D6, USA1300).  
Moderate: Out-of-spec bias diodes.  
Defective bias trimmer components TR3 (TR1, USA1300) and R38 (R54, USA1300).  
Check for open base resistors R17,18 (R16, R17, USA1300) on output devices.
- ◆ OUTPUT WAVEFORM APPEARS "FUZZY"  
Instability on one side of the waveform:  
Add .015uF trimmer bypass capacitor around bias trimmer TR3 (TR1, USA1300).  
Check/adjust driver emitter capacitors C8 and C9 (C5,6 on USA1300).



---

## **Power Supply & Voltage Rail Balancing**

*(Uneven rails and power supply problems)*

**Symptoms :** All MODELS

- ◆ Current limiting wrong
- ◆ Current limiting too high into short
- ◆ IC Rail too high into short
- ◆ Current limiting too low into short
- ◆ Uneven voltage rails

**Possible Causes:**

- ◆ CURRENT LIMITING WRONG  
Current limits should remain high down to 2 ohms, and collapse to a lower value for short circuits. This is caused by the IC rails going from normal 14 - 15 volts to about 5-6 volts. Current limit trimmers TR4 & TR5 (TR2 on USA1300) permits adjustment of each channel to specified range. See Test & Calibration Procedures for correct adjustment of the current limiting.
- ◆ CURRENT LIMITING TOO HIGH INTO SHORT *(IC RAILS CHECK NORMAL 5-6 volts)*  
Reversed or shorted 3.9 or 4.7V zeners Z15, Z16.  
Shorted bias diode D1,2 (also shows severe crossover), (D5, 6, USA1300).
- ◆ IC RAIL TOO HIGH INTO SHORT  
Check op amp (weak output current).  
Clip LED open.  
B2 defective, (B1, USA1300)  
Check for short circuit current balance on the USA370 and USA850 by measuring the main rail voltages during short circuit; they should be balanced within 3V. If severely offset, check Z3 (3.9V) and Z4 (4.7V) for correct voltage, and check values of R15 and R16.
- ◆ CURRENT LIMITING TOO LOW INTO SHORT AND 2 OHM LOAD  
IC RAILS OK  
Bias resistor R12, R13 high.  
Very low gain driver transistors (see below).  
Missing connection or emitter resistors in some of the paralleled output transistors.
- ◆ CURRENT LIMITING TOO LOW INTO SHORT ONLY *(OK into normal loads)*  
Check Clip LED shorted, 1.5A rectifier B1 shorted.  
3.9 or 4.7V zeners high (7.5V or 15V).
- ◆ OK INTO SHORT BUT LOW INTO 2 OHMS: *(Usually on one side only)*  
IC RAIL LOW (driving two ohms even before clipping): check for high or missing charge-back R22 (USA1300-R49), or missing/reversed charge-back diodes D4 or D5 (usually causes premature clipping at 4 ohms as well).  
IC RAIL OK (until clipping starts) usually indicates low output section gain caused by weak driver, open output devices, or open emitter resistors. Also check value of driver emitter resistors R15, R16.
- ◆ UNBALANCED RAIL VOLTAGES: *(USA370 and USA850)*  
Rail voltage is determined by R7 and R8 from the positive and negative rails.  
If the amplifier is passing a signal but clipping unevenly due to uneven rail voltages, check and replace R7,8 (47K, 1watt, Metal Oxide).



## NOTES

---

### *USA1300 Power Supply*

The USA1300 power supply has a transformer center-tap return (DC-coupled), so the rails are forced to remain balanced. Check current balance by raising scope gain during short, and looking at the small voltage across the residual resistance of the short. The voltages (and thus currents) must be balanced within 33% (2:3 ratio maximum). They may be quite uneven. If so, check Z4 (3.9V) and Z1 (4.7V) for correct voltage, check values of R12 and 13, and if necessary adjust values of R10 and R11 within 750 -15K to balance the currents. Concentrate on the parts mentioned above, connected to the side with the high current (remember "reverse" polarity of QSC circuit –see below).

### *Driver Transistor Gain*

To check driver gain, note the "REVERSED" polarity of QSC circuitry. The positive side of the circuit pulls the rails and output DOWN and thus is responsible for NEGATIVE output problems; the negative side of circuit is responsible for positive output. First, confirm their value, and then scope probe or measure the DC voltage on driver emitter resistors R15 or R16. If the driver's emitter resistor on the weak side has low voltage, its current is low, caused by poor drive or low gain. Inspect drive components shown above in Short Circuit Limit sections, or substitute drivers with an approved part. If a driver shows equal or greater current, it is OK and is trying to overcome weakness in outputs. Check that all devices and emitter resistors are good.

### *How to determine which power transistors are shorted:*

Determine which power supply rail (+ or -) is being clamped to ground. A positive side short (Q1-6) will clamp the positive rail to ground, and a negative side short (Q2, Q7-10) will clamp the negative rail to ground.

Raise the AC supply voltage current until the current draw is 2-5 amps. Measure the voltage on the supply rail and output transistors. A hard short to ground will read virtually zero volts. A shorted output device will read 0-.5V depending on the short current.

Confirm that a voltage drop exists across that device's emitter resistor as well. A measurement of .6-1V above ground indicates clamping due to reversed or defective diode D6-7, or a shorted output. A measurement of 1-2 volts could mean a bad driver, but the outputs may be OK (especially if all emitter resistors have the same voltage drop).

Determine which individual devices in a parallel bank are shorted by measuring the voltage across the emitter resistors on the side with the low rail (the faulty side). The shorted devices will draw more current, causing higher voltages on their emitter resistors. The good devices on the opposite rail will all be conducting equal current.

If the base voltage to a group of outputs measures zero, there is a probable solder short to the heat sink or an output collector-to-base short (rare). If output collector to base junction is shorted, all outputs on the same bank must be removed from the circuit board and check the same collector to base junction carefully.

Check for a driver transistor short by measuring across the emitter resistors R15 and R16 (USA1300-R12/13). If the voltage drop is near zero, there is no driver transistor current draw and no driver transistor short. Don't forget to check for open emitter resistors (burned open by a shorted output device).

## **USA Series Circuit Description**

---

This circuit description pertains to the USA850 amplifier which in turn corresponds to the USA370. Reference designators given on the schematics can be referred to to make comparisons when review this description. Refer to the appropriate schematic when following the description given on the coming pages.

### **Power Supply**

AC Power comes in through a thermal (slow-blow) circuit breaker and AC switch. A row of terminals on the main circuit board allows the transformer primary to be wired in parallel for 120V, 60Hz operation, or in series for 220V, 50Hz operation. Transformer exciting current will rise to the limit at 240V, 50Hz, which may increase AC hum in the amplifier. Also, note that there will be an 8% voltage reduction at 220V (110V volts per primary section) compared to 120V operation. This results in a 15% loss of amplifier power but increases transformer capacity for the primary US market.

The fan speed is controlled by R42, a 250 ohm, 15W resistor and a 55C thermostat. With the resistor in series, the fan operates at about half speed. When heat sink temperatures exceed 55C, the thermostat clicks in and bypasses the resistor, giving full voltage to the fan.

The transformer has independent secondary windings for each channel. Each channel has its own filter capacitors (E4, 5, 6, 7) and power rectifier (B1). A fault fuse (F1) is located prior to the rectifier to disconnect a faulty channel. The current rating of the fuse, 12A, is high enough to carry the maximum current of a properly operating channel, even into a short circuit, so the fuse should only blow in case of an actual fault (i.e. shorted output transistor).

There are two unusual features of the QSC power supply circuit. First, while we use conventional positive and negative filter capacitors, for a balanced bipolar power supply, there is no return from the center point to the center-tap of the power transformer. This means that the center voltage of the two capacitors is free to float. Since audio currents have no average DC content, equal power is drawn off both capacitors, and the positive and negative voltages remain equal. This is assisted by feedback circuits described below. However, if the amp develops a DC fault, such as a power transistor short to one of the rails, no long-term DC can flow to the load. Instead, the voltage on the capacitors becomes unbalanced, and the "DC fault" is blocked. The net effect is the same as adding a bipolar output capacitor, without and added expense.

The second unusual feature is that we reverse the usual location of the speaker and ground terminals. For reasons explained in following sections 4 and 5, we ground the common collectors of the output transistors, and take the audio output from the midpoint of the power supply capacitors. This requires separate filters, rectifiers, and transformer secondaries for each channel, but results in minimal cross-talk, and permits one channel to fail without affecting the other.

The bipolar 15V rails for the op amp are derived using dropping resistors (R20 and R21) and zener stabilizers (Z1 and Z2) from the main rails. The op-amp supply rails are involved in our short-circuit protection scheme, as described in a following section.

### **Balanced Input Circuit, Gain Control & Frequency Limits**

The first stage of the dual op-amp is used as a differential input. Matched precision resistive dividers R1/R3, and R2/R4, are arranged so that any signal appearing equally on both the positive and negative inputs results in no voltage across the op-amp input terminals, and no voltage at the output of the op-amp. In other words, noise signals which normally occur equally on both sides of the balanced line are rejected. The audio signal appears as a difference between the balance-line conductors, and these signals are picked up and appear at the same gain at the output of the op-amp. For unbalanced inputs, either input line may be grounded, and the circuit will respond at unity gain to the other line. For reasons of overall stability in actual use, QSC uses the inverting input for unbalanced signals.



After balanced-to-unbalanced conversion, the audio signal flows through a 4.7 $\mu$ F NP (E1), for low frequency rolloff (-3dB at 8Hz), with the 4.7k outboard resistors (R11 and one mounted on jack panel) gives a uniform attenuation slope as calibrated on the Gain control label. Finally, R10 and C1 establish a high frequency rolloff (-3dB at 75kHz). The net audio response is typically down less than 0.5dB from 20 - 20kHz.

### ***Amplifier Feedback Network, Gain Stage, Distortion LED, Short Circuit Protection, and Bridging.***

The actual power amplifier begins at the input to the second stage of the op-amp. Audio feedback is established across R6, from the speaker, and R5 to ground. DC feed back to keep the rail voltages equal is established by matched resistors R7 and R8. If the filter capacitors, are slightly mismatched, ripple on the positive and negative supplies are unequal, and hum can appear at the output during large signal loading. A "hum null" trim, R9, C3, and TR2, allows this to be canceled out.

High frequency stability is established by C4 and C2. C4 is the primary "phase lag" capacitor, which sets slew rate and thus the overall "speed limit" of the circuit. C2 establishes "phase lead" in the speaker feedback network, increases feedback at very high frequencies and thus improves control at frequencies where oscillations might occur. C7, at the output of the op-amp, and L1, R31, R32, and C5, at the speaker output, and C9 (in later versions only) further improve stability.

Most of the gain in the amplifier is contribute by the second stage of the op-amp. this stage's primary job is to feed the driver transistors, but is also used to drive the Distortion LED (LD1) and is tied in to the short circuit protection scheme.

As long as the output of the amp is not clipping, the drive voltage to the bases of the driver transistors, Q1 and Q2, remains below 1.5 volts peak. If the amp clips, the op-amp will attempt to overcome this by instantly delivering a higher than normal voltage to the drivers. This excess voltage is used to driver the distortion (clip) LED, which requires a voltage in excess of about 2 volts to operate. Thus any form of clipping immediately results in illumination of the distortion LED.

One of the feature advantages of the QSC circuit is our effective short circuit protection., In order to maintain good audio performance into low impedance loads, it is necessary to maintain a high output current limit. The normal current limit is determined by the base current to each driver through 1K resistors and 3.9V zener diodes (R12/Z3, and R13/Z4). When the op-amp rails are at their normal 15V, this current is about 9ma, and results in about 20A of output current. This is sufficient to deliver rated power into a two ohm load. The output transistors can withstand this much current into a short for a few seconds, but would overheat and fail before thermal shutdown can occur. Therefore, we need a method of reducing current into shorts without affecting normal operation.

The normal range of currents from the op-amp is less than the current supplied from the main pwer supply rails by R20 and R21. however, as full pwer is reached, and especially if the amp is clipped and the op-amp has to deliver extra current to the distortion LED, more current is drawn than these resistors can supply, and the op-amp rail voltage would normally be drawn down. To prevent this, we have a replenishing circuit, from the speaker output voltage, through R22 and rectifiers D4 and D5. As long as the load impedance is above 2 ohms, there will be enough output voltage to recharge the op-amp rails through this network. If the output is shorted, however, the output voltage will be clamped to a low value, the recharged will no occur, and the op-amp will deplete its supply rails to about 6 volts. This will cut the current tot he drivers drastically (through R12 and R13), and reduces output current to a safe level which the amp can withstand until thermal shutdown occurs. The exact short-circuit current is adjusted by trimpots TR4 and TR5, which varies the voltage drop between the op-amp and the driver transistors, ultimately determining the maximum depletion of the op-amp rails.

Bridged-mono operation requires that channel 2 operates at the same level but out-of-phase with channel 1. This is achieved by connecting the output from channel 1 through the bridge switch and R19 into the inverting input of channel 2. R19's value matches that of the feedback network, for unity gain in Ch.2. Since Ch.2's gain control is bypassed, the gain for Ch.1 controls the entire signal, and equal signal in both channels is assured.

### ***Complementary Driver Transistors & Crossover Bias***

The problem now becomes to amplify the low voltage and current from the op-amp to the full power of the amplifier. We can do this with only two stages of discrete transistors by using careful design.



Complementary drivers Q1 and Q2 are connected to the op-amp through bias diodes D1 and D2. the forward voltage drop of the diodes matches the forward base voltage of Q1 and Q2, so that as the op-amp swings on either side of zero, it immediately drives Q1 or Q2. This eliminates a "dead zone" which would cause crossover distortion. The bias trimpot TR3 was added in series with D1 and D2 to permit the bias to be fine tuned. Emitter resistors R15 and R16 are used to stabilize the gain of Q1 and Q2, and to minimize any tendency to draw more idle current as they heat up. These resistors drop about 1.5 volts at full current, which reduces the output power slightly. The final collector current from Q1 and Q2 is about 500ma, and goes to the bases of the output transistors.

## ***Complementary Output Transistors***

The emitters of the positive and negative output transistors (Q3, 4, 5, 6 and Q7, 8, 9 10) are connected to the main rails through load-sharing emitter resistors R23, 24, 25, 26 and R27, 28, 29, 30. The parallel bases of each bank are bypassed with 22 ohm resistors R17 and R18, which assure positive shut off of the outputs. The 500ma currents from the collectors of Q1 and Q2 are connected to the output transistor bases and amplified to about 20A peak.

Note that the collectors of all output transistors meet at a common ground. This is possible because of the special power supply arrangement outlined earlier. This means we can simply screw the cases to a grounded heat sink, with no need for the usual insulating mica. This saves money and improves reliability through better cooling.

As mentioned earlier, the speaker output is taken from the midpoint of the power supply capacitors. this means that the audio output voltage is superimposed on top of the DC supply voltages, which must be kept in mind when checking these voltages. A stability filter, L1, R31, R32, and C5, eliminates the effects of reactive loads at frequencies way above the audio range where the amp might be unstable.

## ***Muting Delay & Thermal Shutdown***

A small independent power supply is derived through D8 and R33. This a half-wave rectified signal brought from the secondary of the transformer. This supply is used to provide voltage to the pilot LED, mute RC time constant, and thermal shutdown circuits. When the amplifier is turned on, a 47uF 50V (E9) begins to charge until it reaches a point to where it energizes the rest of the circuit to bias Q11 on. When Q11 is biased on, Q12 is no longer conducting. Q12 in its default state is biased on to where its conducting current from the collector - emitter junction. This effectively cancels the 15 volt op-amp rails that appear at this junction. After approximately three seconds, when E9 charges, up Q11 is turned on thereby turning off Q12. When Q12 is no longer in conduction, then the 15 volt rails are free to supply voltage to the op-amps on channel 1 and 2. A 4.7uF 160v capacitor (E8) serves as an immediate drain of voltage upon power up of the amplifier.

Excessive heat sink temperatures are sensed by a PTC resistor. This special part has a positive temperature coefficient which starts to increase rapidly above 80C. When the heat sink temperature reaches about 95C, the resistance is high enough to block power to Q11, and the signal is muted until the amplifier cools down. One drawback of this scheme is that it will not correct overheating due to run away idle current, so careful adjustment of crossover bias is essential.



# USA Amplifier Series

## USA 1300 Ch. 1 Main Board Assembly

| Part Number  | Description                    | Reference          | Part Number  | Description                     | Reference    |
|--------------|--------------------------------|--------------------|--------------|---------------------------------|--------------|
| CA-027100-BM | 27PF,100V,10%,MICA             | C4                 | QD-005402-DX | 1N5402 DIODE                    | D3,4         |
| CA-110100-BM | 100PF,100V,5%,MICA             | C1,2               | QD-008599-TX | MPS 8599 TRANSISTOR, PNP        | Q19,20       |
| CA-147100-BD | 470PF, 100V, 10%, DISK         | C5                 | QD-1.5200-BX | 1.5A 200 VOLT BRIDGE RECTIFIER  | B1,2         |
| CA-215200-BP | .0015UF,200V,10%,MYLAR         | C7                 | QD-250400-BX | BR-254, 25A 400 VOLT BR. RECT.  | B3           |
| CA-222100-BP | .0022UF,100V,10%,MYLAR         | C8                 | RE-.04705-FW | .47 OHM, 3 WATT, WIREWOUND 10%  | R33-48       |
| CA-310100-BP | .01UF,100V,10%,MYLAR           | C6                 | RE-.56005-EM | 5.6 OHM, 2 WATT METAL OXIDE 5%  | R26          |
| CA-333100-BP | .033UF,100V,10%,MYLAR          | C9                 | RE-.68005-DM | 6.8 OHM, 1 WATT, MET. OXIDE 5%  | R12,13       |
| CA-410250-AS | .1UF, 250V, SURGE CAP.         | C10                | RE-000009-PT | 90 C PTC RESISTOR               | PTC          |
| CA-412100-CP | .12UF, 100V, 5%, MYLAR         | C3                 | RE-000050-NR | SC-50 NTC RESISTOR              | R54          |
| CA-610035-BE | 10UF, 35V, ELEC., RADIAL, 10%  | E4                 | RE-001005-EM | 10 OHM, 2 WATT, METAL OXIDE 5%  | R27,28       |
| CA-647010-BN | 47UF, 10V, RADIAL, NON-POLAR   | E1                 | RE-002205-DM | 22 OHM, 1 WATT, METAL OXIDE 5%  | R16,17       |
| CA-647050-BE | 47UF, 50V, ELEC., RADIAL, 10%  | E5                 | RE-015005-BC | 150 OHM, 1/4 WATT, CARBON, 5%   | R25          |
| CA-722010-BN | 220UF, 10V, RADIAL, NON-POLAR  | E6                 | RE-025010-NW | 250 OHM, 15 WATT, WIREWOND, 10% | R50          |
| CA-722025-BE | 220UF, 25V, ELEC., RADIAL, 10% | E2,3               | RE-033010-NW | 330 OHM, 15 WATT WIREWOUND 10   | R50          |
| CA-822100-BE | 220UF, 100V, ELEC, RADIAL,10%  | E7-14              | RE-033201-BM | 332 OHM, 1/4 WATT, MET.FILM,1%  | R7           |
| CH-140208-LX | 1200/1400/1700 HEATSINK, FAB.  |                    | RE-045010-HW | 450 OHM, 5 WATT, WIREWOUND 10%  | R31,49       |
| CO-000008-IC | 8 PIN IC SOCKET                | IC1                | RE-110005-BC | 1K OHM, 1/4 WATT, CARBON, 5%    | R5,14,15     |
| CO-350432-AP | .084" PIN 9 CONTACT PCB HEADER | CO2                | RE-115005-BC | 1.5K OHM, 1/4 WATT, CARBON 5    | R10,R24      |
| CO-641119-AH | 8 PIN .156"/C HEADER           | CO1                | RE-127005-BC | 2.7K OHM, 1/4 WATT, CARBON, 5%  | R11          |
| HW-000001-FC | FUSE CLIPS                     | F1,2               | RE-135005-HW | 3.5K OHM, 5 WATT WIREWOUND 10%  | R52,53       |
| HW-060100-PS | #6-32 X 10 PEM STUD            | P                  | RE-147005-BC | 4.7K OHM, 1/4 WATT, CARBON, 5%  | R6           |
| HW-060405-SP | #6 X 1/4" X 5/32" RND. SPACER  | P                  | RE-210001-BM | 10.0K OHM, 1/4W., MET. FLM. 1%  | R1-4         |
| HW-060600-SO | 1/4"X1/4" MALE/FEMALE 6-32     | S                  | RE-210005-EM | 10K OHM, 2 WATT, MET. OXIDE 5%  | R29,30       |
| IC-005532-OP | 5532 OP-AMP                    | IC1                | RE-221001-CM | 21K OHM, 1/2 WATT, MET.FLM 1%   | R9           |
| LB-100007-PC | PRODUCTION CONTROL LABEL LAR   | PCB                | RE-247005-CC | 47K OHM, 1/2 WATT, CARBON, 5%   | R21          |
| MS-000044-FT | FOAM ADHESIVE TAPE 1/8X 1/2 X1 | PCB                | RE-275001-BM | 75K OHM, 1/4 WATT, MET. FLM 1%  | R8           |
| MS-000066-HS | TO-66 HEATSINK AAVID #E5020B   | Q1,2               | RE-310005-BC | 100K OHM, 1/4 WATT. CARBON 5%   | R22,23       |
| MS-150250-FU | 15A, 250V, FUSE                | F1,2               | RE-333005-BC | 330K OHM, 1/4 WATT, CARBON 5%   | R19,20       |
| NW-060010-SL | #6 SPLIT TOOTH LOCKWASHER      | Q1,2               | SC-060060-PP | #6-32 X 3/8" P/P ZINC           | Q1,2         |
| NW-060500-KP | #6-32 KEPS NUT                 |                    | SC-061041-SP | #6-32X1/4" "A" P/P W/SCRAPING   | CUT-IN & PTC |
| PC-170053-CX | 1700 UPPER MAIN PCB (CH.1)     |                    | SC-062050-PP | #6 X 5/16" "B" P/P ZINC         | Q3-18        |
| PL-000000-AF | ADHESIVE FEET                  | PCB                | SW-000013-RY | RELAY, SPDT, 15A, 24VDC         | K1           |
| PL-903125-SP | BIVAR 903-125 SPACER           | D5,6,R54           | SW-000055-TS | 55C THERMAL CUT-IN SWITCH       | CUT-IN       |
| PL-905100-SP | BIVAR 905-100 SPACER           | L1                 | WC-0.6022-JW | .6" JUMPER, WHITE, 22 GA, SLD   | J4           |
| PL-905156-SP | SPACER, BIVAR 905-156          | LD3                | WC-001102-SQ | INSUL. SLEEVE QSC 1102,.6",CLR  | PTC          |
| PL-905200-SP | BIVAR 905-200 SPACER           | LD1,2              | WC-001103-SQ | INSUL SLEEVE 1103,.875",CLEAR   | CUT-IN       |
| PL-909235-SP | BIVAR 909-235 SPACER           | LD1,2              | WC-1.2518-JW | 1.25" JUMPER, WHITE 18 GA, SLD  | J2,3         |
| PT-110000-AT | 100 OHM TRIMPOT                | TR1,2              | WC-2.5018-JW | 2.5" JUMPER, WHT, 18 GA, SLD    | J1           |
| QD-000004-TX | MPS-U05 TRANSISTOR, NPN        | Q21                | XF-200014-CR | 2UH, 14 GA, COIL/VERTICAL       | L1           |
| QD-000005-QD | TO-220 NPN 250V                | Q1                 |              |                                 |              |
| QD-000006-QD | TO-220 PNP 250V                | Q2                 |              |                                 |              |
| QD-000032-QD | MOTOROLA MJ15022 NPN PWR XSTR  | Q11-Q18            |              |                                 |              |
| QD-000033-QD | MOTOROLA, MJ15023 PNP PWR XST  | Q3-Q10             |              |                                 |              |
| QD-000134-LR | RED T-1 3/4 LED, XC 4655       | LD2                |              |                                 |              |
| QD-000134-LX | RED/GREEN T-1 3/4, XC 5491     | LD1                |              |                                 |              |
| QD-0003.9-ZT | 3.9V TESTED ZENER              | Z4                 |              |                                 |              |
| QD-0004.7-ZT | 4.7V TESTED ZENER              | Z1                 |              |                                 |              |
| QD-0007.5-ZT | 7.5V TESTED ZENER              | Z5                 |              |                                 |              |
| QD-001340-LR | RED T-1 3/4 LED, UTILITY       | LD3                |              |                                 |              |
| QD-004004-DX | 1N4004 DIODE                   | D1,2,7,8,<br>D9,10 |              |                                 |              |
| QD-004744-ZA | 1N4744A 15 VOLT ZENER DIODE    | Z2,3               |              |                                 |              |
| QD-004753-ZT | 1N4753, 36 VOLT ZENER DIODE    | Z6                 |              |                                 |              |
| QD-004934-DX | 1N4934 DIODE                   | D5,6               |              |                                 |              |

## USA 1300 Ch. 2 Main Board Assembly

| Part Number  | Description        | Reference |
|--------------|--------------------|-----------|
| CA-027100-BM | 27PF,100V,10%,MICA | C4        |
| CA-110100-BM | 100PF,100V,5%,MICA | C1,2      |
| CA-147100-BD | 470PF, 100V, 10%,  | C5        |
| CA-215200-BP | .0015UF,200V,10%,M | C7        |
| CA-222100-BP | .0022UF,100V,10%,M | C8        |
| CA-310100-BP | .01UF,100V,10%,MYL | C6        |
| CA-333100-BP | .033UF,100V,10%,MY | C9        |
| CA-368250-AS | .068UF,250V,SURGE  | C11       |
| CA-410250-AS | .1UF, 250V, SURGE  | C10       |
| CA-412100-CP | .12UF, 100V, 5%, M | C3        |



## USA 1300 Ch. 2 Main Board (cont.)

|              |                    |          |              |                    |          |
|--------------|--------------------|----------|--------------|--------------------|----------|
| CA-610035-BE | 10UF, 35V, ELEC.,  | E4       | RE-115005-BC | 1.5K OHM, 1/4 WATT | R11,R24  |
| CA-647010-BN | 47UF, 10V, RADIAL, | E1       | RE-127005-BC | 2.7K OHM, 1/4 WATT | R10      |
| CA-647050-BE | 47UF, 50V, ELEC.,  | E5       | RE-135005-HW | 3.5K OHM, 5 WATT W | R52,53   |
| CA-722010-BN | 220UF, 10V, RADIAL | E6       | RE-147005-BC | 4.7K OHM, 1/4 WATT | R6       |
| CA-722025-BE | 220UF, 25V, ELEC., | E2,3     | RE-210001-BM | 10.0K OHM, 1/4W.,  | R1-R4    |
| CA-822100-BE | 2200UF, 100V, ELEC | E7-E14   | RE-210005-EM | 10K OHM, 2 WATT, M | R29,30   |
| CH-140208-LX | 1200/1400/1700 HEA |          | RE-216501-CM | 16.5K, 1/2 WATT, M | R51      |
| CO-000008-IC | 8 PIN IC SOCKET    | IC1      | RE-221001-CM | 21K OHM, 1/2 WATT, | R9       |
| CO-350432-AP | .084" PIN 9 CONTAC | CO-2     | RE-247005-CC | 47K OHM, 1/2 WATT, | R21      |
| CO-641119-AH | 8 PIN .156"/C HEAD | CO-1     | RE-275001-BM | 75K OHM, 1/4 WATT, | R8       |
| HW-000001-FC | FUSE CLIPS         | F1,2     | RE-310005-BC | 100K OHM, 1/4 WATT | R22,23   |
| HW-060100-PS | #6-32 X 10 PEM STU | P        | RE-333005-BC | 330K OHM, 1/4 WATT | R19,20   |
| HW-060405-SP | #6 X 1/4" X 5/32"  | P        | SC-060060-PP | #6-32 X 3/8" P/P Z | Q1,2     |
| MS-000066-HS | TO-66 HEATSINK AAV | Q1,2     | SC-061041-SP | #6-32X1/4" "A" P/P | CUT-IN & |
| MS-150250-FU | 15A, 250V, FUSE    | F1,2     |              |                    | PTC      |
| NW-060010-SL | #6 SPLIT TOOTH LOC | Q1,2     | SC-062050-PP | #6 X 5/16" "B" P/P | Q3-Q18   |
| NW-060500-KP | #6-32 KEPS NUT     | P        | SW-000055-TS | 55C THERMAL CUT-IN | CUT-IN   |
| PC-170054-CX | 1700 LOWER MAIN PC |          | WC-0.6022-JW | .6" JUMPER, WHITE, | J4       |
| PL-903125-SP | BIVAR 903-125 SPAC | D5,6,R54 | WC-001102-SQ | INSUL. SLEEVE QSC  | PTC      |
| PL-905100-SP | BIVAR 905-100 SPAC | L1       | WC-001103-SQ | INSUL SLEEVE 1103, | CUT-IN   |
| PL-905156-SP | SPACER, BIVAR 905- | LD3      | WC-1.2518-JW | 1.25" JUMPER, WHIT | J2,3     |
| PL-905200-SP | BIVAR 905-200 SPAC | LD1,2    | WC-2.5018-JW | 2.5" JUMPER, WHT,  | J1       |
| PL-909235-SP | BIVAR 909-235 SPAC | LD1,2    | XF-200014-CR | 2UH, 14 GA, COIL/V | L1       |
| PT-110000-AT | 100 OHM TRIMPOT    | TR1,2    |              |                    |          |
| QD-000004-TX | MPS-U05 TRANSISTOR | Q21      |              |                    |          |
| QD-000005-QD | TO-220 NPN 250V    | Q1       |              |                    |          |
| QD-000006-QD | TO-220 PNP 250V    | Q2       |              |                    |          |
| QD-000032-QD | MOTOROLA MJ15022 N | Q11-Q18  |              |                    |          |
| QD-000033-QD | MOTOROLA, MJ15023  | Q3-Q10   |              |                    |          |
| QD-000134-LR | RED T-1 3/4 LED, X | LD2      |              |                    |          |
| QD-000134-LX | RED/GREEN T-1 3/4, | LD1      |              |                    |          |
| QD-0003.9-ZT | 3.9V TESTED ZENER  | Z4       |              |                    |          |
| QD-0004.7-ZT | 4.7V TESTED ZENER  | Z1       |              |                    |          |
| QD-0007.5-ZT | 7.5V TESTED ZENER  | Z5       |              |                    |          |
| QD-001340-LR | RED T-1 3/4 LED, U | LD3      |              |                    |          |
| QD-004004-DX | 1N4004 DIODE       | D1,2,7   |              |                    |          |
|              |                    | D8,9,10  |              |                    |          |
| QD-004744-ZA | 1N4744A 15 VOLT ZE | Z2,3     |              |                    |          |
| QD-004753-ZT | 1N4753, 36 VOLT ZE | Z6       |              |                    |          |
| QD-004934-DX | 1N4934 DIODE       | D5,6     |              |                    |          |
| QD-005402-DX | 1N5402 DIODE       | D3,4     |              |                    |          |
| QD-008599-TX | MPS 8599 TRANSISTO | Q19,20   |              |                    |          |
| QD-1.5200-BX | 1.5A 200 VOLT BRID | B1,2     |              |                    |          |
| RE-.04705-FW | .47 OHM, 3 WATT, W | R33-R48  |              |                    |          |
| RE-.56005-EM | 5.6 OHM, 2 WATT ME | R26      |              |                    |          |
| RE-.68005-DM | 6.8 OHM, 1 WATT, M | R12,13   |              |                    |          |
| RE-000009-PT | 90 C PTC RESISTOR  | PTC      |              |                    |          |
| RE-000050-NR | SC-50 NTC RESISTOR | R54      |              |                    |          |
| RE-000140-NR | SG-140 NTC RESISTO | 2        |              |                    |          |
| RE-001005-EM | 10 OHM, 2 WATT, ME | R27,28   |              |                    |          |
| RE-002205-DM | 22 OHM, 1 WATT, ME | R16,17   |              |                    |          |
| RE-015005-BC | 150 OHM, 1/4 WATT, | R25      |              |                    |          |
| RE-033201-BM | 332 OHM, 1/4 WATT, | R7       |              |                    |          |
| RE-045010-HW | 450 OHM, 5 WATT, W | R31,49   |              |                    |          |
| RE-110005-BC | 1K OHM, 1/4 WATT,  | R5,14,15 |              |                    |          |

## USA 1300 Chassis Assembly

| Part Number  | Description                    | Reference |
|--------------|--------------------------------|-----------|
| CH-140210-BX | 1400 KNOB FABRICATION          |           |
| CH-170100-00 | FACEPLATE PANEL SA650          |           |
| CH-170101-00 | CHASSIS FABRICATION SA650      |           |
| CH-170205-AX | 1700 FAN SHROUD                |           |
| CO-000001-DB | DUAL BINDING POST              |           |
| LB-000010-00 | LABEL, SERIAL NO. SLC GENERIC  |           |
| LB-001403-00 | LABEL, LOGO FACEPLATE USA      |           |
| LB-001702-00 | LBL, FACEPLATE LOWER USA 1300  |           |
| LB-001703-00 | LBL, FACEPLATE UPPER USA 1300  |           |
| LB-100000-CT | CHASSIS CONTROL TAG            |           |
| LB-100007-PC | PRODUCTION CONTROL LABEL LARGE |           |
| LB-140101-00 | LABEL INPUT SLC                |           |
| LB-140102-00 | LABEL OUTPUT SLC               |           |
| NW-060400-HN | #6-32 X 1/4" HEX NUT           |           |
| NW-380801-IL | 3/8" INTERNAL TOOTH LOCKWASHER |           |
| NW-380803-HN | 3/8" DRESS NUT                 |           |
| NW-381023-F  | 3/8" DRESS WASHER              |           |
| PL-000003-CP | AC CORD PROTECTOR              |           |
| PL-000008-SR | HEYCO SR-7P-2 STR. RELIEF 14/3 |           |
| PL-000011-TW | TIE WRAP, LONG                 |           |
| PL-000012-SB | BUSHING, 0.625" OD, 0.50" ID   |           |
| PL-003.65-TW | TIE WRAP, SMALL                |           |
| SC-060041-PP | 6-32 X 1/4" TYPE I PH PAN, BLK |           |
| SC-060081-PP | #6-32 X 1/2" P/P BLACK         |           |
| SC-061041-SP | #6-32X1/4" "A" P/P W/SCRAPING  |           |
| SC-063061-PP | #6-32 X 3/8" "F" P/P BLACK     |           |
| SC-081101-SP | #8-18,AB,5/8,TYPE 1 (PHIL) PH  |           |
| SC-100061-PS | #10-32 X 3/8" P/P SEMS BLACK   |           |



## USA Amplifier Series

### USA 1300 Chassis Assembly (cont.)

|              |                                |
|--------------|--------------------------------|
| SW-000008-CB | 8A CIRCUIT BREAKER-THERMAL     |
| SW-000015-CB | 15A. CIRCUIT BREAKER           |
| SW-000016-SW | SPST SNAP IN POWER SWITCH      |
| WC-001038-BX | 1038 AC CORD, 88", BLACK       |
| WC-001043-TQ | WIRE 1043, 8", RED             |
| WC-001044-TQ | WIRE 1044, 8", WHITE           |
| WC-001045-TQ | WIRE 1045, 8", BLACK           |
| WC-001048-TQ | WIRE 1048, 4", BLACK           |
| WP-170001-CP | SOB-1700 FAN ASSEMBLY          |
| WP-170002-CP | OBS-1700 INPUT JUMP.(R/Y) ASSY |
| WP-170003-CP | OBS-1700 INPUT JUMP. (W/B)ASSY |
| WP-170004-CP | OBS-1700 XFMR ASSY             |

### USA 850 Main Board Assembly

| Part Number  | Description                    | Reference               |
|--------------|--------------------------------|-------------------------|
| CA-068100-BD | 68PF,100V,10%,DISK             | C2A,B                   |
| CA-110100-BM | 100PF,100V,5%,MICA             | C1ab,6ab                |
| CA-222100-BP | .0022UF,100V,10%,MYLAR         | C11ab                   |
| CA-222200-BP | .0022UF,200V,10%,MYLAR         | C4ab,12ab               |
| CA-233100-BP | .0033UF,100V,10%,MYLAR         | C8ab,9ab                |
| CA-310100-BP | .01UF,100V,10%,MYLAR           | C7ab                    |
| CA-368100-BP | .068UF,100V,10%,MYLAR          | C3ab,5ab                |
| CA-368250-AS | .068UF,250V,SURGE CAP.         | C10                     |
| CA-547016-BN | 4.7UF, 16V, RADIAL, NON-POLAR  | E1ab                    |
| CA-547160-BE | 4.7UF, 160V, ELEC, RADIAL, 10% | E8                      |
| CA-647050-BE | 47UF, 50V, ELEC., RADIAL, 10%  | E9                      |
| CA-710035-BE | 100UF, 35V, ELEC., RADIAL, 10% | E2ab,3ab                |
| CA-822100-BE | 220OUF, 100V, ELEC, RADIAL,10% | E4ab,5ab,<br>E6ab,7ab   |
| CH-140208-LX | 1200/1400/1700 HEATSINK, FAB.  |                         |
| CO-000008-IC | 8 PIN IC SOCKET                | IC1ab                   |
| CO-350432-AP | .084" PIN 9 CONTACT PCB HEADER | P1                      |
| HW-000001-FC | FUSE CLIPS                     | F1ab                    |
| HW-060100-PS | #6-32 X 10 PEM STUD            |                         |
| HW-060405-SP | #6 X 1/4" X 5/32" RND. SPACER  |                         |
| HW-060600-SO | 1/4"X1/4" MALE/FEMALE 6-32     |                         |
| IC-005532-OP | 5532 OP-AMP                    | IC1ab                   |
| LB-100002-EG | EXPORT GROUND LABEL            |                         |
| LB-100007-PC | PRODUCTION CONTROL LABEL LARGE |                         |
| MS-000048-HS | HEAT SINK, ISOL TO-220         | REF:Q1A,B,<br>REF:Q2A,B |
| MS-120250-FU | 12A 250V, FUSE                 | F1ab                    |
| NW-060500-KP | #6-32 KEPS NUT                 |                         |
| PC-140044-LX | PCB, MAIN BOARD, 1200/1400     |                         |
| PL-000000-AF | ADHESIVE FEET                  |                         |
| PL-903125-SP | BIVAR 903-125 SPACER           | D1ab,2ab,<br>L1ab,R38ab |
| PL-905156-SP | SPACER, BIVAR 905-156          | REF: LD3                |
| PL-905325-SP | BIVAR 905-325 SPACER           | LD1ab,2                 |
| PL-909235-SP | BIVAR 909-235 SPACER           | LD1ab,2                 |
| PT-110000-AT | 100 OHM TRIMPOT                | TR3ab                   |
| PT-250000-AT | 5K OHM TRIMPOT                 | TR4ab,5ab               |
| PT-422000-AT | 220K OHM, 1/2 WATT, TRIMPOT    | TR2ab                   |

|              |                                |  |
|--------------|--------------------------------|--|
| QD-000004-TX | MPS-U05 TRANSISTOR, NPN        | Q12  |
| QD-000018-QD | 2SC3298B DRIVER TRANSISTOR     | Q1A,B  |
| QD-000019-QD | 2SA1306B DRIVER TRANSISTOR     | Q2A,B  |
| QD-000032-QD | MOTOROLA MJ15022 NPN PWR XSTR  | Q7AB-10AB  |
| QD-000033-QD | MOTOROLA, MJ15023 PNP PWR XST  | Q3AB-6AB   |
| QD-000134-LG | GREEN T-1 3/4 LED, HLMP 3519   | LD2  |
| QD-000134-LR | RED T-1 3/4 LED, XC 4655       | LD1ab  |
| QD-0003.9-ZT | 3.9V TESTED ZENER              | Z3ab   |
| QD-0004.7-ZT | 4.7V TESTED ZENER              | Z4ab   |
| QD-001340-LR | RED T-1 3/4 LED, UTILITY       | LD3  |
| QD-004004-DX | 1N4004 DIODE                   | D11ab<br>D4ab-7ab<br>D8,10ab,<br>Z1ab,2ab,<br>Z5 |
| QD-004744-ZA | 1N4744A 15 VOLT ZENER DIODE    | Z1ab,2ab,<br>Z5                                  |
| QD-004934-DX | 1N4934 DIODE                   | D1ab,2ab   |
| QD-008599-TX | MPS 8599 TRANSISTOR, PNP       | Q11  |
| QD-1.5200-BX | 1.5A 200 VOLT BRIDGE RECTIFIER | B2ab   |
| QD-400400-BX | 40 AMP,400 VOLT, BR. RECTIFIER | B1ab   |
| RE-.02205-FW | .22 OHM, 3WATT, WIREWOUND, 10% | R23ab-30ab                                       |
| RE-.56005-EM | 5.6 OHM, 2 WATT METAL OXIDE 5% | R31ab  |
| RE-.68005-DM | 6.8 OHM, 1 WATT, MET. OXIDE 5% | R15ab,16ab                                       |
| RE-000009-PT | 90 C PTC RESISTOR              | PTC  |
| RE-000050-NR | SC-50 NTC RESISTOR             | R38ab  |
| RE-000140-NR | SG-140 NTC RESISTOR 1400/1500  | R37  |
| RE-001005-EM | 10 OHM, 2 WATT, METAL OXIDE 5% | R32ab  |
| RE-002205-DM | 22 OHM, 1 WATT, METAL OXIDE 5% | R17ab,18ab                                       |
| RE-015001-BM | 150 OHM, 1/4 WATT, MET.FLM 1%  | R14ab,36ab                                       |
| RE-016501-BM | 165 OHM, 1/4 WATT, MET.FLM 1%  | R5ab   |
| RE-025010-NW | 250 OHM, 15 WATT, WIREWND, 10% | R42  |
| RE-045010-HW | 450 OHM, 5 WATT, WIREWOUND 10% | R22ab  |
| RE-075001-BM | 750 OHM,1/4 WATT, MET.FILM, 1% | R10ab  |
| RE-110005-BC | 1K OHM, 1/4 WATT, CARBON, 5%   | R12ab,13ab                                       |
| RE-130005-EM | 3K OHM, 2 WATT, MET. OXIDE 5%  | R20ab,21ab                                       |
| RE-147005-BC | 4.7K OHM, 1/4 WATT, CARBON, 5% | R11ab  |
| RE-162005-CC | 6.2K OHM, 1/2 WATT, CARBON 5%  | R19  |
| RE-168005-BC | 6.8K OHM, 1/4 WATT, CARBON 5%  | R34,41   |
| RE-210001-BM | 10.0K OHM, 1/4W., MET. FLM. 1% | R1ab-4ab   |
| RE-210002-CM | 10K OHM, 1/2 WATT, MET.FLM 2%  | R6ab   |
| RE-210005-EM | 10K OHM, 2 WATT, MET. OXIDE 5% | R39  |
| RE-247005-CC | 47K OHM, 1/2 WATT, CARBON, 5%  | R9ab   |
| RE-247005-DM | 47K OHM, 1W, 5% METAL OXIDE    | R35<br>R7AB,8AB,<br>R40<br>R33                   |
| RE-310005-BC | 100K OHM, 1/4 WATT. CARBON 5%  | R40  |
| RE-318005-BC | 180K OHM, 1/4 WATT, CARBON 5%  | R33  |
| SC-061041-SP | #6-32X1/4" "A" P/P W/SCRAPING  | PTC,55C  |
| SC-062050-PP | #6 X 5/16" "B" P/P ZINC        |  |
| SW-000005-CB | 5A. CIRCUIT BREAKER            |  |
| SW-000055-TS | 55C THERMAL CUT-IN SWITCH      | 55C  |
| SW-000151-S  | SPDT SLIDE SWITCH SW-GP1-151   | NORM BR  |
| WC-0.6022-JW | .6" JUMPER, WHITE, 22 GA, SLD  | J2,8,9,19  |
| WC-0.9022-JW | .9" JUMPER, WHITE, 22 GA, SLD  | J1,3,4,15,<br>J21,22,28,<br>J29,31               |
| WC-001102-SQ | INSUL. SLEEVE QSC 1102,.6",CLR | PTC  |
| WC-001103-SQ | INSUL SLEEVE 1103,.875",CLEAR  | REF: 55C   |



**USA 850 Main Board Assembly (cont.)**

|              |                                |                                       |
|--------------|--------------------------------|---------------------------------------|
| WC-1.2518-JW | 1.25" JUMPER, WHITE 18 GA, SLD | J23                                   |
| WC-1.5022-JW | 1.5" JUMPER, WHITE, 22 GA, SLD | J11,12,16,<br>J17,18,20<br>J5,6,7,10, |
| WC-2.5018-JW | 2.5" JUMPER, WHT, 18 GA, SLD   | J13,14,24,<br>J25-27                  |
| XF-200016-CR | 2UH,16GA., COIL/VERTICAL       | L1ab                                  |

**USA 850 Chassis Assembly**

| Part Number  | Description                    | Reference |
|--------------|--------------------------------|-----------|
| CH-140100-00 | FACEPLATE PANEL SA185/SA425    |           |
| CH-140101-00 | CHASSIS FAB SA185,SA425        |           |
| CH-140210-BX | 1400 KNOB FABRICATION          |           |
| CO-000001-DB | DUAL BINDING POST              |           |
| LB-000010-00 | LABEL, SERIAL NO. SLC GENERIC  |           |
| LB-001402-00 | LABEL, FACEPLATE USA 850       |           |
| LB-001403-00 | LABEL, LOGO FACEPLATE USA      |           |
| LB-100000-CT | CHASSIS CONTROL TAG            |           |
| LB-100007-PC | PRODUCTION CONTROL LABEL LARGE |           |
| LB-140101-00 | LABEL INPUT SLC                |           |
| LB-140102-00 | LABEL OUTPUT SLC               |           |
| NW-040422-SW | TOSHIBA SHOULDER WASHER        |           |
| NW-060400-HN | #6-32 X 1/4" HEX NUT           |           |
| NW-380801-IL | 3/8" INTERNAL TOOTH LOCKWASHER |           |
| NW-380803-HN | 3/8" DRESS NUT                 |           |
| NW-381023-FW | 3/8" DRESS WASHER              |           |
| PL-000001-SR | HEYCO 6W-1 STRAIN RELIEF 16/3  |           |
| PL-000003-CP | AC CORD PROTECTOR              |           |
| PL-000011-TW | TIE WRAP, LONG                 |           |
| SC-060030-PU | #6-32 X 3/16 P/F UNDERCUT ZINC |           |
| SC-060081-PP | #6-32 X 1/2" P/P BLACK         |           |
| SC-062050-PP | #6 X 5/16" "B" P/P ZINC        |           |
| SC-081101-SP | #8-18,AB,5/8,TYPE 1 (PHIL) PH  |           |
| SC-100061-PS | #10-32 X 3/8" P/P SEMS BLACK   |           |
| SW-000010-CB | 10A. CIRCUIT BREAKER           |           |
| SW-000016-SW | SPST SNAP IN POWER SWITCH      |           |
| WC-001001-AX | OBS-QSC WIRE 1001,8.5",BLACK   |           |
| WC-001002-AX | OBS-QSC WIRE 1002, 7.5",YELLOW |           |
| WC-001003-AX | OBS-QSC WIRE 1003,7.5", ORANGE |           |
| WC-001004-CX | QSC AC CORD 1004, 72", BLACK   |           |
| WC-001005-AX | QSC WIRE 1005, 2.5", BLACK     |           |
| WC-001007-AX | QSC WIRE 1007, 2", BLACK       |           |
| WC-001015-AX | OBS-QSC WIRE 1015,4.50",BLACK  |           |
| WP-140001-CP | SOB-1400 XFMR ASSY (120V)      |           |
| WP-140002-CP | SOB-1400 PREPPED FAN ASSY      |           |

**USA 370 Main Board Assembly**

| Part Number  | Description            | Reference |
|--------------|------------------------|-----------|
| CA-047100-BD | 47PF,100V,10%,DISK     | C2AB      |
| CA-110100-BM | 100PF,100V,5%,MICA     | C1ab,6ab  |
| CA-222100-BP | .0022UF,100V,10%,MYLAR | C11ab     |
| CA-222200-BP | .0022UF,200V,10%,MYLAR | C12ab     |

|              |                                |                                      |
|--------------|--------------------------------|--------------------------------------|
| CA-233100-BP | .0033UF,100V,10%,MYLAR         | C4ab,8ab,<br>C9ab                    |
| CA-310100-BP | .01UF,100V,10%,MYLAR           | C7ab                                 |
| CA-368100-BP | .068UF,100V,10%,MYLAR          | C3ab,5ab                             |
| CA-368250-AS | .068UF,250V,SURGE CAP.         | C10                                  |
| CA-547016-BN | 4.7UF, 16V, RADIAL, NON-POLAR  | E1ab                                 |
| CA-547160-BE | 4.7UF, 160V, ELEC, RADIAL, 10% | E8                                   |
| CA-647050-BE | 47UF, 50V, ELEC., RADIAL, 10%  | E9                                   |
| CA-710035-BE | 100UF, 35V, ELEC., RADIAL, 10% | E2ab,3ab                             |
| CA-833080-BE | 330OUF, 80V, ELEC., RADIAL,10% | E4b,5a,7ab                           |
| CH-140208-LX | 1200/1400/1700 HEATSINK, FAB.  |                                      |
| CO-000008-IC | 8 PIN IC SOCKET                | IC1ab                                |
| CO-350432-AP | .084" PIN 9 CONTACT PCB HEADER | P1                                   |
| HW-000001-FC | FUSE CLIPS                     | F1ab                                 |
| HW-060100-PS | #6-32 X 10 PEM STUD            |                                      |
| HW-060405-SP | #6 X 1/4" X 5/32" RND. SPACER  |                                      |
| HW-060600-SO | 1/4"X1/4" MALE/FEMALE 6-32     |                                      |
| IC-005532-OP | 5532 OP-AMP                    | IC1ab                                |
| LB-100007-PC | PRODUCTION CONTROL LABEL LARGE |                                      |
| MS-000048-HS | HEAT SINK, ISOL TO-220         | REF:Q1A,B,<br>REF:Q2A,B              |
| MS-070125-FU | 7A, 250V, FUSE                 | F1ab                                 |
| NW-060500-KP | #6-32 KEPS NUT                 |                                      |
| PC-140044-LX | PCB, MAIN BOARD, 1200/1400     |                                      |
| PL-000000-AF | ADHESIVE FEET                  |                                      |
| PL-903125-SP | BIVAR 903-125 SPACER           | D1A,B,<br>D2A,B,<br>L1A,B,<br>R38A,B |
| PL-905156-SP | SPACER, BIVAR 905-156          | REF: LD3                             |
| PL-905325-SP | BIVAR 905-325 SPACER           | LD1ab,2                              |
| PL-909235-SP | BIVAR 909-235 SPACER           | LD1ab,2                              |
| PT-110000-AT | 100 OHM TRIMPOT                | TR3ab                                |
| PT-250000-AT | 5K OHM TRIMPOT                 | TR4ab,5ab                            |
| PT-422000-AT | 220K OHM, 1/2 WATT, TRIMPOT    | TR2ab                                |
| QD-000004-TX | MPS-U05 TRANSISTOR, NPN        | Q12                                  |
| QD-000018-QD | 2SC3298B DRIVER TRANSISTOR     | Q1A,B                                |
| QD-000019-QD | 2SA1306B DRIVER TRANSISTOR     | Q2A,B                                |
| QD-000032-QD | MOTOROLA MJ15022 NPN PWR XSTR  | Q10B<br>Q7A,8B,9A,                   |
| QD-000033-QD | MOTOROLA, MJ15023 PNP PWR XST  | Q3A,4B,5A,<br>Q6B                    |
| QD-000134-LG | GREEN T-1 3/4 LED, HLMP 3519   | LD2                                  |
| QD-000134-LR | RED T-1 3/4 LED, XC 4655       | LD1ab                                |
| QD-0003.9-ZT | 3.9V TESTED ZENER              | Z3ab                                 |
| QD-0004.7-ZT | 4.7V TESTED ZENER              | Z4ab                                 |
| QD-001340-LR | RED T-1 3/4 LED, UTILITY       | LD3                                  |
| QD-004004-DX | 1N4004 DIODE                   | D10ab,11ab<br>D4ab-7ab,8             |
| QD-004744-ZA | 1N4744A 15 VOLT ZENER DIODE    | Z1ab,2ab,5                           |
| QD-004934-DX | 1N4934 DIODE                   | D1ab,2ab                             |
| QD-008599-TX | MPS 8599 TRANSISTOR, PNP       | Q11                                  |
| QD-1.5200-BX | 1.5A 200 VOLT BRIDGE RECTIFIER | B2ab                                 |
| QD-400400-BX | 40 AMP,400 VOLT, BR. RECTIFIER | B1ab                                 |
| RE-.02205-FW | .22 OHM, 3WATT, WIREWOUND, 10% | R23a,24b,                            |



# USA Amplifier Series

## USA 370 Main Board Assembly (cont.)

|              |                                |            |
|--------------|--------------------------------|------------|
| RE-.56005-EM | 5.6 OHM, 2 WATT METAL OXIDE 5% | R25a,26b,  |
| RE-.68005-DM | 6.8 OHM, 1 WATT, MET. OXIDE 5% | R27a,28b,  |
| RE-000009-PT | 90 C PTC RESISTOR              | R29a,30b   |
| RE-000050-NR | SC-50 NTC RESISTOR             | R31ab      |
| RE-001005-EM | 10 OHM, 2 WATT, METAL OXIDE 5% | R15ab,16ab |
| RE-002205-DM | 22 OHM, 1 WATT, METAL OXIDE 5% | PTC        |
| RE-015001-BM | 150 OHM, 1/4 WATT, MET.FLM 1%  | R38ab      |
| RE-023701-BM | 237 OHM, 1/4 WATT, MET. FLM 1% | R32ab      |
| RE-030005-HV | 300 OHM, 5 WATT, WIREWOUND 10% | R17ab,18ab |
| RE-075001-BM | 750 OHM,1/4 WATT, MET.FILM, 1% | R14ab,36ab |
| RE-110005-BC | 1K OHM, 1/4 WATT, CARBON, 5%   | R5ab       |
| RE-120005-EM | 2K OHM, 2 WATT, MET.OXIDE 5%   | R22ab      |
| RE-147005-BC | 4.7K OHM, 1/4 WATT, CARBON, 5% | R10ab      |
| RE-162005-CC | 6.2K OHM, 1/2 WATT, CARBON 5%  | R12ab,13ab |
| RE-168005-BC | 6.8K OHM, 1/4 WATT, CARBON 5%  | R20ab,21ab |
| RE-210001-BM | 10.0K OHM, 1/4W., MET. FLM. 1% | R11ab      |
| RE-210002-CM | 10K OHM, 1/2 WATT, MET.FLM 2%  | R19        |
| RE-210005-EM | 10K OHM, 2 WATT, MET. OXIDE 5% | R34,41     |
| RE-247005-CC | 47K OHM, 1/2 WATT, CARBON, 5%  | R1ab,2ab,  |
| RE-247005-DM | 47K OHM, 1W, 5% METAL OXIDE    | R3ab,4ab   |
| RE-310005-BC | 100K OHM, 1/4 WATT. CARBON 5%  | R6ab       |
| RE-315005-BC | 150K OHM, 1/4 WATT, CARBON 5%  | R39        |
| SC-061041-SP | #6-32X1/4" "A" P/P W/SCRAPING  | R9ab       |
| SC-062050-PP | #6 X 5/16" "B" P/P ZINC        | R40        |
| SW-000151-SW | SPDT SLIDE SWITCH SW-GP1-151   | R33        |
| WC-0.3022-JW | .3" JUMPER, WHITE, 22 GA SLD   | PTC        |
| WC-0.6022-JW | .6" JUMPER, WHITE, 22 GA, SLD  | NORM BRDGE |
| WC-0.9022-JW | .9" JUMPER, WHITE, 22 GA, SLD  | R37        |
| WC-001102-SQ | INSUL. SLEEVE QSC 1102,.6",CLR | J2,8,9,19  |
| WC-1.2518-JW | 1.25" JUMPER, WHITE 18 GA, SLD | J1,3,4,15, |
| WC-1.5022-JW | 1.5" JUMPER, WHITE, 22 GA, SLD | J21,22,28, |
| WC-2.5018-JW | 2.5" JUMPER, WHT, 18 GA, SLD   | J29,31     |
| XF-200016-CR | 2UH,16GA., COIL/VERTICAL       | PTC        |
|              |                                | J23        |
|              |                                | J11,12,16, |
|              |                                | J17,18,20  |
|              |                                | J5,6,7,10, |
|              |                                | J13,14,    |
|              |                                | J23-27     |
|              |                                | L1ab       |

## USA 370 Chassis Assembly

| Part Number  | Description                   | Reference |
|--------------|-------------------------------|-----------|
| CH-140100-00 | FACEPLATE PANEL SA185/SA425   |           |
| CH-140101-00 | CHASSIS FAB SA185,SA425       |           |
| CH-140210-BX | 1400 KNOB FABRICATION         |           |
| CO-000001-DB | DUAL BINDING POST             |           |
| LB-000010-00 | LABEL, SERIAL NO. SLC GENERIC |           |
| LB-001202-00 | LABEL, FACEPLATE USA 370      |           |

|              |                                |
|--------------|--------------------------------|
| LB-100000-CT | CHASSIS CONTROL TAG            |
| LB-100007-PC | PRODUCTION CONTROL LABEL LARGE |
| LB-140101-00 | LABEL INPUT SLC                |
| LB-140102-00 | LABEL OUTPUT SLC               |
| NW-040422-S  | TOSHIBA SHOULDER WASHER        |
| NW-060400-HN | #6-32 X 1/4" HEX NUT           |
| NW-100600-KP | #10-32 KEPS NUT                |
| NW-380801-IL | 3/8" INTERNAL TOOTH LOCKWASHER |
| NW-380803-HN | 3/8" DRESS NUT                 |
| NW-381023-F  | 3/8" DRESS WASHER              |
| PL-000001-SR | HEYCO 6W-1 STRAIN RELIEF 16/3  |
| PL-000003-CP | AC CORD PROTECTOR              |
| PL-000011-TW | TIE WRAP, LONG                 |
| PL-003.65-TW | TIE WRAP, SMALL                |
| SC-060030-PU | #6-32 X 3/16 P/F UNDERCUT ZINC |
| SC-060081-PP | #6-32 X 1/2" P/P BLACK         |
| SC-062050-PP | #6 X 5/16" "B" P/P ZINC        |
| SC-081101-SP | #8-18,AB,5/8,TYPE 1 (PHIL) PH  |
| SC-100121-PS | #10-32 X 3/4" P/P SEMS BLACK   |
| SW-000003-CB | 3A CIRCUIT BREAKER-THERMAL     |
| SW-000005-CB | 5A. CIRCUIT BREAKER            |
| SW-000016-S  | SPST SNAP IN POWER SWITCH      |
| WC-001001-AX | OBS-QSC WIRE 1001,8.5",BLACK   |
| WC-001002-AX | OBS-QSC WIRE 1002, 7.5",YELLOW |
| WC-001003-AX | OBS-QSC WIRE 1003,7.5", ORANGE |
| WC-001005-AX | QSC WIRE 1005, 2.5", BLACK     |
| WC-001007-AX | QSC WIRE 1007, 2", BLACK       |
| WC-001015-AX | OBS-QSC WIRE 1015,4.50",BLACK  |
| WC-003050-AX | PWR CORD 100/120VAC            |
| WP-120001-CP | SOB-1200 XFMR ASSY (120V)      |

## USA Series Input Jack Panel

| Part Number  | Description                    | Reference |
|--------------|--------------------------------|-----------|
| CO-000005-BS | 5 POSITION BARRIER STRIP       |           |
| CO-300112-PJ | .25" PHONE JACK PC MOUNT       |           |
| CO-640385-AH | 16 PIN .156/C RT ANGLE HEADER  |           |
| HW-060040-PS | #6-32 X 4 PEM STUD             |           |
| HW-060120-SO | STANDOFF,1/4" HEX AL 6-32X3/4" |           |
| PC-140045-FX | USA SERIES JACKPLANE PCB       |           |
| PT-320300-CR | GAIN POT 20K 20% 0.2W          |           |
| RE-147005-BC | RES CF 4.7K 5% 1/4W            |           |
| WC-0.3022-JW | .3" JUMPER, WHITE, 22 GA SLD   |           |



### Semiconductors

**MPS8598**  
**MPS8599**  
PNP

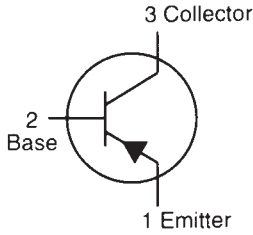

**2N4409**  
**2N4410**  
NPN

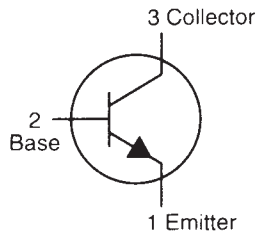

SMALL SIGNAL  
TRANSISTORS

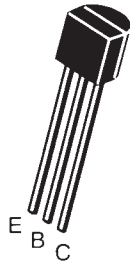

### DRIVER TRANSISTORS

**2SA1306** PNP  
**2SC3298** NPN

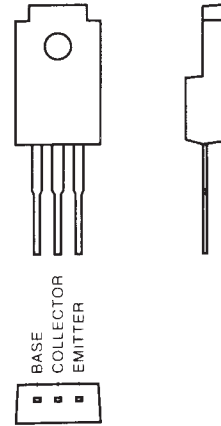

### NE5532AN OP AMP

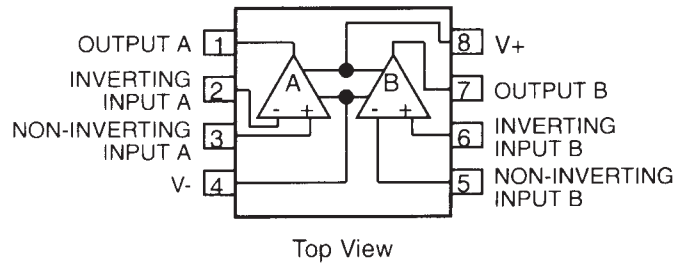

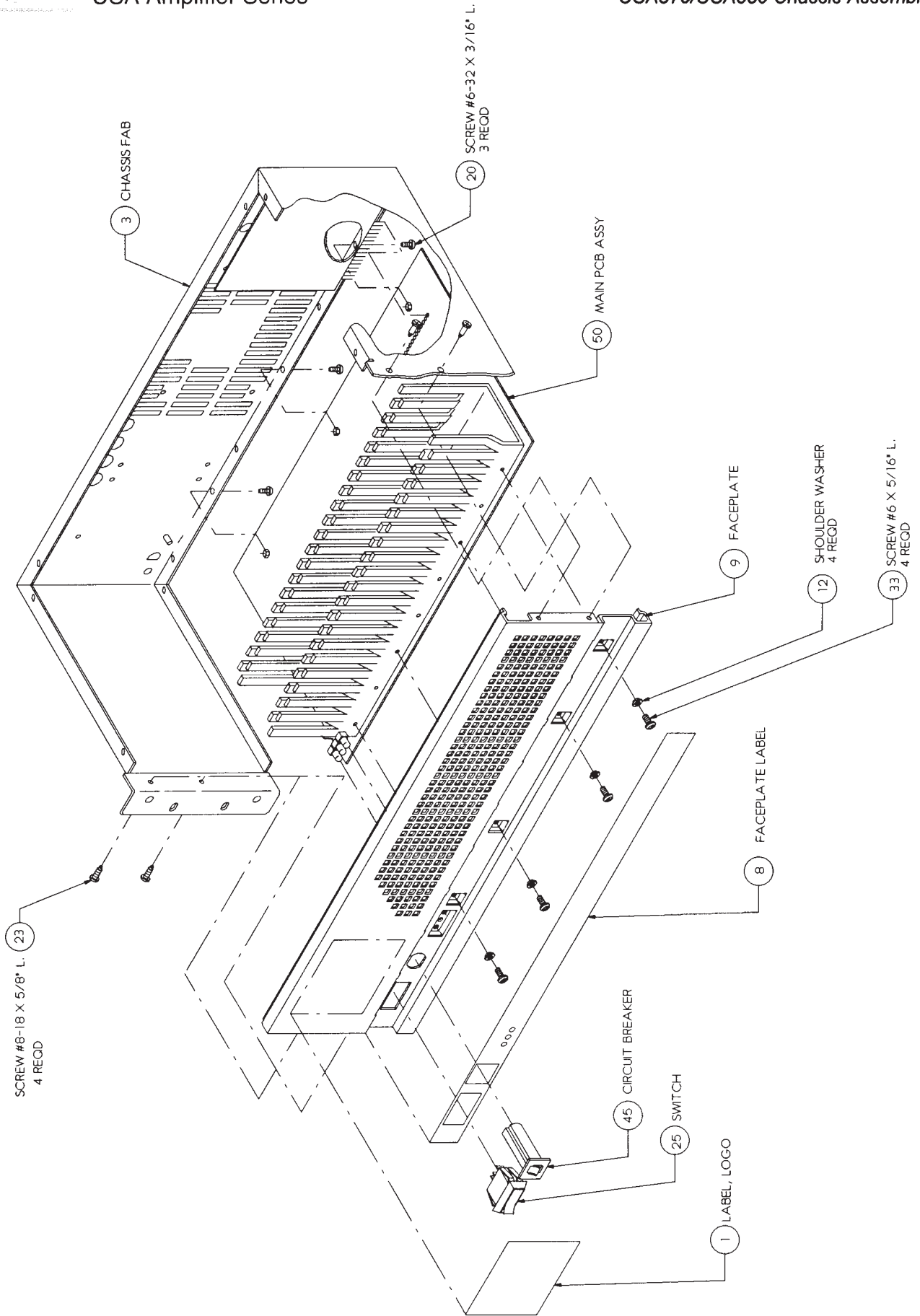

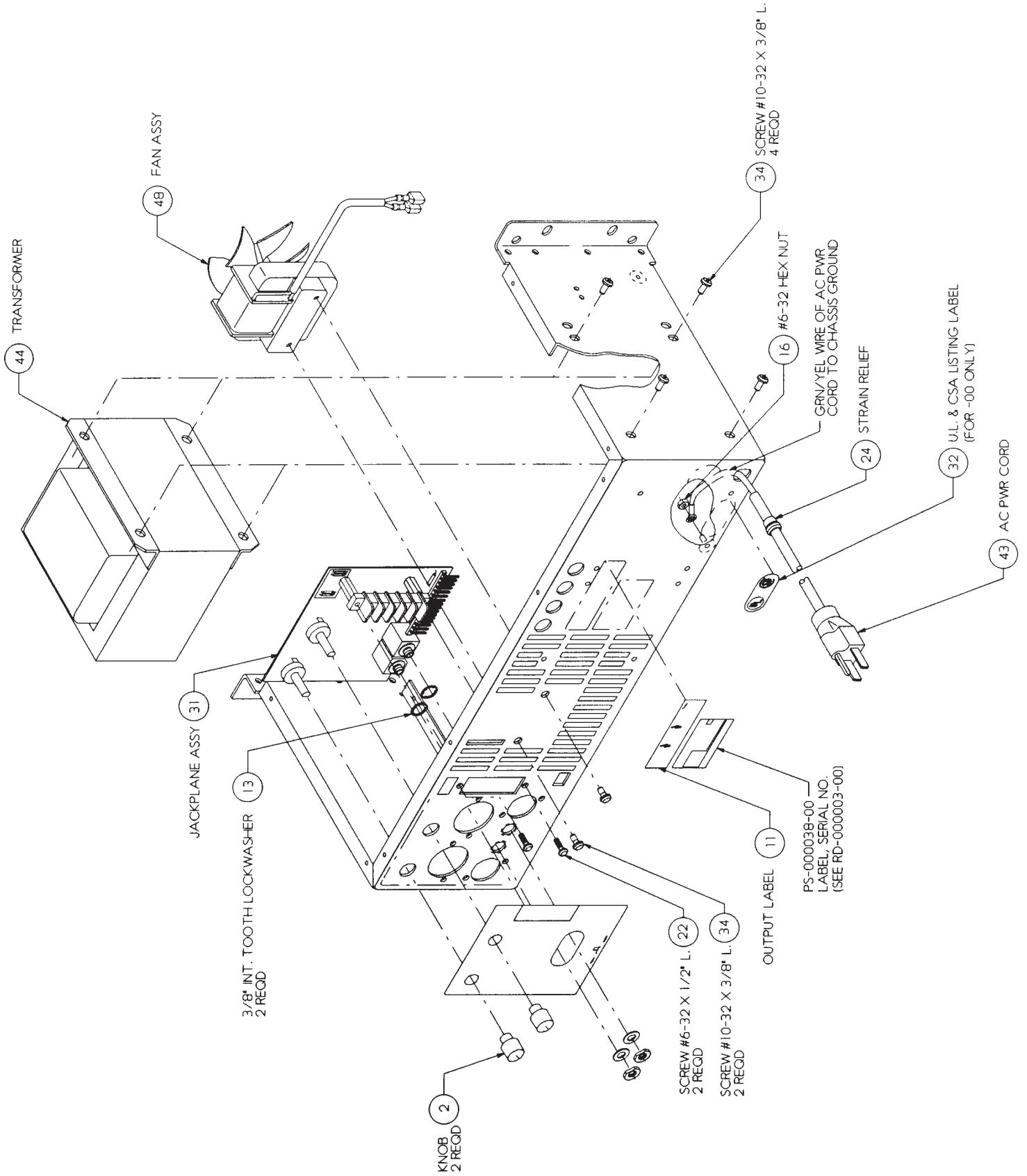

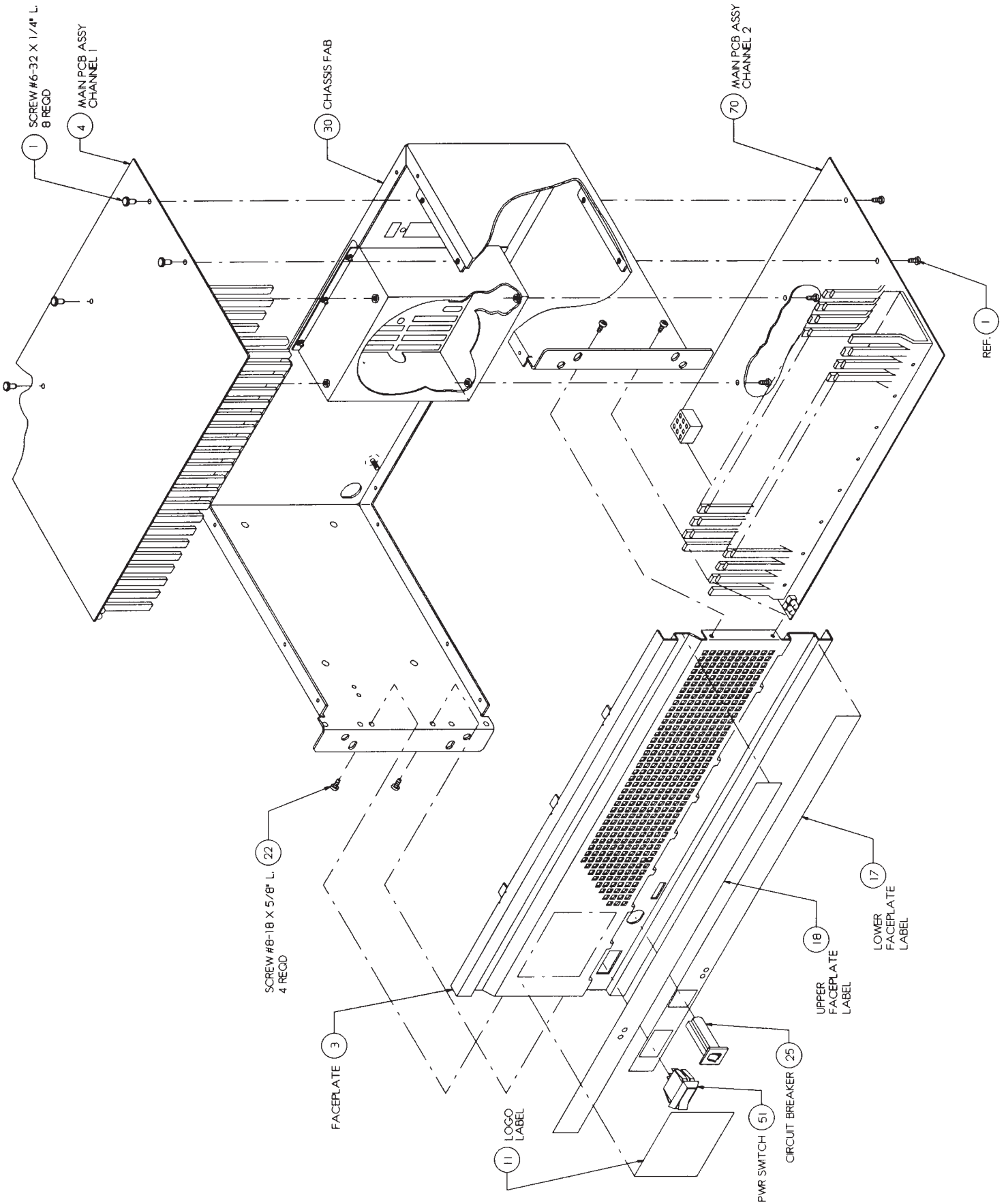

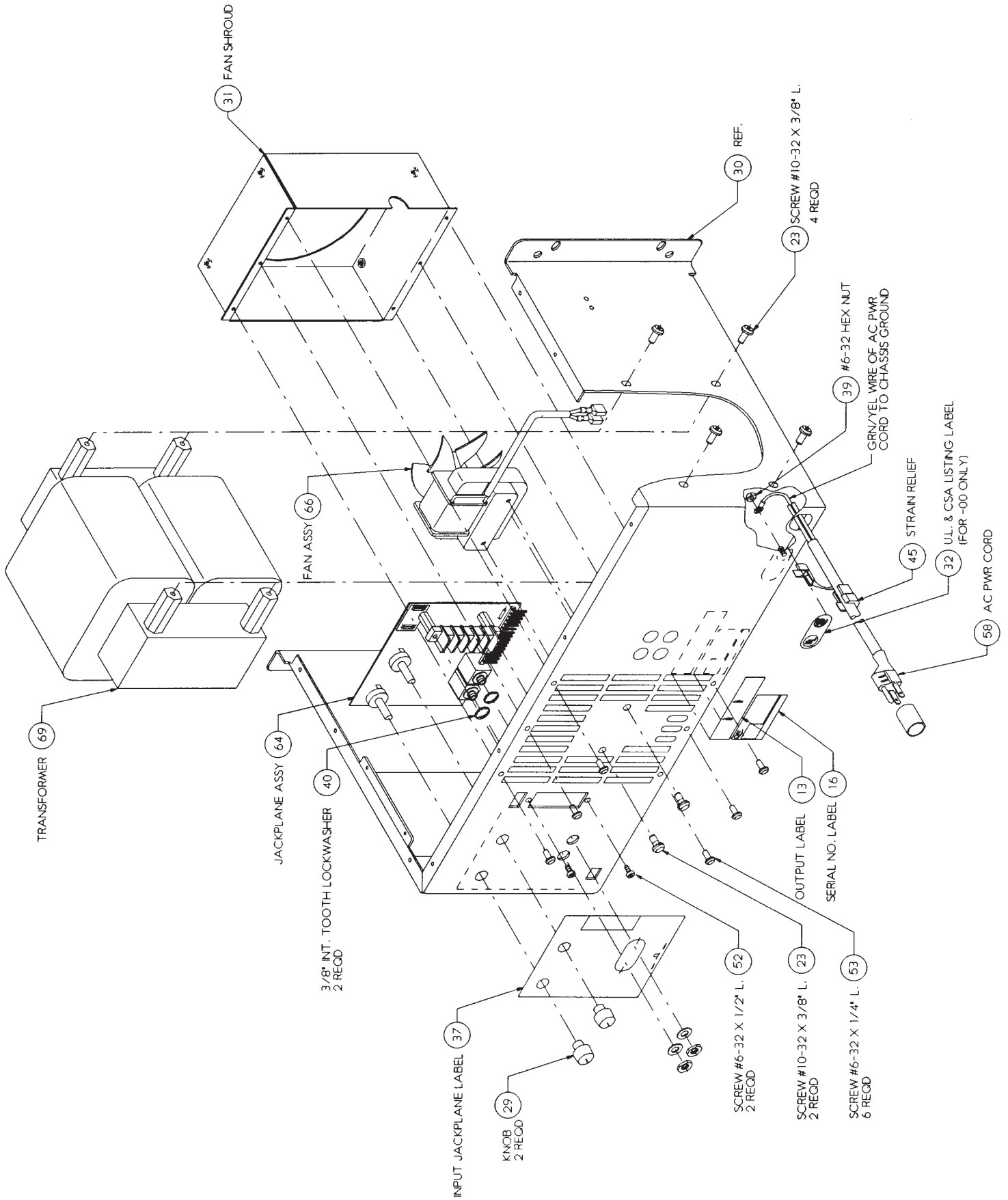





100 VOLT

WP-120044-1D

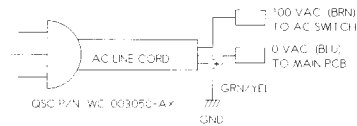
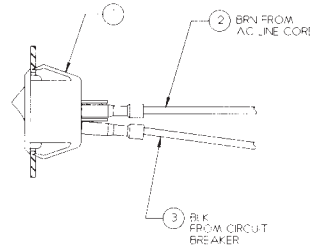
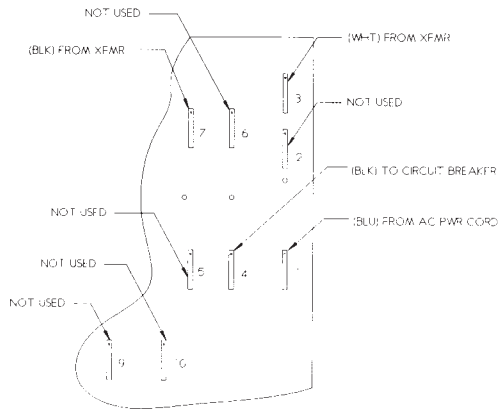

MODEL NO USA 370

100 VOLT WIRING PCB & AC CORD

120 VOLT

WF-20644-1D

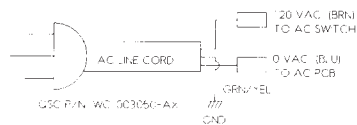
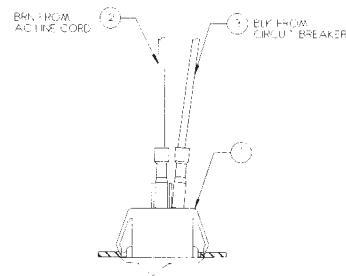
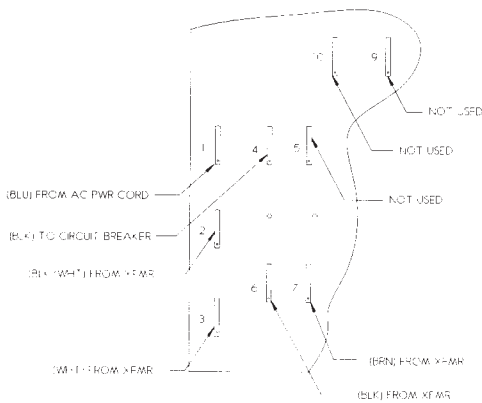

MODEL NO USA 370

120 VOLT WIRING AC PCB & AC CORD

230 VOLT

WF-120044-1E

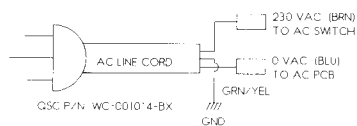
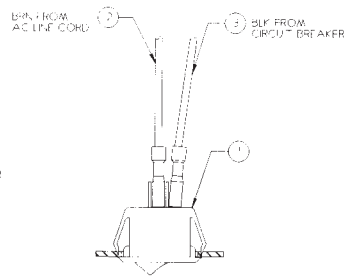
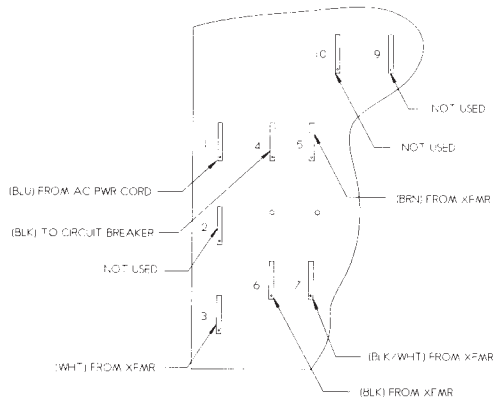

MODEL NO USA 370

230 VOLT WIRING AC PCB & AC CORD





**100 VOLT**

WP-40044-TJ

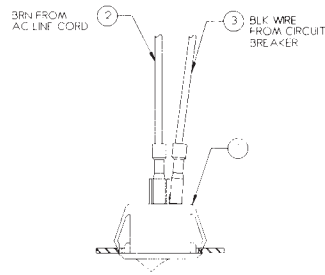
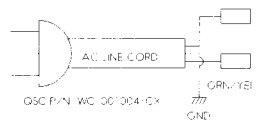
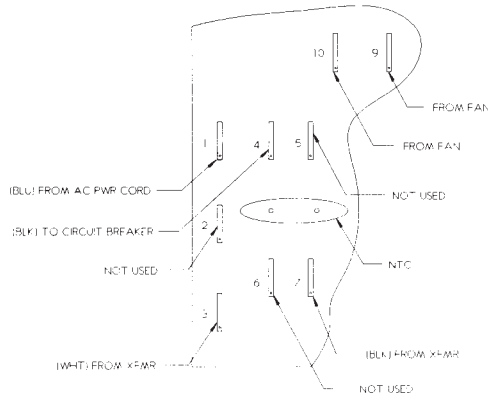

MODEL NO USA 850 100 VOLT WIRING AC PCB & AC CORD

**120 VOLT**

WP-40044-TJ

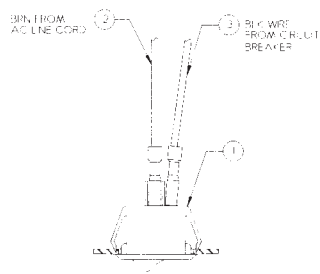
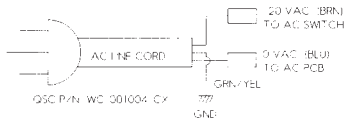
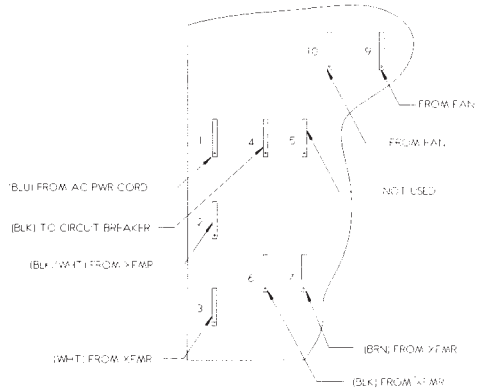

MODEL NO USA 850 120 VOLT WIRING AC PCB & AC CORD

**230 VOLT**

WP-40044-TJ

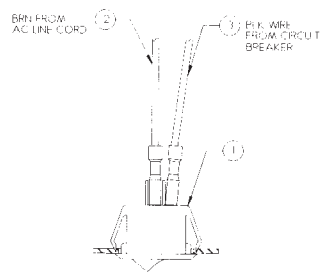
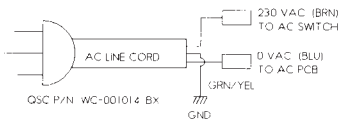
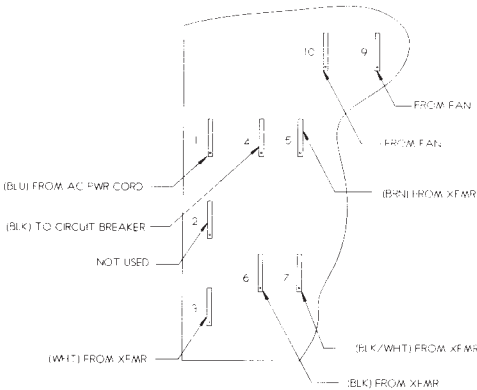

MODEL NO USA 850 230 VOLT WIRING AC PCB & AC CORD



100 VOLT

WP-170054-TJ

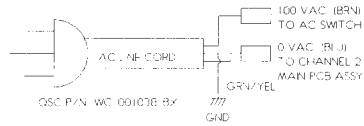
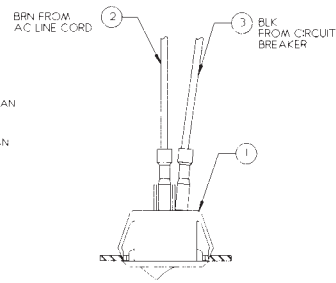
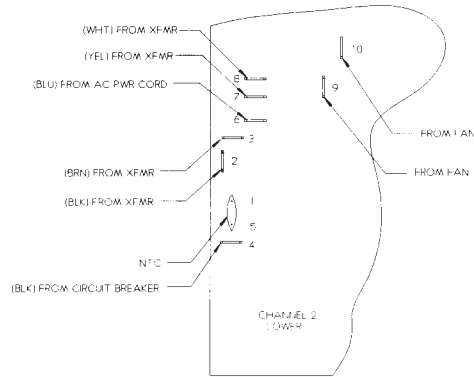

MODEL NO. USA 1300 100 VOLT WIRING PCB & AC CORD

120 VOLT

WP-170054-TD

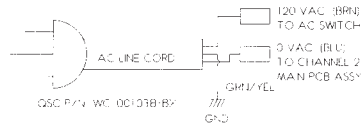
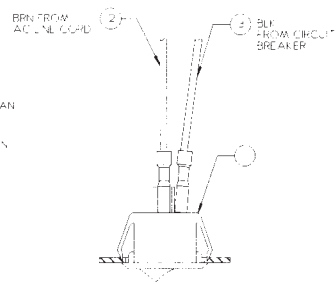
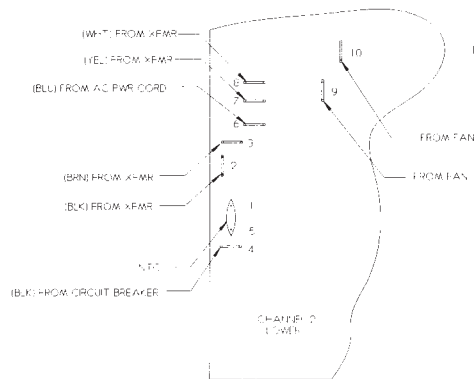

MODEL NO. USA 1300 120 VOLT WIRING PCB & AC CORD

230 VOLT

WP-170054-TL

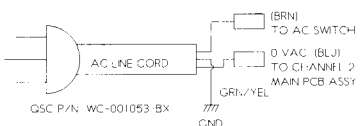
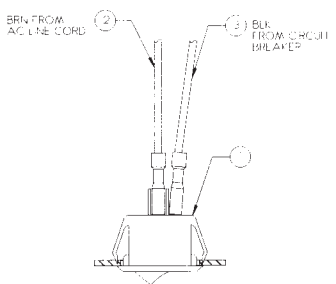
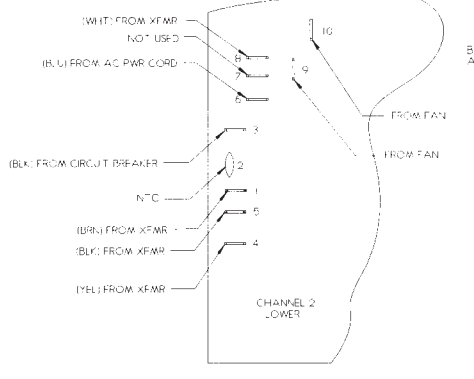

MODEL NO. USA 1300 230 VOLT WIRING PCB & AC CORD

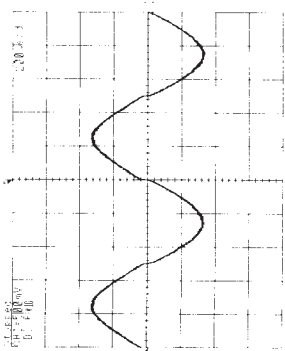
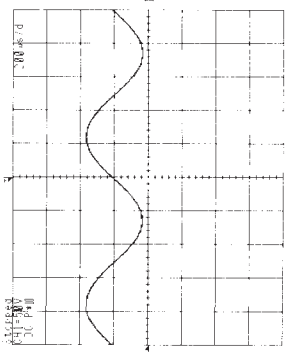
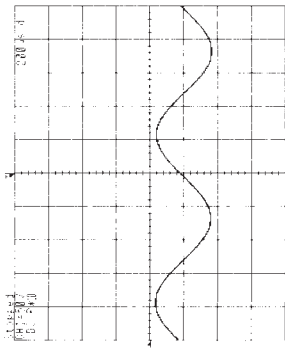

THIS DOCUMENT CONTAINS PROPRIETARY INFORMATION WHICH IS THE PROPERTY OF OSC AUDIO PRODUCTS. THAT WHICH IS NOT HEREIN EXPLICITLY SET FORTH IS NOT TO BE REPRODUCED OR USED IN ANY MANNER WITHOUT THE WRITTEN CONSENT FROM OSC AUDIO PRODUCTS.

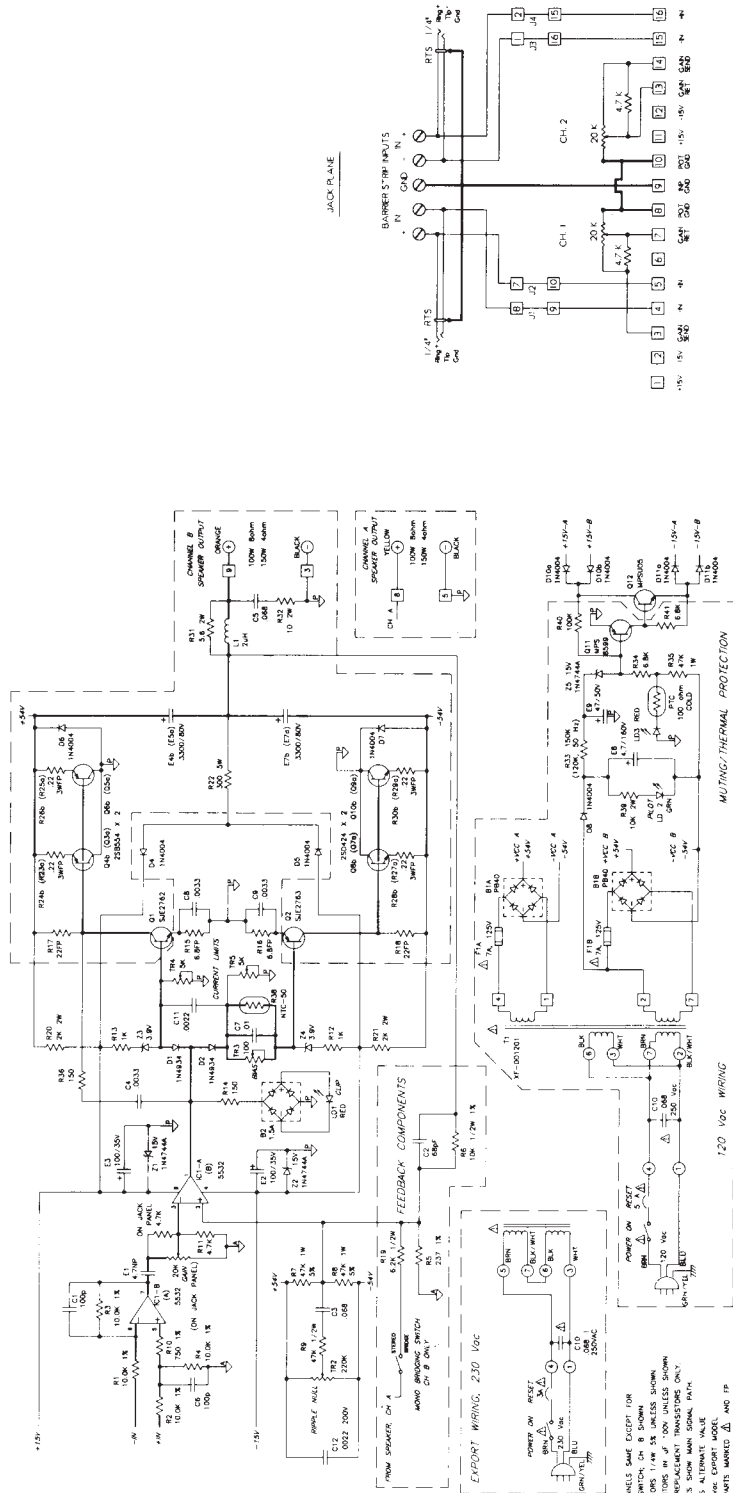

- NOTES
1. WITH CHANNELS SAME EXCEPT FOR BRIDGE SWITCH ON B SHOWN AS SAME.
  2. ALL CAPACITORS IN  $\mu$ F UNLESS SHOWN.
  3. USE OSC REPLACEMENT TRANSISTORS ONLY.
  4. HEAVY LINES SHOW MAIN SIGNAL PATH.
  5. RESISTOR VALUES IN PARENTHESES ARE FOR 350VAC SUPPLY.
  6. REPLACE PARTS MARKED  $\Delta$  AND  $\nabla$  WITH SAME TYPE ONLY FOR CONTINUED SAFETY.
  7. COMPONENTS MARKED WITH THE AET OR FLAMEPROOF SYMBOLS ARE NOT TO BE REPLACED.
  8. CHANNEL 'B' SPEAKER CHANNEL 'A' IN PARENTHESES.
  9. I.E. IC1-A INPUTS 1,2,3 BECOME 7,8,5 ON CHANNEL 'A' AND IC1-B INPUTS 7,8,5 BECOME 1,2,3 ON CHANNEL 'B'.

| LAST USED | NOT USED |
|-----------|----------|
| R2        | IC2      |
| D1        | D11      |
| D2        | D12      |
| D3        | D13      |
| D4        | D14      |
| D5        | D15      |
| D6        | D16      |
| D7        | D17      |
| D8        | D18      |
| D9        | D19      |
| D10       | D20      |
| D21       | D21A     |
| D22       | D22A     |
| D23       | D23A     |
| D24       | D24A     |
| D25       | D25A     |
| D26       | D26A     |
| D27       | D27A     |
| D28       | D28A     |
| D29       | D29A     |
| D30       | D30A     |
| D31       | D31A     |
| D32       | D32A     |
| D33       | D33A     |
| D34       | D34A     |
| D35       | D35A     |
| D36       | D36A     |
| D37       | D37A     |
| D38       | D38A     |
| D39       | D39A     |
| D40       | D40A     |
| D41       | D41A     |
| D42       | D42A     |
| D43       | D43A     |
| D44       | D44A     |
| D45       | D45A     |
| D46       | D46A     |
| D47       | D47A     |
| D48       | D48A     |
| D49       | D49A     |
| D50       | D50A     |
| D51       | D51A     |
| D52       | D52A     |
| D53       | D53A     |
| D54       | D54A     |
| D55       | D55A     |
| D56       | D56A     |
| D57       | D57A     |
| D58       | D58A     |
| D59       | D59A     |
| D60       | D60A     |
| D61       | D61A     |
| D62       | D62A     |
| D63       | D63A     |
| D64       | D64A     |
| D65       | D65A     |
| D66       | D66A     |
| D67       | D67A     |
| D68       | D68A     |
| D69       | D69A     |
| D70       | D70A     |
| D71       | D71A     |
| D72       | D72A     |
| D73       | D73A     |
| D74       | D74A     |
| D75       | D75A     |
| D76       | D76A     |
| D77       | D77A     |
| D78       | D78A     |
| D79       | D79A     |
| D80       | D80A     |
| D81       | D81A     |
| D82       | D82A     |
| D83       | D83A     |
| D84       | D84A     |
| D85       | D85A     |
| D86       | D86A     |
| D87       | D87A     |
| D88       | D88A     |
| D89       | D89A     |
| D90       | D90A     |
| D91       | D91A     |
| D92       | D92A     |
| D93       | D93A     |
| D94       | D94A     |
| D95       | D95A     |
| D96       | D96A     |
| D97       | D97A     |
| D98       | D98A     |
| D99       | D99A     |
| D100      | D100A    |

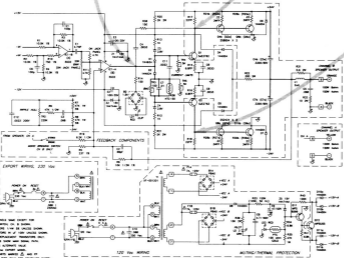
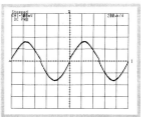
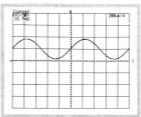
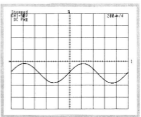

## NOTES

1. WITH CHANNELS WIDE OPEN THE BRIDGE SHOULD BE IN BALANCE
2. ALL RESISTORS 1% UNLESS STATED
3. ALL CAPACITORS  $\mu F$  UNLESS STATED
4. USE 500 AMPERAGE FUSE FOR MAIN
5. MAIN AND WIDE OPEN MUST BE OPEN
6. ALL POINTS SHOWN MUST BE OPEN FOR COMMON
7. REPAIR MAIN WIRING  $\leq 500$  OHM
8. WITH MAIN WIRING OPEN AND ON WITH MAIN THERMISTOR CLOSED MUST BE OPEN
9. ALL RESISTORS SHOWN 1% UNLESS OTHERWISE SPECIFIED AND UNLESS OF 1.0K
10. CHANGE "R" TO "K" UNLESS "K" IS SHOWN
11. "C" IS CAPACITANCE UNLESS "C" IS SHOWN
12. ALL 500 OHM RESISTORS 1.0K UNLESS OTHERWISE STATED

| UNIT | RES  | RES  | RES  |
|------|------|------|------|
| 1    | 100K | 100K | 100K |
| 2    | 100K | 100K | 100K |
| 3    | 100K | 100K | 100K |
| 4    | 100K | 100K | 100K |
| 5    | 100K | 100K | 100K |
| 6    | 100K | 100K | 100K |
| 7    | 100K | 100K | 100K |
| 8    | 100K | 100K | 100K |
| 9    | 100K | 100K | 100K |
| 10   | 100K | 100K | 100K |
| 11   | 100K | 100K | 100K |
| 12   | 100K | 100K | 100K |
| 13   | 100K | 100K | 100K |
| 14   | 100K | 100K | 100K |
| 15   | 100K | 100K | 100K |
| 16   | 100K | 100K | 100K |
| 17   | 100K | 100K | 100K |
| 18   | 100K | 100K | 100K |
| 19   | 100K | 100K | 100K |
| 20   | 100K | 100K | 100K |
| 21   | 100K | 100K | 100K |
| 22   | 100K | 100K | 100K |
| 23   | 100K | 100K | 100K |
| 24   | 100K | 100K | 100K |
| 25   | 100K | 100K | 100K |
| 26   | 100K | 100K | 100K |
| 27   | 100K | 100K | 100K |
| 28   | 100K | 100K | 100K |
| 29   | 100K | 100K | 100K |
| 30   | 100K | 100K | 100K |
| 31   | 100K | 100K | 100K |
| 32   | 100K | 100K | 100K |
| 33   | 100K | 100K | 100K |
| 34   | 100K | 100K | 100K |
| 35   | 100K | 100K | 100K |
| 36   | 100K | 100K | 100K |
| 37   | 100K | 100K | 100K |
| 38   | 100K | 100K | 100K |
| 39   | 100K | 100K | 100K |
| 40   | 100K | 100K | 100K |
| 41   | 100K | 100K | 100K |
| 42   | 100K | 100K | 100K |
| 43   | 100K | 100K | 100K |
| 44   | 100K | 100K | 100K |
| 45   | 100K | 100K | 100K |
| 46   | 100K | 100K | 100K |
| 47   | 100K | 100K | 100K |
| 48   | 100K | 100K | 100K |
| 49   | 100K | 100K | 100K |
| 50   | 100K | 100K | 100K |

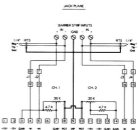

1. THIS DOCUMENT CONTAINS PROPRIETARY INFORMATION AND IS THE PROPERTY OF OSG ELECTRONICS INC. IT IS NOT TO BE REPRODUCED OR TRANSMITTED IN ANY FORM OR BY ANY MEANS, ELECTRONIC OR MECHANICAL, INCLUDING PHOTOCOPYING, RECORDING, OR BY ANY INFORMATION STORAGE AND RETRIEVAL SYSTEM.
2. ALL RIGHTS ARE RESERVED BY OSG ELECTRONICS INC.
3. ALL RIGHTS ARE RESERVED BY OSG ELECTRONICS INC.
4. ALL RIGHTS ARE RESERVED BY OSG ELECTRONICS INC.
5. ALL RIGHTS ARE RESERVED BY OSG ELECTRONICS INC.
6. ALL RIGHTS ARE RESERVED BY OSG ELECTRONICS INC.
7. ALL RIGHTS ARE RESERVED BY OSG ELECTRONICS INC.
8. ALL RIGHTS ARE RESERVED BY OSG ELECTRONICS INC.
9. ALL RIGHTS ARE RESERVED BY OSG ELECTRONICS INC.
10. ALL RIGHTS ARE RESERVED BY OSG ELECTRONICS INC.
11. ALL RIGHTS ARE RESERVED BY OSG ELECTRONICS INC.
12. ALL RIGHTS ARE RESERVED BY OSG ELECTRONICS INC.
13. ALL RIGHTS ARE RESERVED BY OSG ELECTRONICS INC.
14. ALL RIGHTS ARE RESERVED BY OSG ELECTRONICS INC.
15. ALL RIGHTS ARE RESERVED BY OSG ELECTRONICS INC.
16. ALL RIGHTS ARE RESERVED BY OSG ELECTRONICS INC.
17. ALL RIGHTS ARE RESERVED BY OSG ELECTRONICS INC.
18. ALL RIGHTS ARE RESERVED BY OSG ELECTRONICS INC.
19. ALL RIGHTS ARE RESERVED BY OSG ELECTRONICS INC.
20. ALL RIGHTS ARE RESERVED BY OSG ELECTRONICS INC.
21. ALL RIGHTS ARE RESERVED BY OSG ELECTRONICS INC.
22. ALL RIGHTS ARE RESERVED BY OSG ELECTRONICS INC.
23. ALL RIGHTS ARE RESERVED BY OSG ELECTRONICS INC.
24. ALL RIGHTS ARE RESERVED BY OSG ELECTRONICS INC.
25. ALL RIGHTS ARE RESERVED BY OSG ELECTRONICS INC.
26. ALL RIGHTS ARE RESERVED BY OSG ELECTRONICS INC.
27. ALL RIGHTS ARE RESERVED BY OSG ELECTRONICS INC.
28. ALL RIGHTS ARE RESERVED BY OSG ELECTRONICS INC.
29. ALL RIGHTS ARE RESERVED BY OSG ELECTRONICS INC.
30. ALL RIGHTS ARE RESERVED BY OSG ELECTRONICS INC.
31. ALL RIGHTS ARE RESERVED BY OSG ELECTRONICS INC.
32. ALL RIGHTS ARE RESERVED BY OSG ELECTRONICS INC.
33. ALL RIGHTS ARE RESERVED BY OSG ELECTRONICS INC.
34. ALL RIGHTS ARE RESERVED BY OSG ELECTRONICS INC.
35. ALL RIGHTS ARE RESERVED BY OSG ELECTRONICS INC.
36. ALL RIGHTS ARE RESERVED BY OSG ELECTRONICS INC.
37. ALL RIGHTS ARE RESERVED BY OSG ELECTRONICS INC.
38. ALL RIGHTS ARE RESERVED BY OSG ELECTRONICS INC.
39. ALL RIGHTS ARE RESERVED BY OSG ELECTRONICS INC.
40. ALL RIGHTS ARE RESERVED BY OSG ELECTRONICS INC.
41. ALL RIGHTS ARE RESERVED BY OSG ELECTRONICS INC.
42. ALL RIGHTS ARE RESERVED BY OSG ELECTRONICS INC.
43. ALL RIGHTS ARE RESERVED BY OSG ELECTRONICS INC.
44. ALL RIGHTS ARE RESERVED BY OSG ELECTRONICS INC.
45. ALL RIGHTS ARE RESERVED BY OSG ELECTRONICS INC.
46. ALL RIGHTS ARE RESERVED BY OSG ELECTRONICS INC.
47. ALL RIGHTS ARE RESERVED BY OSG ELECTRONICS INC.
48. ALL RIGHTS ARE RESERVED BY OSG ELECTRONICS INC.
49. ALL RIGHTS ARE RESERVED BY OSG ELECTRONICS INC.
50. ALL RIGHTS ARE RESERVED BY OSG ELECTRONICS INC.

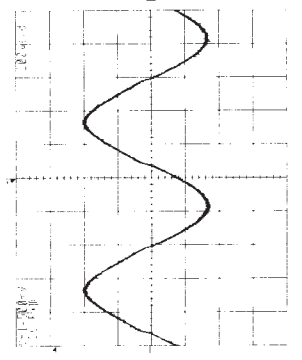
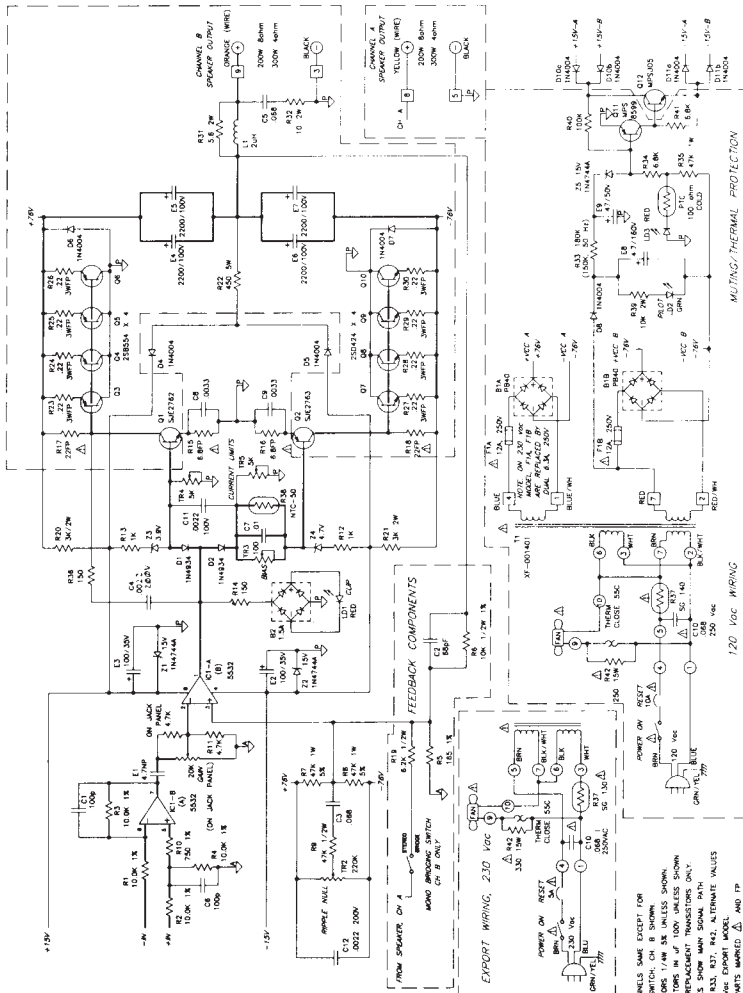
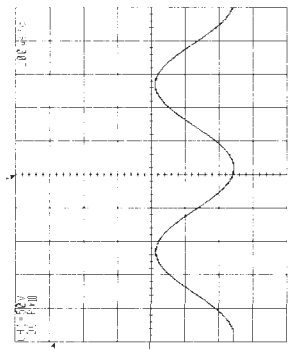
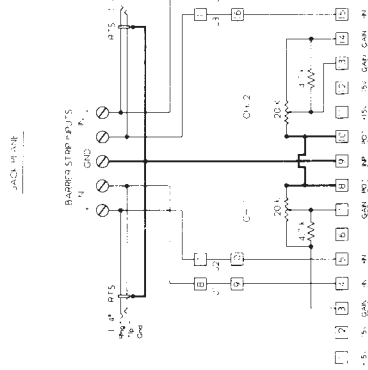
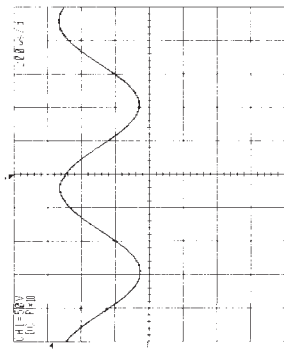

THIS DOCUMENT CONTAINS PROPRIETARY INFORMATION WHICH IS THE PROPERTY OF OSC AUDIO PRODUCTS THAT MAY NOT BE REPRODUCED OR TRANSMITTED IN ANY FORM OR BY ANY MEANS WITHOUT EXPRESS WRITTEN CONSENT FROM OSC AUDIO PRODUCTS

- NOTES
1. BOTH CHANNELS SAME EXCEPT FOR WIREING SWITCH, CH. B SHOWN.
  2. ALL CAPACITORS IN  $\mu$ F UNLESS SHOWN.
  3. USE OSC REPLACEMENT TRANSISTORS ONLY.
  4. HEAVY LINES SHOW MAIN SIGNAL PATH.
  5. ALL DIMENSIONS ARE IN MILLIMETERS UNLESS OTHERWISE SPECIFIED.
  6. FOR 250 VOLT EXPORT MODELS.
  7. REPLACE PARTS MARKED  $\Delta$  AND TP WITH SAME TYPE ONLY FOR CONTINUED SAFETY.
  8. ALL PARTS ARE UL LISTED AND APPROVED FOR USE IN THE U.S.
  9. CONNECTIONS AND DIMENSIONS OF 1.7" WAFERPROOF CHANNEL "B" SHOWN. CHANNEL "A" IN PARENTHESES (IE K1-A PRODUCTS 1,2,3 BECOME 7,8,9 ON CHANNEL "A", AND C1-B PRODUCTS 7,8,9 BECOME 1,2,3 ON CHANNEL "A").

| PART NO. | DESCRIPTION | QTY. |
|----------|-------------|------|
| 82       | RESISTOR    | 1    |
| C12      | CAPACITOR   | 1    |
| D1       | DIODE       | 1    |
| F1       | FUSE        | 1    |
| G1       | TRANSISTOR  | 1    |
| H1       | TRANSISTOR  | 1    |
| I1       | TRANSISTOR  | 1    |
| J1       | TRANSISTOR  | 1    |
| K1       | TRANSISTOR  | 1    |
| L1       | TRANSISTOR  | 1    |
| M1       | TRANSISTOR  | 1    |
| N1       | TRANSISTOR  | 1    |
| O1       | TRANSISTOR  | 1    |
| P1       | TRANSISTOR  | 1    |
| Q1       | TRANSISTOR  | 1    |
| R1       | TRANSISTOR  | 1    |
| S1       | TRANSISTOR  | 1    |
| T1       | TRANSISTOR  | 1    |
| U1       | TRANSISTOR  | 1    |
| V1       | TRANSISTOR  | 1    |
| W1       | TRANSISTOR  | 1    |
| X1       | TRANSISTOR  | 1    |
| Y1       | TRANSISTOR  | 1    |
| Z1       | TRANSISTOR  | 1    |



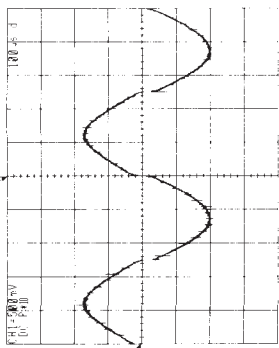
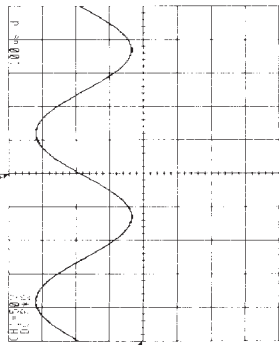
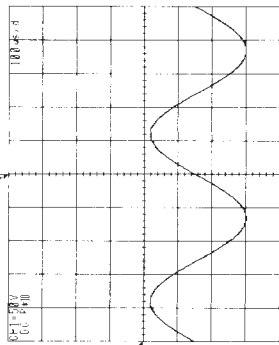

- NOTES:**
- BOTH CH. SAME EXCEPT FOR BRIDGING SW (CH 2 SHOWN).
  - ALL RESISTORS 1/4 WATTS 5% UNLESS SHOWN.
  - ALL CAPACITORS IN UF. 100V UNLESS SHOWN.
  - HEAVY LINE SHOWS MAIN SIGNAL PATH.
  - USE OSC REPLACEMENT TRANSISTORS ONLY.
  - TPP—FLAME PROOF RESISTORS.
  - Z1—Z6 ZENER DIODES.
  - B1—B3 BRIDGE RECTIFIERS.
  - LD1—LD2 FRONT PANEL LED'S.

- TRANSFORMER AND OUTPUT CONNECTOR PINS
- QUICK DISCONNECT TERMINALS (1-10)

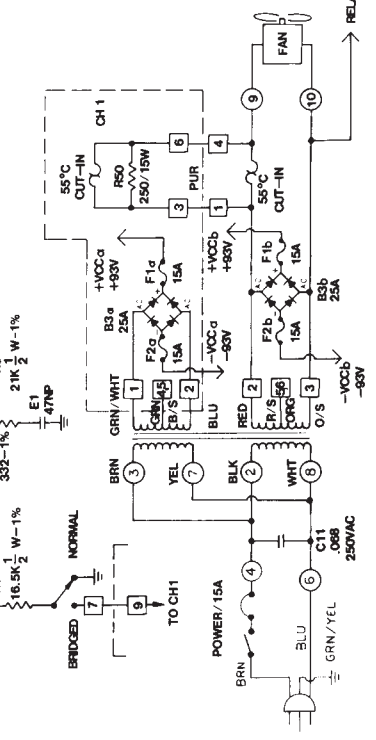
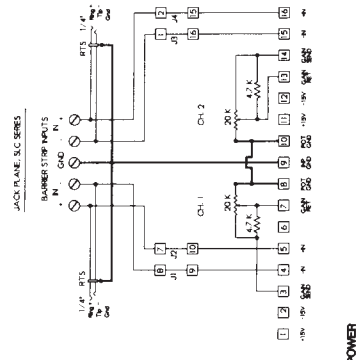
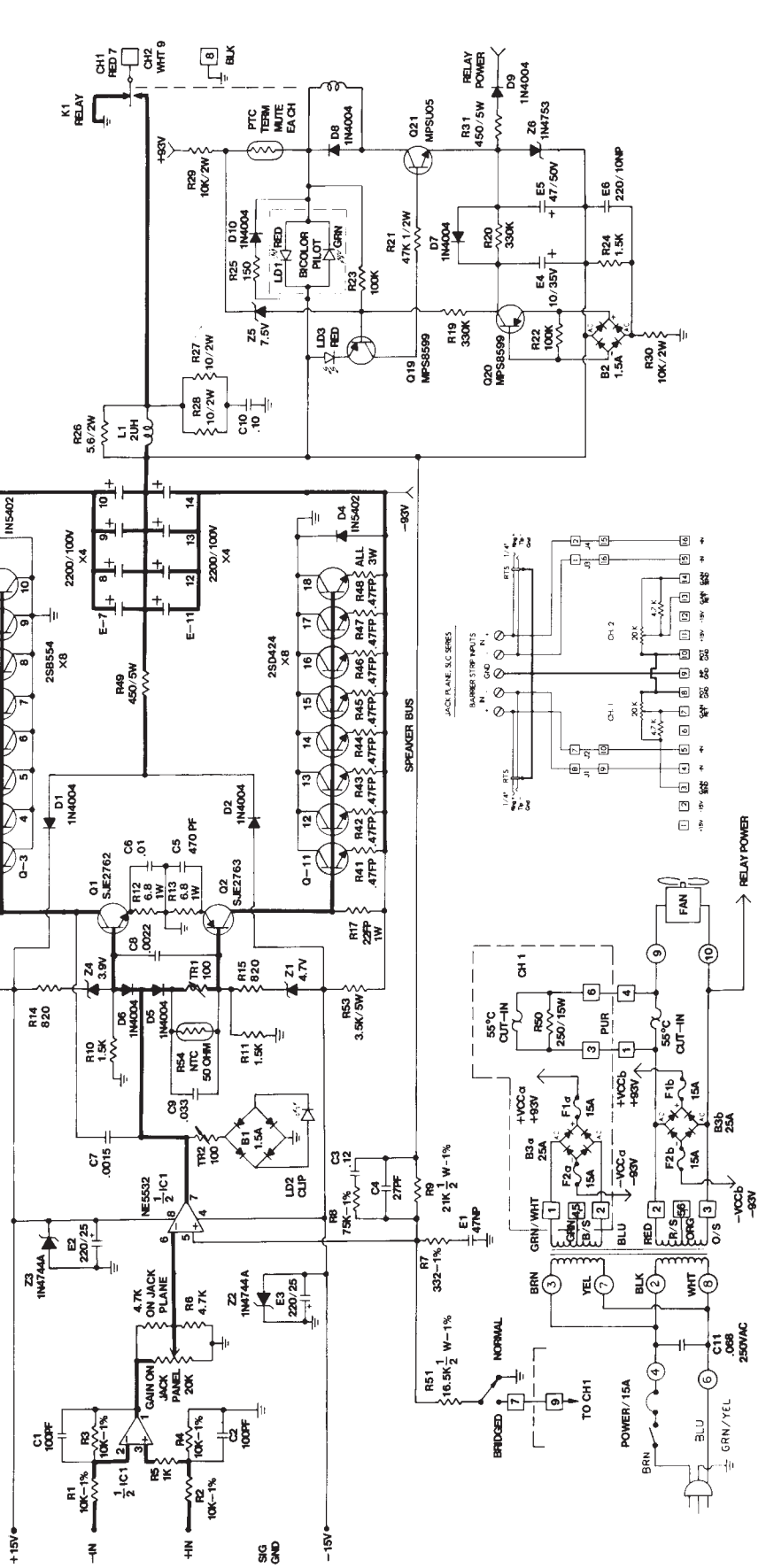

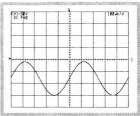
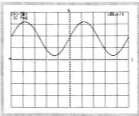
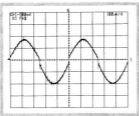

- NOTES:
1. BOTH CH. SAME EXCEPT FOR BRIDGES SW (CH 2 SHOWN).
  2. ALL RESISTORS 1% UNLESS SHOWN.
  3. ALL CAPACITORS IN UF. 100V UNLESS SHOWN.
  4. HEAVY LINE SHOWS MAIN SIGNAL PATH.
  5. USE OSC REPLACEMENT TRANSISTORS ONLY.
  6. 1P - FLAME PROOF RESISTORS.
  7. Z1 - Z5 ZENER DIODES.
  8. B1 - B3 BRIDGE RECTIFIERS.
  9. L301 - L33 FRONT PANEL LED'S.

- TRANSFORMER AND OUTPUT CONNECTOR PINS
- BLACK CONNECT TERMINALS (1-12)

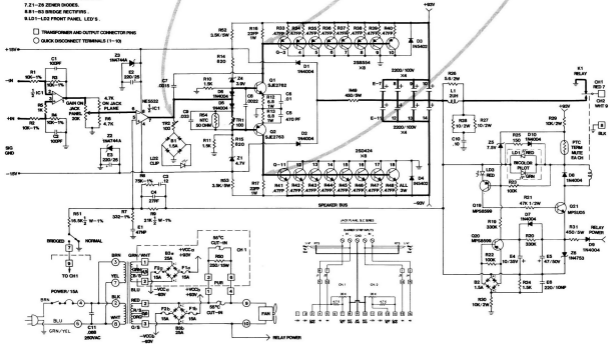



REDUCE TO 10,300

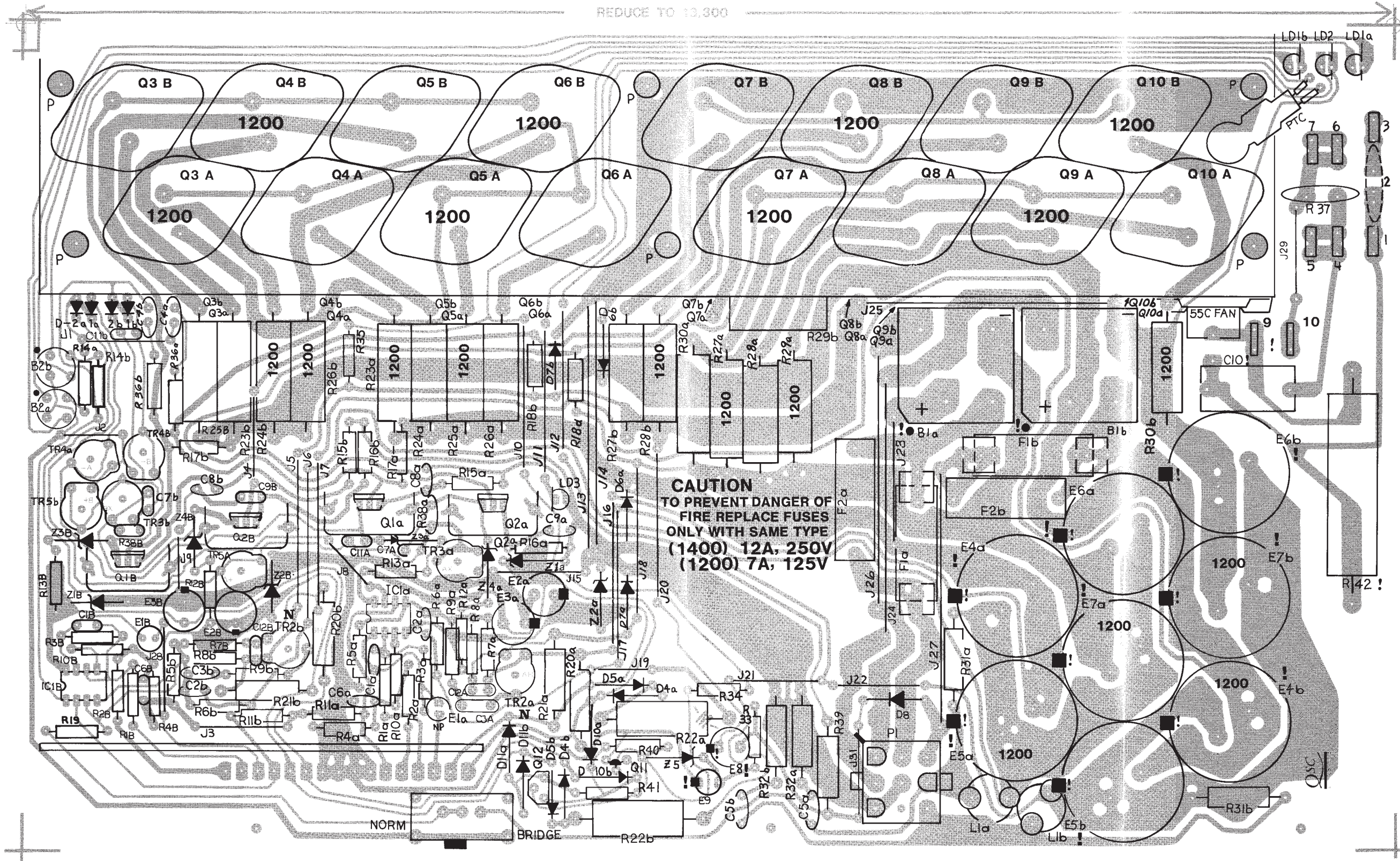



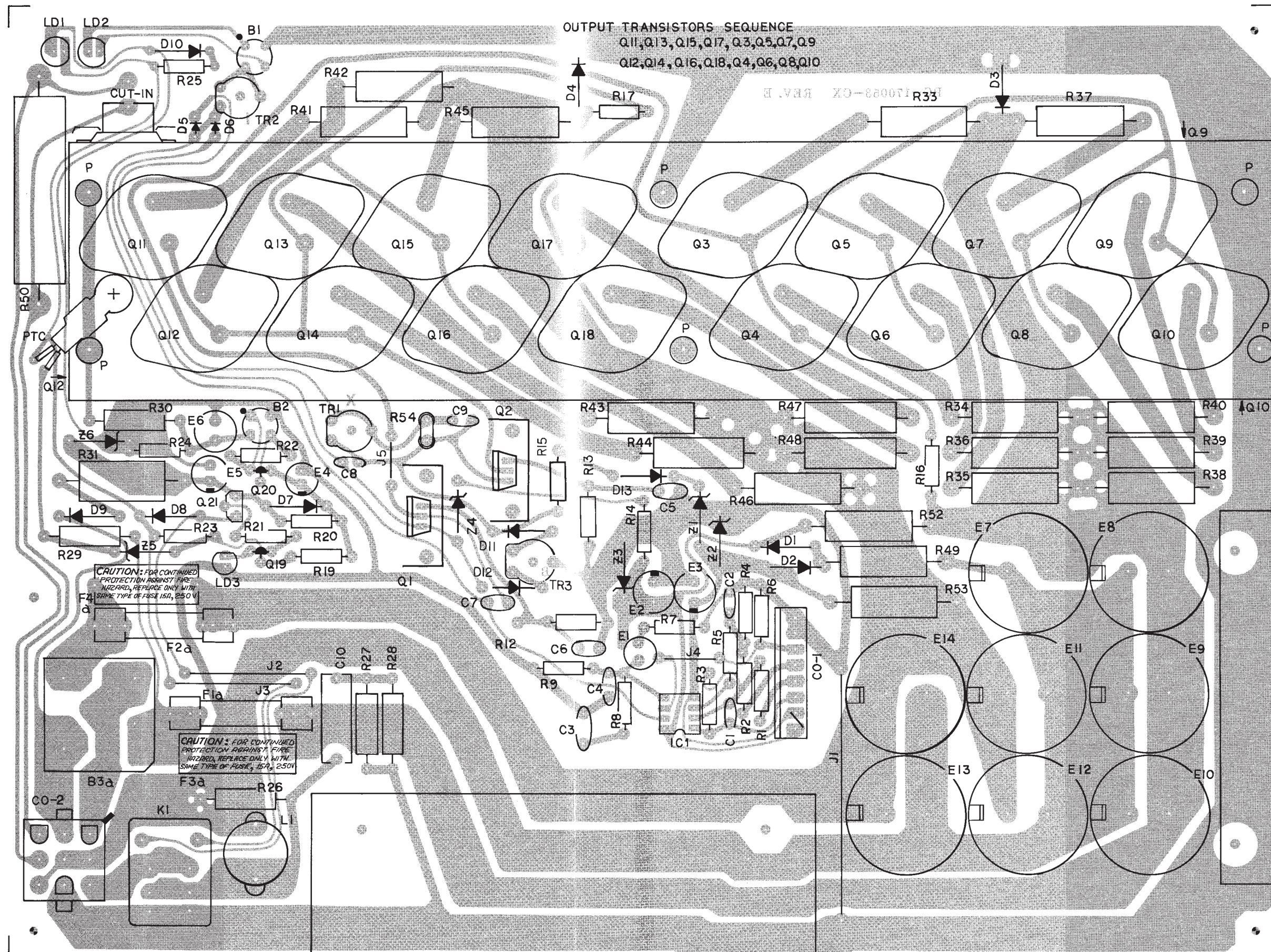



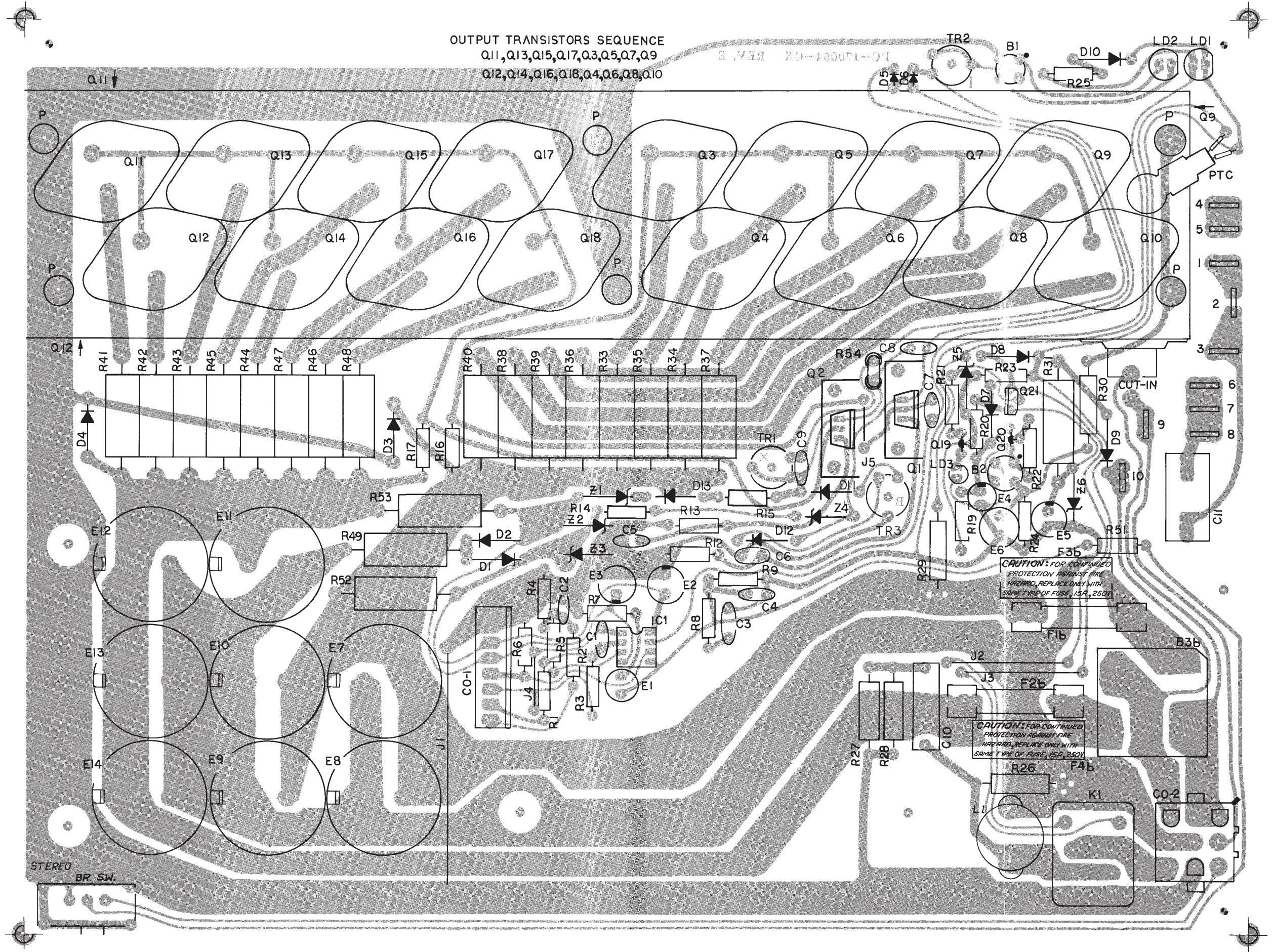



Jackplane PC Parts Side

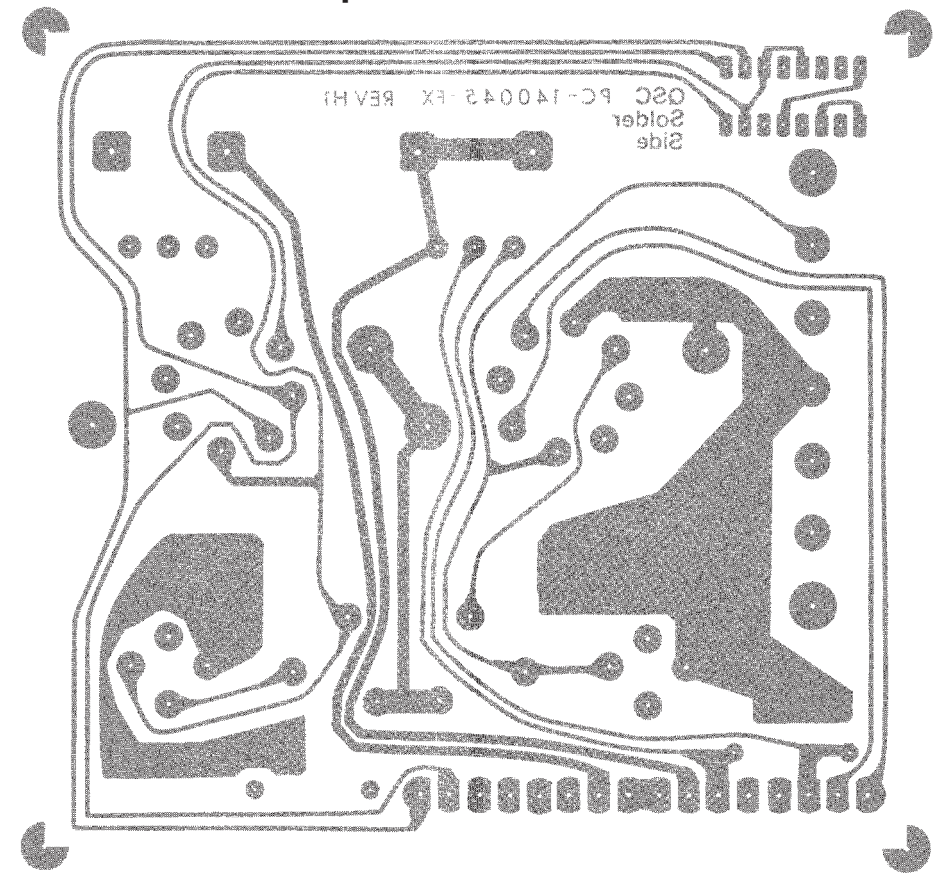

Jackplane PC Parts Side

