

MusicParts.Com

Technical Document Distribution

Brand:	Ramsa		
Model	WR-8112, WR-8118		
Product:	Mixer		
Description:	Service Manual	Dated:	none

Musicparts Document Number: 40342

TechTips: 0

Pages: 45

Hello,

Welcome to MusicParts.Com, Inc. your online resource for technical documents and service information. This PDF package may contain information, schematics, parts lists, images, engineering changes, previous versions, circuit descriptions, and many other unique features about the product you have chosen. This document was assembled from a variety of sources and is the result of our many years in the music repair business.

TECHTIPS: Unique to Musicparts documents are **TECHTIPS** located in critical areas on the schematics. They contain useful information about that area of the schematic such as common problems that we have found and recommended changes. Not all documents will have TechTips.

NOTE: Large original over-sized drawings will need to be taped together. We feel this is better than reducing them and losing fine details.

VIEWING: This document is utilizing PAGE-ON-DEMAND downloading. This will let you navigate to any page without waiting for the entire file to download.

PRINTING: For the best quality, we highly recommend that when the print dialog appears, please **make sure "SHRINK OVERSIZED PAGES " is checked.**, otherwise you may cut off the edge of the page. Also please stay online while printing this document to make sure you get all the pages.

Visit us on the web at: <http://www.musicparts.com/>
Email us at: customerservice@musicparts.com

Service Manual

Sound Reinforcement and Recording Console WR-8112, WR-8118

Frequency Response:	MIC INPUT ± 1.0 dB 20 Hz to 20 kHz (24 dB gain and +4 dB at master output) LINE INPUT ± 0.5 dB 20 Hz to 20 kHz (-6 dB gain and +4 dB at master output)
T.H.D.:	MIC INPUT 0.03% at 20 Hz, 0.03% at 1 kHz 0.07% at 20 kHz (24 dB gain and +18 dB at master output) LINE INPUT 0.07% 20 Hz to 20 kHz (-6 dB gain and +18 dB at master output)
SMPTE IM Distortion:	0.02% Mic or Line Input (+18 dB at master output)
Equivalent Input Noise:	-128 dB Maximum (-132 dB typical) IHF "A" WTD (64 dB gain 150-ohm source)
Residual Noise:	-90 dB at all faders down
Max. Input Level:	MIC +10 dB LINE +30 dB
Maximum Gain:	MIC 84 dB LINE 34 dB, EFFECT IN 34 dB
Crosstalk:	60 dB at 1 kHz
C.M.R.R.:	60 dB Minimum (20 Hz to 20 kHz) 70 dB Typical (1 kHz)
Phantom Power:	+48 V DC regulated (50 mA max current)
Input Channel EQ:	High 6 k/12 kHz ± 12 dB shelving Mid 400 Hz to 6 kHz sweep ± 12 dB peaking Low 60 Hz/180 Hz ± 12 dB shelving
Inputs:	Mic In x 12(18) (-60 to -20 dB, 12 k ohms, balanced XL-type connector) Line In x 12(18) (-10 to +10 dB, 20 k ohms, unbalanced phone jack) Effect In x 2 (-20 dB, 20 k ohms, phone jack) Sub In to Master L & R x 2 (+4 dB, 100 k ohms phone jack) Sub In to Mon/Eff L, R & Send x 3 (+4 dB, 100 k ohms phone jack)
Insertion (In/Out):	Input x 12(18) (-10 dB, 20 k ohms, phone jack) Group x 4 (-10 dB, 20 k ohms, phone jack) Master x 3 (-10 dB, 20 k ohms, phone jack)
Mixing Busses:	Group x 4 Master x 2 Monitor/Effect x 2 Send x 1 Solo x 1



Model WR-8118

Improvement information for WR-8112 is included in this manual.

Output (Unbalanced):	Group Out x 4 (-10 dB, 10 k ohms, phone jack) Master L,R Output x 2 (+4 dB, 600 ohms, phone jack) Master L, R Insertion x 2 (-10 dB, 10 k ohms, RCA pin jack) Mono Out x 1 (+4 dB, 600 ohms, XL-type connector) Mon/Eff Out x 2 (+4 dB, 10 k ohms, phone jack) Send Out x 1 (+4 dB, 10 k ohms, phone jack) Cue Send Out x 1 (+4 dB, 10 k ohms, phone jack) Monitor x 2 (+4 dB, 10 k ohms, phone jack) Phones L, R x 2 (500 mW into 8 ohms and 26 mW into 600 ohms, phone jack) Direct Out x 12 (-10 dB, 10 k ohms, phone jack)
Solo Trigger:	1 circuit
Maximum Output Level:	+20 dB
Peak Meters:	12-point LED bargraph type peak meter
Fader:	60 mm stroke smooth straight line fader
Peak Factor:	Input 30 dB, Program 16 dB
Power Source:	120V AC, 60Hz
Dimensions [WR-8112]:	24-9/32" (W) x 5-3/16" (H) x 20-10/16" (D) (617 mm x 147 mm x 524 mm)
[WR-8118]:	35-3/8" (W) x 5-13/16" (H) x 20-10/16" (D) (899 mm x 147 mm x 524 mm)
Weight [WR-8112]:	Approx. 41.7 lb (18.9 kg)
[WR-8118]:	Approx. 58.5 lb (26.5 kg)
	* 0dB is referenced to 0.775V rms. Weight and dimensions shown are approximate. Specifications are subject to change without notice.

Panasonic®

INPUT SECTION

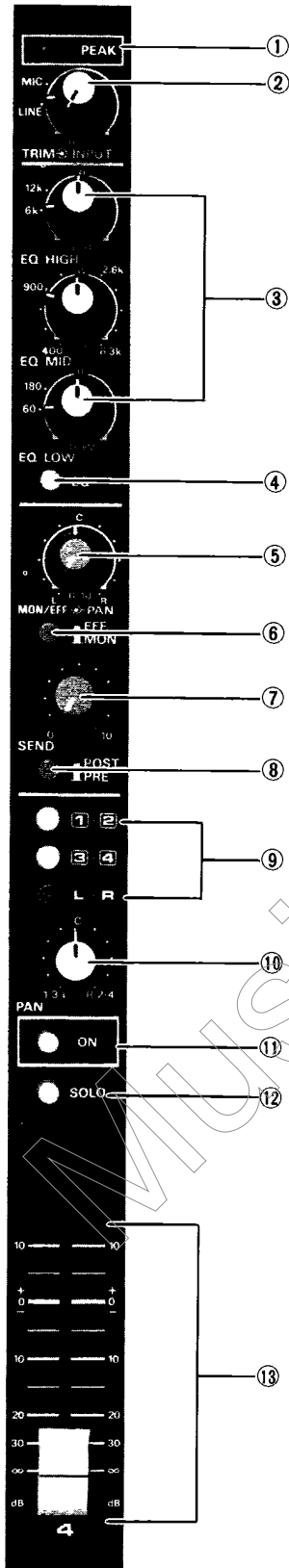

1. Peak LED

The peak LED indicates that 6 dB of headroom remains in the input section. By adjusting the trim control on the input as high as it can go before the LED flashes during peaks, you can obtain the optimum S/N ratio, while retaining low distortion.

If greater headroom is desired to avoid possible overload during excessive transient peaks, set all Line faders to their 0 dB position and adjust the relative balance between channels with the input trim controls. This will provide significant headroom as well as acceptable S/N ratio. The LED's indication applies to pre-EQ, pre-fader signals.

2. Input/Trim controls

The outer Input knob selects either the MIC or Line input. The inner Trim control provides continuously variable gain for either the Mic or Line input. 40 dB of adjustment is provided for the Mic Input and 20 dB is provided for the Line Input. If the Input selector is set to the Mic position the trim control has no effect on the Line signal being sent to the stereo tape monitor controls. Since the trim control takes effect before the insertion jack, it allows adjustment to the optimum level for connection of external equipment.

3. Equalizer

These controls offer the engineer maximum flexibility in tonal adjustment - a sophisticated 3-band variable frequency equalizer section is included. The center knob controls the level adjustment and includes a 0 dB center detent. The outer knob adjusts the frequency. These three controls provide the input signals with the following EQ Control Frequency adjustment Level adjustment.

High	6 k/12 kHz	+ 12 dB (Shelving)
Mid	400 Hz to 6.3 kHz	+ 12 dB (Peaking)
Low	60/180 Hz	+ 12 dB (Shelving)

For the midrange control, a continuously variable rotary knob permits precise frequency adjustments, covering about one octave around the center frequency. The low and high controls are 2-position shelving-type controls. Although choosing the correct mic for each source is the best way to achieve a good sounding signal, the equalizer can provide the engineer with a greater amount of control to achieve the desired signal quality. With the high degree of flexibility provided in this EQ section the engineer is not limited to a set of EQ controls where the frequencies chosen are not the same as the engineer chooses to adjust. For the recording engineer, usually each channel of a multi-channel tape recorder is recorded without any EQ during the overdub process. By adding Equalization during the mixdown, the engineer has the option of readjusting the equalization, rather than having it permanently on the tape.

However, when a limited number of channels are available and multiple sources are recorded in a channel at the same time rather than bouncing tracks, equalization will sometimes be added to the signals since equalization of individual signals is not possible. Also, when multiple mics are being used the equalizer can also be used for isolation. For

example, when recording drums, the highs could be attenuated on the kick drum signal and lows could be attenuated on the cymbal signal.

For the sound reinforcement engineer, the equalizer can serve three purposes. It can be used to correct tonal balance, isolation between channels, and feedback control. By providing a continuously variable frequency adjustment for the midrange control, not only can precise tonality be adjusted in the critical vocal range, it can also be used to notch out problem frequencies, where feedback is a problem, by attenuating the midrange control and sweeping the frequency control until the feedback is reduced.

4. Equalizer-On Switch:

Using this switch, you can turn the equalizer on or off without resetting the level adjustment positions.

5. Monitor/Effect Level Control & Pan:

The center control adjusts the level of either the tape monitor or Effect signal to the left and right Master Mon/EFF level controls.

The outer knob pans the signal between the left and right Master Mon/EFF level controls.

6. Monitor/Effect Select Switch:

This switch selects the signal to be sent to the Master L & R Mon/EFF controls. In the MON (tape monitor) position, the signal of the equipment connected to the LINE IN jack will be selected, and in the EFF (Effect) position, the post-fader signal chosen by the input selector will be selected.

7. SEND Control

This level control adjusts the level of either a pre-fader, pre-EQ, or a post-fader, post-EQ signal on each channel being sent to the Master Send Control.

8. PRE/POST Select Switch

This switch selects either a pre-fader, pre-EQ or post-fader, post-EQ signal to be controlled by the send control on each channel.

9. Program Bus Assign Switches

This section assigns the input signal to the input of any of the Four Group Outputs, or directly to the Left and Right outputs.

10. Pan Control

The Pan control, used in conjunction with the program assign switch, varies the level of the signal between any of the assigned channels. Turning the pan control to the left assigns channels 1, 3, L and turning to the right assigns channels 2, 4, R. In the center position the input signal will be sent to all assigned channels, each signal level is 3 dB down from the maximum level so that the combined stereo output power remains constant as the signal is panned.

By using the bus assign switches and the pan control multiple signals, such as a set of drum mics, could all be sent to a Group Bus where the overall level could be adjusted without having to change the relative balance between channels on the input faders. For recording, one input could be assigned from one group to another as tracks are recorded. When grouping is not necessary for individual signals the L & R assign switch allows connection to the left and right Master output section allowing the 4 groups to be used only for grouping purposes.

11. Channel on Switch

When this switch is engaged, the input signal is sent to any of the assigned output channels, the effect send control, and the direct out jack. When it is switched out the signal is muted. Mic leakage or noise caused by a mic not in use will be eliminated.

12. Solo Switch

This lockable switch provides monitoring of either a pre-fader, pre-EQ signal or a post-fader, post-EQ signal depending on the position of the MON/EFF switch. If the MON/EFF switch is in the Mon position, the solo switch will select a post-fader, post-EQ signal used during the recording process. When the MON/EFF switch is in the EFF position, the solo switch will select a pre-fader, pre-EQ signal used during sound reinforcement applications. Since it can be locked in the "on" position, simultaneous monitoring with other channels can be performed. When the solo mode is selected, the solo function is indicated by an LED indicating priority over other monitoring modes. Also, if the solo Meter Switch is engaged the solo level is also indicated by the LED Meter. The LED Meter is calibrated so that a level of -10 dB, at the insertion point for pre-fader signals or the direct out jack for post fader signals, will read 0 dB on the LED METER. By adjusting the input trim control and fader to give solo meter levels of 0 dB the rated output levels will be set at the insertion and direct out points yielding optimum headroom in the mixer. Because the mixer has greater headroom than the meter range will indicate, solo levels well above +12 dB on the LED Meter do not necessarily overload in the mixer. To check input overload use the input LED overload indicator or use the monitor section.

13. Input Fader

A 60 mm stroke, smooth touch fader adjusts the level to the direct out, Group and L & R outs through the program bus assign switches and pan pot.

METER SELECT

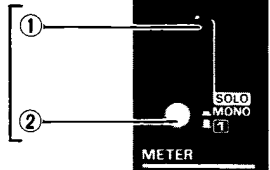

EFFECT SECTION

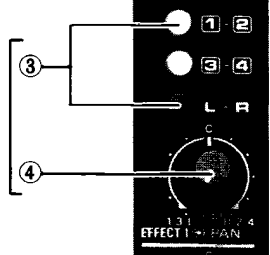

GROUP SECTION

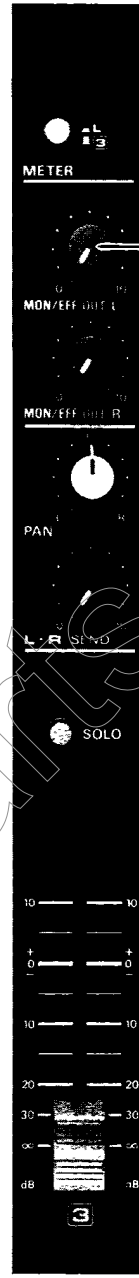
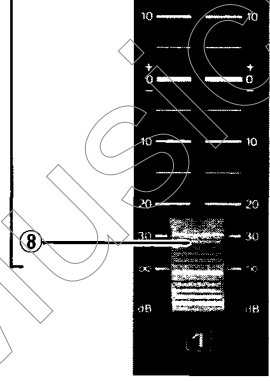
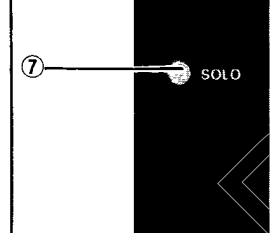
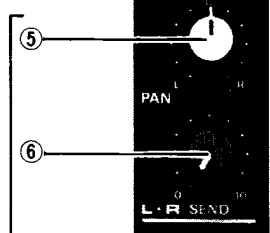

SEND SECTION



METER SELECT SECTION

1. Solo Meter Indicator

This LED illuminates when the solo meter switch is in the on position. For the solo meter function to occur, the Meter select switch must be in the Mono position.

2. Meter Select Switches

These switches are used to select any of the 4 group output levels for metering or to meter the levels of the Mono, Solo, Send, and L & R Master outputs

EFFECT SECTION

3. Effect In Assign Switches

These switches assign the signals returned from the effects unit to any of the 4 group busses or directly to the L & R channels of the stereo Master bus.

4. Effect Return Controls

The inner knob controls the level of the signal returned from the effects unit to any of the group busses or directly to the L & R channels of the stereo master bus via the Pan control and the assign switches. The outer knob adjusts the signal between any of the channels selected by the assign switches.

GROUP SECTION

5. Pan Control

The pan control routes the signal from each Group output between the left and right channels of the stereo Master fader.

6. L-R Send Control

The L-R SEND control adjusts the level of post-fader Group output signal to the left and right channels of the stereo Master Fader via the Pan control. By adjusting the L-R Send controls the levels of the Group outputs sent to the Stereo Master Fader may be adjusted to obtain the desired balance while still providing optimum output levels at the Group outputs for tape recorders or external signal processing devices

7. Solo Switch

This locking switch is used to monitor the post-fader signal of each Group output individually. Activation of the Solo button is indicated by the solo-on LED indicating priority over other monitoring modes

8. Group Fader

A 60 mm stroke, smooth touch fader adjusts the overall level for the respective group program signals.

SEND SECTION

9. L & R Master MON/EFF Output Level Controls

These controls adjust the left and right Master outputs of either the Monitor or effects signals sent from any of the input channels. For recording, the output of these two controls are summed together with the send control output to form the signal for the cue send output.

10. Send Output Level Control

This control adjusts the master output level of the send signal from any of the input channels. For recording, the output of this control is summed together with the L & R MON/EFF control outputs to form the signal for the cue send output.

MASTER & POWER SECTION



1. Phantom Power Indicator Lamp

The phantom power indicator lamp turns on when the +48 V DC phantom power is supplied to the mic inputs by turning the phantom power switch on.

2. Power ON/OFF Switch/Power Indicator

The power switch turns on the mixing console, and the indicator lamp displays the mode of operation

3. Phones Jack

A Tip-ring-sleeve phone jack will accept virtually any type of headphone for monitoring purposes. The signal being monitored may be chosen by the Monitor select switches and the level adjusted by the inner monitor knob on the MON/SOLO control. If a solo signal is selected, the solo LED will illuminate and the solo signal will take priority over other monitoring modes. A separate solo level control is also provided being the outer knob of the MON/SOLO Control.

4. Monitor Select Switch

These 3-lock release type switches permit convenient monitoring of the following signals

- | | |
|---------|----------------------|
| MON/EFF | MONITOR/EFFECT |
| SEND | (STEREO) |
| L, R | SEND (MONAURAL) |
| | MASTER L, R (STEREO) |

5. MON/SOLO Level Control

The inner knob of the MON/SOLO level control controls the level of the signal being sent to the L & R Monitor out jacks and the stereo headphone jack. The outer knob controls the level of the solo signal when a solo button is engaged. The solo level control is pre-fader to the monitor level control. If a solo button is not engaged, the signals controlled by the monitor level control will be chosen by the monitor select switches

6. Solo Meter Switch

When the solo meter switch is engaged an LED near the Group 1/MONO meter will illuminate. If the Group 1/MONO switch is in the Mono position, then any solo signal will be shown by the Group 1/MONO meter. If the MON/EFF switch is in the MON position then 0 dB on the

METER PANEL

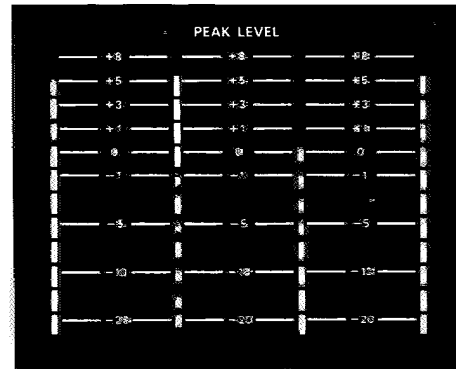

solo meter will correspond to -10 dB at the direct out jack which will be useful for multichannel recording. And if the MON/EFF switch is in the EFF position then 0 dB on the solo meter will correspond to -10 dB at the insertion point, which will be useful for monitoring the levels to be sent to external signal processing devices. Because the mixer has greater headroom than the meter range will indicate, solo levels well above +12 dB on the LED Meter do not necessarily indicate overload in the mixer. To check input overload use the input LED overload indicator or use the monitor section.

7. Mono Master Control

This control adjusts the level of the combination of the left and right master outputs, to the mono output connection

8. Solo Indicator Lamp

The solo indicator illuminates when either an input or a group solo switch is in the ON position

9. Stereo Master Fader

A single stereo Master Fader is used to adjust the level of the left and right master outputs

10. Output Meter

Four 12 point LED peak reading meters are provided for monitoring the 4 Group outputs, Mono output, Send output, Master L output, Master R output and Solo signals. The colors of the LEDs are Green for -30 dB to 0 dB, Yellow for +1 dB to +5 dB, Red for +8 dB or more. The meters have been designed to have quick attack time to monitor transients and slow decay time for optimum visual indication

0 dB on the meter corresponds to -10 dB for Group 1 to 4 and Solo output, and to +4 dB for Mono, Send, Master L and R output.

REAR PANEL

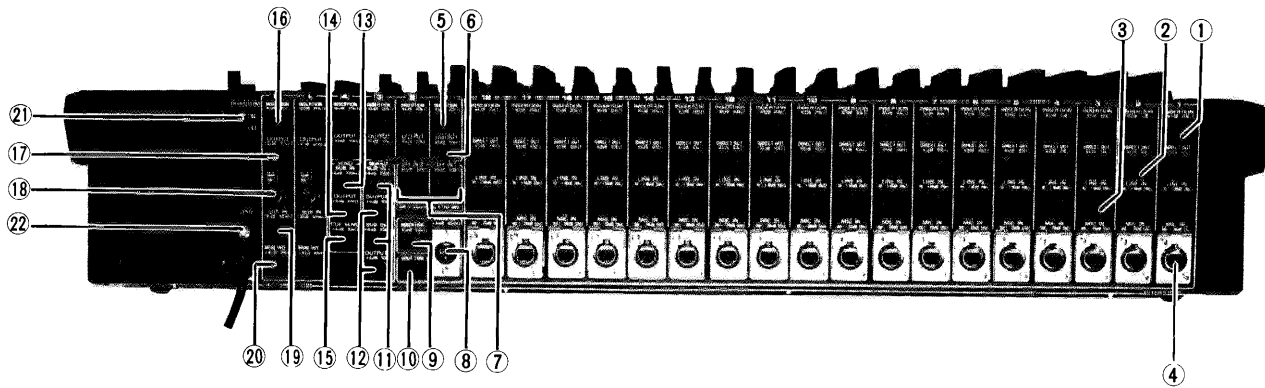

Model: WR-8118

1. Input Insertion Jack

(Phone Jack, -10 dB, 20 K ohms)

An Input insertion jack is provided for innerconnection of signal processing equipment. Each jack accepts a TRS phone plug using the RTS form. Tip is Return In and Ring is Send Out.

2. Direct Out Jack

(Phone Jack, -10 dB, 10 K ohms)

The Direct Out jack can be easily used for a direct send to a multi-track recorder, or as an individual cue or effects send.

3. Line Input Jack

(Phone Jack, -10 dB to $+10$ dB, 20 K ohms)

A line input jack is provided for connecting auxiliary equipment or the output of a multi track recorder.

4. Mic Input Connector

(XL-type connector -60 dB to -20 dB, 12K ohms)

A Mic Input jack is electronically balanced, with $+48$ V DC phantom power available for condenser microphones.

5. Group Output Jacks

(Phone Jacks, -10 dB, 10 K ohms)

Four Group output jacks are provided to connect to a multi-track tape recorder. The signal levels are controlled by the Group Line Faders and independent of the L-R SEND Controls and Pan Controls. In the event a $+4$ dB, 10 K ohm signal is desired the levels may be changed internally by moving the jumper wire on the group modules to the $+4$ dB post.

6. Group Insertion In/Out Jack

(Phone Jack, -10 dB, 20 K ohms)

Group insertion jacks are provided for interconnection of accessory equipment. Each jack accepts a TRS phone plug using the TS format. Tip is Return In and Ring is Send out.

7. Effect Input Jack

(Phone Jack, -20 dB, 20 K ohms)

An effect in jack connects the output from the sound effect's device to the mixer.

8. Mono Master Output Connector

(XL-type Connector, $+4$ dB, 600 ohms)

The Mono Master output jack is a terminal providing the mono output controlled by the Mono Master Control.

9. Mono Master Insertion Jack

(Phone Jack, -10 dB, 20 K ohms)

An insertion jack is provided for the mono output signal to connect accessory signal processing equipment, this jack accepts a TRS phone plug using the TRS Format. Tip is Return In and Ring is Send Out.

10. Solo Trigger Jack

A solo trigger jack is provided to activate the Solo function on an external monitor console.

11. MON/EFFECT Sub-Input Jack

(Phone Jack, $+4$ dB, 10 K ohms)

By using this jack, signals from another mixer can be mixed directly with the Monitor/Effect L & R Bus line.

12. MON/EFFECT Output Jacks

(Phone Jack, $+4$ dB, 10 K ohms)

Two outputs are provided for each of the left and right MON/EFFECT outputs controlled by the L & R Master MON/EFFECT controls.

13. SEND, Sub Input Jack

(Phone Jack, $+4$ dB, 10 K ohms)

By using this jack, signals from another mixer can be mixed directly with the send bus line before the Master Fader.

14. SEND Output Jack

(Phone Jack, $+4$ dB, 10 K ohms)

This jack provides a connection for either a stage monitor speaker, effect device, or a cue send system.

15. Cue Send Output Jack

(Phone Jack, $+4$ dB, 10 K ohms)

In the event that the MON/EFF and Send output jacks are being used a CUE SEND output jack is provided which sums together the outputs of the L & R MON/EFFECT and Send busses.

16. Master L & R, Insertion Jack

(Phone Jack, -10 dB, 20 K ohms)

Used to connect external equipment to process the Master left + right Signals.

17. Master L & R, Output Jack

(Phone Jack, $+4$ dB, 600 ohms)

This jack is a terminal for sending out the L & R Master signals adjusted by the Master Fader.

18. Master L & R, Output Jack

(Pin Jack, -10 dB, 10 K ohms)

This pin jack is a spare output terminal of the Master L & R Output. To be used when recording cassette tapes.

19. Master L & R, Sub Input Jack

(Phone Jack, $+4$ dB, 100 K ohms)

With this jack, signals from another mixer or tape recorder can be mixed directly to the L & R Master signals before the Master Fader.

20. Monitor Output Jack

(Phone Jack, $+4$ dB, 10 K ohms)

This jack is used for external monitoring of the head phone signal.

21. Phantom Power ON/OFF Switch (48 V DC)

When the phantom power switch is turned on, up to 48 V DC is available at the microphone inputs to power condenser microphones.

22. Grounding (GND) Terminal

A grounding terminal, for hard wire grounding of the mixing console, is provided.

Note:

* 0dB is referenced to 0.775V rms

CABLE CONNECTIONS TO IN/OUT Connector

● XL-type Connectors

a. Balanced Connection (Input)

Connect 2-core shielded cable as shown below.

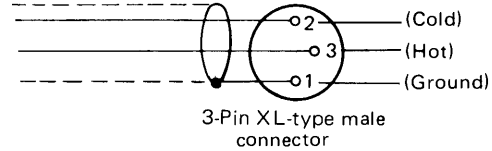
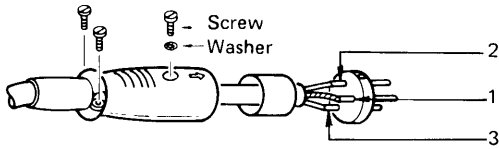

b. Balanced Connection (Output)

Connect 2-core shielded cable as shown below.

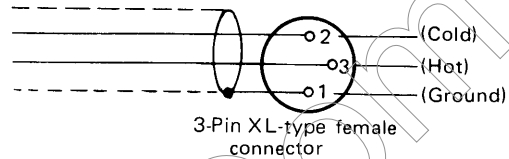
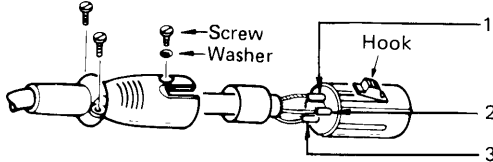

c. Unbalanced Connection (Input and Output)

When using an unbalanced microphone, connect pin No. 3 (Hot) and No. 2, 1 (Ground).

● Tip-sleeve phone plug

Connect single-core shielded cable as shown below.

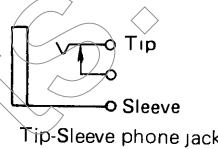
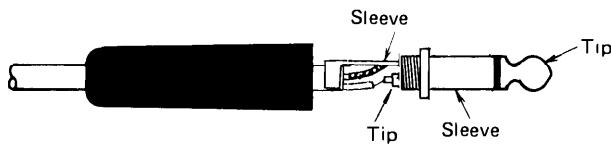

● Tip-Ring-Sleeve phone plug

Connect 2-core shielded cable as shown below.

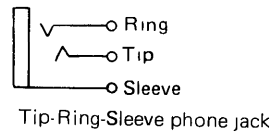
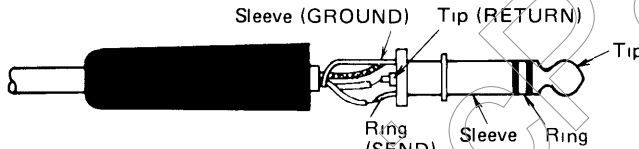

● RCA pin-plug (Output)

Connect single-core shielded cable as shown below.

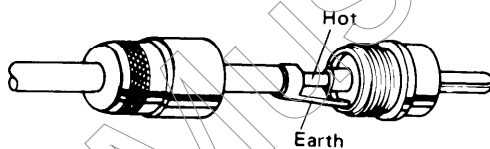

IMPORTANT NOTICE

- 1) The mixer outputs are available in a few seconds after the power switch is turned on. Also, it takes approximately 5 minutes before the performance of the mixer becomes fully stabilized. Clicking-sounds might be generated before it is fully warmed up.
- 2) When turning Phantom Power on, turn the output faders down to avoid any pops which might result in damage to the speakers or other equipment connected. Do not connect unbalanced microphones to the mic inputs. This may result in the damage of the microphones and the mixer's power supply.
- 3) For insertion at the input, group, L & R Master and MONO Master patches, use a Y type adaptor cord (optional), wired as tip return, ring send and sleeve common on a TRS phone plug.

BLOCK DIAGRAM

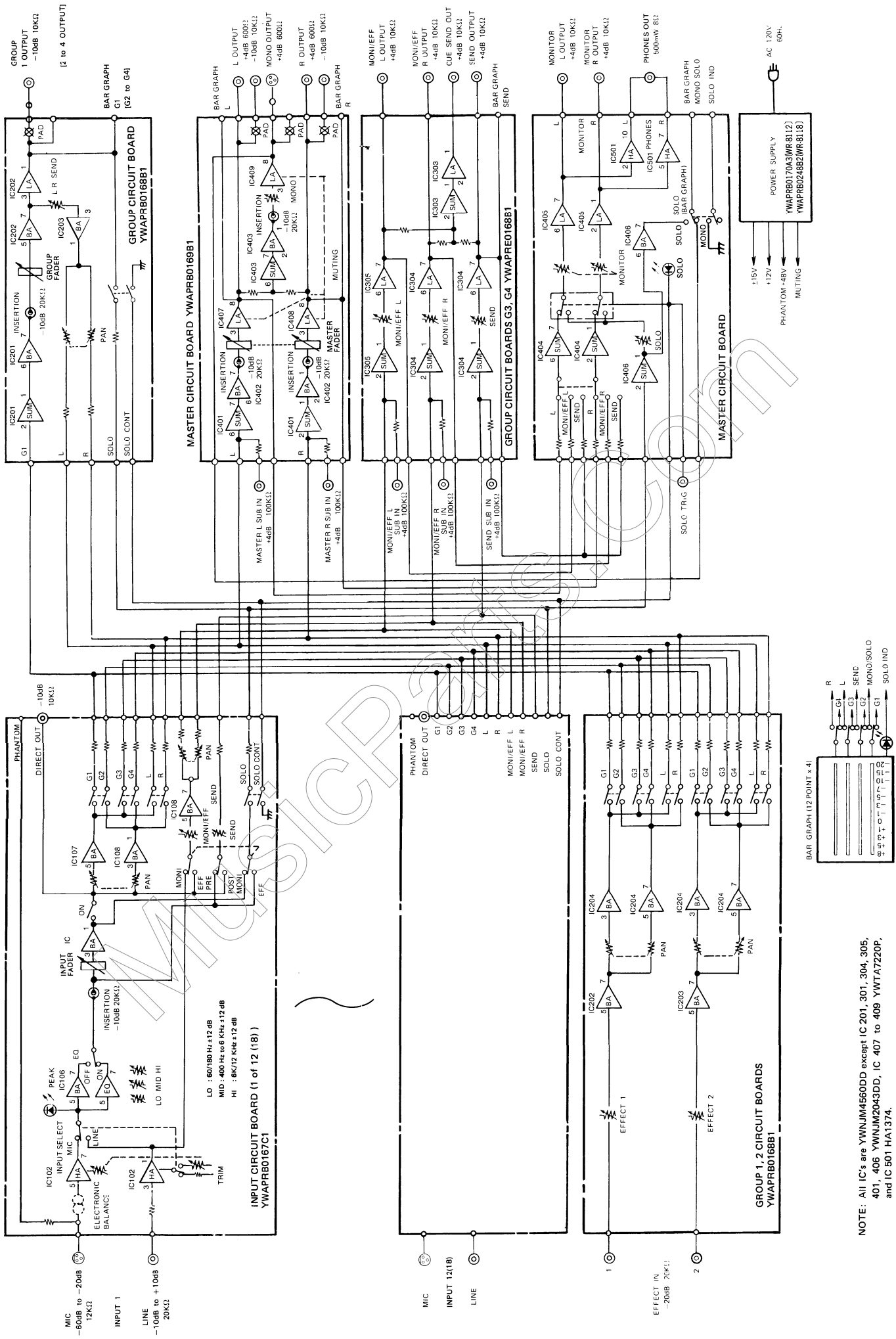

NOTE: All IC's are YWNJM4560DD except IC 201, 301, 304, 305, 401, 406 YWNJM2043DD, IC 407 to 409 YWTA7220P, and IC 501 HA1374.

LEVEL DIAGRAM

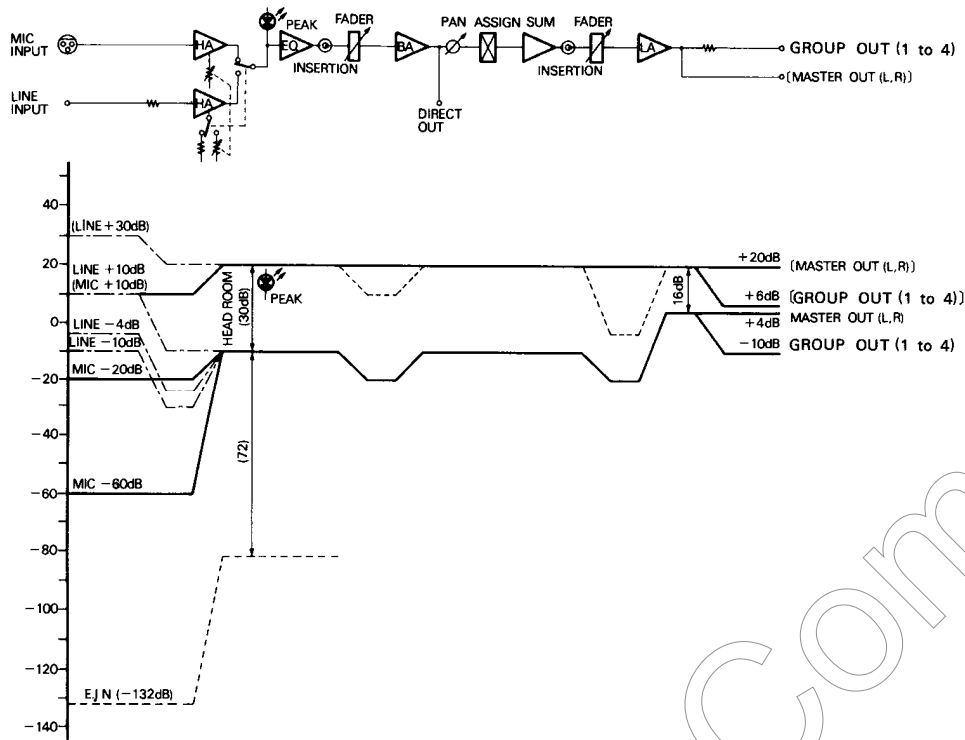

DISASSEMBLY

1. Bottom Cover Removal

- Remove the 13 screws and remove the bottom cover as shown in Fig. 1.

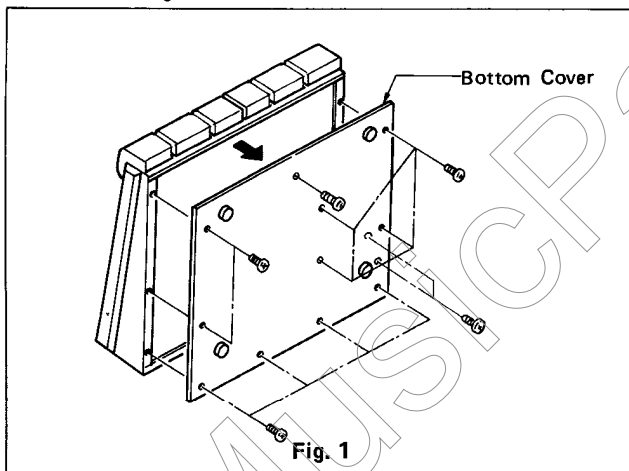

3. Control Panel Removal

- Pull off all the input and fader knobs.
- Remove the 8 screws, and the control panel as shown in Fig. 3.

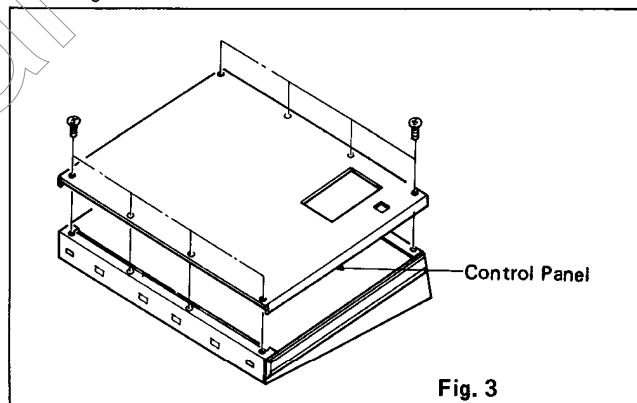

2. Arm Rest Removal

- Remove the 6 screws, and carefully lift up the arm rest as shown in Fig. 2.

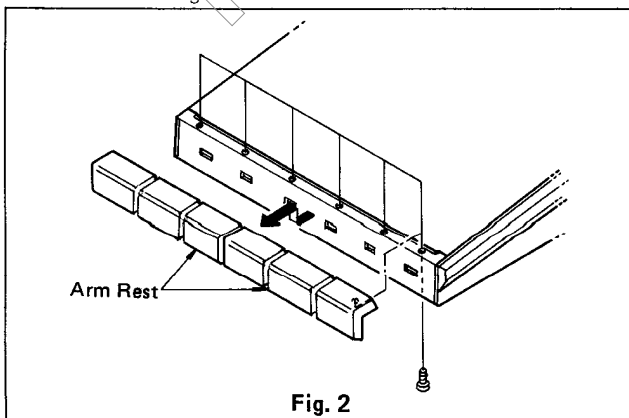

4. Circuit Board Removal

- To remove the input circuit board and input fader, remove the four (or 3 when remove Input 17 and 18) screw (A), and remove the input chassis.
- Remove the seven nuts (B), and remove the input circuit board.
- Remove the two screws (C), and remove the input fader board.

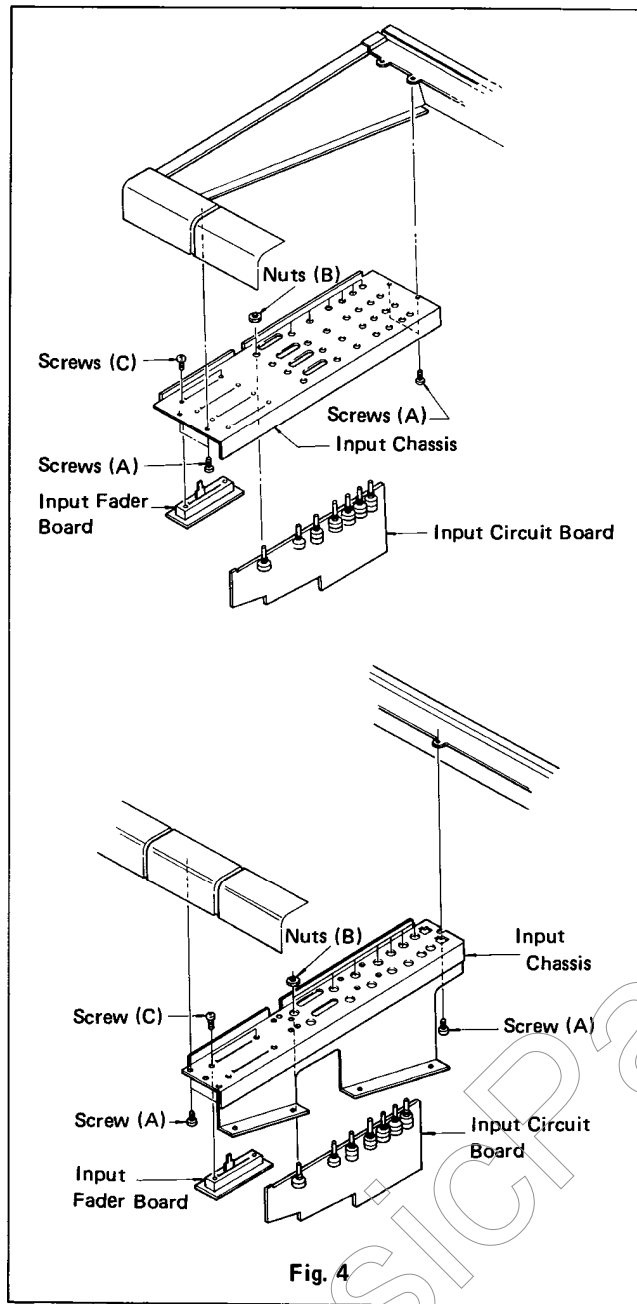

Fig. 4

- To remove the group circuit board, group fader board, master circuit board and master fader board, remove the four screws (D), and remove the master chassis.
- Remove the three nuts (or four nuts. G3 only) (E), and one screw (F), and remove the group circuit board.
- Remove the two screws (G), and remove the group fader board (or the master fader board).
- Remove the two nuts (H) and four screws (I), and remove the master circuit board.
- Remove the four screw (J) 1 and 4 connectors (CN701 to CN704), and remove the power circuit board.
- Remove the four screws (K), and remove the bar graph circuit board.

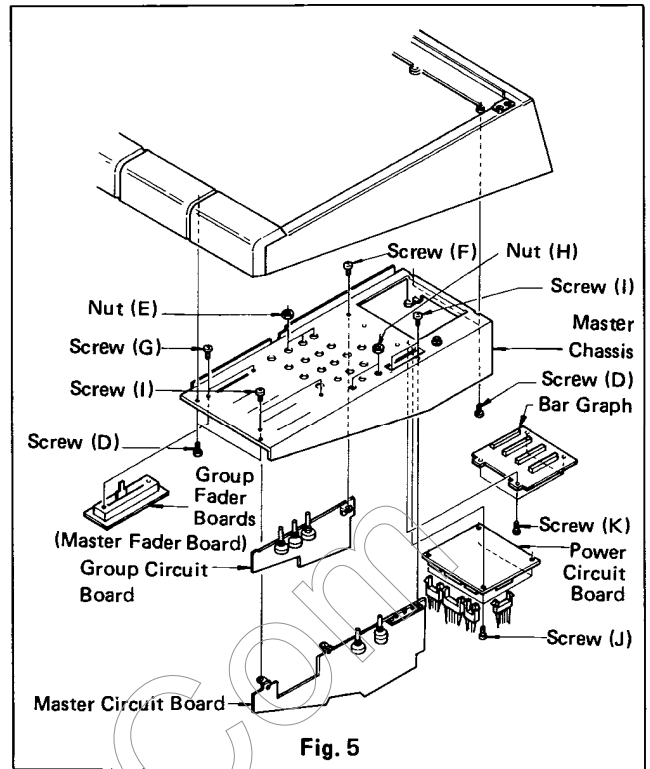

Fig. 5

- Remove the two screws (L) and remove the heat sink for power supply.
- Remove the two connectors (CN803 and CN804) and six screws (M,N) and remove the power control circuit board.

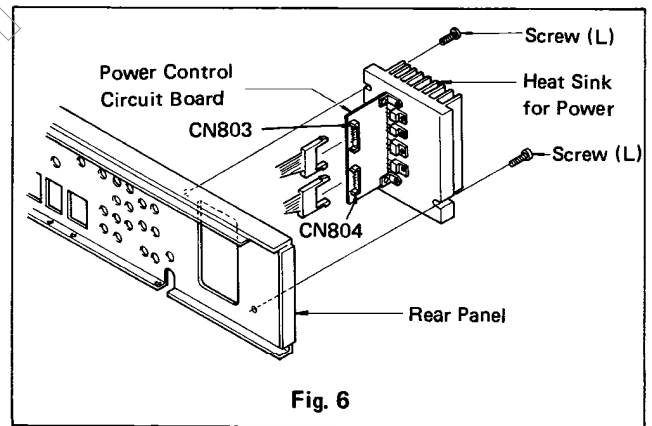

Fig. 6

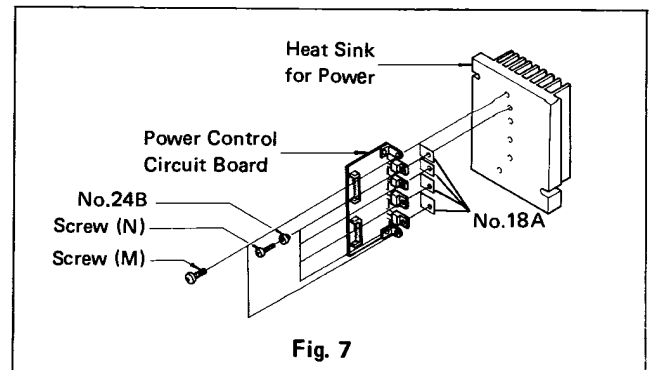
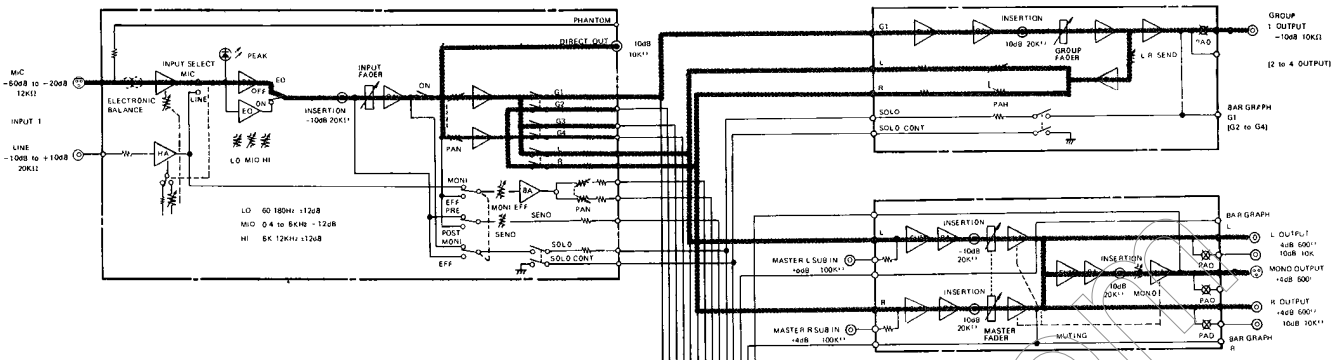

Fig. 7

OPERATION CHECK

1. MIC IN → DIRECT OUT
- MIC IN → GROUP OUT
- MIC IN → MASTER OUT
- MIC IN → MONO OUT



- Set the controls as follows.

■ INPUT SECTION

- Input Selector Switch : At "MIC" position
- Input Trim Control : At "10" on scale
- EQ On Switch : At off position
- Channel On Switch : At on position
- Input Fader : At "0 dB" on scale

■ GROUP SECTION

- Group Fader : At "0 dB" on scale

■ MASTER SECTION

- Master Fader : At "0 dB" on scale
- Mono Master Control : At "0 dB" on scale

- Apply a $-60 \text{ dB} \pm 2 \text{ dB/1 k Hz}$ signal to the MIC input connector.
- Check the DIRECT, GROUP, MASTER and MONO outputs level while setting the controls as follows.
When the GROUP output level is -10 dB , the other outputs will be the rated output level.
- Apply a -30 dB/1 k Hz signal to the MIC input connector and check that the Peak LED lights.
- Check all the MIC inputs in the same way.
- The rated output of Group output is normally -10 dB/10 k ohms . If $+4 \text{ dB/10 k ohms}$ rated output is required, move the jumper between "T" and "-10" to "T" and "+4" in output connection section of Group 1 to 4 printed circuit board.

Table 1

INPUT SECTION		GROUP SECTION		OUTPUT							
Program Bus Assign Switch	Pan Control	L-R Send Control	Pan Control	GROUP 1	GROUP 2	GROUP 3	GROUP 4	DIRECT	MASTER L	MASTER R	MONO
				-10 dB/10 kΩ				-10 dB/10 kΩ	+4 dB/600 Ω	+4 dB/600 Ω	+4 dB/600 Ω
1-2	1-3-L	"10"	L	○				○	○		○
	2-4-R		R		○			○		○	○
3-4	1-3-L	"10"	L			○		○	○		○
	2-4-R		R				○	○		○	○
L-R	1-3-L	"0"						○	○		○
	2-4-R							○		○	○

- 2. LINE IN → DIRECT OUT
- LINE IN → GROUP OUT
- LINE IN → MASTER OUT
- LINE IN → MONO OUT

- Set the Input Selector Switch to "LINE" position and others to the same positions as in the item 1.
- Apply a -10 dB ± 2 dB/1 k Hz signal to the LINE

input jack.

- Check in the same way as in item 1.
- Check all the LINE inputs in the same way.

- 3. MIC IN → MONI/EFF OUT
- MIC IN → CUE SEND OUT
- MIC IN → SEND OUT
- MIC IN → MONITOR OUT, PHONE OUT

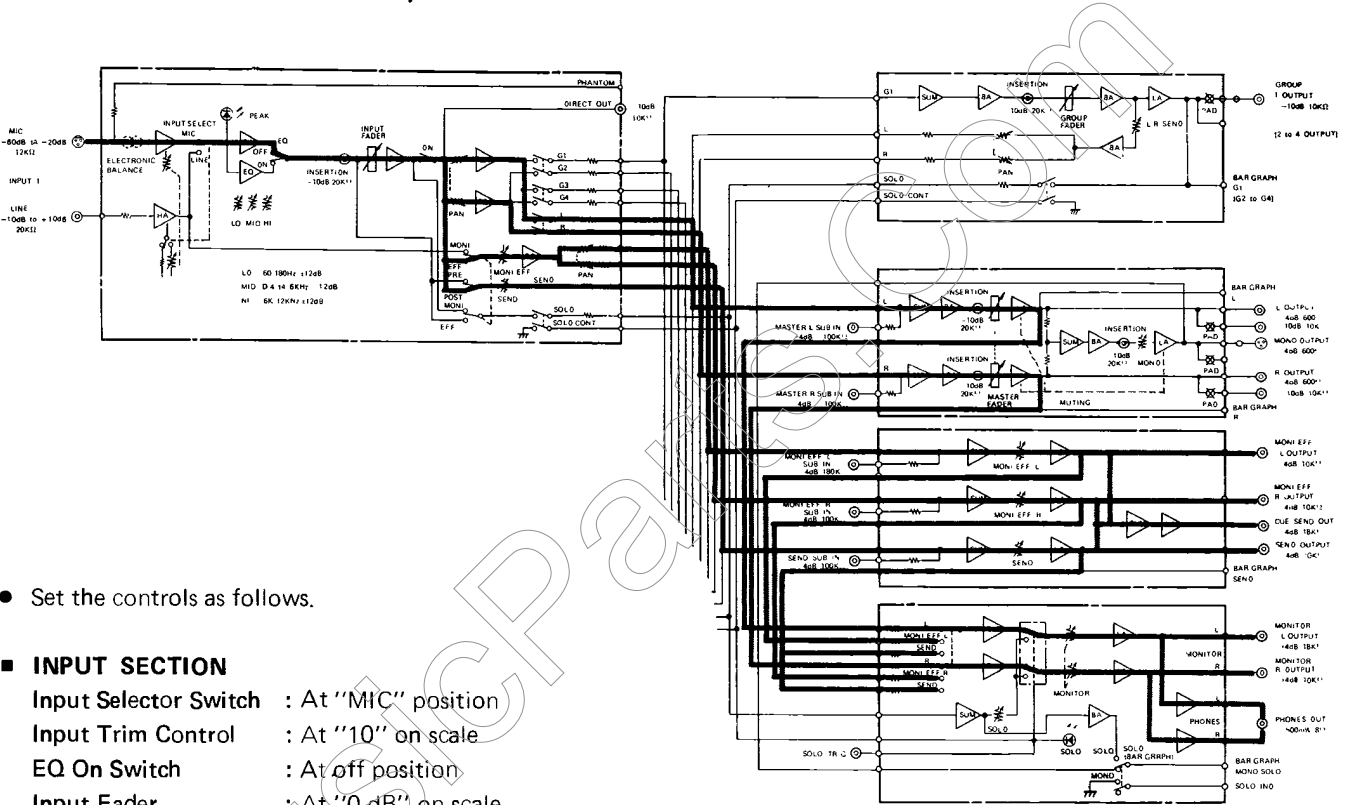

- Set the controls as follows.

■ INPUT SECTION

- Input Selector Switch : At "MIC" position
- Input Trim Control : At "10" on scale
- EQ On Switch : At off position
- Input Fader : At "0 dB" on scale
- Channel On Switch : At on position
- Program Bus Assign Switch : Set the L-R switch to on
- Monitor/Effect Select Switch : At "EFF" position
- PRE/POST Select Switch : At "post" position
- MONI/EFF Level Control : At "10" on scale
- SEND Level Control : At "10" on scale

■ MASTER SECTION

- Master Fader : At "0 dB" on scale
- Monitor Level Control : At "10" on scale

■ MONITOR/EFFECT SECTION

- L & B Output Level Control : At "8" on scale
- Control

■ SEND SECTION

- Send Output Level Control : At "8" on scale

- Apply a -60 dB ± 2 dB/1 k Hz signal to the MIC input connector.
- Check the MONI/EFF, CUE SEND, SEND, MONI-TOR and PHONE outputs level while setting the controls as Table 2.

Table 2

INPUT SECTION				MASTER SECTION	OUTPUT							
Pan Control	MONI/EFF Level Control	MONI/EFF Pan Control	Send Control	Monitor Select Switch	MONI/EFF L	MONI/EFF R	CUE SEND	SEND	MONI-TOR L	MONI-TOR R	PHONE L	PHONE R
					+4 dB/10 k Ω		+4 dB/10 k Ω	+4 dB/10 k Ω	+4 dB/10 k Ω		500 mW/8 Ω	
L	"10"	L	"0"	L, R	○		○		○		○	
	"0"		"10"	MONI/EFF	○		○	○	○	○	○	○
R	"10"	R	"0"	L, R		○	○			○		○
	"0"		"10"	SEND			○	○	○	○	○	○

**4. LINE IN → MONI/EFF OUT
 LINE IN → CUE SEND OUT
 LINE IN → SEND OUT
 LINE IN → MONITOR OUT, PHONE OUT**

- Set the Input Selector Switch to "LINE" position and others the same positions as in item 3.
- Apply a -10 dB ± 2 dB/1 k Hz signal to the LINE input jack.
- Check in the same way as in item 1.
- Check all the LINE inputs in the same way.

**5. EFFECT IN → GROUP OUT
 EFFECT IN → MASTER OUT
 EFFECT IN → MONO OUT**

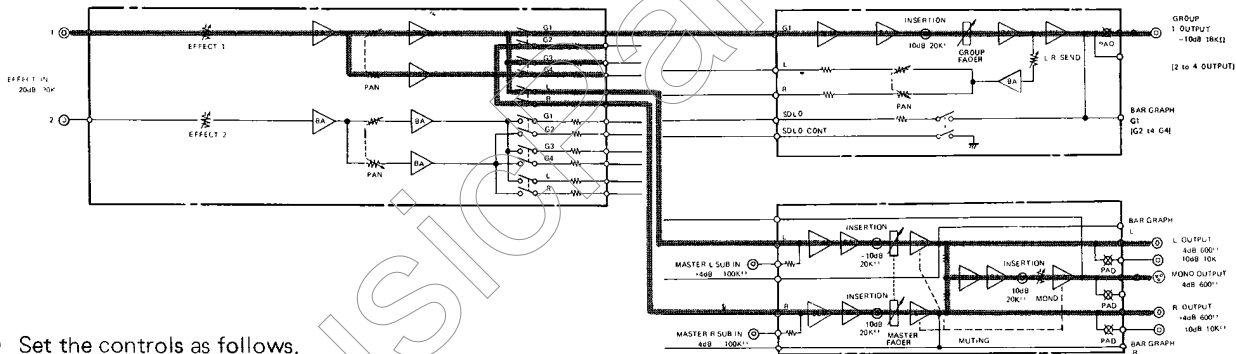

- Set the controls as follows.

■ **EFFECT SECTION**

Effect In Level : At "10" on scale
 Effect In Assign Switch : Set the 1-2, 3-4 and L-R switch to on position

■ **GROUP SECTION**

Group Fader : At "0 dB" on scale
 L-R Send Control : At "0" on scale

■ **MASTER SECTION**

Master Fader : At "0 dB" on scale

- Set the Effect In Pan Control to "1·3·L" position and check that the output levels at GROUP 1/3 are -10 dB with a 10 k ohm load, MASTER L and MONO are +4 dB with a 600 ohm load.
- Set the Effect In Pan Control to "2·4·R" position on the INPUT SECTION and check that the output levels at GROUP 2/4 are -10 dB with a 10 k ohm load, MASTER R and MONO are +4 dB with a 600 ohm load.
- Check all the EFFECT inputs in the same way.

- Apply a -20 dB (±2 dB)/1 k Hz signal to the EFFECT input jack.

6. SOLO

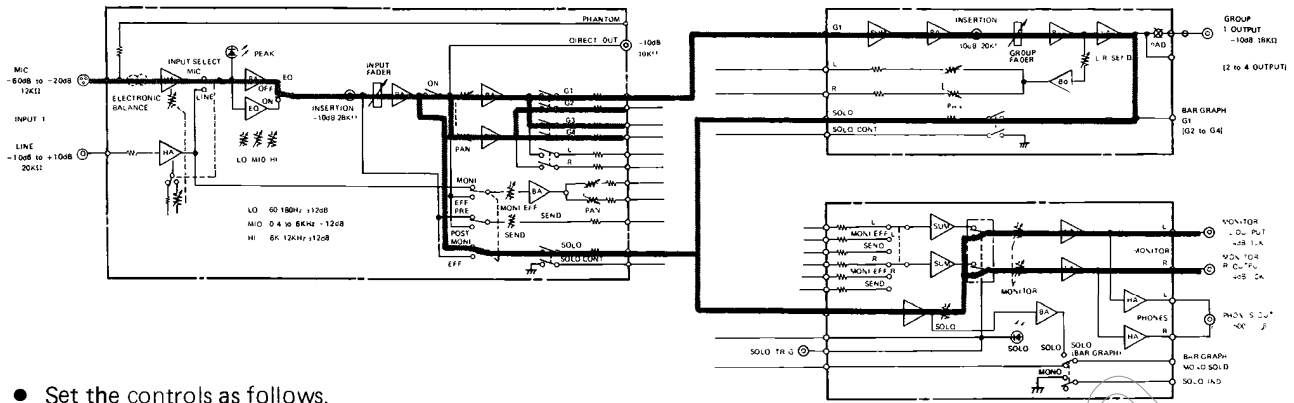

- Set the controls as follows.

■ INPUT SECTION

- Input Selector Switch : At "MIC" position
- Input Trim Control : At "10" on scale
- EQ On Switch : At off position
- Monitor/Effect Select Switch : At "MON" position
- Input Fader : At "0 dB" on scale
- Program Bus Assign Switch : Set the 1-2 and 3-4 switch to on position
- Channel On Switch : At on position

■ GROUP SECTION

- Group Fader : At "0 dB" on scale

■ MASTER SECTION

- Monitor/Solo Level Control : At "10" on scale

- Apply a $-60 \text{ dB} \pm 2 \text{ dB/1 k Hz}$ signal to the MIC input connector.
- Check the MONITOR output level while setting the controls as Table 3.
- Check all the MIC inputs in the same way.

Table 3

INPUT SECTION		GROUP SECTION	MONITOR OUTPUT	SOLO LED
Pan Control	Solo Switch	Solo Switch	—	—
—	ON	OFF	+4 dB with a 10 k ohm load	The Solo LED on the MASTER SECTION is lit
L	OFF	GROUP 1 ON		
		GROUP 3 ON		
R	OFF	GROUP 2 ON		
		GROUP 4 ON		

7. MASTER SUB IN → MASTER OUT

- Set the control as follows.

■ MASTER SECTION

- Master Fader : At "0 dB" on scale
- Apply a $+4 \text{ dB} \pm 2 \text{ dB/1 k Hz}$ signal to the MASTER L SUB IN jack.
- Check that the output level at MASTER L output is $+4 \text{ dB}$ with a 600 ohm load.
- Check MASTER R SUB IN in the same way.

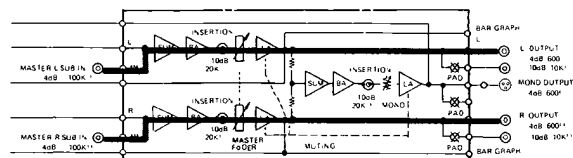

8. MON/EFF SUB IN → MON/EFF OUT SEND SUB IN → SEND OUT

- Set the controls as follows.

■ MONITOR EFFECT SECTION

Monitor/Effect Output

L & R Level Control : At "8" on scale

Send Output Level

Control : At "8" on scale

- Apply a +4 dB ± 2 dB/1 k Hz signal to the MON/EFF L SUB IN jack.
- Check that the output level at MON/EFF L OUTPUT is +4 dB with a 10 k ohm load.
- Check MON/EFF R SUB IN and SEND SUB IN in the same way.

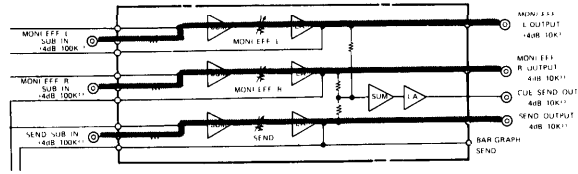

9. OUTPUT METER

- Set the controls as follows.

■ INPUT SECTION

Input Selector Switch : MIC

Input Trim Control : At "10" on scale

EQ On Switch : At off position

Input Fader : At "0 dB" on scale

Channel On Switch : At on position

■ GROUP SECTION

Group Master Fader : At "0 dB" on scale

- Apply a -60 dB (±2 dB)/1 k Hz signal to the MIC IN connector and set the GROUP OUT 1 to 4 level to -10 dB with a 10 k ohm load while setting the controls as Table 4.

Table 4

INPUT SECTION		METER SELECT SWITCH	OUTPUT
Program Bus Assign Switch	Pan Control		
1-2	1-3-L	1CH	GROUP 1
	2-4-R	2CH	GROUP 2
3-4	1-3-L	3CH	GROUP 3
	2-4-R	4CH	GROUP 4

- Check that the 0 dB (Green) of the BAR GRAPH lights. If the LED goes on at incorrect level, adjust VR611.
- Check all the Group outputs in the same way.
- Then set the GROUP OUT level as Table 5, and check that the LED goes on depending upon the GROUP OUT level.

NOTE:

0 dB on the Solo meter corresponds to -10 dB output. To correspond 0 dB on the meter to +4 dB output, change R433 10 k ohms to 51 k ohms on Master Section circuit board.

Table 5

GROUP OUT LEVEL	LED
-2 dB ± 2 dB	" +8 dB " on scale
-5 dB ± 1.5 dB	" +5 dB " on scale
-7 dB ± 1.5 dB	" +3 dB " on scale
-9 dB ± 1.0 dB	" +1 dB " on scale
-10 dB ± 0.5 dB	" 0 dB " on scale
-13 dB ± 1.5 dB	" -1 dB " on scale
-17 dB ± 1.5 dB	" -3 dB " on scale
-17 dB ± 1.5 dB	" -5 dB " on scale
-17 dB ± 1.5 dB	" -7 dB " on scale
-25 dB ± 2.0 dB	" -10 dB " on scale
-25 dB ± 2.0 dB	" -15 dB " on scale
-25 dB ± 2.0 dB	" -20 dB " on scale

Bar Graph Circuit Board (Component side view)

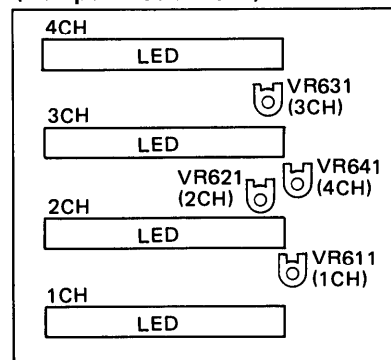

TYPICAL PERFORMANCE

Total Harmonic Distortion [MIC Input]

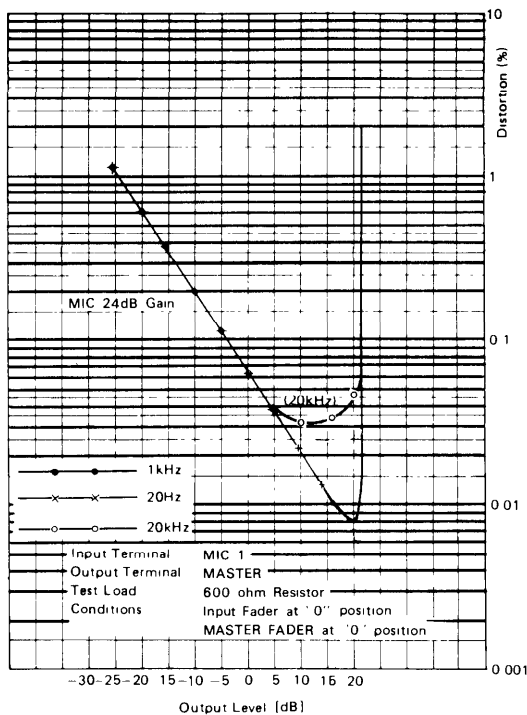

Total Harmonic Distortion [LINE Input]

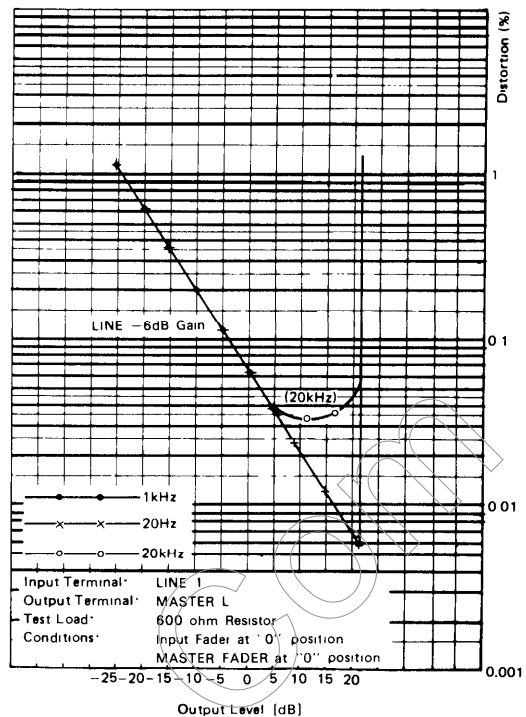

Input Equalizer

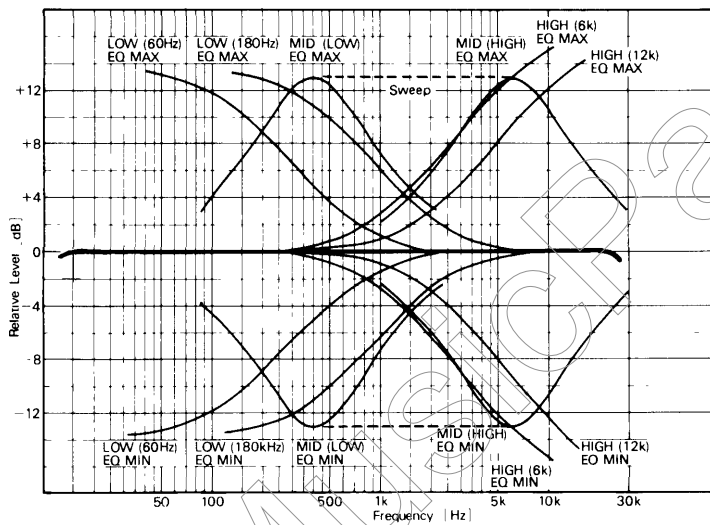

Frequency Response

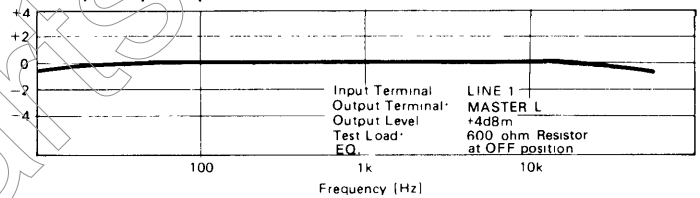

TERMINAL GUIDE

IC

YWTA7220P

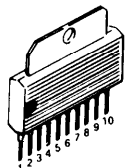

YWHA1374

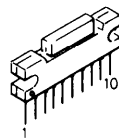

YWNJM4560DD

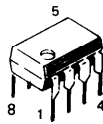

TRANSISTOR

2SC828
2SC828A
2SC2557
2SA720
2SA564A
2SK128



2SB751A

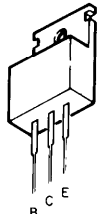

DIODE

MA150TA
XZ162
EM1Z

RB152F

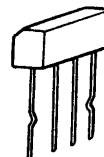

Cathode



Anode

LN21RPH
LN31GPH

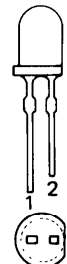

1 : Anode
2 : Cathode

CIRCUIT BOARD AND WIRING CONNECTION DIAGRAM OF WR-8112 AND WR-8118

- VIEW FROM COMPONENTS SIDE -

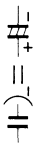

INPUT CIRCUIT BOARD (YWAPRBO167C1)

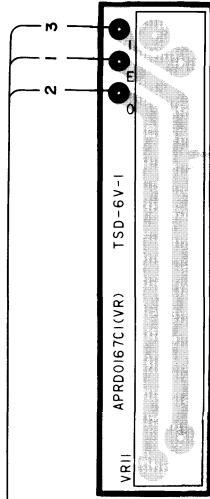
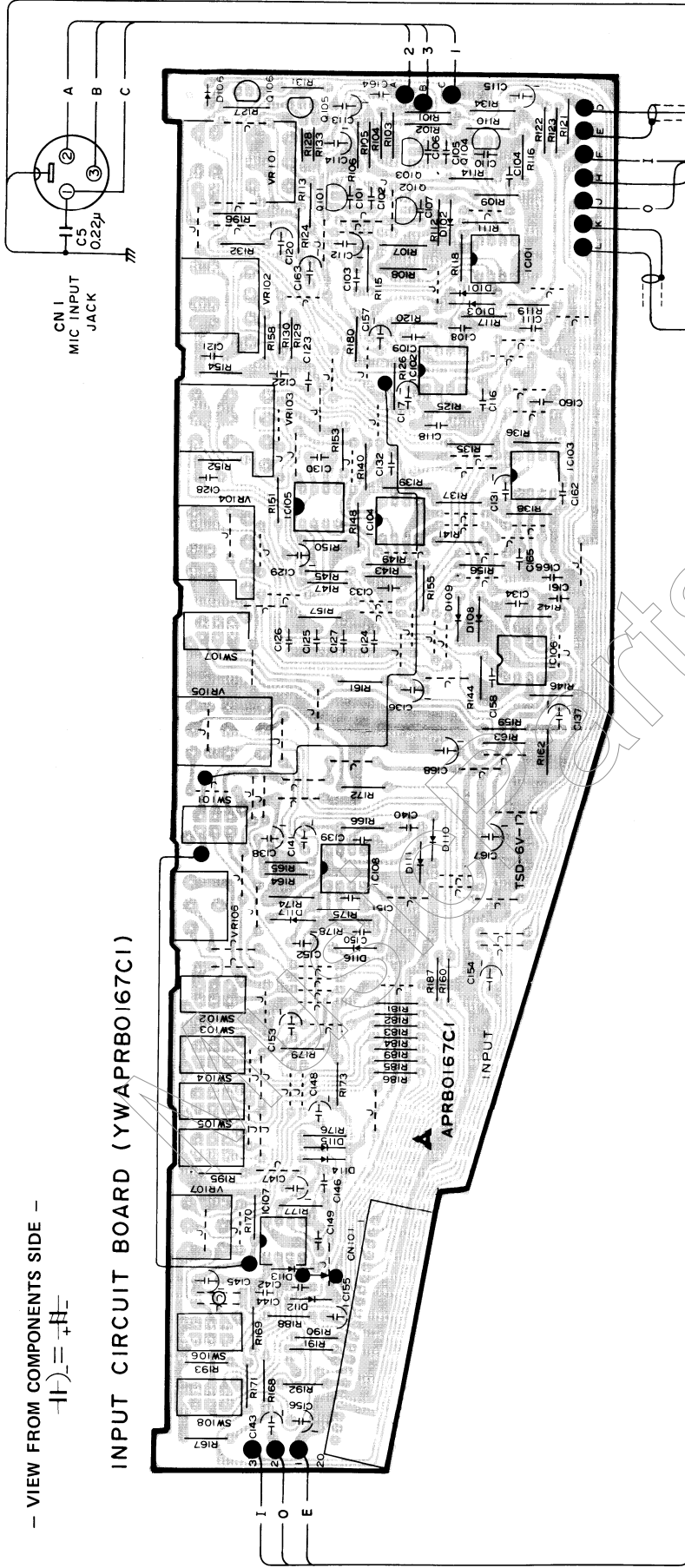

INPUT FADER BOARD
(YWAPRDO167C1)

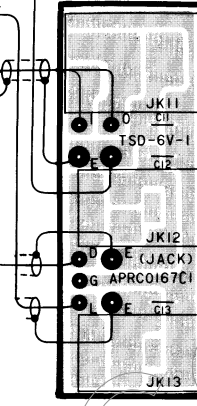

INPUT JACK BOARD
(YWAPRCO167C1)

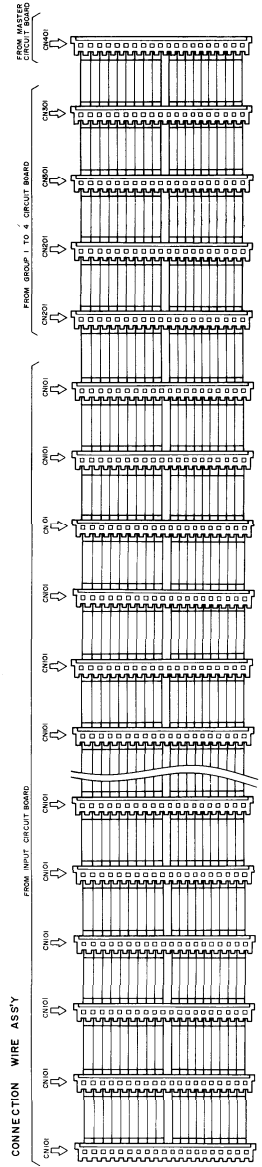

Note: In WR-8112, this circuit board is used at the production line from serial numbers 82X0001 and after. Please refer to the service manual of WR-8112 (AVD-8206-034) for the products whose serial numbers are 829□□□□ and before.

SCHEMATIC DIAGRAM OF WR-8112 AND WR-8118

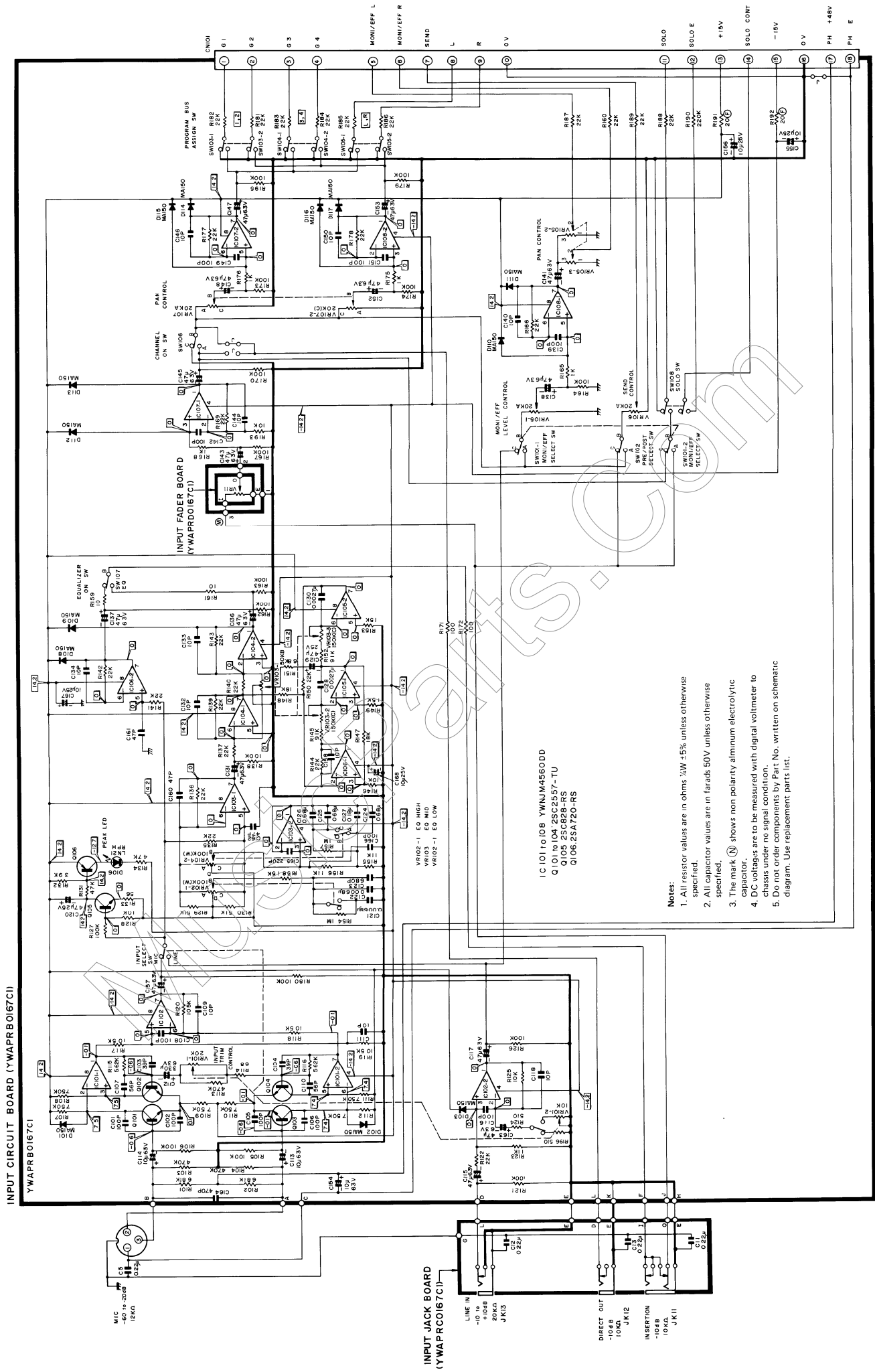

INPUT JACK BOARD (YWAPR0167C1)

YWAPR0167C1

INPUT FADER BOARD (YWAPR0167C1)

YVAPR0167C1

- IC 101 10108 YMNJ4660DD
- Q 101 to 104 25C2557-TU
- Q 105 25C828-RS
- Q 106 25A720-RS

- Notes:**
1. All resistor values are in ohms $\frac{1}{2}$ W $\pm 5\%$ unless otherwise specified.
 2. All capacitor values are in farads 50V unless otherwise specified.
 3. The mark $\text{\textcircled{N}}$ shows non polarity aluminum electrolytic capacitor.
 4. DC voltages are to be measured with digital voltmeter to chassis under no signal condition.
 5. Do not order components by Part No. written on schematic diagram. Use replacement parts list.

CIRCUIT BOARD AND WIRING CONNECTION DIAGRAM OF WR-8112 AND WR-8118

— VIEW FROM COMPONENTS SIDE —

$\text{---} \text{---} \text{---} \text{---} \text{---} \text{---}$

GROUP 1, 2 JACK BOARD
(YWAPRC0168B1)

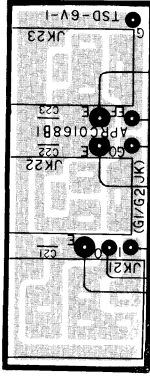

GROUP 1, 2 CIRCUIT BOARD
(YWAPRBO168B1)

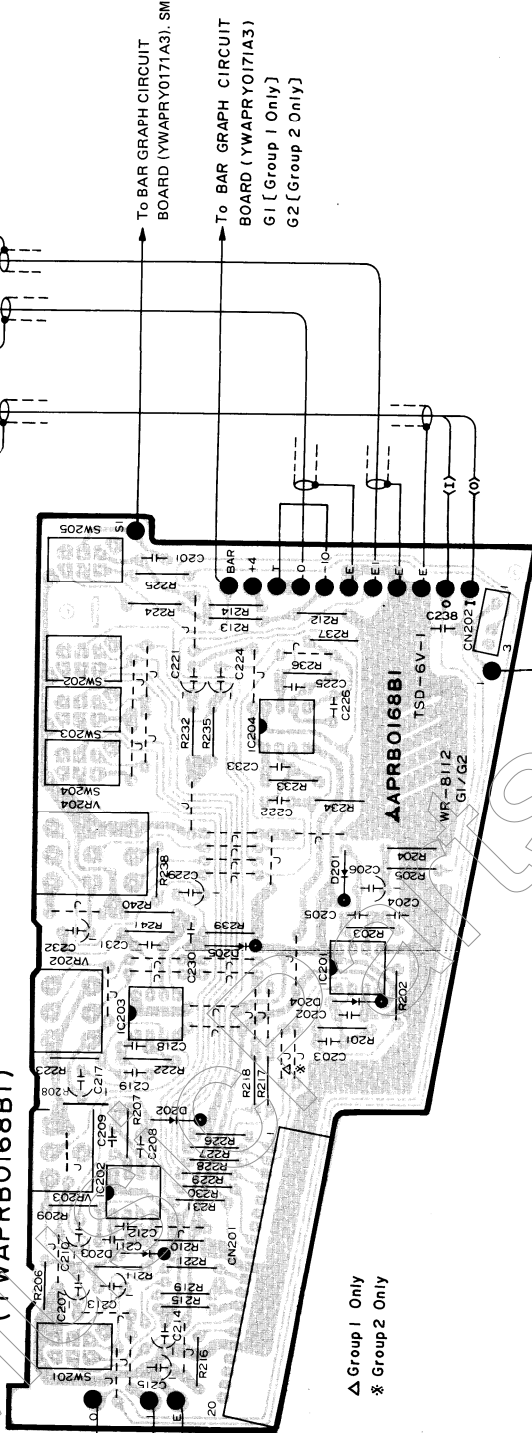

△ Group 1 Only
* Group 2 Only

To GROUP 1 CIRCUIT BOARD
(YWAPRBO168B1) . 1
[Group 2 Only]

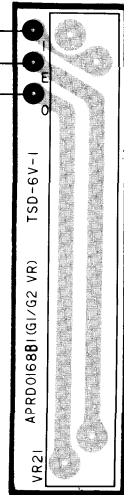

GROUP 1, 2 FADER BOARD
(YWAPRDO168B1)

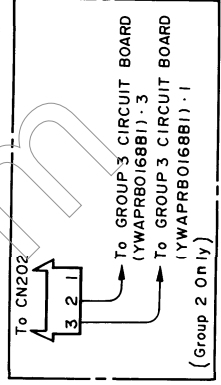
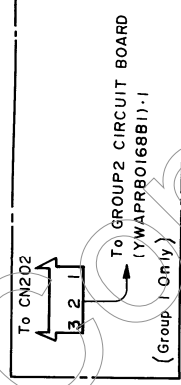

Note: In WR-8112, this circuit board is used at the production line from serial numbers 82X0001 and after. Please refer to the service manual of WR-8112 (AVD-8206-034) for the products whose serial numbers are 829□□□□ and before.

SCHEMATIC DIAGRAM OF WR-8112 AND WR-8118
GROUP 1,2 CIRCUIT BOARD (YWAPR0168BI)

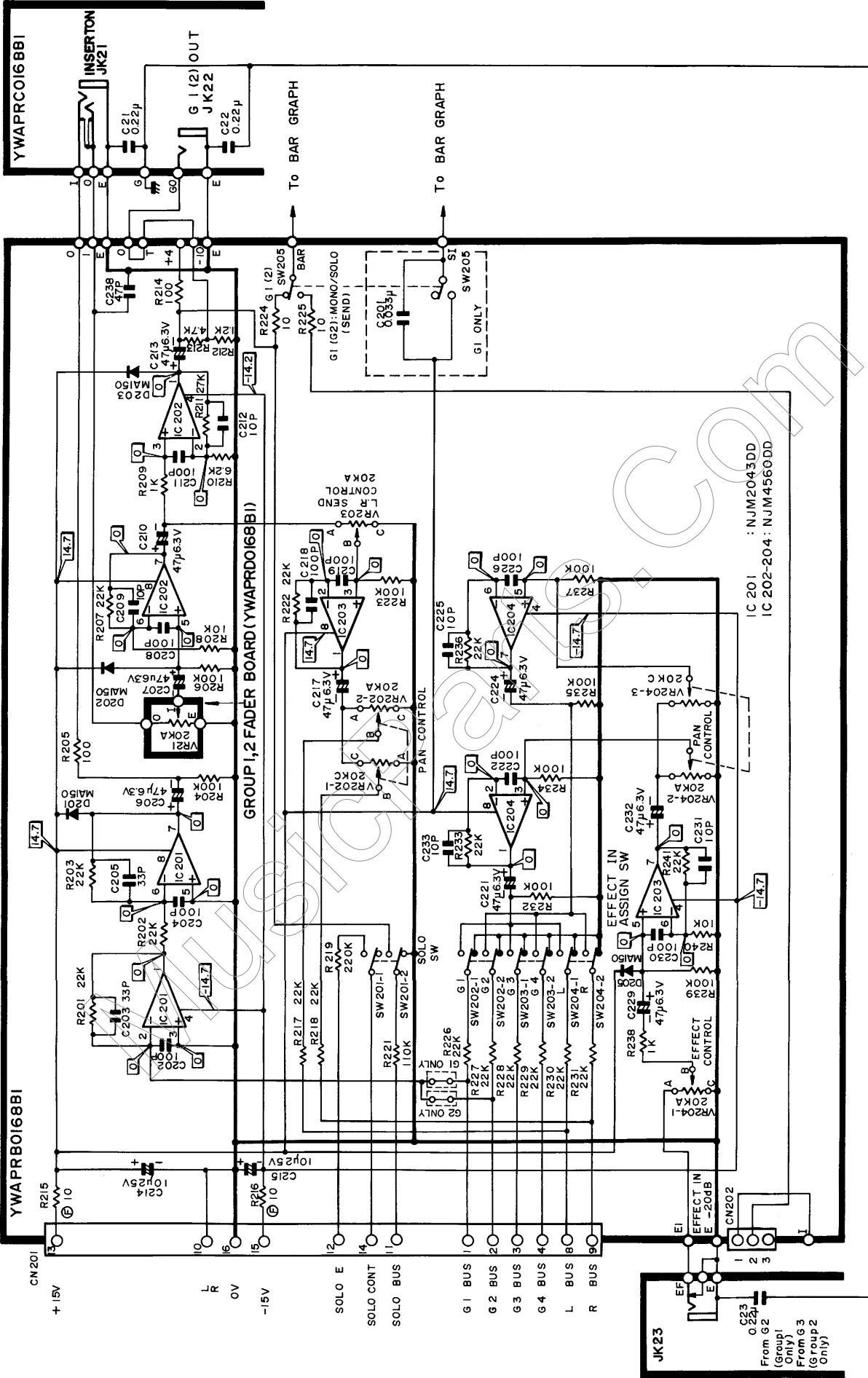

Note:
 1. Resistor values are in ohms, $\frac{1}{2}$ W, 5% unless otherwise specified.
 2. All capacitor values are in farads, 50V unless otherwise specified.
 3. The mark $\text{\textcircled{R}}$ shows non polarity aluminum electrolytic capacitor.
 4. DC voltages are to be measured with digital voltmeter to 0.1% accuracy.
 5. Do not order components by Part No. written on schematic diagram. Use replacement parts list.

CIRCUIT BOARD AND WIRING CONNECTION DIAGRAM OF WR-8112 AND WR-8118 GROUP 3 JACK BOARD (YWAPRFO168BI)

— VIEW FROM COMPONENTS SIDE —

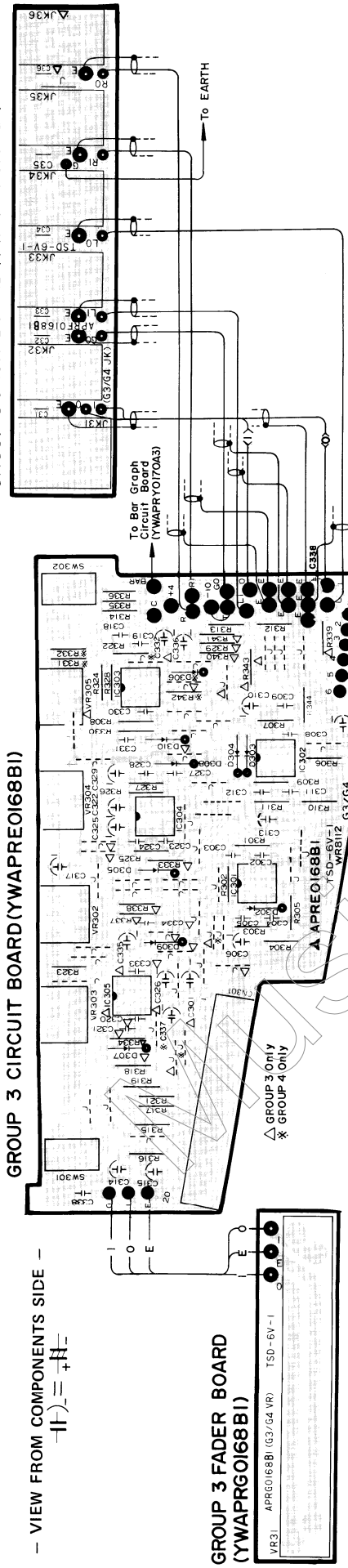
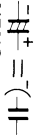

GROUP 3 FADER BOARD (YWAPRGO168BI)

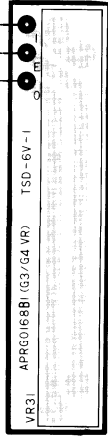

GROUP 4 JACK BOARD (YWAPRFO168BI)

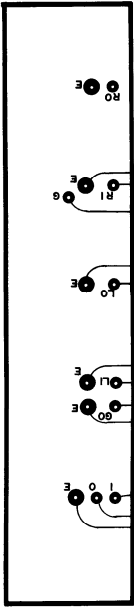

GROUP 4 CIRCUIT BOARD (YWAPRGO168BI)

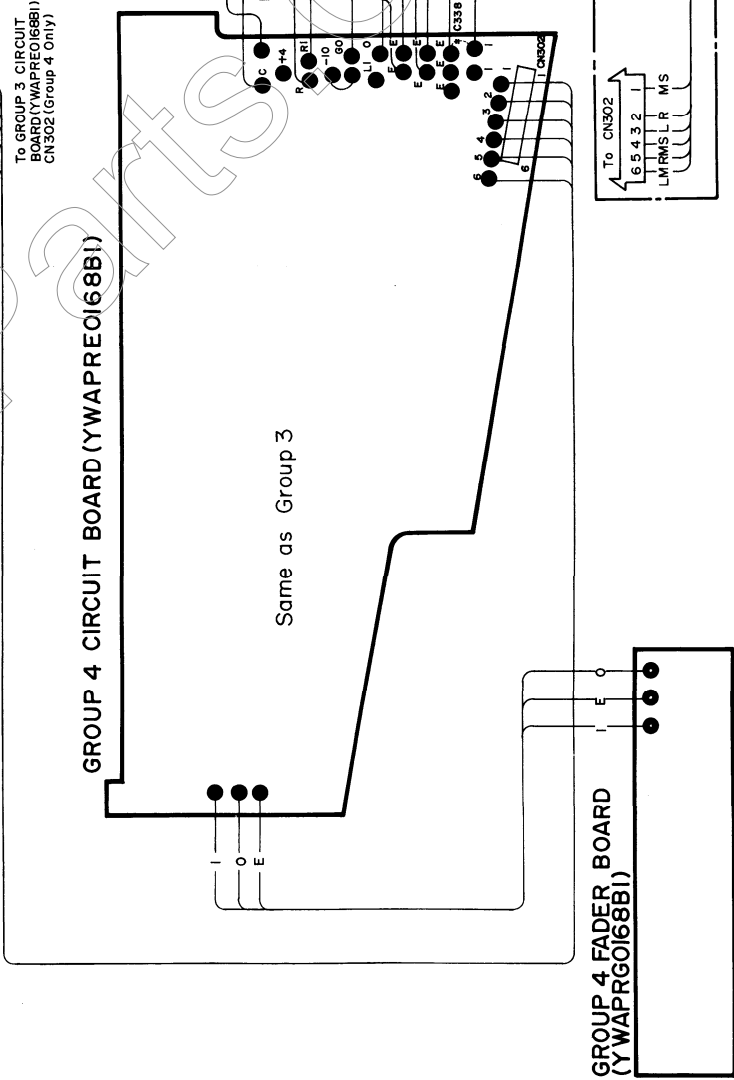

GROUP 4 FADER BOARD (YWAPRGO168BI)

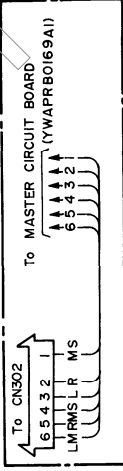
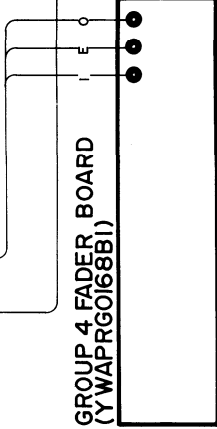

Note: In WR-8112, this circuit board is used at the production line from serial numbers 82X0001 and after. Please refer to the service manual of WR-8112 (AVD-8206-034) for the products whose serial numbers are 829□□□□ and before.

SCHEMATIC DIAGRAM OF WR-8112 AND WR-8118

GROUP 3,4 JACK BOARD
(YWAPRFO168BI)

GROUP 3,4 CIRCUIT BOARD (YWAPREO168BI)

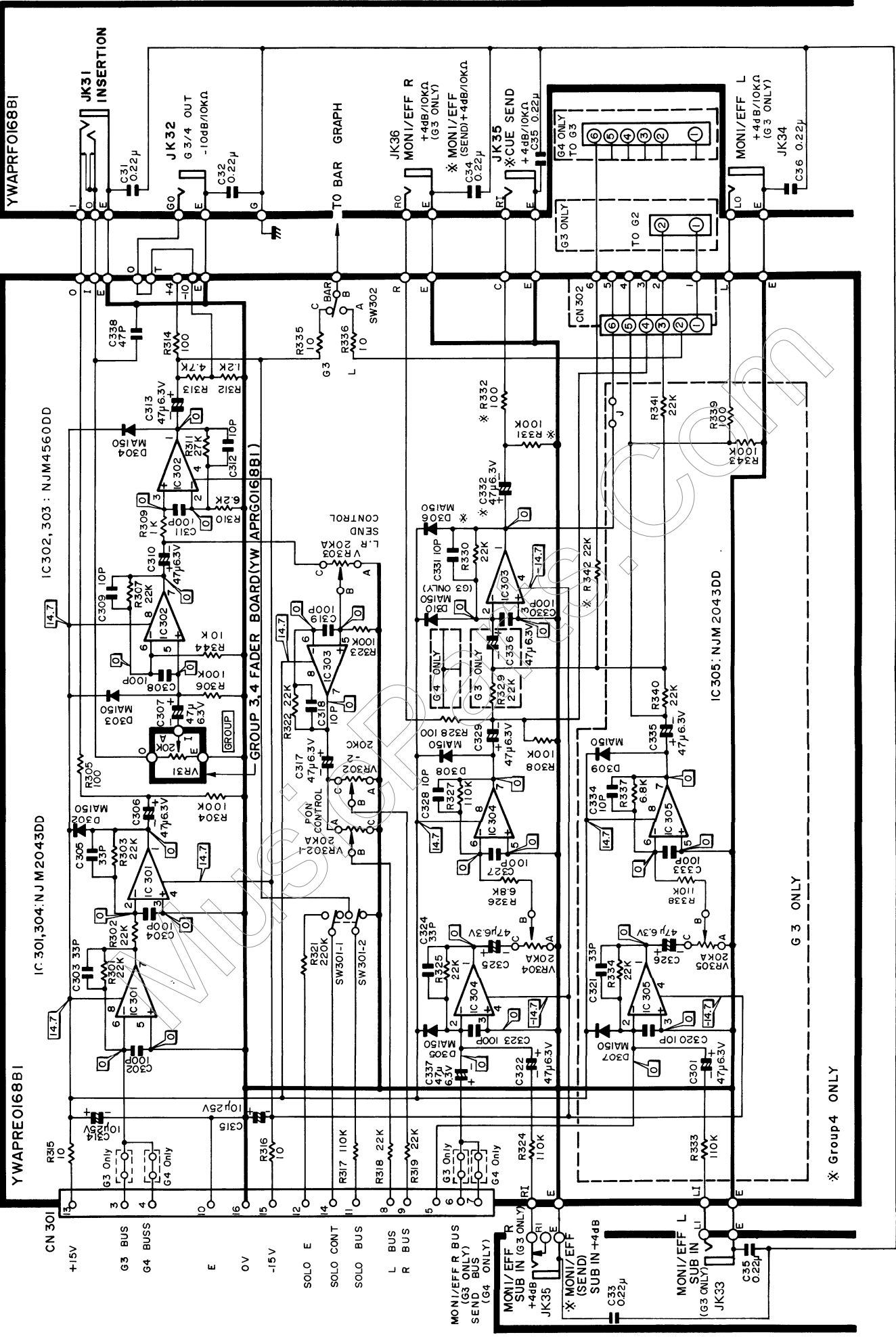

- Notes:
1. All resistor values are in ohms $\pm 5\%$ unless otherwise specified.
 2. All capacitor values are in farads: 50V unless otherwise specified.
 3. The mark $\text{\textcircled{X}}$ shows non polarity aluminum electrolytic capacitor.
 4. DC voltages are to be measured with digital voltmeter to chassis under no signal condition.
 5. Do not order components by Part No. written on schematic diagram. Use replacement parts list.

CIRCUIT BOARD AND WIRING CONNECTION DIAGRAM OF WR-8112 AND WR-8118

— VIEW FROM COMPONENTS SIDE —

$\text{---} \text{---} \text{---} \text{---}$

MASTER L,R FADER BOARD
(YWAPRH0169A1)

MASTER R JACK BOARD
(YWAPRE0169A1)

MASTER L JACK BOARD
(YWAPRD0169A1)

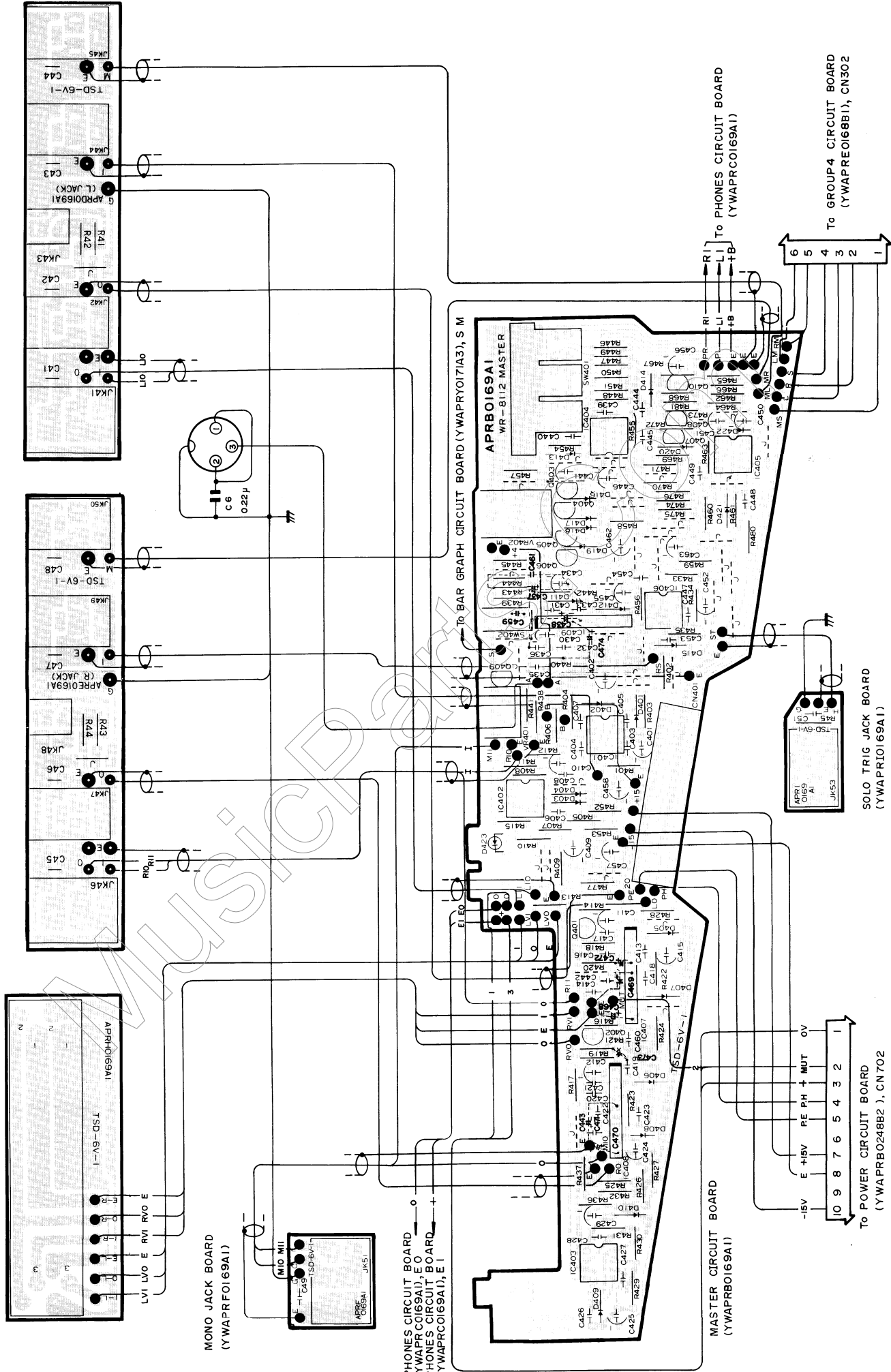

To PHONES CIRCUIT BOARD
(YWAPRC0169A1), E 0
To PHONES CIRCUIT BOARD
(YWAPRC0169A1), E 1

To POWER CIRCUIT BOARD
(YWAPRB0248B2), CN 702

SOLO TRIG JACK BOARD
(YWAPR0169A1)

SCHEMATIC DIAGRAM OF WR-8112 AND WR-8118

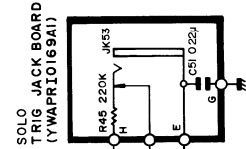
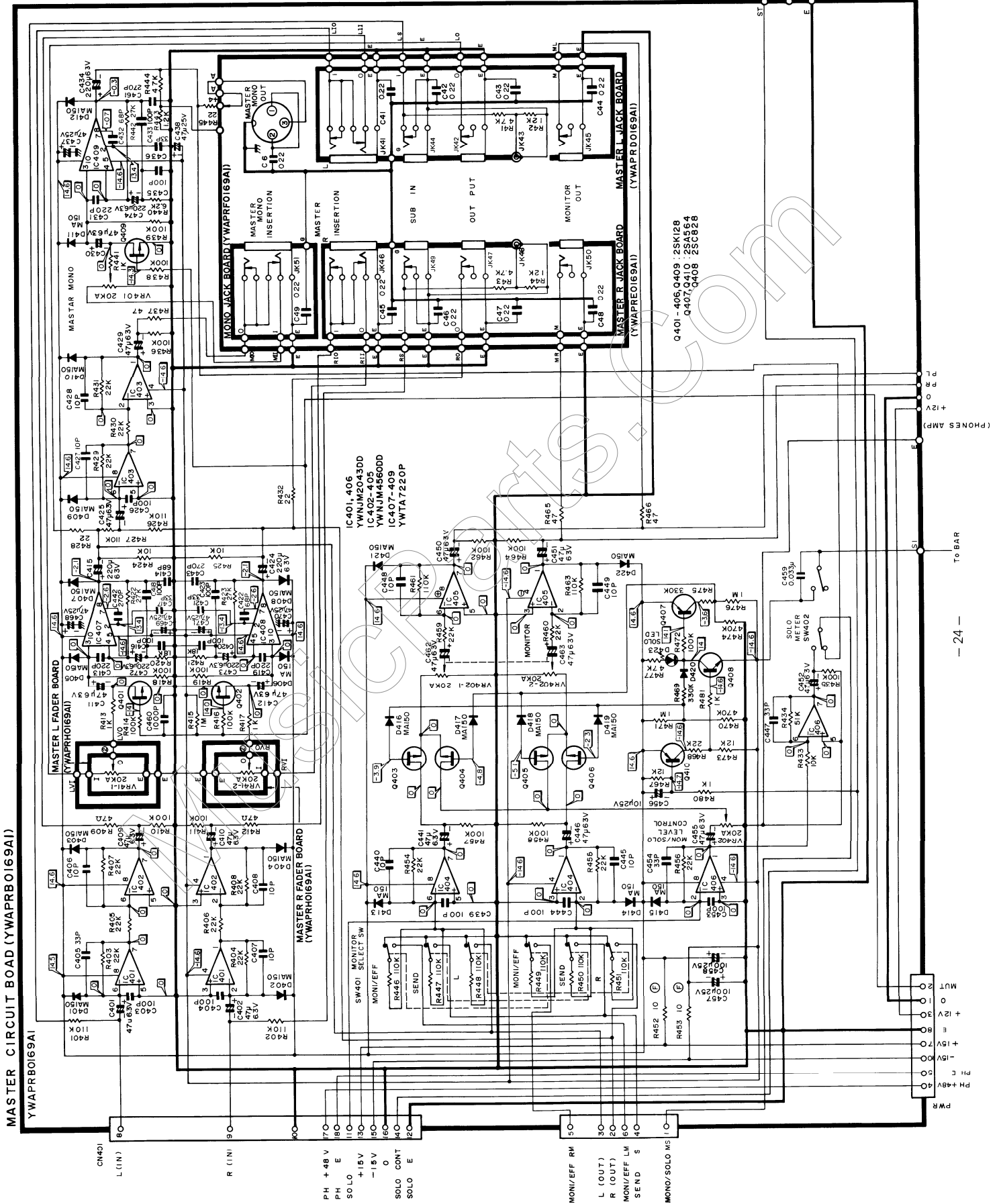

CIRCUIT BOARD AND WIRING CONNECTION AND SCHEMATIC DIAGRAM OF WR-8112 AND WR-8118

— VIEW FROM COMPONENTS SIDE —

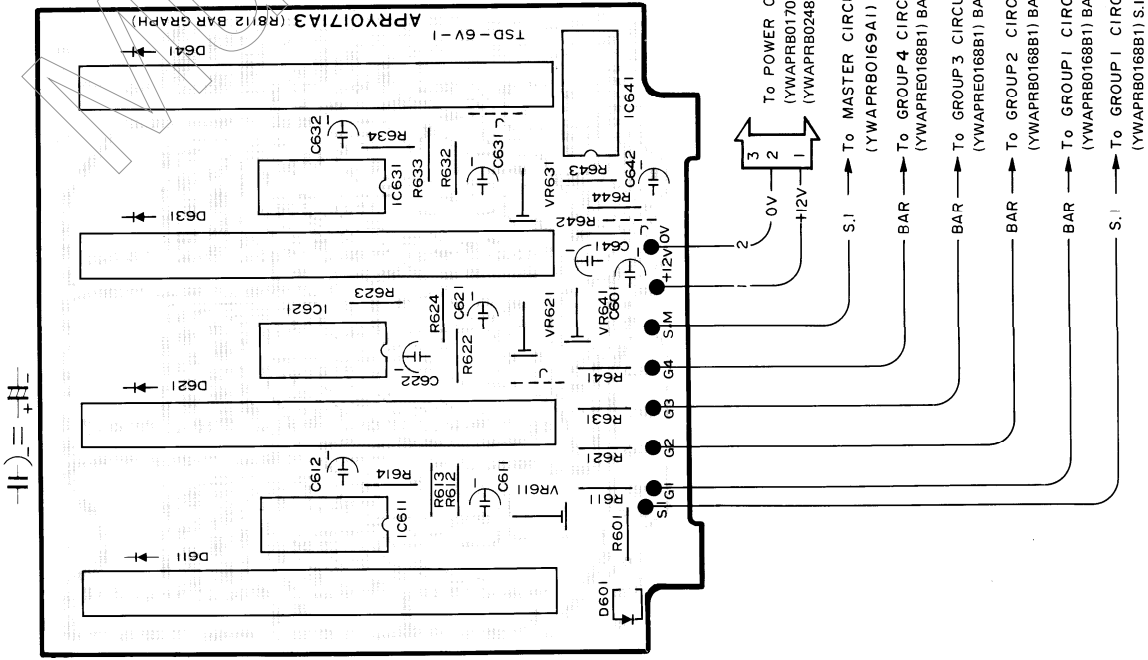

BAR GRAPH CIRCUIT BOARD (YWAPRY017IA3)

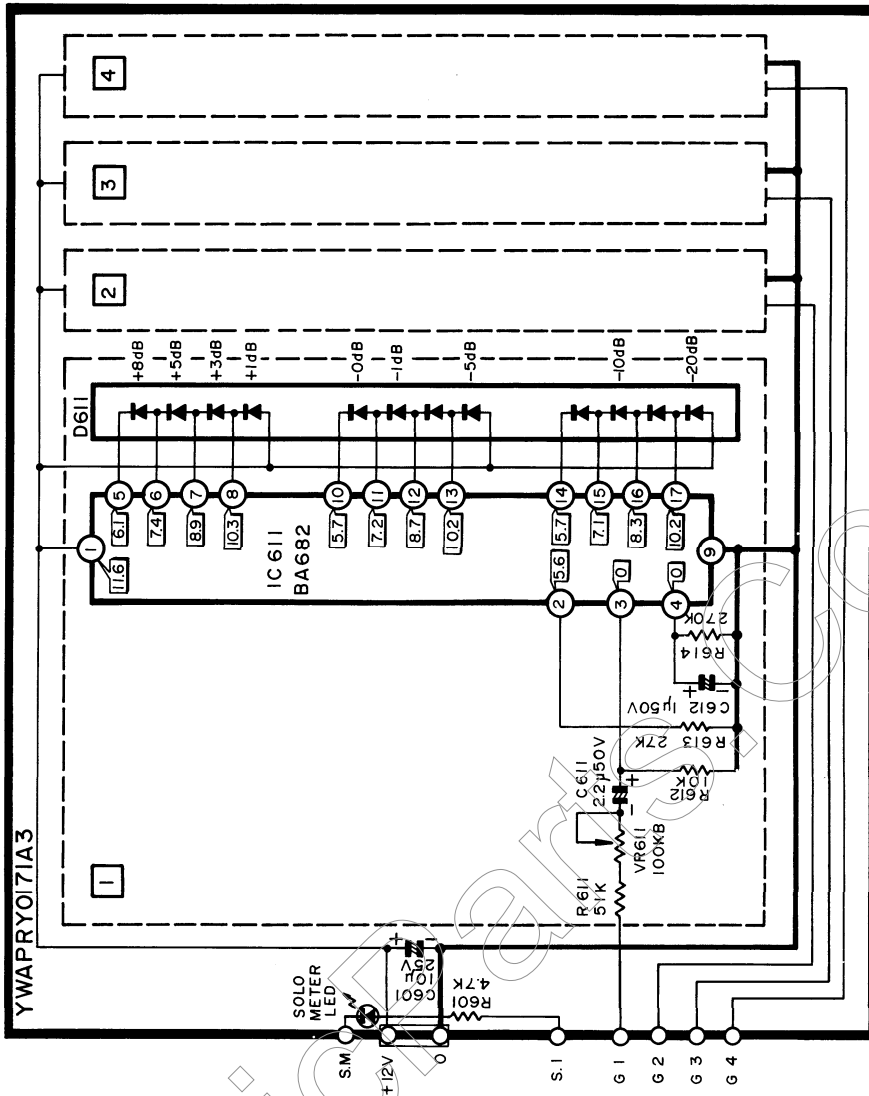

CIRCUIT BOARD AND WIRING CONNECTION AND SCHEMATIC DIAGRAM OF WR-8112 AND WR-8118

- VIEW FROM COMPONENTS SIDE -

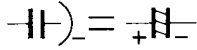

**PHONES CIRCUIT BOARD
(YWAPRC0169A1)**

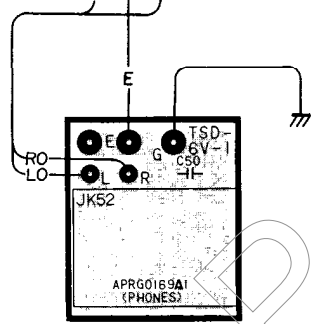
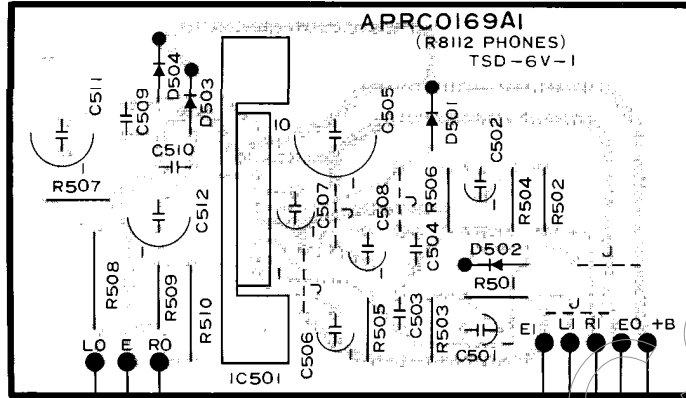

**PHONES JACK BOARD
(YWAPRG0169A1)**

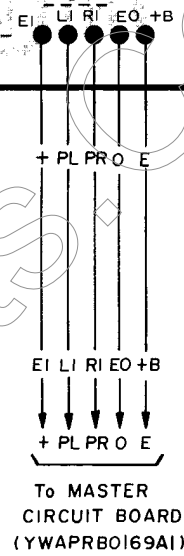

PHONES CIRCUIT BOARD (YWAPRC0169A1)

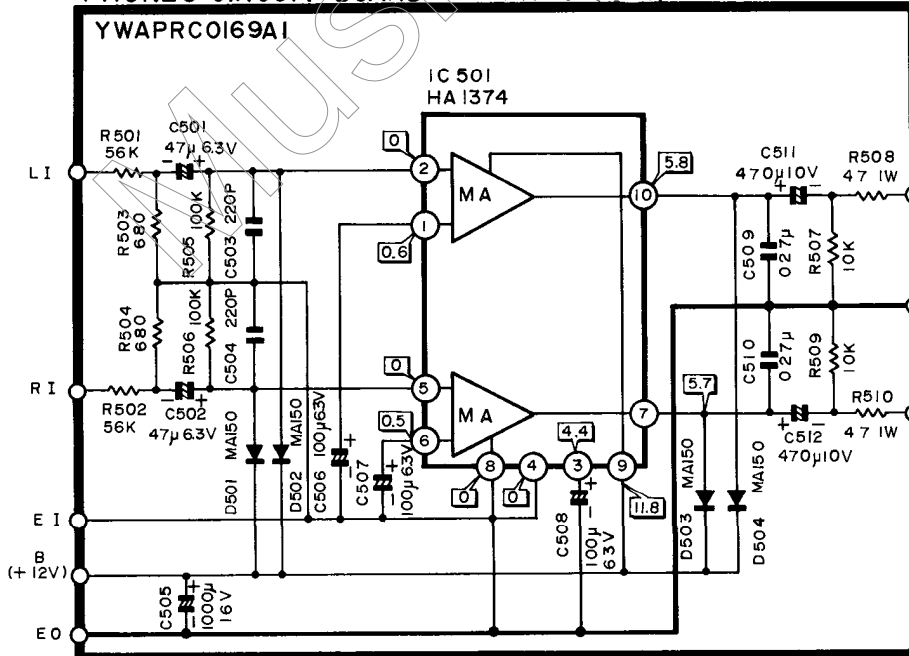

**PHONES JACK BOARD
(YWAPRG0169A1)**

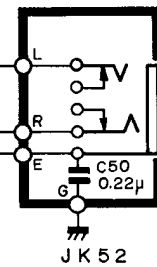

CIRCUIT BOARD AND WIRING CONNECTION DIAGRAM OF WR-8112

— VIEW FROM COMPONENTS SIDE —

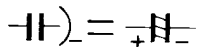

LED BOARD
(YWAPRDO170A3)

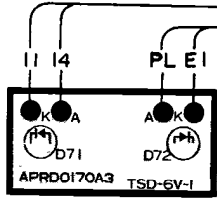

PHANTOM SWITCH BOARD
(YWAPRCO170A3)

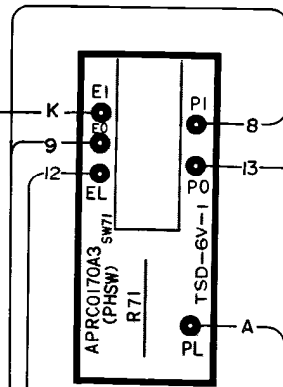

POWER CIRCUIT BOARD
(YWAPRBO170A3)

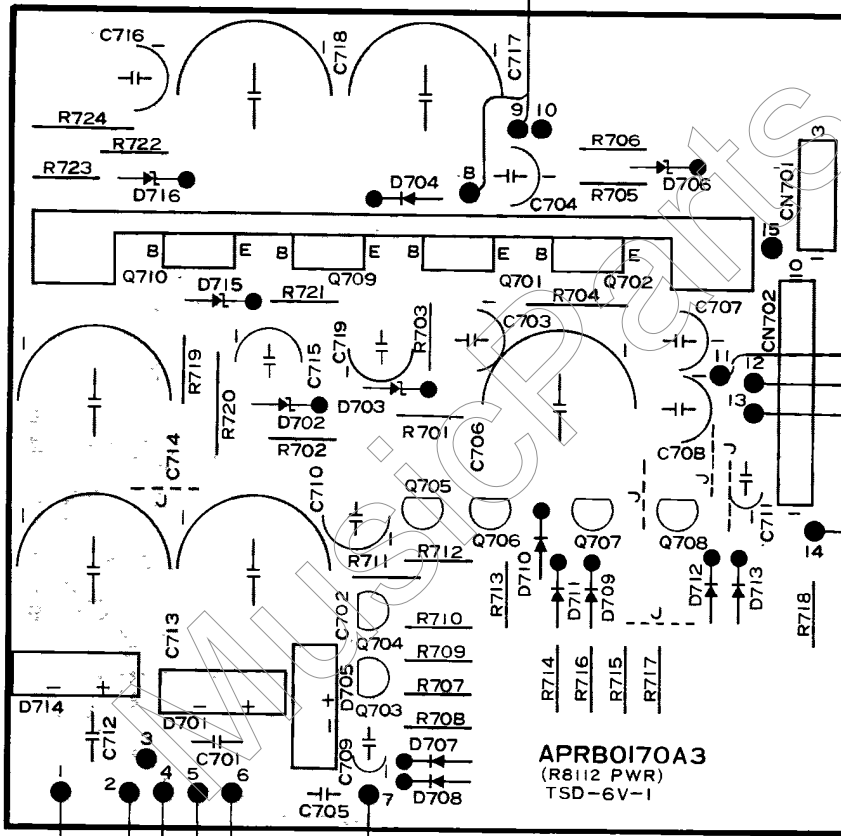

To POWER TRANSFORMER
(HPE166U70)

To MASTER CIRCUIT BOARD
(YWAPRBO169A1)

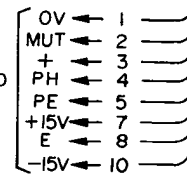
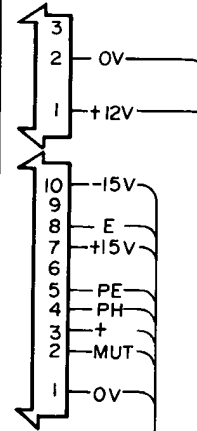

Note: These circuit boards are used only for WR-8112.

To BAR GRAPH CIRCUIT BOARD
(YWAPRYO171A3)

SCHEMATIC DIAGRAM OF WR-8112

PHANTOM SWITCH BOARD (YWAPRC0170A3)
LED BOARD (YWAPRD170A3)

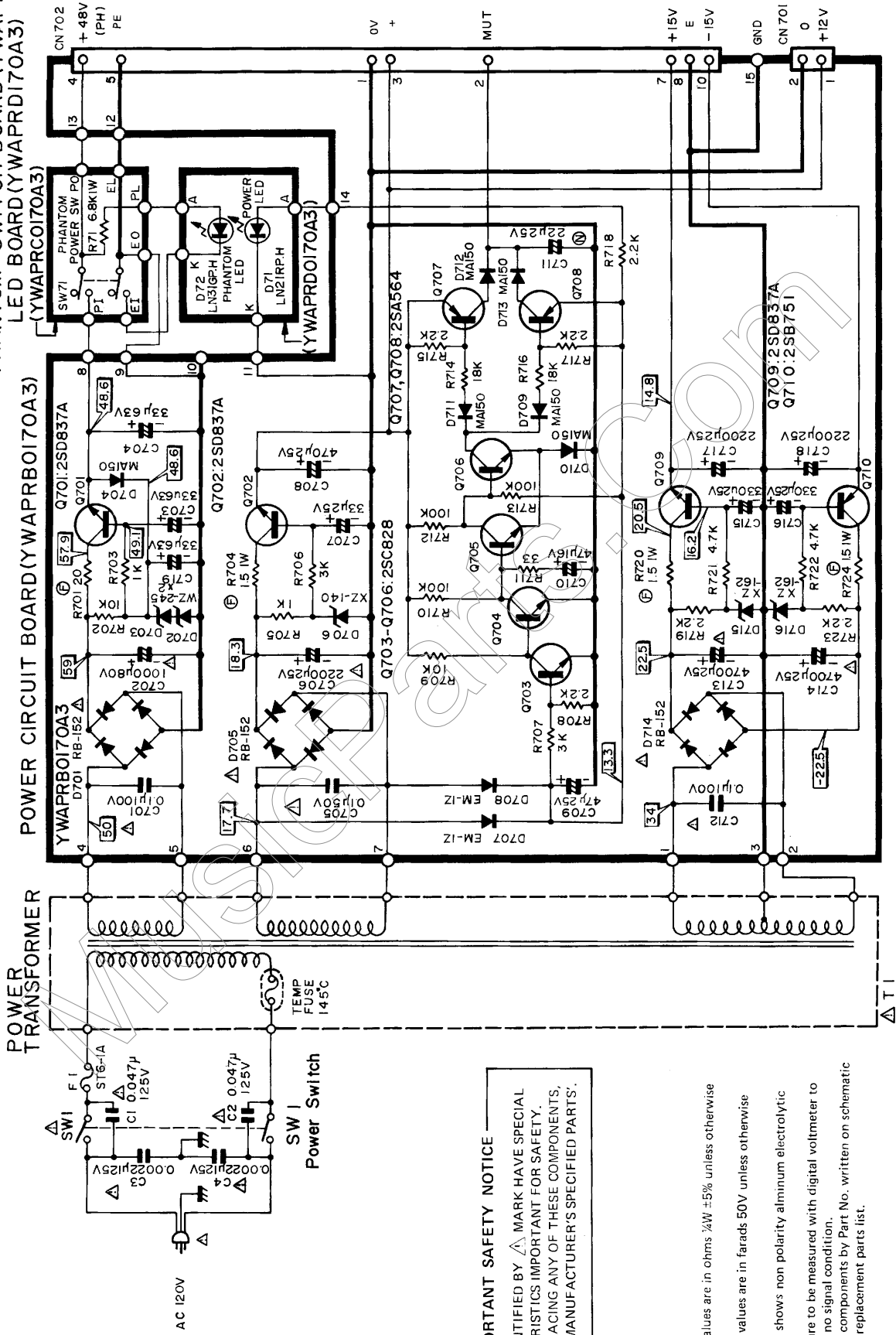

IMPORTANT SAFETY NOTICE
PARTS IDENTIFIED BY Δ MARK HAVE SPECIAL CHARACTERISTICS IMPORTANT FOR SAFETY. WHEN REPLACING ANY OF THESE COMPONENTS, USE ONLY MANUFACTURER'S SPECIFIED PARTS.

- Notes:**
1. All resistor values are in ohms $\frac{1}{4}W \pm 5\%$ unless otherwise specified.
 2. All capacitor values are in farads 50V unless otherwise specified.
 3. The mark (N) shows non polarity aluminum electrolytic capacitor.
 4. DC voltages are to be measured with digital voltmeter to chassis under no signal condition.
 5. Do not order components by Part No. written on schematic diagram. Use replacement parts list.

SCHEMATIC DIAGRAM OF WR-8118

PHANTOM SWITCH CIRCUIT BOARD
(YWA PRE0248B2)



POWER CIRCUIT BOARD
(YWAPRB0248B2)

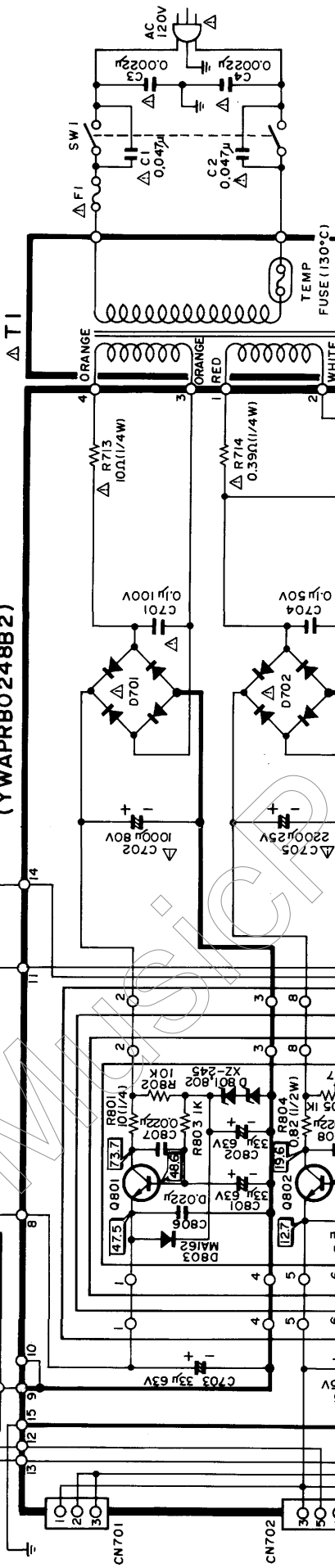

POWER CONTROL
CIRCUIT BOARD
(YWA PRCO248B2)

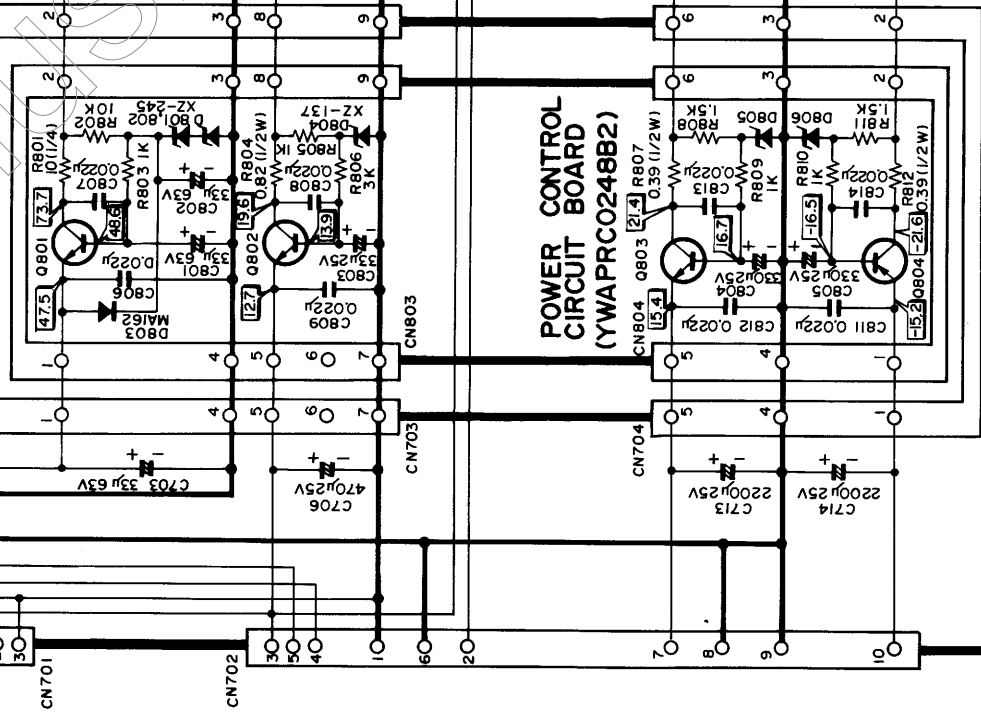

BRIDGE DIODE CIRCUIT BOARD
(YWAPRD0248B2)

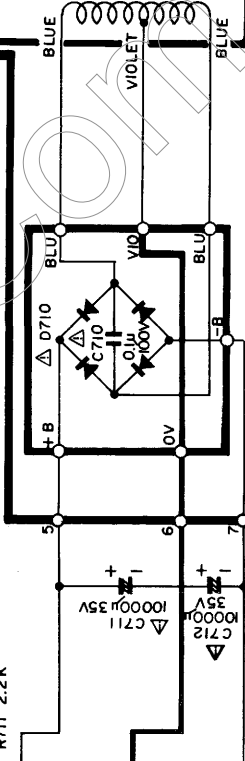

- D701, 702 : RB-152
- Q701 to 704 : 2SC828X4
- Q705, 706 : 2SA564 X2
- Q801, 802, 803 : 2SD837AX2
- Q804 : 2SB751A
- D805, 806 : XZ-170
- D710 : RB-402

IMPORTANT SAFETY NOTICE
PARTS IDENTIFIED BY Δ MARK HAVE SPECIAL CHARACTERISTICS IMPORTANT FOR SAFETY. WHEN REPLACING ANY OF THESE COMPONENTS, USE ONLY MANUFACTURER'S SPECIFIED PARTS.

- Note:**
1. All resistor values are in ohms, μ W, 5% unless otherwise specified.
 2. All capacitor values are in farads 50V unless otherwise specified.
 3. The mark Δ shows non polarity aluminum electrolytic capacitor.
 4. DC voltages are to be measured with digital voltmeter to signal common.
 5. Do not order components unless they are written on schematic diagram. Use replacement parts list.

CIRCUIT BOARD AND WIRING CONNECTION DIAGRAM OF WR-8118

— VIEW FROM COMPONENTS SIDE —

$$-||- = +||-$$

POWER CIRCUIT BOARD (YWAPRBO248B2)

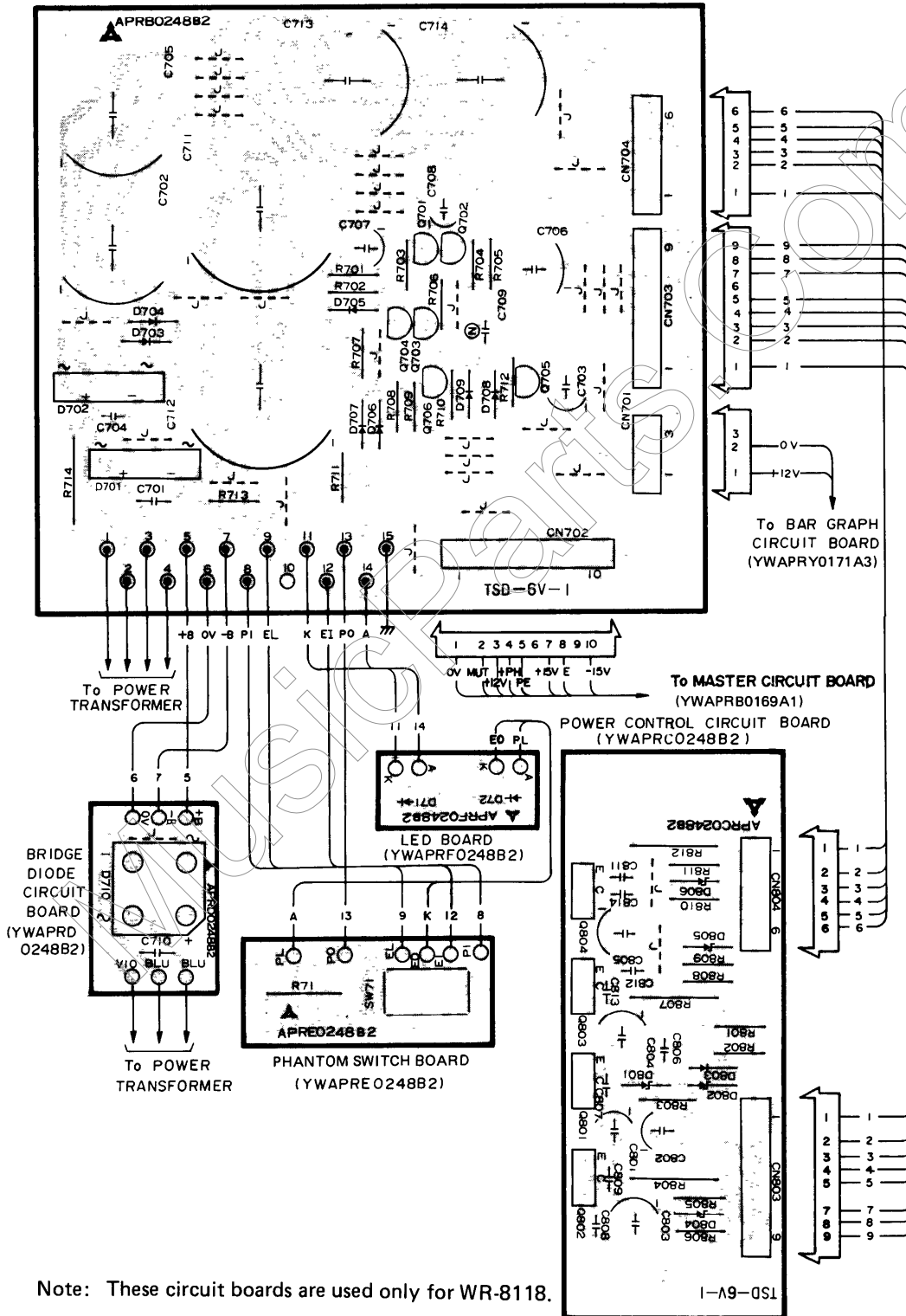

Note: These circuit boards are used only for WR-8118.

REPLACEMENT PARTS LIST

Important Notice

- Components identified by Δ mark have special characteristics important for safety.
When replacing any of these components, use only manufacturer's specified parts.
- Components identified by * mark are new parts used from this model.

MODEL WR-8112, WR-8118

SYMBOL NO.	PART NO.	DESCRIPTION	SYMBOL NO.	PART NO.	DESCRIPTION
MISCELLANEOUS			M17	YWS5RA0003B3	Slide Knob (Gray)
C1,2 Δ	ECQU1A473KD	Polyester (x2) 0.047 μ F 125V	M18	YWS5RA0008B3	Knob (X63: WR-8112 only) (X93: WR-8118 only)
C3,4 Δ	ECKFEL222ZE	Ceramic (x2) 2.200pF 125V	M19	YWS5RA0009B3	ϕ 11 Knob (White) (X13: WR-8112 only) (X19: WR-8118 only)
C5	ECQV05224JZ	Polyester 0.22 μ F 50V	M20	YWS5RA0010A3	ϕ 14 Knob (White) (X17: WR-8112 only) (X23: WR-8118 only)
C14-17(x3)	ECQV05224JZ	Polyester (x4) 0.22 μ F 50V [WR-8112 only]	M21	YWS5RB0010A3	Knob (Gray) (x4)
C14,15(x5)	ECQV05224JZ	Polyester (x2) 0.22 μ F 50V [WR-8118 only]	M22	YWS5RC0009B3	ϕ 1 Knob (Yellow) (x34: WR-8112 only) (x54: WR-8118 only)
C16,17(x4)	ECQV05224JZ	Polyester (x2) 0.22 μ F 50V [WR-8118 only]	M23	YWS5RD0010A3	ϕ 14 Knob (Blue) (X13: WR-8112 only) (X19: WR-8118 only)
T1 Δ {	YWHPE166U70	Power Transformer [WR-8112 only]	M24	YWS5RE0009B3	ϕ 11 Knob (Green) (X14: WR-8112 only) (X20: WR-8118 only)
SW1 Δ	ESB-70222T	Power Transformer [WR-8118 only]	M25	YWS5RE0010A3	ϕ 14 Knob (Green) (x2)
F1 Δ {	YWST6-1A	Fuse 1A [WR-8112 only]	M26	YWA E6UB10	Serial No. Label
CN1-JM	YWFM-3-32	Fuse, 1.25A [WR-8118 only]	M27	YWBM90HR02B	Knob for Power Switch
E1	YWHP-4N	3-pin Jack Male	M28	YWR130-HR01	Slide Knob (White) (x12: WR-8112 only) (x18: WR-8118 only)
E2 Δ	YWKP30SVT310	Cable Clamp	M29	YWR130-HR02	Slide Knob (Red) (x4)
E3	YWT-3P-UL	Power Cord	M30	YES-CULRB07	Caution Label
CN11-14-JF (x3)	YWFM-3-31	3-Pin Terminal Board	M31	{ * YWSF01RB01	Fuse Label [WR-8112 only]
CN11,12-JF (x5)	YWFM-3-31	3-Pin Jack Female (x4) [WR-8112 only]	M32	YWA7SA0170A4	Fuse Label [WR-8118 only]
CN13,14-JF (x4)	YWFM-3-31	3-Pin Jack Female (x2) [WR-8118 only]	M33	YWS-WB02	Rubber Foot (x4)
E4	YWUB0029	Grounding Terminal	M34	YWSR-5P-4	Cord Clamp
E5	YWX-N1157-01	Fuse Holder	M35	{ * YWZ9300DR10	Power Switch Guard [WR-8112 only]
E6	YW820836A	Capacitor Cover (x2)	M36	{ * YWA5DA0016A3	Power Switch Guard [WR-8118 only]
E7 {	YWR8112PLHO	Connection Wire Ass'y for Bus line.	M37	{ * YWA5DA0024A3	Smoke Plate [WR-8112 only]
CN703-PF	YWR8118PLHO	Connection Wire Ass'y for Bus line.	M38	{ * YWA5KA0062A1	Smoke Plate [WR-8118 only]
CN704-PF	EMCHUR0901K	9-pin Plug Female [WR-8118 only]	M39	{ * YWA5KA0131A0	Rear Plate [WR-8112 only]
CN803-PF	EMCHUR0601K	6-pin Plug Female [WR-8118 only]	M40	{ * YWA5WA0081A1	Rear Plate [WR-8118 only]
CN804-PF	EMCHUR0601K	9-pin Plug Female [WR-8118 only]	M41	{ * YWA5WA0174A0	Panel [WR-8112 only]
M1 {	YWA2CA0021B4	Mounting Bracket for Power Trans [WR-8112 only]	M42	{ * YWA5WA0174A0	Panel [WR-8118 only]
M2	{ * YWA2CA0036A4	Mounting Bracket for Power Trans [WR-8118 only]	M43	{ * YWA7MA0002B4	Main Label [WR-8112 only]
M3 {	YWA2CA002A3	Mounting Bracket for Smoke Plate	M44	{ * YWA7MA0007A4	Main Label [WR-8118 only]
M4 {	{ * YWA2KA0069A2	Frame [WR-8112 only]	M45	{ * YWA2KA0068A2	Chassis for Input Circuit Board (x4)
M5 {	{ * YWA2KA0105A2	Frame [WR-8118 only]	M46	{ * YWA2SA0121A3	Angle for Input Jack (x3: WR-8112 only) (x4: WR-8118 only)
M6 {	{ * YWA2KA0070A1	Master Chassis [WR-8112 only]	M47	YWA1EA0001A4	Screw (x4)
M7 {	{ * YWA2KA0106A1	Master Chassis [WR-8118 only]	M48	* YWA7DA0048A4	Heart-Sink for Power [WR-8118 only]
M8 {	{ * YWA2SA0122B3	Angle for Output Jack	M49	* YWA2KA0107A1	Chassis for Input Angle [WR-8118 only]
M9 {	{ * YWA2WA0003A1	Front Angle [WR-8112 only]	M50	* YWA2SA0236A4	Angle for Input Jack [WR-8118 only]
M10 {	{ * YWA2WA0014A0	Front Angle [WR-8118 only]	YWAPRB0167C1 INPUT CIRCUIT BOARD		
M11 {	{ * YWA3AA0001A3	Dustproof Sheet [WR-8112 only]	12 Circuit Boards are used in WR-8112 : PB1 (x12)		
M12 {	{ * YWA3AA0024A3	Dustproof Sheet [WR-8118 only]	18 Circuit Boards are used in WR-8118 : PB1 (x18)		
M13 {	{ * YWA5DA0002A2	Decoration Plate (x2)	PB	* YWAPRB0167C1	Circuit Board
M14 {	{ * YWA5KA0002C1	Side Plate, Right	IC101-108	YWNJM4560DD	Integrated Circuit (x8)
M15 {	{ * YWA5KA0003C1	Side Plate, Left	Q101-104	2SC2557TU	Transistor (x4)
M16 {	{ * YWA5KA0061A2	Bottom Cover [WR-8112 only]	Q105	2SC828A-RS	Transistor
M17 {	{ * YWA5KA0130A2	Bottom Cover [WR-8118 only]	Q106	2SA720-RS	Transistor
M18 {	{ * YWA5LA0001B4	Rubber Foot (Rear Panel) (x2)	D101-103	MA150	Diode (x3)
M19 {	{ * YWS5CA0001C4	Assignment Marker (X17: WR-8112 only) (X23: WR-8118 only)	D106	LN21.RP.H	LED
M20	YWS5DA0003A2	Arm Rest (X2: WR-8112 only) (X3: WR-8118 only)			

SYMBOL NO.	PART NO.	DESCRIPTION	SYMBOL NO.	PART NO.	DESCRIPTION
D108-117	MA150	Diode (x10)	VR104	YWAVRA0002A4	Variable Resistor 100K Ω (W)
R101,102	ERO25CKF6811	Metal Film (x2) 6.81K Ω $\frac{1}{4}$ W	VR105	YWAVRA0003A4	Variable Resistor 20K Ω (A) (NC)
R103,104	ERD25FJ474	Carbon Film (x2) 470K Ω $\frac{1}{4}$ W	VR106	YWAVRA0005A4	Variable Resistor 20K Ω (A)
R105,106	ERD25FJ104	Carbon Film (x2) 100K Ω $\frac{1}{4}$ W	VR107	YWAVRA00021A4	Variable Resistor 20K Ω (K/E)
R107-112	ERO25CKF7501	Metal Film (x6) 7.5K Ω $\frac{1}{4}$ W	C101, 102	ECCF1H101J	Ceramic (x2) 100pF 50V
R113	ERD25FJ474	Carbon Film 470K Ω $\frac{1}{4}$ W	C103,104	ECCF1H390JC	Ceramic (x2) 39pF 50V
R114	ERD25FJ680	Carbon Film 68 Ω $\frac{1}{4}$ W	C105, 106	ECCF1H101J	Ceramic (x2) 100pF 50V
R115,116	ERO25CKF5621	Metal Film (x2) 5.62K Ω $\frac{1}{4}$ W	C107	ECCF1H560J	Ceramic 56pF 50V
R107-112	ERO25CKF1052	Metal Film (x4) 10.5K Ω $\frac{1}{4}$ W	C108	ECCF1H101J	Ceramic 100pF 50V
R121	ERD25FJ104	Carbon Film 100K Ω $\frac{1}{4}$ W	C109	ECCF1H100D	Ceramic 10pF 50V
R122	ERD25FJ223	Carbon Film 22K Ω $\frac{1}{4}$ W	C110	ECCF1H560J	Ceramic 56pF 50V
R123	ERD25FJ112	Carbon Film 1.1K Ω $\frac{1}{4}$ W	C111	ECCF1H100D	Ceramic 10pF 50V
R124	ERD25FJ511	Carbon Film 510 Ω $\frac{1}{4}$ W	C112	ECEA0JS331	Electrolytic 330 μ F 6.3V
R125	ERD25FJ103	Carbon Film 10K Ω $\frac{1}{4}$ W	C113,114	ECEA1JS100	Electrolytic (x2) 10 μ F 63V
R126,127	ERD25FJ104	Carbon Film (x2) 100K Ω $\frac{1}{4}$ W	C115	ECEA0JS470	Electrolytic 47 μ F 6.3V
R128	ERD25FJ103	Carbon Film 10K Ω $\frac{1}{4}$ W	C116	ECCF1H101J	Ceramic 100pF 50V
R129,130	ERD25FJ513	Carbon Film (x2) 51K Ω $\frac{1}{4}$ W	C117	ECEA0JS470	Electrolytic 47 μ F 6.3V
R131	ERD25FJ473	Carbon Film 47K Ω $\frac{1}{4}$ W	C118	ECCF1H100D	Ceramic 10pF 50V
R132	ERD25FJ392	Carbon Film 3.9K Ω $\frac{1}{4}$ W	C120	ECEA1ES4R7	Electrolytic 4.7 μ F 25V
R133	ERD25FJ560	Carbon Film 56 Ω $\frac{1}{4}$ W	C121,122	ECQM1H682KZ	Polyester (x2) 0.0068 μ F 50V
R134	ERD25FJ472	Carbon Film 4.7K Ω $\frac{1}{4}$ W	C123	ECKF1H681KB	Ceramic 680pF 50V
R135-137	ERD25FJ223	Carbon Film (x3) 22K Ω $\frac{1}{4}$ W	C124-126	ECQV05684JZ	Polyester (x3) 0.68 μ F 50V
R138	ERD25FJ104	Carbon Film 100K Ω $\frac{1}{4}$ W	C127	ECQV05184JZ	Polyester 0.18 μ F 50V
R139-144	ERD25FJ223	Carbon Film (x6) 22K Ω $\frac{1}{4}$ W	C128	ECQM1H272KZ	Polyester 0.0027 μ F 50V
R145	ERD25FJ912	Carbon Film 9.1K Ω $\frac{1}{4}$ W	C129	ECEA1ES4R7	Electrolytic 4.7 μ F 25V
R146	ERD25FJ103	Carbon Film 10K Ω $\frac{1}{4}$ W	C130	ECQM1H272KZ	Polyester 0.0027 μ F 50V
R147,148	ERD25FJ183	Carbon Film (x2) 18K Ω $\frac{1}{4}$ W	C131	ECEA0JS470	Electrolytic 47 μ F 6.3V
R149	ERD25FJ152	Carbon Film 1.5K Ω $\frac{1}{4}$ W	C132-134	ECCF1H100D	Ceramic (x3) 10pF 50V
R150	ERD25FJ223	Carbon Film 22K Ω $\frac{1}{4}$ W	C136-138	ECEA0JS470	Electrolytic (x3) 47 μ F 6.3V
R151	ERD25FJ682	Carbon Film 6.8K Ω $\frac{1}{4}$ W	C139	ECCF1H101J	Ceramic 100pF 50V
R152	ERD25FJ912	Carbon Film 9.1K Ω $\frac{1}{4}$ W	C140	ECCF1H100D	Ceramic 10pF 50V
R153	ERD25FJ152	Carbon Film 1.5K Ω $\frac{1}{4}$ W	C141	ECEA0JS470	Electrolytic 47 μ F 6.3V
R154	ERD25FJ105	Carbon Film 1M Ω $\frac{1}{4}$ W	C142	ECCF1H101J	Ceramic 100pF 50V
R155,156	ERD25FJ112	Carbon Film (x2) 1.1K Ω $\frac{1}{4}$ W	C143	ECEA0JS470	Electrolytic 47 μ F 6.3V
R157	ERD25FJ105	Carbon Film 1M Ω $\frac{1}{4}$ W	C144	ECCF1H100D	Ceramic 10pF 50V
R158	ERD25FJ152	Carbon Film 1.5K Ω $\frac{1}{4}$ W	C145	ECEA0JS470	Electrolytic 47 μ F 6.3V
R159	ERD25FJ100	Carbon Film 10 Ω $\frac{1}{4}$ W	C146	ECCF1H100D	Ceramic 10pF 50V
R160	ERD25FJ223	Carbon Film 2.2K Ω $\frac{1}{4}$ W	C147,148	ECEA0JS470	Electrolytic (x2) 47 μ F 6.3V
R161	ERD25FJ100	Carbon Film 10 Ω $\frac{1}{4}$ W	C149	ECCF1H101J	Ceramic 100pF 50V
R162-164	ERD25FJ104	Carbon Film (x3) 100K Ω $\frac{1}{4}$ W	C150	ECCF1H100D	Ceramic 10pF 50V
R165	ERD25FJ102	Carbon Film 1K Ω $\frac{1}{4}$ W	C151	ECCF1H101J	Ceramic 100pF 50V
R166	ERD25FJ223	Carbon Film 22K Ω $\frac{1}{4}$ W	C152,153	ECEA0JS470	Electrolytic (x2) 47 μ F 6.3V
R167	ERD25FJ104	Carbon Film 100K Ω $\frac{1}{4}$ W	C154	ECEA1JS100	Electrolytic 10 μ F 63V
R168	ERD25FJ102	Carbon Film 1K Ω $\frac{1}{4}$ W	C155,156	ECEA1ES100	Electrolytic (x2) 10 μ F 25V
R169	ERD25FJ223	Carbon Film 22K Ω $\frac{1}{4}$ W	C157	ECEA0JS470	Electrolytic 47 μ F 6.3V
R170	ERD25FJ104	Carbon Film 100K Ω $\frac{1}{4}$ W	C158	ECCF1H100D	Ceramic 10pF 50V
R171,172	ERD25FJ101	Carbon Film (x2) 100 Ω $\frac{1}{4}$ W	C160-162	ECCF1H470J	Ceramic (x3) 47pF 50V
R173,174	ERD25FJ104	Carbon Film (x2) 100K Ω $\frac{1}{4}$ W	C163	ECEA0JS470	Electrolytic 47 μ F 6.3V
R175,176	ERD25FJ102	Carbon Film (x2) 1K Ω $\frac{1}{4}$ W	C164	ECKF1H471KB	Ceramic 470pF 50V
R177,178	ERD25FJ223	Carbon Film (x2) 22K Ω $\frac{1}{4}$ W	C165	ECKF1H221KB	Ceramic 220pF 50V
R179,180	ERD25FJ104	Carbon Film (x2) 100K Ω $\frac{1}{4}$ W	C166	ECCF1H101J	Ceramic (x2) 10pF 25V
R181-187	ERD25FJ223	Carbon Film (x7) 22K Ω $\frac{1}{4}$ W	SW101-106	YWSPJ222LN	Push Switch (x6)
R188	ERD25FJ223	Carbon Film 22K Ω $\frac{1}{4}$ W	C167,168	ECEA1ES100	Electrolytic (x2) 10 μ F 25V
R189	ERD25FJ223	Carbon Film 22K Ω $\frac{1}{4}$ W	SW107	YWSPJ222LS	Push Switch
R190	ERD25FJ224	Carbon Film 220K Ω $\frac{1}{4}$ W	SW108	YWSPJ222LN	Push Switch
R191,192	ERD25FJ200	Carbon Film (x2) 20 Ω $\frac{1}{4}$ W	CN101-JM	YWEI17205820	20-Pin Jack Male
R193	ERD25FJ103	Carbon Film 10K Ω $\frac{1}{4}$ W	M48	YWS5RA0002B4	Push Button (White) (x2)
R195	ERD25FJ104	Carbon Film 100K Ω $\frac{1}{4}$ W	M49	YWS5RB0002B4	Push Button (Gray)
R196	ERD25FJ511	Carbon Film 510 Ω $\frac{1}{4}$ W	M50	YWS5RC0002B4	Push Button (Yellow)
VR101	YWAVRA0019A4	Variable Resistor 10K Ω , 20K Ω (RD)	M51	YWS5RD0002B4	Push Button (Blue)
VR102	YWAVRA0002A4	Variable Resistor	M52	YWS5RE0002B4	Push Button (Orange) (x2)
VR103	YWAVRA0020A4	Variable Resistor 150K Ω x2, 50K Ω (B)	M53	YWS5RF0002B4	Push Button (Green)
			M54	YWUA520FR01	LED Spacer

SYMBOL NO.	PART NO.	DESCRIPTION	SYMBOL NO.	PART NO.	DESCRIPTION
YWAPRC0167C1 INPUT JACK BOARD			C202	ECCF1H101J	Ceramic 100pF 50V
12 Circuit Boards are used in WR-8112 : PB2 (x12) 18 Circuit Boards are used in WR-8118 : PB2 (x18)			C203	ECCF1H330J	Ceramic 33pF 50V
			C204	ECCF1H101J	Ceramic 100pF 50V
PB *	YWAPRC0167C1	Circuit Board	C205	ECCF1H330J	Ceramic 33pF 50V
C11-13	ECQV05224JZ	Polyester (x3) 0.22μF 50V	C206,207	ECEA0JS470	Electrolytic (x2) 47μF 6.3V
JK11	YWHLJ316-1-8	Input Jack	C208	ECCF1H101J	Ceramic 100pF 50V
JK12,13	YWEJU6LC1	Input Jack (x2)	C209	ECCF1H100D	Ceramic 10pF 50V
YWAPRD0167C1 INPUT FADER CIRCUIT BOARD			C210	ECEA0JS470	Electrolytic 47μF 6.3V
12 Circuit Boards are used in WR-8112 : PB3 (x12) 18 Circuit Boards are used in WR-8118 : PB3 (x18)			C211	ECCF1H101J	Ceramic 100pF 50V
			C212	ECCF1H100D	Ceramic 10pF 50V
PB *	YWAPRD0167C1	Circuit Board	C213	ECEA0JS470	Electrolytic 47μF 6.3V
VR11	YWAVRA0009A4	Variable Resistor	C214,215	ECEA1ES100	Electrolytic (x2) 10μF 25V
YWAPRB0168B1 GROUP 1,2 CIRCUIT BOARD			C217	ECEA0JS470	Electrolytic 47μF 6.3V
2 Circuit Boards are used in WR-8112 and WR-8118 : PB4 (x2)			C218	ECCF1H100D	Ceramic 10pF 50V
			C219	ECCF1H101J	Ceramic 100pF 50V
PB4 *	YWAPRB0168B1	Circuit Board	C221	ECEA0JS470	Electrolytic 47μF 6.3V
IC201	YWNJM2043DD	Integrated Circuit	C222	ECCF1H101J	Ceramic 100pF 50V
IC202-204	YWNJM4560DD	Integrated Circuit (x3)	C224	ECEA0JS470	Electrolytic 47μF 6.3V
D201-203	MA150	Diode (x3)	C225	ECCF1H100D	Ceramic 10pF 50V
D205	MA150	Diode	C226	ECCF1H101J	Ceramic 100pF 50V
R201-203	ERD25FJ223	Carbon Film (x3) 22KΩ ¼W	C229	ECEA0JS470	Electrolytic 47μF 6.3V
R204	ERD25FJ104	Carbon Film 100KΩ ¼W	C230	ECCF1H101J	Ceramic 100pF 50V
R205	ERD25FJ101	Carbon Film 100Ω ¼W	C231	ECCF1H100D	Ceramic 10pF 50V
R206	ERD25FJ104	Carbon Film 100KΩ ¼W	C232	ECEA0JS470	Electrolytic 47μF 6.3V
R207	ERD25FJ223	Carbon Film 22KΩ ¼W	C233	ECCF1H100D	Ceramic 10pF 50V
R208	ERD25FJ103	Carbon Film 10KΩ ¼W	C238	ECCF1H470J	Ceramic 47pF 50V
R209	ERD25FJ102	Carbon Film 1KΩ ¼W	SW201-205	YWSPJ222LN	Push Switch (x5)
R210	ERD25FJ622	Carbon Film 6.2KΩ ¼W	CN201-JM	YWEI17205820	20-Pin Jack Male
R211	ERD25FJ273	Carbon Film 27KΩ ¼W	CN202-JM	EMCS0360	3-Pin Jack Male
R212	ERD25FJ122	Carbon Film 1.2KΩ ¼W	CN202-PF	EMCHUR0301K	3-pin Plug Female [Group 2 only]
R213	ERD25FJ472	Carbon Film 4.7KΩ ¼W	M48	YWS5RA0002B4	Push Button (White) (x3)
R214	ERD25FJ101	Carbon Film 100Ω ¼W	M49	YWS5RB0002B4	Push Button (Gray)
R215,216	ERD25FJ100	Carbon Film (x2) 10Ω ¼W	M52	YWS5RE0002B4	Push Button (Orange)
R217,218	ERD25FJ223	Carbon Film (x2) 22KΩ ¼W	M61	YWA2SA0120A4	Angle for Group 1,2 P.B.
R219	ERD25FJ224	Carbon Film 220KΩ ¼W	YWAPRC0168B1 GROUP 1,2 JACK BOARD		
R221	ERD25FJ114	Carbon Film 110KΩ ¼W	2 Circuit Boards are used in WR-8112 and WR-8118 : PB5 (x2)		
R222	ERD25FJ223	Carbon Film 22KΩ ¼W			
R223	ERD25FJ104	Carbon Film 100KΩ ¼W	PB *	YWAPRC0168B1	Circuit Board
R224,225	ERD25FJ100	Carbon Film (x2) 10Ω ¼W	C21-23	ECQV05224JZ	Polyester (x3) 0.22μF 50V
R226-231	ERD25FJ223	Carbon Film (x6) 22KΩ ¼W	JK21	YWHLJ316-1-8	Jack
R232	ERD25FJ104	Carbon Film 100KΩ ¼W	JK22,23	YWEJU6LC1	Jack (x2)
R233	ERD25FJ223	Carbon Film 22KΩ ¼W	YWAPRD0168B1 GROUP 1,2 FADER BOARD		
R234,235	ERD25FJ104	Carbon Film (x2) 100KΩ ¼W	2 Circuit Boards are used in WR-8112 and WR-8118 : PB6 (x2)		
R236	ERD25FJ223	Carbon Film 22KΩ ¼W			
R237	ERD25FJ104	Carbon Film 100KΩ ¼W	PB *	YWAPRD0168B1	Circuit Board
R238	ERD25FJ102	Carbon Film 1KΩ ¼W	VR21	YWAVRA0009A4	Variable Resistor
R239	ERD25FJ104	Carbon Film 100KΩ ¼W	YWAPRE0168B1 GROUP 3,4 CIRCUIT BOARD		
R240	ERD25FJ103	Carbon Film 10KΩ ¼W	2 Circuit Boards are used in WR-8112 and WR-8118 : PB7 and PB17		
R241	ERD25FJ223	Carbon Film 22KΩ ¼W			
VR202	YWAVRA0010A4	Variable Resistor 20KΩ(A),20KΩ(C)	PB *	YWAPRE0168B1	Circuit Board
VR203	YWAVRA0005A4	Variable Resistor 20KΩ(A)	IC301	YWNJM2043DD	Integrated Circuit
VR204	YWAVRA0022A4	Variable Resistor 20KΩ(K/E), 20KΩ(A)	IC302,303	YWNJM4560DD	Integrated Circuit (x2)
C201	ECQV0533JZ	Polyester (Group 1 only) 0.033μF 50V	IC304	YWNJM2043DD	Integrated Circuit
			IC305	YWNJM2043DD	Integrated Circuit (PB17 Only)
			D302-305	MA150	Diode (x4)
			D306	MA150	Diode [PB17 Only]
			D307	MA150	Diode [PB7 Only]

SYMBOL NO.	PART NO.	DESCRIPTION	SYMBOL NO.	PART NO.	DESCRIPTION
D308	MA150	Diode	C308	ECCF1H101J	Ceramic 100pF 50V
D309,310	MA150	Diode [PB7 Only] (x2)	C309	ECCF1H100D	Ceramic 10pF 50V
R301-303	ERD25FJ223	Carbon Film (x3) 22KΩ ¼W	C310	ECEA0JS470	Electrolytic 47μF 6.3V
R304	ERD25FJ104	Carbon Film 100KΩ ¼W	C311	ECCF1H101J	Ceramic 100pF 50V
R305	ERD25FJ101	Carbon Film 100Ω ¼W	C312	ECCF1H100D	Ceramic 10pF 50V
R306	ERD25FJ104	Carbon Film 100KΩ ¼W	C313	ECEA0JS470	Electrolytic 47μF 6.3V
R307	ERD25FJ223	Carbon Film 22KΩ ¼W	C314,315	ECEA1ES100	Electrolytic (x2) 10μF 25V
R308	ERD25FJ104	Carbon Film 100KΩ ¼W	C317	ECEA0JS470	Electrolytic 47μF 6.3V
R309	ERD25FJ102	Carbon Film 1KΩ ¼W	C318	ECCF1H100D	Ceramic 10pF 50V
R310	ERD25FJ622	Carbon Film 6.2KΩ ¼W	C319	ECCF1H101J	Ceramic 100pF 50V
R311	ERD25FJ273	Carbon Film 27KΩ ¼W	C320	ECCF1H101J	Ceramic (PB7 Only) 100pF 50V
R312	ERD25FJ122	Carbon Film 1.2KΩ ¼W	C321	ECCF1H330J	Ceramic (PB7 Only) 33pF 50V
R313	ERD25FJ472	Carbon Film 4.7KΩ ¼W	C322	ECEA0JS470	Electrolytic 47μF 6.3V
R314	ERD25FJ101	Carbon Film 100Ω ¼W	C323	ECCF1H101J	Ceramic 100pF 50V
R315,316	ERD25FJ100	Carbon Film (x2) 10Ω ¼W	C324	ECCF1H330J	Ceramic 33pF 50V
R317	ERD25FJ114	Carbon Film 110KΩ ¼W	C325	ECEA0JS470	Electrolytic 47μF 6.3V
R318,319	ERD25FJ223	Carbon Film (x2) 22KΩ ¼W	C326	ECEA0JS470	Electrolytic (PB7 Only) 47μF 6.3V
R321	ERD25FJ224	Carbon Film 220KΩ ¼W	C327	ECCF1H101J	Ceramic 100pF 50V
R322	ERD25FJ223	Carbon Film 22KΩ ¼W	C328	ECCF1H100D	Ceramic 10pF 50V
R323	ERD25FJ104	Carbon Film 100KΩ ¼W	C329	ECEA0JS470	Electrolytic 47μF 6.3V
R324	ERD25FJ114	Carbon Film 110KΩ ¼W	C330	ECCF1H101J	Ceramic 1000pF 50V
R325	ERD25FJ223	Carbon Film 22KΩ ¼W	C331	ECCF1H100D	Ceramic 10pF 50V
R326	ERD25FJ682	Carbon Film 6.8KΩ ¼W	C332	ECEA0JS470	Electrolytic (PB17 Only) 47μF 6.3V
R327	ERD25FJ114	Carbon Film 110KΩ ¼W	C333	ECCF1H101J	Ceramic (PB7 Only) 100pF 50V
R328	ERD25FJ101	Carbon Film 100Ω ¼W	C334	ECCF1H100D	Ceramic (PB7 Only) 10pF 50V
R329	ERD25FJ223	Carbon Film [PB7 Only] 22KΩ ¼W	C335,336	ECEA0JS470	Electrolytic (PB7 Only) (x2) 47μF 6.3V
R330	ERD25FJ223	Carbon Film 22KΩ ¼W	C337	ECEA0JS470	Electrolytic 47μF 6.3V
R331	ERD25FJ104	Carbon Film (PB17 Only) 100KΩ ¼W	C338	ECCF1H470J	Ceramic 47pF 50V
R332	ERD25FJ101	Carbon Film (PB17 Only) 100Ω ¼W	SW301,302	YWSPJ222LN	Push Switch (x2)
R333	ERD25FJ114	Carbon Film (PB7 Only) 110KΩ ¼W	CN301-JM	YWEI17205820	20-Pin Jack Male
R334	ERD25FJ223	Carbon Film (PB7 Only) 22KΩ ¼W	CN302-JM	EMCS0660	6-Pin Jack Male
R335,336	ERD25FJ100	Carbon Film (x2) 10Ω ¼W	CN302-PF	EMCHUR0601K	6-Pin Plug Female [Group4 Only]
R337	ERD25FJ682	Carbon Film (PB7 Only) 6.8KΩ ¼W	CN202-PF	EMCHUR0301K	3-Pin Plug Female [Group3 Only]
R338	ERD25FJ114	Carbon Film (PB7 Only) 110KΩ ¼W	M48	YWS5RA0002B4	Push Button (White)
R339	ERD25FJ101	Carbon Film (PB7 Only) 100Ω ¼W	M52	YWS5RE0002B4	Push Button (Orange)
R340,341	ERD25FJ223	Carbon Film (PB7 Only) (x2) 22KΩ ¼W	M67	YWA2SA0120A4	Angle for Group 3,4 P.B.
R342	ERD25FJ223	Carbon Film (PB17 Only) 22KΩ ¼W	YWAPRF0168B1 GROUP 3,4 JACK BOARD		
R343	ERD25FJ104	Carbon Film (PB7 Only) 100KΩ ¼W	2 Circuit Boards are used in WR-8112 and WR-8118 : PB8 and PB9		
R344	ERD25FJ103	Carbon Film 10KΩ ¼W	PB *	YWAPRF0168B1	Circuit Board
VR302	YWAVRA0010A4	Variable Resistor 20KΩ (A, C)	C31-35	ECQV05224JZ	Polyester (x5) 0.22μF 50V
VR303,304	YWAVRA0005A4	Variable Resistor (x2)20KΩ (A)	C36	ECQV05224JZ	Polyester (Group 3 only) 0.22μF 50V
VR305	YWAVRA0005A4	Variable Resistor 20KΩ (A) (PB7 Only)	JK31	YWHLJ316-1-8	Jack
C301	ECEA0JS470	Electrolytic (PB7 Only) 47μF 6.3V	JK32-35	YWEJU6LC1	Jack (x4)
C302	ECCF1H101J	Ceramic 100pF 50V	JK36	YWEJU6LC1	Jack (Group 3 only)
C303	ECCF1H330J	Ceramic 33pF 50V	YWAPRG0168B1 GROUP 3,4 FADER BOARD		
C304	ECCF1H101J	Ceramic 100pF 50V	2 Circuit Boards are used in WR-8112 and WR-8118 : PB10 (x2)		
C305	ECCF1H330J	Ceramic 33pF 50V	PB *	YWAPRG0168B1	Circuit Board
C306,307	ECEA0JS470	Electrolytic (x2) 47μF 6.3V	VR31	YWAVRA0009A4	Variable Resistor 20KΩ (C)
YWAPRB0169A1 MASTER CIRCUIT BOARD					
PB11	YWAPRB0169A1	Circuit Board			
IC401	YWNJM2043DD	Integrated Circuit			

SYMBOL NO.	PART NO.	DESCRIPTION	SYMBOL NO.	PART NO.	DESCRIPTION
IC402-405	YWNJM4560DD	Integrated Circuit (x4)	VR401	YWAVRA0005A4	Variable Resistor 20K Ω (A)
IC406	YWNJM2043DD	Integrated Circuit	VR402	YWAVRA0023A4	Variable Resistor 20K Ω (A) x2
IC407-409	YWTA7220P	Integrated Circuit (x3)	C401,402	ECEA0JS470	Electrolytic (x2) 47 μ F 6.3V
Q401-406	2SK128-QR	F.E.T. (x6)	C403,404	ECCF1H101J	Ceramic (x2) 100pF 50V
Q407	2SA564A-RS	Transistor	C405,407	ECCF1H330	Ceramic (x2) 33pF 50V
Q408	2SC828A-RS	Transistor	C406,408	ECCF1H100D	Ceramic (x2) 10pF 50V
Q409	2SK128-QR	F.E.T.	C409-412	ECEA0JS470	Electrolytic (x4) 47 μ F 6.3V
Q410	2SA564A-RS	Transistor	C413	ECKF1H221KB	Ceramic (x2) 220pF 50V
D401-422	MA150	Diode (x22)	C414	ECCF1H680J	Ceramic (x2) 68pF 50V
D423	LN21 RP.H	L.E.D.	C415	ECEA0JS221	Electrolytic 220 μ F 6.3V
R401,402	ERD25FJ114	Carbon Film (x2) 110K Ω 1/4W	C416	ECCF1H101J	Ceramic 100pF 50V
R403-408	ERD25FJ223	Carbon Film (x6) 22K Ω 1/4W	C417,418	ECCF1H330J	Ceramic (x2) 33pF 50V
R409	ERD25FJ470	Carbon Film 47 Ω 1/4W	C419	ECKF1H221KB	Ceramic 220pF 50V
R410,411	ERD25FJ104	Carbon Film (x2) 100K Ω 1/4W	C420	ECCF1H101J	Ceramic 100pF 50V
R412	ERD25FJ470	Carbon Film 47 Ω 1/4W	C421	ECCF1H330J	Ceramic 33pF 50V
R413	ERD25FJ102	Carbon Film 1K Ω 1/4W	C422	ECCF1H680J	Ceramic 68pF 50V
R414	ERD25FJ104	Carbon Film 100K Ω 1/4W	C423	ECCF1H330J	Ceramic 33pF 50V
R415	ERD25FJ105	Carbon Film 1M Ω 1/4W	C424	ECEA0JS221	Electrolytic 220 μ F 6.3V
R416	ERD25FJ104	Carbon Film 100K Ω 1/4W	C425	ECEA0JS470	Electrolytic 47 μ F 6.3V
R417	ERD25FJ102	Carbon Film 1K Ω 1/4W	C426	ECCF1H101J	Ceramic 100pF 50V
R418,419	ERD25FJ104	Carbon Film (x2) 100K Ω 1/4W	C427,428	ECCF1H100D	Ceramic (x2) 10pF 50V
R420,421	ERD25FJ182	Carbon Film (x2) 1.8K Ω 1/4W	C429,430	ECEA0JS470	Electrolytic (x2) 47 μ F 6.3V
R422,423	ERD25FJ273	Carbon Film (x2) 27K Ω 1/4W	C431	ECKF1H221KB	Ceramic 220pF 50V
R424,425	ERD25FJ103	Carbon Film (x2) 10K Ω 1/4W	C432	ECCF1H680J	Ceramic 68pF 50V
R426,427	ERD25FJ114	Carbon Film (x2) 110K Ω 1/4W	C433	ECCF1H330J	Ceramic 33pF 50V
R428	ERD25FJ220	Carbon Film 22 Ω 1/4W	C434	ECEA0JS221	Electrolytic 220 μ F 6.3V
R429-431	ERD25FJ223	Carbon Film (x3) 22K Ω 1/4W	C435	ECCF1H101J	Ceramic 100pF 50V
R432	ERD25FJ220	Carbon Film 22 Ω 1/4W	C436,447	ECCF1H330J	Ceramic (x2) 33pF 50V
R433	ERD25FJ103	Carbon Film 10K Ω 1/4W	C437,438	ECEA0JS470	Electrolytic (x2) 47 μ F 6.3V
R434	ERD25FJ513	Carbon Film 51K Ω 1/4W	C439	ECCF1H101J	Ceramic 100pF 50V
R435,436	ERD25FJ104	Carbon Film (x2) 100K Ω 1/4W	C440	ECCF1H100D	Ceramic 10pF 50V
R437	ERD25FJ470	Carbon Film 47 Ω 1/4W	C441	ECEA0JS470	Electrolytic 47 μ F 6.3V
R438,439	ERD25FJ104	Carbon Film (x2) 100K Ω 1/4W	C442,443	ECKF1H271KB	Ceramic (x2) 270pF 50V
R440	ERD25FJ622	Carbon Film 6.2K Ω 1/4W	C444	ECCF1H101J	Ceramic 100pF 50V
R441	ERD25FJ102	Carbon Film 1K Ω 1/4W	C445	ECCF1H100D	Ceramic 10pF 50V
R442	ERD25FJ273	Carbon Film 27K Ω 1/4W	C446	ECEA0JS470	Electrolytic 47 μ F 6.3V
R443	ERD25FJ122	Carbon Film 1.2K Ω 1/4W	C448-449	ECCF1H100D	Ceramic (x2) 10pF 50V
R444	ERD25FJ472	Carbon Film 4.7K Ω 1/4W	C450-452	ECEA0JS470	Electrolytic (x3) 47 μ F 6.3V
R445	ERD25FJ220	Carbon Film 22 Ω 1/4W	C453	ECCF1H101J	Ceramic 100pF 50V
R446-451	ERD25FJ114	Carbon Film (x6) 110K Ω 1/4W	C454	ECCF1H100D	Ceramic 10pF 50V
R452,453	ERD25FJ100	Carbon Film (x2) 10 Ω 1/4W	C455	ECEA0JS470	Electrolytic 47 μ F 6.3V
R454-456	ERD25FJ223	Carbon Film (x3) 22K Ω 1/4W	C456	ECEA1ES100	Electrolytic 10 μ F 25V
R457,458	ERD25FJ104	Carbon Film (x2) 100K Ω 1/4W	C457,458	ECEA1ES101	Electrolytic (x2) 100 μ F 25V
R459,460	ERD25FJ223	Carbon Film (x2) 22K Ω 1/4W	C459	ECQV05333JZ	Polyester 0.033 μ F 50V
R461	ERD25FJ114	Carbon Film 110K Ω 1/4W	C460	ECKF1H102KB	Ceramic 1000pF 50V
R462	ERD25FJ104	Carbon Film 100K Ω 1/4W	C461	ECKF1H271KB	Ceramic 270pF 50V
R463	ERD25FJ114	Carbon Film 110K Ω 1/4W	C462,463	ECEA0JS470	Electrolytic (x2) 47 μ F 6.3V
R464	ERD25FJ104	Carbon Film 100K Ω 1/4W	C468-471	ECEA1ES470	Electrolytic (x4) 47 μ F 25V
R465,466	ERD25FJ470	Carbon Film (x2) 47 Ω 1/4W	C472-474	ECEA0JS221	Electrolytic (x3) 220 μ F 6.3V
R467	ERD25FJ123	Carbon Film 12K Ω 1/4W	SW401	YWSU F30NS	Push Switch
R468	ERD25FJ223	Carbon Film 22K Ω 1/4W	SW402	YWSPJ222LN	Push Switch
R469	ERD25FJ334	Carbon Film 330K Ω 1/4W	CN401-JM	YWEI17205820	20-Pin Jack Male
R470	ERD25FJ474	Carbon Film 470K Ω 1/4W	CN302-PF	EMCHUR0601K	6-pin Plug Female
R471	ERD25FJ105	Carbon Film 1M Ω 1/4W	CN702-PF	EMCHUR1001K	10-pin Plug Female [WR-8112 only]
R472	ERD25FJ104	Carbon Film 100K Ω 1/4W	M48	YWS5RA0002B4	Push Button (White)
R473	ERD25FJ123	Carbon Film 12K Ω 1/4W	M49	YWS5RB0002B4	Push Button (Gray)
R474	ERD25FJ474	Carbon Film 470K Ω 1/4W	M51	YWS5RD0002B4	Push Button (Blue)
R475	ERD25FJ334	Carbon Film 330K Ω 1/4W	M53	YWS5RF0002B4	Push Button (Green)
R476	ERD25FJ105	Carbon Film 1M Ω 1/4W	M73	YWA2SA0120A4	Angle for Master P.B. (x2)
R477	ERD25FJ472	Carbon Film 4.7K Ω 1/4W	M74	YWUA520FR01	LED Spacer
R480,481	ERD25FJ102	Carbon Film (x2) 1K Ω 1/4W			

SYMBOL NO.	PART NO.	DESCRIPTION	SYMBOL NO.	PART NO.	DESCRIPTION
YWAPRC0169A1 PHONES CIRCUIT BOARD			YWAPRH0169A1 MASTER L, R FADER BOARD		
PB12 * IC501 D501-504 R501,502 R503,504	YWAPRC0169A1 YWHA1374 MA150 ERD25FJ563 ERD25FJ681	Circuit Board Integrated Circuit Diode (x4) Carbon Film (x2) 56KΩ ¼W Carbon Film (x2) 680Ω ¼W	PB18 * VR41	YWAPRH0169A1 YWAVRA0024A4	Circuit Board Variable Resistor 20KΩ(A) x 2
YWAPRI0169A1 SOLO TRIG JACK BOARD			WR-8112 YWAPRB0170A3 POWER CIRCUIT BOARD		
R505,506 R507 R508 R509 R510	ERD25FJ104 ERD25FJ103 ERX1ANJ4R7 ERD25FJ103 ERX1ANJ4R7	Carbon Film (x2) 100KΩ ¼W Carbon Film 10KΩ ¼W Metal Film 4.7Ω 1W Carbon Film 10KΩ ¼W Metal Film 4.7Ω 1W	PB19 * R45 C51 JK53	YWAPRI0169A1 ERD25FJ224 ECQV05224JZ YWEJU6LC1	Circuit Board Carbon Film 220K ¼W Polyester 0.22μF 50V Jack
C501,502 C503,504 C505 C506-508 C509,510	ECEA0JS470 ECKF1H221KB ECEA1CS102 ECEA0JS101 ECQV05274JZ	Electrolytic (x2) 47μF 6.3V Ceramic (x2) 220pF 50V Electrolytic 1000μF 16V Electrolytic (x3) 100μF 6.3V Polyester (x2) 0.27μF 50V	PB20 * Q701,702 Q703-706 Q707,708 Q709	YWAPRB0170A3 2SD837A-PQ 2SC828-RS 2SA564A-RS 2SD837A-PQ	Circuit Board Transistor (x2) Transistor (x4) Transistor (x2) Transistor
C511,512 M79	ECEA1AS471 YWA7DA0001A4	Electrolytic (x2) 470μF 10V Heat Sink for IC	Q710 D701 D702,703 D704 D705	2SB751A-PQ YWRB152F YWXZ-245 MA150 YWRB152F	Transistor Bridge Diode Zener Diode (x2) Diode Bridge Diode
YWAPRD0169A1 MASTER L JACK BOARD			D706 D707,708 D709-713 D174 D715,716	WZ140 EM1Z MA150 RB152F YUDXZ162	Zener Diode Diode (x2) Diode (x5) Bridge Diode Zener Diode (x2)
PB13 * R41 R42 C41-44 JK41	YWAPRD0169A1 ERD25FJ472 ERD25FJ122 ECQV05224JZ YWHLJ316-1-8	Circuit Board Carbon Film 4.7KΩ ¼W Carbon Film 1.2KΩ ¼W Polyester (x4) 0.22μF 50V Jack	R701 R702 R703 R704 R705	ERD25FJ200 ERD25FJ103 ERD25FJ102 ERX1ANJ1R5H ERD25FJ102	Carbon Film 20Ω ¼W Carbon Film 10KΩ ¼W Carbon Film 1KΩ ¼W Metal Film 1.5Ω 1W Carbon Film 1KΩ ¼W
JK42 JK43 JK44,45 M85	YWEJU6LC1 YWJJP047212 YWEJU6LC1 YWA2CA0020A4	Jack RCA Pin Jack Jack (x2) Pin Jack Holder Plate	R706,707 R708 R709 R710 R711	ERD25FJ302 ERD25FJ222 ERD25FJ103 ERD25FJ104 ERD25FJ330	Carbon Film (x2) 3KΩ ¼W Carbon Film 2.2KΩ ¼W Carbon Film 10KΩ ¼W Carbon Film 100KΩ ¼W Carbon Film 33Ω ¼W
YWAPRE0169A1 MASTER R JACK BOARD			R712,713 R714 R715 R716 R717-719	ERD25FJ104 ERD25FJ183 ERD25FJ222 ERD25FJ183 ERD25FJ222	Carbon Film (x2) 100KΩ ¼W Carbon Film 18KΩ ¼W Carbon Film 2.2KΩ ¼W Carbon Film 18KΩ ¼W Carbon Film (x3) 2.2KΩ ¼W
PB14 * R43 R44 C45-48 JK48	YWAPRE0169A1 ERD25FJ472 ERD25FJ122 ECQV05224JZ YWJJP047212	Circuit Board Carbon Film 4.7KΩ ¼W Carbon Film 1.2KΩ ¼W Polyester (x4) 0.22μF 50V RCA Pin Jack	R720 R721,722 R723 R724 C701	ERX1ANJ1R5H ERD25FJ472 ERD25FJ222 ERX1ANJ1R5H ECQM1104KZ	Metal Film 1.5Ω 1W Carbon Film (x2) 4.7KΩ ¼W Carbon Film 2.2KΩ ¼W Metal Film 1.5Ω 1W Polyester 0.1μF 100V
JK46 JK47 JK49,50 M91	YWHLJ316-1-8 YWEJU6LC1 YWEJU6LC1 YWA2CA0020A4	Jack Jack Jack (x2) Pin Jack Holder Plate	YWAPRF0169A1 MONO JACK BOARD		
PB15 * C49 JK51	YWAPRF0169A1 ECQV05224JZ YWHLJ316-1-8	Circuit Board Polyester 0.22μF 50V Jack	YWAPRG0169A1 PHONES JACK BOARD		
YWAPRG0169A1 PHONES JACK BOARD			C702 C703,704 C705 C706 C707	ECET80T102SW ECEA1JS330 ECQV05104JZ ECET25R222SW ECEA1ES330	Electrolytic 1000μF 80V Electrolytic (x2) 33μF 63V Polyester 0.1μF 50V Electrolytic 2200μF 25V Electrolytic 33μF 25V
PB16 * C50 JK52	YWAPRG0169A1 ECQV05224JZ YWHLJ316-1-8	Circuit Board Polyester 0.22μF 50V Jack	C708 C709	ECEA1ES471 ECEA1ES470	Electrolytic 470μF 25V Electrolytic 47μF 25V

SYMBOL NO.	PART NO.	DESCRIPTION	SYMBOL NO.	PART NO.	DESCRIPTION
C710	ECEA1CS470	Electrolytic 47 μ F 16V	■ WR-8118 YWAPRE0248A3 PHANTOM SWITCH BOARD		
C711	ECEA1EN220S	Electrolytic 22 μ F 25V	PB21 *	YWAPRE0248B2	Circuit Board
C712	ECQM1104KZ	Polyester 0.1 μ F 100V	R71	ERG1ANJ682	Metal Film 6.8K Ω 1W
C713,714	ECET25R472SW	Electrolytic (x2) 4700 μ F 25V	SW71	YWSSB022L06U	Push Switch
C715,716	ECEA1ES331	Electrolytic (x2) 330 μ F 25V	■ WR-8118 YWAPRF0248B2 LED BOARD		
C717,718	ECET25R222SW	Electrolytic (X2) 2200 μ F 25V	PB22 *	YWAPRF0248B2	Circuit Board
C719	ECEA1JS330	Electrolytic 33 μ F 63V	D71	LN21RP.H	LED
CN701-JM	EMCS0360	3-Pin Jack Male	D72	LN31GP.H	LED
CN702-JM	EMCS1060	10-Pin Jack Male	M103	YWK L04	LED Holder (x2)
M97 *	YWA7DA0019A4	Heat Sink for Power Transformer	■ WR-8118 YWAPRC0248B2 POWER CONTROL CIRCUIT BOARD		
■ WR-8112 YWAPRC0170A3 PHANTOM SWITCH BOARD			PB24 *	YWAPRC0248B2	Circuit Board
PB21 *	YWAPRC0170A3	Circuit Board	Q801-803	2SD837A-PQ	Transistor (x3)
R71	ERG1ANJ682	Metal Film 6.8K Ω 1W	Q804	2SB751A-PQ	Transistor
SW71	YWSSB022L06U	Push Switch	D801,802	YWXZ-245	Diode (x2)
■ WR-8112 YWAPRD0170A3 LED BOARD			D803	MA162F	Diode
PB22	YWAPRD0170A3	Circuit Board	D804	YWXZ137	Diode
D71	LN21RP.H	LED	D805,806	YWXZ170	Diode (x2)
D72	LN31FP.H	LED	R801	ERD25FJ100	Carbon Film 10 Ω 1/4W
M103	YWK L04	LED Holder (x2)	R802	ERD25FJ103	Carbon Film 10K Ω 1/4W
■ WR-8118 YWAPRB0248B2 POWER CIRCUIT BOARD			R803	ERD25FJ102	Carbon Film 1K Ω 1/4W
PB20 *	YWAPRB0248B2	Circuit Board	R804	ERQ12HJR82P	Fuse Resistor 0.82 Ω 1/4W
Q701-704	2SC828-RS	Transistor (x4)	R805	ERD25FJ102	Carbon Film 1K Ω 1/4W
Q705,706	2SA564A-RS	Transistor (x2)	R806	ERD25FJ302	Carbon Film 3K Ω 1/4W
D701,702 Δ	YWRB152F	Bridge Diode (x2)	R807	ERQ12HJR39P	Fuse Resistor 0.39 Ω 1/4W
D703,704	YWEM1Z	Diode (x2)	R809,810	ERD25FJ102	Carbon Film (x2) 1K Ω 1/4W
D705-709	MA150	Diode (x5)	R808,811	ERD25FJ152	Carbon Film (x2) 1.5K Ω 1/4W
R701	ERD25FJ302	Carbon Film 3K Ω 1/4W	R812	ERQ12HJR39P	Fuse Resistor 0.39 Ω 1/4W
R702	ERD25FJ222	Carbon Film 2.2K Ω 1/4W	C801,802	ECEA1JS330	Electrolytic (x2) 33 μ F 63V
R703	ERD25FJ103	Carbon Film 10K Ω 1/4W	C803	ECEA1ES330	Electrolytic 330 μ F 25V
R704	ERD25FJ104	Carbon Film 100K Ω 1/4W	C804,805	ECEA1ES331	Electrolytic (x2) 330 μ F 25V
R705	ERD25FJ330	Carbon Film 33 Ω 1/4W	C806-809	ECQV05223JZ	Polyester (x4) 0.022 μ F 50V
R706,707	ERD25FJ104	Carbon Film (x2) 100K Ω 1/4W	C811-814	ECQV05223JZ	Polyester (x4) 0.022 μ F 50V
R708,709	ERD25FJ183	Carbon Film 18K Ω 1/4W	CN804-JM	EMCS0660L	6-Pin Jack Male
R710-712	ERD25FJ222	Carbon Film (x3) 2.2K Ω 1/4W	CN803-JM	EMCS0960L	9-Pin Jack Male
R713 Δ	ERD25FJ100	Carbon Film 10 Ω 1/4W	M97	YWA2SA0237A4	Angle for Circuit Board (x2)
R714 Δ	ERQ12HJR39	Fuse Resistor 0.39 Ω 1/4W	■ WR-8118 YWAPRD0248B2 BRIDGE DIODE CIRCUIT BOARD		
C701 Δ	ECQM1104KZ	Polyester 0.1 μ F 100V	PB25 *	YWAPRD0248B2	Circuit Board
C702 Δ	ECET80R102S	Electrolytic 1000 μ F 80V	D710 Δ	YWRB402F	Bridge Diode
C703	ECEA1JS330	Electrolytic (x2) 33 μ F 63V	C710 Δ	ECQM1104KZ	Polyester 0.1 μ F 100V
C704	ECQV05104JZ	Polyester 0.1 μ F 50V	YWAPRY0171A3 BAR GRAPH CIRCUIT BOARD		
C705 Δ	ECET25R222SW	Electrolytic 0.0022 μ F 25V	PB23	YWAPRY0171A3	Circuit Board
C706	ECEA1ESA71	Electrolytic 470 μ F 25V	IC611	YWBA682	Integrated Circuit
C707	ECEA1ES470	Electrolytic 47 μ F 25V	IC621	YWBA682	Integrated Circuit
C708	ECEA1CS471	Electrolytic 470 μ F 16V	IC631	YWBA682	Integrated Circuit
C709	ECEA1EN220	Electrolytic 22 μ F 25V	IC641	YWBA682	Integrated Circuit
C711,712 Δ	ECET35R103SW	Electrolytic (x2) 10.000 μ F 35V	D601	LN21RP.H	LED
C713,714	ECET25R222SW	Electrolytic (x2) 2.200 μ F 25V	D611	LN12161P	LED
CN701-JM	EMCS0360	3-pin Jack Male	D621	LN12161P	LED
CN702-JM	EMCS1060	10-pin Jack Male	D631	LN12161P	LED
CN703-JM	EMCS0660	6-pin Jack Male	D641	LN12161P	LED
CN704-JM	EMCS0960	9-pin Jack Male	R601	ERD25FJ472	Carbon Film 4.7K Ω 1/4W
M97 *	YWA2SA0237A4	Heat Sink for Power Transformer (x2)	R611	ERD25FJ513	Carbon Film 51K Ω 1/4W

SYMBOL NO.	PART NO.	DESCRIPTION	SYMBOL NO.	PART NO.	DESCRIPTION
R612	ERD25FJ103	Carbon Film 10KΩ ¼W	C612	ECEA1HS010	Electrolytic 1μF 50V
R613	ERD25FJ273	Carbon Film 27KΩ ¼W	C621	ECEA1HS2R2	Electrolytic 2.2μF 50V
R614	ERD25FJ274	Carbon Film 270KΩ ¼W	C622	ECEA1HS010	Electrolytic 1μF 50V
R621	ERD25FJ513	Carbon Film 51KΩ ¼W	C631	ECEA1HS2R2	Electrolytic 2.2μF 50V
R622	ERD25FJ103	Carbon Film 10KΩ ¼W	C632	ECEA1HS010	Electrolytic 1μF 50V
R623	ERD25FJ273	Carbon Film 27KΩ ¼W	C641	ECEA1HS2R2	Electrolytic 2.2μF 50V
R624	ERD25FJ274	Carbon Film 270KΩ ¼W	C642	ECEA1HS010	Electrolytic 1μF 50V
R631	ERD25FJ513	Carbon Film 51KΩ ¼W	CN701-PF	EMCHUR0301K	3-Pin Plug Female
R632	ERD25FJ103	Carbon Film 10KΩ ¼W	M109	YWA3CA0012C4	LED Holder
R633	ERD25FJ273	Carbon Film 27KΩ ¼W	ACCESSORIES / PACKAGING		
R634	ERD25FJ274	Carbon Film 270KΩ ¼W	M115	* YWSRB115A	Service Center List Operating Instructions [WR-8112 only]
R641	ERD25FJ513	Carbon Film 51KΩ ¼W	M116	* YWA8QA0117AN	
R642	ERD25FJ103	Carbon Film 10KΩ ¼W	M116	* YWA8OA0169AN	Operating Instructions [WR-8118 only]
R643	ERD25FJ273	Carbon Film 27KΩ ¼W	M117	YWA8SA0001A3	Micky Knob
R644	ERD25FJ274	Carbon Film 270KΩ ¼W	M118	YWA8UA0001A2	Warranty Card
VR611	EVNK4AA00B15	Variable Resistor 100KΩ (B)	M119	YWT10X16C03	Polyethylen Bag for Service Parts
VR621	EVNK4AA00B15	Variable Resistor 100KΩ (B)	M120	YWT15X20C03	Polyethylene Bag for Power Cord Polyethylen Bag for Set [WR-8112 only]
VR631	EVNK4AA00B15	Variable Resistor 100KΩ (B)	M121	YWT80X90X1	
VR641	EVNK4AA00B15	Variable Resistor 100KΩ (B)	M121	YWT100X120X1	Polyethylene Bag for Set [WR-8118 only]
C601	ECEA1ES100	Electrolytic 10μF 25V	M122	YWR8112PHA1A	Packaging Case Ass'y [WR-8112 only]
C611	ECEA1HS2R2	Electrolytic 2.2μF 50V	M122	* YWR8118PHA1	Packaging Case Ass'y [WR-8118 only]
CN701-PF	EMCHUR0301K	3-pin Plug Female	M123	YWA8SA0002A4	Micky Knob
			M124	XZB26X40C05	Polyethylene Bag for Operating Instructions.

MusicParts

APPLICATION NOTES

EIGHT TRACK MIXDOWN

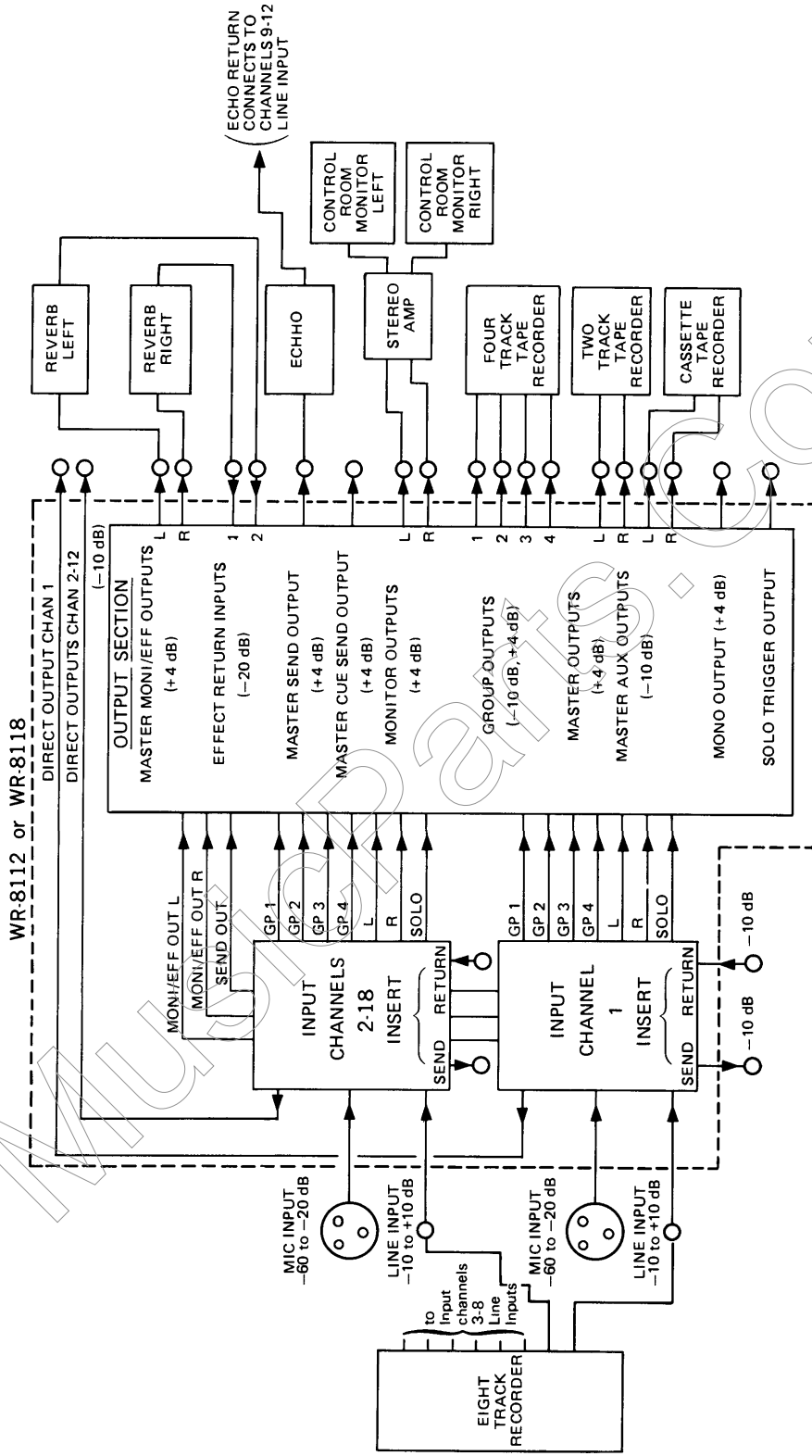

SOUND REINFORCEMENT

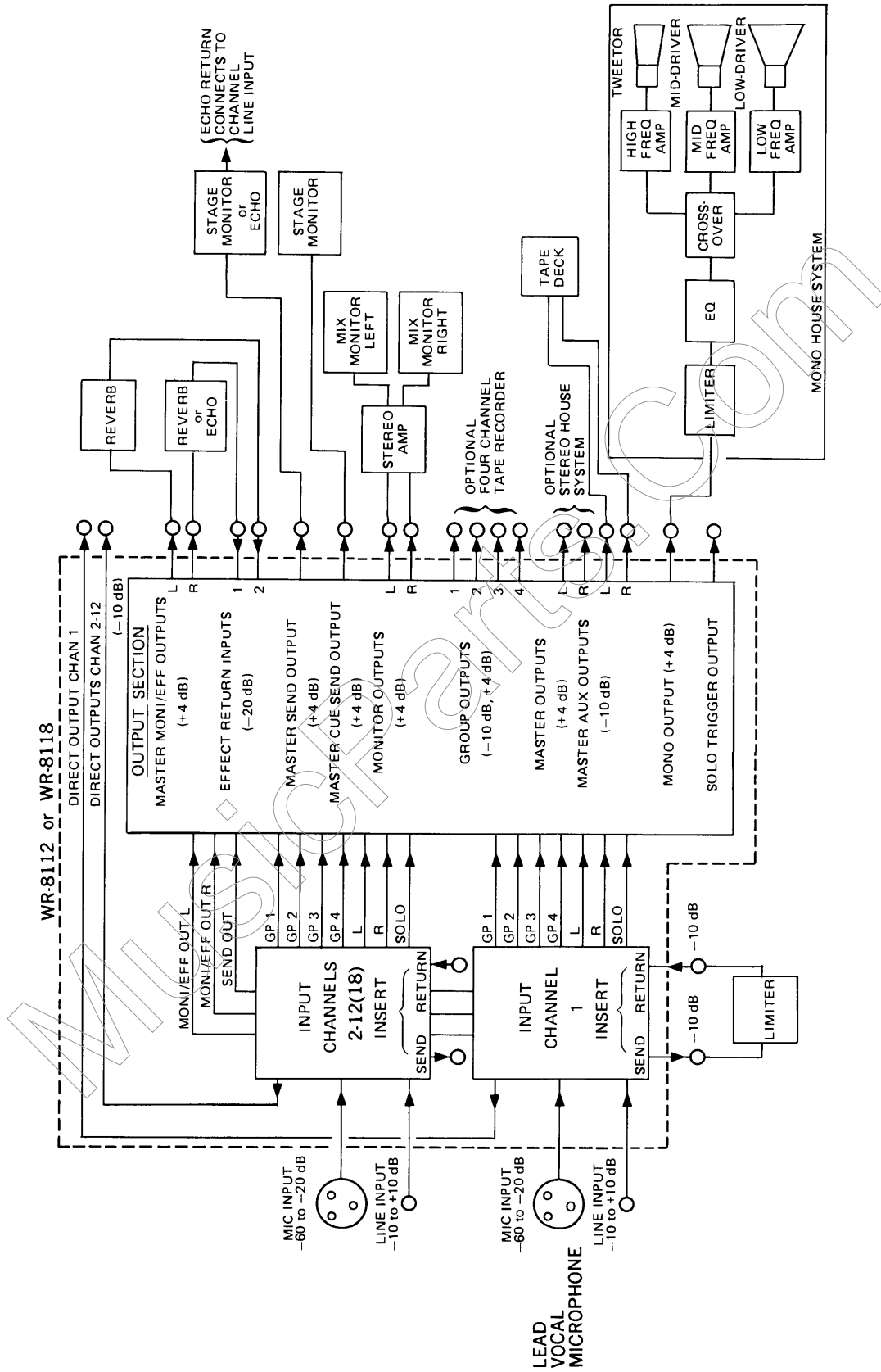

TWO/FOUR/EIGHT TRACK RECORDING

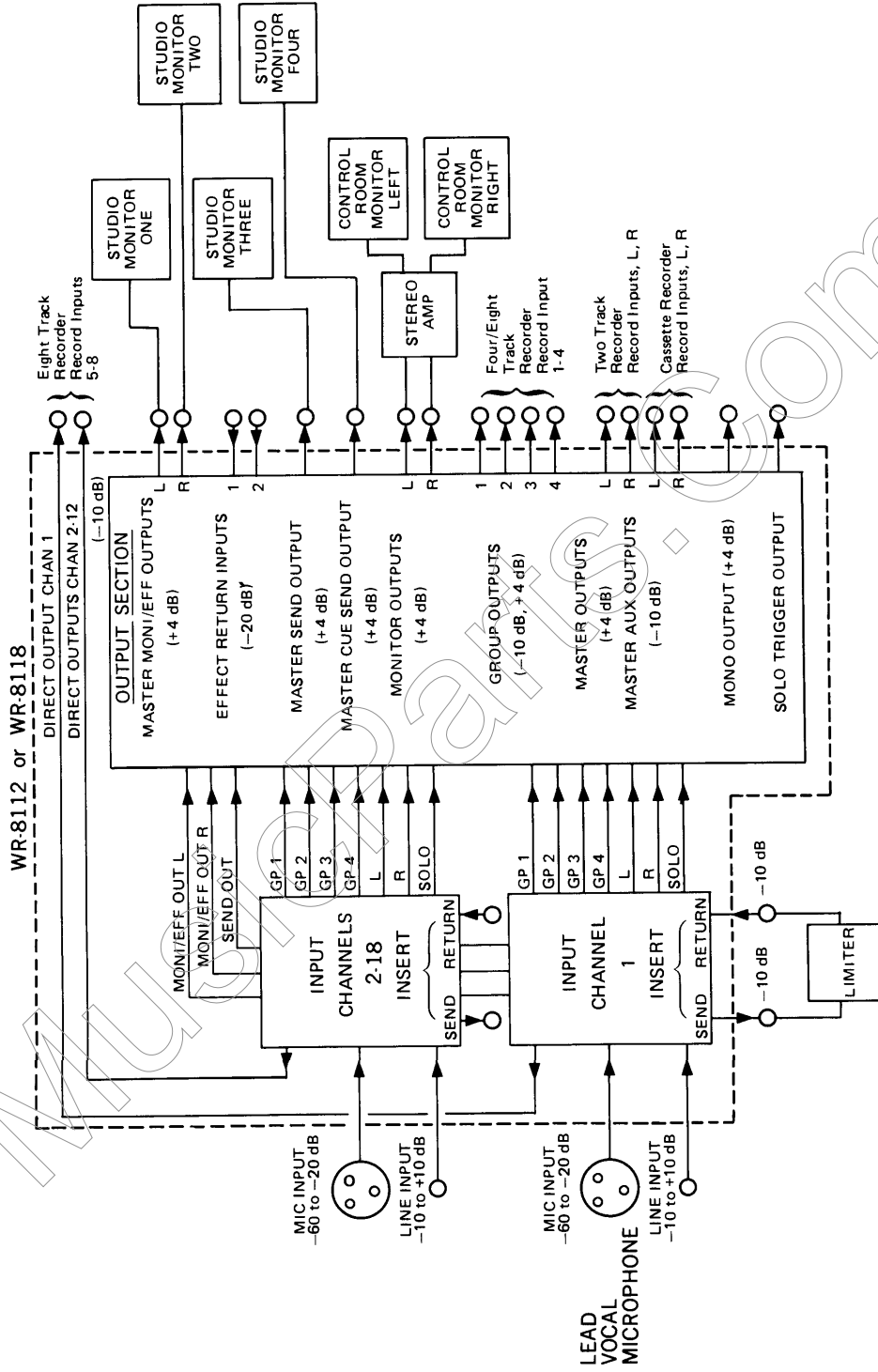

STAGE MONITORING

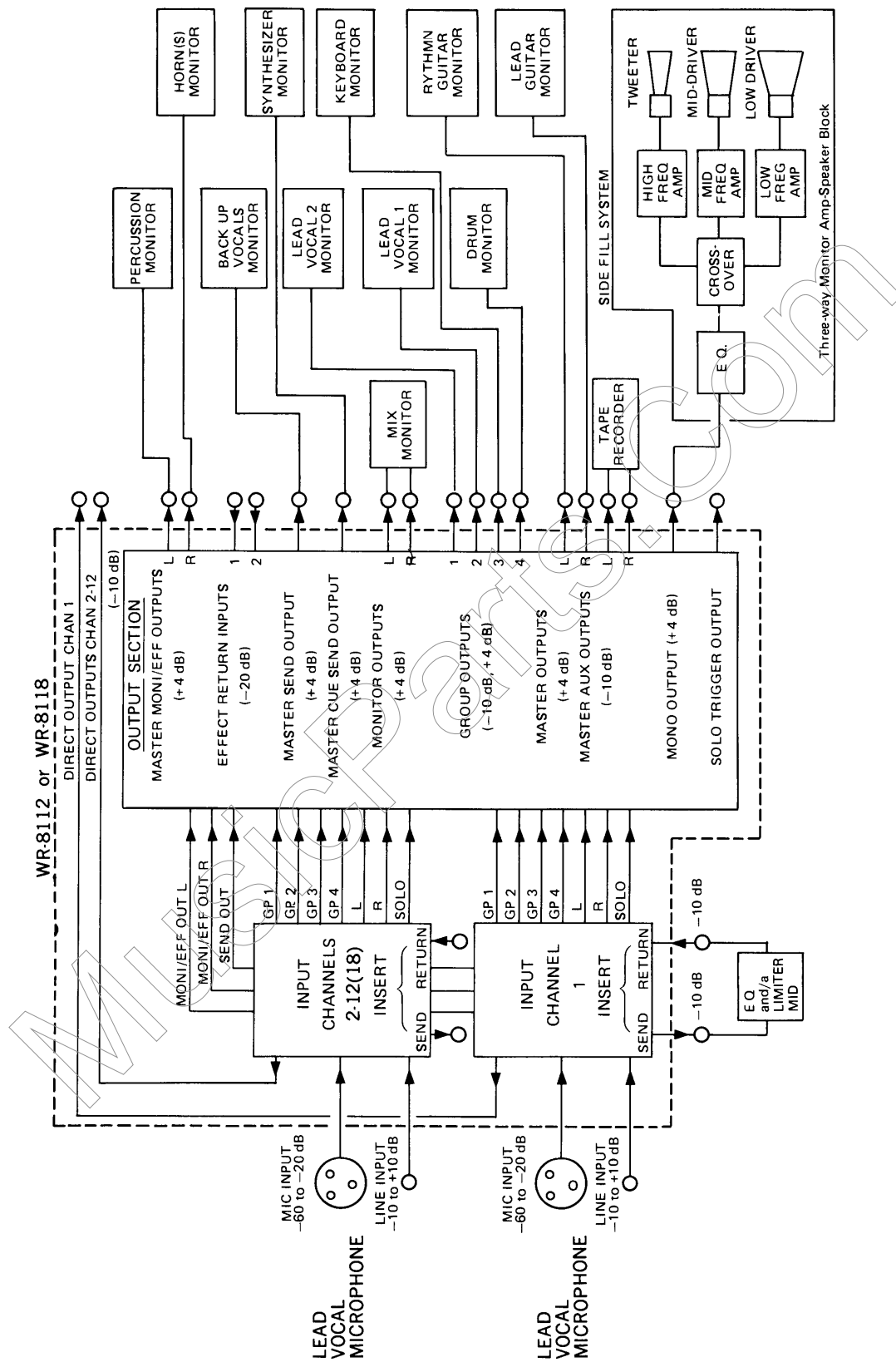

OVERDUBBING FORMAT

