

SVC-350 SERVICE NOTES

SPECIFICATIONS

ROLAND VOCODER Model SVC-350

INPUTS

MIC INPUT: 1/4 inch STANDARD Phone Jack or EIA-RS297 Connector (600ohm, -54dBm min.)

INSTRUMENT INPUT: 1/4 inch STANDARD Phone Jack (100kohm, 0dB max.)

GUITAR INPUT: 1/4 inch STANDARD Phone Jack (100kohm, GUITAR Raw LEVEL) -10dBm (750mV)

INSTRUMENT LEVEL SELECTOR Switch (0dBm, -15dBm, -30dBm)

INPUT LEVEL INDICATORS:

LED DISPLAY 5
MIC LEVEL: Green, Red/over
INSTRUMENT LEVEL: Green Red/over
GUITAR LEVEL: Green Red/over

OUTPUTS

For GUITAR AMPLIFIER: 1/4 inch STANDARD Phone Jack (10kohm)

MONO or STEREO OUTPUTS: 1/4 inch STANDARD Phone Jack

CONTROLS

MIC LEVEL CONTROL
(-54dBm to -14dBm)

POWER CONSUMPTION: 18W

DIMENSIONS: 482(W) x 92(H) x 350(D) mm

WEIGHT: 5.3kg

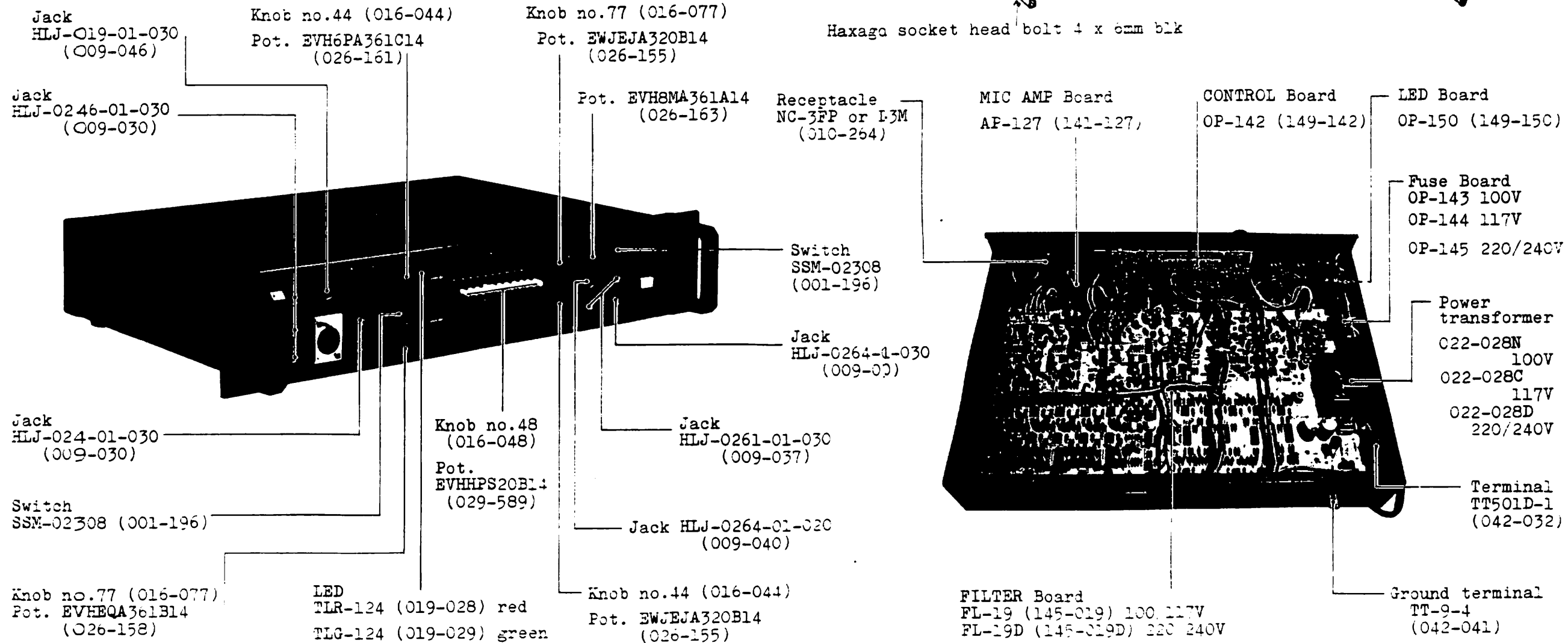
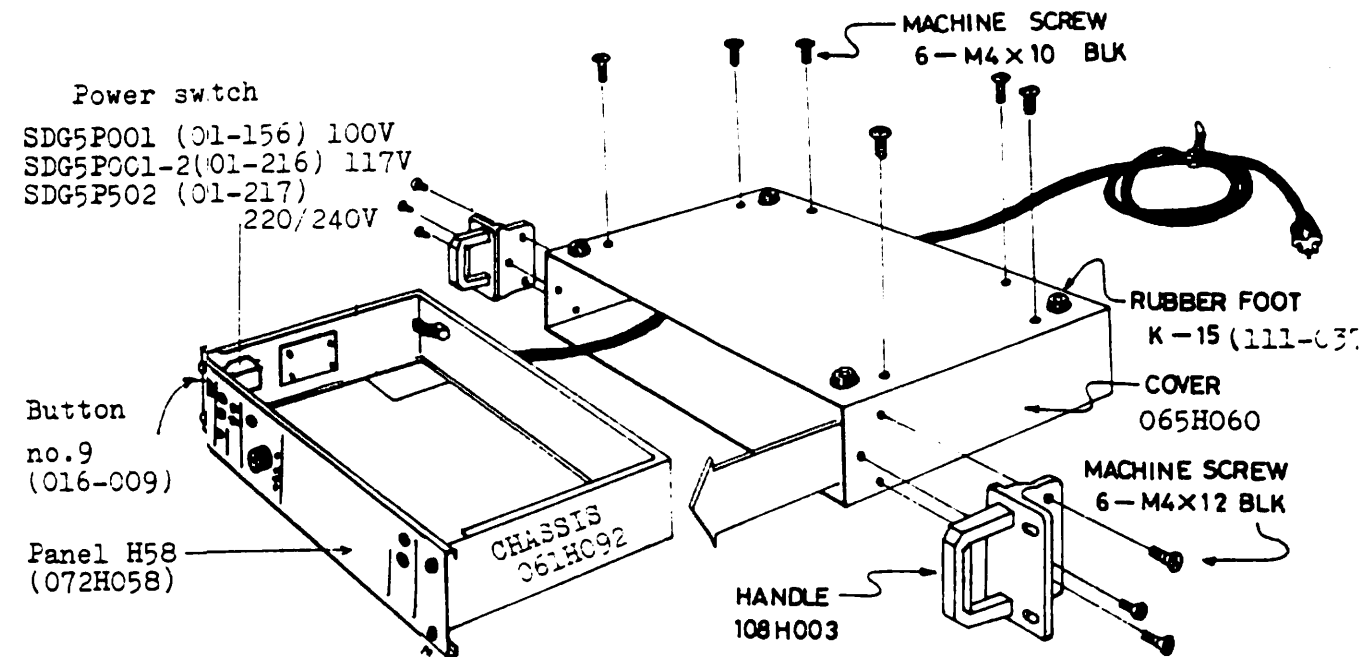

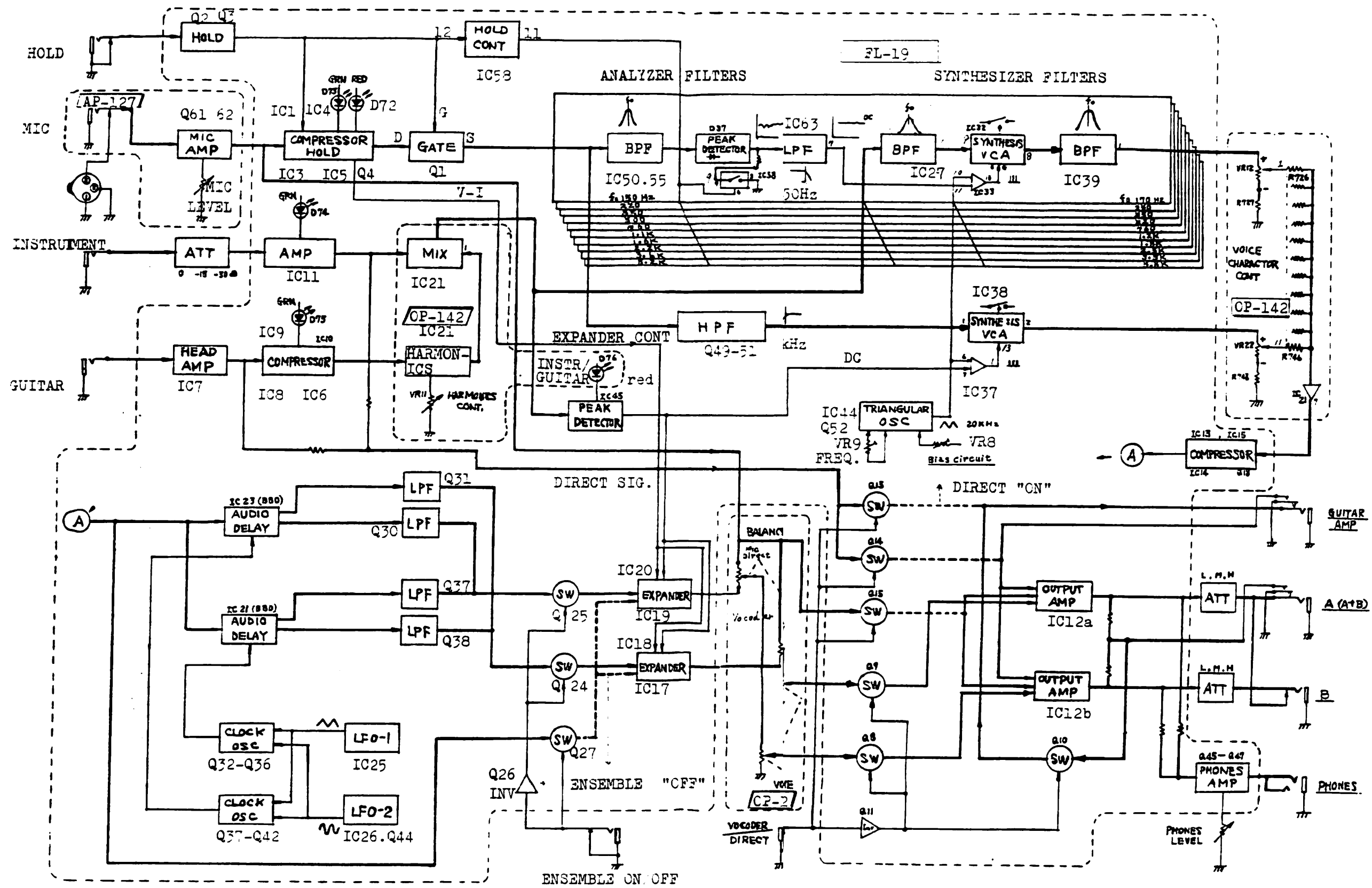

SVC-350 BLOCK DIAGRAM

COMPRESSOR

After amplified by 14-54dB through Mic Head Amp on AF-127, Mic signal goes to IC4 (pins 5-7) whose gain is reversely proportional to the control current from Q5 emitter.

The mic signal coming from IC2 pin 7 is full-wave rectified by IC3 (pins 5-7), D1 and D2, peak-voltage detected by IC3 (pins 1-3), D3, smoothed to DC voltage by IC5 (pins 1-3), and V-I converted by IC4 (pins 1-3), Q5. Connected across IC4's pins 6 and 7 in parallel with feedback resistors is IC1 3A662. As the mic signal increases, Q5 output current increases, that causes 3A662 conductance to increase, lowering the gain of IC4 (pins 5-7) to retain either half peak output from going above 10V (20 Vpp).

In this Vocoder, there are two other compressors similar to the Mic compressor in configuration: in Guitar preamp chain and Synthesizer filter output channel.

EXPANDER

The output voltage at pin 1 of IC5 is also received by Expanders IC17-20, Q22 and Q23. The current from Q22 (Q23) varies in the same direction as in the Compressor, but with this fashion, signal flow rate through IC18 (IC20) is directly proportional to the control current; the more current flows, the more signal flows through IC18.

ANALYSER FILTER

Ten BPFs with a high Q consisting of ICs (e. g. IC50 and IC55) covers most of the audio spectrum - speech signal.

The signal from the compressor is pre-emphasized through IC5 (pins 5-7) and fed to the filter bank which slices up the spectrum. Each slice goes to a diode (e.g. D37) where its peak is detected, smoothed and is fed to the VCA in the next stage filter -Synthesizer filter. This is a control voltage that is proportional to the strength of that slice.

SYNTHESIZER FILTER

The Synthesizer filter is a set of bandpass filter, identical to those of the Analyzer section, is fed by the signal coming through either INSTRUMENT or PHAR preamp and HARMONICS circuit. The filter bank slices up instrument sound spectrum into bands in the same way analyzer filter does on the speech spectrum. Each slice then connects to voltage-controlled amp -VCA.

VCA

During an absence of signal in Analyzer filter (e.g. IC50 IC55, IC63), negative peaks of triangular wave on pin 10 of IC33 is kept positive -determined by VR3 with respect to the pin 11, disabling switching gate IC32.

When the voltage from IC63 increases to some extent, it exceeds lower portion of triangular wave, causing IC33 pin 13 turns to "H" which in turn gates IC32 on. When positive going triangular wave reaches above the voltage on pin 11, pin 13 turns to "L" and IC32 turns off. The signal flow rate through IC32 depends on the width of pulse from IC33 and pulse width is proportional to IC63 control voltage. pulsesating rectified signals are smoothed while they are passing through the next filter -IC39.

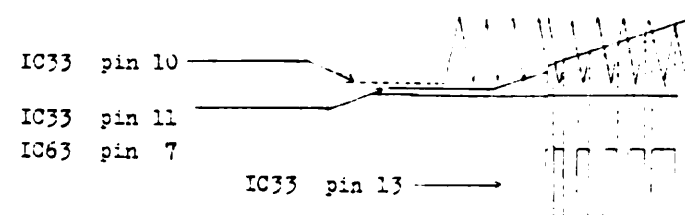

HIGH CONSONANT FILTER

This HPF allows only high-frequency component in signal from the Mic amp to pass so as to compensate for high-frequency range incapable of reproduction by the Vocoder circuits.

VOCODER HOLD

This circuit is composed of Q2, Q3 and Q4. When the HOLD jack circuit opens, and 50ms later, the Q2 output increases in the positive-going to turn on the gate Q1 and to shunt IC50 input to the ground. On the other hand, a signal supplied through D7 turns FET switch IC58 (pins 10-12) on, turning IC58 (pins 8 and 9) off, disconnecting R307 from discharging path. Increased discharging time constant can hold previously charged C135 for 7-10sec.

VOICE CHARACTER CONTROL

Because resistors -R726, 728, 730 --- connected to wiper terminals of CHARACTER CONTROL pots, are different in value; the higher the frequency, the larger the value; overall frequency response offers de-emphasized characteristics.

SOUND DETECTOR

During an absence of musical instrument's signal, Vocoder shuts inadvertent signals in under the coordination of a system. The sound detector is the first stage of the system.

IC45 (pins 5-7), D51 and D52 make up a full-wave rectifier. The average output voltage is peak of the signal delivered by IC21 pin 1, then IC45 (pins 1-3) provides adequately smooth DC output from pin 1.

When this voltage - at pin 4 of IC37 - exceeds voltage at pin 5, pin 3 goes to negative, cutting Q29 off, removing the ground from pin 2 of IC17 (IC19). Expanders are now ready to function.

IC37 pin 7 also sees Sound Detector's output and determines pin 1's output pulse width which in turn regulates HPF signal flow rate. While Synthesizer filter VCA responds to speech spectrum, HPF VCA to the instrument's.

CIRCUIT DESCRIPTION

—General—

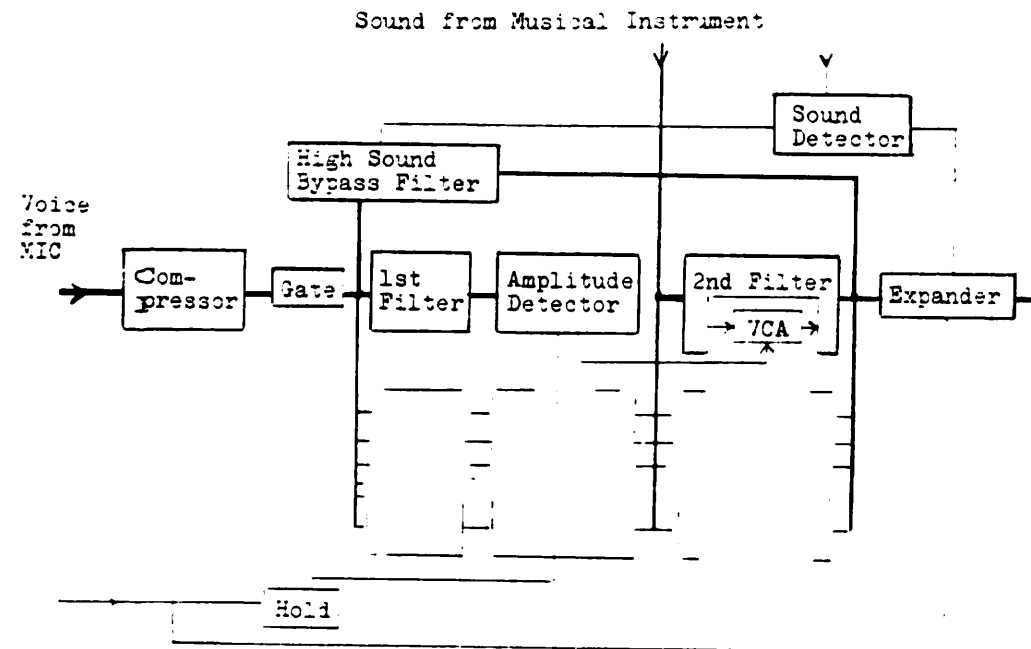

In the Vocoder, the voice signal from a Mic is frequency-analysed through a group of filters to slice up a voice signal frequency spectrum featuring human voice. Then the spectrum is duplicated to another group of musical sound signal filters to obtain functions equivalent to human mouth and throat and thus to simulate human voice with musical sound signals.

Fundamental Vocoder functions are described below according to the Block Diagram shown above.

1. Analyzing (first) Filter and Amplitude Detectors

A Mic input signal is resolved by a group of filters into frequency band components which are amplitude-detected and supplied to the VCAs of the Synthesizer Filter (second filter).

Signals passing through second filters are controlled in volume at VCA by the control signal coming from corresponding frequency band of the first filter.

2. Synthesizer (second) filter and VCAs

Like the first filter, a musical sound signal being supplied is resolved into frequency spectrum components. Since a musical sound passing through the second group of filters is proportional to the first filter output amplitude, the spectrum of the second filter output is analogous to that of the voice signal. In other words, the second filter output is mixture of the input musical sound signal and the first signal output. Thus, uniform sound signal spectrum would be ideal for reproduction of human voice, but it is no longer of a musical instrument.

3. Comander

The comander is a combination of a compressor and an expander.

The compressor reduces a mic input signals range in amplitude and supplies smaller output signals range than input signals' to the first filter.

On the contrary, the expander, for a given range of amplitude input voltages, produces a larger amplitude range of output voltage. Thus restores the original volume range.

4. High Frequency Voice Signal Bypass Filter (Resonant Filter)

Since musical sounds rarely include high frequency noise components such as "fricative" may be in voice, the second filter has no spectrum to respond to. Furthermore, such a sound, hardly relating to musical intervals, is separated from a mic input signal, passes through this circuit and is recombined with the second filter outputs.

5. Musical Sound Signal Detector

This circuit obstructs the second filter output as long as a musical sound is not supplied to the Vocoder and tells the circuits 3 and 4 whether a musical sound signal is being fed or not.

6. Hold Circuit

This circuit enables Vocoder to hold its output during an interruption in mic signal, e.g. when a singer inspires. The function can also be used for some special effect applications.

During holding, this circuit retains spectrums and volume by holding amplitude detectors output voltages and expander control voltage.

The compressor gain is minimized and the voice gate is turned off so as to keep voice unchanged even though Mic input signal is changing.

FUSE BOARD AC CONNECTIONS

100V

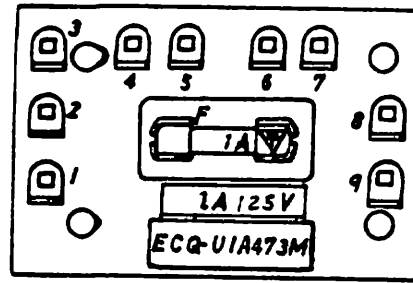

OP-143A
(149-143A)

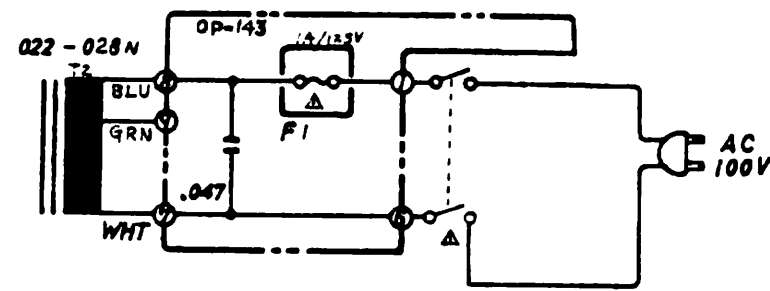

POWER SW. SDG-SP-001-1
001-215

117V

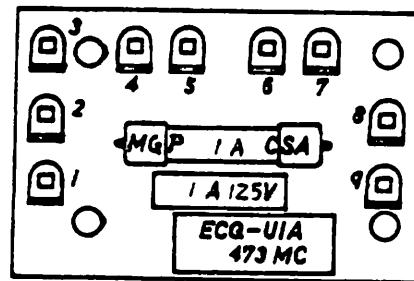

OP-144A
(149-144A)

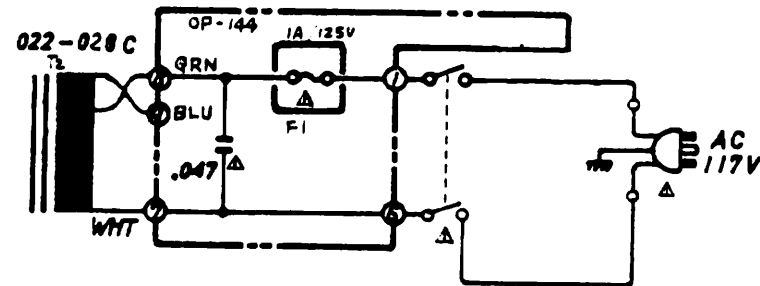

POWER SW. SDG-SP-001-2
001-216

220, 240V

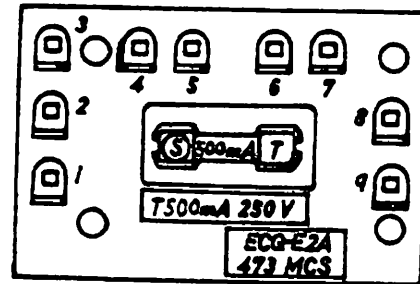

OP-145A
(149-145A)

(Etch mask 052H185A)

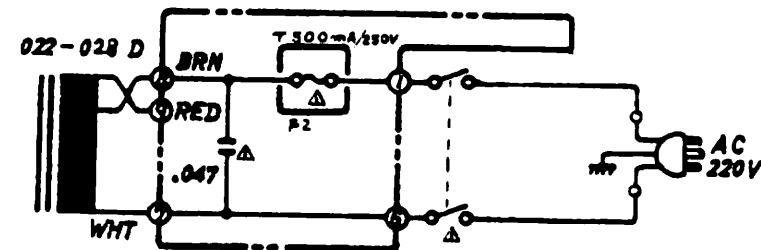

POWER SW. SDG-SP-302
001-217

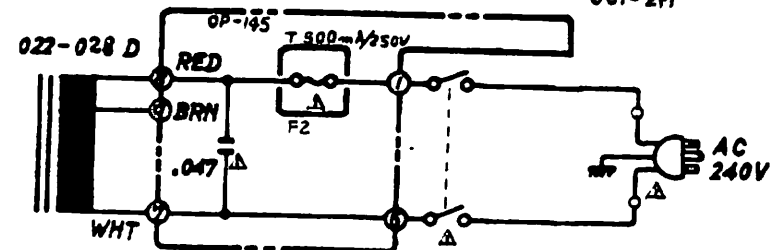

OP-150 (149-150)

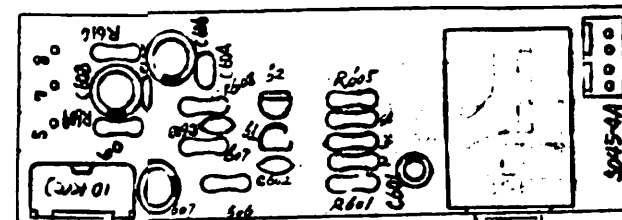
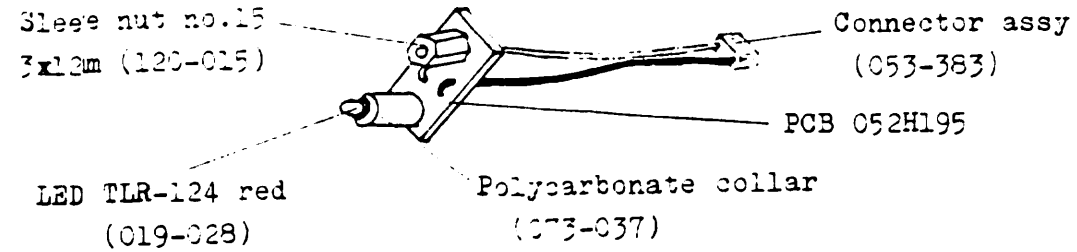

MIC LEVEL VR10 EVH6PA361C14 (026-141)
MIC INPUT J4 HLJ0190-01-030 (009-046)

AP-127 (141-127)

(Etch mask 052-491)

- : 2SC945-P
- : 2SA733-P
- ⊗ : Electrolytic
- ⊔ : Maylar 50V K
- : Ceramic 50V K
- ⊕ : Resistor ⊕w

OP-142 (149-142) View from foil side

(Etch mask 052-492)

EWJ-EJA320B14 (026-155)
BALANCE! EVAHHPS20B14

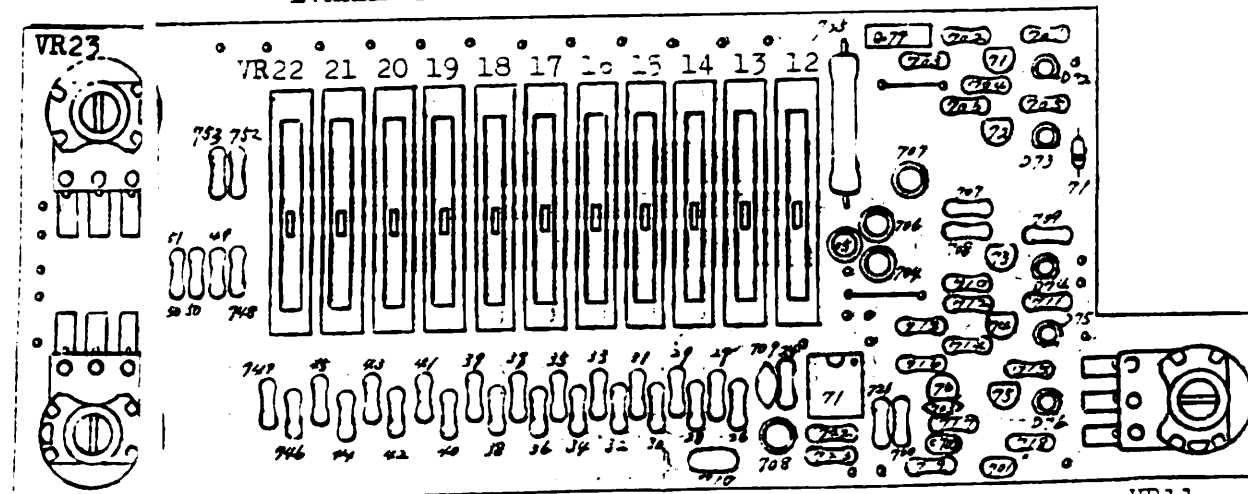

VOLUME! EWJ-EJA320B14 (026-155)
HARMONICS EVH-EQA361 B14 (026-158)

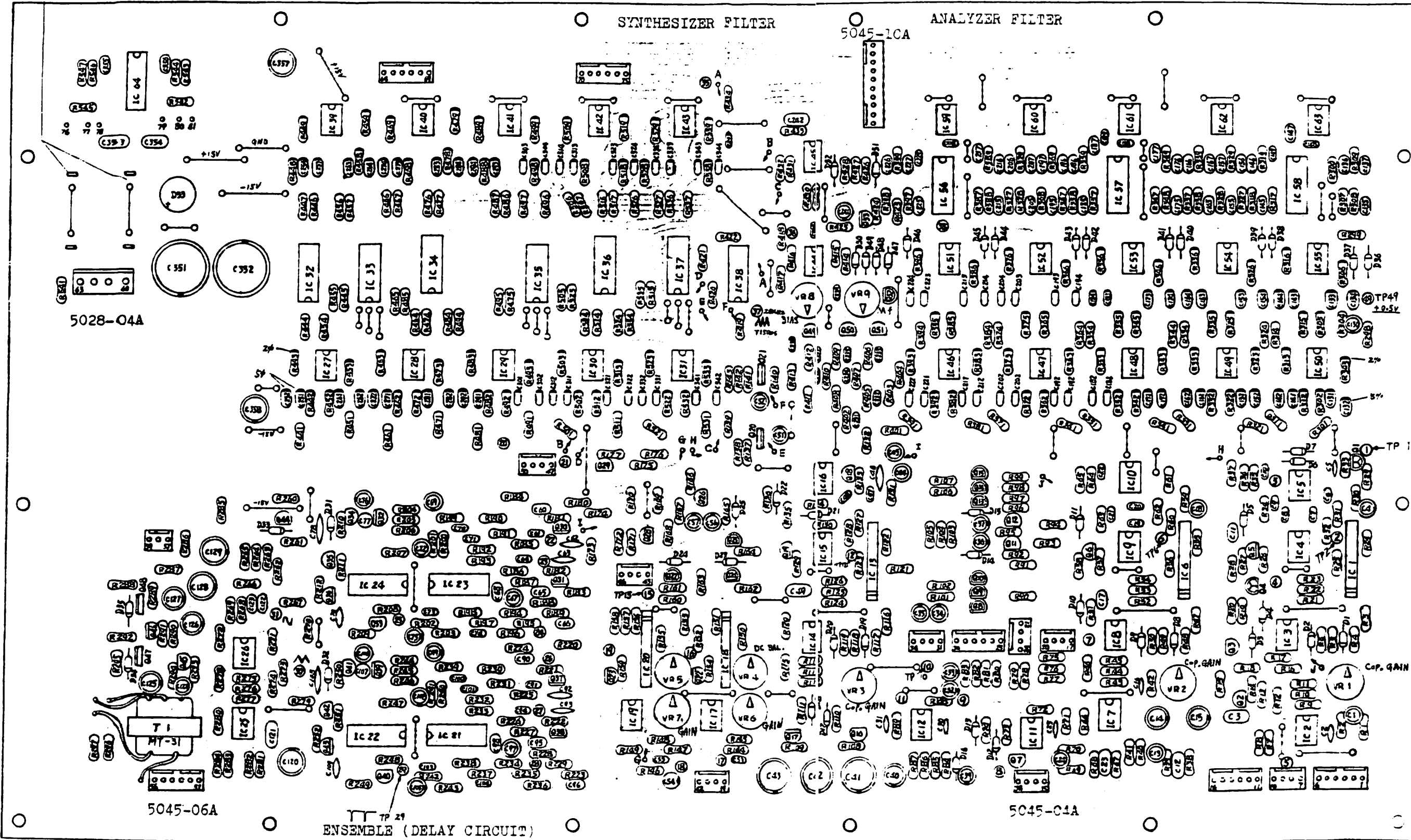

PARTS LIST

072H058	Panel H58 front
065H060	Cover (case) H60
108H003	Handle H3
111-037	Rubber foot K-15
061H092	Chassis H92
016-044	Knob no.44 MIC LEVEL.VOLUME
016-077	Knob no.77 rotary small
016-048	Knob no.48 slider
016-009	Button no.9 blk power switch
010-264	Receptacle NC-3FP or D-3M
009-037	Jack HLJ-0261-01-030
009-040	Jack HLJ-0264-01-020 stereo
009-030	Jack HLJ-0264-01-030
009-046	Jack HLJ-0190-01-030 headphones
001-156	Switch SDG5F001 power 100V
001-216	Switch SDG5F001-216 power 117V
001-217	Switch SDG5P 502 power 220/240V
001-195	Switch SSM02308 slide

PCB ASSEMBLY

145-019	FL-19 (PCB 052-490)	100/117V
145-019D	FL-19D with fuses	220/240V
141-127	AF-127 (PCB 052-491)	mic
149-142	OP-142 (PCB 052-492)	control
149-150	OP-150 (PCB 052H195)	LED
Fuse PCB (PCB 052H185A)		
149-143A	OP-143A	100V
149-144A	OP-144A	117V
149-145A	OP-145A	220/240V

FUSE, FUSE HOLDER

008-026	Fuse SGA 1A prim. 100/117V
008-025	Fuse CEE T500mA prim.sec. 220/240V
012-003	Clip TF-758

022-028N	Power transformer no.28N	100V
022-028C	Power transformer no.28C	117V
022-028D	Power transformer no.28D	220/240V
022-122	Output transformer MT-31	headphones

SEMICONDUCTOR

Transistor

017-022	2SB434-0	or 2SB660-0
017-010	2SD880-0	or 2SD234-0
017-024	2SA733-F	
017-023	2SC945-P	
017-146	2SB605-L	
017-072	2SD571-L	
017-016	2SK30A-GR	FET
017-014	2SK30A-Y	FET

Diode

018-014	1S2473	or equivalent
018-082	W-02	rectifier bridge 1.5A
019-028	TLR-124	red LED
019-029	TLG-124	green LED

IC

020-097	μPC4558C	dual op amp
020-100	TL082CP	dual FET op amp
OR		
020-208	LF353N	
020-219	CD4066BE	quad FET
020-041	TC4013BP	
020-103	TA7179P	±15V
020-216	MN3010	BBD
020-160	BA662A	
020-229	AN6912	quad comparator
OR		
	μPC177C	

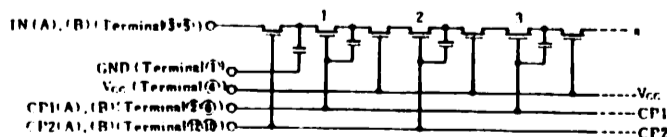
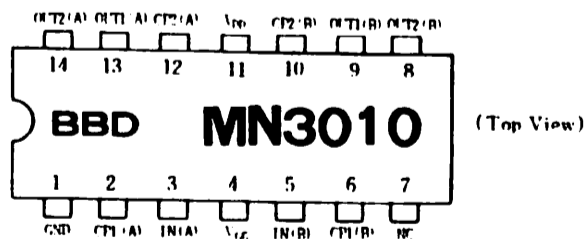

DUAL OP AMP

μPC4558C TL082CP LF353N

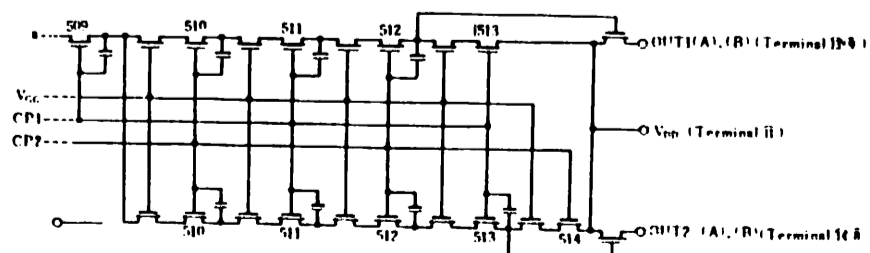
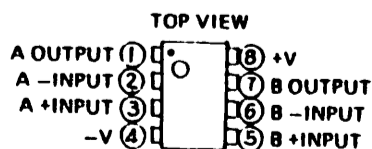

SVC-350 CIRCUIT DIAGRAM

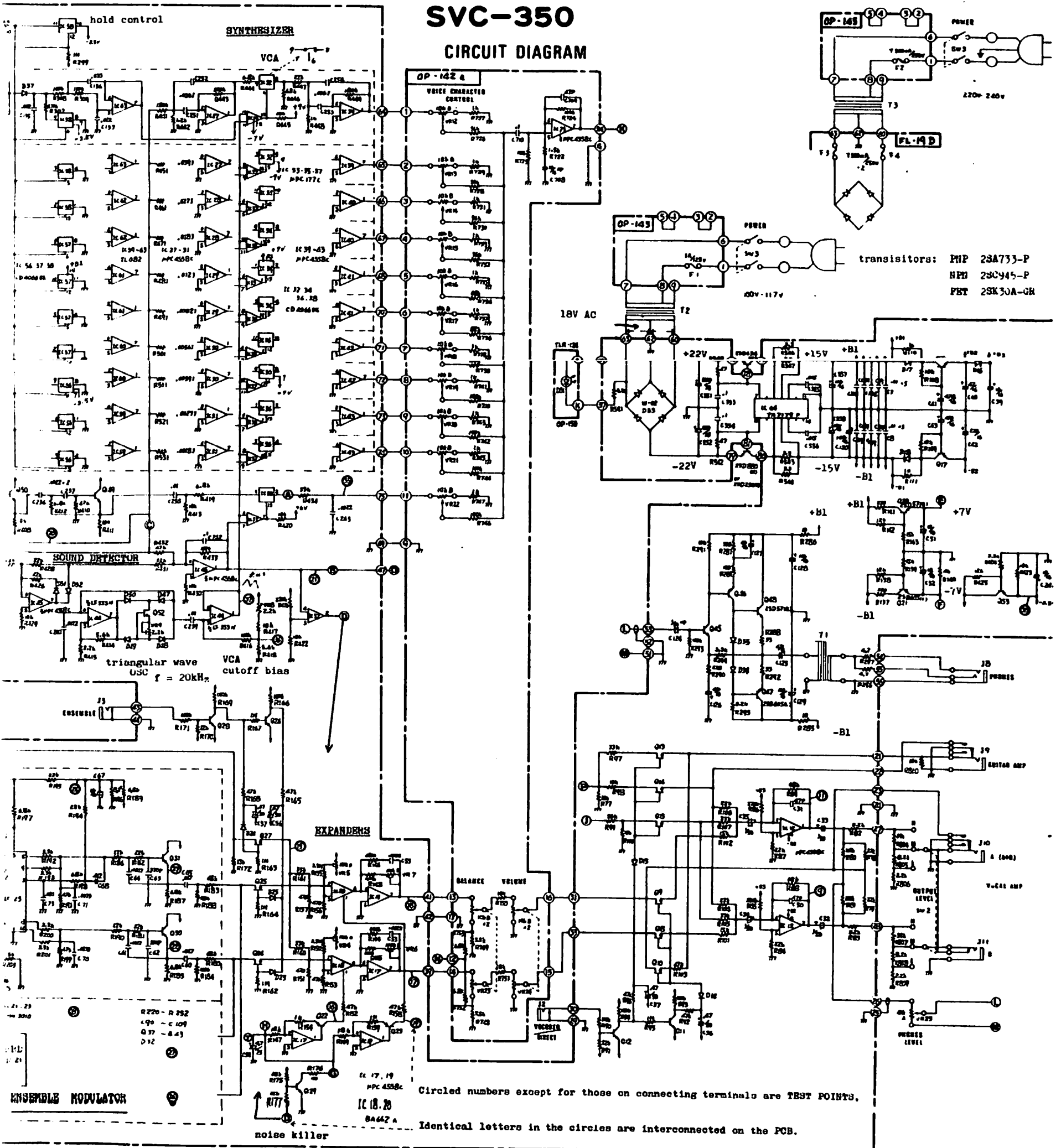

Circled numbers except for those on connecting terminals are TEST POINTS.

Identical letters in the circles are interconnected on the PCB.

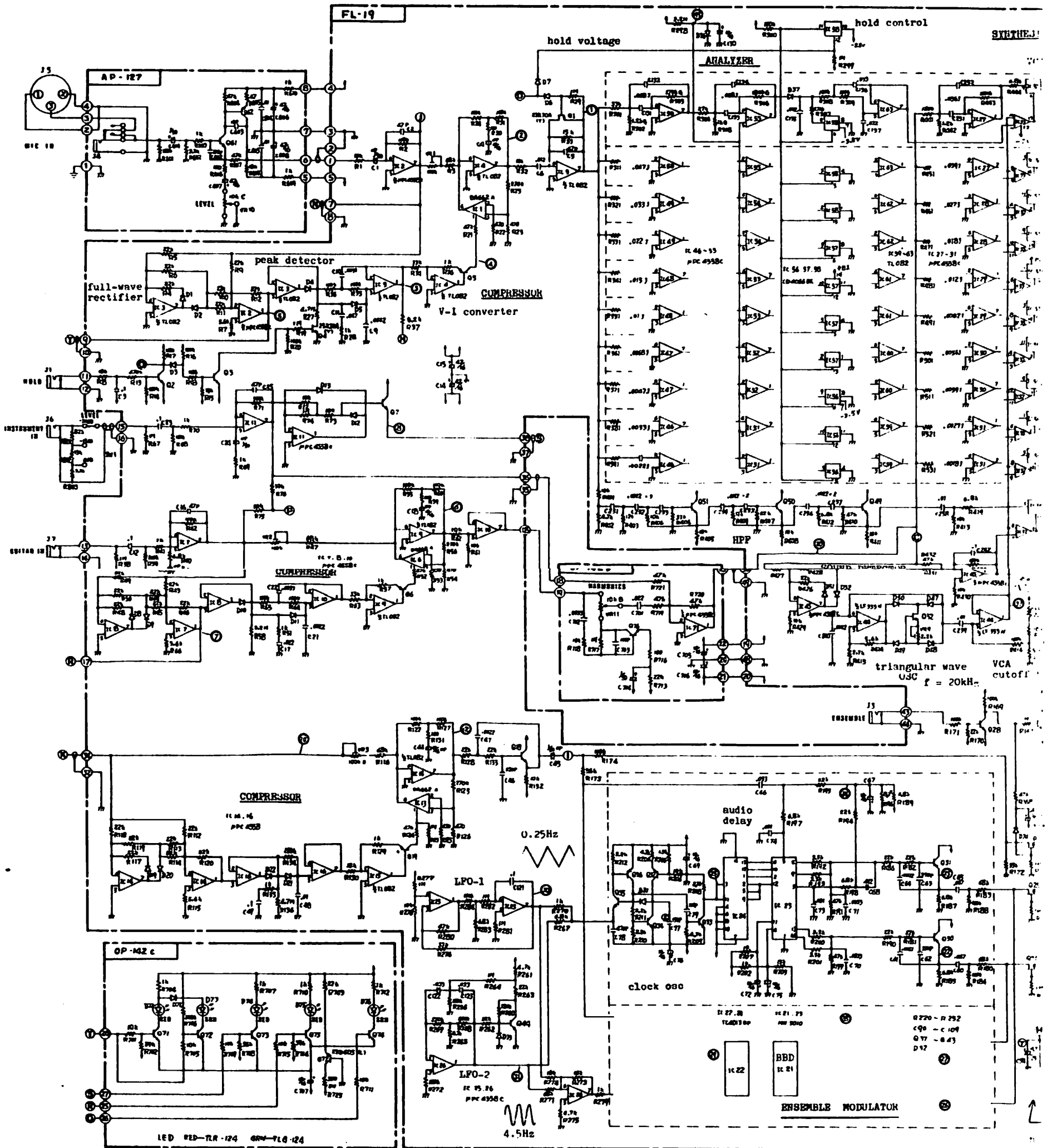

SVC-350

Dec. 8, 1979

.28N 100V
 .28C 117V
 .28D 220/240V
 T-31 headphones

POTENTIOMETER

026-163	EVH8MA361A14	10kA	solder terminal
026-161	EVH6PA361C14	10kC	
026-155	EWJEJA320B14	10kB x 2	
026-158	EVHEQA361B14	10kB	361=K20
029-589	EVAHHPS20B14	10kB	slider
030-461	SR19R	2.2k	trimmer
030-471	SR19R	100k	trimmer

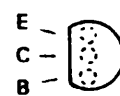

2SA733(P)
 2SC945(P)

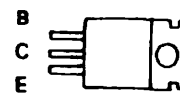

2SD234(O)
 2SB234(O)

CAPACITOR

032-191	ECEA16N10	10mfd	16V non-polar
032-190	ECEA50N1	1mfd	50V non-polar
035-156	ECQS1151JZ	150pf	polystyrene
035-319	ECQI1A473MC	0.047mfd	polypropylene 100.117V
035-310	ECQE2A473MCS	0.047mfd	polypropylene 220.240V
032-228	CE15E1V4R7	4.7mfd	35V k tantalum

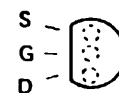

2SK30A(Y)
 2SK30A(GR)

MISCELLANEOUS

064-265	Holder no.265	PCE retainer right angle 396mm long
064-200	PCB holder(fastener/spacer)	DLCBS-6N
120-015	Sleeve nut no.15	3x12mm (spacer or stand-off)
073-037	Polycarbonate collar	3x6x18mm LED
042-032	Terminal TT501D-1	2p mains
042-041	Terminal TT-9-4	ground
048-001	Heat sink no.1	
123-013	Hexagon socket head bolt	4x8mm
065-268	Cover no.268	dust cover, slider
065-261	Cover no.261	dust cover, slide sw.

2SB605 2SD571-L

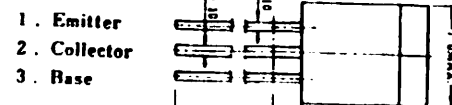

DUAL "D" TYPE FLIP FLOP

TC4013P

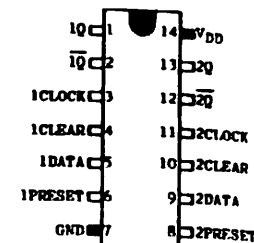

Quad Comparator

μPC177C, AN6912

Connection Diagram (Top View)

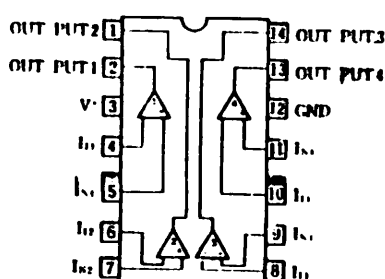

CD4066B E

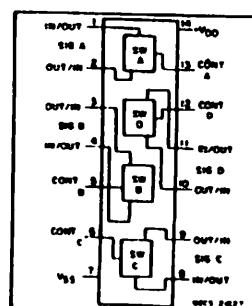

COS/MOS Quad Bilateral Switch

For Logic Systems Applications in Aerospace, Military, and Critical Industrial Equipment

Special Features:

- 15-V digital or ± 7.5-V peak to peak switching
- 80-Ω typical ON resistance for 15-V operation
- Switch ON resistance matched to within 5 Ω over 15-V signal-input range
- ON resistance flat over full peak-to-peak signal range

ADJUSTMENT

3. Vocoder SOUND COMPRESSOR GAIN

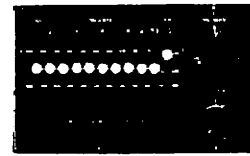

"11": top

To make sure of the compressor function, slide knob "11" down to lowest. The waveform has just reduced to a some extent (depends on knob's traveling speed) is rising and will stop when it reaches half an amplitude of earlier.

4. VCA TRIANGULAR WAVEFORM FREQUENCY

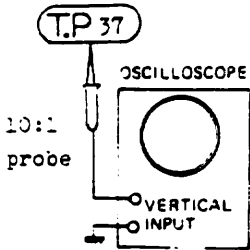

10:1 probe

Use a 10:1 probe for trace clarity.

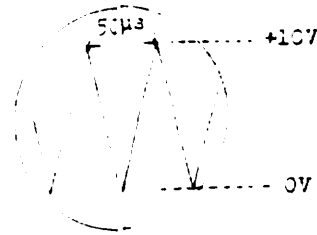

Adjust VR-9 for 50µs period.

5. VCA CUT-OFF BIAS

Feed white noise, 1Vpp into GUITAR input jack.

Slide up CHARACTER CONTROL FREQUENCY knobs "1" to "10" to the top.

Adjust VR-8 until the noise signal just disappears. Excessive turn will result in low VCA output.

NOTE

If this adjustment failed noise reduction, slide down the knobs individually. The signal leaking through a filter will decrease as the corresponding knob being slid down. Check the Analyzer and Synthesizer filters in that frequency chain for malfunction.

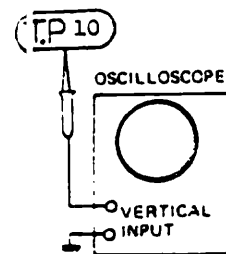

1. MIC COMPRESSOR GAIN

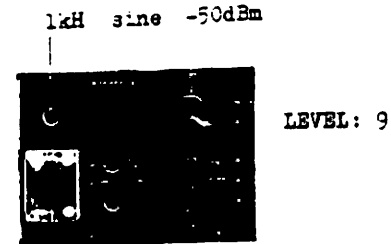

Make sure that the Red LED on the MICROPHONE section goes on and stays on in above set-up.

Adjust VR-1 for 20Vpp at TP-2.

2. GUITAR COMPRESSOR GAIN

Feed a signal, 1kHz, sine -10dBm into GUITAR Input jack.

The Red LED on the GUITAR section should light and stay on.

Adjust VR-2 for 20Vpp at TP-6.

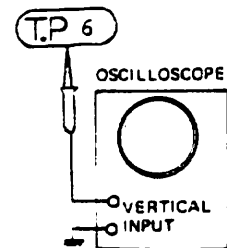

Waveform Checking

With HARMONICS knob turned fully clockwise, a waveform similar to the waveforms in the figure below should be seen at TP-20.



6. EXPANDER DC BALANCE

Place a ground on TP-15. Plug a blank plug into ENSEMBLE jack to open the jack circuit.

- Connect TP-16 to a ground. Adjust VR-4 so that TP-17 becomes 0V DC.
- Connect TP-19 to a ground. Adjust VR-5 so that TP-18 becomes 0V DC.

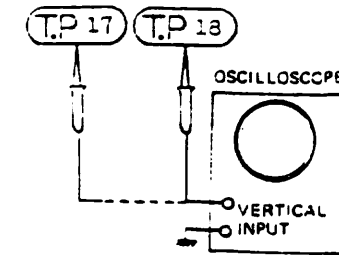

7. EXPANDER GAIN

Feed a signal, 1kHz, sine -5dBm into TP-15.

Connect TP-16 and TP-19 to the ground.

- Adjust VR-6 for 3Vpp at TP-17.
- Adjust VR-7 for 3Vpp at TP-18.

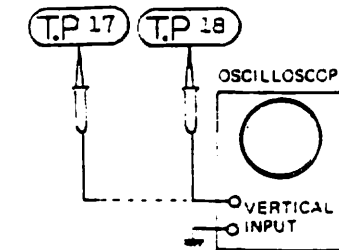

BBD MODULATING VCO WAVEFORM CHECKING

T = 4-5sec (approx.) at TP-30

T = 0.2-0.23sec at TP-31
E = 17Vpp at TP-31

T = 4µs-15µs (approx.) at TP-25, TP-29

Being modulated by the composite signal (sine and triangular waveforms), the waveforms at TP-25 and TP-29 sweep slowly with joggling.