

ELECTRONIC MUSICAL INSTRUMENT

ROLAND RHYTHM INSTRUMENT
Rhythm 77

SERVICE NOTES

THE 7th EDITION
Printed in Japan '76. Nov.

 **Roland**

CONTENTS

| | |
|--|----|
| GENERAL BLOCK DIAGRAM | 1 |
| SECTION 1. SPECIFICATIONS | 2 |
| SECTION 2. THEORY OF OPERATION | 3 |
| SECTION 3. GENERAL NOTICE | 6 |
| SECTION 4. DISASSEMBLING | 7 |
| SECTION 5. LOGIC CIRCUIT | 8 |
| SECTION 6. RHYTHM SWITCH ASSEMBLY | 12 |
| SECTION 7. VOICE GENERATOR CIRCUIT | 16 |
| SECTION 8. CONTROL CIRCUIT | 18 |
| SECTION 9. ALIGNMENT PROCEDURE | 20 |
| SECTION 10. PARTS LIST | 28 |

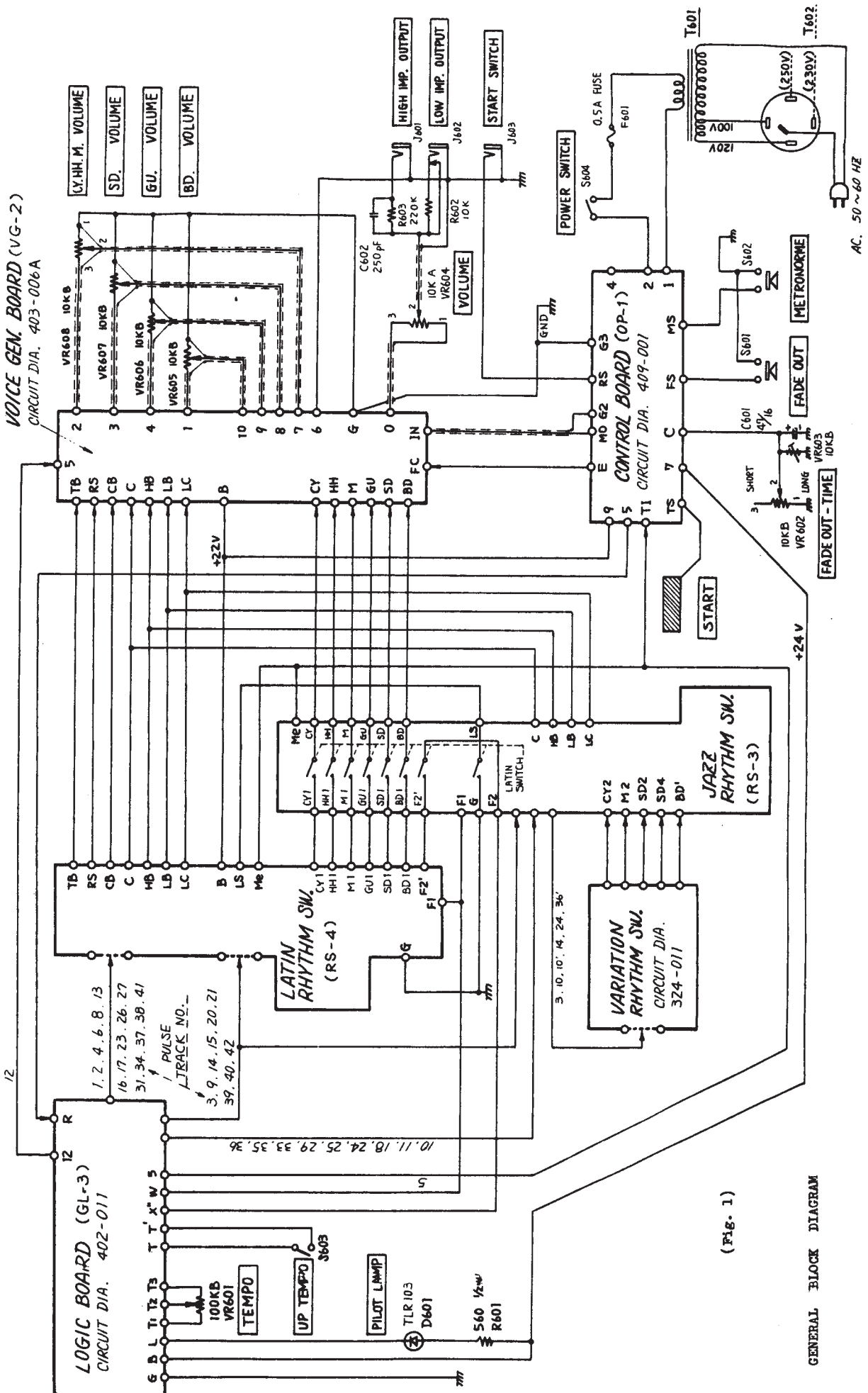

(Fig. 1)

GENERAL BLOCK DIAGRAM

SECTION 1. SPECIFICATIONS

1-1. Summary

A. Rhythm Jazz Section Rock'n Roll 1, Rock'n Roll 2, Slow Rock, Ballad, Western, 6/8 March, Jazz Waltz, Waltz, CANCEL.

Latin Section Rhumba, Beguine, Cha-Cha, Mambo, Samba 1, Samba 2, Baion, Bossanova, Bolero, Tango.

2 Beat Variation Bass Drum, Bass & Snare Drum, Fox Trot 1, Swing 1, March, Parade.

4 Beat Variation Bass Drum, Bass & Snare Drum, Fox Trot 2, Swing 2, Swing 3, Shuffle.

B. Voices Bass Drum, Low Conga, Low Bongo, High Bongo, Cow Bell, Rim Shot, Claves, Snare Drum, Maracas, Cymbal, High Hat, Guiro, Tambourine.

C. Voice Control

1. Cymbal, High Hat, Maracas 2. Guiro 3. Snare Drum

4. Bass Drum

D. Tempo of Beat 12 - 130 Beats/Min.

| | | |
|------------------------------|----------------------|---------|
| E. Number of Active Elements | Silicon Transistors | 41 pcs |
| | Silicon Diodes | 175 pcs |
| | Light Emitting Diode | 1 pce |
| | IC | 1 pce |

1-2. Apperance

A. Dimension Width 640mm Highth 95mm Depth 310mm

B. Weight 7.5Kg

C. Finish Walnut Finish with Hard Resin

D. Accessory Connecting Cord (with Pin-Plug Adapter), Foot Switch

E. Controler Start-Stop, UP-TEMPO, METRO NONE, FADE-OUT Control, Voice Control, Volume Control, Tempo Control.

F. Others Foot Switch Jack, Output Jack, Pilot Lamp

1-3. Electricity

A. Output Max. 8.0V(p-p) Low impedance out-10Kohm
High impedance out-200Kohm

B. Power Supply 100V - 240V 50/60 Hz

C. Power Consumption 4.9VA

SPECIFICATIONS SUBJECT TO CHANGE WITHOUT NOTICE

SECTION 2. THEORY OF OPERATION

ROLAND RHYTHM TR-77 consists of four elemental sections and a power supply. The first elemental section is operation system for rhythm patterns, including a master oscillator, a reset circuit, TOUCH START and a TEMPO LAMP. The second elemental one is rhythm selector system which selects pulse patterns coming out of the operation system. The third is voice generator system, and the fourth is audio preamplifier. The Following Figure 1 shows the abovementioned.

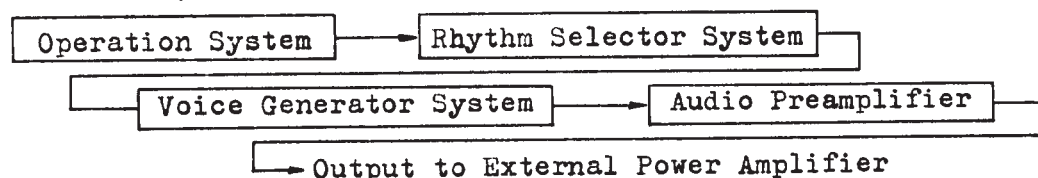

(Fig. 2)

2-1. Operation System

The operation system is divided into master oscillator, divider, matrix, reset START circuit and TEMPO LAMP. Master oscillator is a multi-vibrator of two transistors. Tempo is controlled by adjusting bias voltage to the oscillator, which is three potentiometers of series connection. One is the slowest tempo, and the other is the fastest tempo. The another one, which is fixed on the control panel, is used by a player for adjusting a very delicate tempo.

Divider is 5 stage transistor flip-flop counter set for dividing a beat cycle into $1/32$ cycle of the master oscillator. As a $3/4$ beat rhythm must be necessary, the second and third stage divide a beat cycle as the unit of 3 instead of 4 with feed back between the output of the third and second stage of the dividers. The output of the stage-four divider is supplied to the base of the transistor for lighting up the TEMPO LAMP. The TEMPO LAMP will light-up to the first beat. But only for SLOW-ROCK and BALLAD rhythm, light will come on the first and third beat. The control of brightness is adjusted in advance on light-up time. For the TEMPO LAMP, a light emitting diode is used. Output of divider are connected to the diode matrix which is taking pulse patterns. Various pulse patterns are used as a trigger of a voice generator. Touch switch consists of radio frequency oscillator, detector, flip-flop, and part of oscillator connected to Touch plate on the control panel. When this plate is touched with hand, oscillation will stop and this voltage fluctuation is used for trigger of flip-flop, and so rhythm will either stop or start.

Up-Tempo Switch ----- Up- Tempo Switch works remarkably when you want to double the tempo suddenly and enjoy performance. Press the switch " ON " and the tempo will be doubled instantly. With "OFF" switch pressed, the tempo is restored to the former state.

Up-Tempo Switch adds interest and pleasure to your performance.

2-2. Rhythm Selector

The selection of rhythm patterns is made up by a push button switch divided into two stages on the control panel and a rotary switch.

Push buttons at the two stage are separated beat buttons for the variation section and a JAZZ section and LATIN section. The gate circuit provides for working on the push of " LATINS " to select the signal from a pulse pattern generator lest two trains of buttons should interfere with each other.

When this button is turned off, the output signal of the diode matrix is biased by positive voltage and the voice generator will not work. Therefore, when the push button " LATIN " is not pushed, even if the button of LATIN section is pushed, the rhythms of LATIN will not come out. On adjusting the push button to " LATIN ", you are listening to a rhythm of LATIN. While you push a JAZZ section button, the push button " LATIN " is automatically returned, you will hear a JAZZ section rhythm as soon as the LATIN rhythm goes out. And yet rotary switch for variation works by pushing " 2 BEAT " or " 4 BEAT " button. The necessary pattern of the rhythm indicated by a buttons is connected with the voice generator. Buttons of WALTZ, JAZZ WALTZ, SLOW ROCK, BALLAD, and BOLERO, provides for the circuit to feed back on the divider for making $3/4$ beat.

The diode connected with the rhythm switch helps the diode matrix and keeps away from affecting JAZZ and LATIN rhythms to each other.

2-3. Voice Generator

ROLAND RHYTHM TR-77 has 13 voice generators including Bass Drum, Low Conga, Low Bongo, High Bongo, Rim Shot, Cow Bell, Claves, Snare Drum, Cymbal, High-Hat, Maracas, Tambourine and Guiro.

Each of Bass Drum, Low Conga, Low Bongo, High Bongo, Rim Shot, Cow Bell, and Claves oscillates by electrical input pulses given to each L-C resonantly circuits of necessary frequency and index decayed oscillation. Drum sound of Snare Drum has a buffer amplifier by transistor in addition to L-C resonantly circuits, and likewise oscillates. For

outputs potentiometers may be set in order to control the output level. Cow Bell is combined with binary different frequency oscillators. The outputs of these L-C resonant circuits are coupled to audio pre-amplifier. The transistor, reversely biased, provides the basic "WHITE NOISE" which is generated in Cymbal, High-Hat, Maracas, Snare Drum and Guiro. The output of noise generator is given to the first amplifier and three semifixed resistors are parallelly connected with the collector load of the amplifier. They are used for adjusting the output level of treble sound including Cymbal, High-Hat, Maracas, Snare Drum and Guiro. The signal affects a tuned amplifier after passing the required envelope circuit. This time it is compounded with " WHITE NOISE " signal. The output from the tuned amplifier, moreover, adds to the preamplifier.

Guiro is oscillated by outputs for trigger matrix, exclusively made from the diode matrix outputs, different from other outputs. The other different kind of signal comes into the base of the transistor, works the multivibrator composed of two transistors, and oscillates the diode matrix outputs more closely. This multi-vibrator makes out the efficient percussion sounds of Guiro itself. The frequency of the multi-vibrator comes from the bias adjustment of a semifixed resistor for providing beforehand. The output of the multi-vibrator feeds a tuned amplifier with " WHITE NOISE " signal. And this tuned amplifier is the narrow band amplifier, and the output passing this amplifier comes into the preamplifier.

2-4. Audio Output

Both the signal of a high frequency territory and that of a low frequency territory are added to the preamplifier. The outputs feed to the volume control fixed on the control panel. Moreover, it feeds to obtain outputs of the full auto-rhythm instrument through the buffer resistance. Preamplifier consists of 3 parts of amplification, the 2nd of which is IC of Electronic Attenuator for the fadeout.

2-5. Touch Switch

Touch switch circuit to reset logic circuit consists of radio frequency oscillator, bufferamplifier, flip-flop and oneshot.

Radio frequency oscillator works regular oscillation.

The output of oscillator is added to the base of bufferamplifier after

it is rectified. When you touch the touch plate mounted on the control panel, the oscillator stops oscillation. The voltage that was rectified minus comes up to "0".

This rise up voltage moves the bias of buffer amplifier and let it turn on. The collector voltage of buffer amplifier is used for trigger of flip-flop, and the output of flip-flop is used for trigger of oneshot. The output of transistor usually in the turn-off state is connected with the reset terminal of Logic board. While this transistor turns on (time between 20 and 30mS), master oscillator and divider are reset. Because they are set immediately after "turn-off", they can count from the 1st beat.

2-6. Start Switch

Start switch jack mounted on the rear side of rhythm unit is connected with the terminal " RS " of control board assembly.

Start switch is used as a substitute for time switch. When the start switch is placed " ON " or " OFF ", flip-flop and oneshot can work accordingly.

2-7. Metronome

The metronome is generated by a phase shift oscillator which decays exponentially. Frequency is adjusted by potentiometer. The metronome switch is used as a flip-flop trigger.

2-8. Fade-out

When the fade-out switch is pushed, condenser of CR Time Contrast is earthed. At this time, the resistor of CR Time Contrast is connected with the base of PNP transistor.

The emitter of this transistor is connected with the control input of electronic attenuator mounted on the voice generator board assembly.

SECTION 3. GENERAL NOTICE

3-1. Avoid playing near the fluorescent light, neon light, transformers etc., as they will create undesirable noises.

3-2. It is absolutely free from sound distortion, but it should be played within the capacity rating of the amplifier. It is always advisable to connect to amplifiers having ample output power.

3-3. Since it covers a very wide range of tones, the quality of tones may vary according to the types of amplifiers used. Use any amplifiers having high selective qualities.

3-4. Avoid using " RHYTHM ROLAND " in high temperature and humid places, also remember that accumulated dust will take damp.

SECTION 4. DISASSEMBLING

When disassembling the cabinet, remove wood screw on three points of rear side and six points of the bottom with a screw driver.

Logic Board

B. Circuit Diagram (GL-3) (Fig. 4)

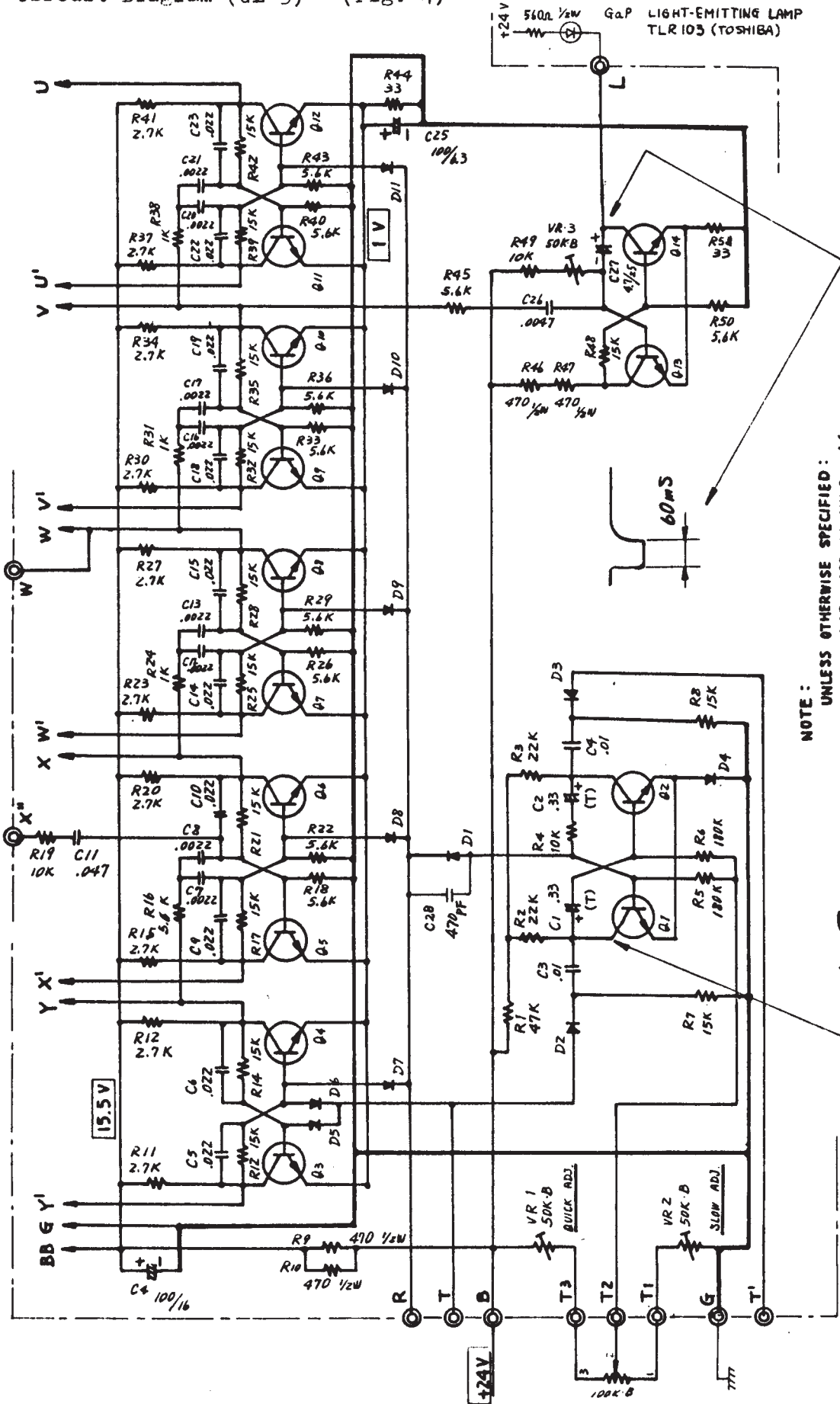

NOTE :
 UNLESS OTHERWISE SPECIFIED :
 ALL RESISTOR ARE IN OHMS , 1/4 W .
 ALL CAPACITOR ARE IN MFD .
 ALL TRANSISTOR ARE TYPE 2N2218-B or R
 ALL DIODE ARE TYPE 1N4148
 (T) Tantalum Capacitor

37.5 ~ 300 mS
 Q1 + Q2 = MASTER OSC

SECTION 5. LOGIC CIRCUIT

5-1, Logic Matrix Board Assembly (GL-3)

A. Parts Layout (Fig. 3)

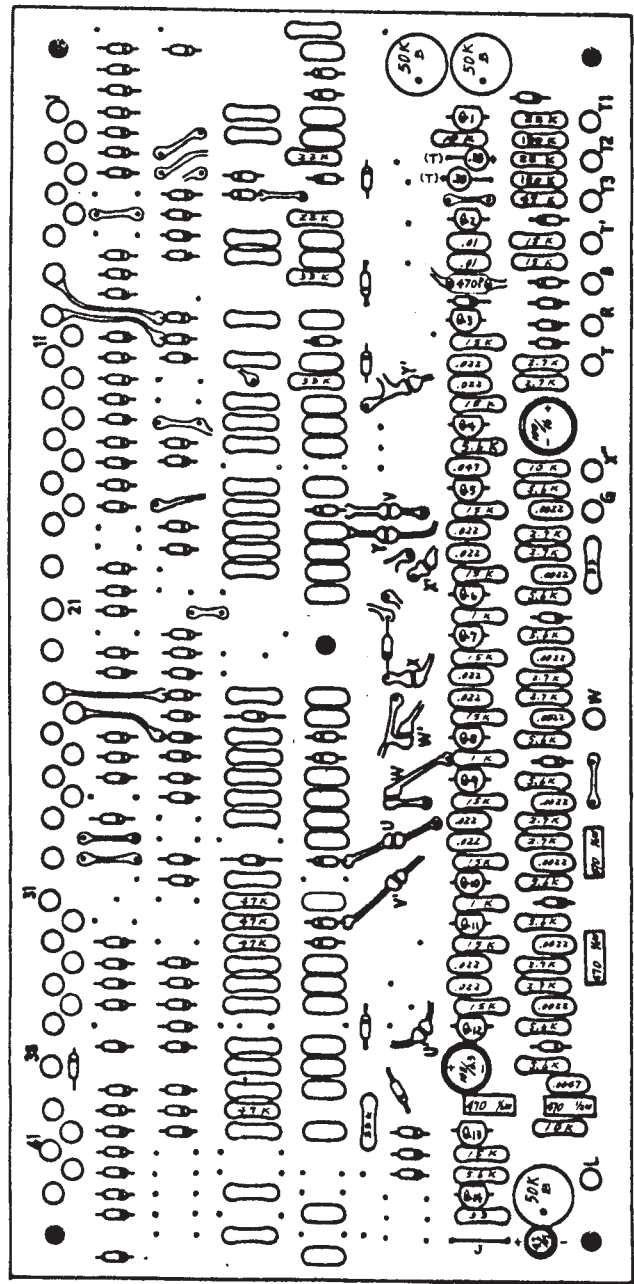
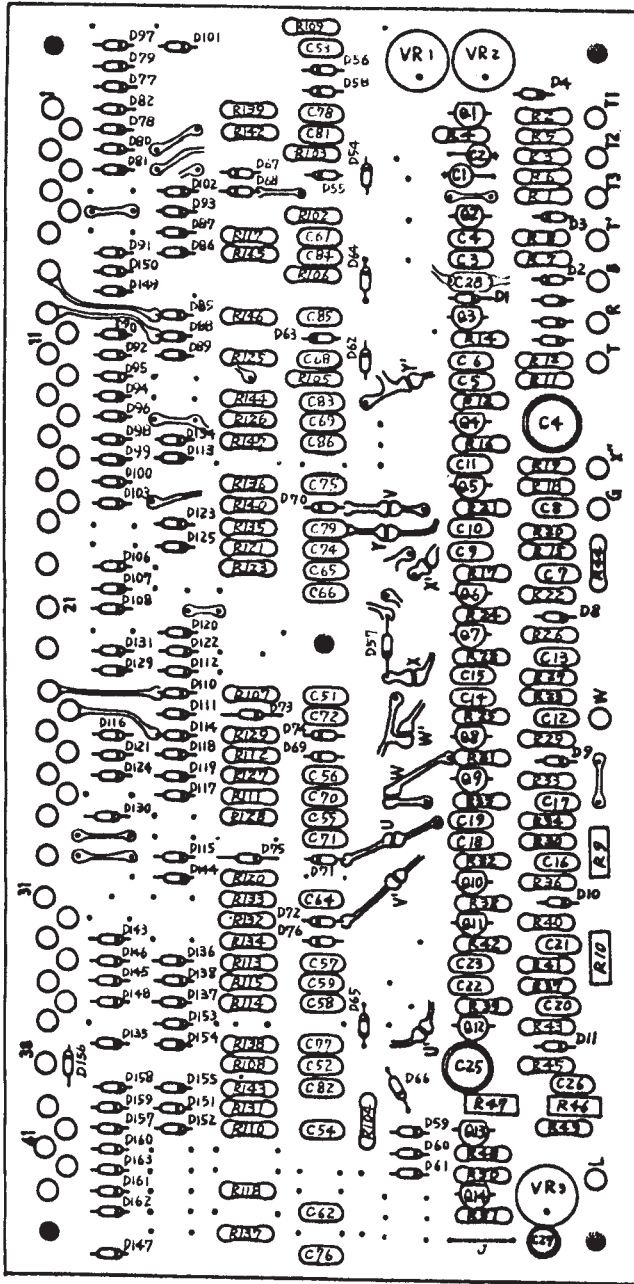

UNLESS OTHERWISE SPECIFIED:

D1 - D14 25C020-R

D 1S1555

C : .059 μ R : 270K

(T) Tantalum Capacitor

5-2. Matrix Circuit

A. Circuit Diagram (Fig. 5)

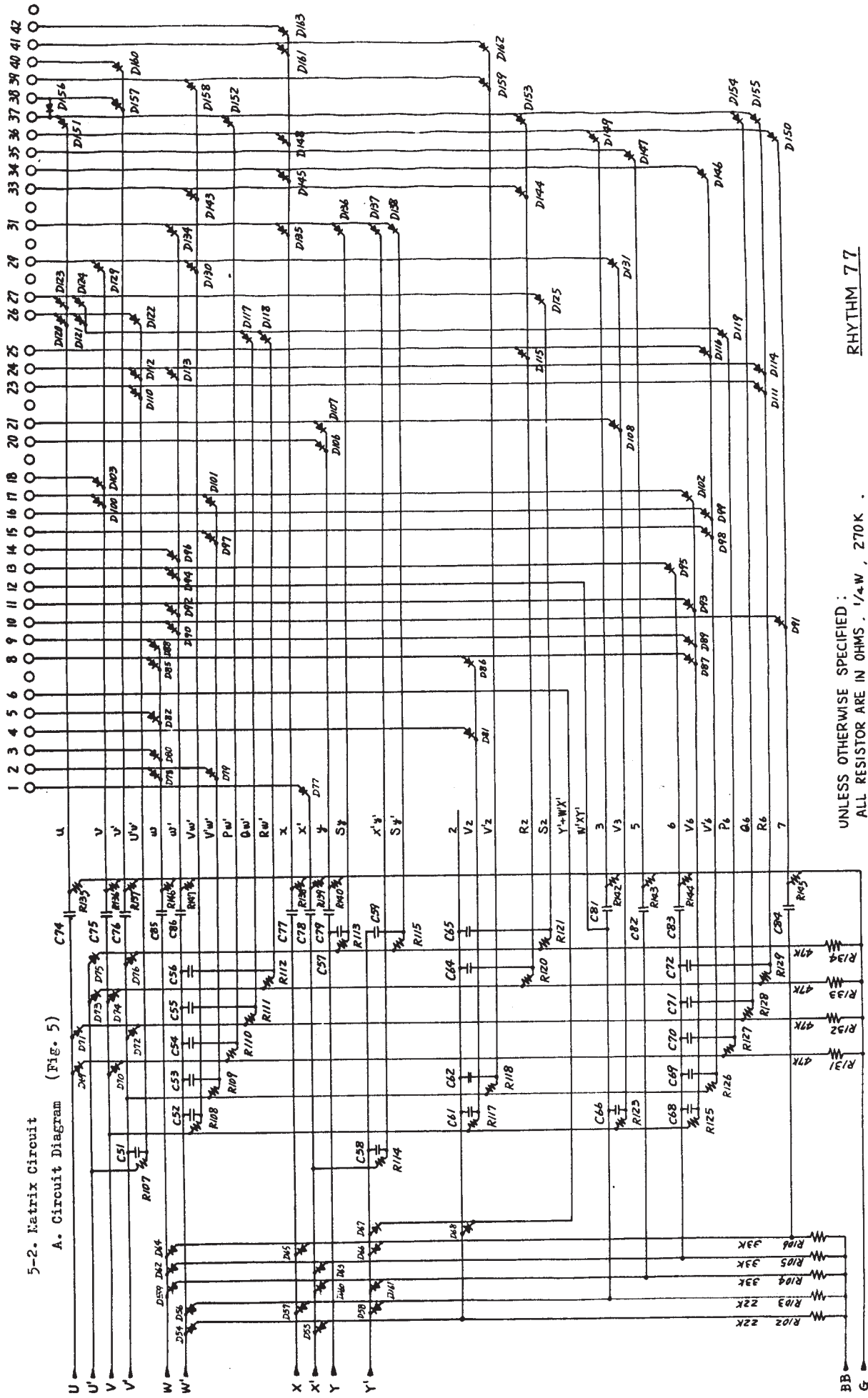

UNLESS OTHERWISE SPECIFIED :
 ALL RESISTOR ARE IN OHMS . 1/4W , 270K .
 ALL CAPACITOR ARE IN MFD . 50V . .039 .
 ALL DIODE ARE TYPE 1S1555

RHYTHM 77
 MATRIX CIRCUIT

B. Logic Output Timing Chart (Fig. 6)

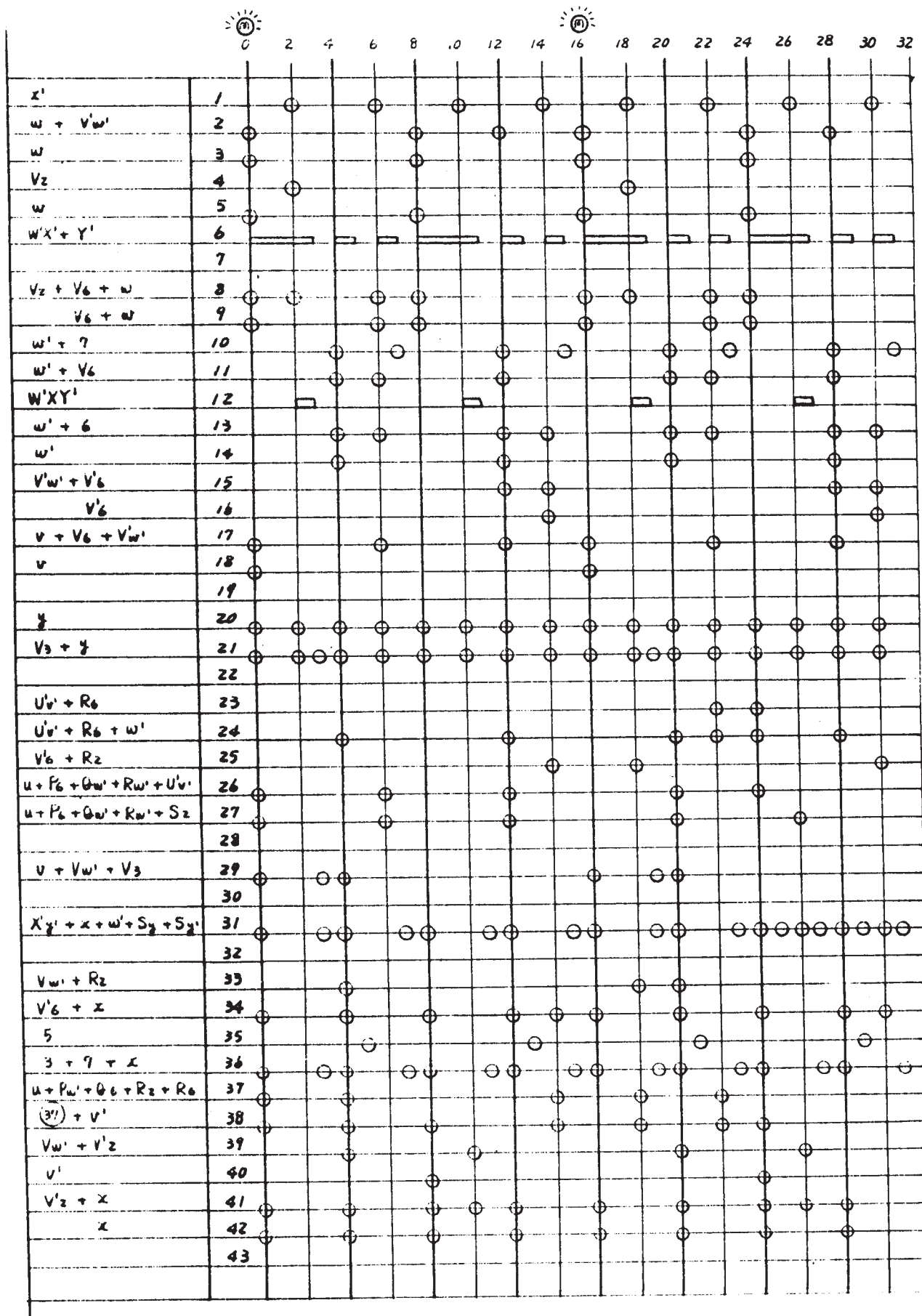

SECTION 6. RHYTHM SWITCH ASSEMBLY

6-1. Jazz Section Switch Assembly (RS-3) (Fig. 7)

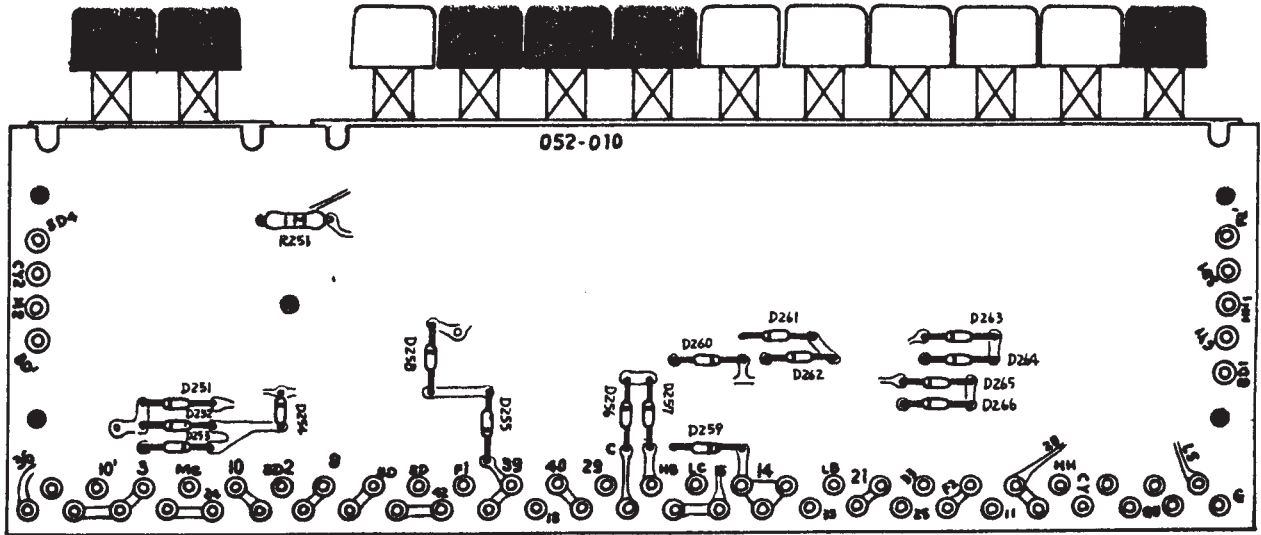

6-2. Latin Section Switch Assembly (RS-4) (Fig. 8)

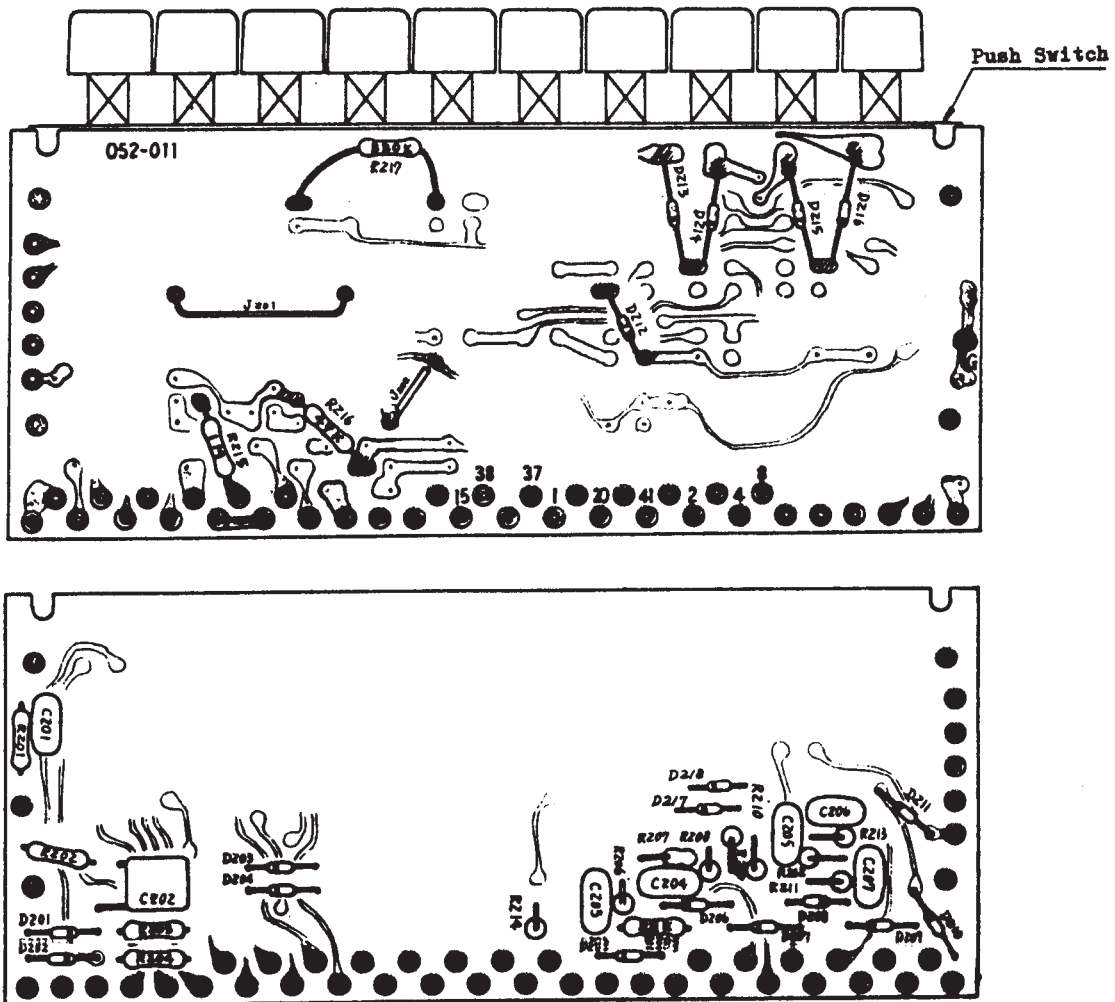

UNLESS OTHERWISE SPECIFIED

C : IPE
 R : IM
 D : 181555

6-3. Rhythm Pattern
A. Jazz (Fig. 9)

B. Latin (Fig. 10)

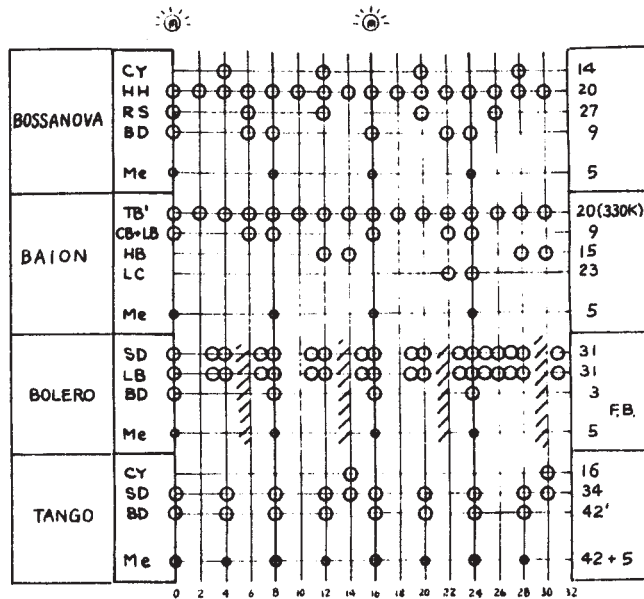
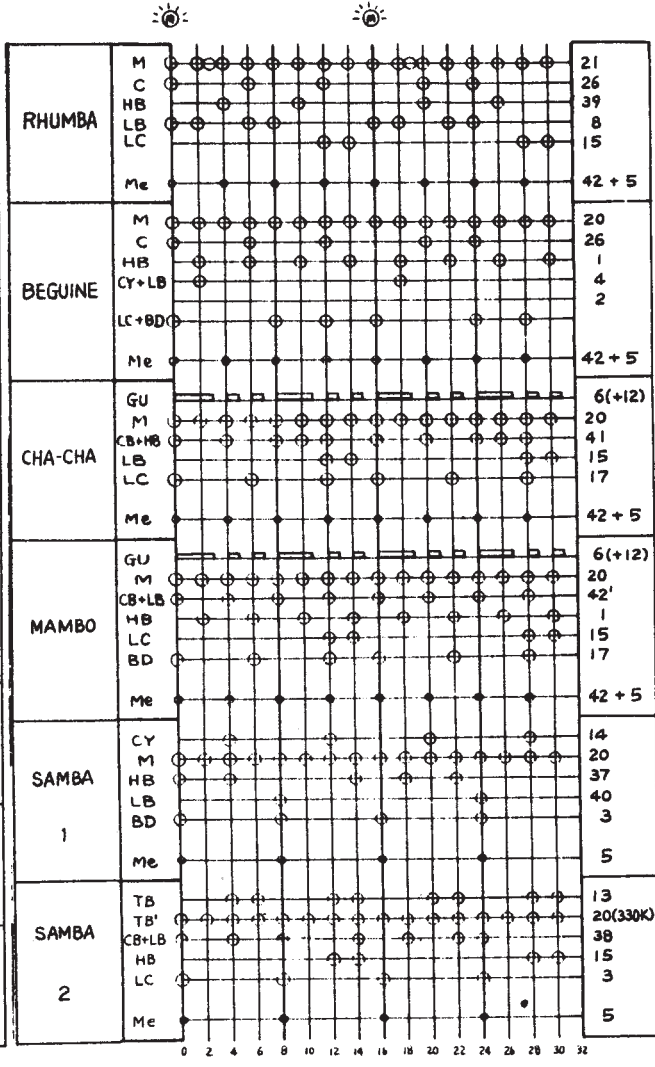
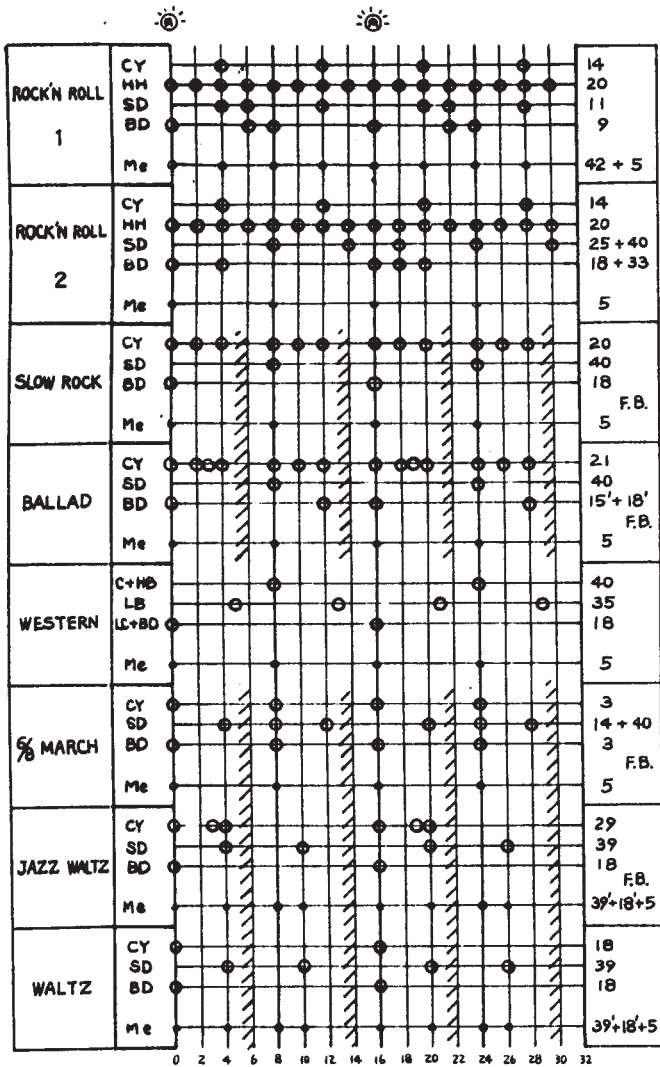

6-4. Variation Section

A. Relation Diagram of Beat Selector and Rotary Switch

(Fig. 11)

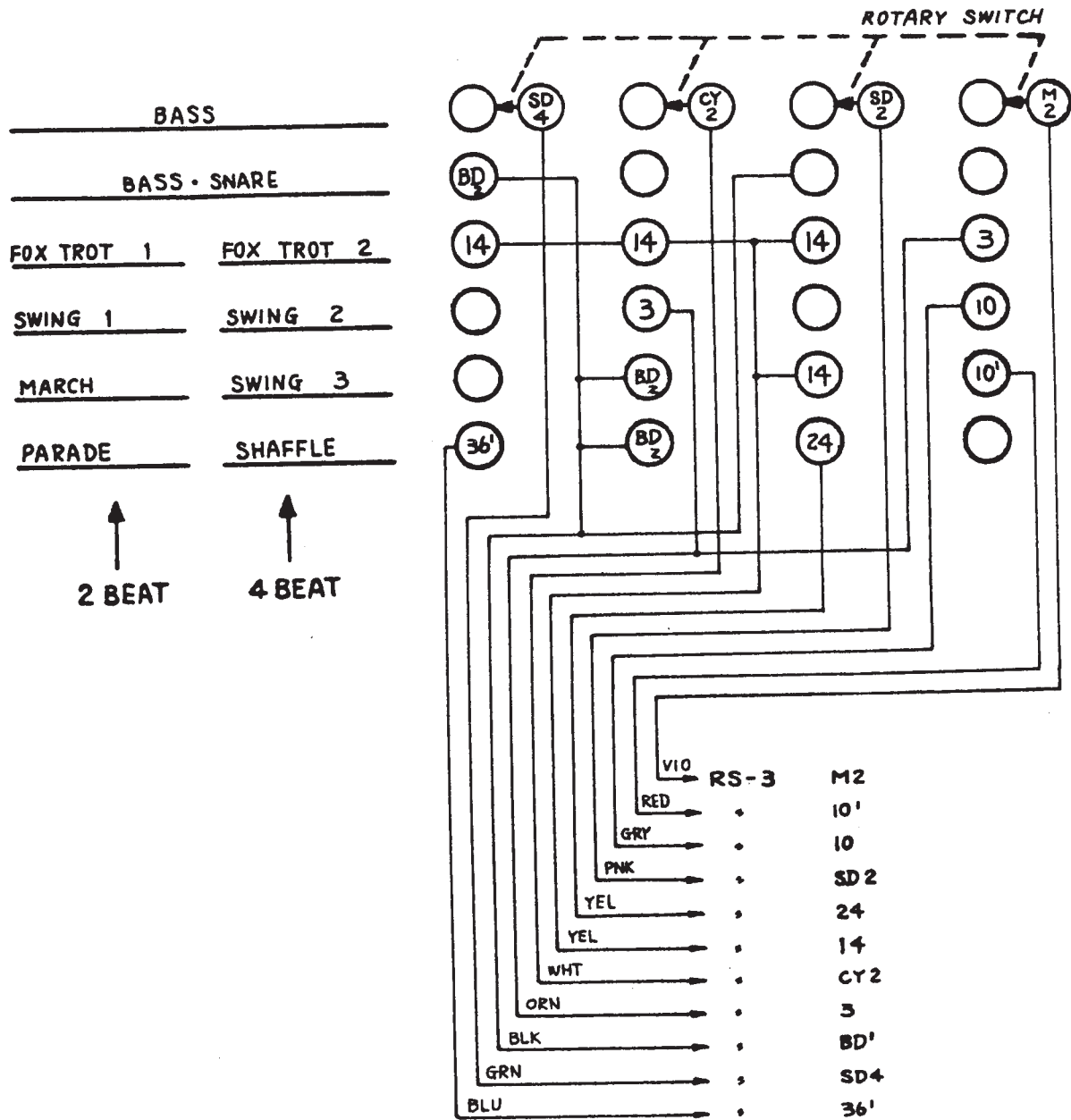

B. Rhythm Ensemble Pattern (Fig. 12)

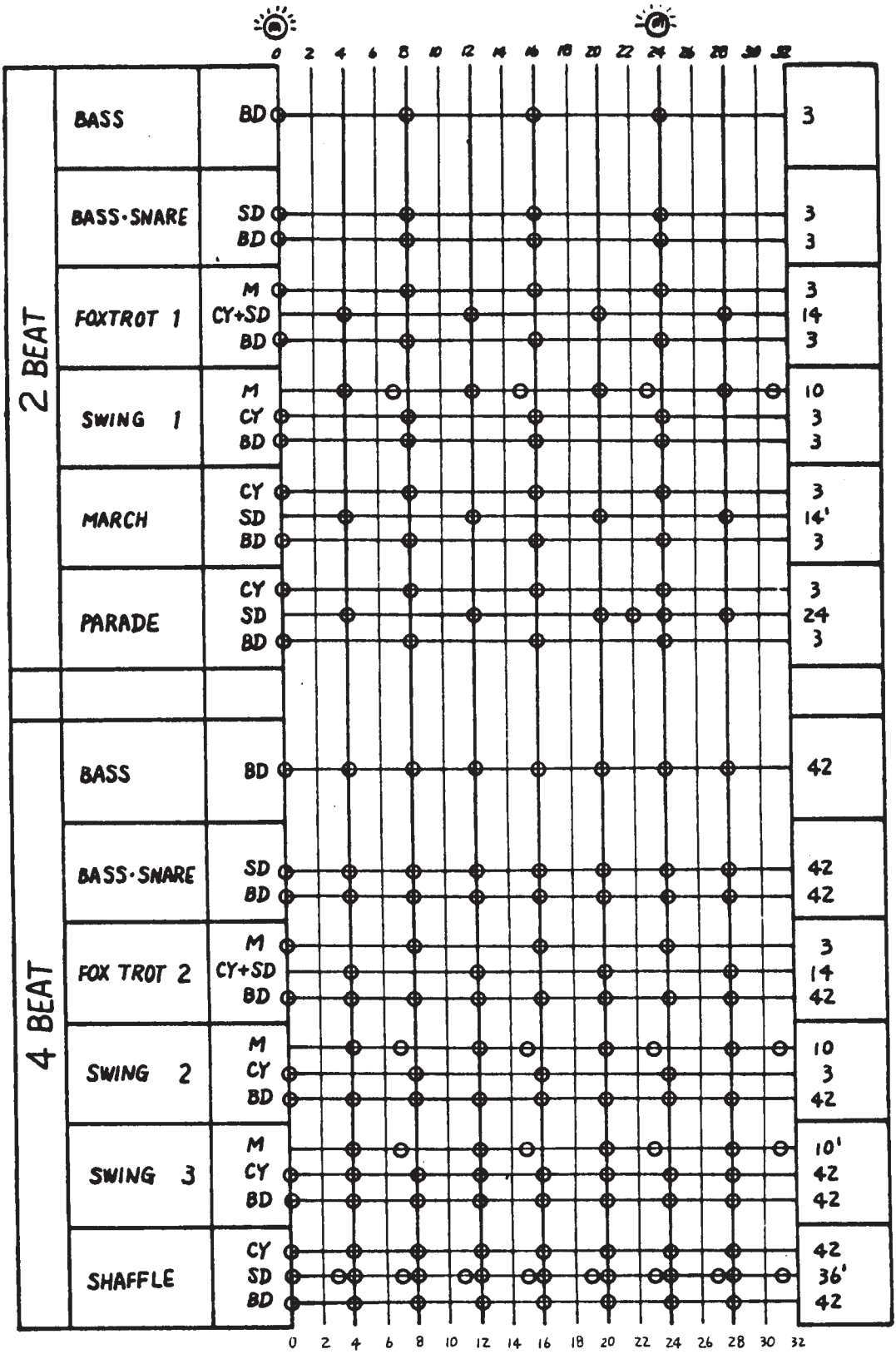

SECTION 7. VOICE GENERATOR CIRCUIT

7-1. Voice Generator Board Assembly (VG-2)

A. Parts Layout (Fig. 13)

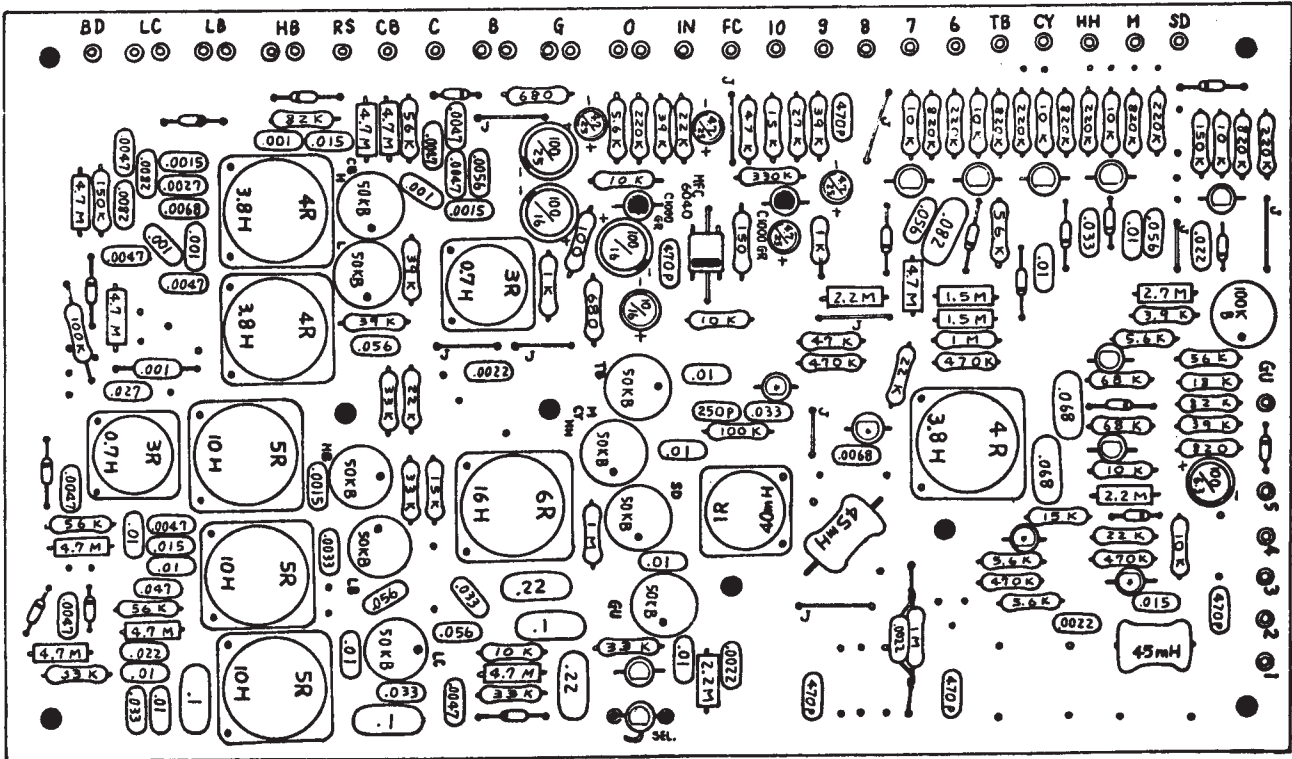
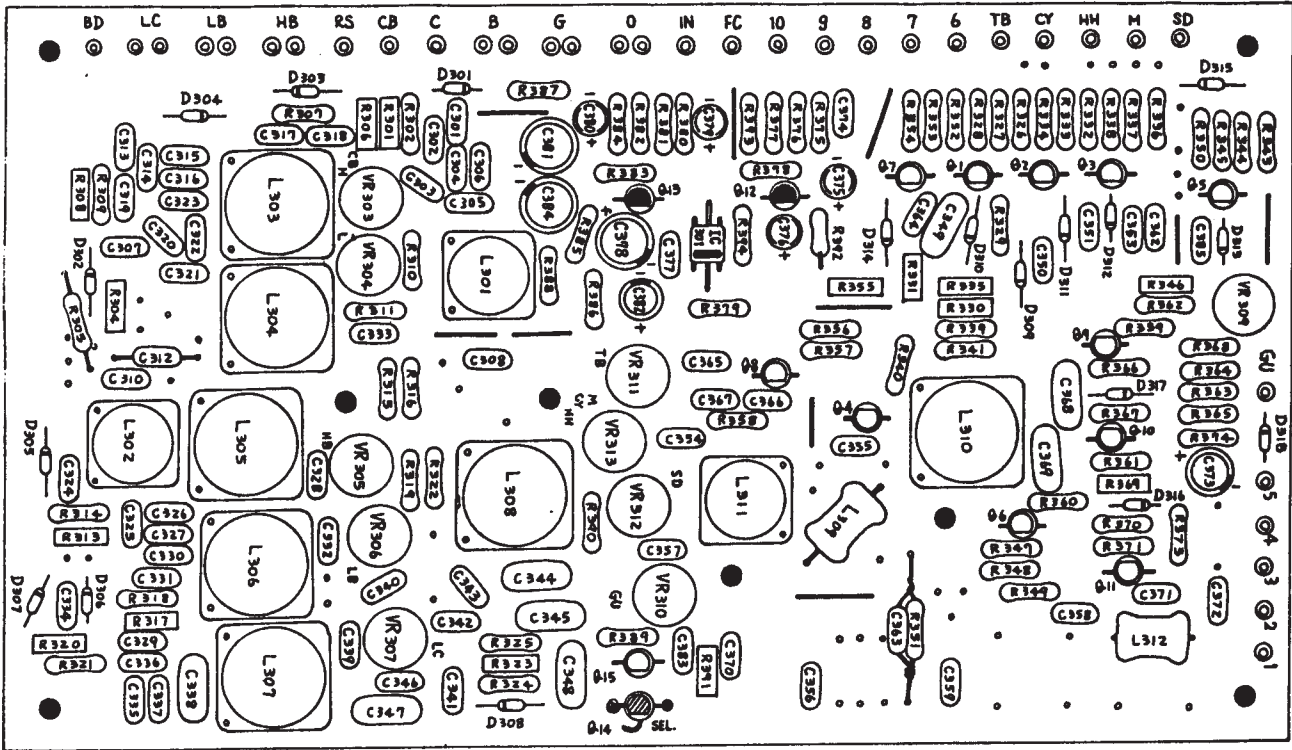

C352 is soldered on rear side of the board, between collector and base of Q3.



25C 1060 QR
25C 372 Y
1S 1555

D. 1S1555 or 1S2473
Tr 25C372Y

Voice Generator

B. Circuit Diagram (VG-2)

(Fig. 14)

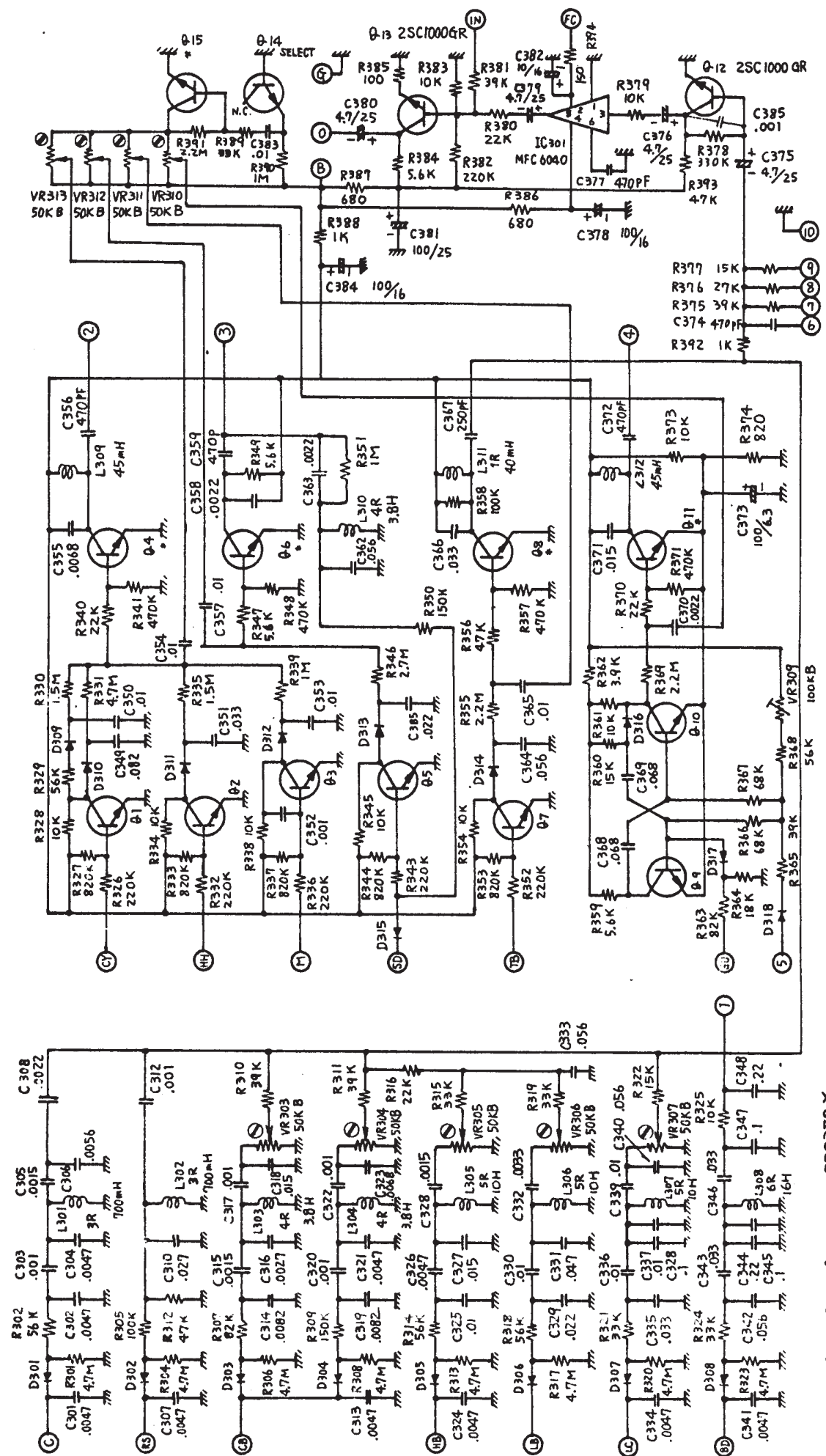

Q1 ~ Q11, Q15 : 2SC372-Y
 Q14 : Selected (for Noise)

SECTION 8. CONTROL CIRCUIT

8-1. Control Board Assembly (OP-1)

A. Parts Layout (Fig. 15)

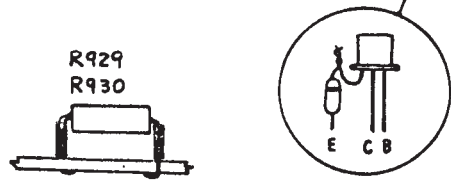
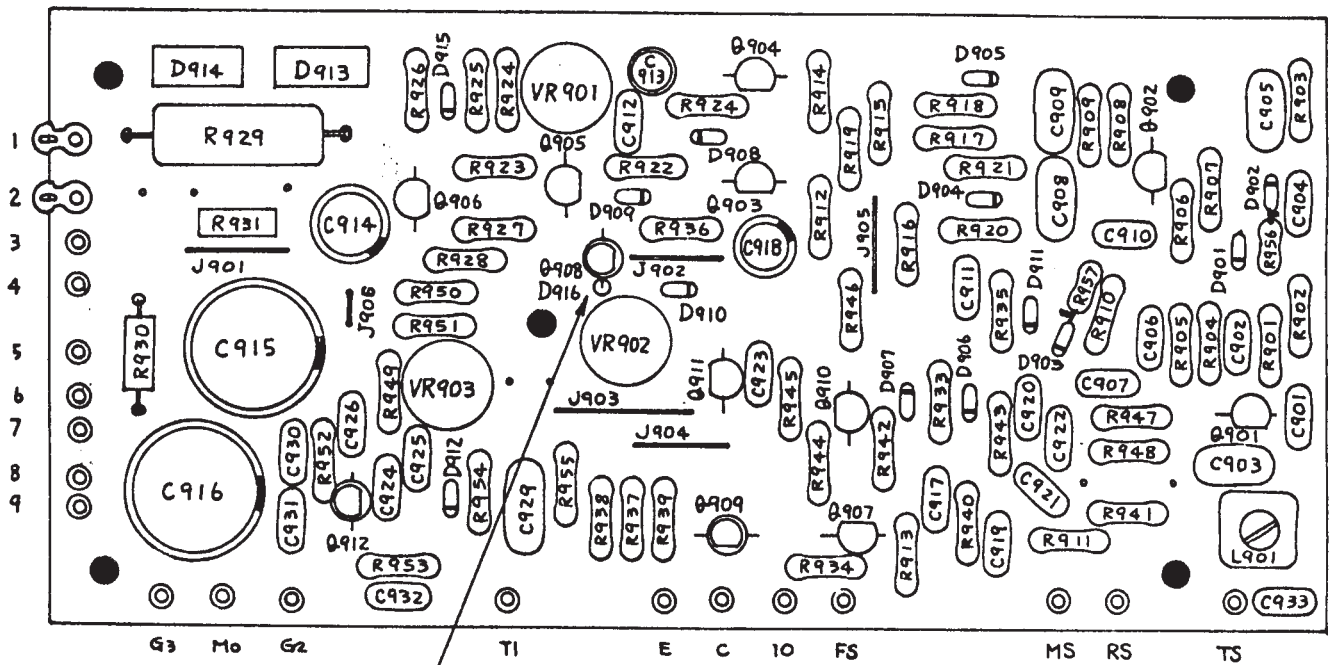
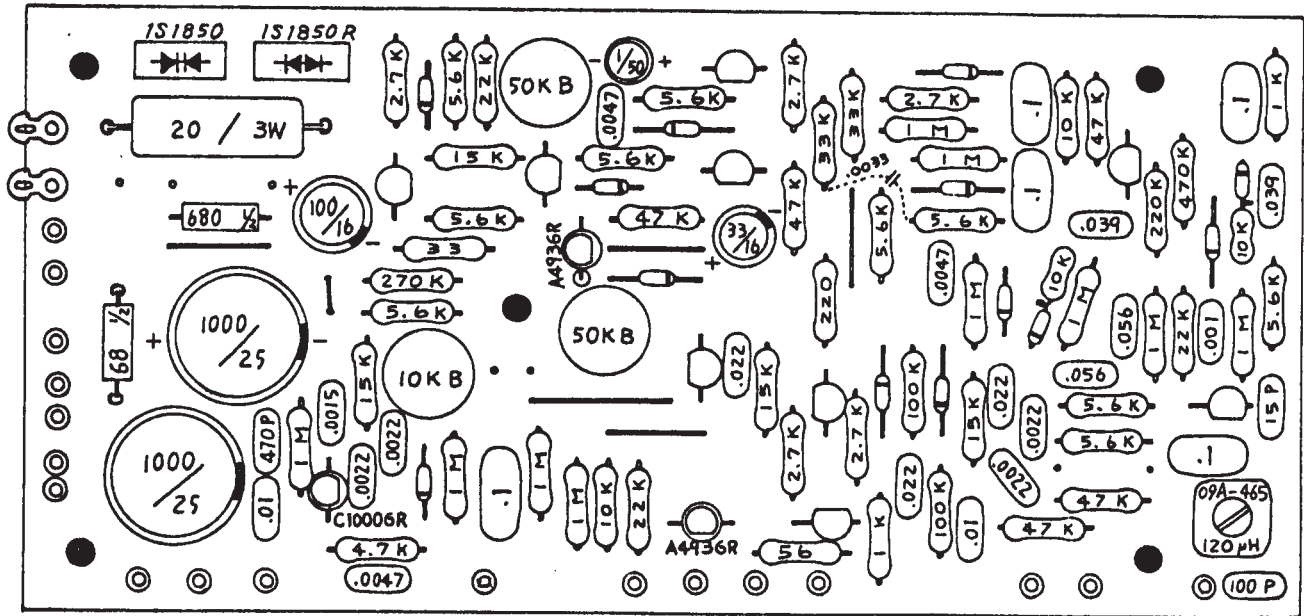

Q901 ~ Q907, Q910, Q911 : 2SC828-R or Q
 D901 ~ D912 : 1S1555 or 1S2473

B. Circuit Diagram (OF-1) (Fig. 16)

UNLESS OTHERWISE SPECIFIED:
 ALL RESISTOR ARE IN OHMS, 1/4W.
 ALL CAPACITOR ARE IN MFD.
 ALL TRANSISTOR ARE TYPE 2SC828-R.
 ALL DIODE ARE TYPE 1S1555 OR 1S2473.

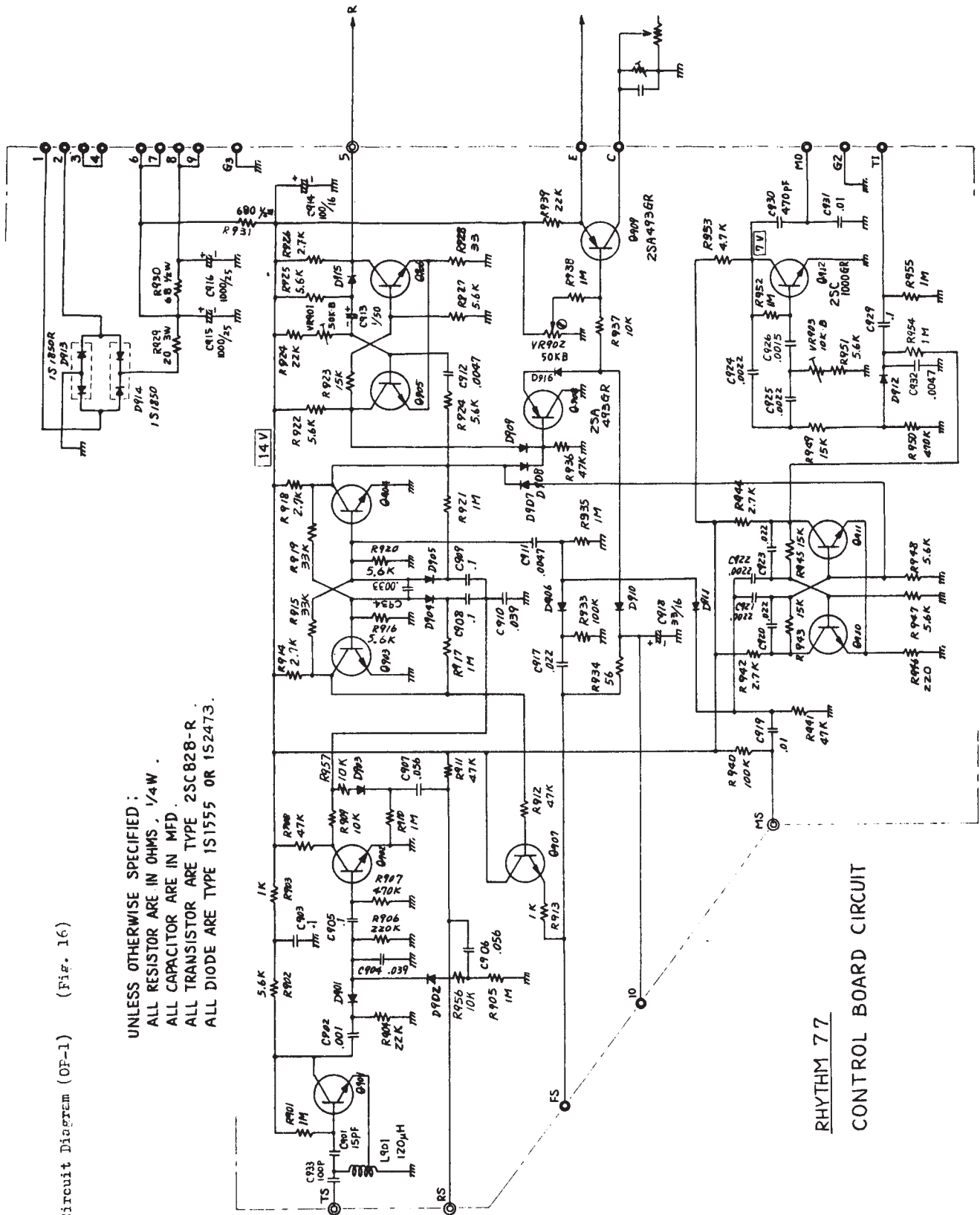

SECTION 9. ALIGNMENT PROCEDURE

9-1. Logic Circuit

A. Adjustment of Tempo Speed

B. Rating

For oscillation period of Master Oscillator(Q1, Q2)

$$37.5\text{mS}(\text{QUICK}) - 300\text{mS}(\text{SLOW}) \quad \pm 10\%$$

C. Adjustment

In case of measuring wave form of logic output terminal T or T' by the oscilloscope.

- At the right end of tempo slide volume (QUICK), adjust semifixed resistor VR1 so as to make the period of measured negative pulse as 37.5mS.
- At the left end of tempo slide volume(SLOW), adjust semifixed resistor VR2 to make the period of negative pulse as 300mS.
- Repeat above-mentioned procedures and adjust semifixed resistor VR1 and VR2 satisfactorily.

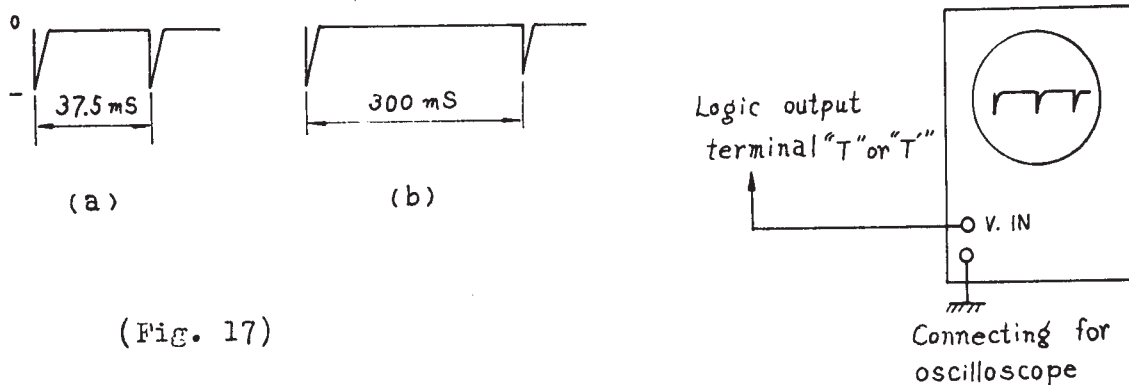

D. Checking the wave form of collector of Master oscillator

Seeing the wave form on the collectors of Q1 and Q2, and check the wave forms whether they are as Fig.B undesirable wave form including unsaturated territory. In this case, it is necessary to use the oscilloscope of which input impedance is not less than 5000K Ohms.

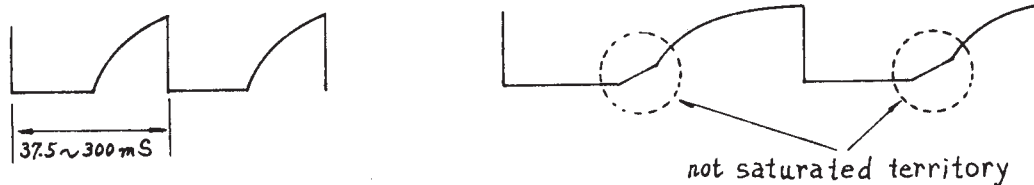

(Fig. 18)

E. For symmetrical the wave form of output of the Master oscillator
The wave form on the collector becomes not to be symmetrical,
because of instability of the circuit constant of the Master oscil-
lator.

This circuit constant is set as following mention, and adjust it
by changing the capacitor C1 or C2.

$$T_1 = \frac{T_1 + T_2}{2} (\pm 20 \%)$$

(Fig. 19)

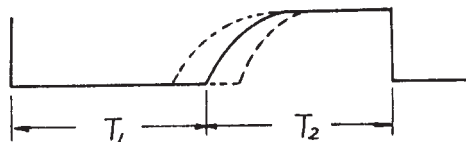

F. When the UP-TEMPO switch is set "ON", check the tempo speed to be
double, despite the place of the tempo volume. In case that oscillo-
scope is connected with logic output terminal "T", the period of
pulse observed becomes to 1/2.

9-2. Adjustment of Tempo lamp

See wave form at the logic board terminal L by the oscilloscope, and
adjust semifixed resistor VR3 so as to get the lighting time of the
light emitting diode as 60mS.

(Fig. 20)

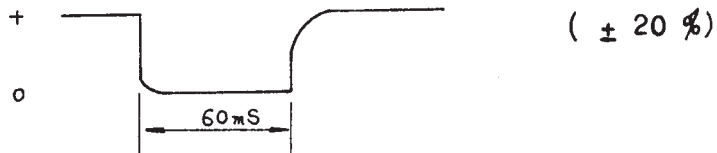

9-3. Voice Generator

A. Adjustment by measuring wave form on the oscilloscope

Logic output terminal "3"(pulse track No.3, negative pulse) is a
standard triggerpulse, adding input terminal of each voice generator
except Guiro's.

The period of a standard trigger pulse is generally 0.6 seconds at
UP TEMPO " OFF ". Measure voltage of output terminal "0" on the
voice generator PCB, and connect jack output(Low out) with an ampli-
fier. In case of listening to sound at the same time, connecting an
amplifier, take down the volume position not to be due to output
terminal.

Set the percussion level control knobs(Cymbal.High-Hat.Maracas,
Guiro, Snare Drum, Bass Drum) to right end on the scale.

Set the Fade-Time control knob to left end on the scale.

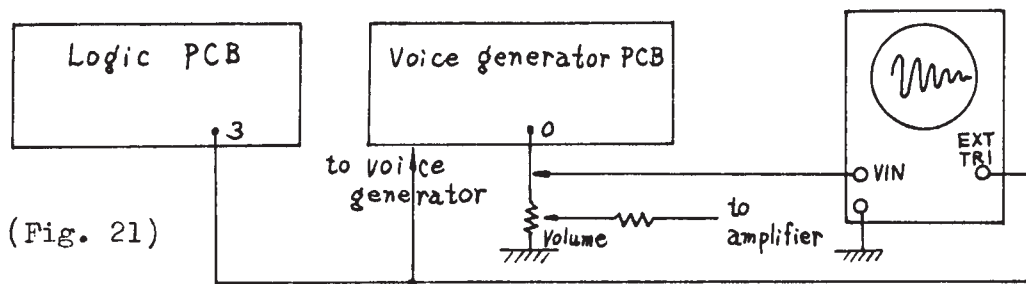

(Fig. 21)

B. Adjustment of the noise section (M, Cy, HH, SD, TB, GU)

a) Adjustment of Maracas

Connect a trigger pulse with terminal " M " on voice generator PCB, and adjust semifixed resistor VR313 so that the level of output voltage may reach 2.0V. Check decay time within regular value.

b) Adjustment of Cymbal

Connect a trigger pulse with terminal " Cy " on the PCB, and check decay time and output voltage within regular value.

(output adjuster of Cymbal is same Maracas)

c) Adjustment of High -Hat

Connect a trigger pulse with terminal " HH ", and see output voltage within regular value. Check decay time within regular value.

(The High-Hat adjuster for output is to do the same semifixed resistor VR313 that Maracas's and Cymbal's)

outputs of M, Cy, HH

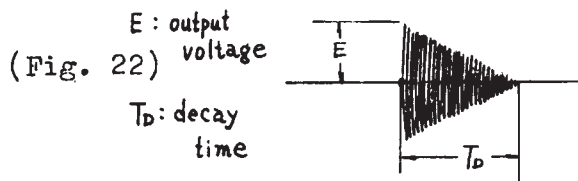

(Fig. 22)

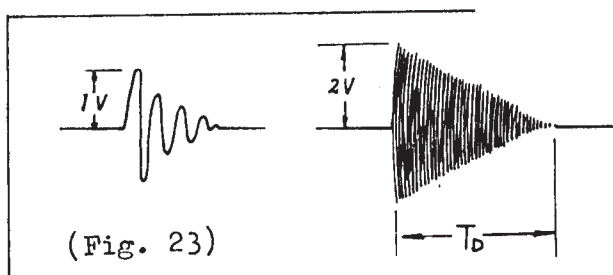

(Fig. 23)

d) Adjustment of Snare Drum

Connect a trigger pulse with terminal " SD " on PCB.

Measure voltage of output at terminal " 0 " on PCB.

Check the frequency within regular cycles. And then turn semifixed resistor VR312 so that the level of " Noise " may reach 2.0V. And also check decay time within regular time.

e) Adjustment of Tambourine

Connect a trigger pulse with terminal " TB ", turn semifixed resistor VR311 so as to get the output voltage as 0.4V. And check decay time within standard time.

f) Adjustment of Guiro

The square wave is only used for Guiro.

Connect trigger No.6 on the Logic PCB in case of Guiro, and connect trigger No.12 with terminal Gu on the voice generator board.

To begin with, check the wave form on the collector of Q10 by the oscilloscope, and adjust semifixed resistor VR309 so as to make the period of negative pulse as 13mS. Check the period of the pulse to be no more than 8 mS., in adding positive square wave to the terminal No.5 on the voice generator board.

(The output of No.12 on the Logic PCB is conveniently used for EXT. trigger of the oscilloscope.)

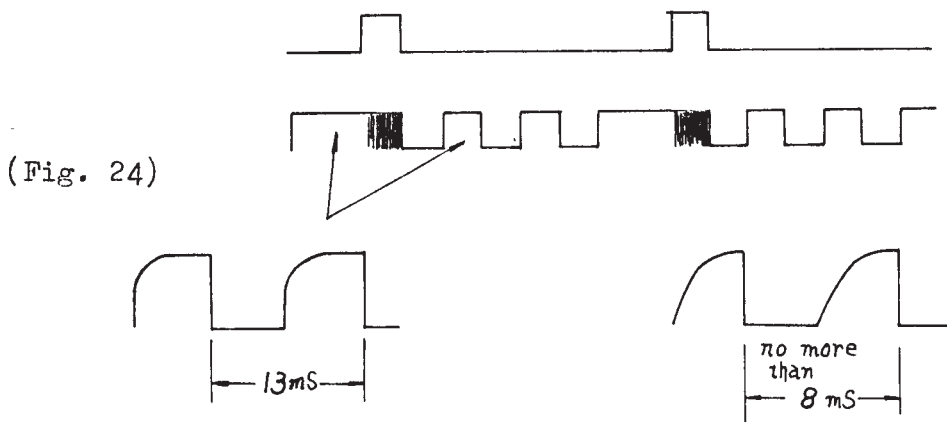

Adjust the semifixed resistor VR310 so that the voltage of " White Noise " may reach 0.5V.

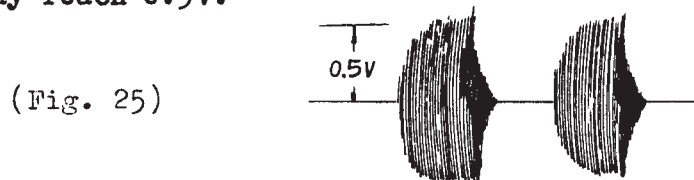

In case that Noise section is zero. The period of ringing is 3500-5000Hz.



C. Adjustment of the Drum section(BD, LC, LB, HB, RS, CB, C)

a) Adjustment of Bass Drum

Connect a trigger pulse with terminal "BD" on PCB, and check the level of output voltage, frequency and decay time within regular value. To represent frequency, a time of a period at wave form of vibration decay time is measured, and its reciprocal number is shown as a unit of Hz. 65Hz is nearly 15.4ms. When the frequency of BD is over, or under the regular value. Adjust the capacitors C344 or 345.

In case that a capacitor or value is changed, check frequency, voltage, and decay time again.

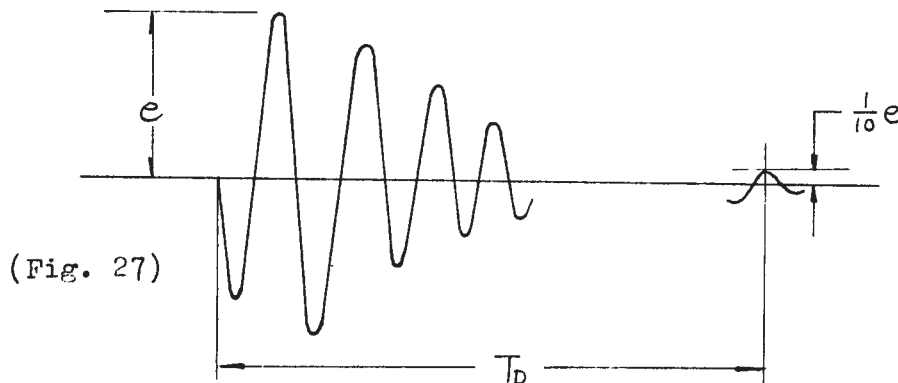

Output voltage of the Drum section is shown by max. of plus side.

e : voltage

T : decay time

b) Adjustment of Low Conga

Connect a trigger pulse with terminal "LC" on PCB, adjust semifixed resistor VR307 so that the level of output voltage may reach 4.0V. Check frequency and decay time within regular time.

When frequency of "LC" is over or under the regular value adjust capacitors C337 or 338. In case that a capacitor or value is changed, check frequency, voltage, and decay time again.

c) Adjustment of Low Bongo

Connect a trigger pulse with terminal "LB" on PCB, adjust semifixed resistor VR306 so that the level of output voltage may reach 1.5V. Check frequency and decay time within regular time.

When frequency of "LB" is over or under the regular value, adjust capacitor 331. In case that a capacitor or value is changed, check frequency, voltage, and decay time again.

d) Adjustment of High Bongo

Connect a trigger pulse with terminal "HB" on PCB, adjust semifixed resistor VR305 so that the level of output voltage may reach 1.5V. When frequency of "HB" is over or under the regular value adjust capacitor C327. In case that a capacitor or value is changed, check frequency, voltage, and decay time again.

e) Adjustment of Cow Bell

Check frequency.

Connect a trigger pulse with terminal "CB" on PCB, turn semifixed resistor VR303, release the higher sound CB-H, and check frequency and decay time of the lower sound CB-L within regular value. On the other hand, turn semifixed resistor VR304, release the lower sound CB-L, and check frequency and decay time of the higher sound CB-H within regular value. And adjust the semifixed resistor VR304 so that the voltage of the lower sound CB-L may reach 0.6V.

Next, adjust the semifixed resistor VR303 so as to make the voltage synthesized of CB-L and CB-H as 1.3V.

When frequency of the lower sound CB-L or the higher sound CB-H is over or under the regular value, adjust capacitor C316.

For the lower sound CB-L, adjust capacitor C321.

In case that a capacitor or value is changed, check frequency and decay time again.

f) Adjustment of Claves

Connect a trigger pulse with terminal "C" on PCB.

When the frequency of "C" is over or under the regular value, adjust capacitor C304.

In case that a capacitor or value is changed, check frequency, voltage, and decay time again.

g) Adjustment of Rim Shot

Connect a trigger pulse with terminal "RS" on PCB.

When the frequency of "RS" is over or under the regular value, adjust (Fig. 28) capacitor C310.

In case that a capacitor or value is changed, check frequency, voltage, and decay time again.

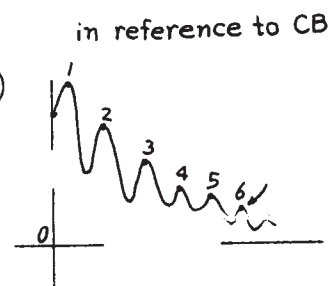

9-4. Adjustment of Control board

A. The start switch circuit of touching type

a) Check of the oscillated frequency

Connected the Oscilloscope to the collector of transistor Q901, check the oscillated frequency to be not less than 1700KHz(0.59 μ Sec.).

If the frequency is no more than 1700KHz, turn the core of coil L901(09A-465) counter clockwise to make the frequency within regular value.

b) Check of the oscillated voltage

Connected the Oscilloscope, of which the frequency band is not less than 2,000KHz, to the collector of transistor Q901.

And check the oscillated voltage to be not less than 5.5V(p-p).

c) Check of the oscillation stoped

Connect the Oscilloscope to the collector of transistor Q901, touch the Badge(Touch-Plate) with hand softly, and then check the wave form of oscillated frequency disappear.

B. Sound source of metronome

(Fig. 29)

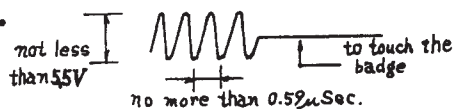

Connect oscilloscope with the power terminal "0" on Voice Generator as in chapter No.3, and press the button of metronome. The trigger pulse shows No.5. Adjust the semifixed resistor VR903 so that the frequency may come to 1480Hz(0.68mS) And check the output voltage and decay time within standard time.

C. Adjustment of Reset time

Connect the oscilloscope with reset terminal "R" on Logic board, or on Control board. The terminal "R" on the Control board is the collector (Q906) of oneshot multivibrator.

Touch the badge with hands or connect footswitch(FS-1)with start jack (ON-OFF), and adjust the semifixed resistor VR901 so that the pulse width may come to 30mS.

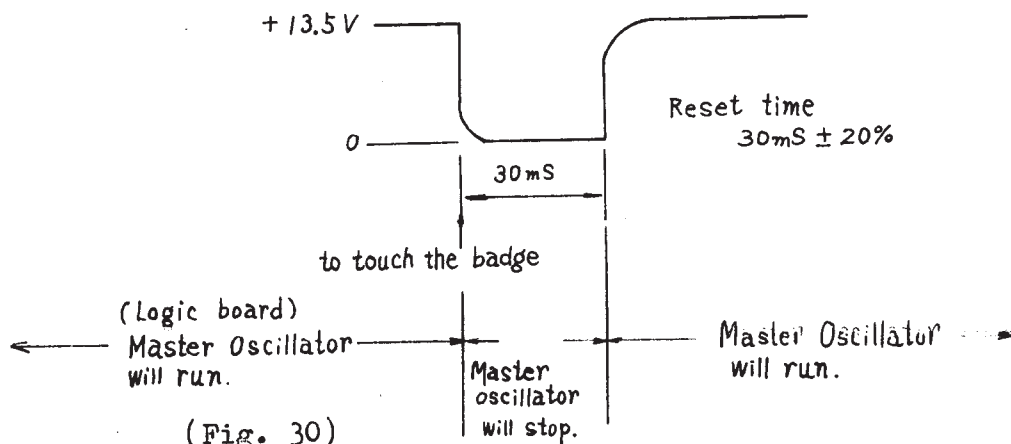

D. Check of Start and Stop, using Footswitch

Connect the Footswitch(FS-1 or the substitute) with the start switch jack in the rear chassis, and check if they work the same way as Item 4-3.

E. Adjustment of Fade-Time

Connect oscilloscope with the terminal "0" on Voice Generator, set the rhythm on Bass Drum of 2 Beat, and make the rhythm start.

Adjust the semifixed resistor VR603 soldered on the terminal strip so that the volume of Bass Drum will fall down to 90% in case the fade-time volume is slide on the right end(SHORT) from the left end(LONG). (100 - 90%)

And set the rhythm on Rhumba or Mambo of Latin, push the fade-out button and adjust the semifixed resistor VR902 so that the decay time will be 5-8 seconds at SHORT position.

Next, check if the decay time at LONG position is about double of it at SHORT position.

* Standard outputs of percussion instruments

| VOICE | AMPLITUDE [V] | | | FREQUENCY (mS) (Hz) | | | DURATION [mS] | | |
|-----------|---------------|-------|------|----------------------------|------------------|----------------|---------------|----------|------|
| | MIN. | AVE. | MAX. | MIN. | AVE. | MAX. | MIN. | AVE. | MAX. |
| BD | 2.3 | 3.0 | 3.6 | 16.7 (60) | 15.4 (65) | 14.3 (70) | 90 | 120 | 160 |
| LC | 3.4 | 4.0 | 4.6 | 7.9 (126) | 7.2 (139) | 6.5 (154) | 80 | 100 | 120 |
| LB | 1.2 | 1.5 | 1.8 | 5.3 (187) | 4.8 (208) | 4.4 (229) | 50 | 80 | 110 |
| HB | 1.2 | 1.5 | 1.8 | 3.2 (312) | 2.9 (346) | 2.6 (378) | 50 | 70 | 95 |
| (L) CB | 1.0 | 0.6 | 1.6 | 1.13 (883) | 1.02 (984) | 0.93 (1080) | 25 | 35 | 80 |
| (H) | | (1.0) | | 0.94 (1060) | 0.85 (1176) | 0.78 (1290) | 30 | 40 | 90 |
| RS | 3.4 | 4.0 | 4.6 | 0.94 (1060) | 0.85 (1175) | 0.78 (1290) | 2 | 4 | 6 |
| C | 1.2 | 1.5 | 1.8 | 0.48 (2100) | 0.426 (2350) | 0.38 (2600) | 9 | 15 | 25 |
| SD (D) | 1.7 | 2.0 | 2.3 | | - | | 65 | 90 | 110 |
| | | 1.5 | | 3.6 (280) | 3.0 (330) | 2.6 (380) | | - | |
| M | 1.7 | 2.0 | 2.3 | | - | | 25 | 30 | 40 |
| HH | 1.7 | 2.0 | 2.3 | | - | | 75 | 100 | 120 |
| CY | 1.7 | 2.0 | 2.3 | | - | | 200 | 300 | 400 |
| TB | 0.3 | 0.4 | 1.0 | | - | | 170 | 220 | 290 |
| GU | 0.4 | 0.5 | 0.7 | | - | | | (P=13mS) | |
| Me | 0.4 | 0.8 | 1.2 | | (0.68) (1480) | | - | | - |

Me is Metronome.

Standard trigger pulse : No.3

CABINET ASSEMBLY (Complete)

Cabinet No.11
 Music Rack No.1
 MP Hinge

CHASSIS ASSEMBLY

| | | | |
|--------------------------------|----------------|---------------------------------|-----------|
| Logic Board Assembly | GL-3 | | 142-003 |
| Voice Generator Board Assembly | VG-2 | | 143-002 |
| Control Board Assembly | OP-1 | | 149-001 |
| Rhythm Switch Board Assembly | RS-3 | (Jazz Section) | 148-003 |
| " | RS-4 | (Latin Section) | 148-004 |
| Chassis | No.8 | | |
| Holder | No.2 | | |
| Panel | No.18 | | |
| Knob | No.2 x 1 | (for Tempo Control) | 016-002 |
| " | No.3 x 6 | | 016-003 |
| Rotary Switch | ESR-E246R25B | | 001-006 |
| Paddle Switch | PW-2022(Black) | | |
| " | PW-2022(White) | | |
| Slide Potentiometer | 1OK(A) | EVA-QOAA00 (for Volume Control) | |
| " | 1OK(B) | EVA-QOAA00 | |
| " | 1OOK(B) | EVA-SOAA00 (for Tempo Control) | |
| Light Emitting Diode | TLR-103 | | |
| Badge | No.21 | (Touch-Start Bar) | |
| Voltage Selector Switch | XW-103-1-10 | | |
| Jack | SG-7615 | No.5 | |
| Push Switch | KW-006 | (for Metronome and Fade-out) | |
| Knob | MSA-26TS | (for Rotary Switch) | 016-010 |
| Power Transformer | PT-19B-C | (100-120V) | 022-019BC |
| " | or PT-19B-D | (230-250V) | 022-019BD |
| Power Supply Cord | | 3m with Plug | |
| Bracket | No.2 | (Lamp Bracket) | |
| Long Nut | No.1 | (10mm) | |
| " | No.2 | (16.4mm) | |
| Terminal Strip | | 2L4P | |
| " | | 2L5P | |
| Wired-in Fuse | | 0.5A | 008-013 |

PRINTED Circuit BOARDS

| | | |
|-------|----------------------|---------|
| No.8 | (Logic) | 052-008 |
| No.9 | (Voice) | 052-009 |
| No.10 | (Rhythm Switch RS-3) | 052-010 |
| No.11 | (Rhythm Switch RS-4) | 052-011 |
| No.12 | (Control) | 052-012 |

PUSH SWITCHES

| | |
|-------------|-------------|
| 10FS-50U-85 | (Jazz) |
| 2FS-14U-251 | (Variation) |
| 10FS-54U-86 | (Latin) |

BUTTONS

| | | |
|------|--------|---------|
| No.4 | Ivory | 016-004 |
| No.5 | Maroon | 016-005 |
| No.6 | Green | 016-006 |
| No.7 | Yellow | 016-007 |
| No.8 | Gray | 016-008 |

COILS

022-030

| | | |
|------------------|-------------|---------|
| Choke Coil | 45mH | |
| Coil | 40mH | 1R |
| " | 0.7H | 3R |
| " | 3.8H | 4R |
| " | 10H | 5R |
| " | 16H | 6R |
| Oscillation Coil | 120 μ H | 09A-465 |

SEMICONDUCTORS

| | |
|--------------------|----------------------|
| Integrated Circuit | MFC 6040 or SFC 6043 |
| Silicon Transistor | 2SC1000-GR |
| " | 2SC372-Y |
| " | 2SC828-R or Q |
| " | 2SA493-GR |
| Silicon Diode | 1S1850 |
| " | 1S1850R |
| " | 1S1555 or 1S2473 |

RESISTORS

| | |
|------------------------------|--------------------|
| Trimmer Potentiometer | 10K(B) EVL-R4XA00 |
| " | 50K(B) EVL-R4XA00 |
| " | 100K(B) EVL-R4XA00 |
| Metallic Oxide Film Resistor | 20 ohm 3W |
| Carbon Solid Resistor | 68 ohm 1/2 GF |
| " | 470ohm " |
| " | 560ohm " |
| " | 680ohm " |
| " | 1.5Mohm " |
| " | 2.2Mohm " |
| " | 2.7Mohm " |
| " | 4.7Mohm " |
| Carbon Film Resistor | 33 ohm 1/4 R |
| " | 56 ohm " |
| " | 100ohm " |
| " | 150ohm " |
| " | 220ohm " |
| " | 680ohm " |
| " | 820ohm " |
| " | 1 Kohm " |
| " | 2.7Kohm " |
| " | 3.9Kohm " |
| " | 4.7Kohm " |
| " | 5.6Kohm " |
| " | 10 Kohm " |
| " | 15 Kohm " |
| " | 18 Kohm " |
| " | 22 Kohm " |
| " | 27 Kohm " |
| " | 33 Kohm " |
| " | 39 Kohm " |
| " | 47 Kohm " |
| " | 56 Kohm " |
| " | 68 Kohm " |
| " | 82 Kohm " |
| " | 100Kohm " |
| " | 150Kohm " |
| " | 180Kohm " |
| " | 220Kohm " |

MODEL TR-77 PARTS LIST

| | |
|----------------------|---------------|
| Carbon Film Resistor | 270Kohm 1/4 R |
| " | 330Kohm " |
| " | 470Kohm " |
| " | 820Kohm " |
| " | 1 Mohm " |

CAPACITORS

| | | |
|------------------------|---------------------|---------|
| Electrolytic Capacitor | 1 mfd 50V V type | |
| " | 4.7 mfd 25V " " | |
| " | 10 mfd 16V " " | |
| " | 33 mfd 16V " " | |
| " | 47 mfd 16V " " | |
| " | 100 mfd 6V " " | |
| " | 100 mfd 16V " " | |
| " | 100 mfd 25V " " | |
| " | 1000mfd 25V " " | |
| Ceramic Capacitor | 15 pfd 50V V type | 037-002 |
| " | 100 pfd 50V " " | 037-006 |
| " | 250 pfd 50V " " | 037-007 |
| Plastic Film Capacitor | 470 pfd 50V V type | 035-001 |
| " | .001mfd " " | |
| " | .0015mfd " " | |
| " | .0022mfd " " | |
| " | .0027mfd " " | |
| " | .0033mfd " " | |
| " | .0047mfd " " | |
| " | .0056mfd " " | |
| " | .0068mfd " " | |
| " | .0082mfd " " | |
| " | .01 mfd " " | |
| " | .015 mfd " " | |
| " | .022 mfd " " | |
| " | .027 mfd " " | |
| " | .033 mfd " " | |
| " | .039 mfd " " | |
| " | .047 mfd " " | |
| " | .056 mfd " " | |
| " | .068 mfd " " | |
| " | .082 mfd " " | |
| " | .1 mfd " " | |
| " | .22 mfd " " | |
| Tantalum Capacitor | .33 mfd 35V(or 25V) | 032-094 |